



Test Report

Prepared for: Wulfsberg Electronics Division

Model: RT-5000

Description: 29.7 MHz to 960 MHz Tactical Airborne Transceiver

To

FCC Part 22, 80, and 90

Date of Issue: November 30, 2012

On the behalf of the applicant:

Wulfsberg Electronics Division
6400 Wilkinson Drive
Prescott, AZ 86301

Attention of:

Jim Buehring, Certification Manager
Ph: (928) 708-1550
E-Mail: jim.buehring@cobham.com

Prepared By
Compliance Testing, LLC
3356 N San Marcos Pl, Suite 107
Chandler, AZ 85225-7176
(866) 311-3268 phone / (480) 926-3598 fax
www.compliancetesting.com
Project No: p12a0008

John Erhard
Project Test Engineer

This report may not be reproduced, except in full, without written permission from Compliance Testing
All results contained herein relate only to the sample tested



Test Report Revision History

Revision	Date	Revised By	Reason for Revision
1.0	November 30, 2012	John Erhard	Original Document
2.0	December 19, 2012	John Erhard	Added Configuration data
3.0	December 21, 2012	Karen Springer	Correction Table 1 pg 3



This Table serves to define the FCC ID numbers regarding the optional RF sub-assemblies included with the main transceiver. In the table below there are twelve combinations of these optional RF assemblies. Part numbers can differentiate both hardware configuration and software features. Part numbers that match the hardware combination in the following table will be identified with the FCC ID listed in the table.

This test report contains the full test suite for all optional combinations for the indicated FCC ID.

Table 1 – FCC ID Defining RF Sub-Assemblies Installed

FCC ID	Installed Options, Part Numbers and Frequency Range				
	246-049664-01, 02, 04, 24, & 25 (136–174 MHz)	246-049664-05, 08, 10, & 26 (380–470 MHz)	246-049664-11, 12, 14, 15, 16, 23, & 27 (450-520 MHz)	246-049664-21, 22, 28, & 29 (764-870 MHz)	Base Transceiver (29-960 MHz)
FRWRT-5000P-01					1 each
FRWRT-5000P-02					2 each
FRWRT-5000P-03				1 each	1 each
FRWRT-5000P-04			1 each		1 each
FRWRT-5000P-05		1 each			1 each
FRWRT-5000P-06	1 each				1 each
FRWRT-5000P-07			1 each	1 each	1 each
FRWRT-5000P-08		1 each		1 each	1 each
FRWRT-5000P-09	1 each			1 each	1 each
FRWRT-5000P-10		1 each	1 each		1 each
FRWRT-5000P-11	1 each		1 each		1 each
FRWRT-5000P-12	1 each	1 each			1 each



Table of Contents

<u>Description</u>	<u>Page</u>
Standard Test Conditions and Engineering Practices	7
Test Result Summary	8
Carrier Output Power (Conducted)	12
Conducted Spurious Emissions	14
Field Strength of Spurious Radiation	51
Emission Masks (Occupied Bandwidth)	67
Transient Frequency Behavior	207
Audio Low Pass Filter (Voice Input)	220
Audio Frequency Response	232
Modulation Limiting	244
Frequency Stability	267
Receiver Spurious Emissions	285
Necessary Bandwidth Calculations	286
Test Equipment Utilized	288



ILAC / A2LA

Compliance Testing, LLC, has been accredited in accordance with the recognized International Standard ISO/IEC 17025:2005. This accreditation demonstrates technical competence for a defined scope and the operation of a laboratory quality management system (refer joint ISO-ILAC-IAF Communiqué dated January 2009)

The tests results contained within this test report all fall within our scope of accreditation, unless noted below.

Please refer to <http://www.compliancetesting.com/labscope.html> for current scope of accreditation.

Testing Certificate Number: **2152.01**



FCC OATS Reg, #933597

IC Reg. #2044A-1

Non-accredited tests contained in this report:

N/A



The Applicant has been cautioned as to the following:

15.21: Information to the User

The user's manual or instruction manual for an intentional radiator shall caution the user that changes or modifications not expressly approved by the party responsible for compliance could void the user's authority to operate the equipment.

15.27(a): Special Accessories

Equipment marketed to a consumer must be capable of complying with the necessary regulations in the configuration in which the equipment is marketed. Where special accessories, such as shielded cables and/or special connectors are required to enable an unintentional or intentional radiator to comply with the emission limits in this part, the equipment must be marketed with, i.e. shipped and sold with, those special accessories. However, in lieu of shipping or packaging the special accessories with the unintentional or intentional radiator, the responsible party may employ other methods of ensuring that the special accessories are provided to the consumer, without an additional charge.

Information detailing any alternative method used to supply the special accessories for a grant of equipment authorization or retained in the verification records, as appropriate. The party responsible for the equipment, as detailed in § 2.909 of this chapter, shall ensure that these special accessories are provided with the equipment. The instruction manual for such devices shall include appropriate instructions on the first page of text concerned with the installation of the device that these special accessories must be used with the device. It is the responsibility of the user to use the needed special accessories supplied with the equipment.



Test and Measurement Data

Sub-part
2.1033(c)(14):

All tests and measurement data shown were performed in accordance with FCC Rules and Regulations, Volume II, Part 2, Sub-part J, Sections 2.947, 2.1033(c), 2.1041, 2.1046, 2.1047, 2.1079, 2.1051, 2.1053, 2.1055, 2.1057, and the following individual Parts: 22, 80, and 90.

Standard Test Conditions and Engineering Practices

Except as noted herein, the following conditions and procedures were observed during the testing.

In accordance with ANSI/C63.4-2009, and unless otherwise indicated in the specific measurement results, the ambient temperature of the actual EUT was maintained within the range of 10° to 40°C (50° to 104°F) unless the particular equipment requirements specify testing over a different temperature range. Also, unless otherwise indicated, the humidity levels were in the range of 10% to 90% relative humidity.

Environmental Conditions		
Temp (°C)	Humidity (%)	Pressure (mbar)
20.4 - 23.3	23.4 - 24.5	974 - 980

Measurement results, unless otherwise noted, are worst-case measurements.

EUT Description

Model: RT-5000
Description: 29.7 to 960 MHz Tactical Airborne Transceiver
Firmware: N/A
Software: N/A

Additional Information:

None

EUT Operation during Tests

The EUT was in a normal operating condition.

Accessories: None

Cables: None

Modifications: None



Test Result Summary

Specification	Test Name	Pass, Fail, N/A	Comments
2.1046	Carrier Output Power (Conducted)	Pass	
2.1051	Unwanted Emissions (Transmitter Conducted)	Pass	
2.1053	Field Strength of Spurious Radiation	Pass	
90.210	Emission Masks (Occupied Bandwidth)	Pass	
2.1047	Audio Low Pass Filter (Voice Input)	Pass	
2.1047	Audio Frequency Response	Pass	
2.1047(a)	Modulation Limiting	Pass	
90.213	Frequency Stability (Temperature Variation)	Pass	
90.213	Frequency Stability (Voltage Variation)	Pass	
90.214	Transient Frequency Behavior	Pass	
RSS-Gen	Receiver Spurious Emissions	Pass	
2.202	Necessary Bandwidth Calculation	Pass	



Frequency Test List and Rule Section Summary Table

Frequency (MHz)	FCC Rule Section(s)	IC Rule Section(s)	Emissions Designator	FCC Extended Frequency
29.75	90	RSS-119	8K10F1E, 8K10F1D, 11K0F3E, 16K0F3E	
72.5	22, 90	RSS-119	8K10F1E, 8K10F1D, 11K0F3E, 16K0F3E	
87.05	90	RSS-119	8K10F1E, 8K10F1D, 11K0F3E, 16K0F3E	
138.05	90	RSS-119	8K10F1E, 8K10F1D, 11K0F3E, 16K0F3E	Yes
150.05	90	RSS-119	8K10F1E, 8K10F1D, 11K0F3E 16K0F3E (RSS-119 Only)	
161.775	80, 90	RSS-119	8K10F1E, 8K10F1D, 11K0F3E 16K0F3E (RSS-119 Only)	
173.95	90	RSS-119	8K10F1E, 8K10F1D, 11K0F3E 16K0F3E (RSS-119 Only)	
380.00	90		6K00A3E, 8K10F1E, 8K10F1D, 11K0F3E 16K0F3E (Federal Use Only)	Yes
406.15	90	RSS-119	8K10F1E, 8K10F1D, 11K0F3E 16K0F3E (Federal Use Only)	
413	90	RSS-119	8K10F1E, 8K10F1D, 11K0F3E 16K0F3E (Federal Use Only)	
420.975	90	RSS-119	8K10F1E, 8K10F1D, 11K0F3E 16K0F3E (Federal Use Only)	
438.05	90	RSS-119	8K10F1E, 8K10F1D, 11K0F3E 16K0F3E (RSS-119 Only)	
469.95	90	RSS-119	8K10F1E, 8K10F1D, 11K0F3E 16K0F3E (RSS-119 Only)	
470.05	90	RSS-119	8K10F1E, 8K10F1D, 11K0F3E, 16K0F3E	
490.05	90	RSS-119	8K10F1E, 8K10F1D, 11K0F3E, 16K0F3E	
511.95	90	RSS-119	8K10F1E, 8K10F1D, 11K0F3E ,16K0F3E	
519.95	90	RSS-119	8K10F1E, 8K10F1D, 11K0F3E, 16K0F3E	Yes
764.05	90	RSS-119	8K10F1E, 8K10F1D, 11K0F3E, 16K0F3E	
769.95	90	RSS-119	8K10F1E, 8K10F1D, 11K0F3E, 16K0F3E	
774.95	90	RSS-119	8K10F1E, 8K10F1D, 11K0F3E, 16K0F3E	
793.05	90	RSS-119	8K10F1E, 8K10F1D, 11K0F3E, 16K0F3E	
799.95	90	RSS-119	8K10F1E, 8K10F1D, 11K0F3E, 16K0F3E	
804.95	90	RSS-119	8K10F1E, 8K10F1D, 11K0F3E, 16K0F3E	
806.05	90	RSS-119	8K10F1E, 8K10F1D, 11K0F3E, 16K0F3E	



Frequency (MHz)	FCC Rule Section(s)	IC Rule Section(s)	Emissions Designator	FCC Extended Frequency
809.05	22, 90	RSS-119	8K10F1E, 8K10F1D, 11K0F3E, 16K0F3E	
827.05	22, 90	RSS-119	8K10F1E, 8K10F1D, 11K0F3E, 16K0F3E	
848.95	22, 90	RSS-119	8K10F1E, 8K10F1D, 11K0F3E, 16K0F3E	
850.95	22	RSS-119	8K10F1E, 8K10F1D, 11K0F3E, 16K0F3E	
851.05	90	RSS-119	8K10F1E, 8K10F1D, 11K0F3E, 16K0F3E	
854.05	22, 90	RSS-119	8K10F1E, 8K10F1D, 11K0F3E, 16K0F3E	
869.95	22, 90	RSS-119	8K10F1E, 8K10F1D, 11K0F3E, 16K0F3E	
872.05	22, 90	RSS-119	8K10F1E, 8K10F1D, 11K0F3E, 16K0F3E	
893.95	22, 90	RSS-119	8K10F1E, 8K10F1D, 11K0F3E, 16K0F3E	
895.95	22	RSS-119	8K10F1E, 8K10F1D, 11K0F3E, 16K0F3E	
896.05	90	RSS-119	8K10F1E, 8K10F1D, 11K0F3E, 16K0F3E	
900.95	90	RSS-119	8K10F1E, 8K10F1D, 11K0F3E, 16K0F3E	
902.05	90	RSS-119	8K10F1E, 8K10F1D, 11K0F3E, 16K0F3E	
916.05	90	RSS-119	8K10F1E, 8K10F1D, 11K0F3E, 16K0F3E	
928.05	22, 90	RSS-119	8K10F1E, 8K10F1D, 11K0F3E, 16K0F3E	
928.95	22, 90	RSS-119	8K10F1E, 8K10F1D, 11K0F3E, 16K0F3E	
929.95	90	RSS-119	8K10F1E, 8K10F1D, 11K0F3E, 16K0F3E	
931.05	22	RSS-119	8K10F1E, 8K10F1D, 11K0F3E, 16K0F3E	
934.95	22	RSS-119	8K10F1E, 8K10F1D, 11K0F3E, 16K0F3E	
935.05	90	RSS-119	8K10F1E, 8K10F1D, 11K0F3E, 16K0F3E	
939.95	90	RSS-119	8K10F1E, 8K10F1D, 11K0F3E, 16K0F3E	
941.05	22	RSS-119	8K10F1E, 8K10F1D, 11K0F3E, 16K0F3E	
950.05	22	RSS-119	8K10F1E, 8K10F1D, 11K0F3E, 16K0F3E	
959.95	22	RSS-119	8K10F1E, 8K10F1D, 11K0F3E, 16K0F3E	
MTM 138.05	90	RSS-119	8K10F1E, 8K10F1D, 11K0F3E, 16K0F3E	Yes
MTM 150.05	90	RSS-119	8K10F1E, 8K10F1D, 11K0F3E 16K0F3E (RSS-119 Only)	
MTM 161.775	80, 90	RSS-119	8K10F1E, 8K10F1D, 11K0F3E 16K0F3E (RSS-119 Only)	
MTM 173.95	90	RSS-119	8K10F1E, 8K10F1D, 11K0F3E 16K0F3E (RSS-119 Only)	



Frequency (MHz)	FCC Rule Section(s)	IC Rule Section(s)	Emissions Designator	FCC Extended Frequency
MTM 380.00	90		8K10F1E, 8K10F1D, 11K0F3E 16K0F3E (Federal Use Only)	Yes
MTM 406.15	90	RSS-119	8K10F1E, 8K10F1D, 11K0F3E 16K0F3E (Federal Use Only)	
MTM 438.05	90	RSS-119	8K10F1E, 8K10F1D, 11K0F3E 16K0F3E (RSS-119 Only)	
MTM 469.95	90	RSS-119	8K10F1E, 8K10F1D, 11K0F3E 16K0F3E (RSS-119 Only)	
MTM 450.05	90	RSS-119	8K10F1E, 8K10F1D, 11K0F3E 16K0F3E (RSS-119 Only)	
MTM 460.05	90	RSS-119	8K10F1E, 8K10F1D, 11K0F3E 16K0F3E (RSS-119 Only)	
MTM 469.95	90	RSS-119	8K10F1E, 8K10F1D, 11K0F3E 16K0F3E (RSS-119 Only)	
MTM 470.05	90	RSS-119	8K10F1E, 8K10F1D, 11K0F3E, 16K0F3E	
MTM 490.05	90	RSS-119	8K10F1E, 8K10F1D, 11K0F3E, 16K0F3E	
MTM 511.95	90	RSS-119	8K10F1E, 8K10F1D, 11K0F3E, 16K0F3E	
MTM 519.95	90	RSS-119	8K10F1E, 8K10F1D, 11K0F3E, 16K0F3E	Yes
MTM 764.05	90	RSS-119	8K10F1E, 8K10F1D, 11K0F3E, 16K0F3E	
MTM 769.95	90	RSS-119	8K10F1E, 8K10F1D, 11K0F3E, 16K0F3E	
MTM 774.95	90	RSS-119	8K10F1E, 8K10F1D, 11K0F3E, 16K0F3E	
MTM 851.05	22, 90	RSS-119	8K10F1E, 8K10F1D, 11K0F3E, 16K0F3E	
MTM 854.05	22, 90	RSS-119	8K10F1E, 8K10F1D, 11K0F3E, 16K0F3E	
MTM 869.95	22, 90	RSS-119	8K10F1E, 8K10F1D, 11K0F3E, 16K0F3E	



Carrier Output Power (Conducted)

Name of Test: Carrier Output Power (Conducted)

Engineer: John Erhard

Test Equipment Utilized: i00331

Test Date: 11/16/2012

Measurement Procedure

The Equipment Under Test (EUT) was connected to a spectrum analyzer through a 30 dB power attenuator. The cable and attenuator losses were input into the spectrum analyzer as a reference level offset to ensure accurate reading were obtained. The peak readings were taken and the result was then compared to the limit. Multiple frequencies per rule section and frequency band were tested ensuring compliance across all operational rule sections.

Test Setup

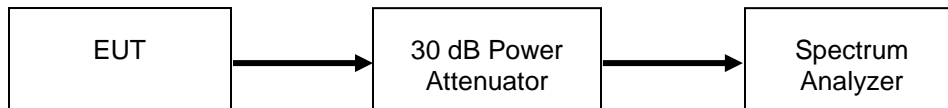

Transmitter Output Power

Tuned Frequency (MHz)	Recorded Measurement (dBm)	Recorded Measurement (Watts)	Result
29.75	40.71	11.78	Pass
72.5	40.56	11.38	Pass
87.05	40.54	11.32	Pass
138.05	40.94	12.42	Pass
150.05	40.87	12.22	Pass
161.775	40.56	11.38	Pass
173.95	40.42	11.02	Pass
380.00 (AM)	42.93	19.63	Pass
380.00 (FM)	40.19	10.45	Pass
406.15	39.32	8.55	Pass
413	38.77	7.53	Pass
420.975	39.52	8.95	Pass
438.05	39.68	9.29	Pass
469.95	39.07	8.07	Pass
470.05	39.10	8.13	Pass
490.05	39.73	9.40	Pass
511.95	39.16	8.24	Pass
519.95	39.17	8.26	Pass
764.05	39.24	8.39	Pass
769.95	39.22	8.36	Pass
774.95	39.34	8.59	Pass
793.05	39.84	9.64	Pass
799.95	39.56	9.04	Pass
804.95	39.33	8.57	Pass
806.05	39.28	8.47	Pass
809.05	39.14	8.20	Pass
827.05	40.42	11.02	Pass



Tuned Frequency (MHz)	Recorded Measurement (dBm)	Recorded Measurement (Watts)	Result
848.95	40.32	10.76	Pass
850.95	39.91	9.79	Pass
851.05	39.83	9.62	Pass
854.05	39.69	9.31	Pass
869.95	38.82	7.62	Pass
872.05	39.30	8.51	Pass
893.95	39.85	9.66	Pass
895.95	39.71	9.35	Pass
896.05	39.76	9.46	Pass
900.95	39.61	9.14	Pass
902.05	39.55	9.02	Pass
916.05	38.54	7.14	Pass
928.05	39.60	9.12	Pass
928.95	39.62	9.16	Pass
929.95	39.64	9.20	Pass
931.05	37.94	6.22	Pass
934.95	37.92	6.19	Pass
935.05	37.99	6.30	Pass
939.95	38.00	6.31	Pass
941.05	38.87	7.71	Pass
950.05	39.64	9.20	Pass
959.95	38.62	7.28	Pass
MTM 138.05	41.02	12.65	Pass
MTM 150.05	40.99	12.56	Pass
MTM 161.775	41.65	14.62	Pass
MTM 173.95	41.76	15.00	Pass
MTM 380.00	35.00	3.16	Pass
MTM 406.15	35.49	3.54	Pass
MTM 438.05	35.37	3.44	Pass
MTM 469.95	35.40	3.47	Pass
MTM 450.05	35.01	3.17	Pass
MTM 460.05	34.51	2.82	Pass
MTM 469.95	34.53	2.84	Pass
MTM 470.05	34.54	2.84	Pass
MTM 490.05	35.29	3.38	Pass
MTM 511.95	34.76	2.99	Pass
MTM 519.95	35.02	3.18	Pass
MTM 764.05	33.53	2.25	Pass
MTM 769.95	33.67	2.33	Pass
MTM 774.95	33.81	2.40	Pass
MTM 851.05	32.63	1.83	Pass
MTM 854.05	32.86	1.93	Pass
MTM 869.95	32.53	1.79	Pass



Conducted Spurious Emissions

Name of Test: Conducted Spurious Emissions

Engineer: John Erhard

Test Equipment Utilized: i00331, i00124, i00126, i00364

Test Date: 11/19/2012

Test Procedure

The EUT was connected to a spectrum analyzer through a 30 dB power attenuator to verify that the UUT met the requirements for spurious emissions. A tunable notch filter was utilized to ensure the fundamental did not put the spectrum analyzer into compression. The reference level was adjusted to ensure the system had sufficient dynamic range to measure spurious emissions. The frequency range from 25 MHz to the 10th harmonic of the fundamental transmitter was observed and plotted. Multiple frequencies per rule section and frequency band were tested ensuring compliance across all operational rule sections.

Test Setup

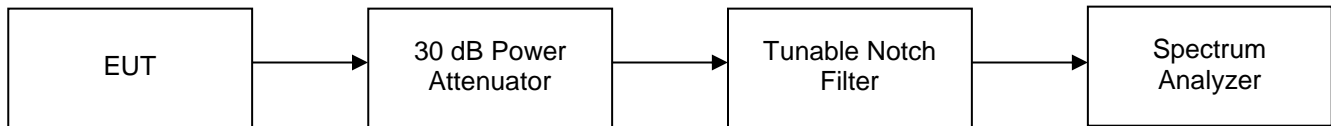

Conducted Spurious Emissions Summary Test Table

Tuned Frequency (MHz)	Spurious Frequency (MHz)	Measured Spurious Level (dBm)	Specification Limit (dBm)	Result
29.75	60.0	-27.42	-13	Pass
72.5	217.5	-37.89	-13	Pass
87.05	173.8	-36.02	-13	Pass
138.05	276.0	-38.19	-13	Pass
150.05	301	-35.48	-13	Pass
161.775	50.0	-35.91	-13	Pass
173.95	350.0	-36.9	-13	Pass
380.00	2977.0	-36.18	-13	Pass
406.15	263.0	-30.22	-13	Pass
413	263.0	-27.23	-13	Pass
420.975	263.0	-30.59	-13	Pass
438.05	266.0	-27.1	-13	Pass
469.95	266.0	-25.97	-13	Pass
470.05	266.0	-27.05	-13	Pass
490.05	266.0	-27.1	-13	Pass
511.95	266.0	-28.56	-13	Pass
519.95	266.0	-28.74	-13	Pass
764.05	272.0	-22.17	-13	Pass
769.95	272.0	-20.83	-13	Pass
774.95	272.0	-22.77	-13	Pass
793.05	252.0	-19.24	-13	Pass
799.95	272.0	-22.68	-13	Pass
804.95	272.0	-22.0	-13	Pass
806.05	274.0	-30.68	-13	Pass
809.05	274.0	-29.56	-13	Pass
827.05	274.0	-32.44	-13	Pass



Tuned Frequency (MHz)	Spurious Frequency (MHz)	Measured Spurious Level (dBm)	Specification Limit (dBm)	Result
848.95	274.0	-34.29	-13	Pass
850.95	1696.0	-33.77	-13	Pass
851.05	274.0	-32.21	-13	Pass
854.05	274.0	-33.63	-13	Pass
869.95	274.0	-31.7	-13	Pass
872.05	274.0	-33.17	-13	Pass
893.95	1796.0	-32.76	-13	Pass
895.95	249.0	-30.54	-13	Pass
896.05	274.0	-32.5	-13	Pass
900.95	274.0	-26.76	-13	Pass
902.05	274.0	-23.95	-13	Pass
916.05	274.0	-33.33	-13	Pass
928.05	274.0	-30.49	-13	Pass
928.95	274.0	-31.05	-13	Pass
929.95	1870.0	-31.08	-13	Pass
931.05	1920.0	-32.2	-13	Pass
934.95	1920.0	-32.38	-13	Pass
935.05	1920.0	-31.27	-13	Pass
939.95	1920.0	-31.91	-13	Pass
941.05	1870.0	-31.39	-13	Pass
950.05	1895.0	-28.76	-13	Pass
959.95	1920.0	-31.94	-13	Pass
MTM 138.05	1521.0	-30.45	-13	Pass
MTM 150.05	1501.0	-33.33	-13	Pass
MTM 161.775	1457.0	-28.93	-13	Pass
MTM 173.95	1393.0	-24.51	-13	Pass
MTM 380.00	2985.0	-37.19	-13	Pass
MTM 406.15	2960.0	-37.35	-13	Pass
MTM 438.05	2884.0	-36.94	-13	Pass
MTM 469.95	2985.0	-37.43	-13	Pass
MTM 450.05	1349.0	-23.31	-13	Pass
MTM 460.05	1371.0	-18.83	-13	Pass
MTM 469.95	1416.0	-14.25	-13	Pass
MTM 470.05	1416.0	-14.16	-13	Pass
MTM 490.05	1461.0	-24.08	-13	Pass
MTM 511.95	2560.0	-25.29	-13	Pass
MTM 519.95	2605.0	-25.82	-13	Pass
MTM 764.05	2291.0	-36.45	-13	Pass
MTM 769.95	2314.0	-34.73	-13	Pass
MTM 774.95	1551.0	-31.71	-13	Pass
MTM 851.05	2560.0	-15.58	-13	Pass
MTM 854.05	2560.0	-15.11	-13	Pass
MTM 869.95	2605.0	-16.63	-13	Pass



Test Plots

29.75 MHz

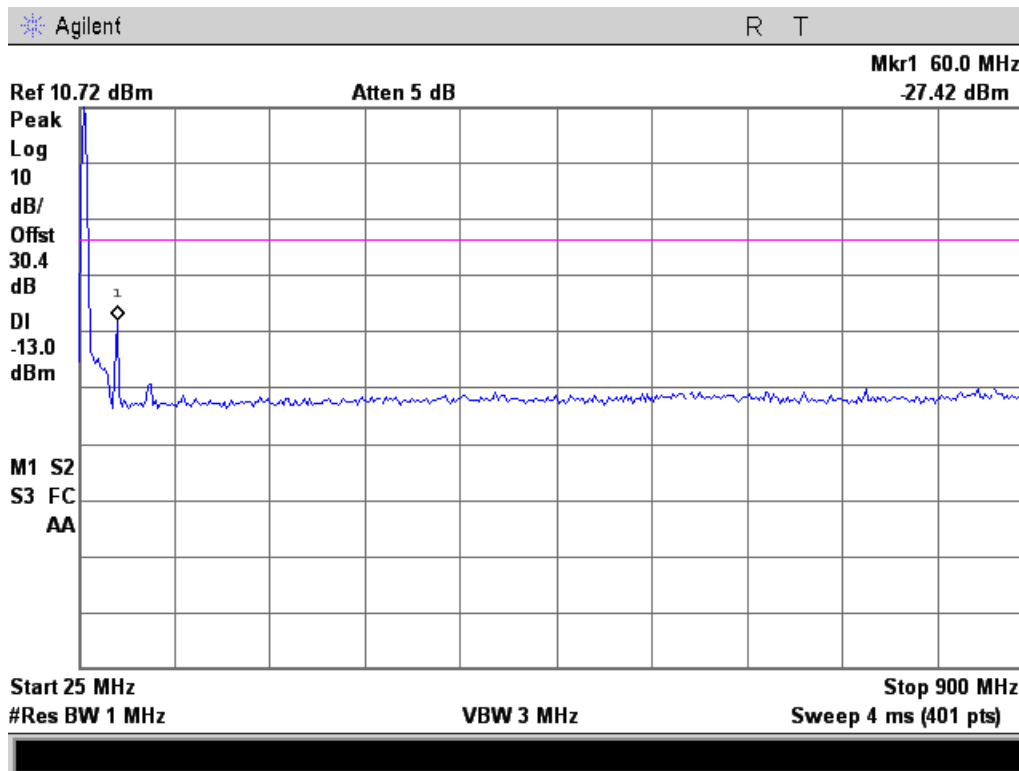

72.5 MHz

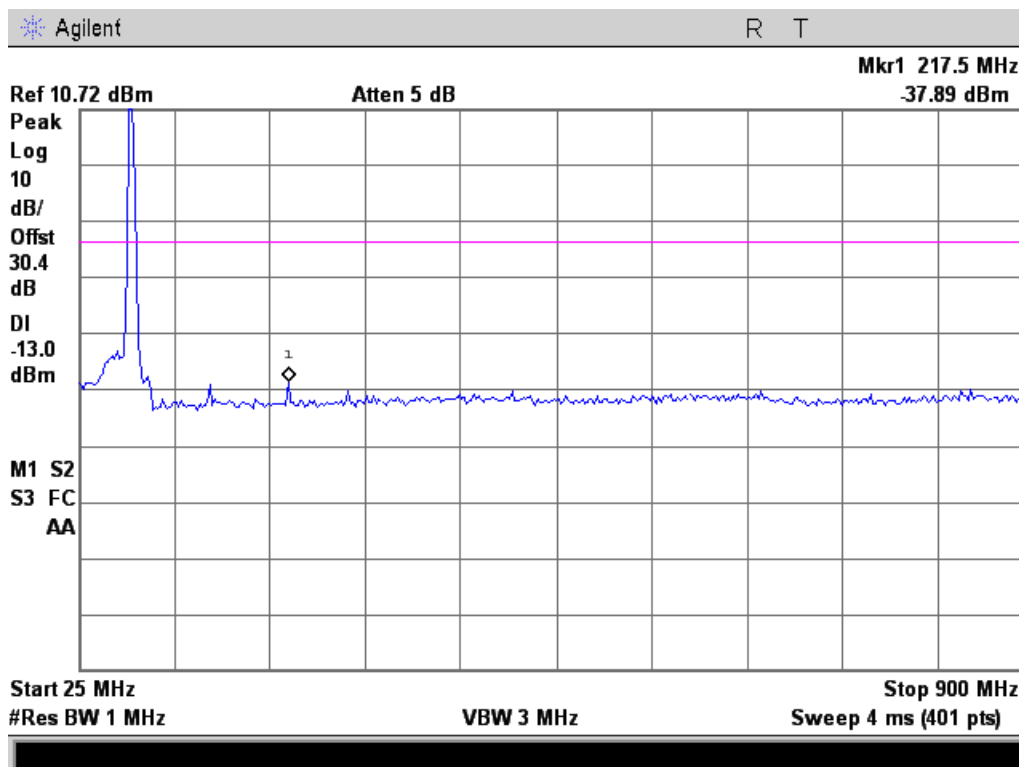



87.05 MHz

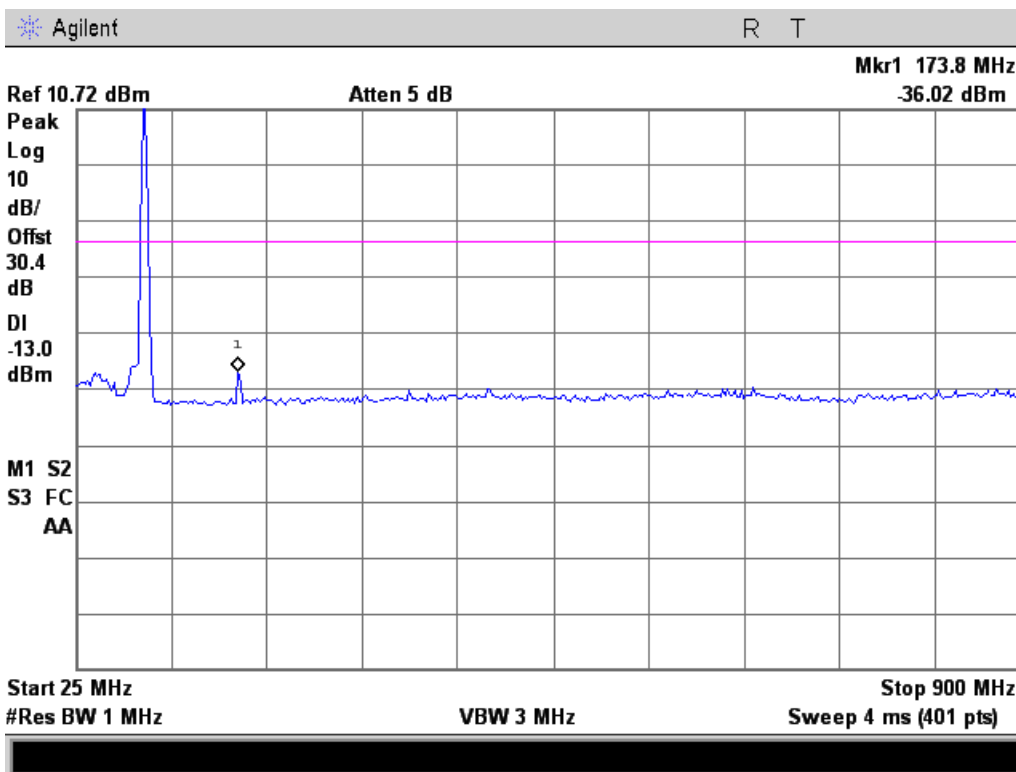

138.05 MHz

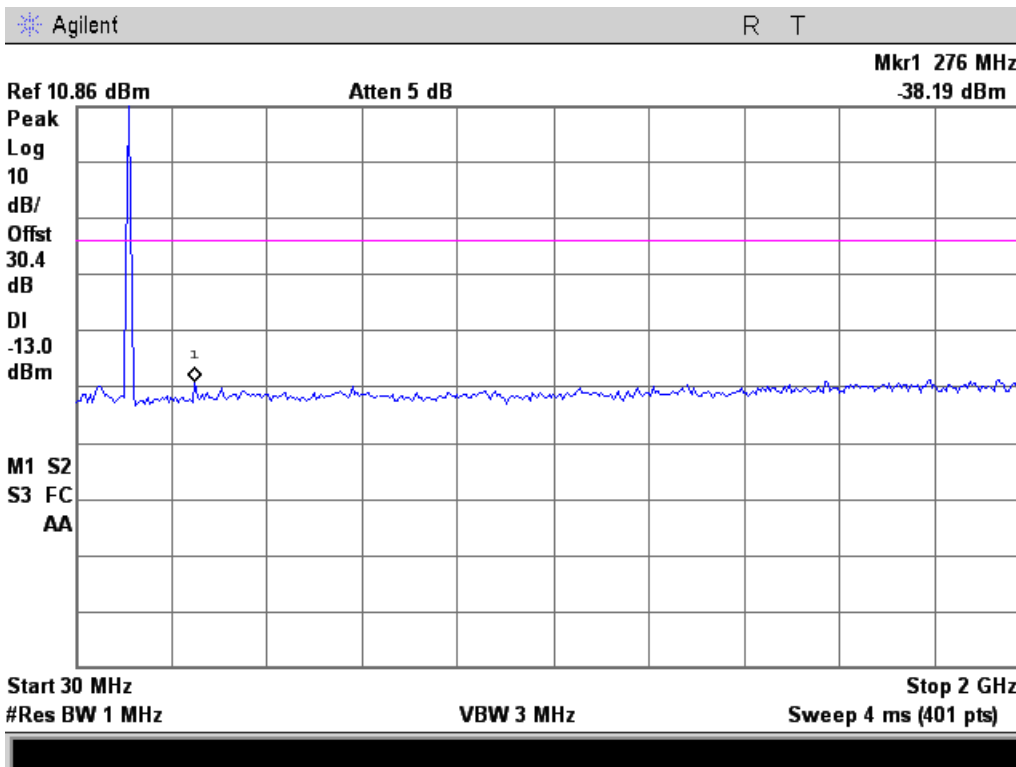



150.05 MHz

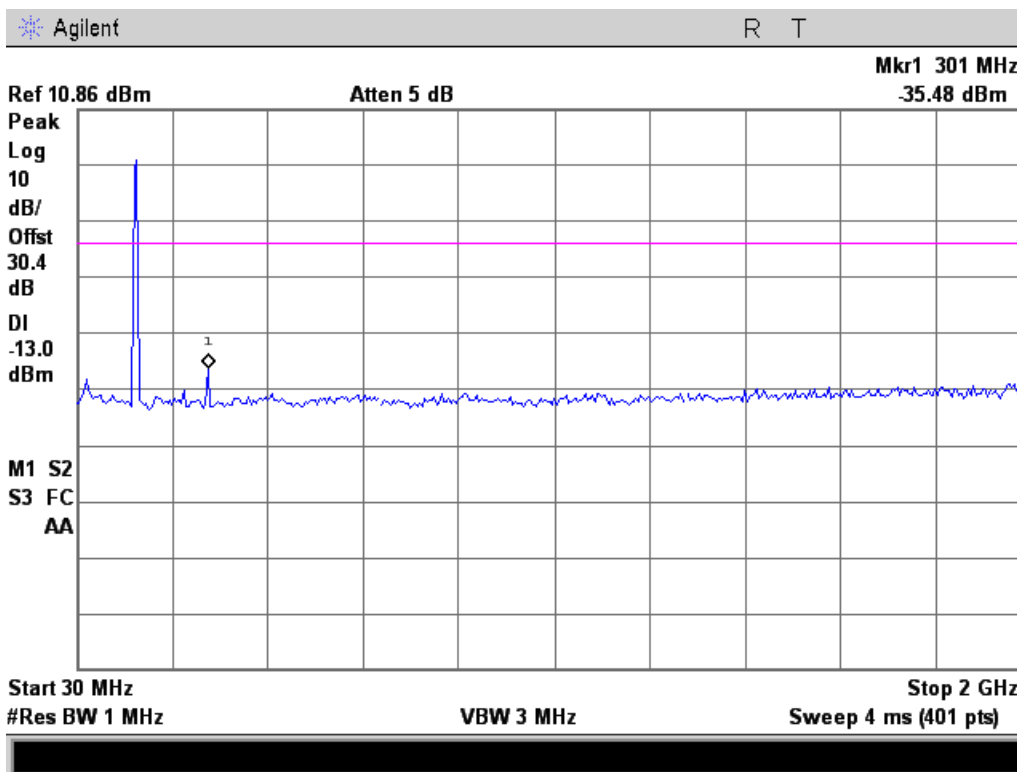

161.775 MHz

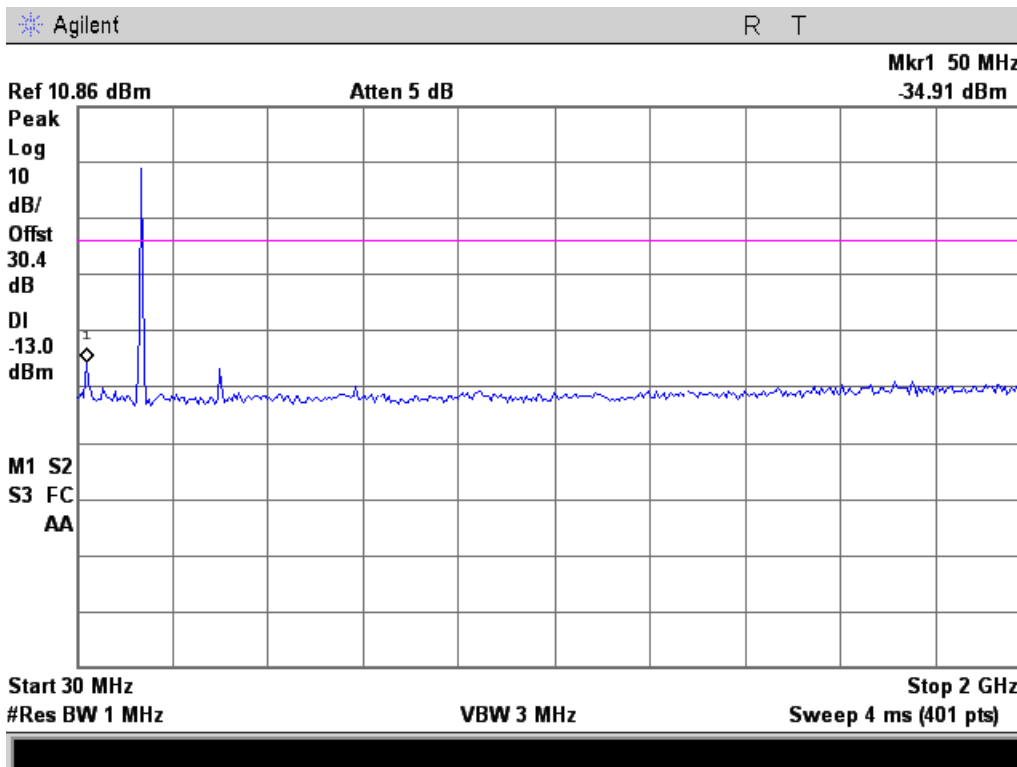



173.95 MHz

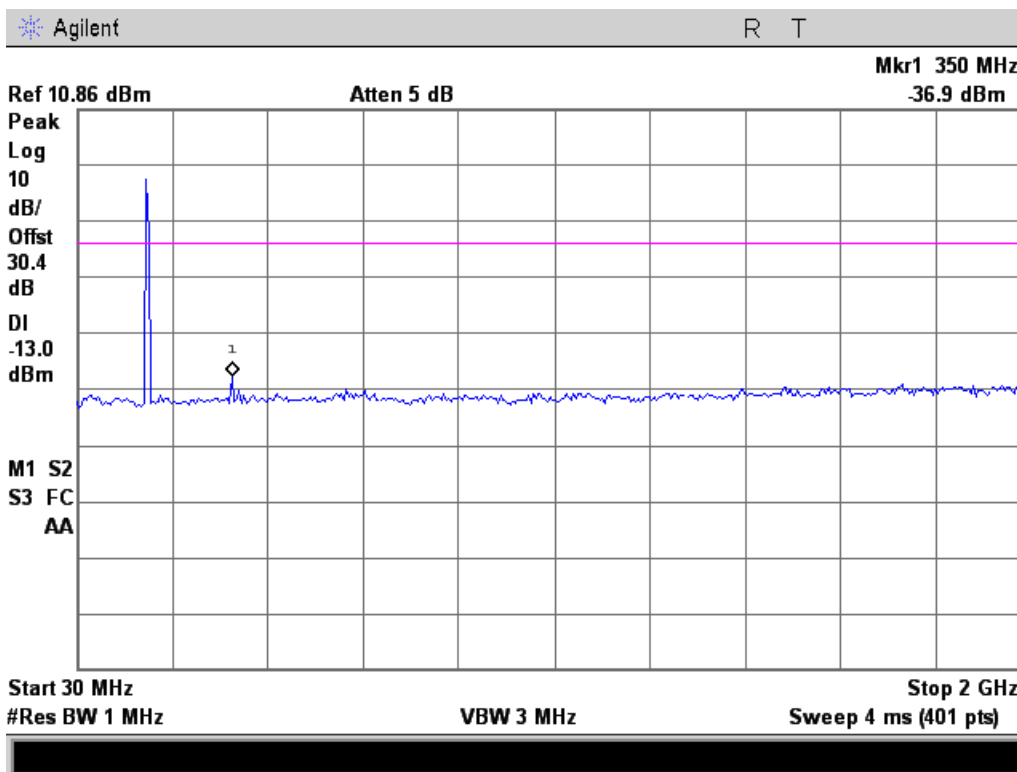

380.00 MHz

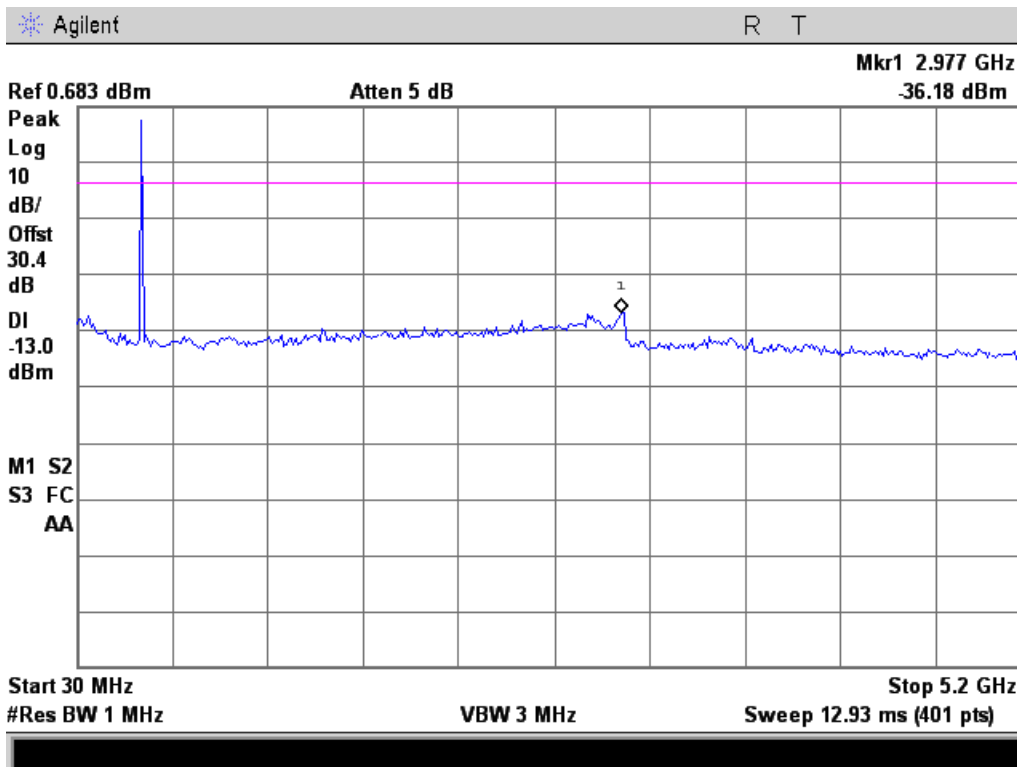



406.15 MHz

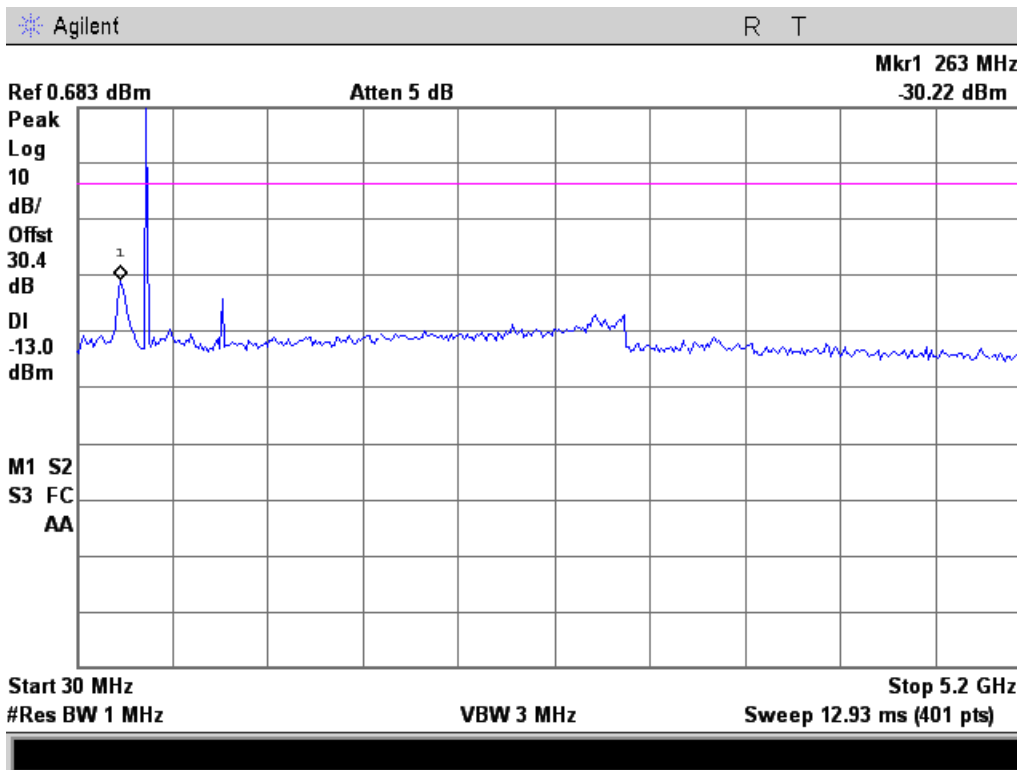

413 MHz

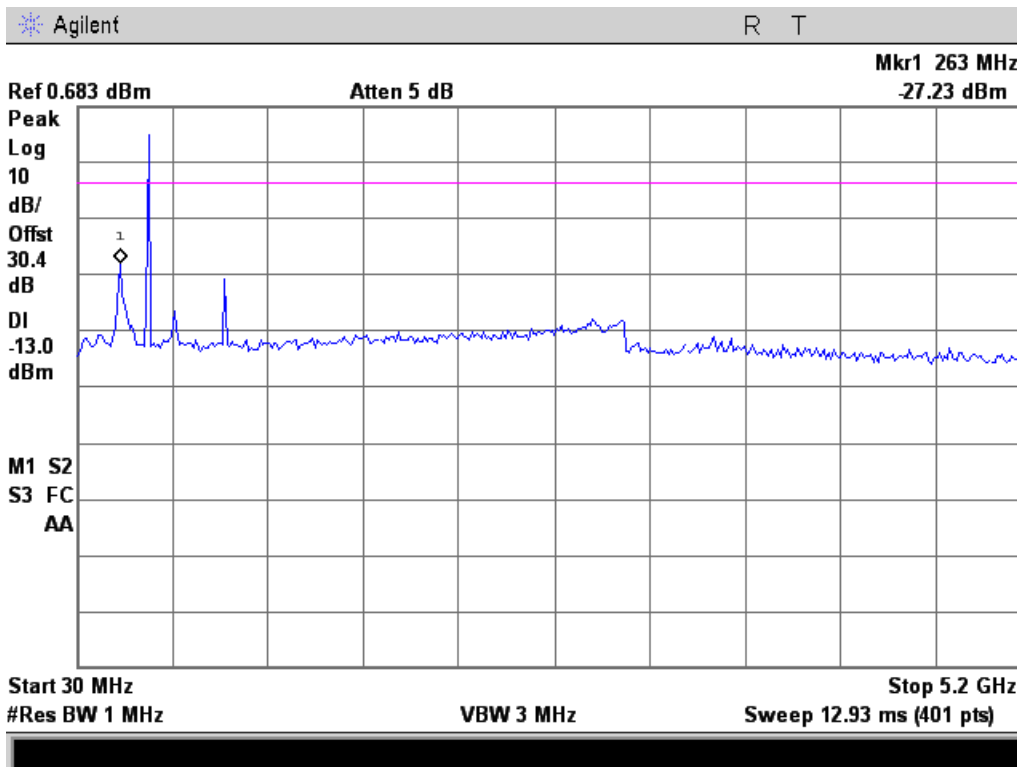



420.975 MHz

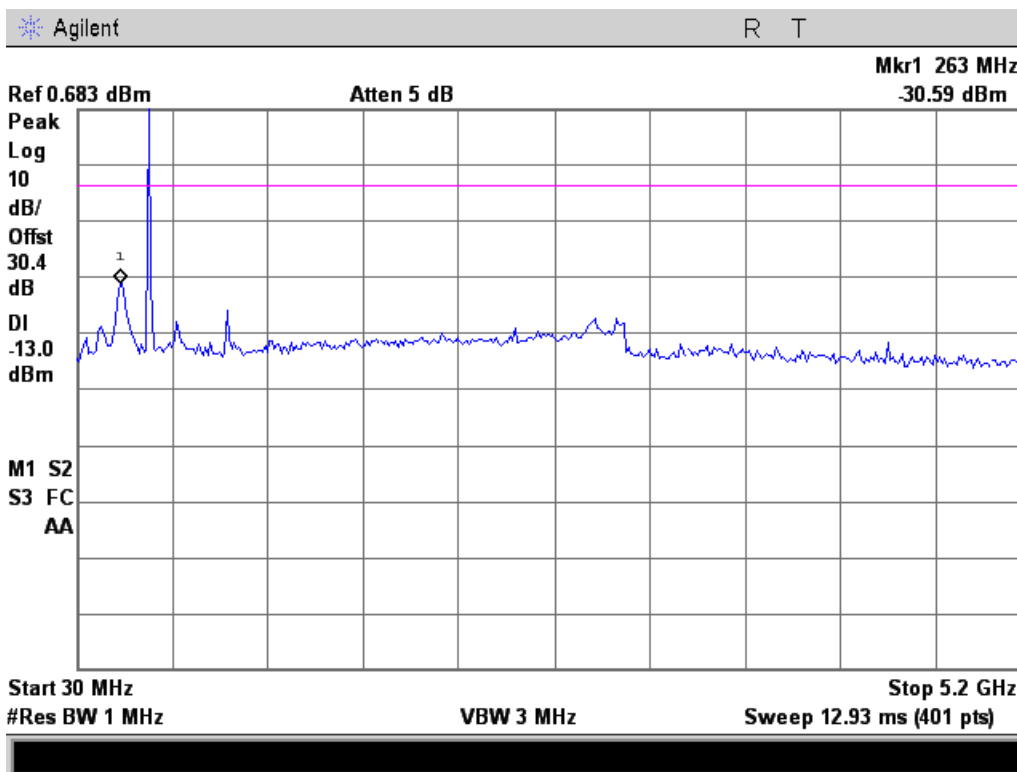

438.05 MHz

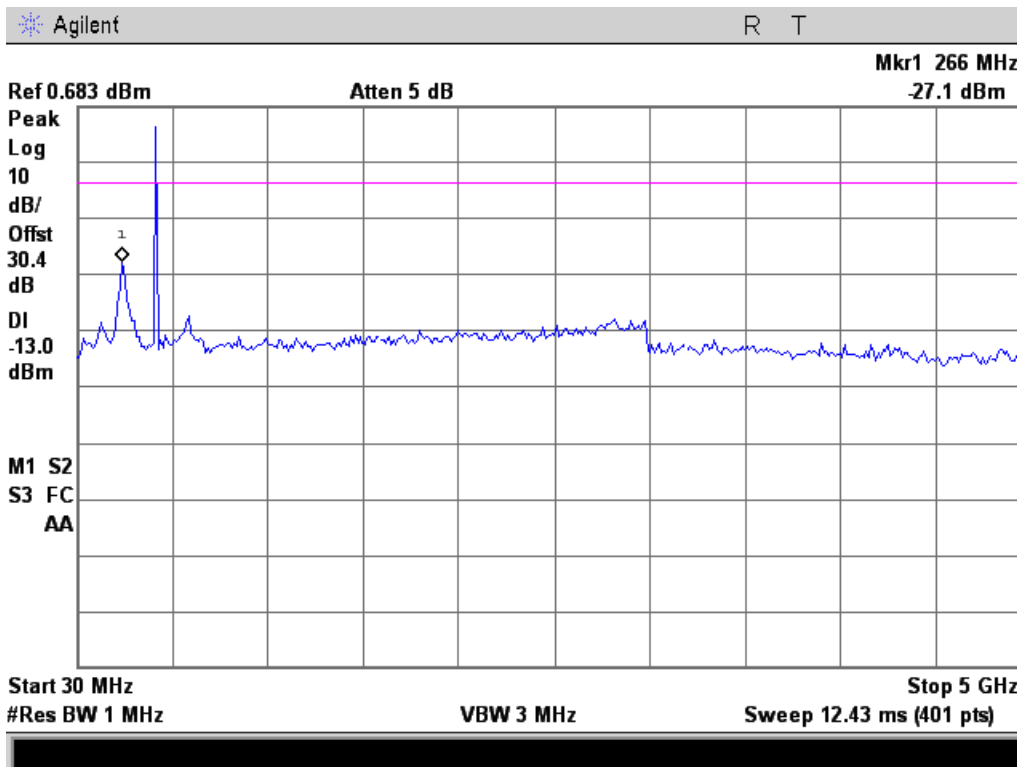



469.95 MHz

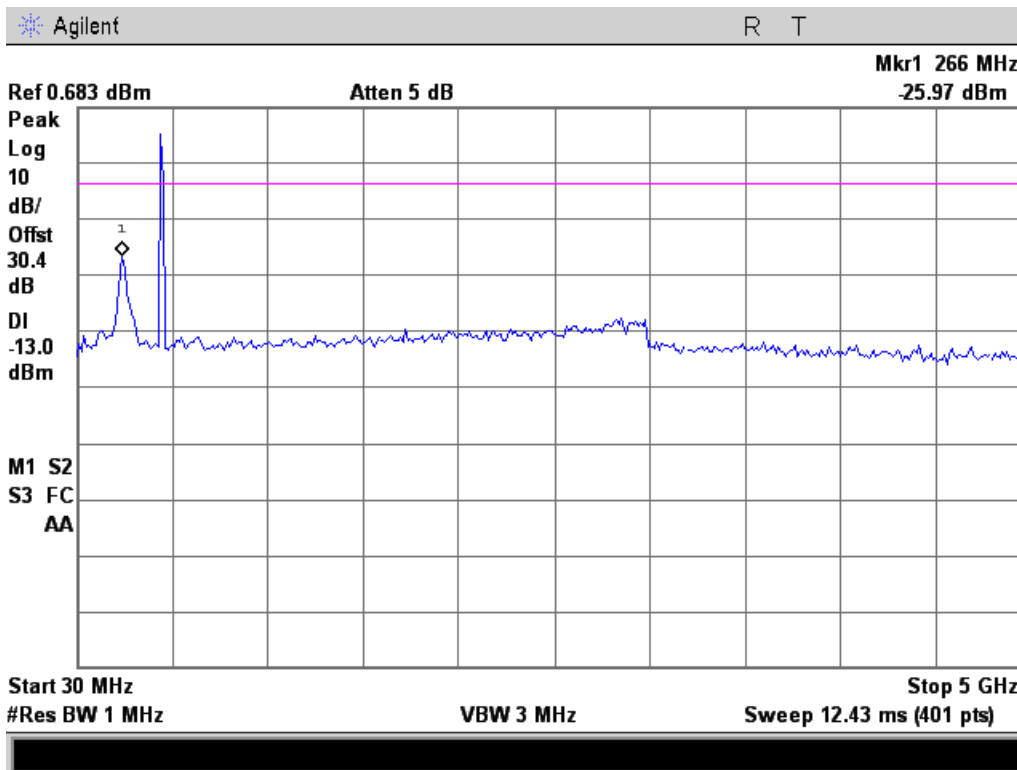

470.05 MHz

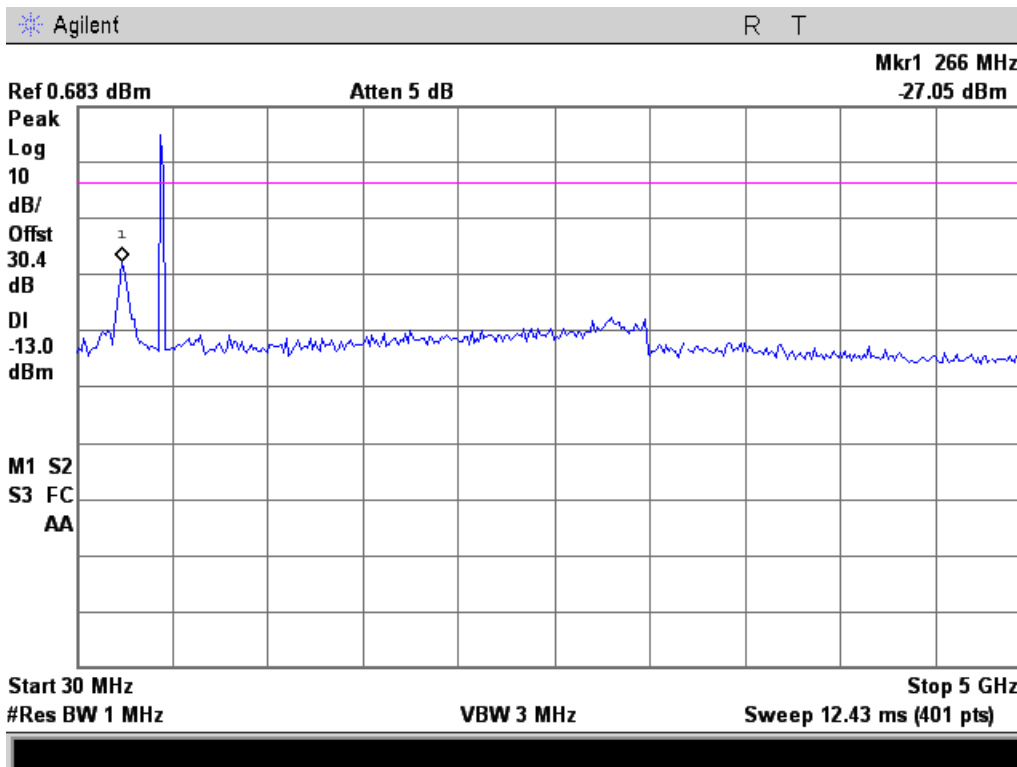



490.05 MHz

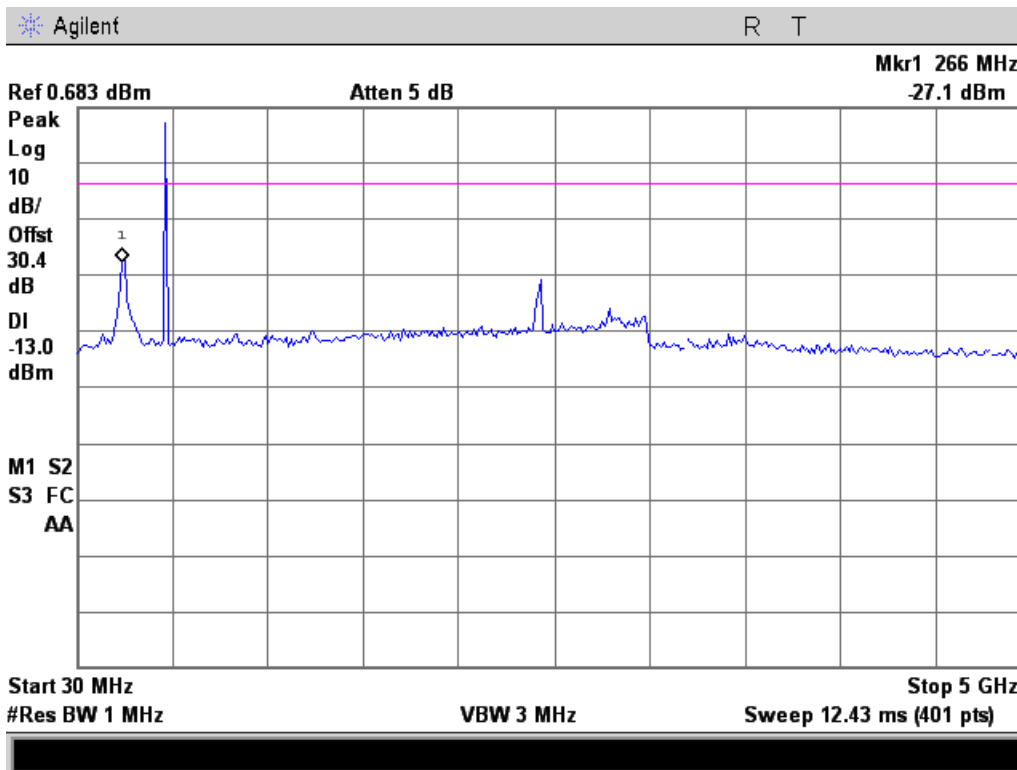

511.95 MHz

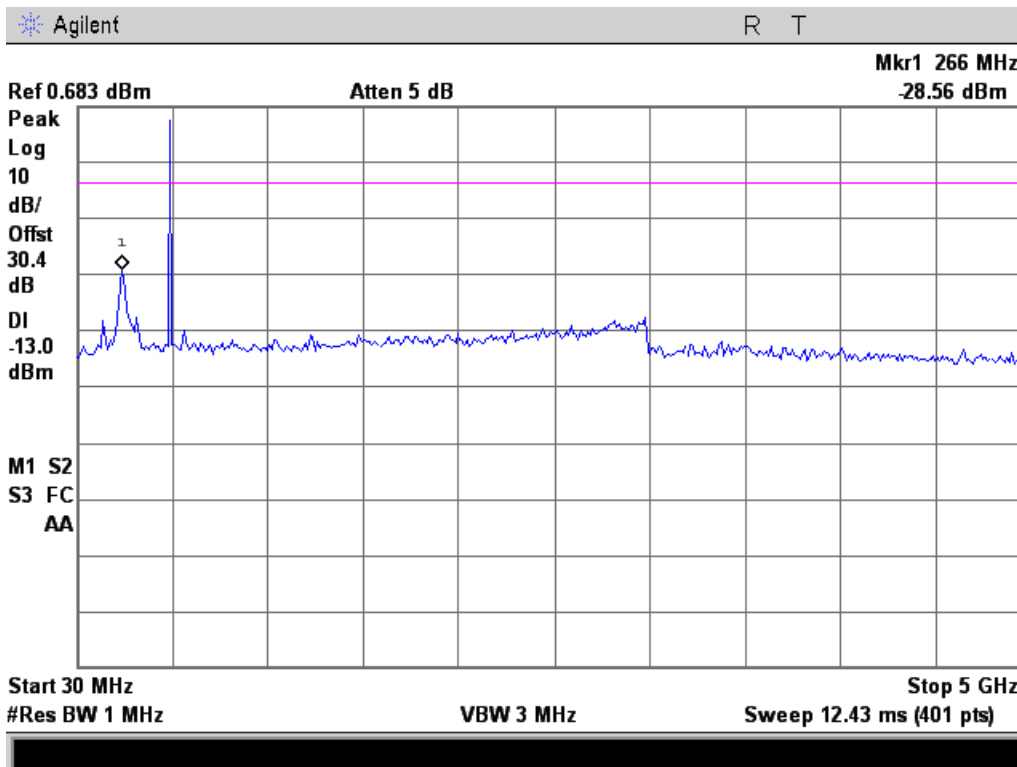



519.95 MHz

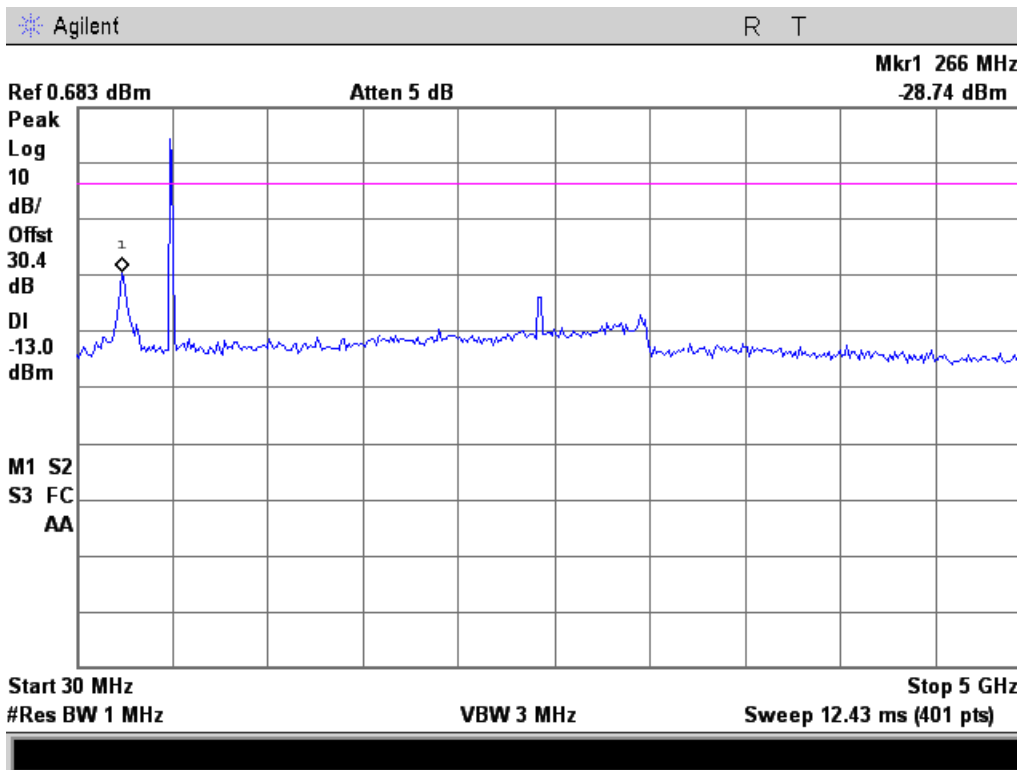

764.05 MHz

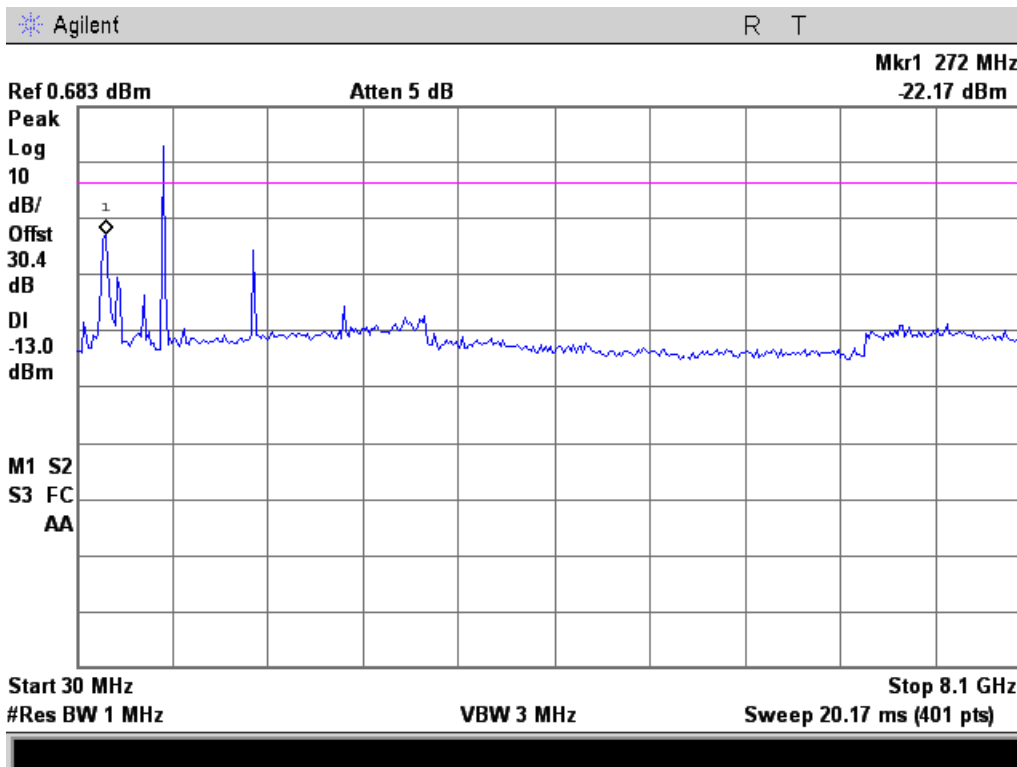



769.95 MHz

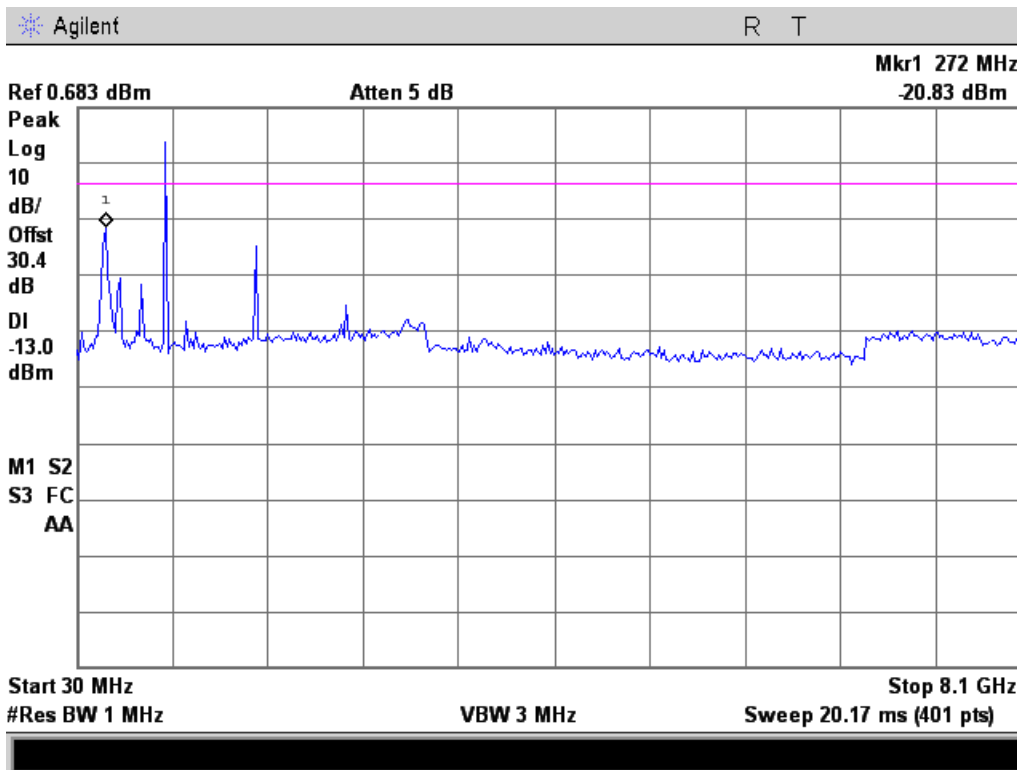

774.95 MHz

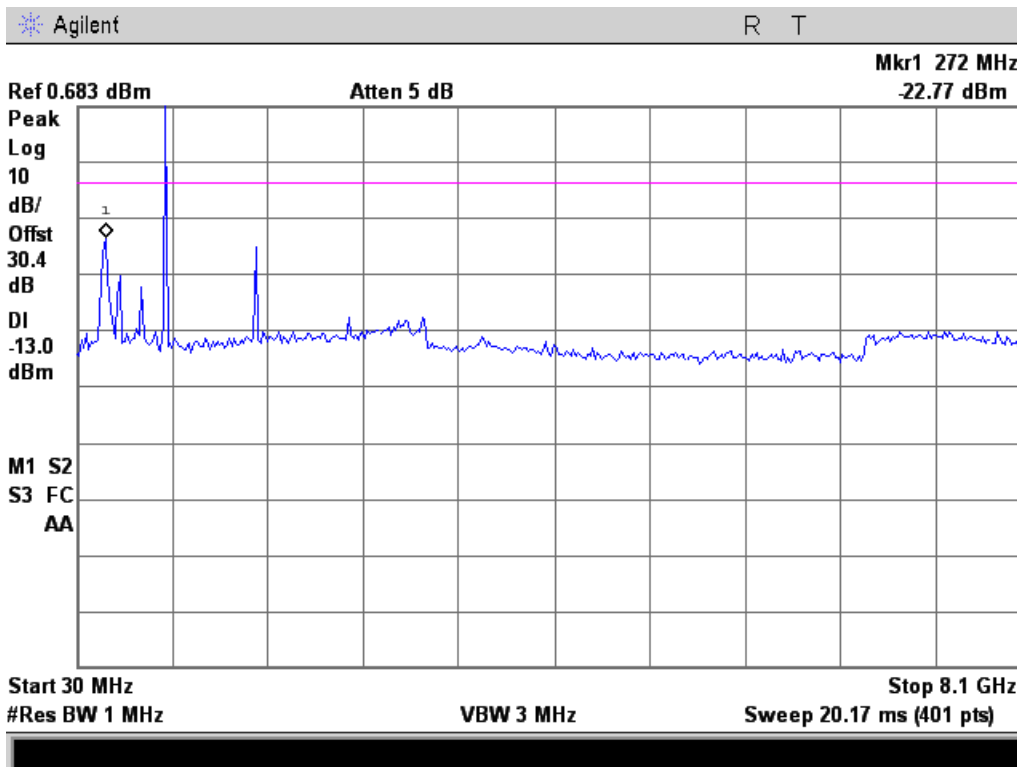



793.05 MHz

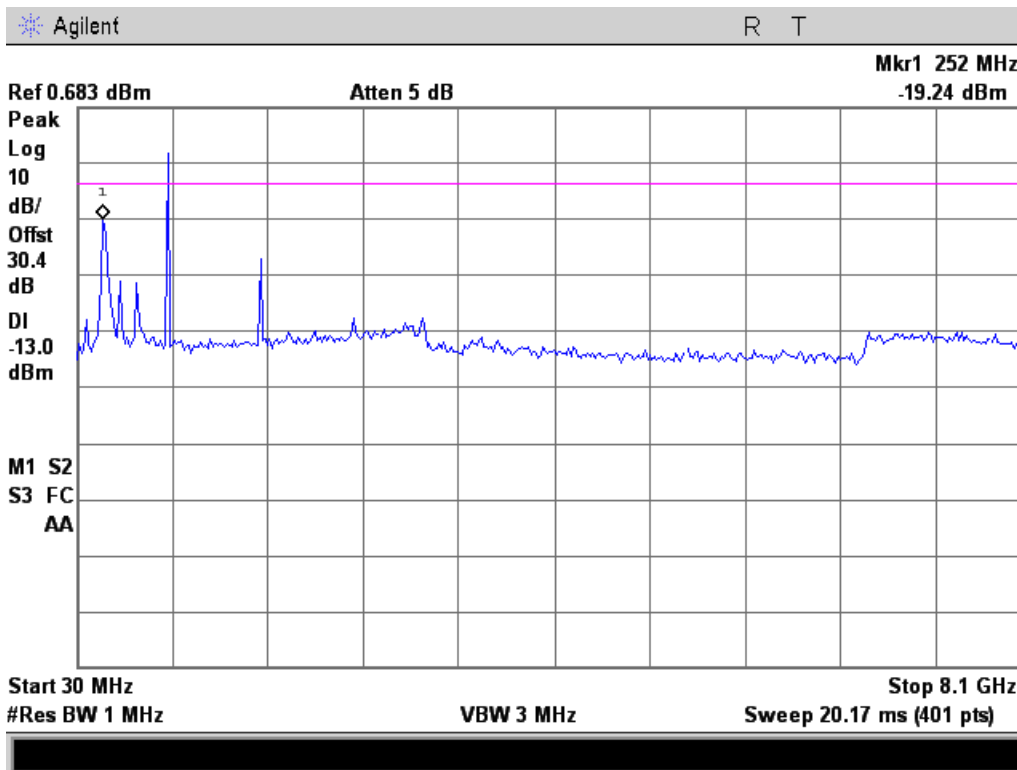

799.95 MHz

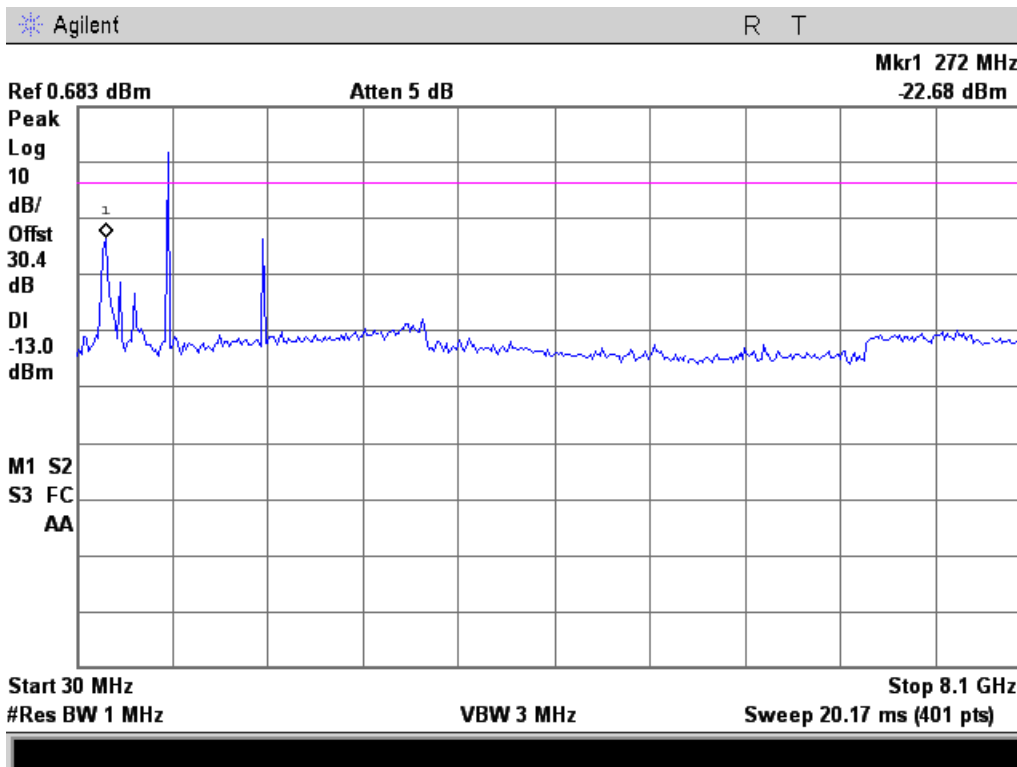



804.95 MHz

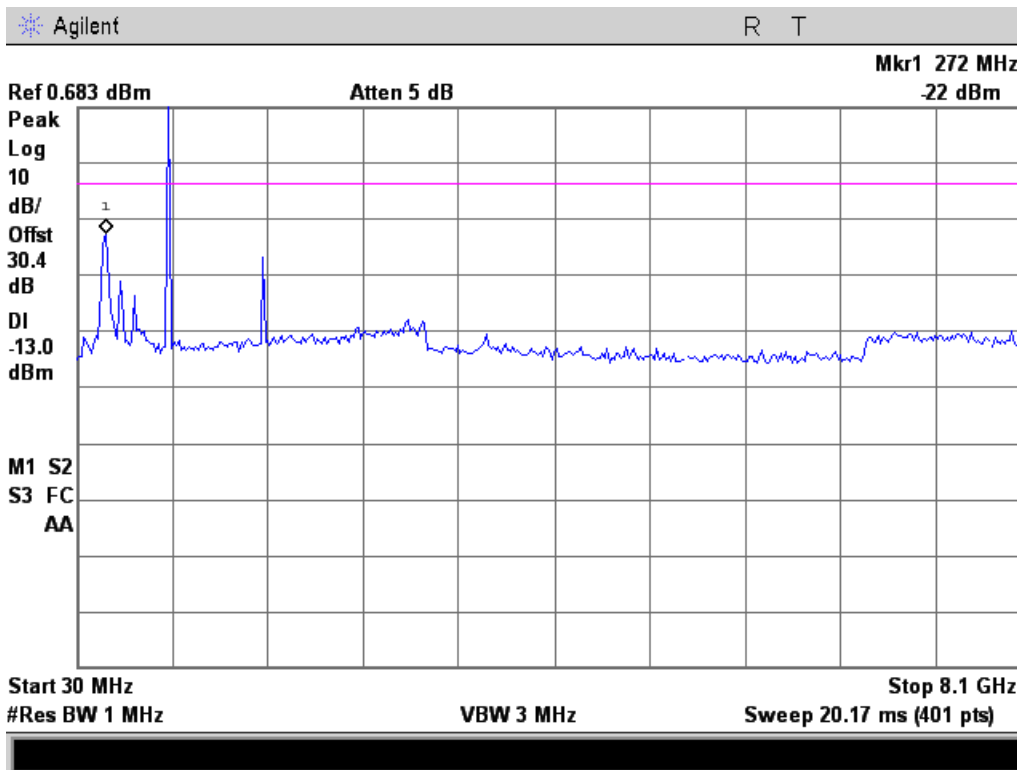

806.05 MHz

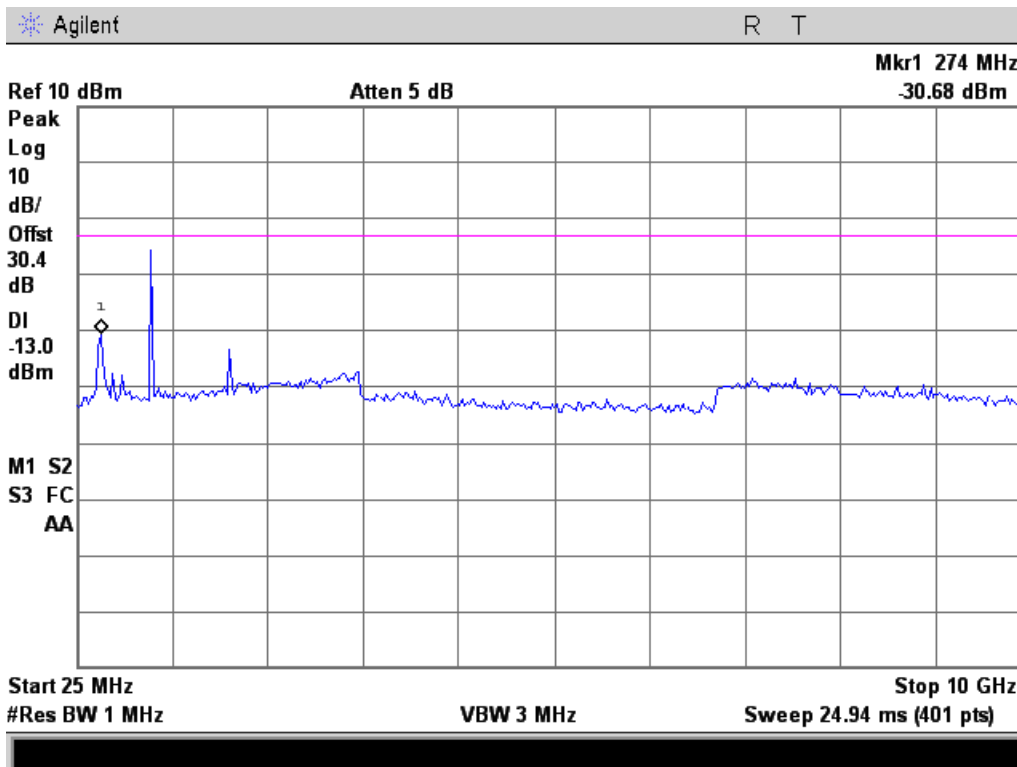



848.95 MHz

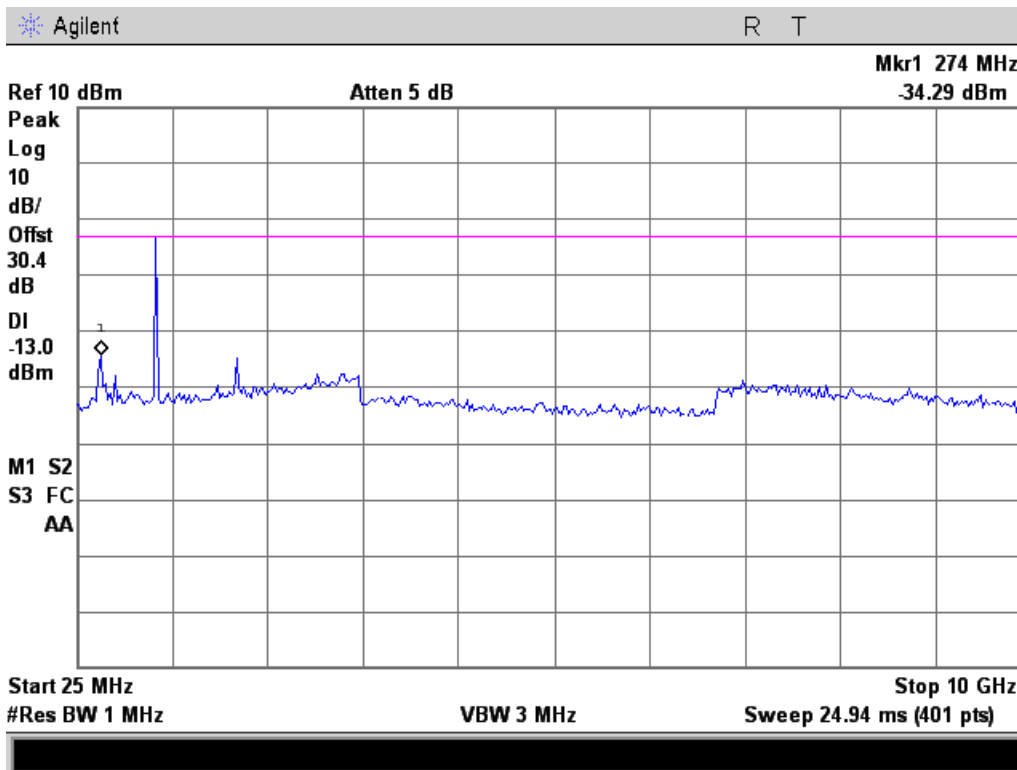

850.95 MHz

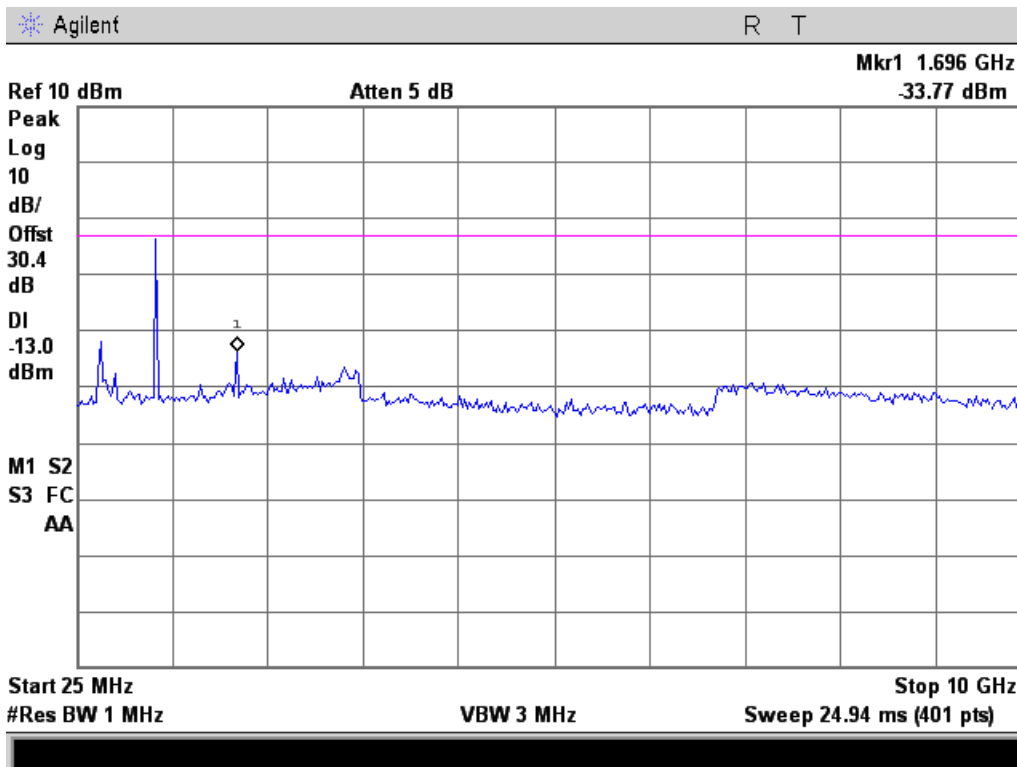



851.05 MHz

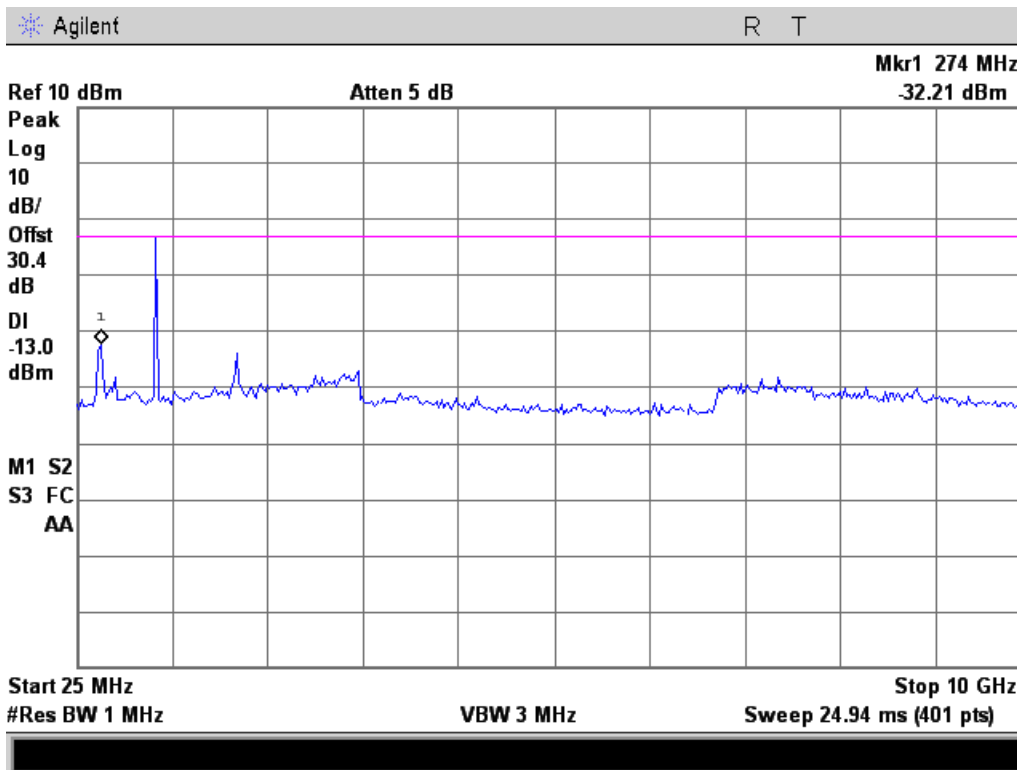

854.05 MHz

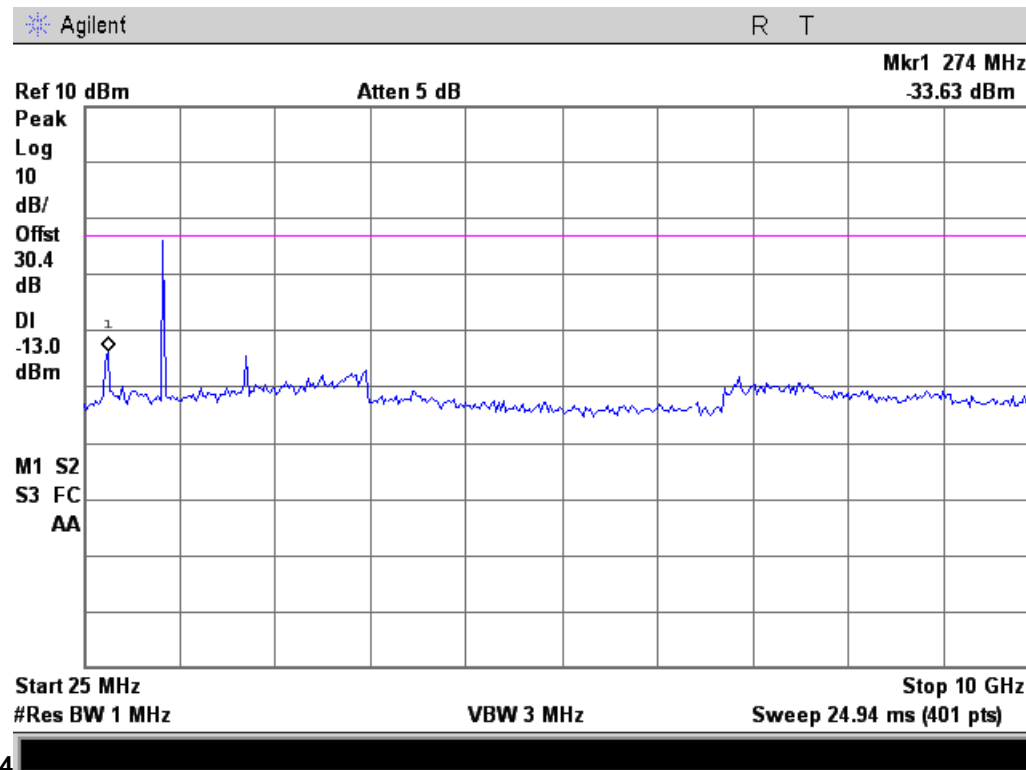



869.95 MHz

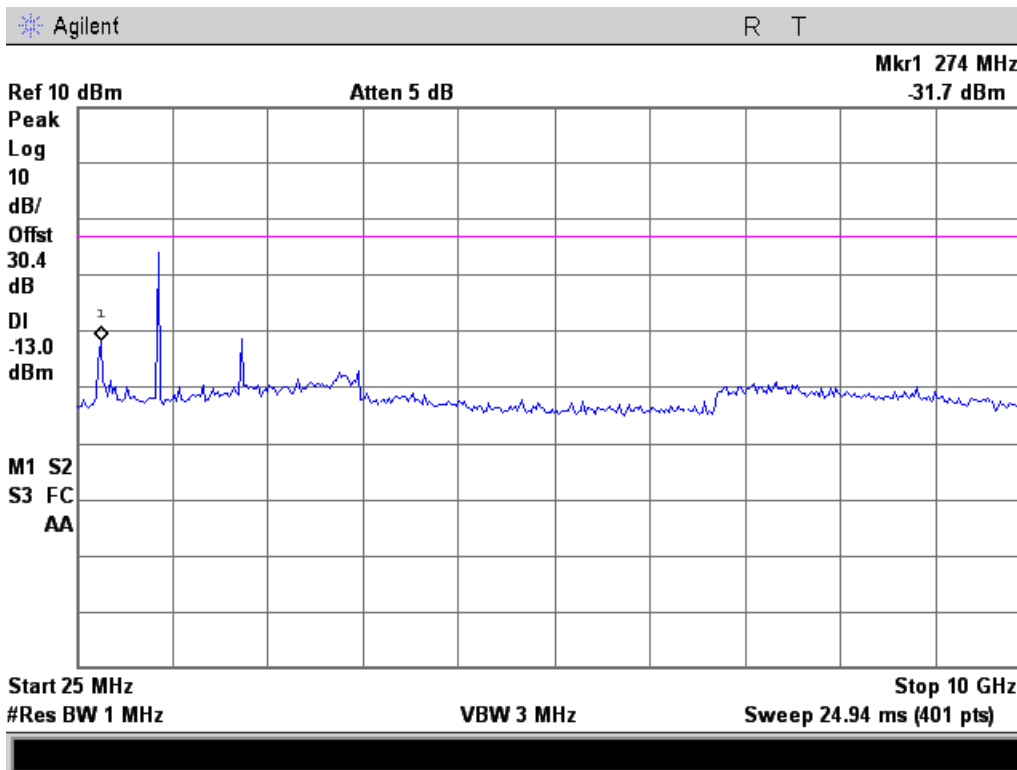

872.05 MHz

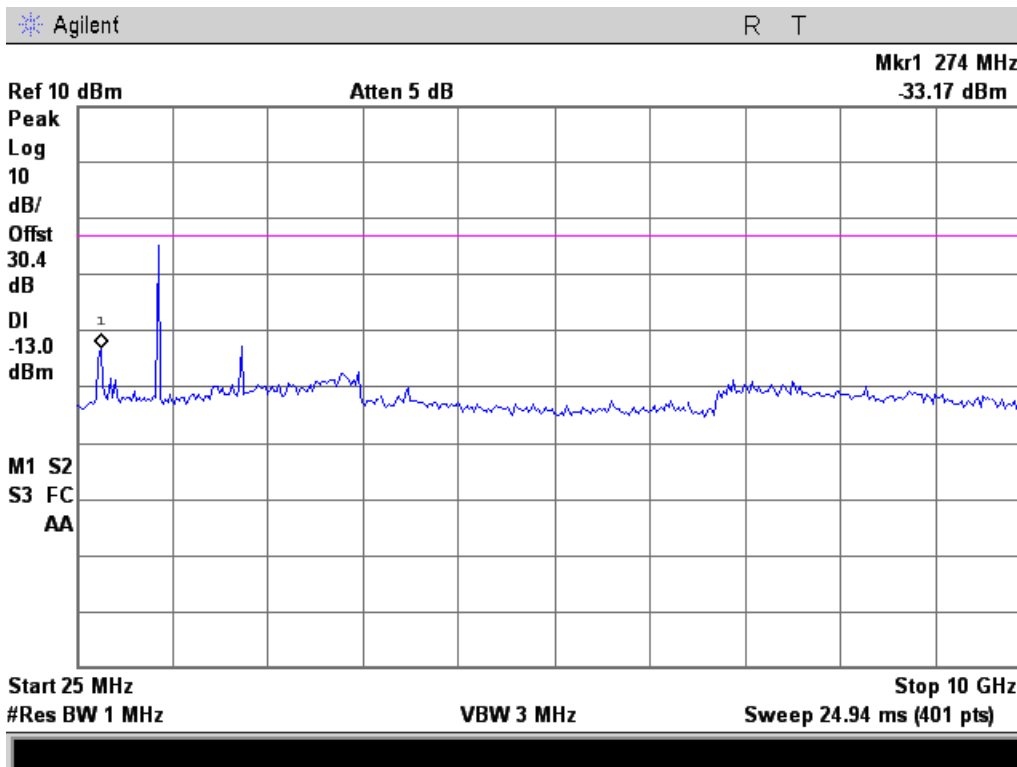



893.95 MHz

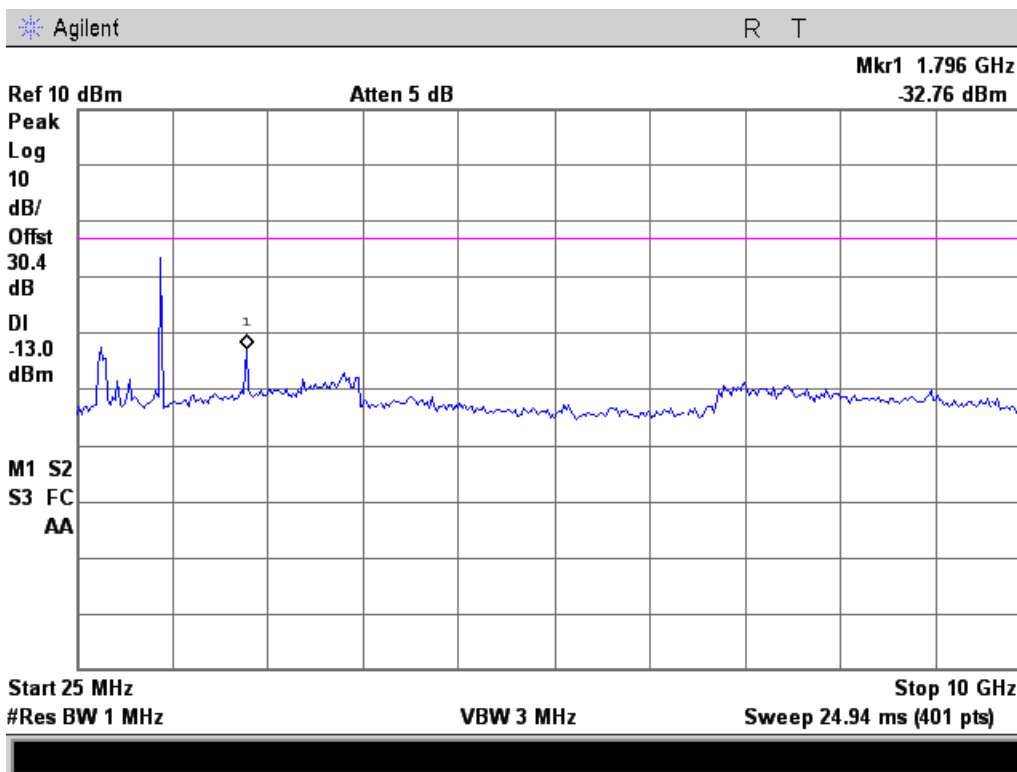

895.95 MHz

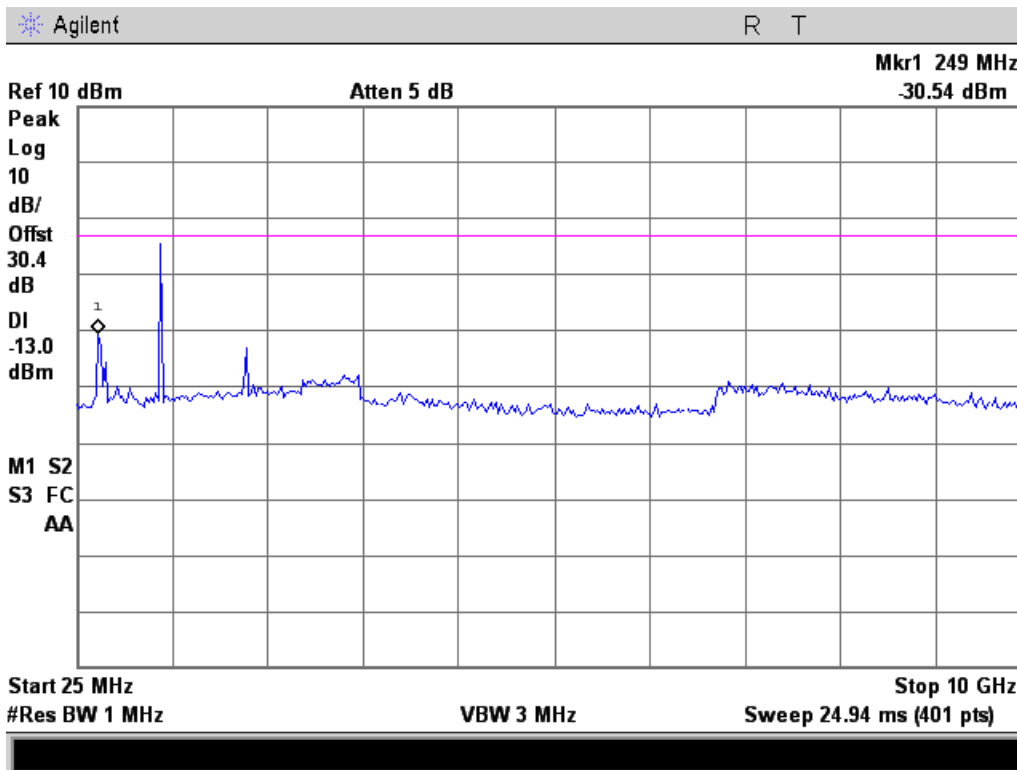



896.05 MHz

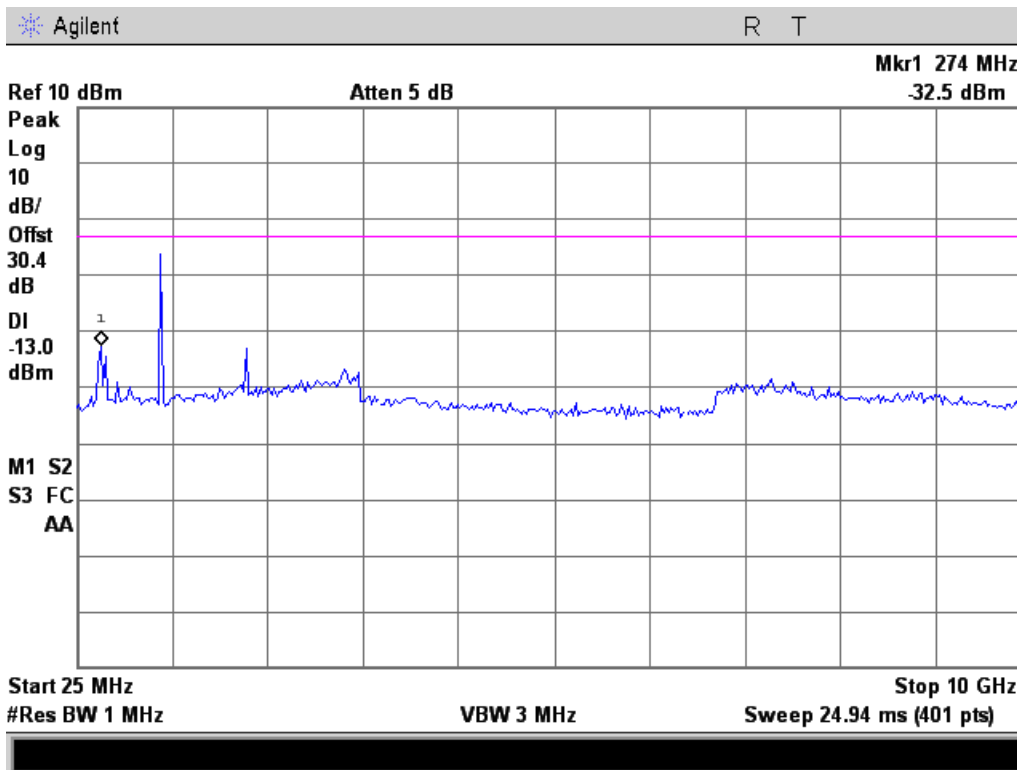

900.95 MHz

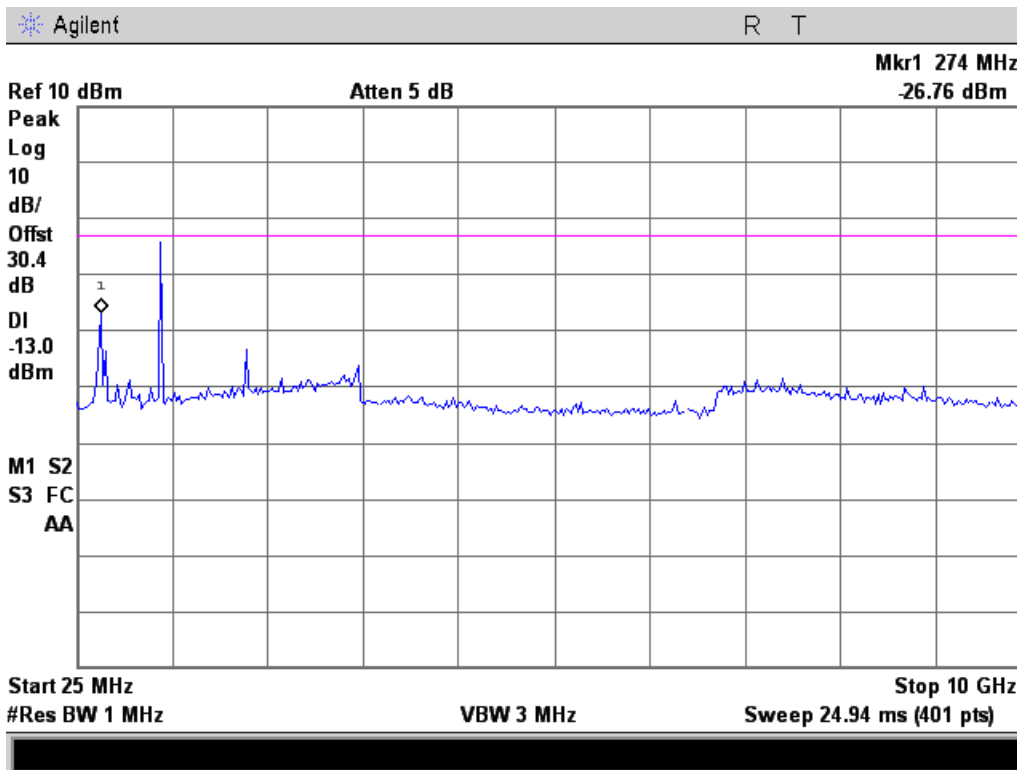



902.05 MHz

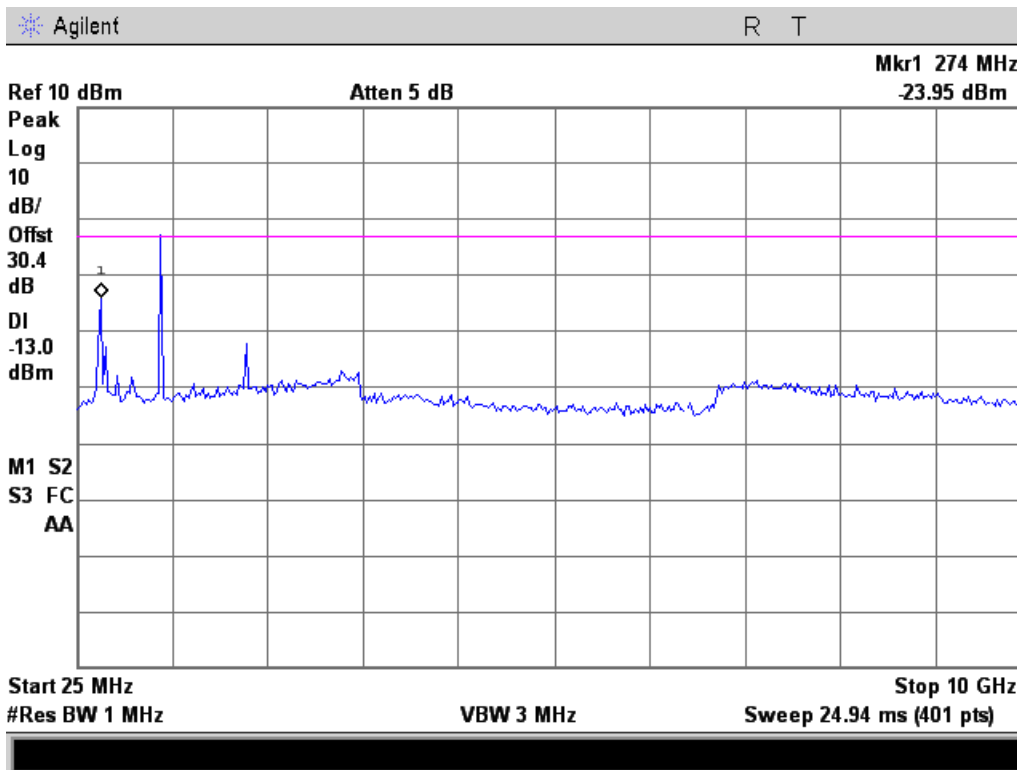

916.05 MHz

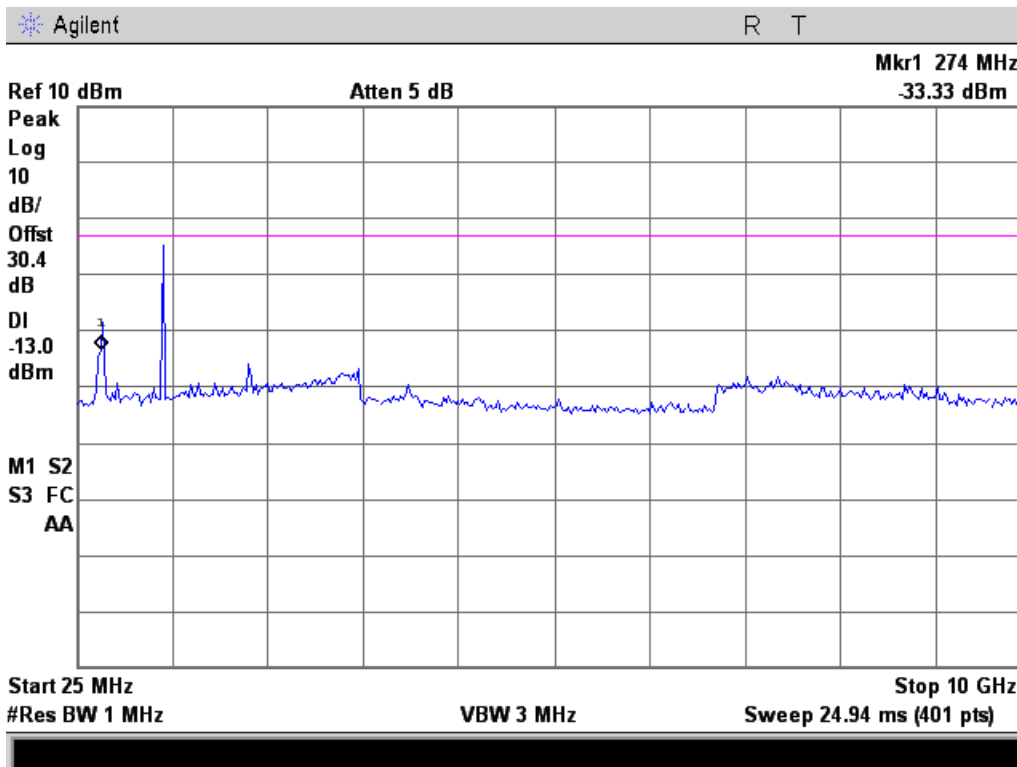



928.05 MHz

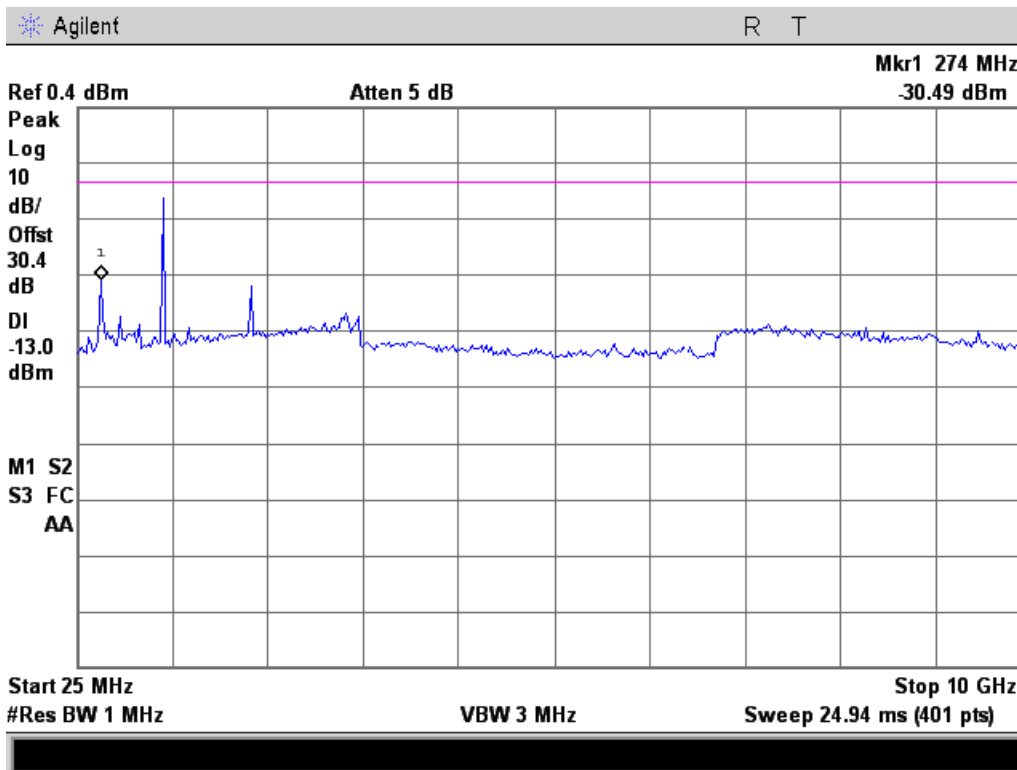

928.95 MHz

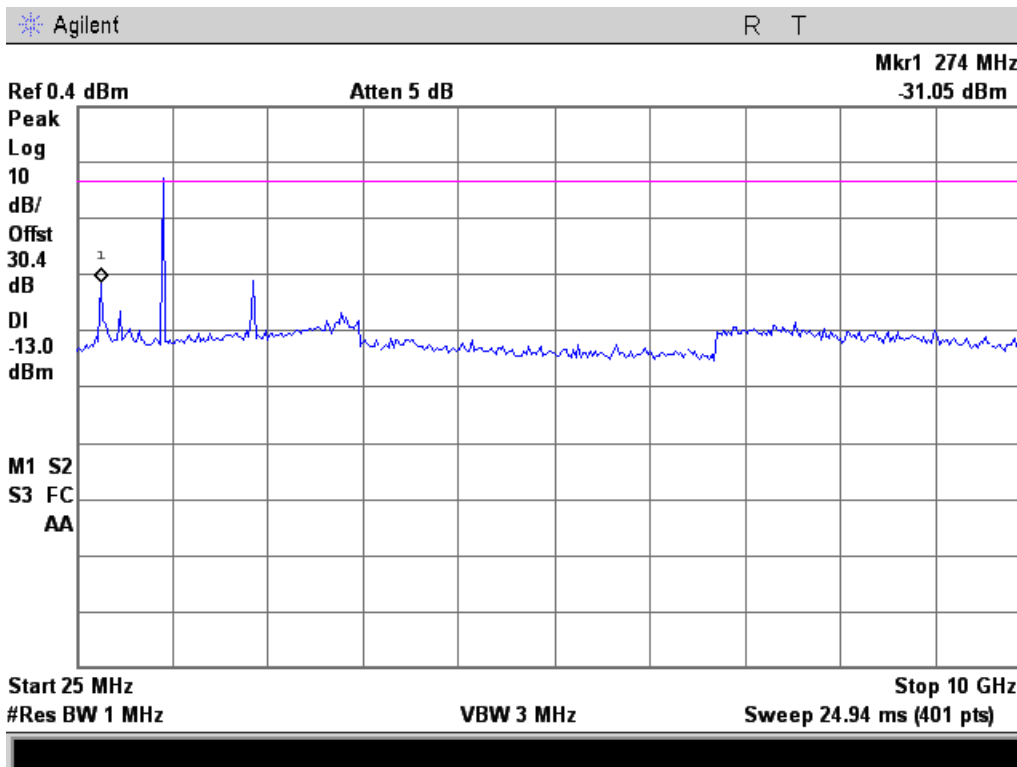



929.95 MHz

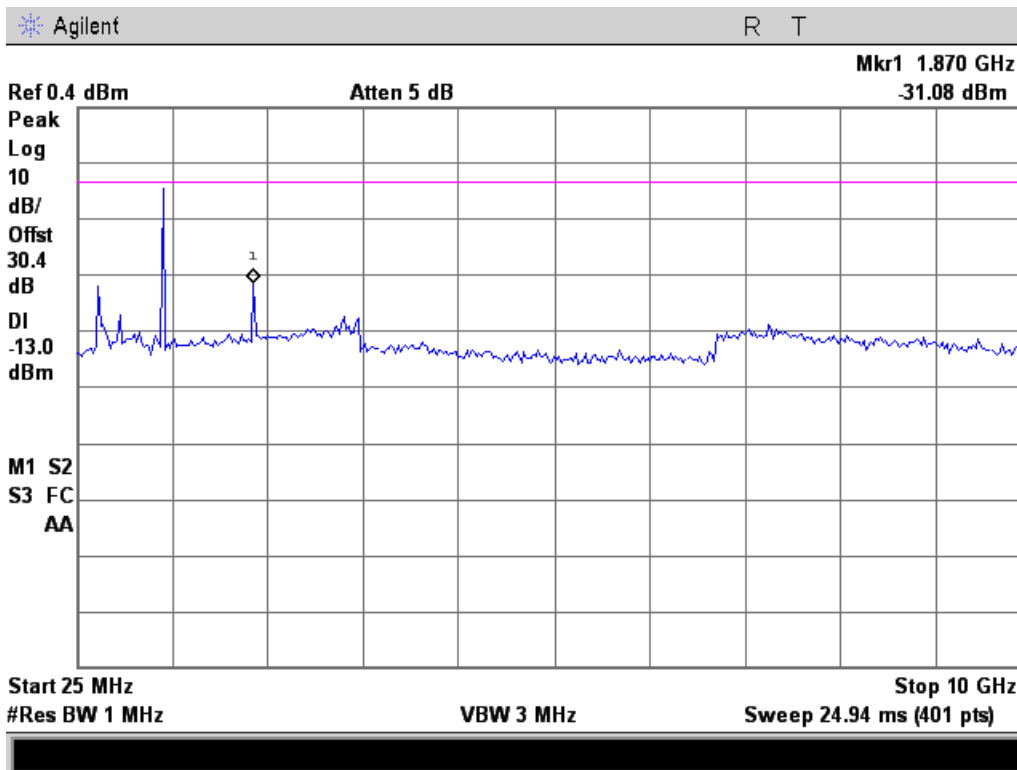

931.05 MHz

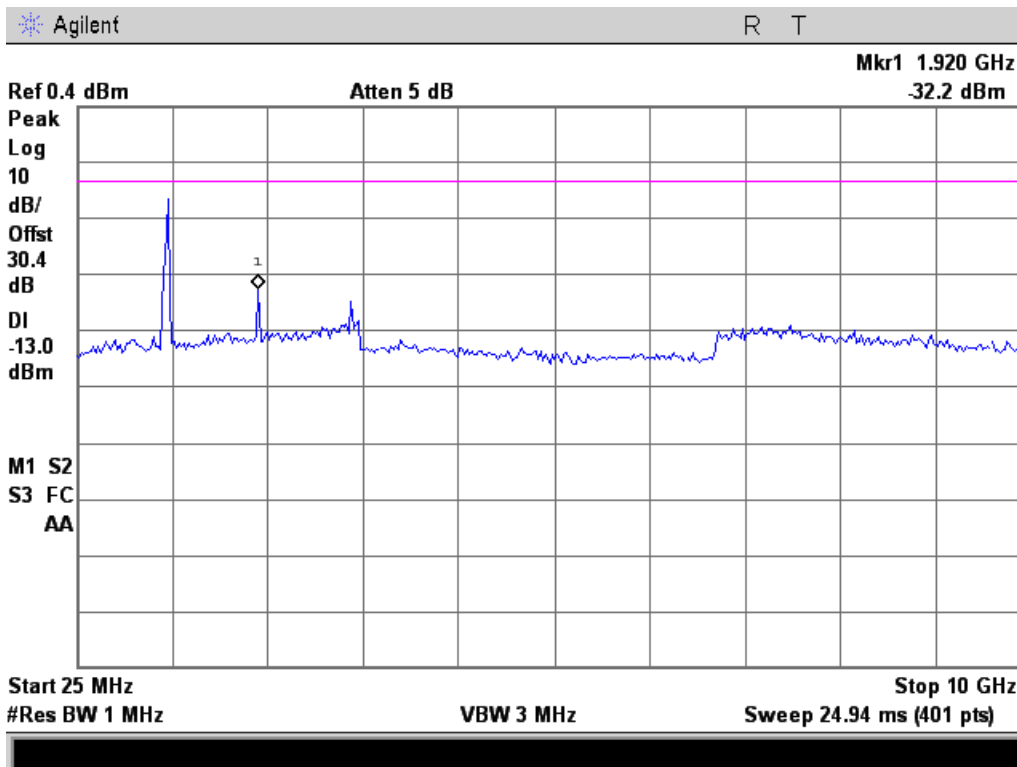



934.95 MHz

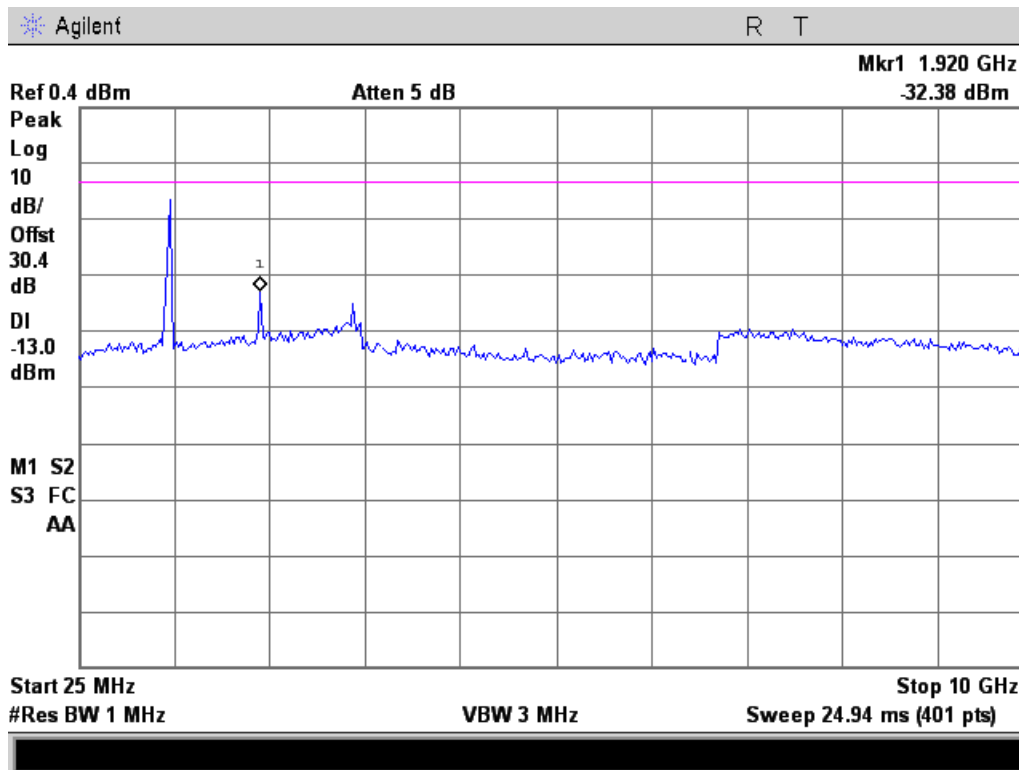

935.05 MHz

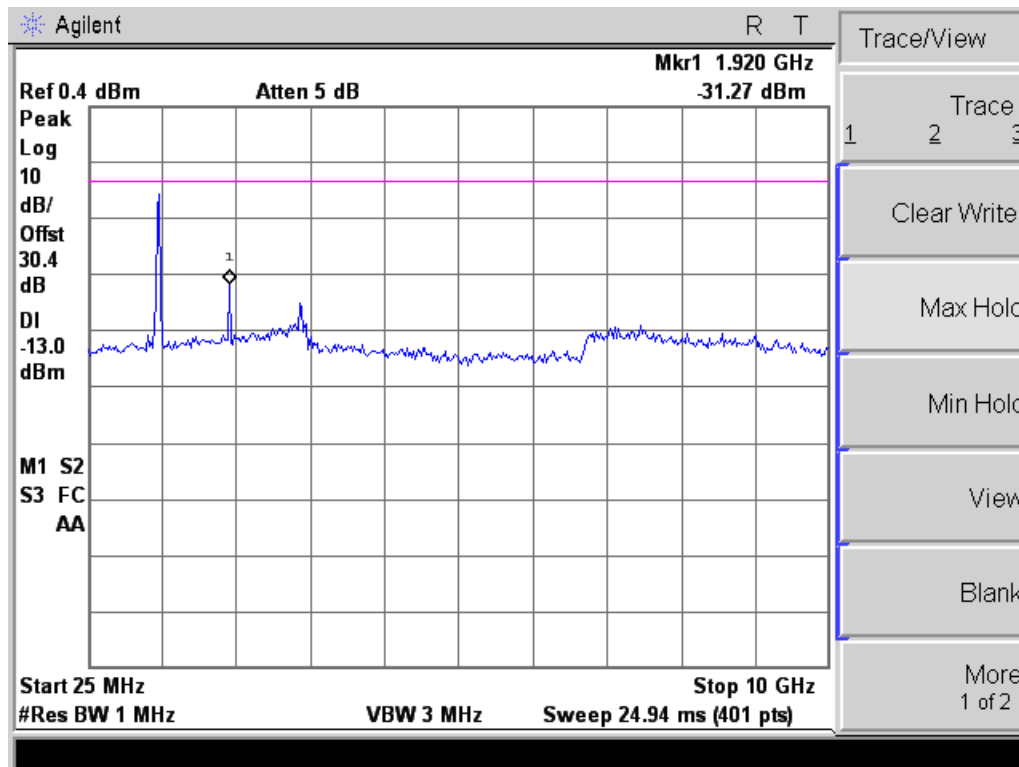



939.95 MHz

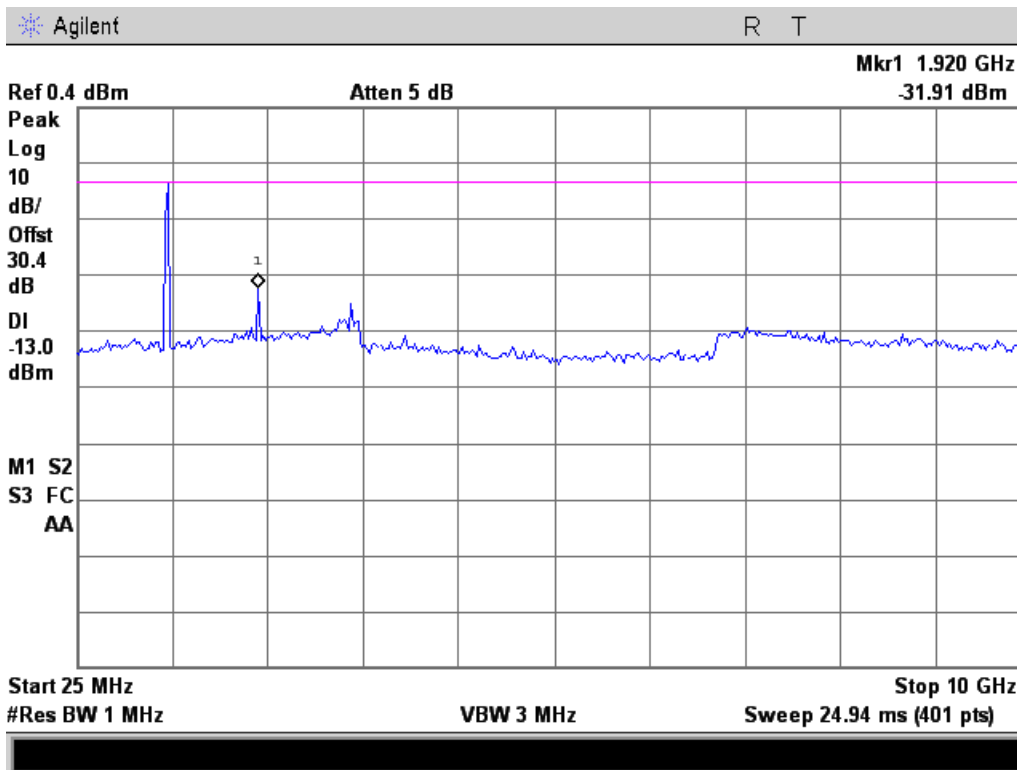

941.05 MHz

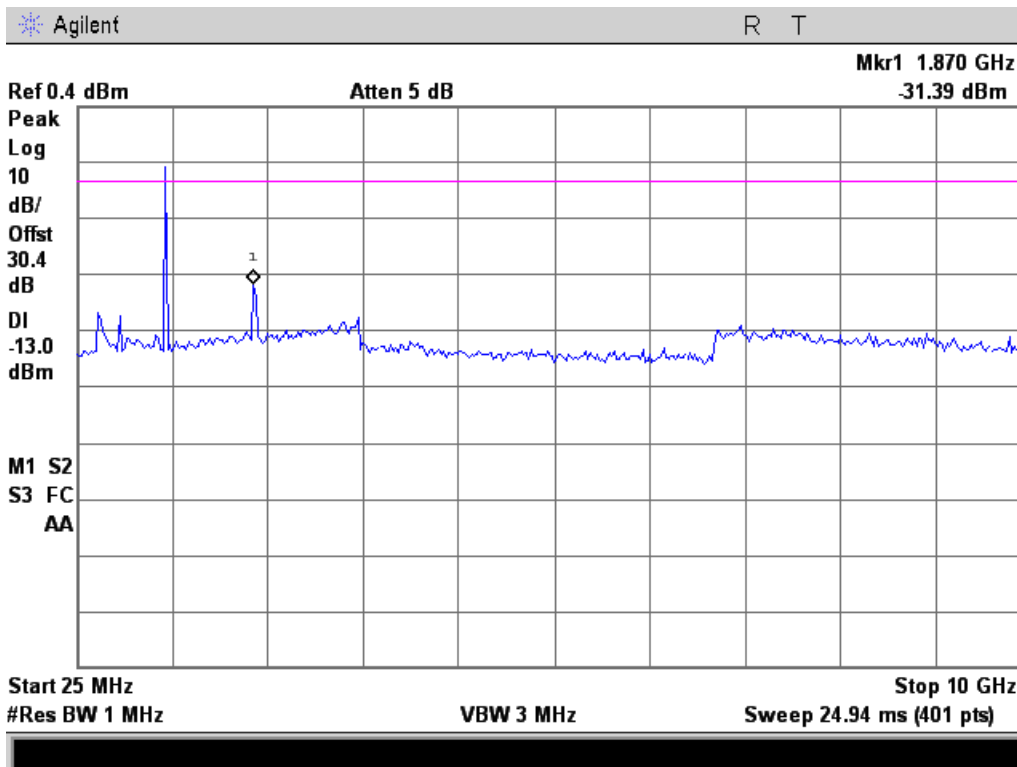



950.05 MHz

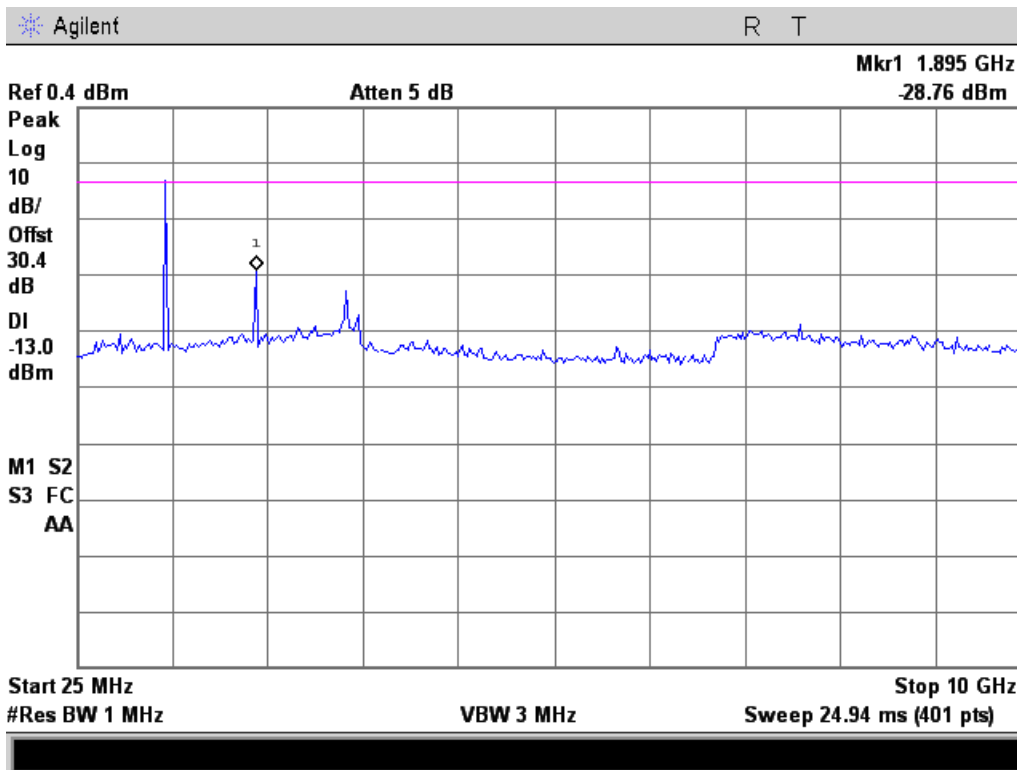

959.95 MHz

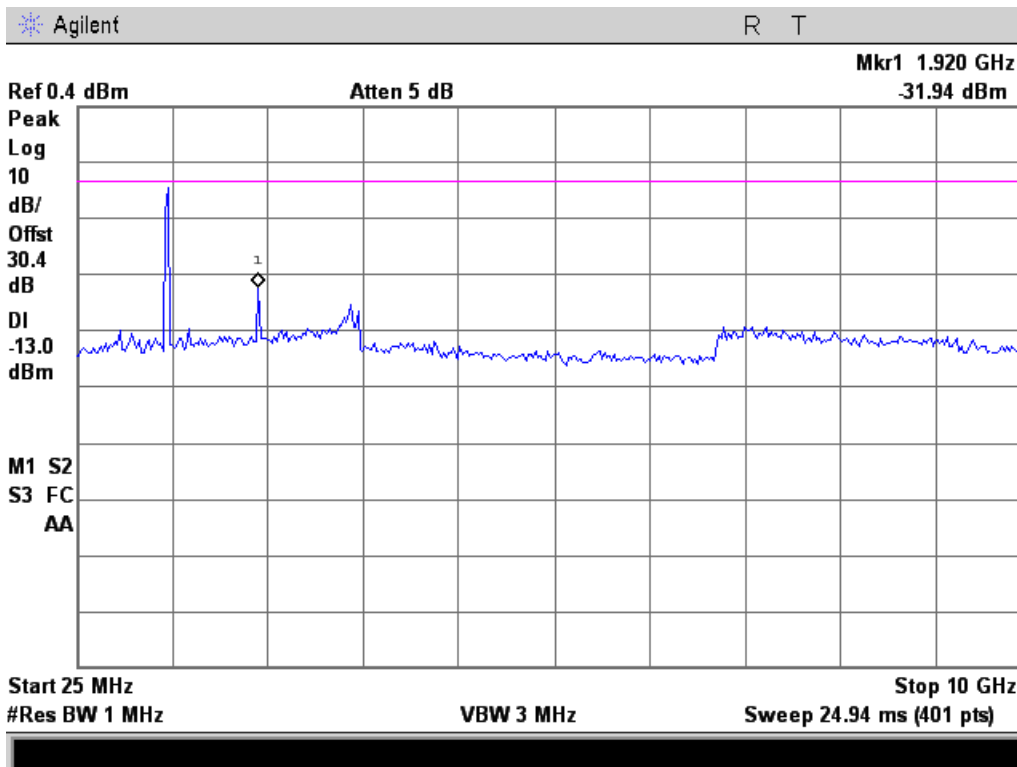



MTM 138.05 MHz

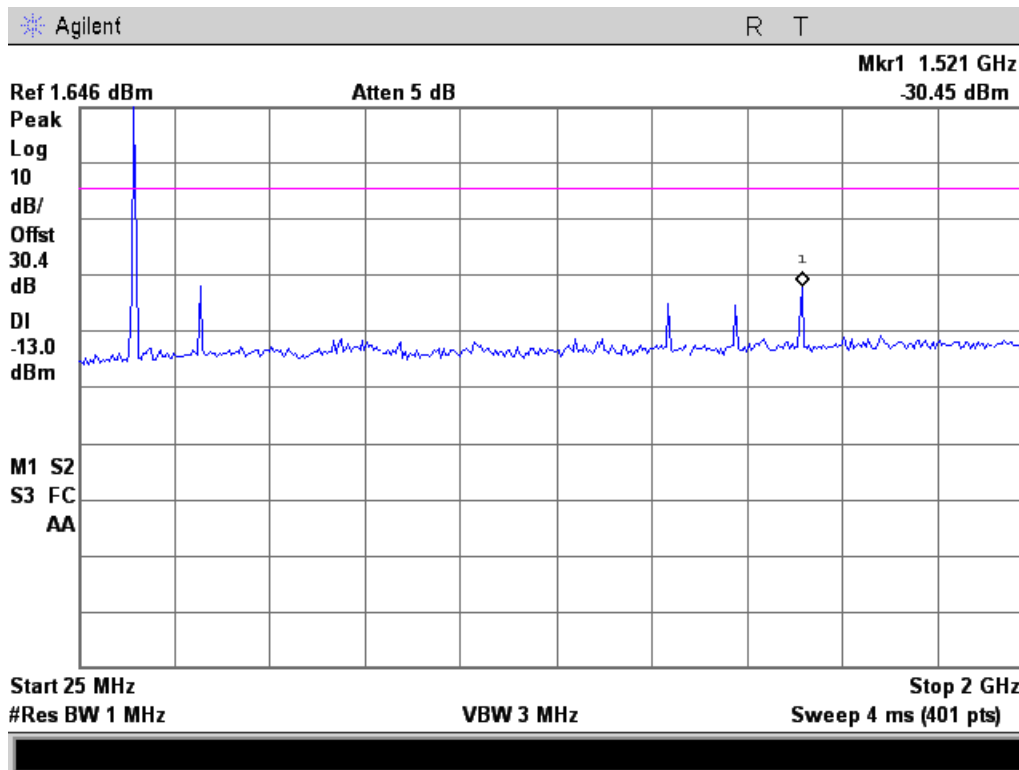

MTM 150.05 MHz

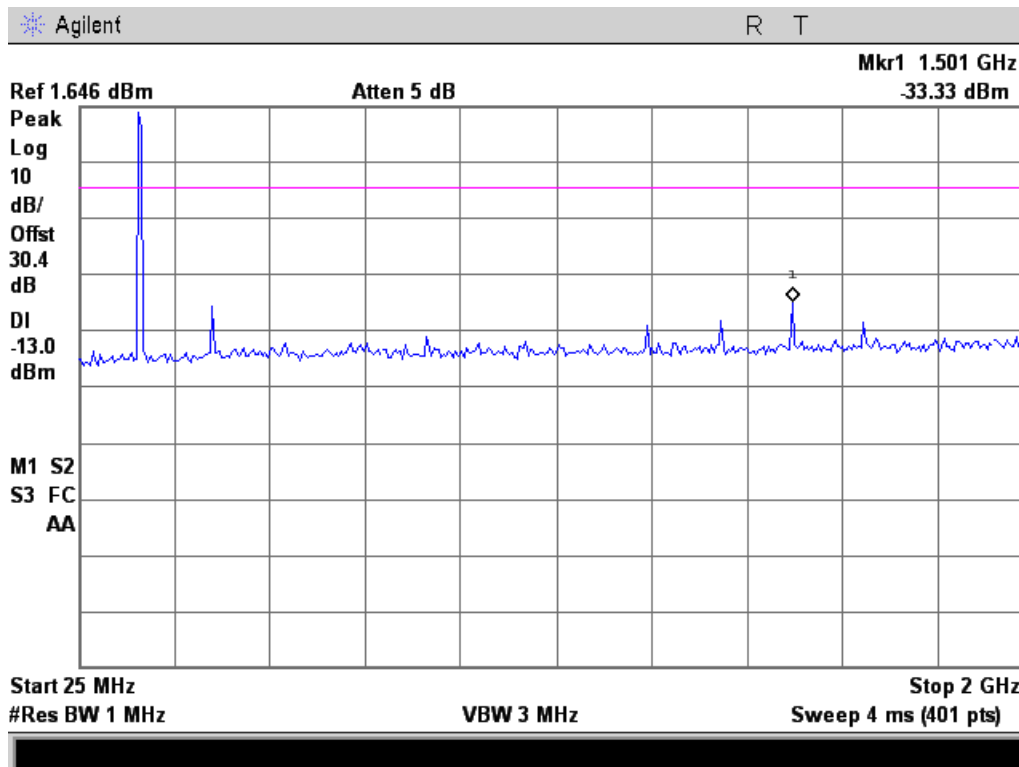



MTM 161.775 MHz

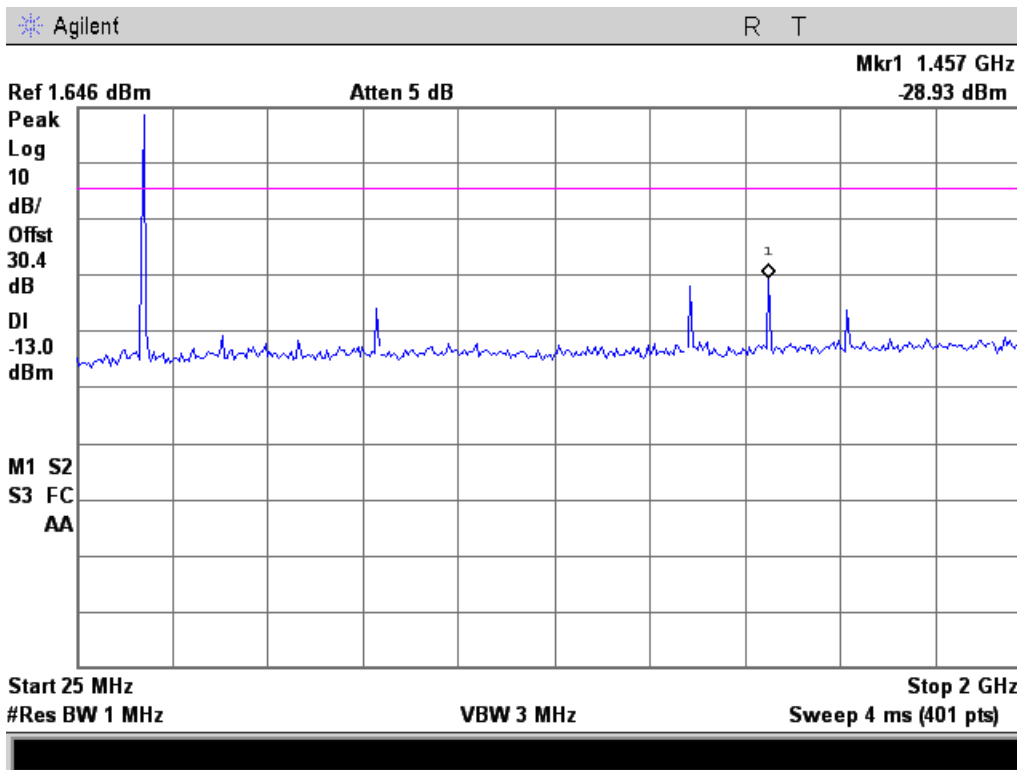

MTM 173.95 MHz

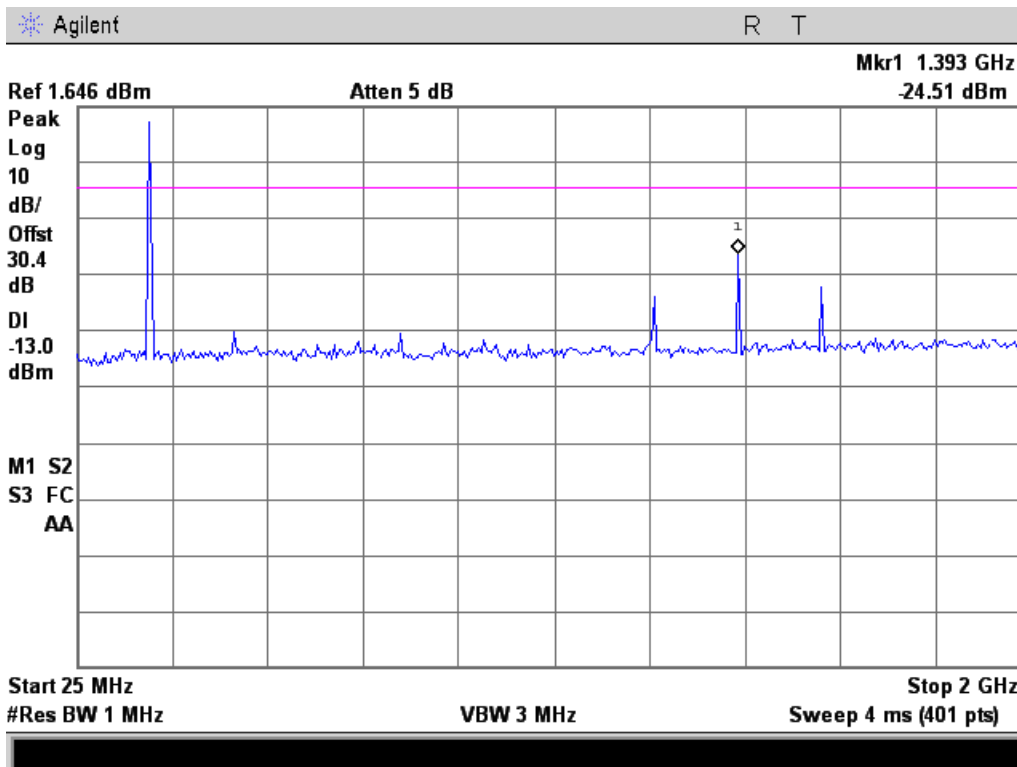



MTM 380.00 MHz

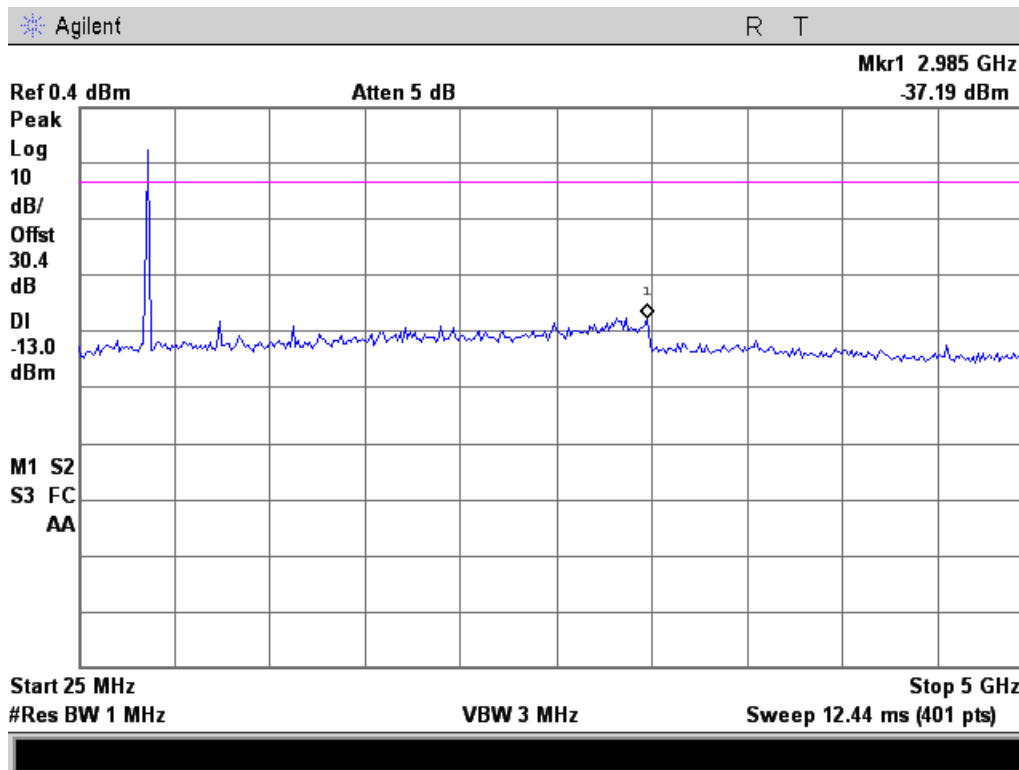

MTM 406.15 MHz

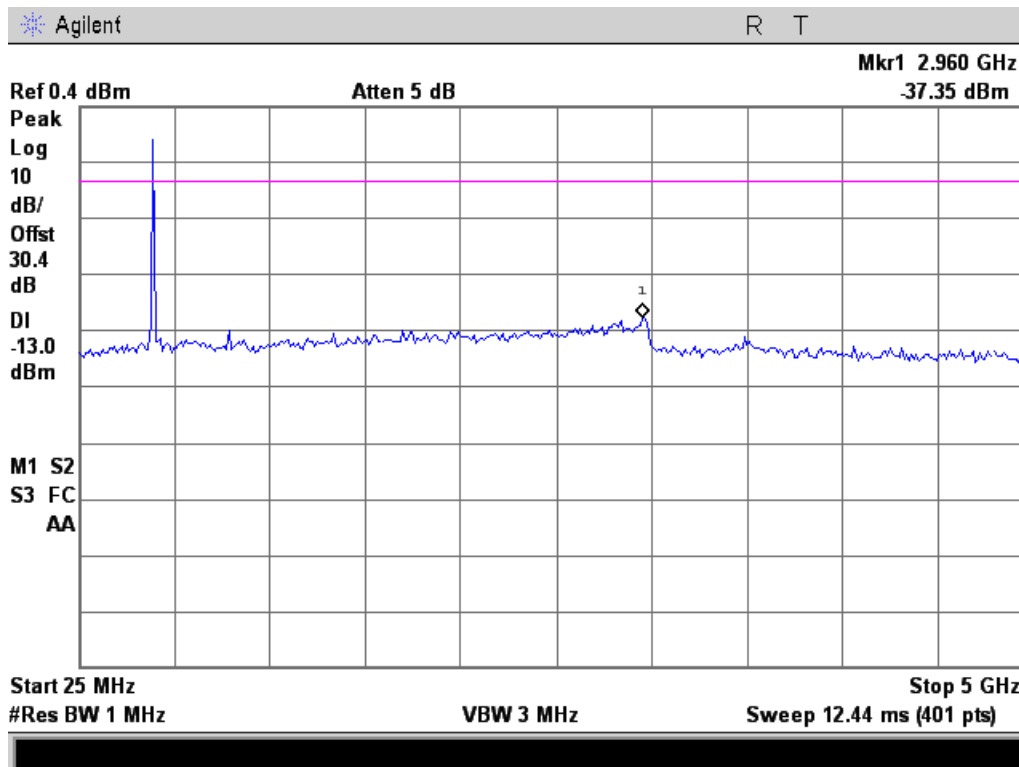



MTM 438.05 MHz

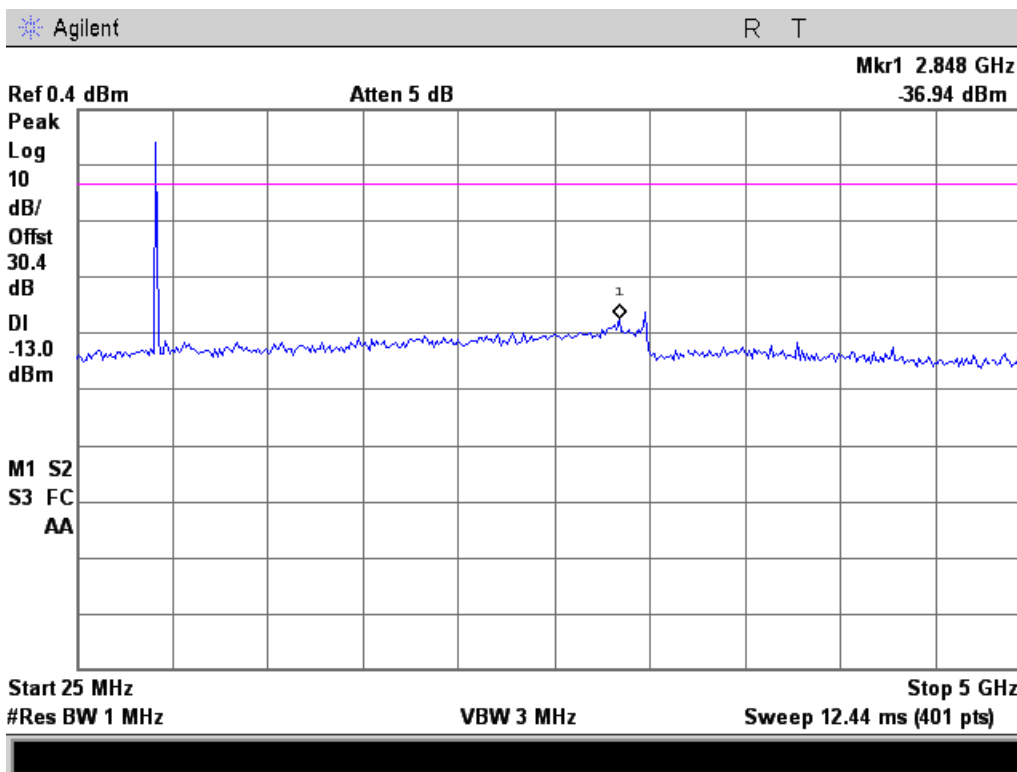

MTM 469.95 MHz

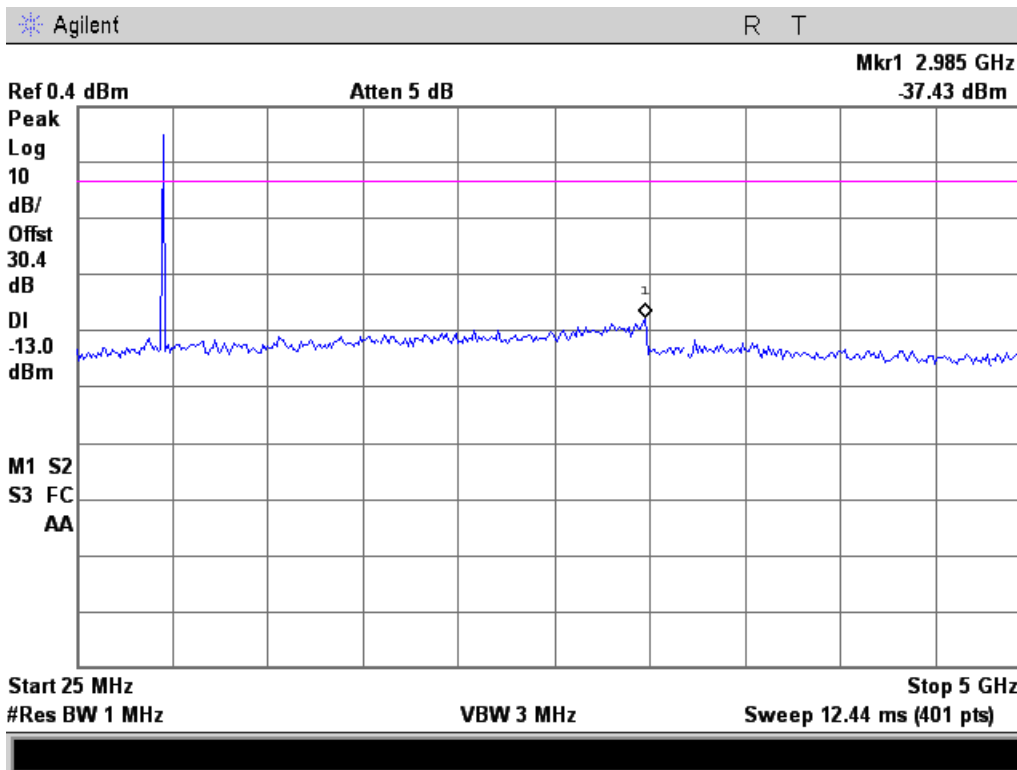



MTM 450.05 MHz

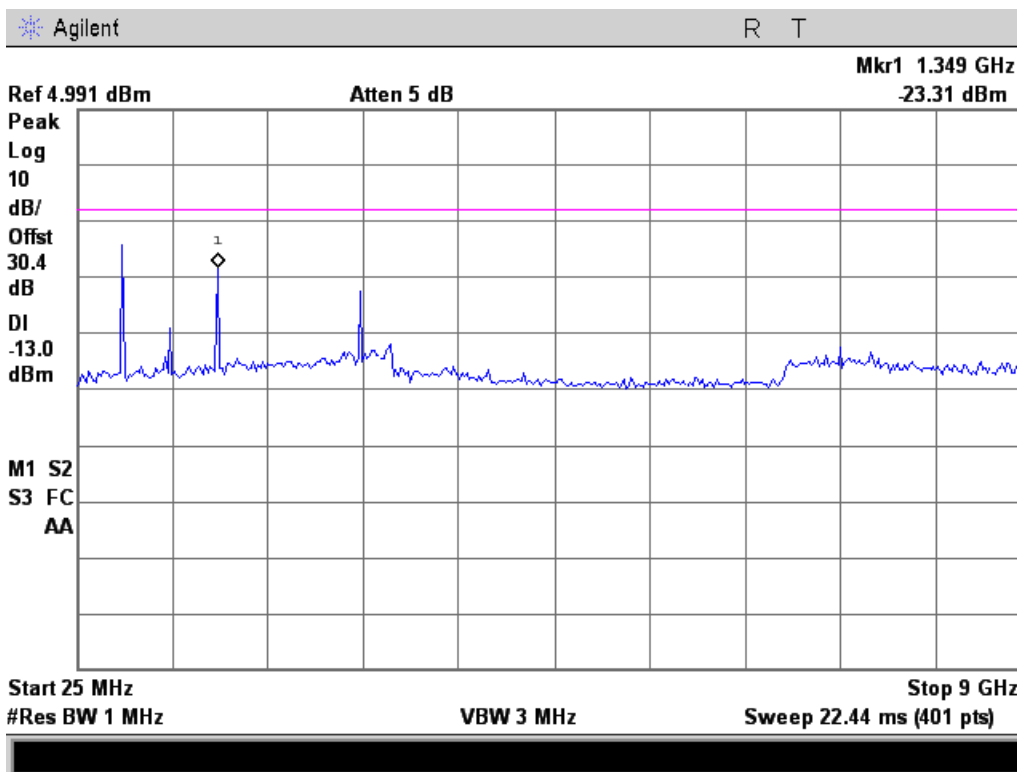

MTM 460.05 MHz

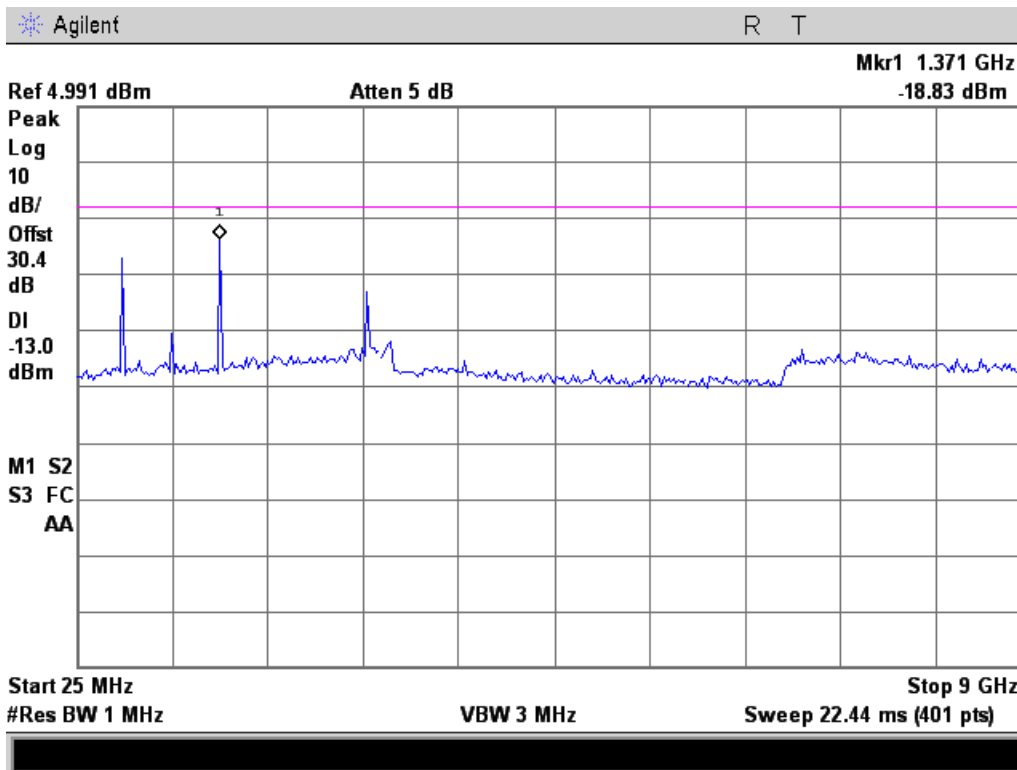



MTM 469.95 MHz

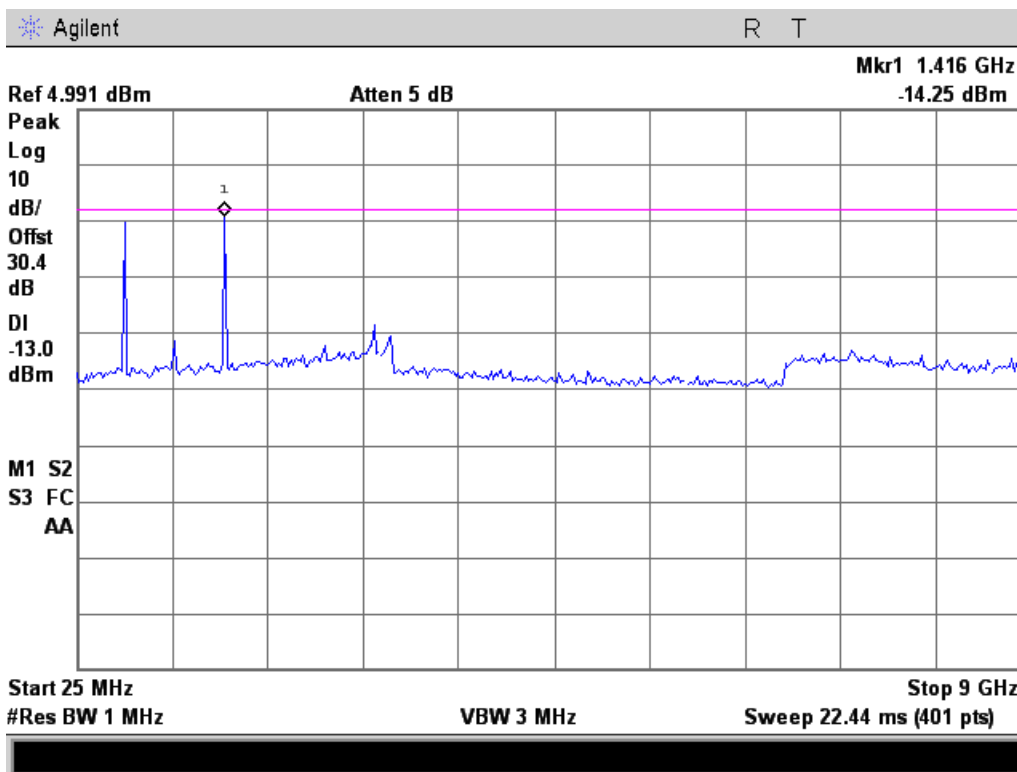

MTM 470.05 MHz

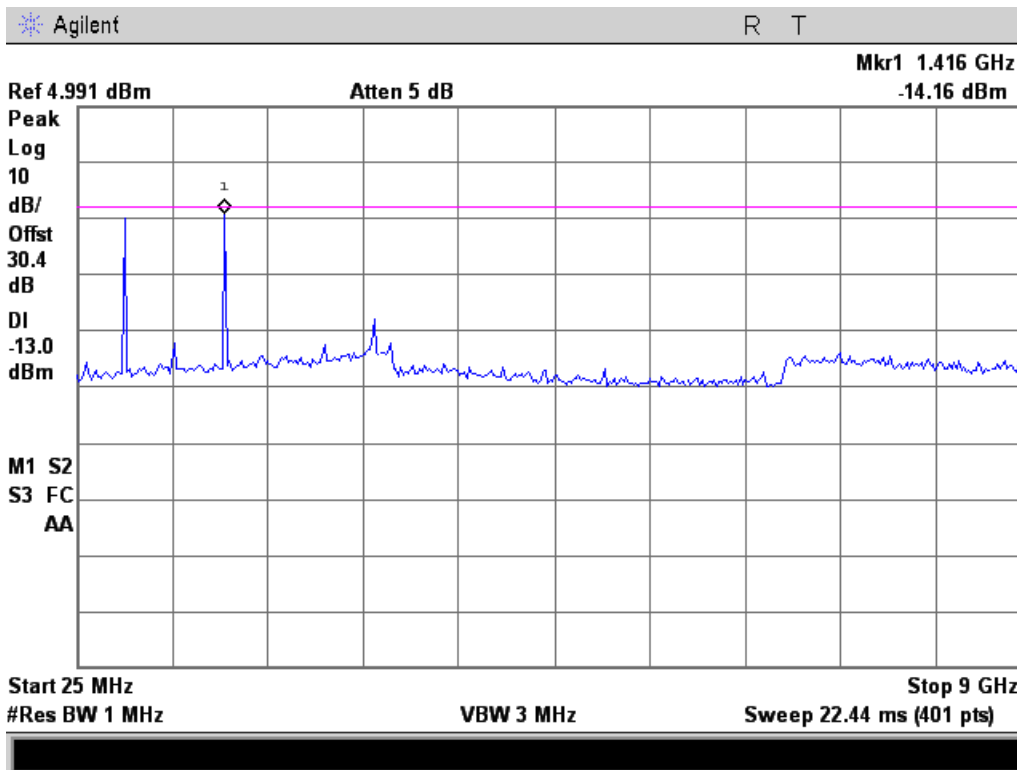



MTM 490.05 MHz

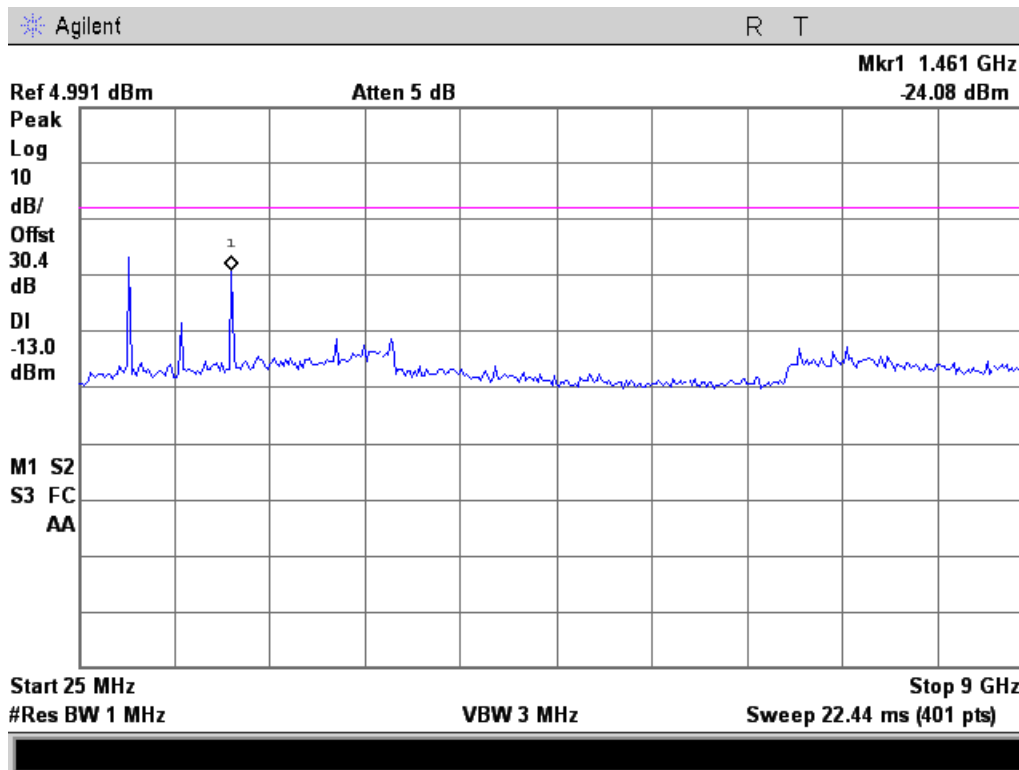

MTM 511.95 MHz

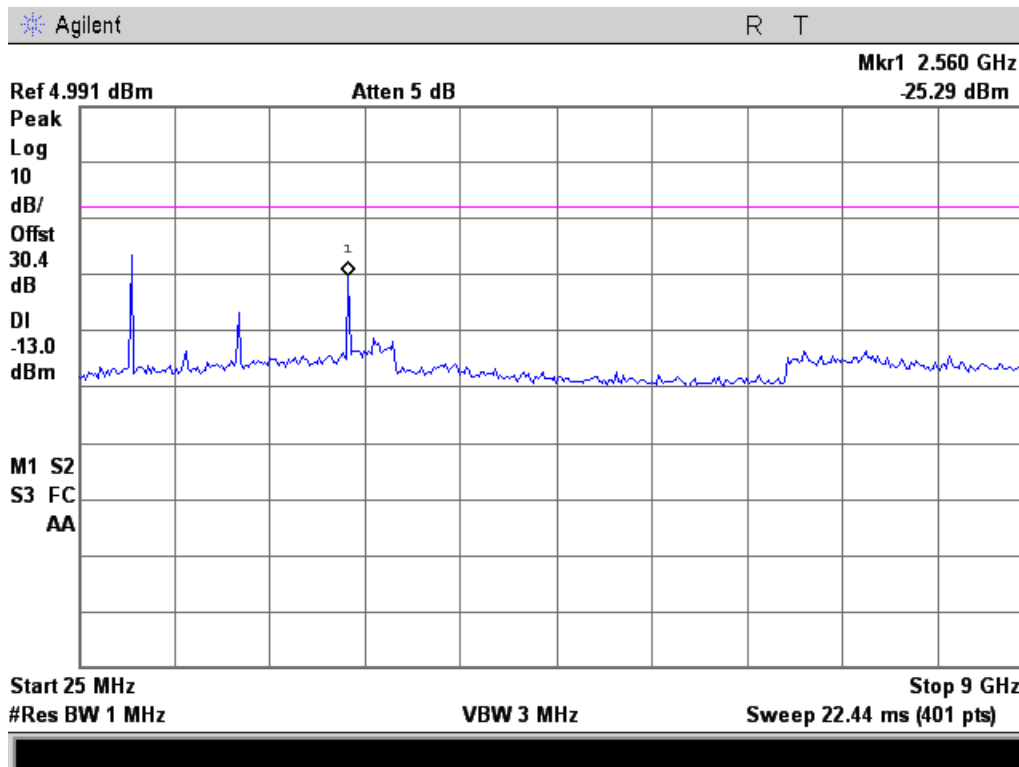



MTM 519.95 MHz

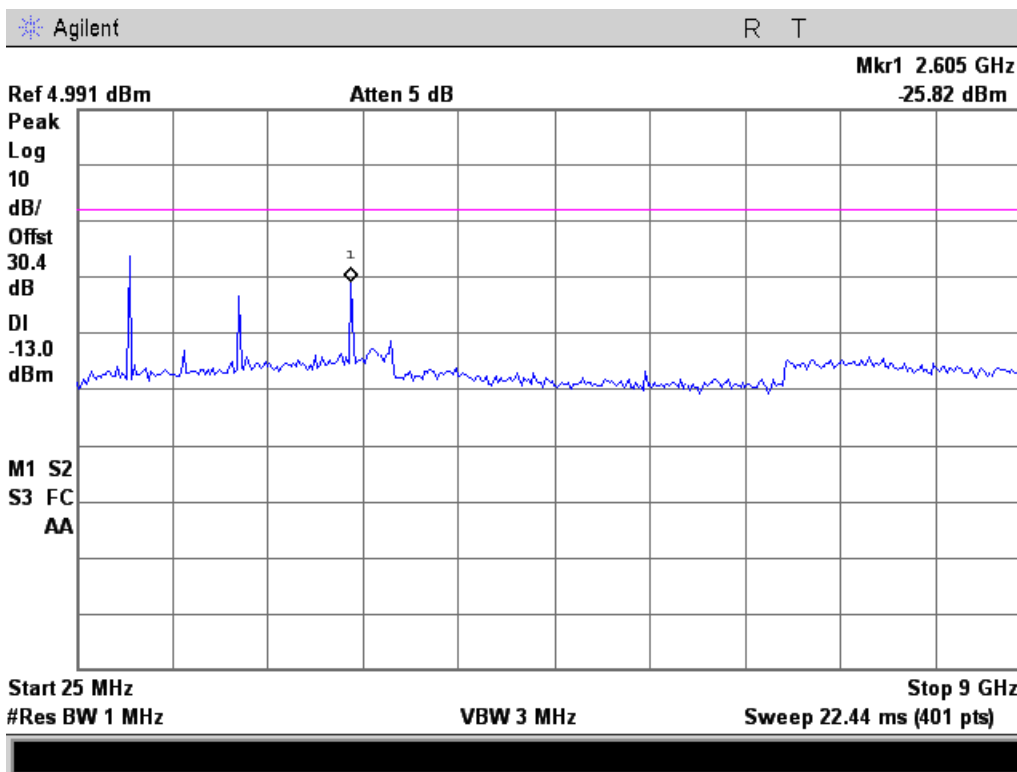

MTM 764.05 MHz

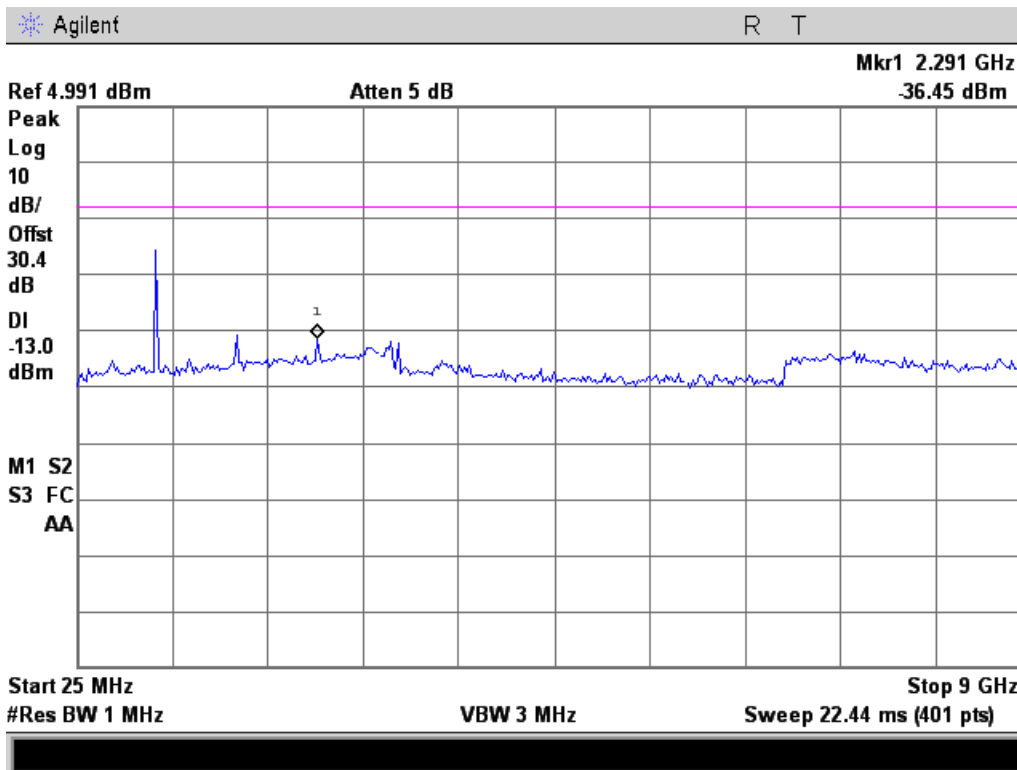



MTM 769.95 MHz

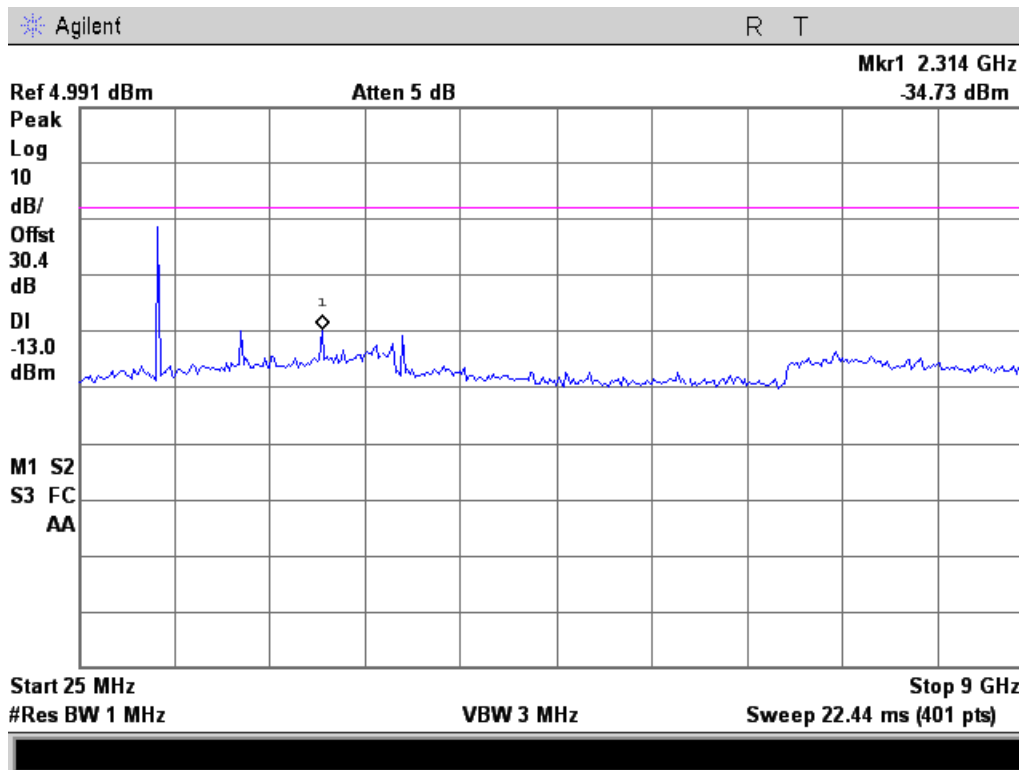

MTM 774.95 MHz

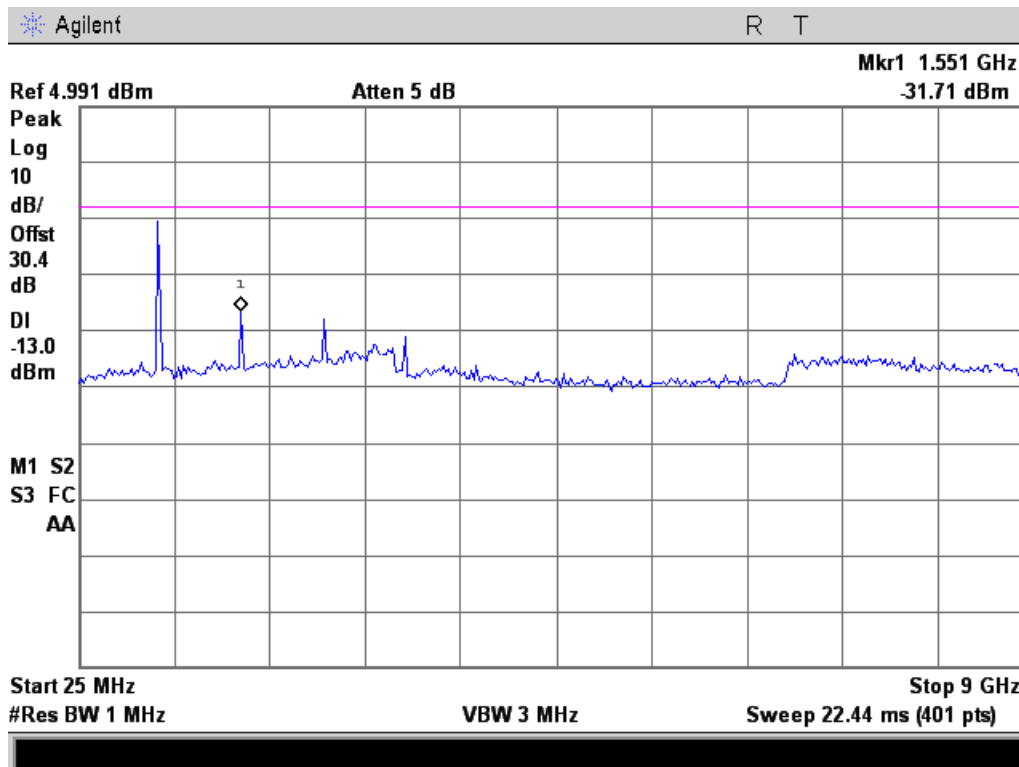



MTM 851.05 MHz

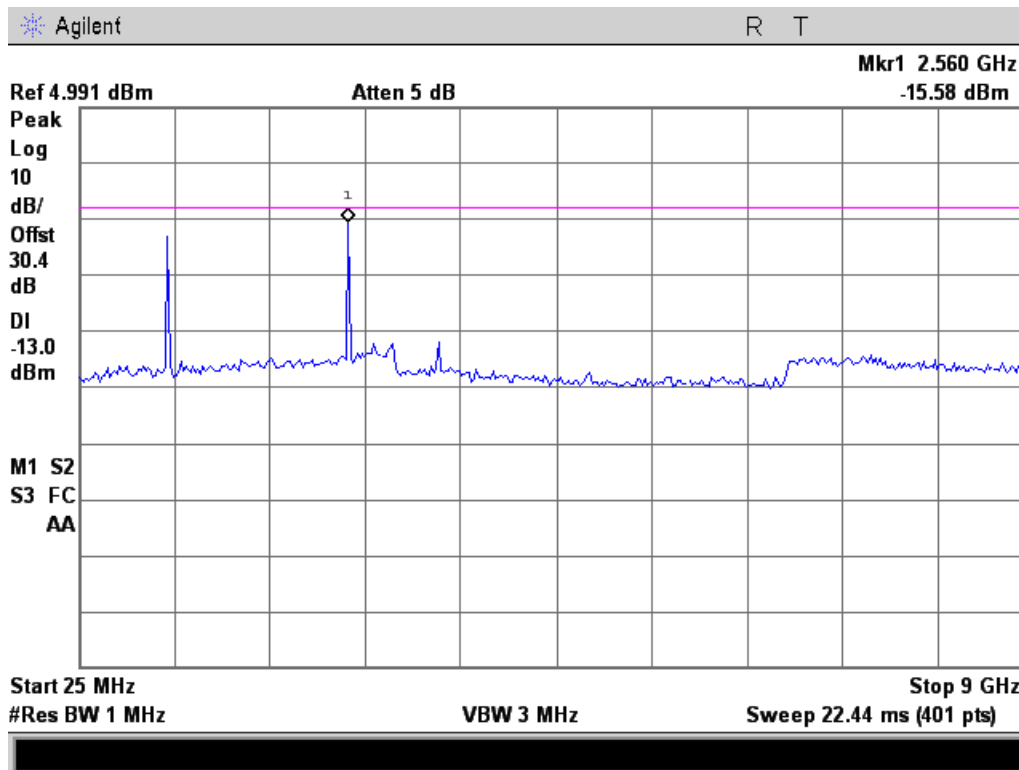

MTM 854.05 MHz

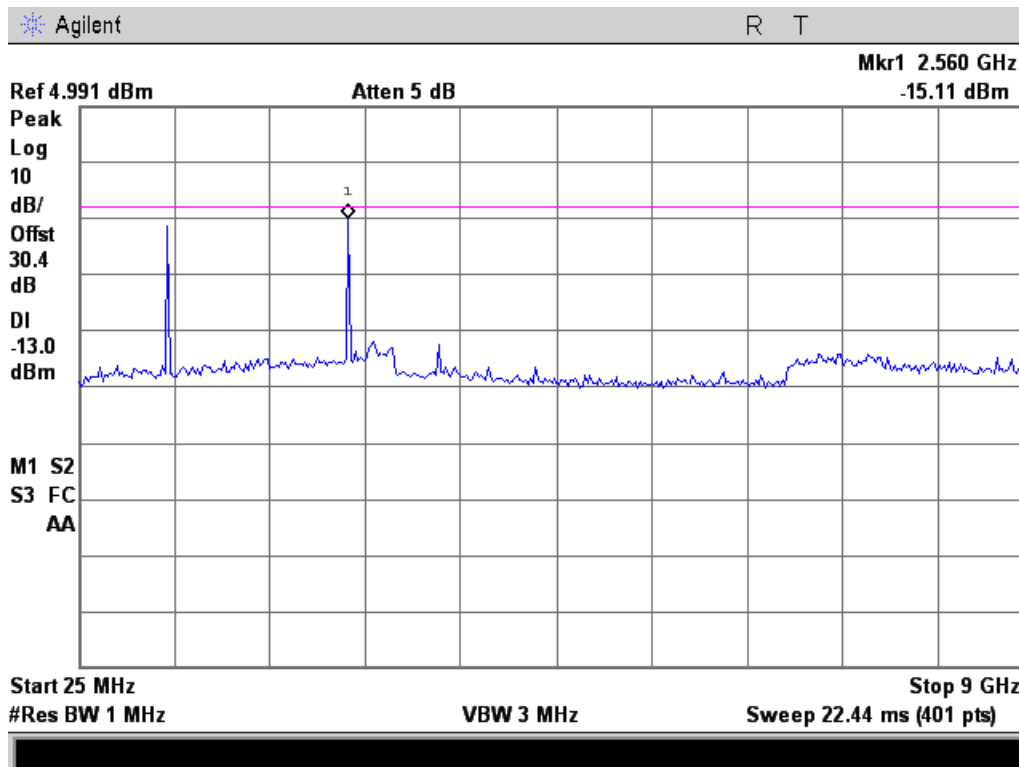



MTM 869.95 MHz

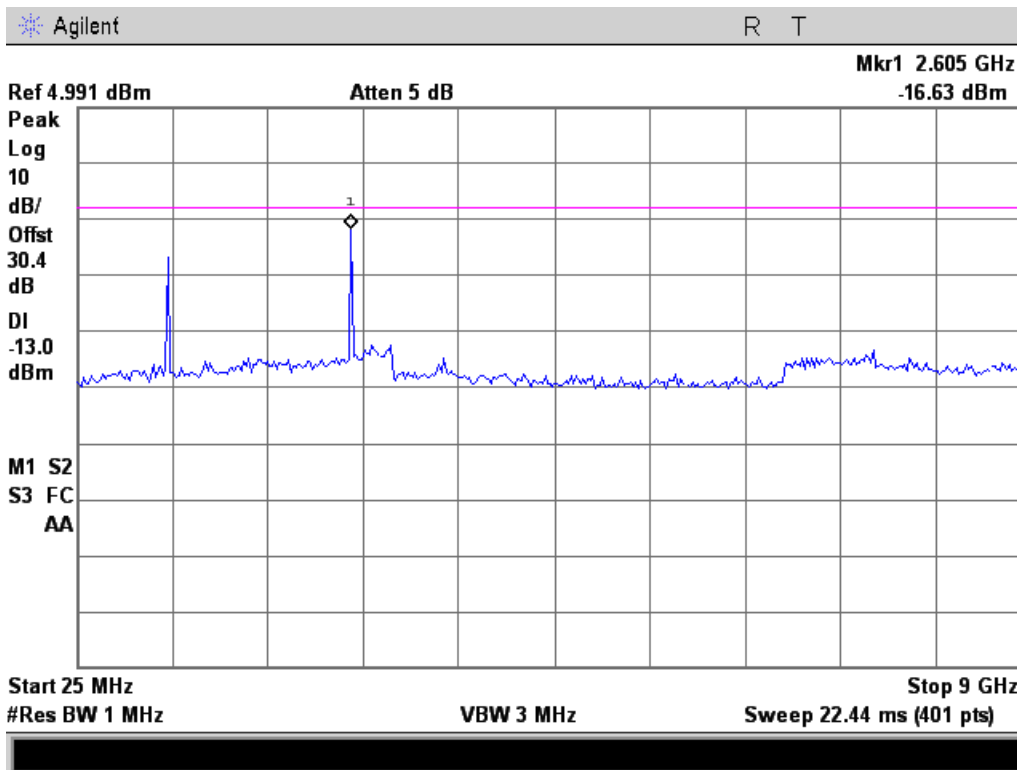



Field Strength of Spurious Radiation

Name of Test: Field Strength of Spurious Radiation

Engineer: John Erhard

Test Equipment Utilized: i00103, i00142, i00147, i00148, i00266, i00267, i00331

Test Date: 11/29/2012

Test Procedure

- A) Connect the equipment as illustrated below.
- B) Adjust the spectrum analyzer to the following settings:
 - 1) Resolution Bandwidth 100 kHz (< 1 GHz), 1 MHz (> 1GHz)
 - 2) Video Bandwidth ≥ 3 times Resolution Bandwidth, or 30 kHz
 - 3) Sweep Speed ≤ 2000 Hz/second
 - 4) Detector Mode = Mean or Average Power
- C) Place the transmitter to be tested on the turntable in the standard test site. The transmitter is transmitting into a non-radiating load that is placed on the turntable. The RF cable to this load should be of minimum length.
- D) For each spurious measurement the test antenna should be adjusted to the correct length for the frequency involved. This length may be determined from a calibration ruler supplied with the equipment. Measurements shall be made from the lowest radio frequency generated in the equipment to the tenth harmonic of the carrier, except for the region close to the carrier equal to \pm the test bandwidth (see Section 1.3.4.4).
- E) For each spurious frequency, raise and lower the test antenna from 1 m to 4 m to obtain a maximum reading on the spectrum analyzer with the test antenna at horizontal polarity. Repeat this procedure to obtain the highest possible reading. Record this maximum reading.
- F) Repeat Step E) for each spurious frequency with the test antenna polarized vertically.
- G) Reconnect the equipment as illustrated.
- H) Keep the spectrum analyzer adjusted as in Step B).
- I) Remove the transmitter and replace it with a substitution antenna (the antenna should be half wavelength for each frequency involved). The center of the substitution antenna should be approximately at the same location as the center of the transmitter. At lower frequencies, where the substitution antenna is very long, this will be impossible to achieve when the antenna is polarized vertically. In such case the lower end of the antenna should be 0.3 m above the ground.
- J) Feed the substitution antenna at the transmitter end with a signal generator connected to the antenna by means of a non-radiating cable. With the antennas at both ends horizontally polarized and with the signal generator tuned to a particular spurious frequency, raise and lower the test antenna to obtain a maximum reading at the spectrum analyzer. Adjust the level of the signal generator output until the previously recorded maximum reading for this set of conditions is obtained. This should be done carefully repeating the adjustment of the test antenna and generator output.
- K) Repeat Step J) with both antennas vertically polarized for each spurious frequency.
- L) Calculate power in dBm into a reference ideal half-wave dipole antenna by reducing the readings obtained in Steps J) and K) by the power loss in the cable between the generator and the antenna and further corrected for the gain of the substitution antenna used relative to an ideal half-wave dipole antenna.
- M) The levels recorded in Step L) are absolute levels of radiated spurious emissions in dBm.
The radiated spurious emissions in dB can be calculated by the following:

Radiated spurious emissions dB = $10\log_{10}$ (TX power in watts/0.001) – the levels in Step I)

NOTE: It is permissible that the other antennas provided can be referenced to a dipole.



Test Setup

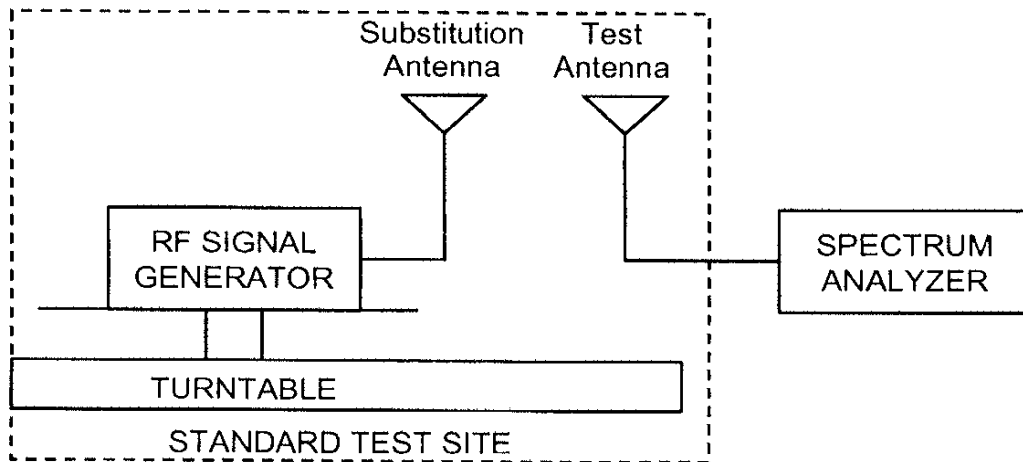
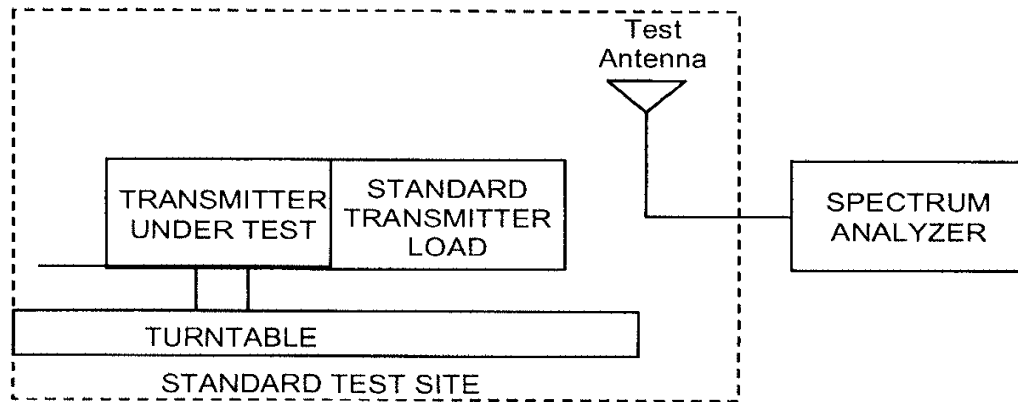



29.75 MHz Test Results

Emission Frequency (MHz)	Measured Level (dBm)	Limit (dBm)	Result
59.5	-62.43	-13	Pass
119.0	-63.58	-13	Pass
148.75	-65.04	-13	Pass

72.5 MHz Test Results

Emission Frequency (MHz)	Measured Level (dBm)	Limit (dBm)	Result
145.0	-64.33	-13	Pass
217.5	-74.21	-13	Pass
280.0	-76.14	-13	Pass

138.05 MHz Test Results

Emission Frequency (MHz)	Measured Level (dBm)	Limit (dBm)	Result
276.1	-67.11	-13	Pass
414.15	-68.58	-13	Pass
552.2	-70.25	-13	Pass

150.05 MHz Test Results

Emission Frequency (MHz)	Measured Level (dBm)	Limit (dBm)	Result
300.1	-74.65	-13	Pass
450.15	-70.0	-13	Pass
900.31	-67.19	-13	Pass

161.775 MHz Test Results

Emission Frequency (MHz)	Measured Level (dBm)	Limit (dBm)	Result
323.55	-76.97	-13	Pass
647.1	-67.58	-13	Pass
808.875	-67.68	-13	Pass



173.95 MHz Test Results

Emission Frequency (MHz)	Measured Level (dBm)	Limit (dBm)	Result
347.9	-65.48	-13	Pass
521.85	-62.19	-13	Pass
1043.7	-63.79	-13	Pass

380.00 MHz Test Results

Emission Frequency (MHz)	Measured Level (dBm)	Limit (dBm)	Result
760.0	-60.26	-13	Pass
1140.0	-57.51	-13	Pass
1520.0	-61.24	-13	Pass

406.15 MHz Test Results

Emission Frequency (MHz)	Measured Level (dBm)	Limit (dBm)	Result
812.3	-52.96	-13	Pass
1218.45	-62.85	-13	Pass
1324.6	-54.17	-13	Pass

413 MHz Test Results

Emission Frequency (MHz)	Measured Level (dBm)	Limit (dBm)	Result
826.0	-53.69	-13	Pass
1239.0	-65.72	-13	Pass
1652.0	-59.66	-13	Pass

420.975 MHz Test Results

Emission Frequency (MHz)	Measured Level (dBm)	Limit (dBm)	Result
841.95	-59.87	-13	Pass
1262.925	-65.32	-13	Pass
1683.9	-58.74	-13	Pass



438.05 MHz Test Results

Emission Frequency (MHz)	Measured Level (dBm)	Limit (dBm)	Result
879.25	-69.72	-13	Pass
1278.55	-65.8	-13	Pass
1700.73	-62.17	-13	Pass

469.95 MHz Test Results

Emission Frequency (MHz)	Measured Level (dBm)	Limit (dBm)	Result
939.9	-52.23	-13	Pass
1409.85	-66.2	-13	Pass
1879.8	-62.25	-13	Pass

470.05 MHz Test Results

Emission Frequency (MHz)	Measured Level (dBm)	Limit (dBm)	Result
940.1	-53.69	-13	Pass
1410.15	-64.14	-13	Pass
1880.2	-59.08	-13	Pass

490.05 MHz Test Results

Emission Frequency (MHz)	Measured Level (dBm)	Limit (dBm)	Result
980.1	-63.44	-13	Pass
1470.15	-63.09	-13	Pass
1960.2	-60.88	-13	Pass

511.95 MHz Test Results

Emission Frequency (MHz)	Measured Level (dBm)	Limit (dBm)	Result
1023.9	-64.74	-13	Pass
1535.85	-62.97	-13	Pass
2047.8	-61.71	-13	Pass



519.95 MHz Test Results

Emission Frequency (MHz)	Measured Level (dBm)	Limit (dBm)	Result
1039.9	-67.03	-13	Pass
1559.85	-61.9	-13	Pass
2079.8	-59.3	-13	Pass

764.05 MHz Test Results

Emission Frequency (MHz)	Measured Level (dBm)	Limit (dBm)	Result
1528.1	-56.96	-13	Pass
2292.15	-58.0	-13	Pass
3056.2	-43.66	-13	Pass

769.95 MHz Test Results

Emission Frequency (MHz)	Measured Level (dBm)	Limit (dBm)	Result
1539.9	-54.58	-13	Pass
2309.85	-58.89	-13	Pass
3079.8	-44.11	-13	Pass

774.95 MHz Test Results

Emission Frequency (MHz)	Measured Level (dBm)	Limit (dBm)	Result
1549.9	-56.4	-13	Pass
2324.85	-58.42	-13	Pass
3099.8	-41.75	-13	Pass

793.05 MHz Test Results

Emission Frequency (MHz)	Measured Level (dBm)	Limit (dBm)	Result
1586.1	-55.36	-13	Pass
2379.15	-60.02	-13	Pass
3172.2	-44.69	-13	Pass



799.95 MHz Test Results

Emission Frequency (MHz)	Measured Level (dBm)	Limit (dBm)	Result
1599.9	-57.03	-13	Pass
2399.85	-53.96	-13	Pass
3199.8	-44.08	-13	Pass

804.95 MHz Test Results

Emission Frequency (MHz)	Measured Level (dBm)	Limit (dBm)	Result
1609.9	-53.63	-13	Pass
2414.85	-56	-13	Pass
3219.8	-41.73	-13	Pass

806.05 MHz Test Results

Emission Frequency (MHz)	Measured Level (dBm)	Limit (dBm)	Result
1612.1	-56.03	-13	Pass
2418.15	-56.53	-13	Pass
3224.2	-44.12	-13	Pass

809.05 MHz Test Results

Emission Frequency (MHz)	Measured Level (dBm)	Limit (dBm)	Result
1618.1	-56.4	-13	Pass
2427.15	-55.28	-13	Pass
3236.2	-43.9	-13	Pass

827.05 MHz Test Results

Emission Frequency (MHz)	Measured Level (dBm)	Limit (dBm)	Result
1654.1	-50.48	-13	Pass
2481.15	-59.21	-13	Pass
3308.2	-42.62	-13	Pass



848.95 MHz Test Results

Emission Frequency (MHz)	Measured Level (dBm)	Limit (dBm)	Result
1697.9	-47.58	-13	Pass
2546.85	-55.58	-13	Pass
3395.8	-43.94	-13	Pass

850.95 MHz Test Results

Emission Frequency (MHz)	Measured Level (dBm)	Limit (dBm)	Result
1701.9	-48.38	-13	Pass
2552.85	-55.99	-13	Pass
3403.8	-43.57	-13	Pass

851.05 MHz Test Results

Emission Frequency (MHz)	Measured Level (dBm)	Limit (dBm)	Result
1702.1	-48.98	-13	Pass
2553.15	-55.86	-13	Pass
3404.2	-42.5	-13	Pass

854.05 MHz Test Results

Emission Frequency (MHz)	Measured Level (dBm)	Limit (dBm)	Result
1708.1	-50.1	-13	Pass
2562.15	-56.37	-13	Pass
3416.2	-42.82	-13	Pass

869.95 MHz Test Results

Emission Frequency (MHz)	Measured Level (dBm)	Limit (dBm)	Result
1739.9	-49.82	-13	Pass
2609.85	-56.64	-13	Pass
3479.8	-42.47	-13	Pass



872.05 MHz Test Results

Emission Frequency (MHz)	Measured Level (dBm)	Limit (dBm)	Result
1744.1	-50.13	-13	Pass
2616.15	-58.0	-13	Pass
3488.2	-41.88	-13	Pass

893.95 MHz Test Results

Emission Frequency (MHz)	Measured Level (dBm)	Limit (dBm)	Result
1787.9	-48.62	-13	Pass
2681.85	-57.4	-13	Pass
3575.8	-43.66	-13	Pass

895.95 MHz Test Results

Emission Frequency (MHz)	Measured Level (dBm)	Limit (dBm)	Result
1791.9	-48.6	-13	Pass
2687.85	-55.37	-13	Pass
3583.8	-42.14	-13	Pass

896.05 MHz Test Results

Emission Frequency (MHz)	Measured Level (dBm)	Limit (dBm)	Result
1792.1	-48.49	-13	Pass
2688.15	-54.06	-13	Pass
3584.2	-42.46	-13	Pass

900.95 MHz Test Results

Emission Frequency (MHz)	Measured Level (dBm)	Limit (dBm)	Result
1801.9	-47.12	-13	Pass
2702.85	-52.98	-13	Pass
3603.8	-41.41	-13	Pass



902.05 MHz Test Results

Emission Frequency (MHz)	Measured Level (dBm)	Limit (dBm)	Result
1804.1	-46.4	-13	Pass
2706.15	-54.81	-13	Pass
3608.2	-42.62	-13	Pass

916.05 MHz Test Results

Emission Frequency (MHz)	Measured Level (dBm)	Limit (dBm)	Result
1832.1	-49.7	-13	Pass
2748.15	-55.79	-13	Pass
3664.2	-39.45	-13	Pass

928.05 MHz Test Results

Emission Frequency (MHz)	Measured Level (dBm)	Limit (dBm)	Result
1856.1	-43.9	-13	Pass
2784.15	-52.71	-13	Pass
3712.2	-42.19	-13	Pass

928.95 MHz Test Results

Emission Frequency (MHz)	Measured Level (dBm)	Limit (dBm)	Result
1857.9	-43.72	-13	Pass
2786.85	-52.75	-13	Pass
3715.8	-42.66	-13	Pass

929.95 MHz Test Results

Emission Frequency (MHz)	Measured Level (dBm)	Limit (dBm)	Result
1859.9	-44.04	-13	Pass
2789.85	-52.49	-13	Pass
3719.8	-42.5	-13	Pass



931.05 MHz Test Results

Emission Frequency (MHz)	Measured Level (dBm)	Limit (dBm)	Result
1862.1	-47.62	-13	Pass
2793.15	-55.61	-13	Pass
3724.2	-42.81	-13	Pass

934.95 MHz Test Results

Emission Frequency (MHz)	Measured Level (dBm)	Limit (dBm)	Result
1869.9	-46.4	-13	Pass
2804.85	-52.59	-13	Pass
3739.8	-43.4	-13	Pass

935.05 MHz Test Results

Emission Frequency (MHz)	Measured Level (dBm)	Limit (dBm)	Result
1870.1	-47.6	-13	Pass
2805.15	-52.85	-13	Pass
3740.2	-39.23	-13	Pass

939.95 MHz Test Results

Emission Frequency (MHz)	Measured Level (dBm)	Limit (dBm)	Result
1879.9	-45.73	-13	Pass
2819.85	-51.5	-13	Pass
3759.8	-41.15	-13	Pass

941.05 MHz Test Results

Emission Frequency (MHz)	Measured Level (dBm)	Limit (dBm)	Result
1882.1	-41.84	-13	Pass
2823.15	-48.35	-13	Pass
3764.2	-42.54	-13	Pass



950.05 MHz Test Results

Emission Frequency (MHz)	Measured Level (dBm)	Limit (dBm)	Result
1900.1	-39.78	-13	Pass
2850.15	-48.06	-13	Pass
3800.2	-42.58	-13	Pass

959.95 MHz Test Results

Emission Frequency (MHz)	Measured Level (dBm)	Limit (dBm)	Result
1919.9	-43.36	-13	Pass
2879.85	-45.6	-13	Pass
3839.8	-41.68	-13	Pass

MTM 138.05 MHz Test Results

Emission Frequency (MHz)	Measured Level (dBm)	Limit (dBm)	Result
276.1	-75.99	-13	Pass
414.15	-69.43	-13	Pass
522.2	-71.71	-13	Pass

MTM 150.05 MHz Test Results

Emission Frequency (MHz)	Measured Level (dBm)	Limit (dBm)	Result
287.6	-76.44	-13	Pass
425.65	-75.79	-13	Pass
563.7	-72.06	-13	Pass

MTM 161.775 MHz Test Results

Emission Frequency (MHz)	Measured Level (dBm)	Limit (dBm)	Result
323.55	-73.26	-13	Pass
347.1	-69.9	-13	Pass
808.875	-67.9	-13	Pass



MTM 173.95 MHz Test Results

Emission Frequency (MHz)	Measured Level (dBm)	Limit (dBm)	Result
347.9	-74.64	-13	Pass
521.85	-64.56	-13	Pass
1043.7	-64.83	-13	Pass

MTM 380.00 MHz Test Results

Emission Frequency (MHz)	Measured Level (dBm)	Limit (dBm)	Result
760.0	-64.75	-13	Pass
1140.0	-65.4	-13	Pass
1520.0	-62.49	-13	Pass

MTM 406.15 MHz Test Results

Emission Frequency (MHz)	Measured Level (dBm)	Limit (dBm)	Result
812.3	-68.49	-13	Pass
1218.45	-67.48	-13	Pass
1624.6	-64.43	-13	Pass

MTM 438.05 MHz Test Results

Emission Frequency (MHz)	Measured Level (dBm)	Limit (dBm)	Result
1314.15	-65.69	-13	Pass
1752.2	-61.75	-13	Pass
2190.25	-59.98	-13	Pass

MTM 469.95 MHz Test Results

Emission Frequency (MHz)	Measured Level (dBm)	Limit (dBm)	Result
939.91	-55.22	-13	Pass
1409.85	-67.76	-13	Pass
1879.8	-62.05	-13	Pass



MTM 450.05 MHz Test Results

Emission Frequency (MHz)	Measured Level (dBm)	Limit (dBm)	Result
900.1	-68.84	-13	Pass
1350.15	-65.03	-13	Pass
1800.2	-62.15	-13	Pass

MTM 460.05 MHz Test Results

Emission Frequency (MHz)	Measured Level (dBm)	Limit (dBm)	Result
920.1	-67.64	-13	Pass
1380.15	-62.96	-13	Pass
1840.2	-62.3	-13	Pass

MTM 469.95 MHz Test Results

Emission Frequency (MHz)	Measured Level (dBm)	Limit (dBm)	Result
939.9	-56.86	-13	Pass
1409.85	-65.05	-13	Pass
1879.8	-62.25	-13	Pass

MTM 470.05 MHz Test Results

Emission Frequency (MHz)	Measured Level (dBm)	Limit (dBm)	Result
940.1	-54.97	-13	Pass
1410.15	-64.25	-13	Pass
1880.2	-64.13	-13	Pass

MTM 490.05 MHz Test Results

Emission Frequency (MHz)	Measured Level (dBm)	Limit (dBm)	Result
980.1	-66.76	-13	Pass
1470.15	-63.72	-13	Pass
1960.2	-62.0	-13	Pass



MTM 511.95 MHz Test Results

Emission Frequency (MHz)	Measured Level (dBm)	Limit (dBm)	Result
1023.9	-65.16	-13	Pass
1535.85	-64.16	-13	Pass
2045.8	-61.15	-13	Pass

MTM 519.95 MHz Test Results

Emission Frequency (MHz)	Measured Level (dBm)	Limit (dBm)	Result
1039.9	-65.15	-13	Pass
1559.85	-64.26	-13	Pass
2079.8	-62.49	-13	Pass

MTM 764.05 MHz Test Results

Emission Frequency (MHz)	Measured Level (dBm)	Limit (dBm)	Result
1528.1	-64.51	-13	Pass
2292.15	-59.44	-13	Pass
3056.2	-44.02	-13	Pass

MTM 769.95 MHz Test Results

Emission Frequency (MHz)	Measured Level (dBm)	Limit (dBm)	Result
1534.0	-62.85	-13	Pass
2298.05	-62.7	-13	Pass
3062.1	-44.112	-13	Pass

MTM 774.95 MHz Test Results

Emission Frequency (MHz)	Measured Level (dBm)	Limit (dBm)	Result
1549.9	-64.32	-13	Pass
2324.85	-60.88	-13	Pass
3099.8	-41.98	-13	Pass



MTM 851.05 MHz Test Results

Emission Frequency (MHz)	Measured Level (dBm)	Limit (dBm)	Result
1702.1	-62.44	-13	Pass
2553.15	-49.58	-13	Pass
3404.2	-43.73	-13	Pass

MTM 854.05 MHz Test Results

Emission Frequency (MHz)	Measured Level (dBm)	Limit (dBm)	Result
1708.1	-62.56	-13	Pass
2562.15	-50.59	-13	Pass
3416.2	-45.34	-13	Pass

MTM 869.95 MHz Test Results

Emission Frequency (MHz)	Measured Level (dBm)	Limit (dBm)	Result
1739.9	-64.07	-13	Pass
2609.85	-59.37	-13	Pass
3479.8	-43.25	-13	Pass

No other emissions were detected. All emissions were less than -13 dBm.



Emission Masks (Occupied Bandwidth)

Name of Test: Emission Masks (Occupied Bandwidth)

Engineer: John Erhard

Test Equipment Utilized: i00331, i00118

Test Date: 11/16/2012

Measurement Procedure

The EUT was connected to a spectrum analyzer through a 30 dB power attenuator to verify that the EUT meets the required emissions mask. A reference level plot is provided to verify that the peak power was established prior to testing the mask. A modulation frequency of 2.5 kHz at a level of 500 mVPP was input into the EUT for the analog tests and an internal test pattern was utilized for the digital input. Multiple frequencies per rule section and frequency band were tested ensuring compliance across all operational rule sections.

Test Setup

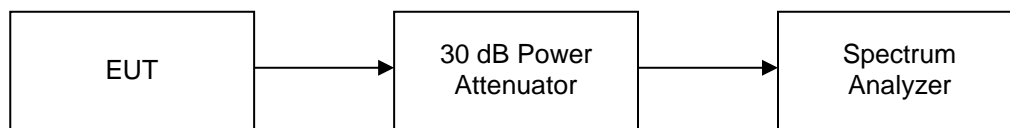



Occupied Bandwidth Plots

29.75 MHz
Reference

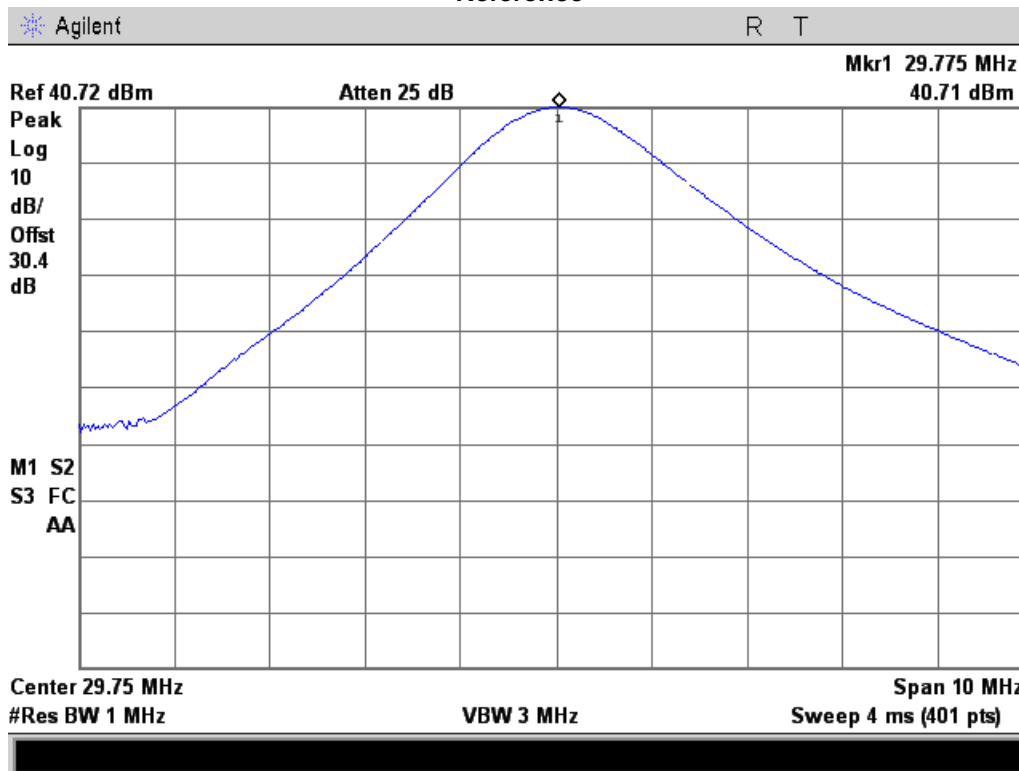

8K10F1D

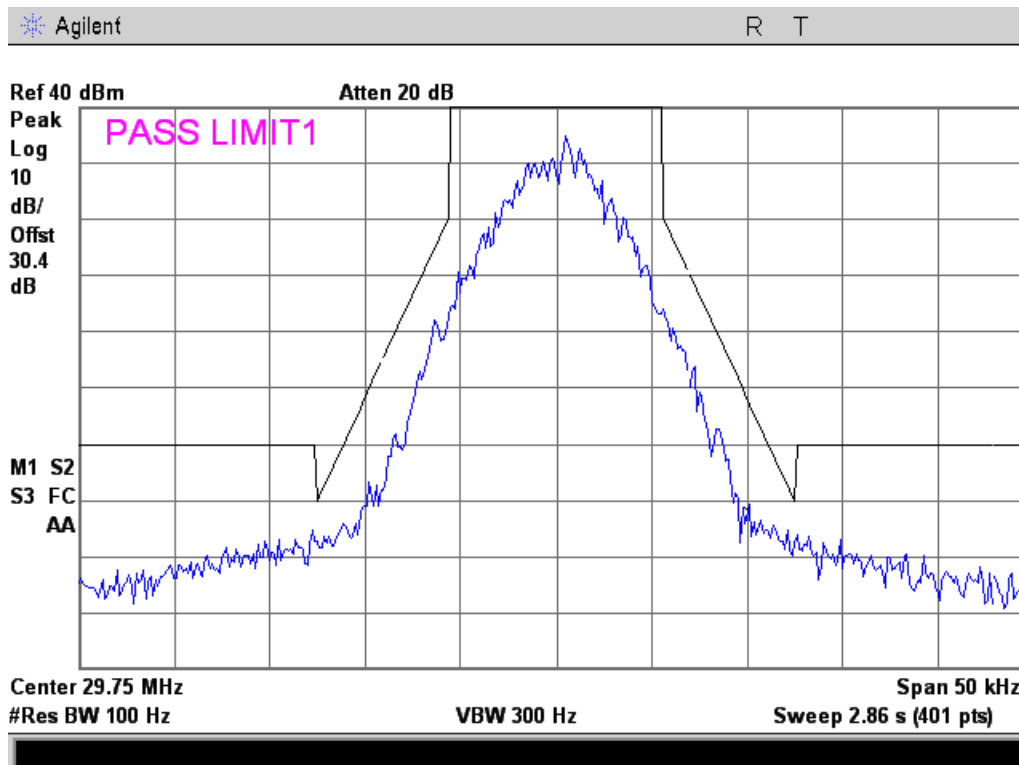



11K0F3E

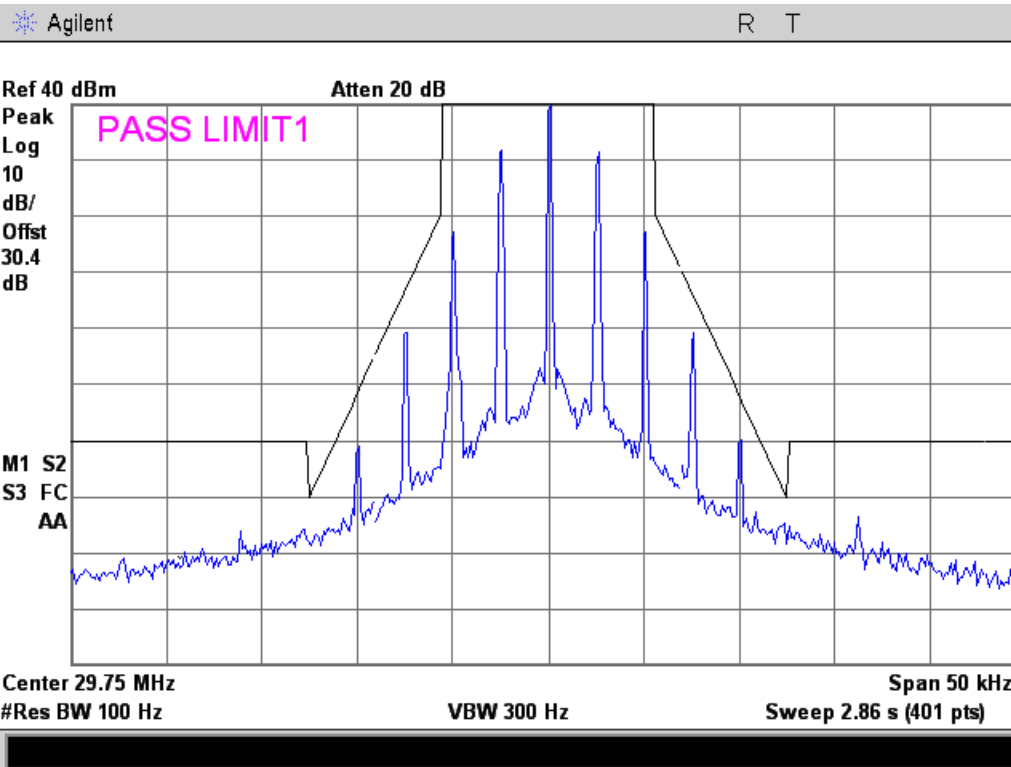

16K0F3E

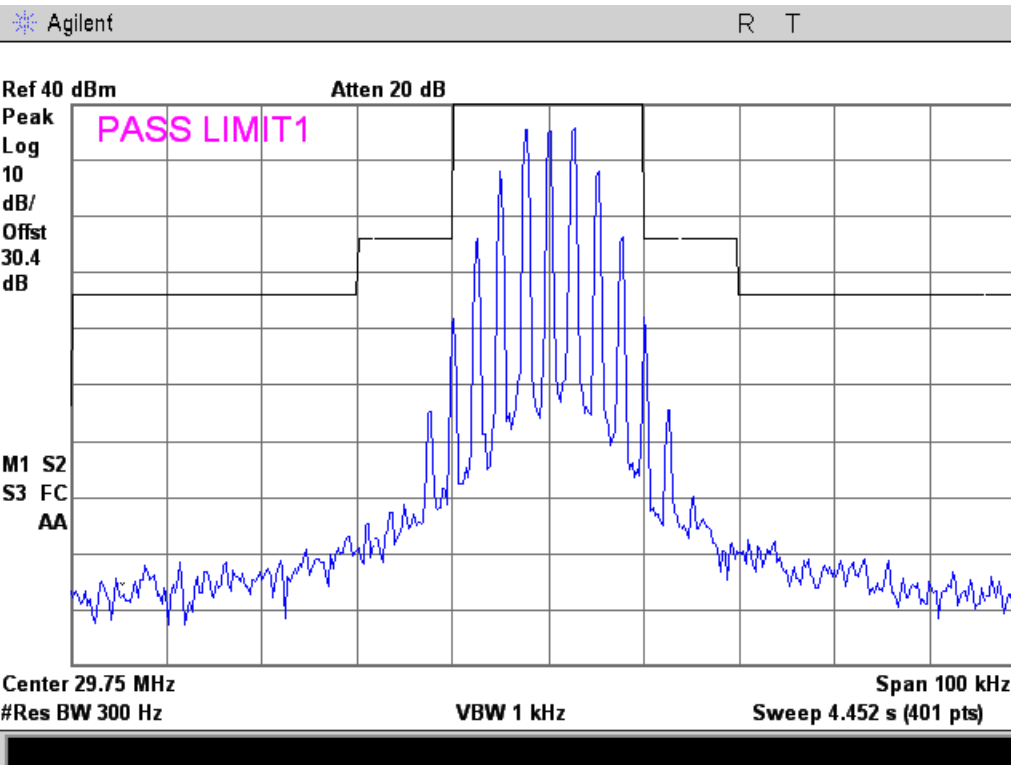



72.5 MHz Reference



8K10F1D

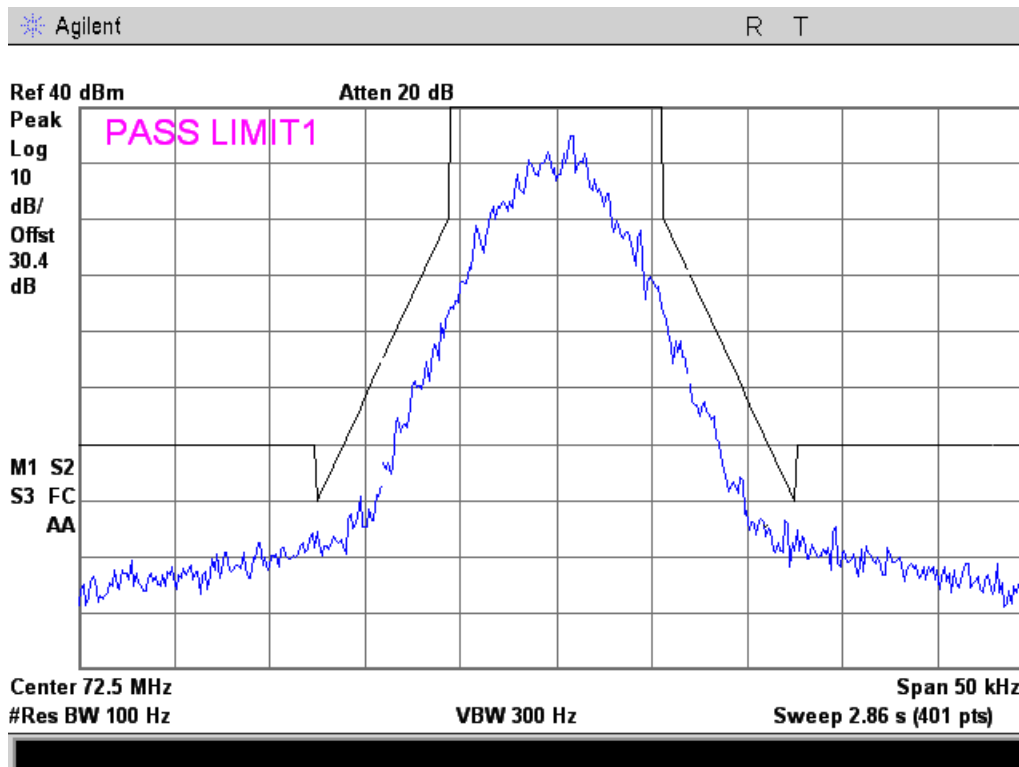



11K0F3E

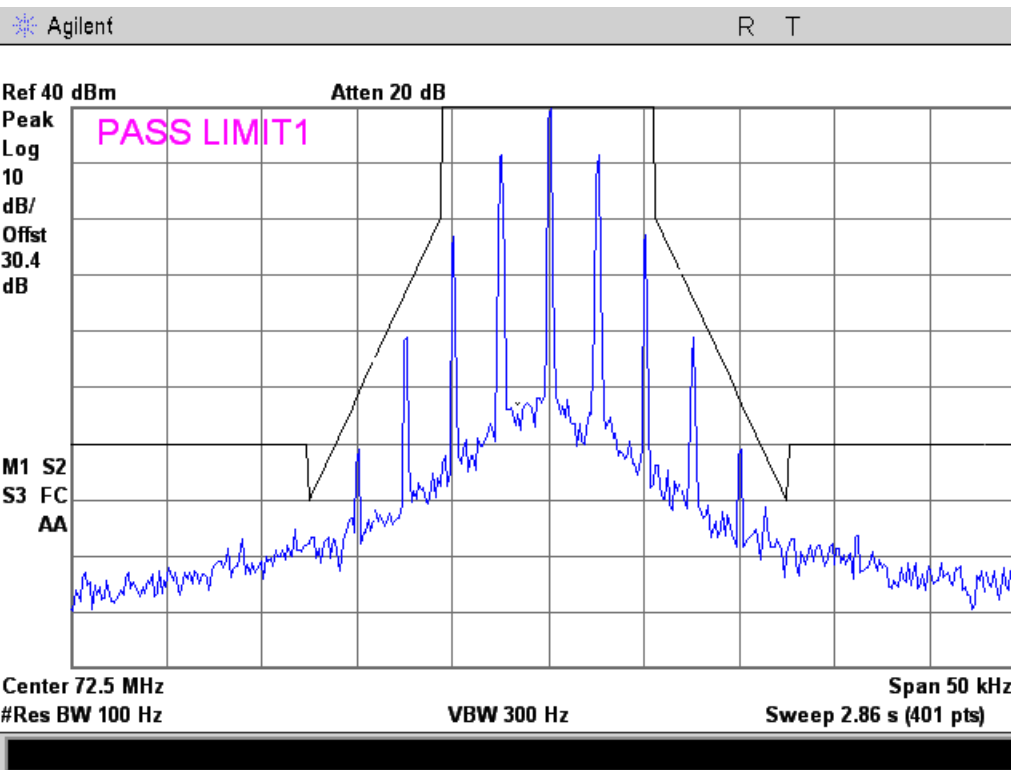

16K0F3E

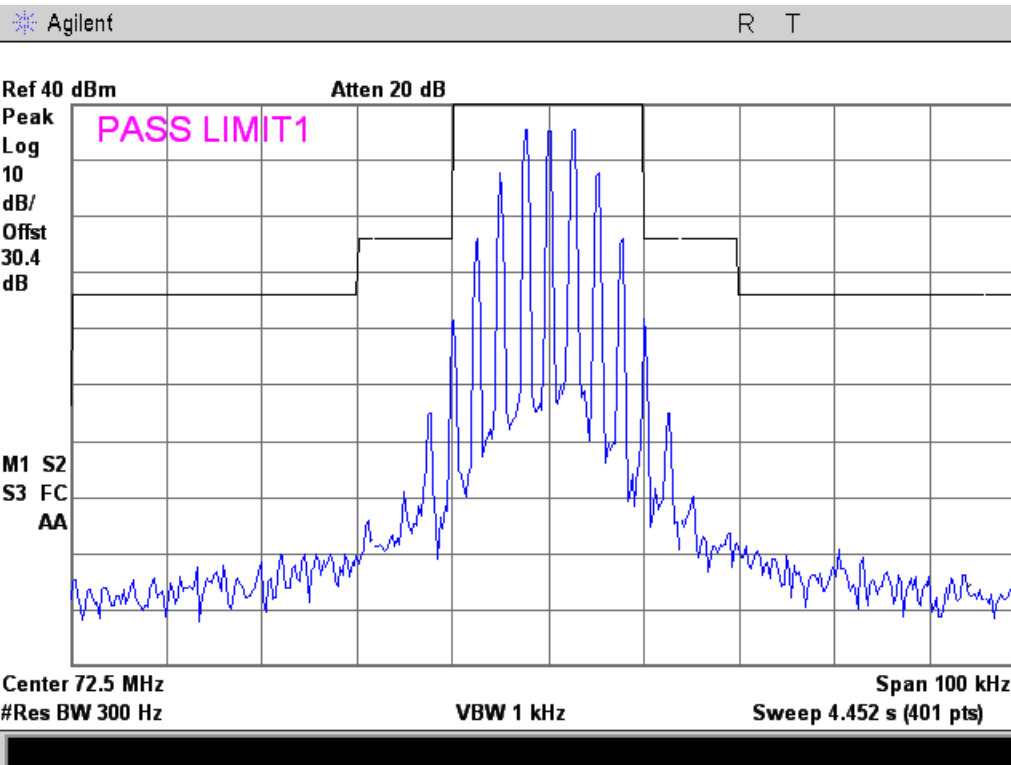



87.05 MHz Reference



8K10F1D

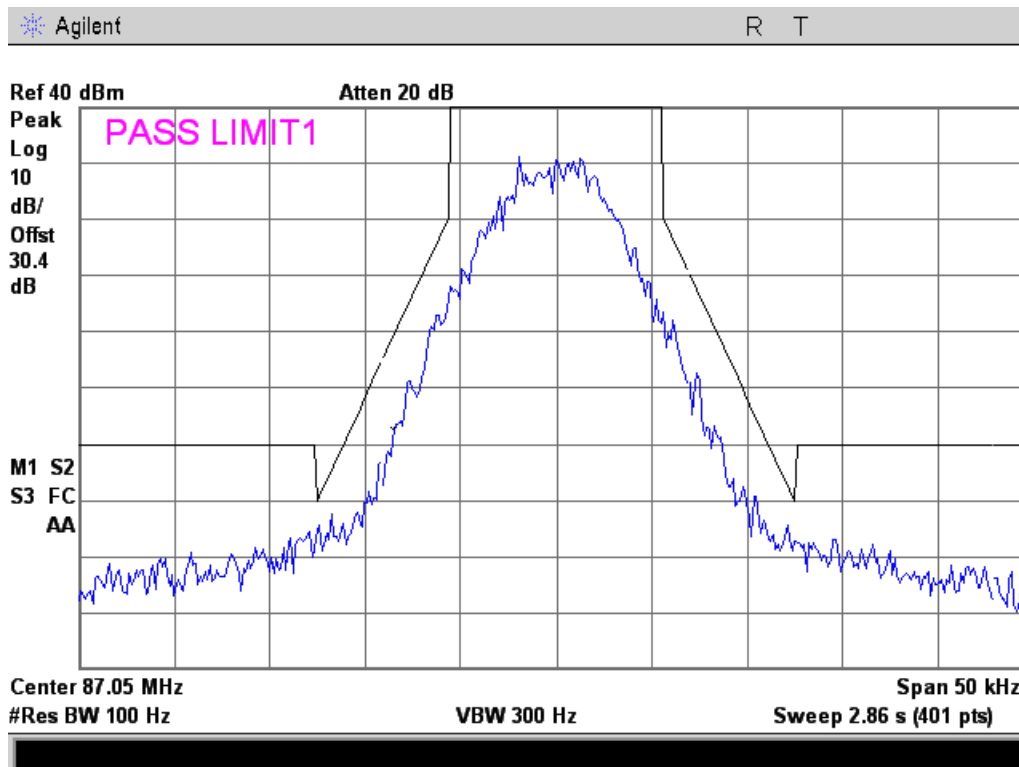



11K0F3E

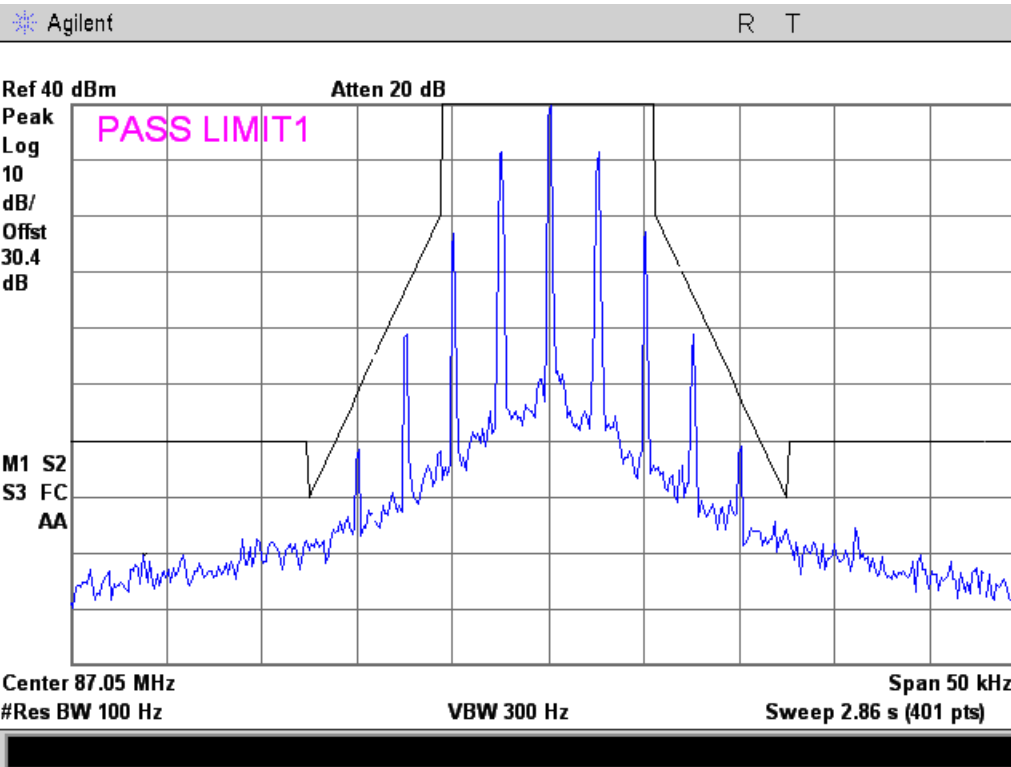

16K0F3E

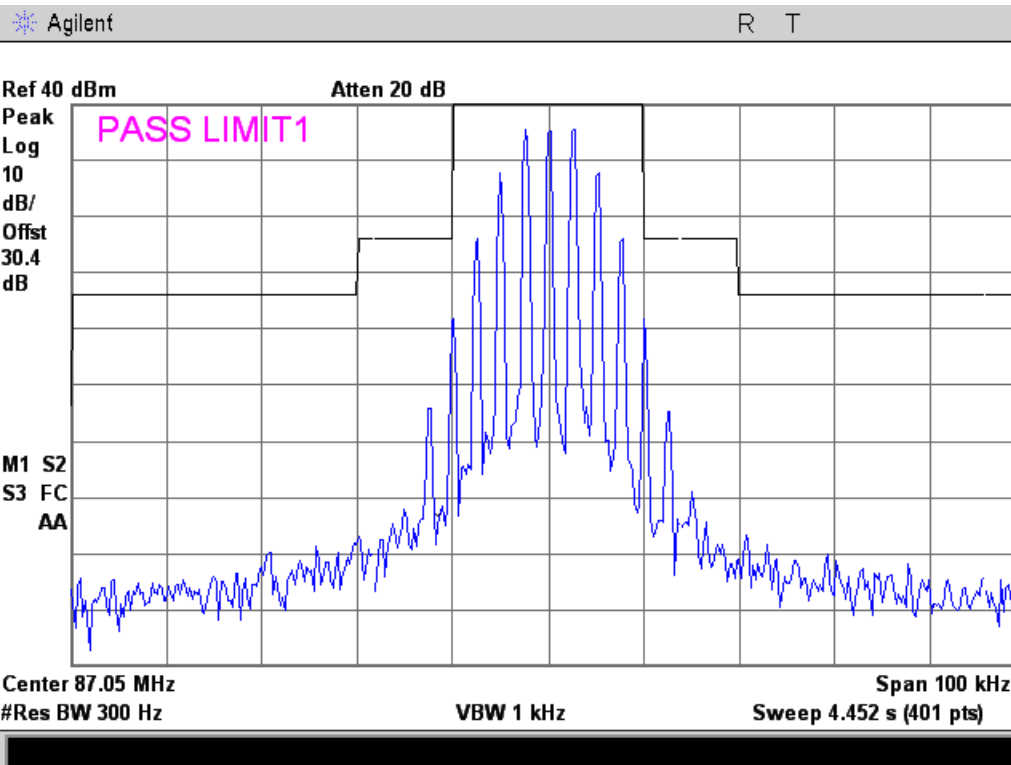



138.05 MHz Reference

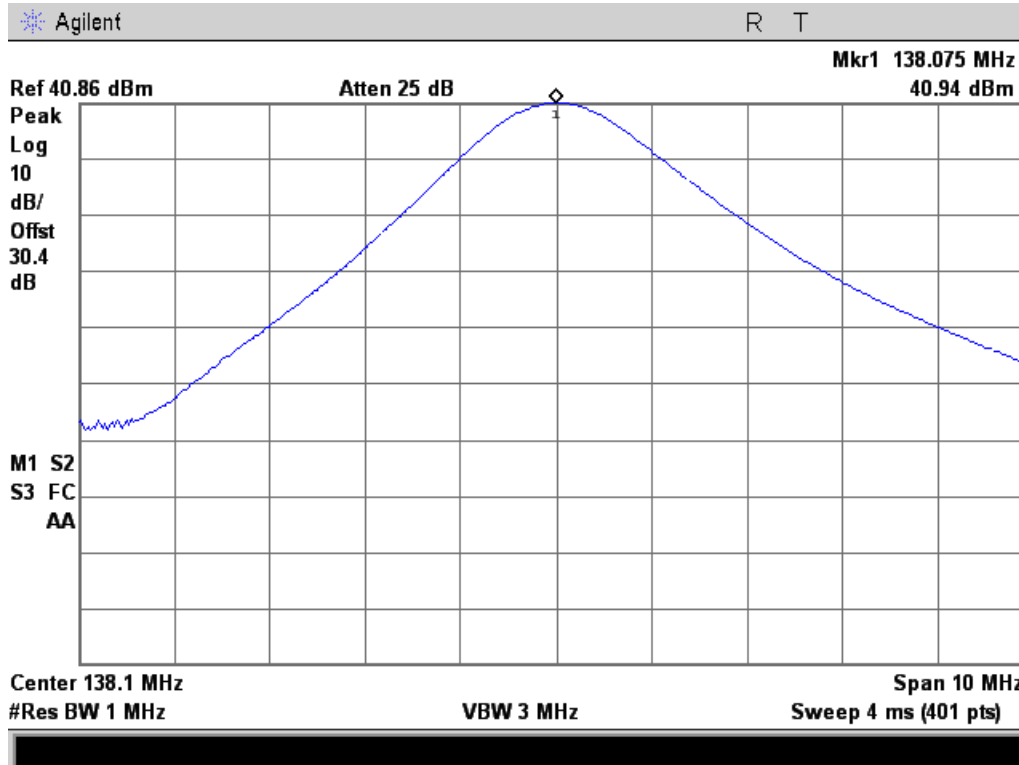

8K10F1D

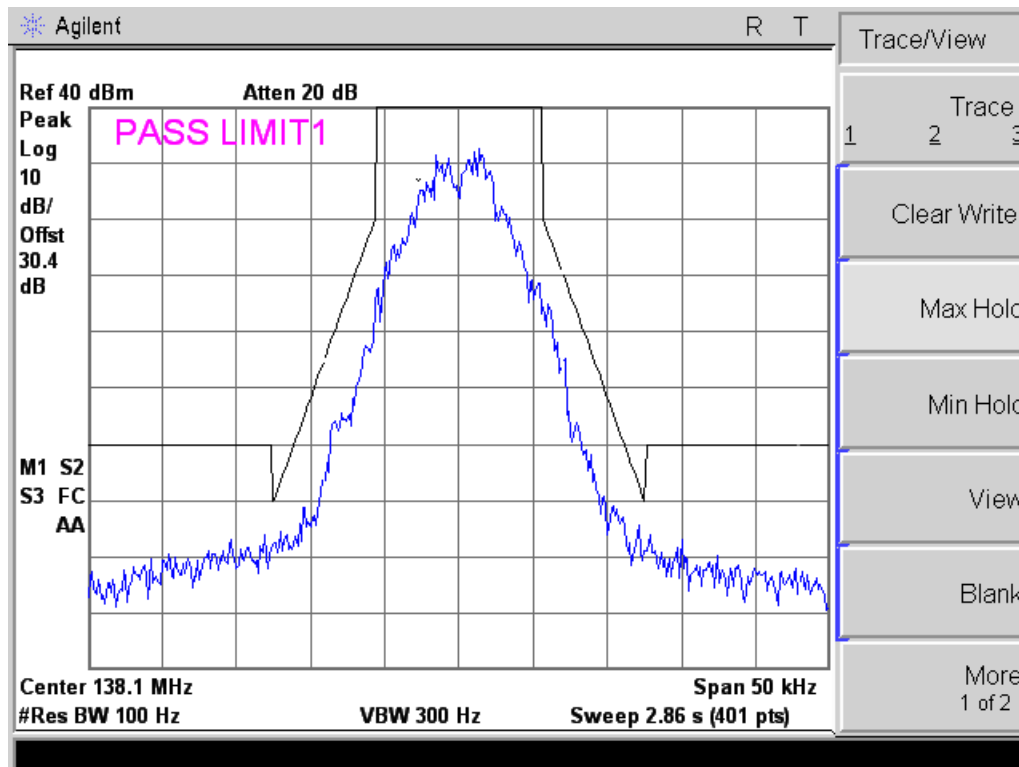



11K0F3E

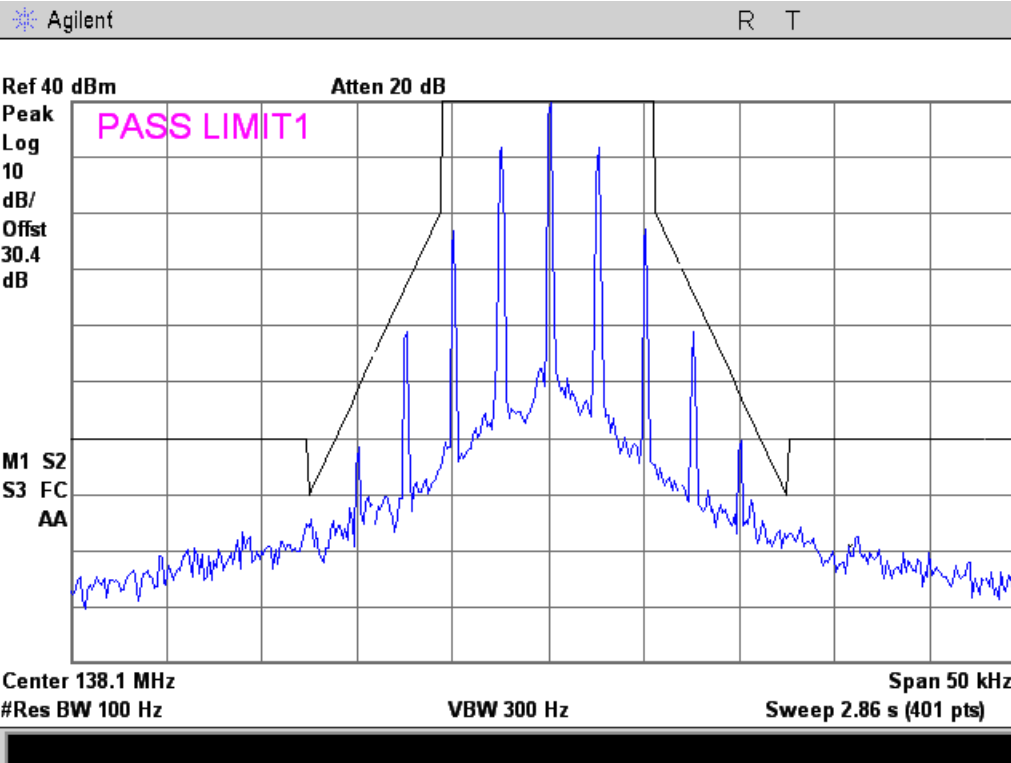

16K0F3E

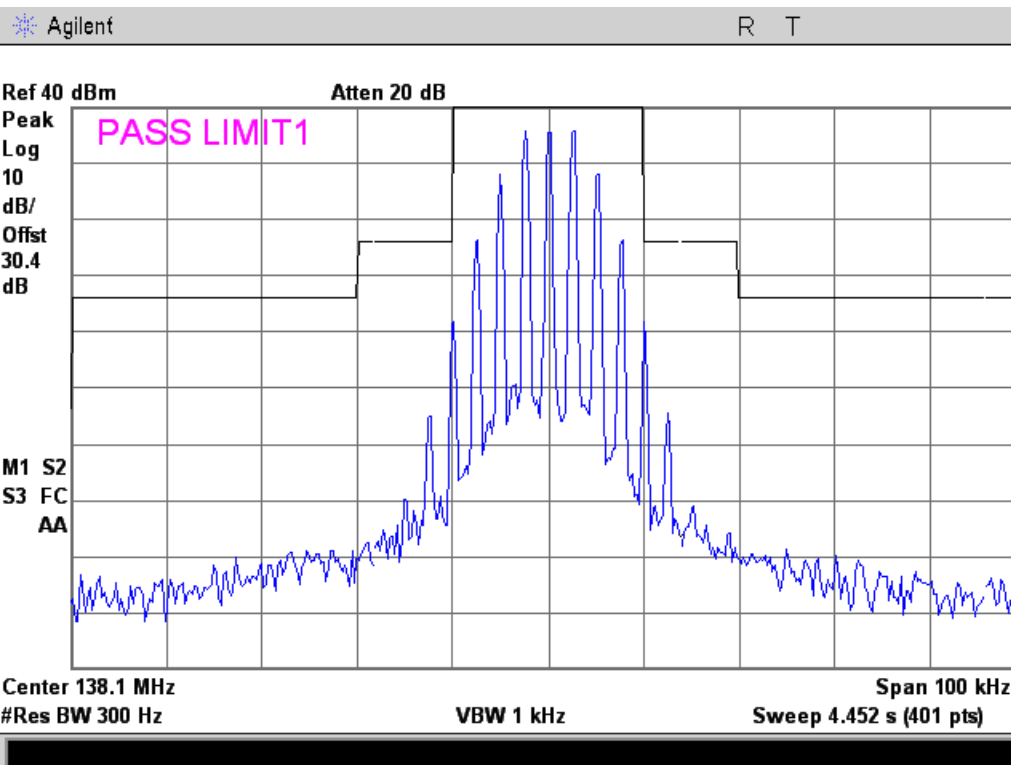



150.05 MHz

Reference

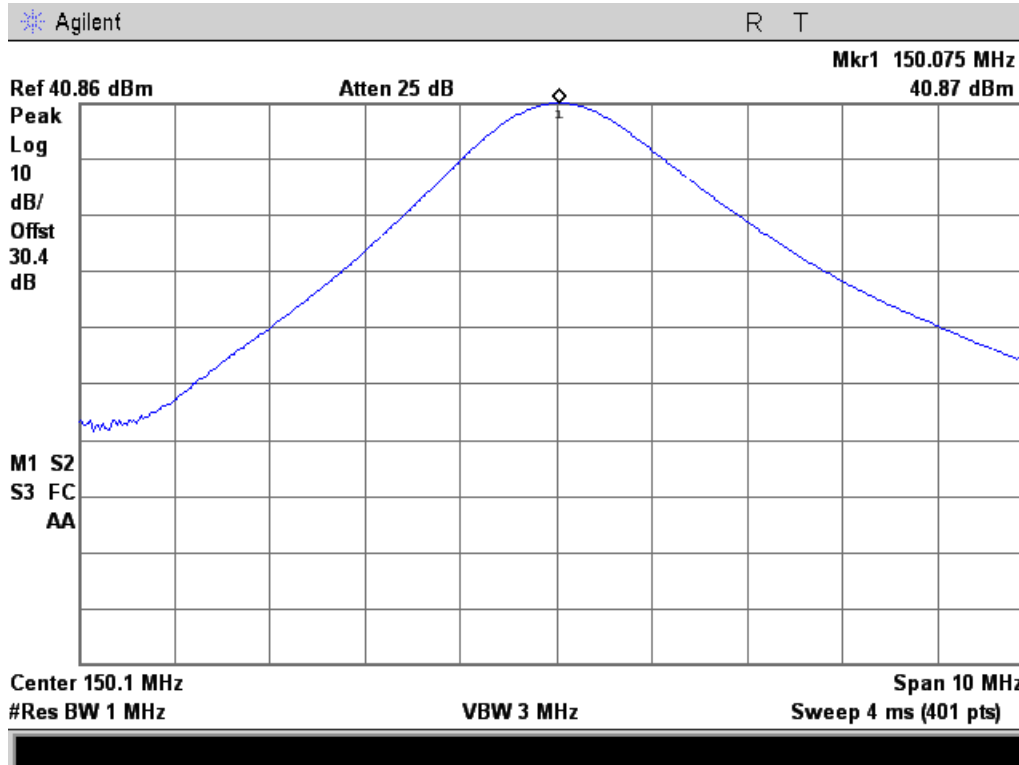

8K10F1D

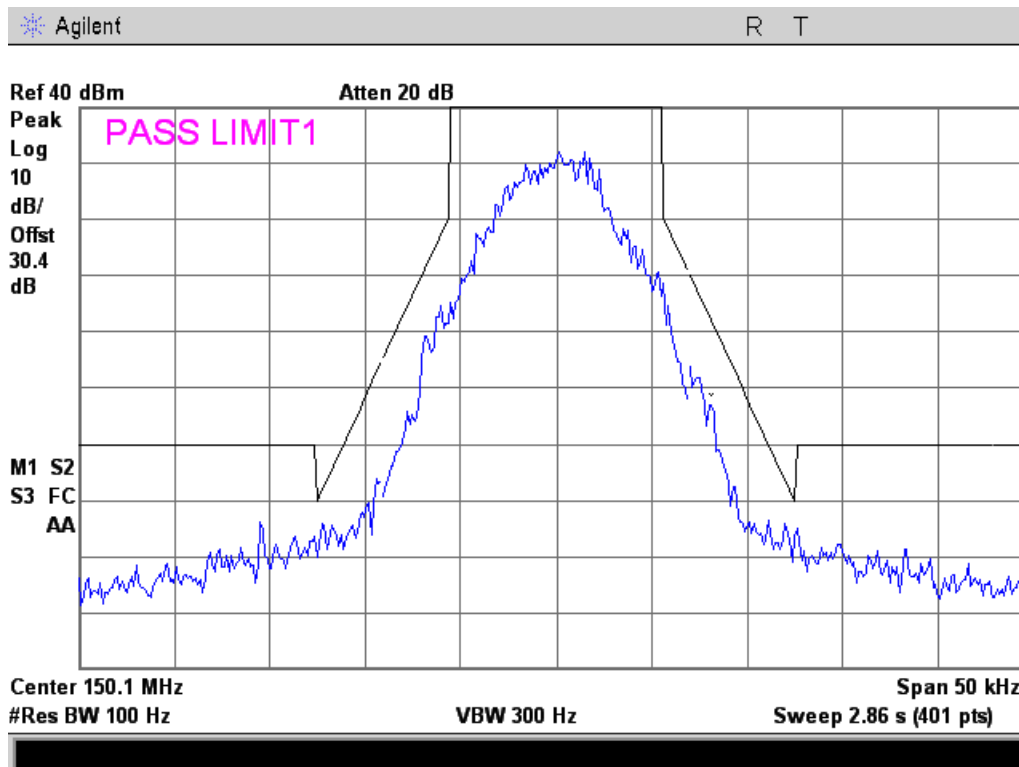



11K0F3E

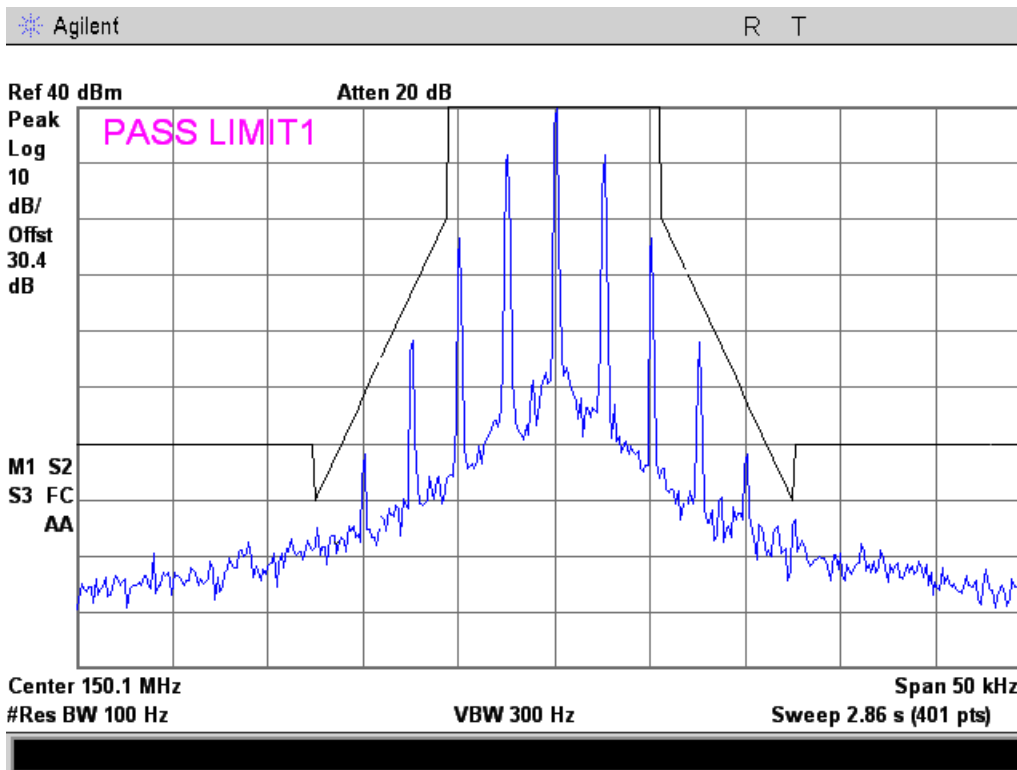

16K0F3E (RSS-119 Only)

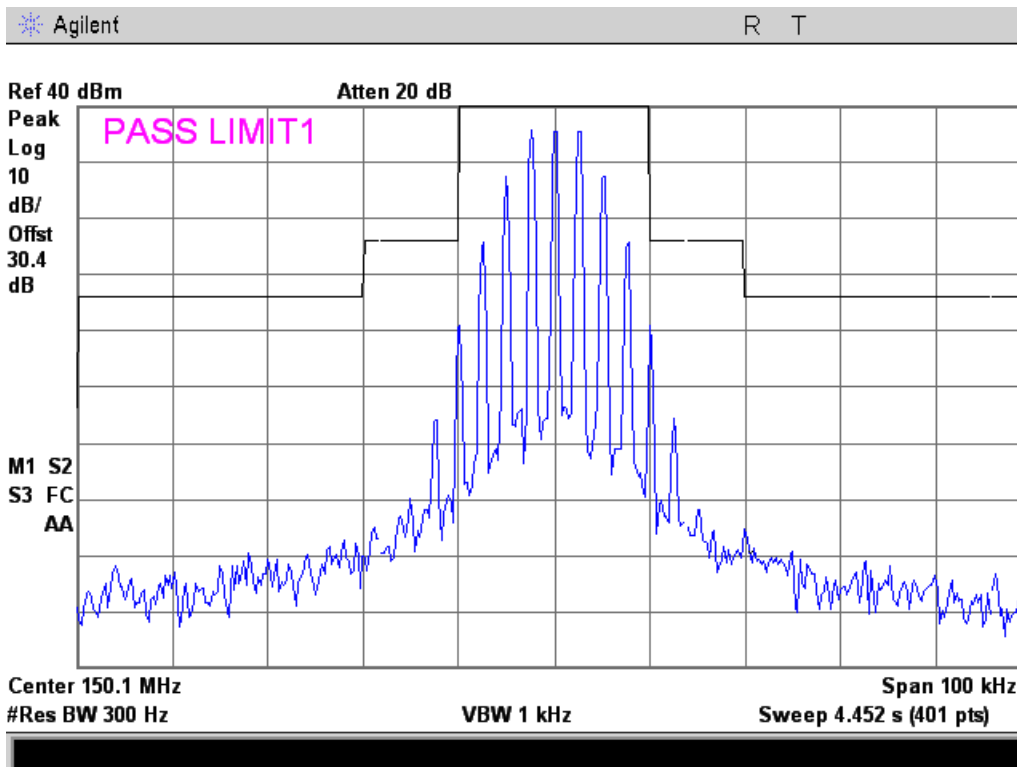



161.775 MHz Reference

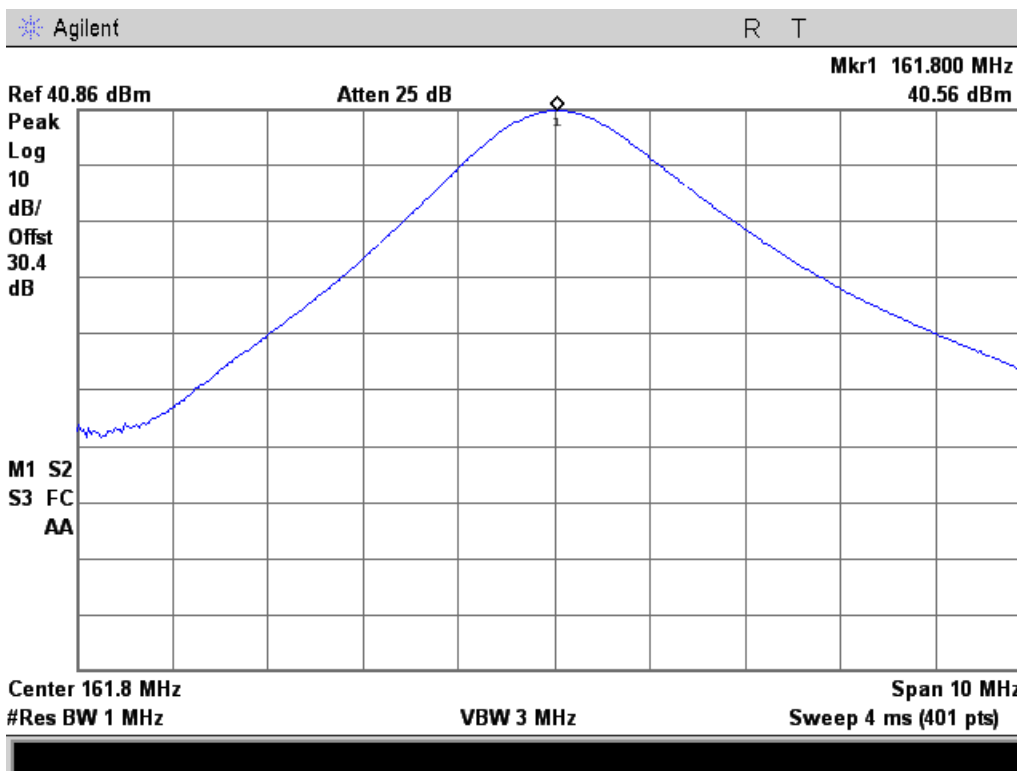

8K10F1D

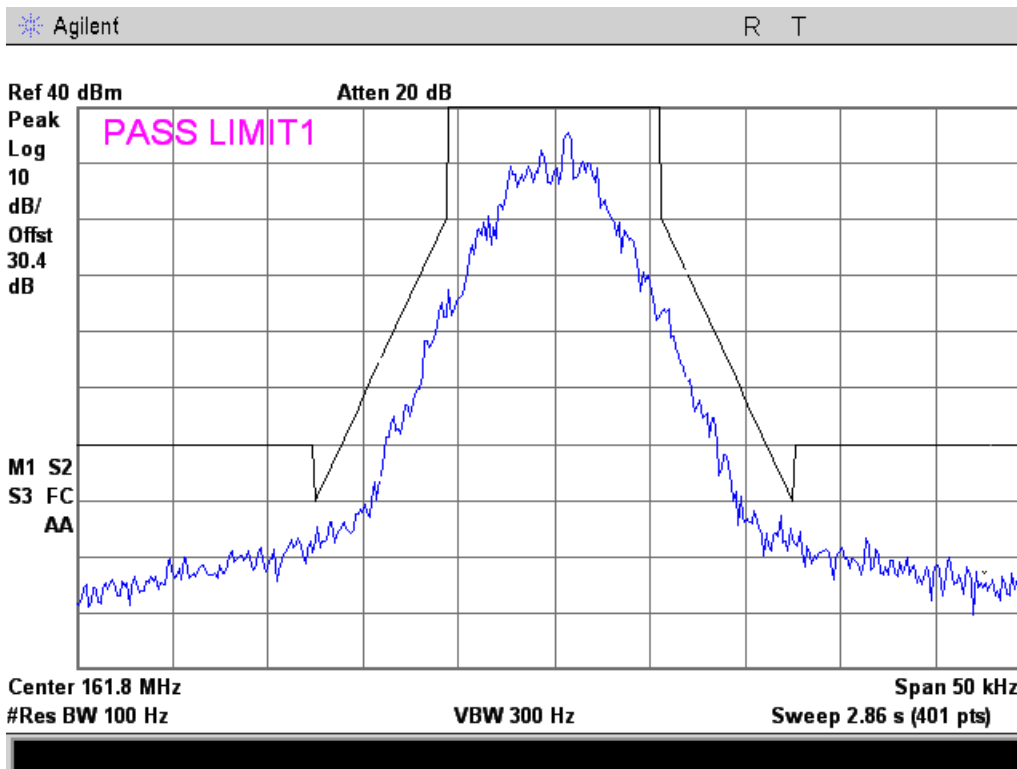



11K0F3E

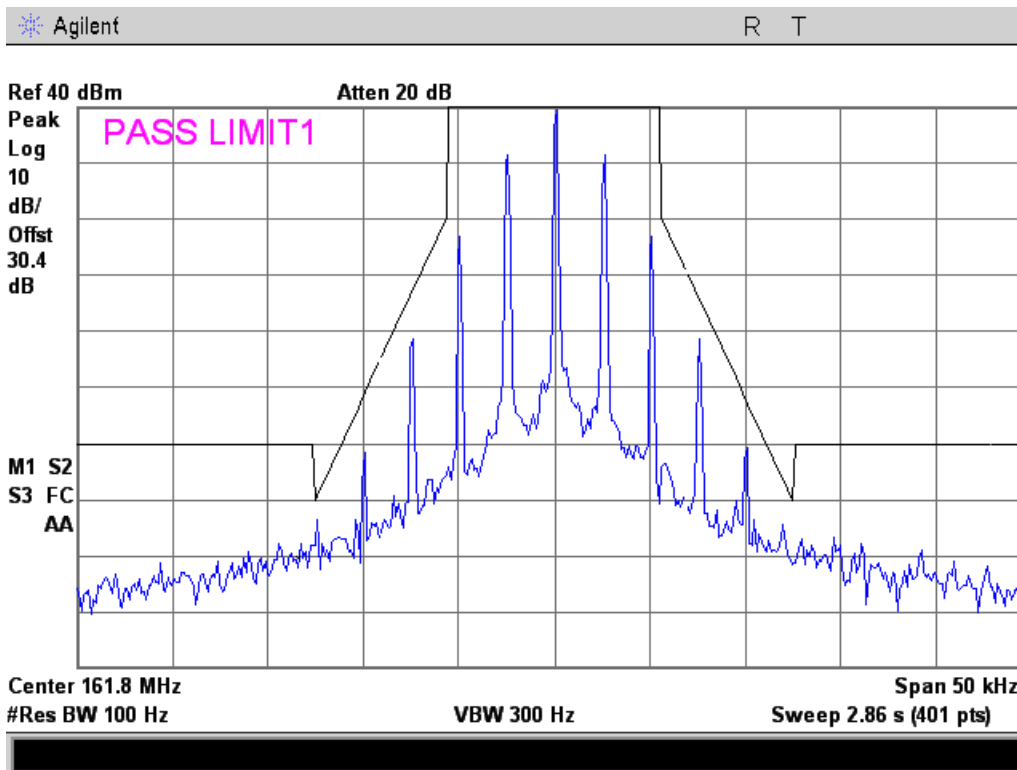

16K0F3E (RSS-119 Only)

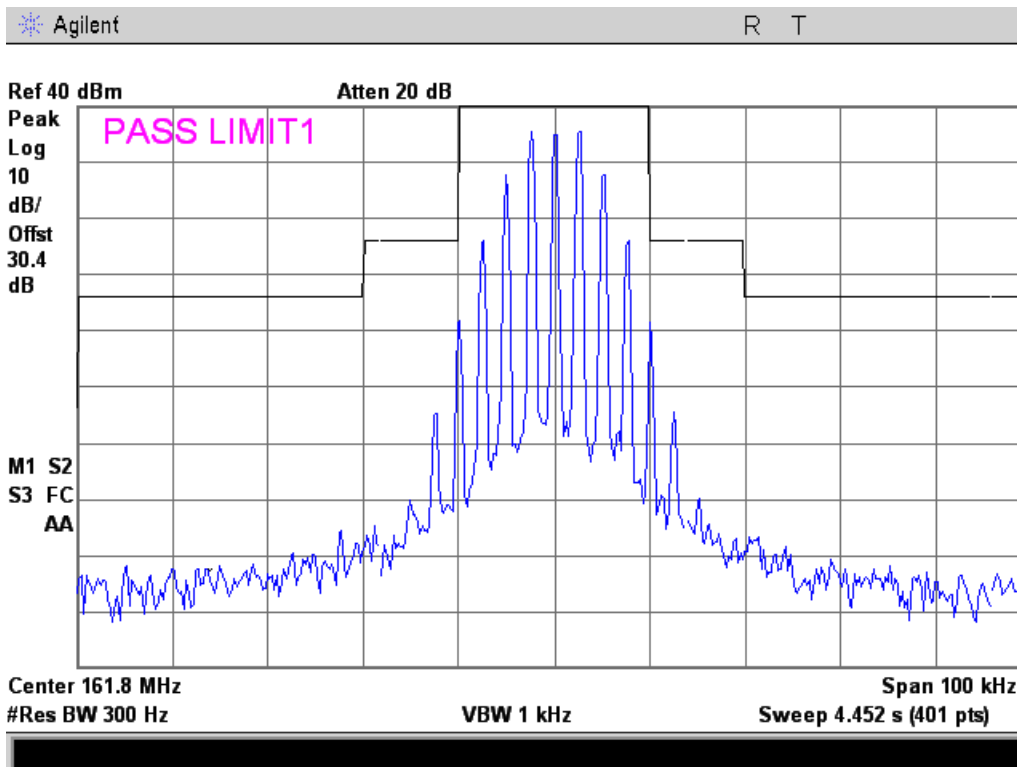



173.95 MHz Reference

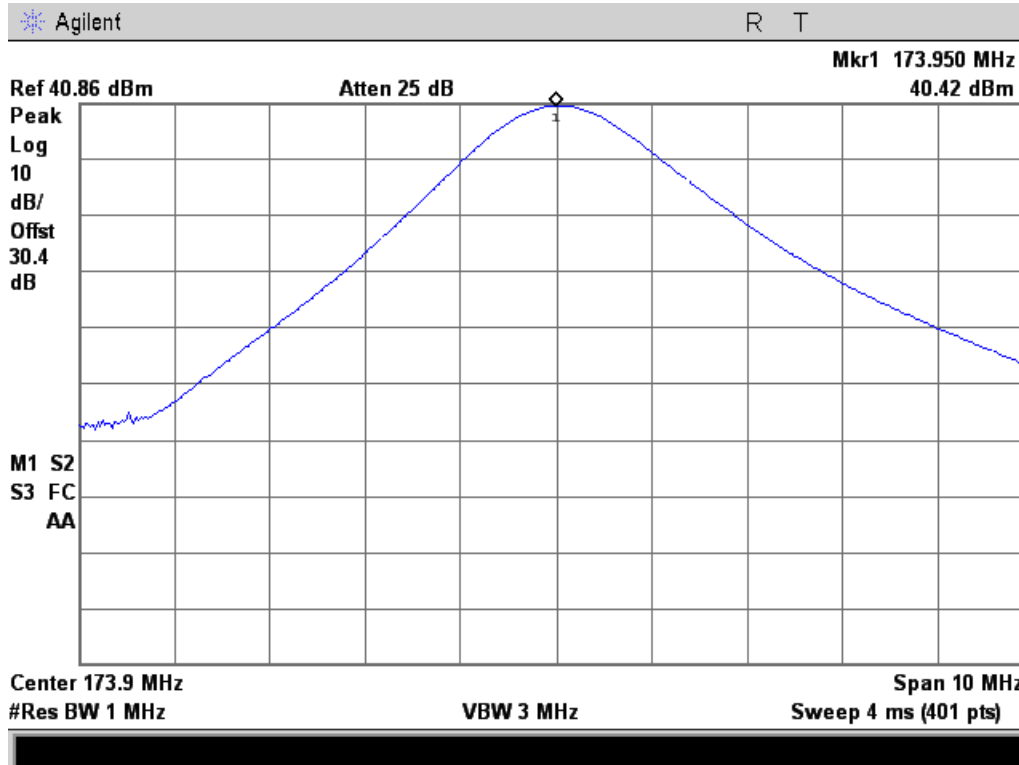

8K10F1D

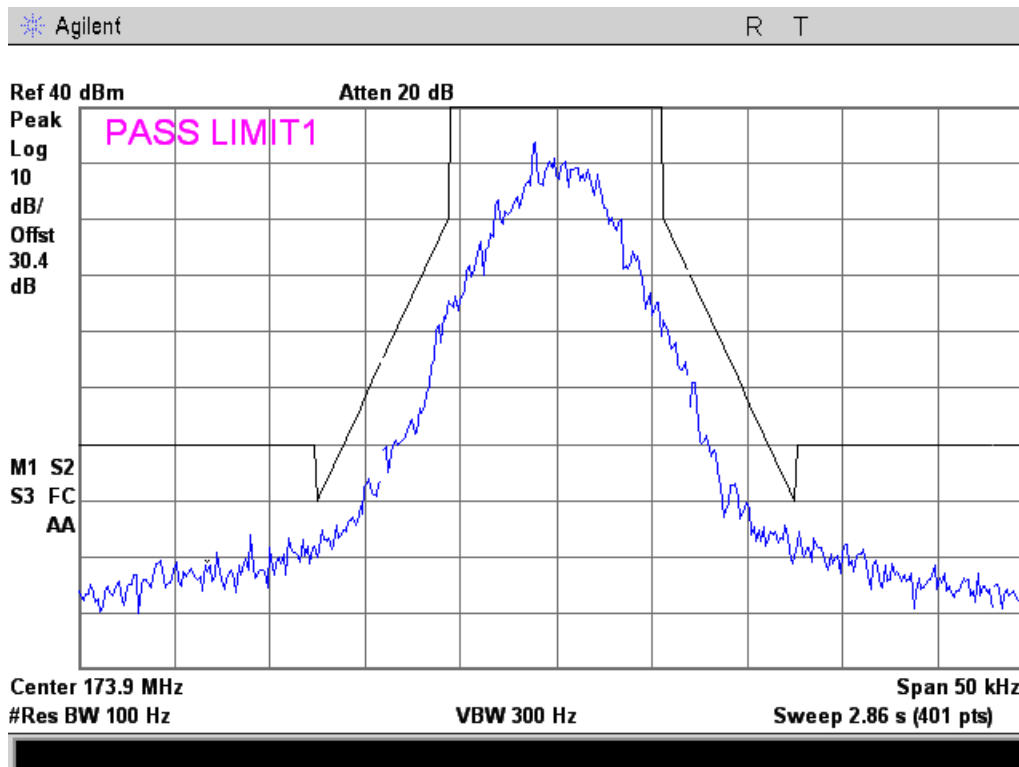



11K0F3E

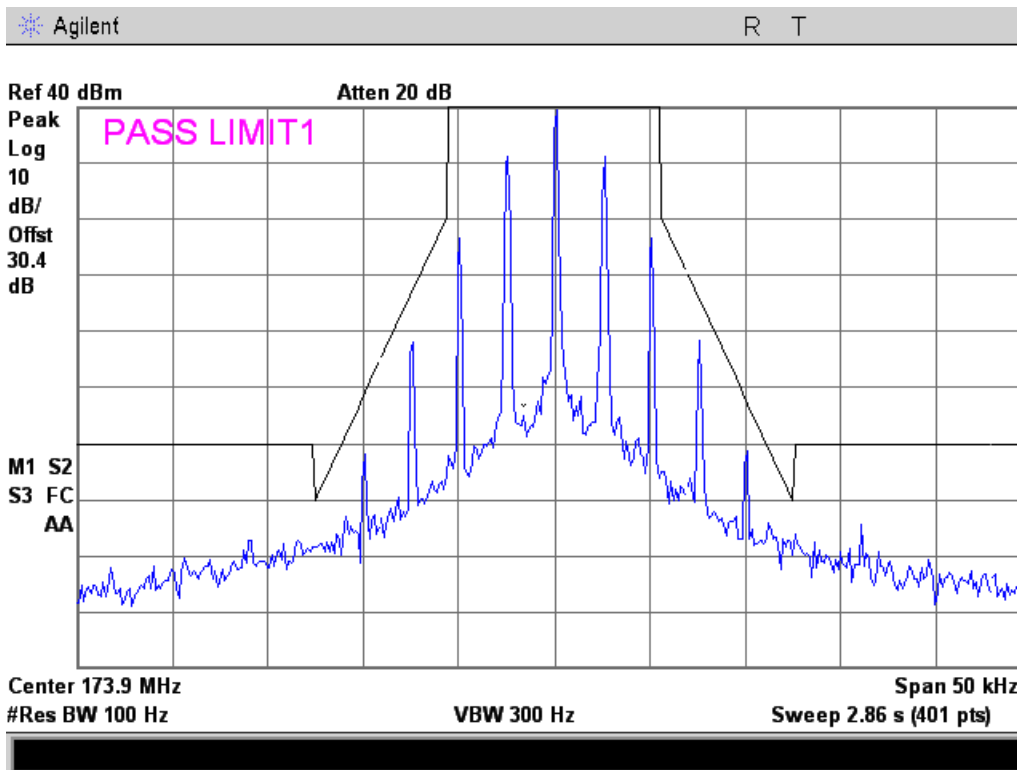

16K0F3E (RSS-119 Only)

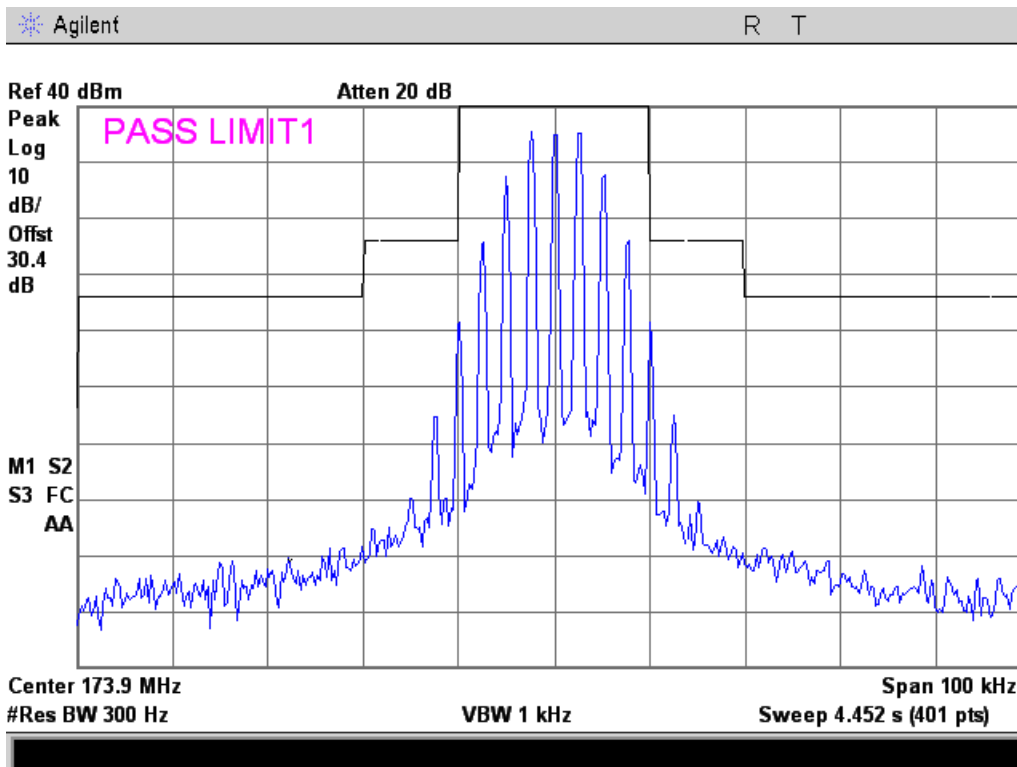



380.00 AM MHz 6K00A3E Reference

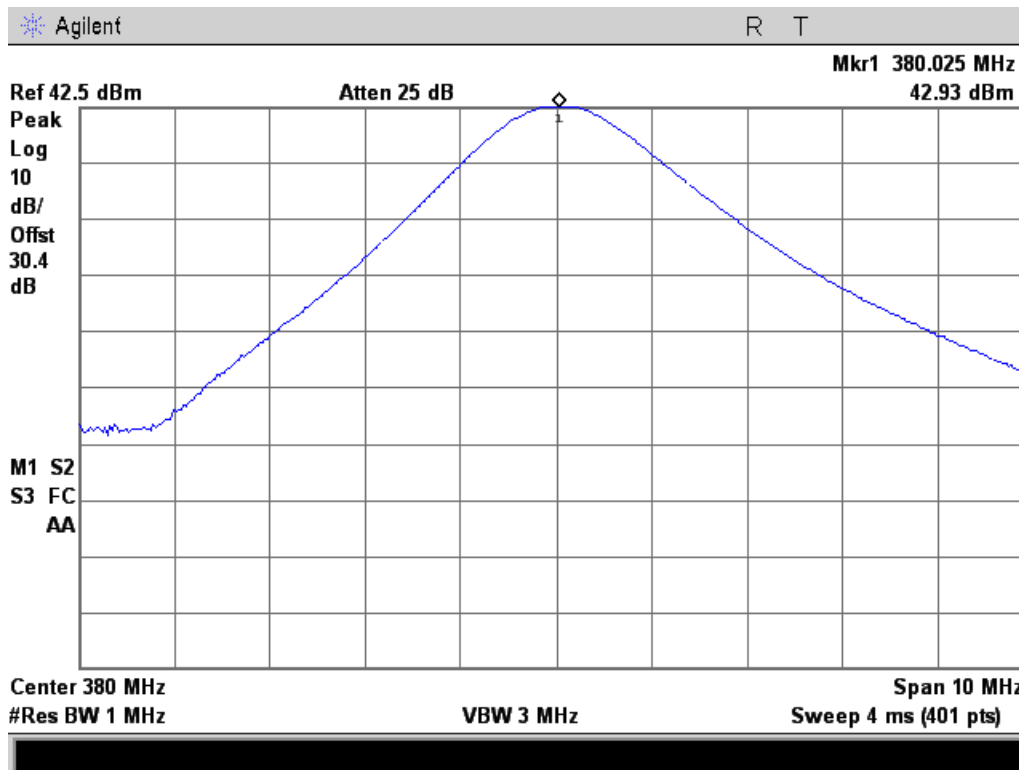

6K00A3E

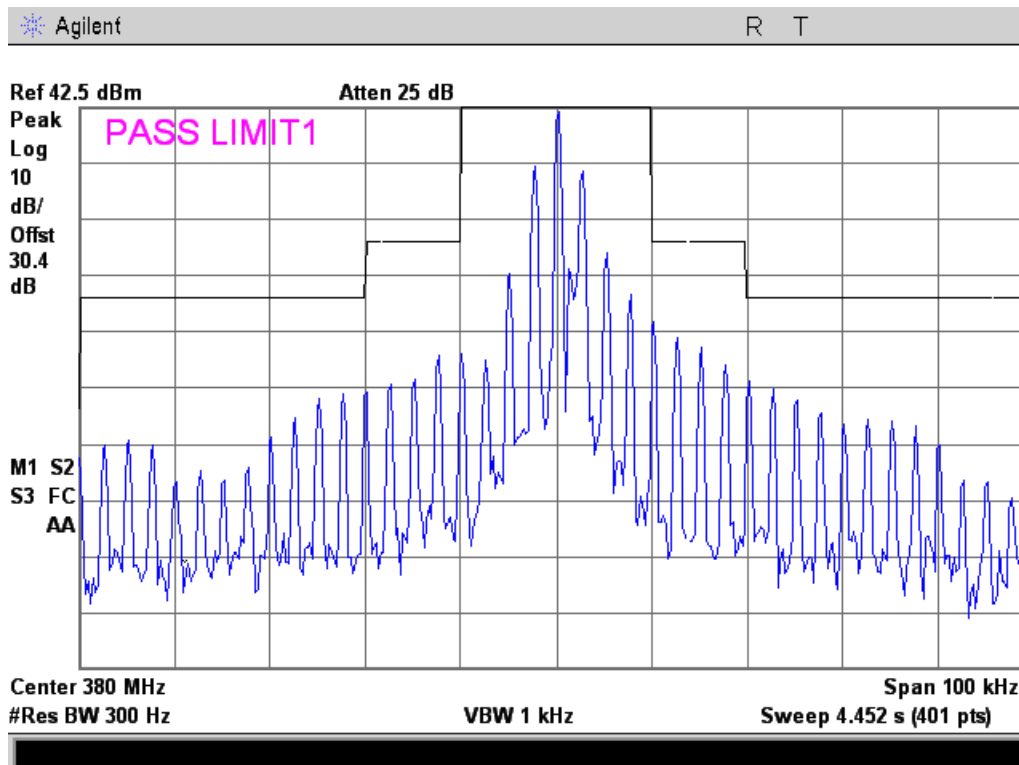



380.00 FM MHz

Reference

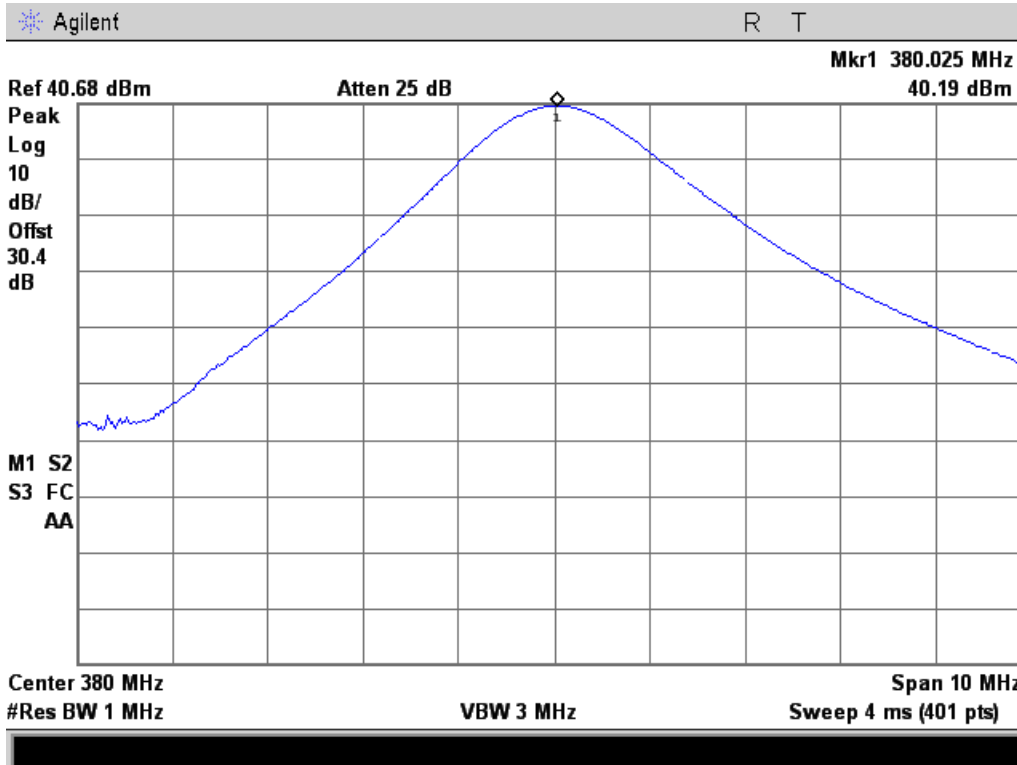

8K10F1D

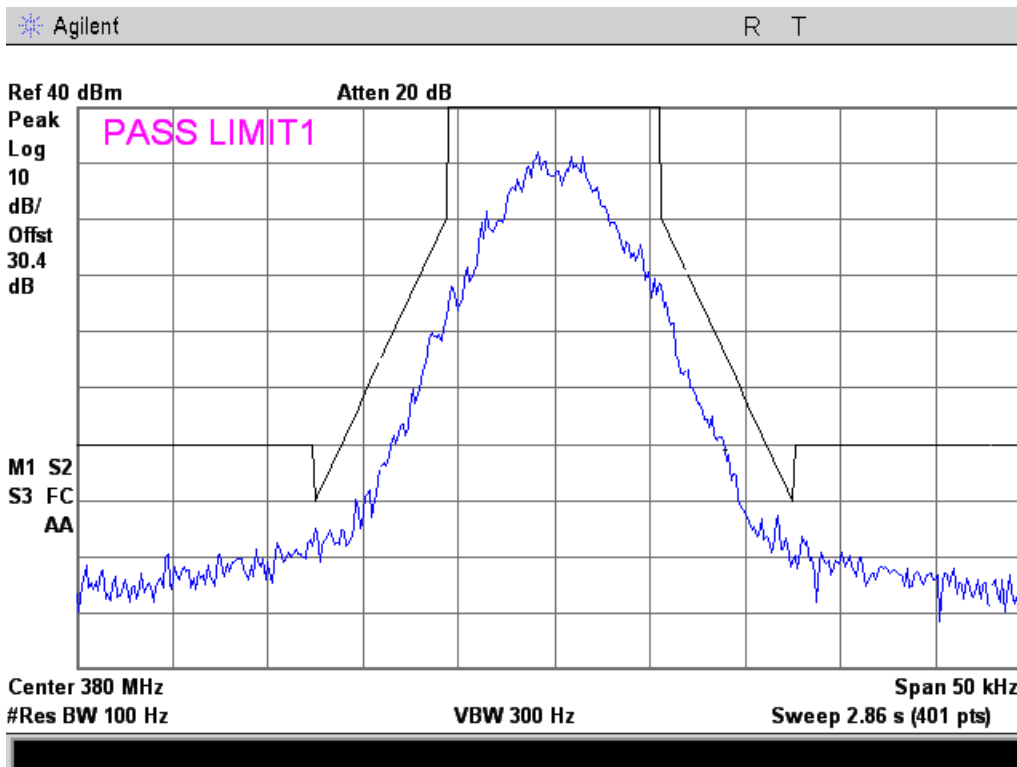



11K0F3E

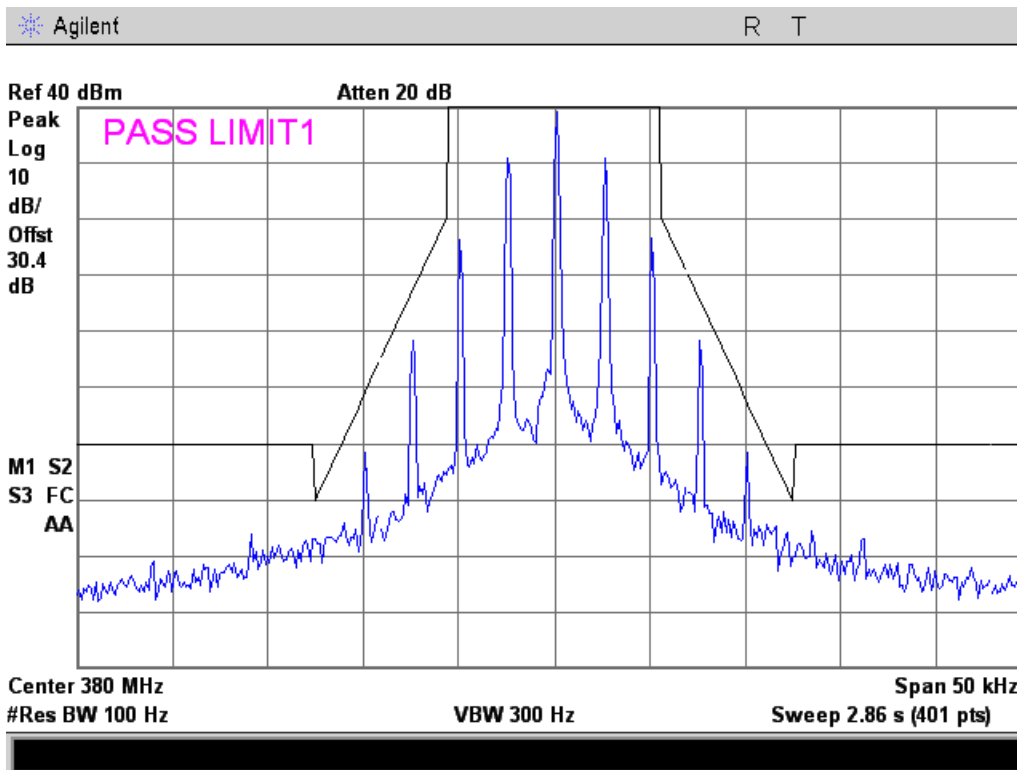

16K0F3E (Federal Use Only)

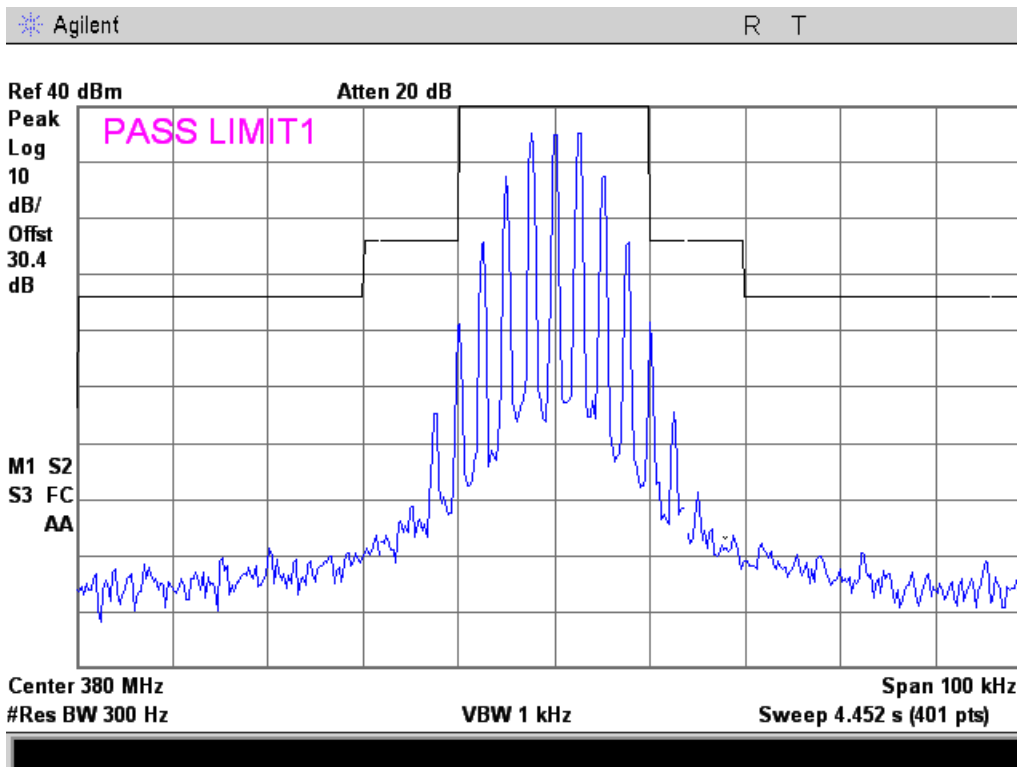



406.15 MHz Reference

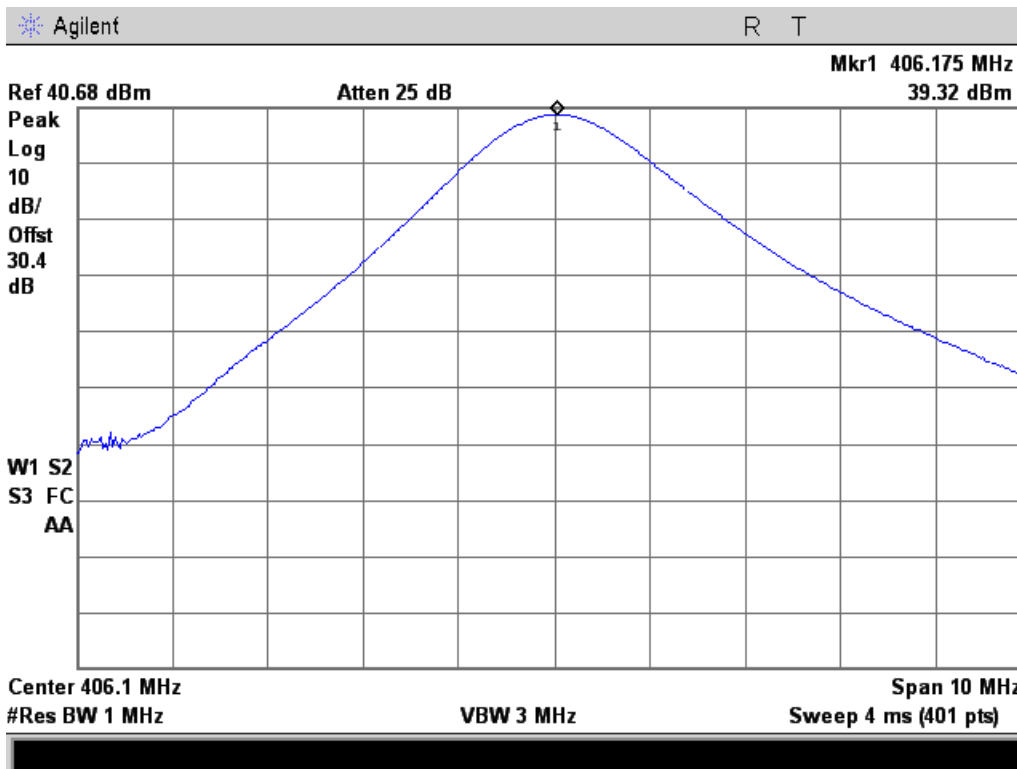

8K10F1D

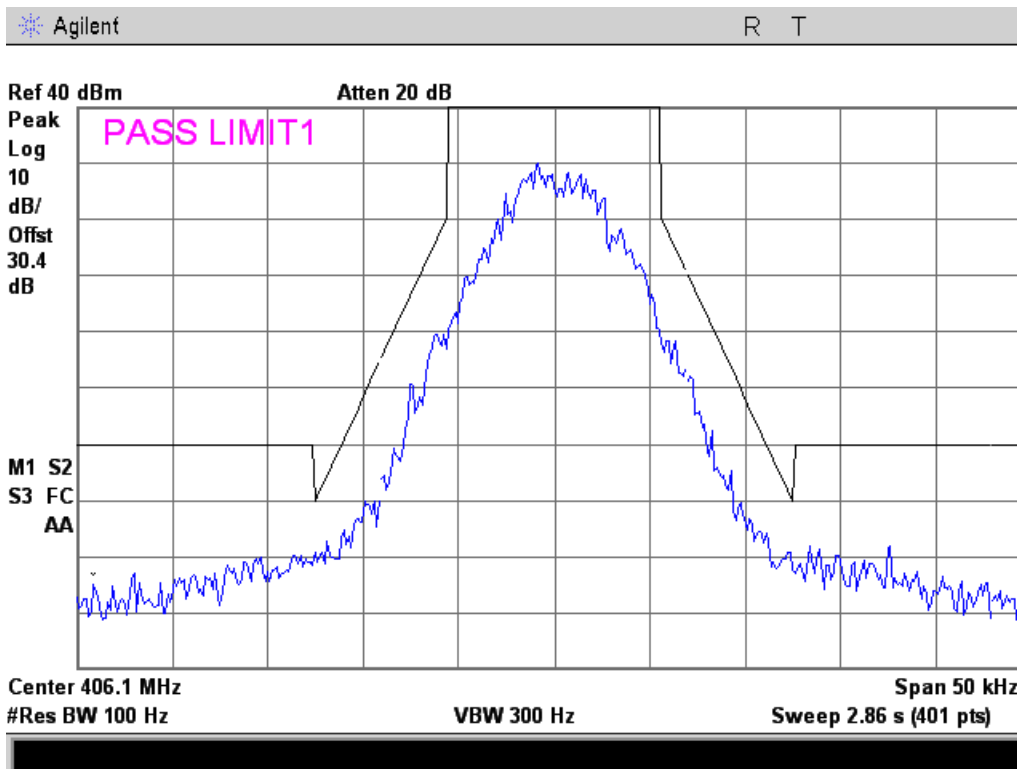



11K0F3E

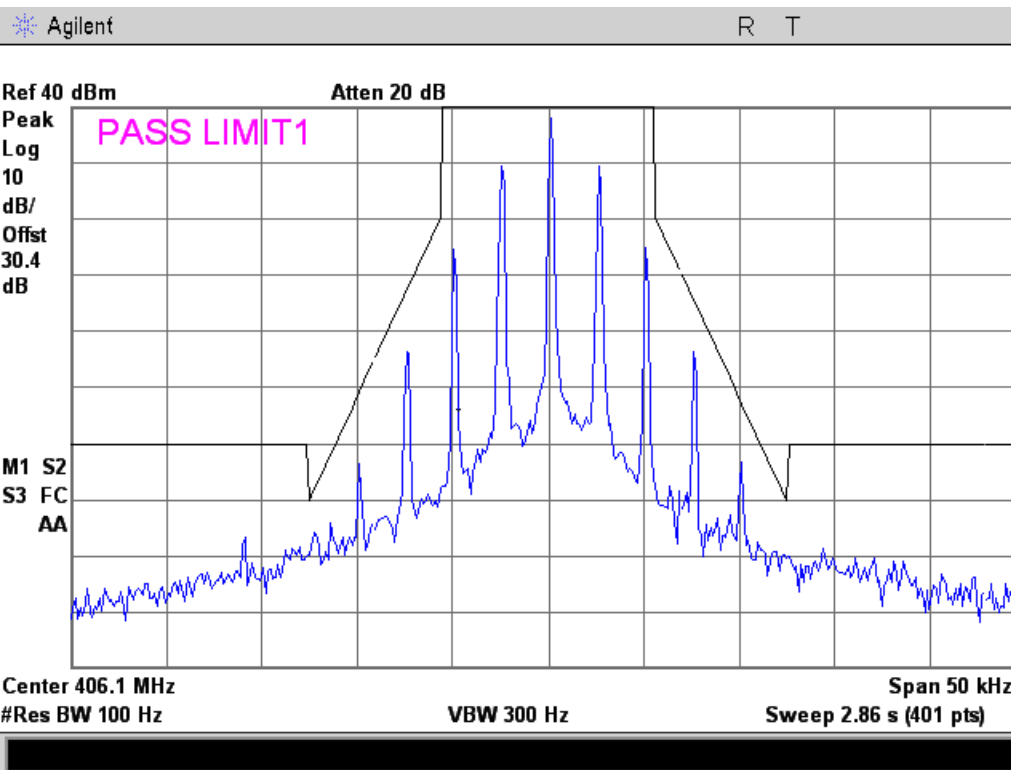

16K0F3E (Federal Use Only)

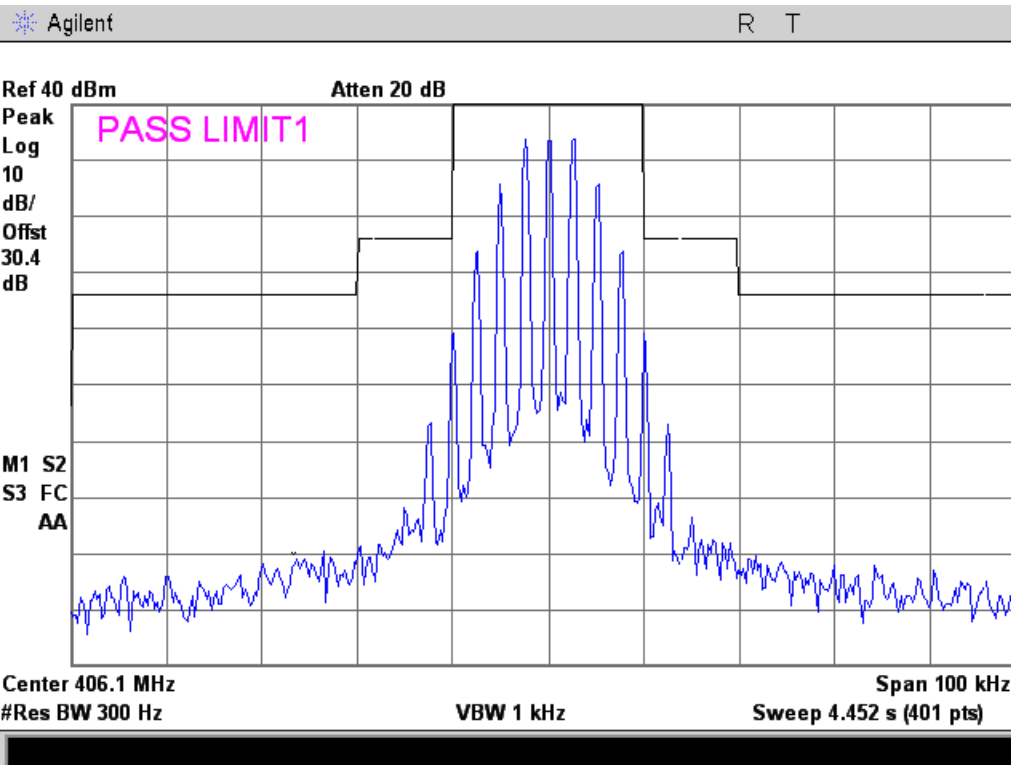



413 MHz Reference

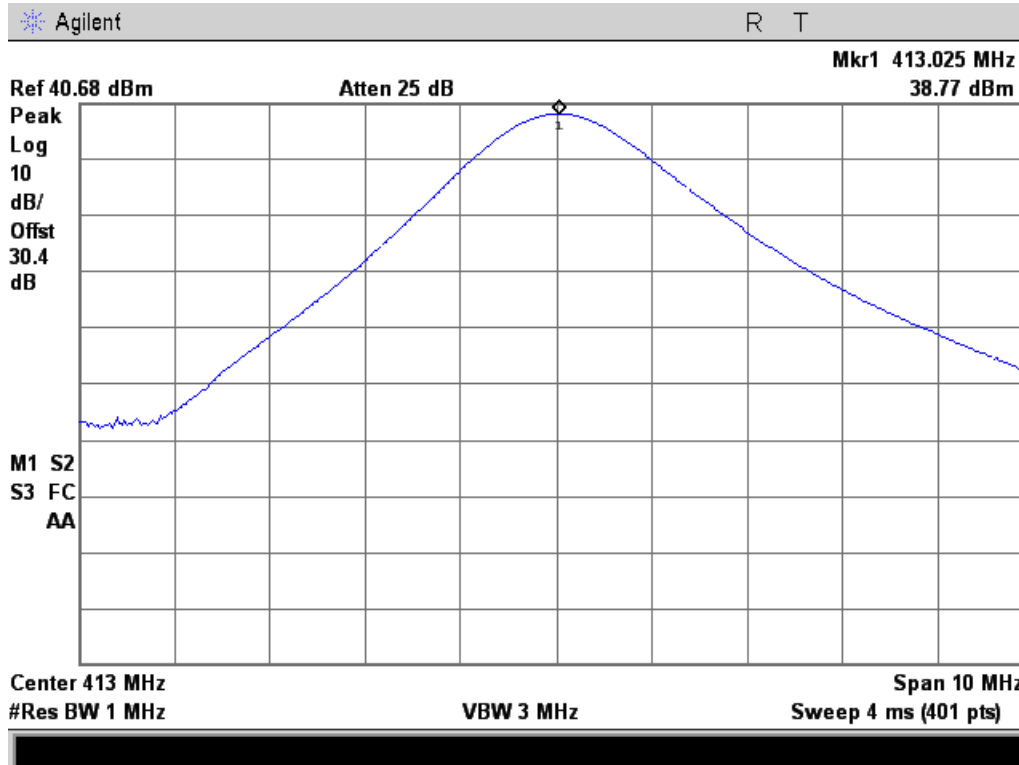

8K10F1D

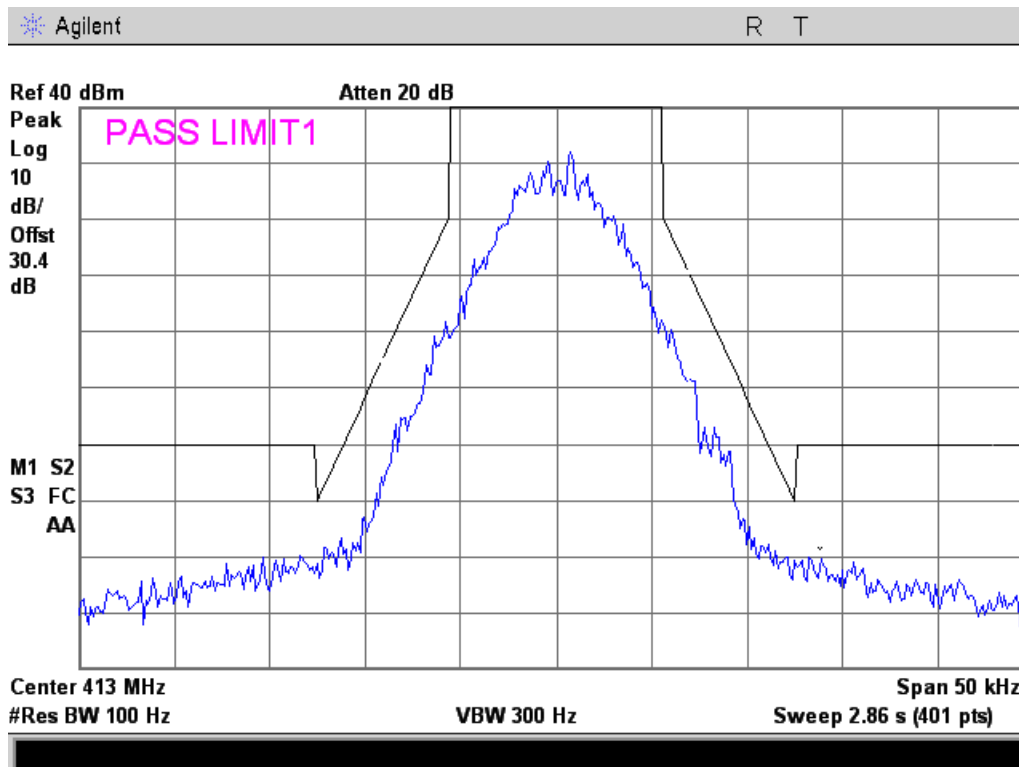



11K0F3E

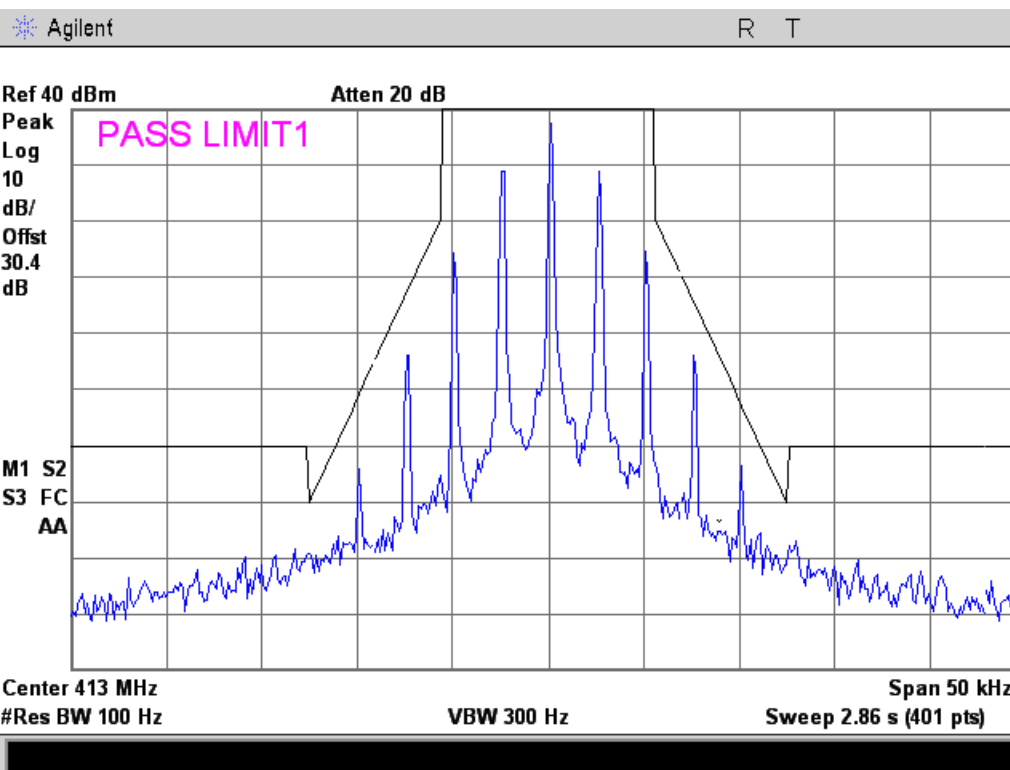

16K0F3E (Federal Use Only)

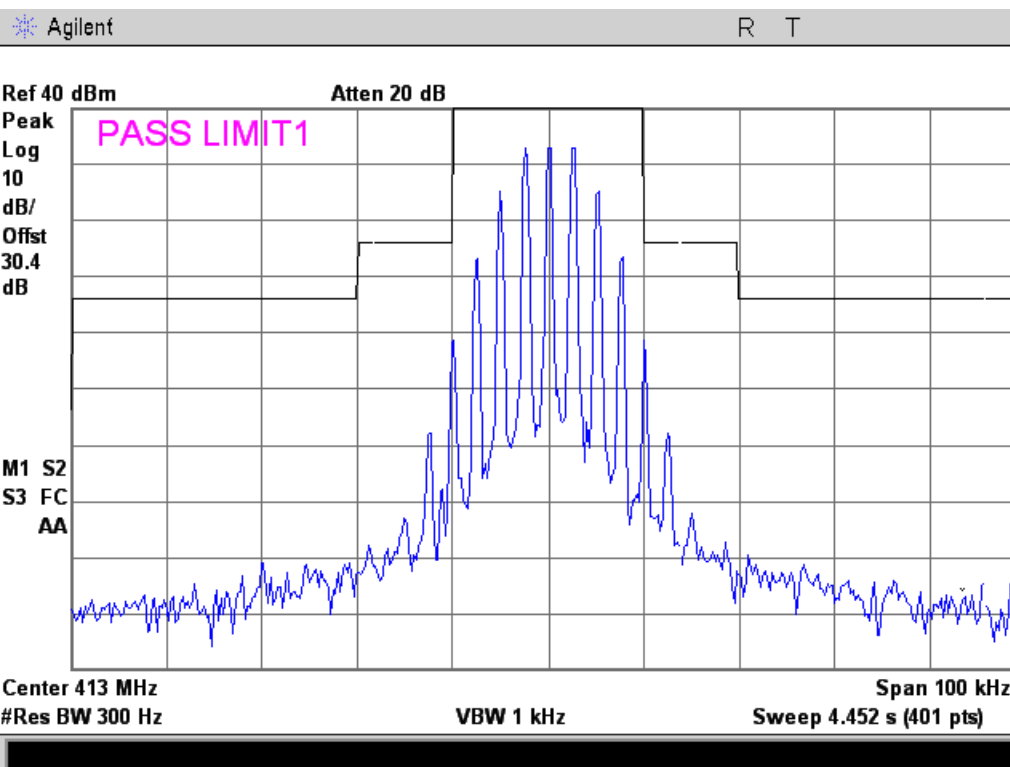



420.975 MHz Reference

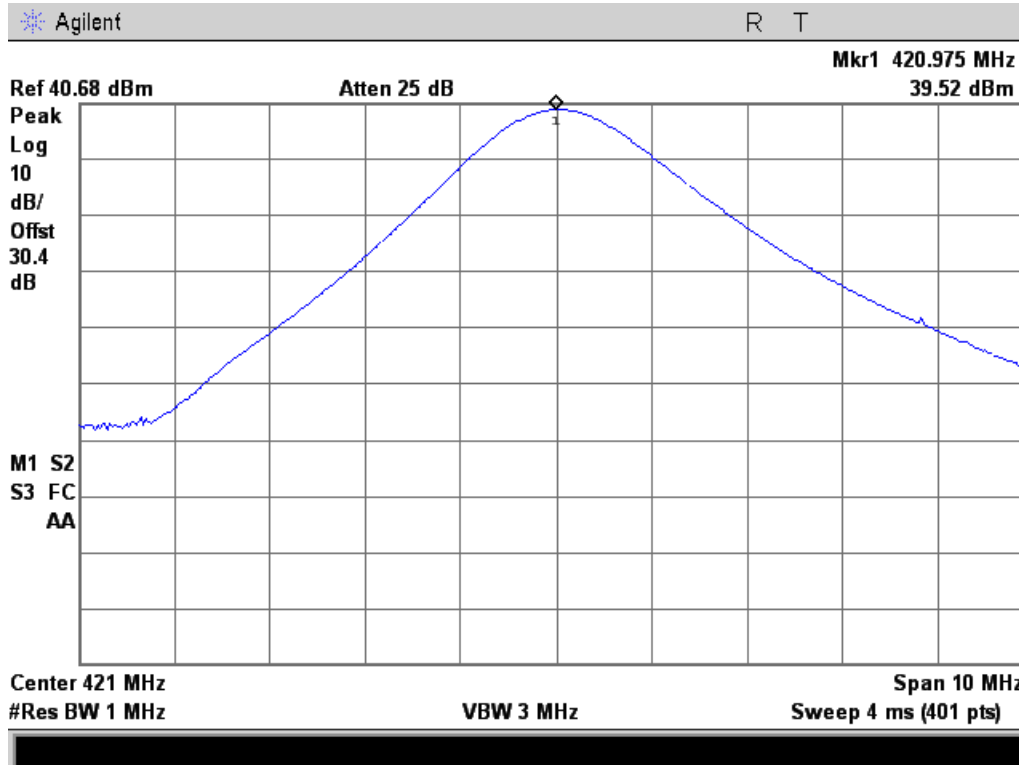

8K10F1D

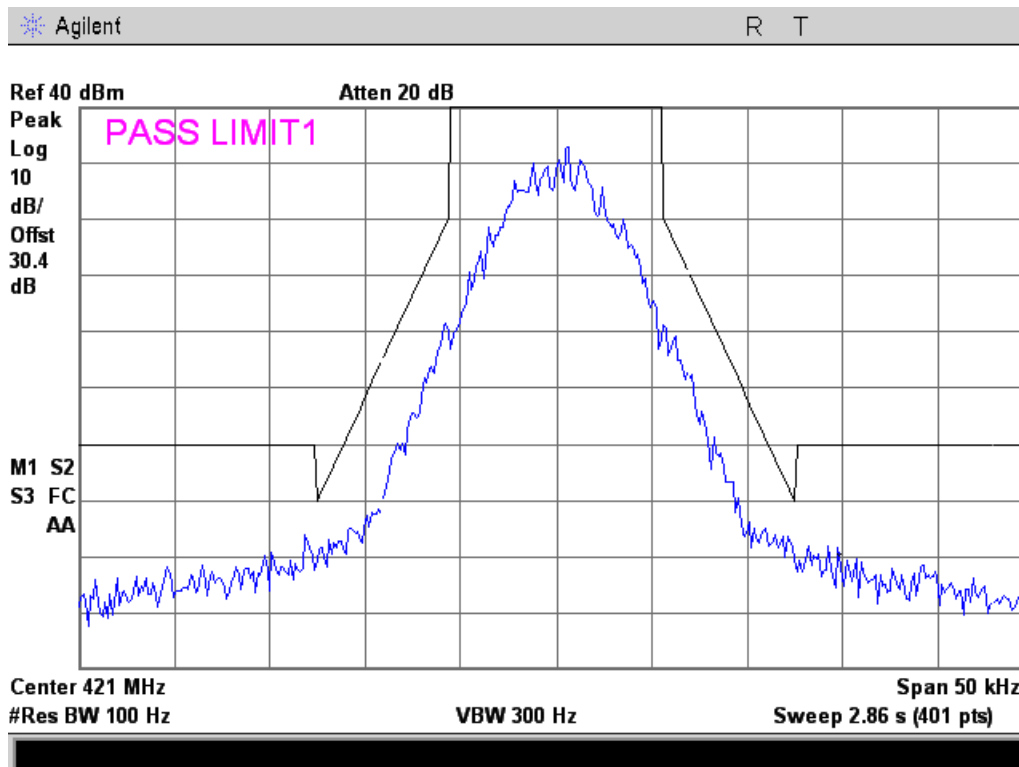



11K0F3E

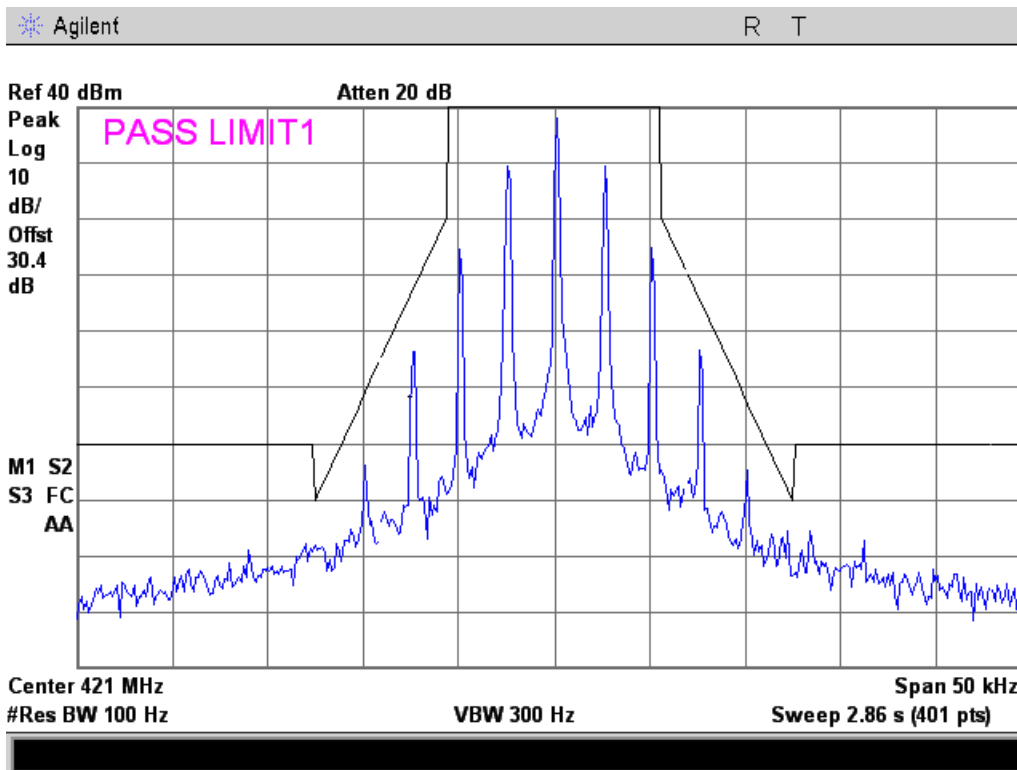

16K0F3E (Federal Use Only)

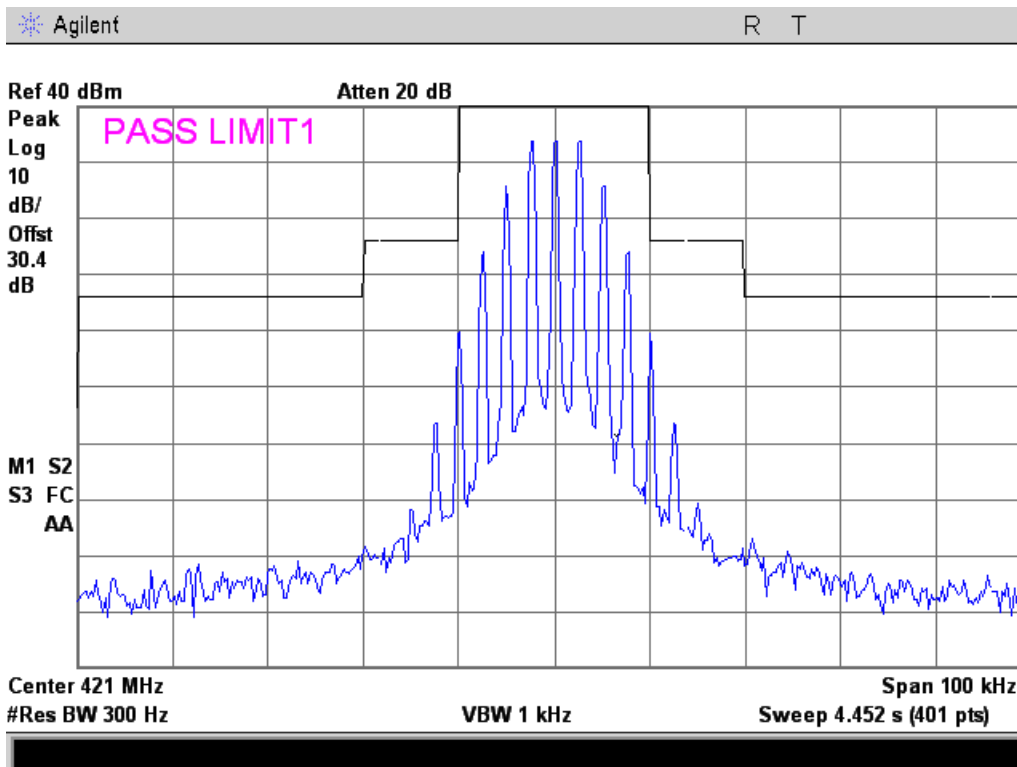



438.05 MHz Reference



8K10F1D

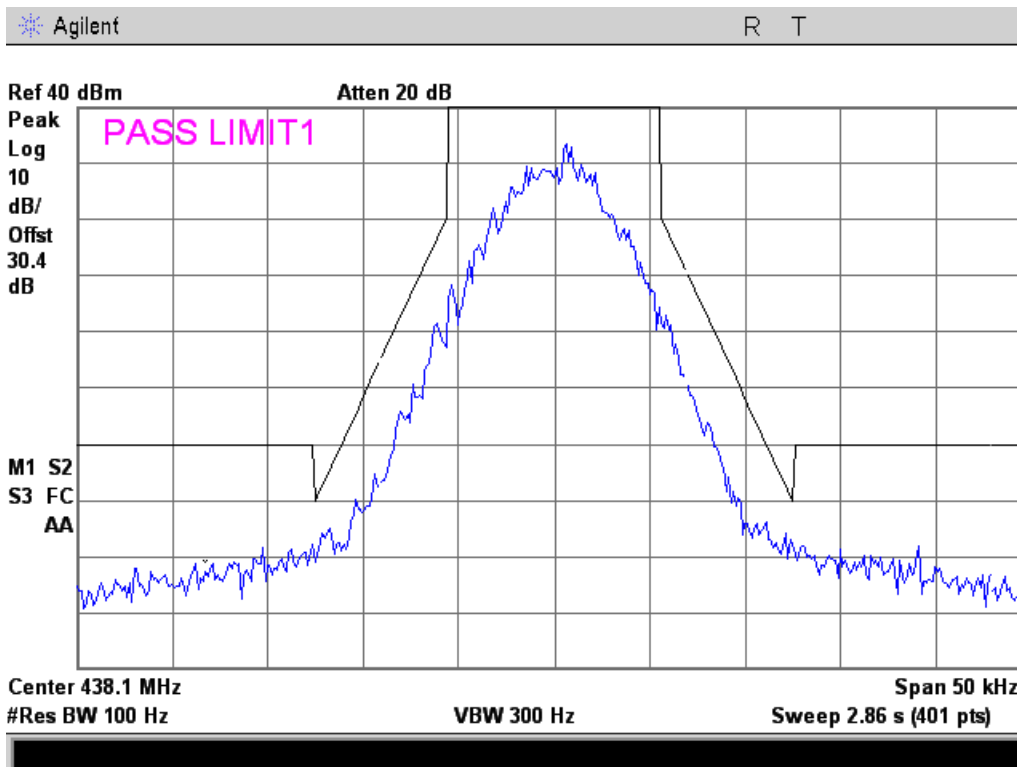



11K0F3E

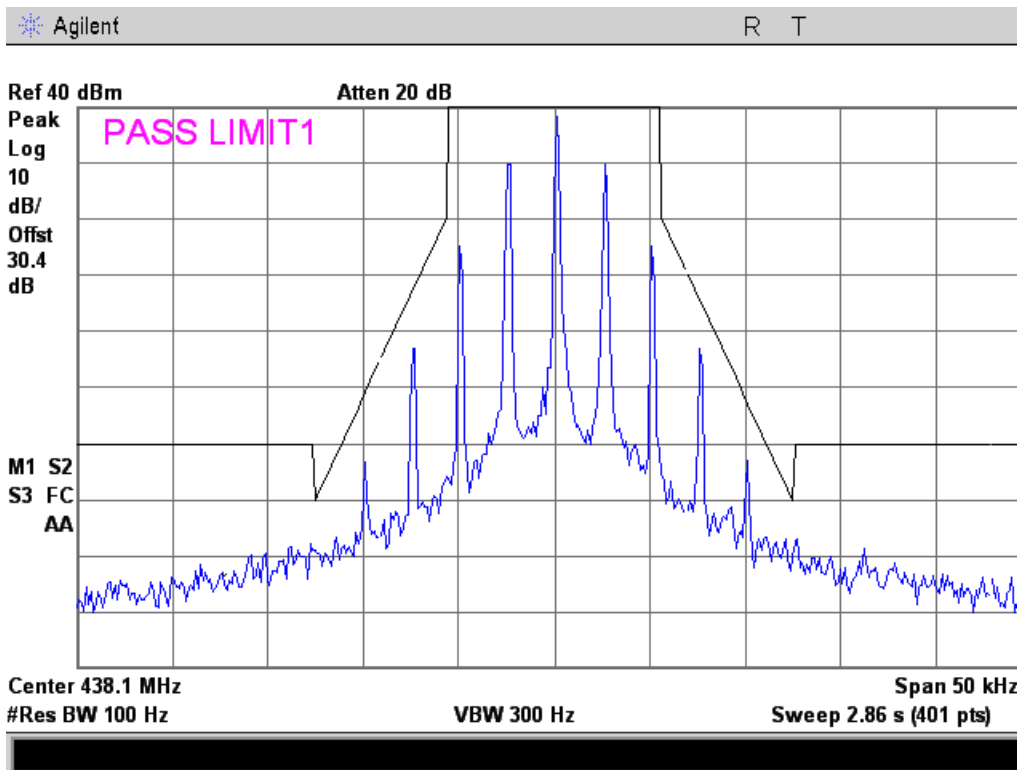

16K0F3E (RSS-119 Only)

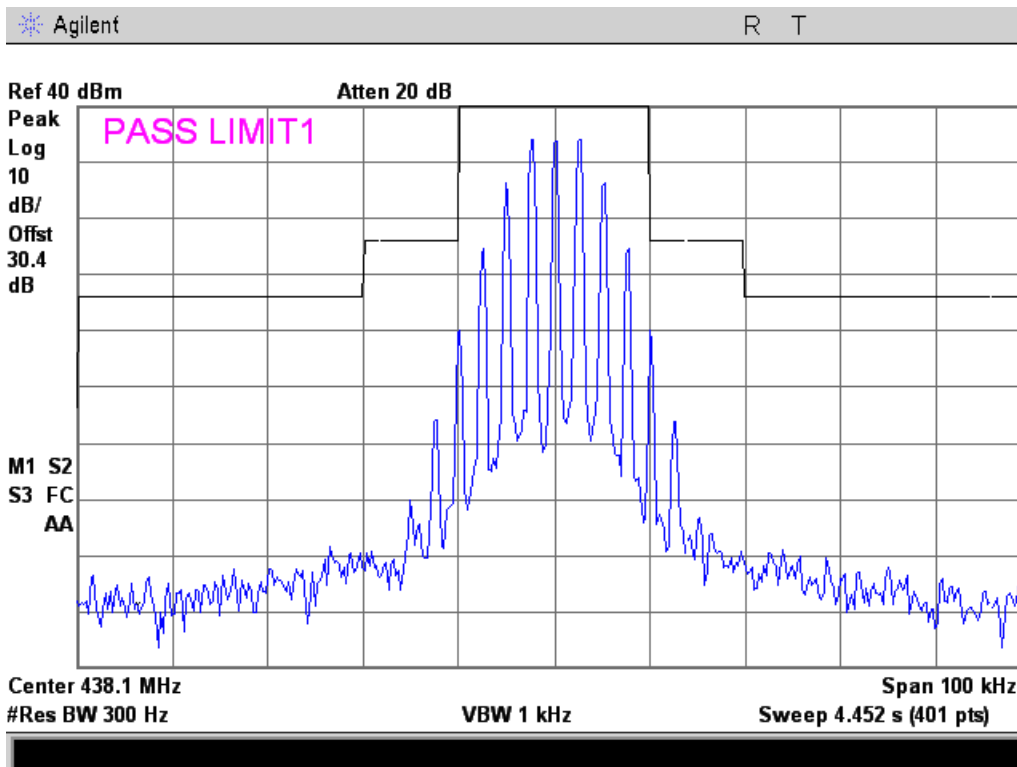



469.95 MHz Reference

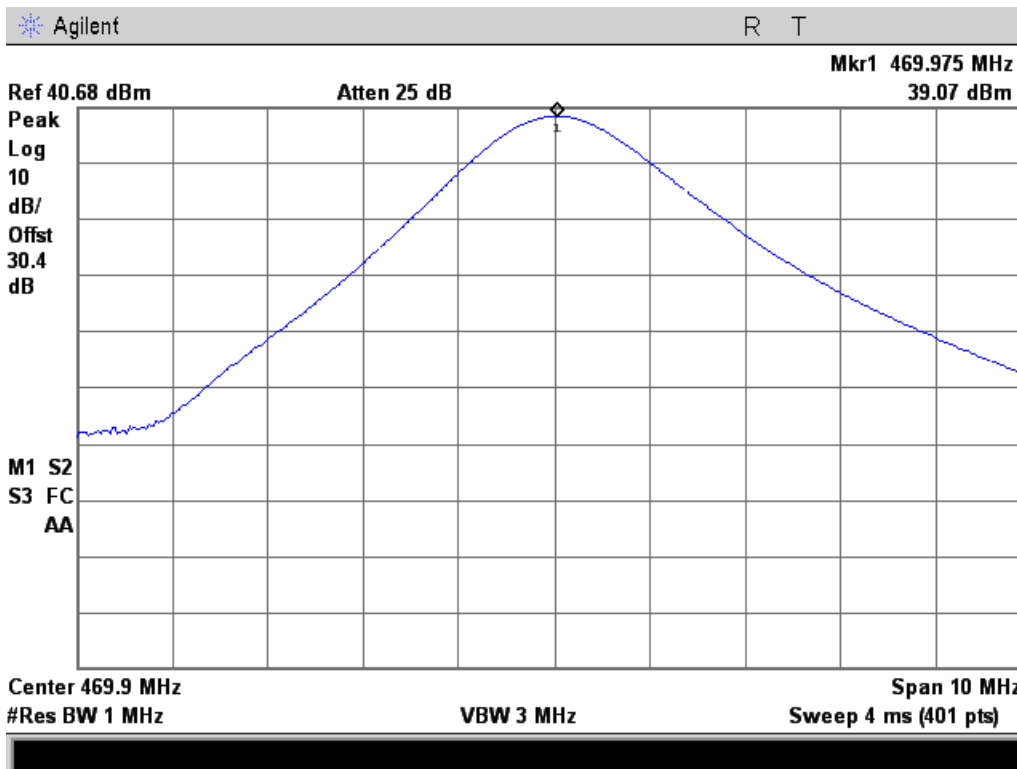

8K10F1D

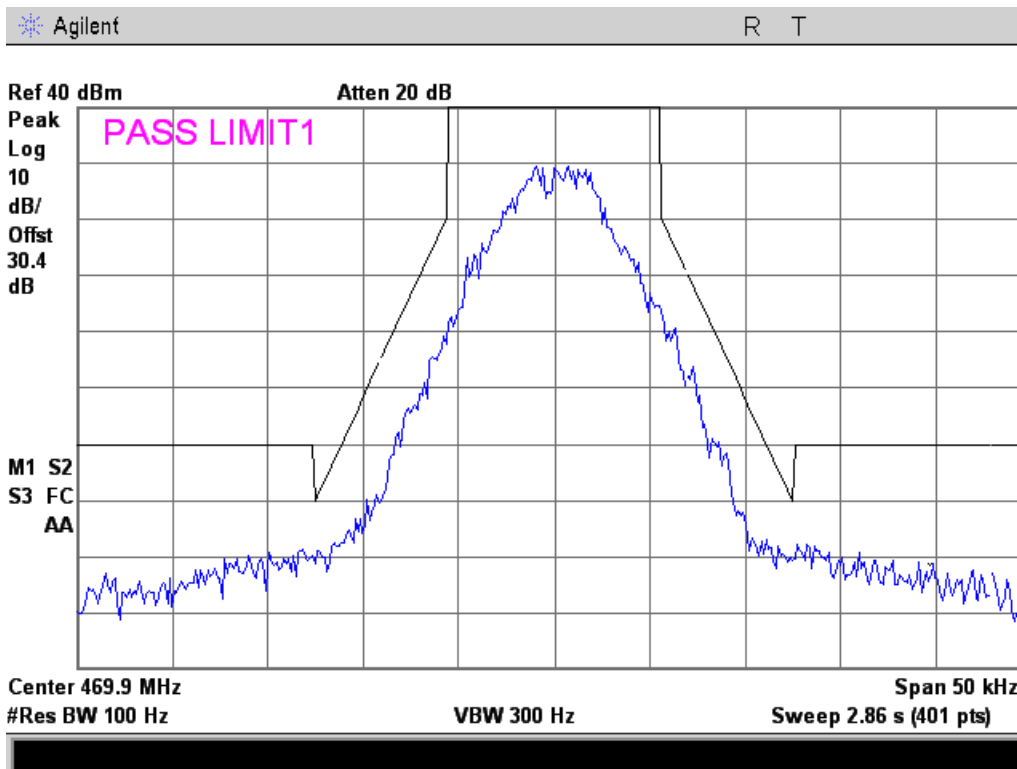



11K0F3E

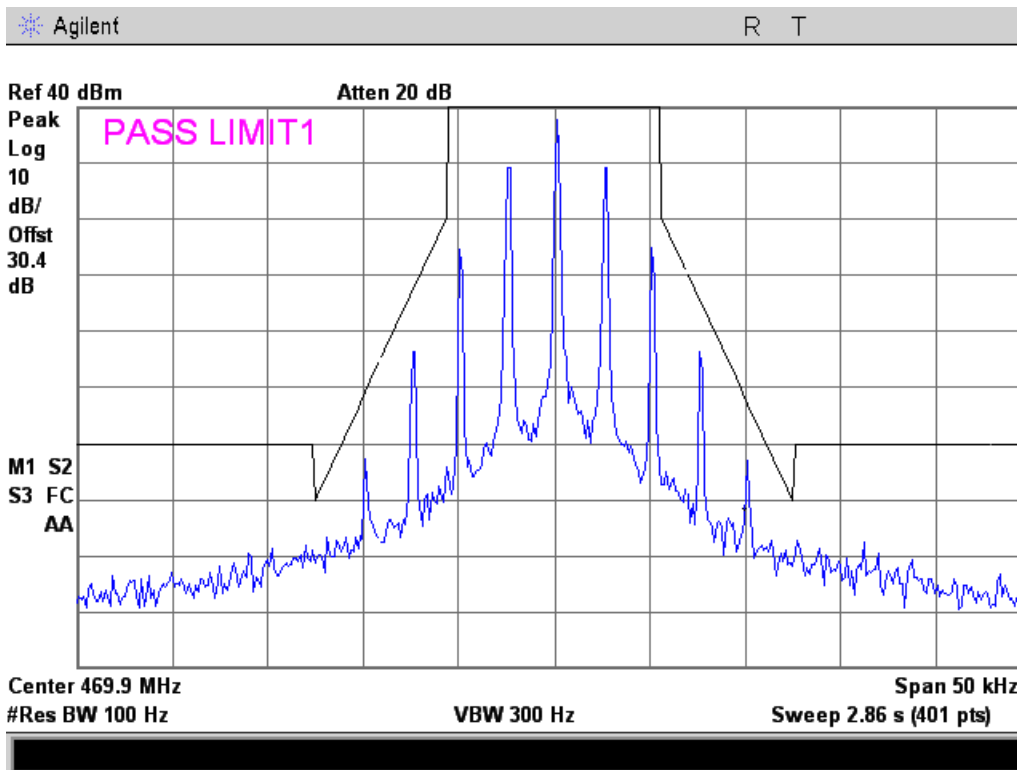

16K0F3E (RSS-119 Only)

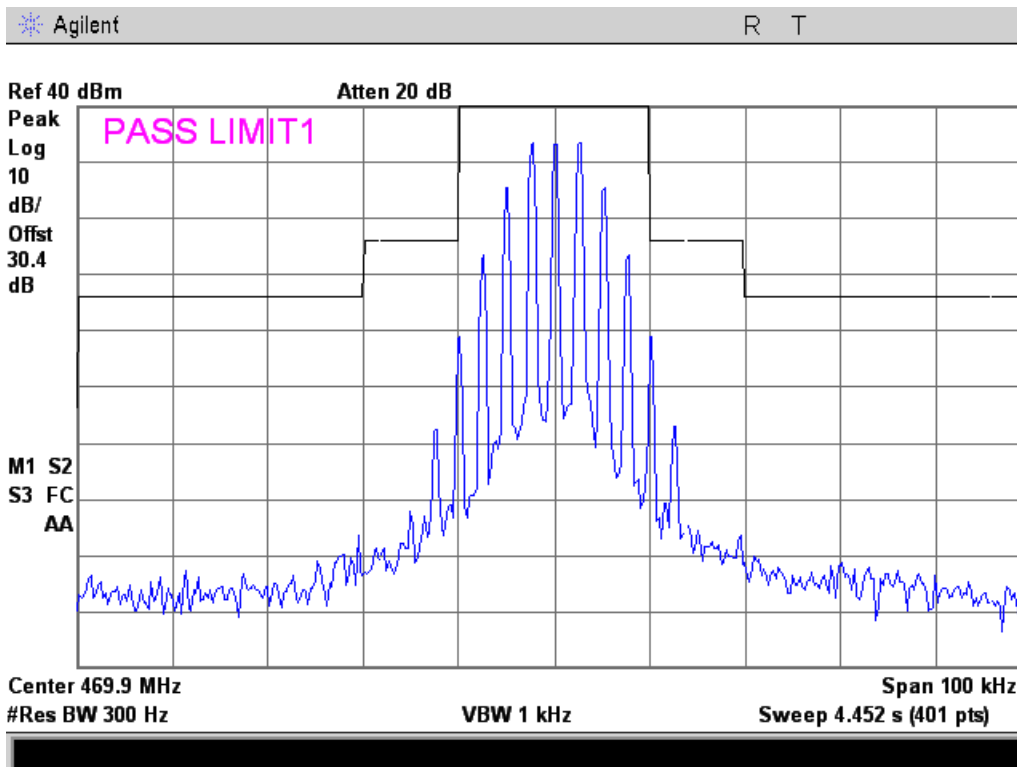



470.05 MHz Reference

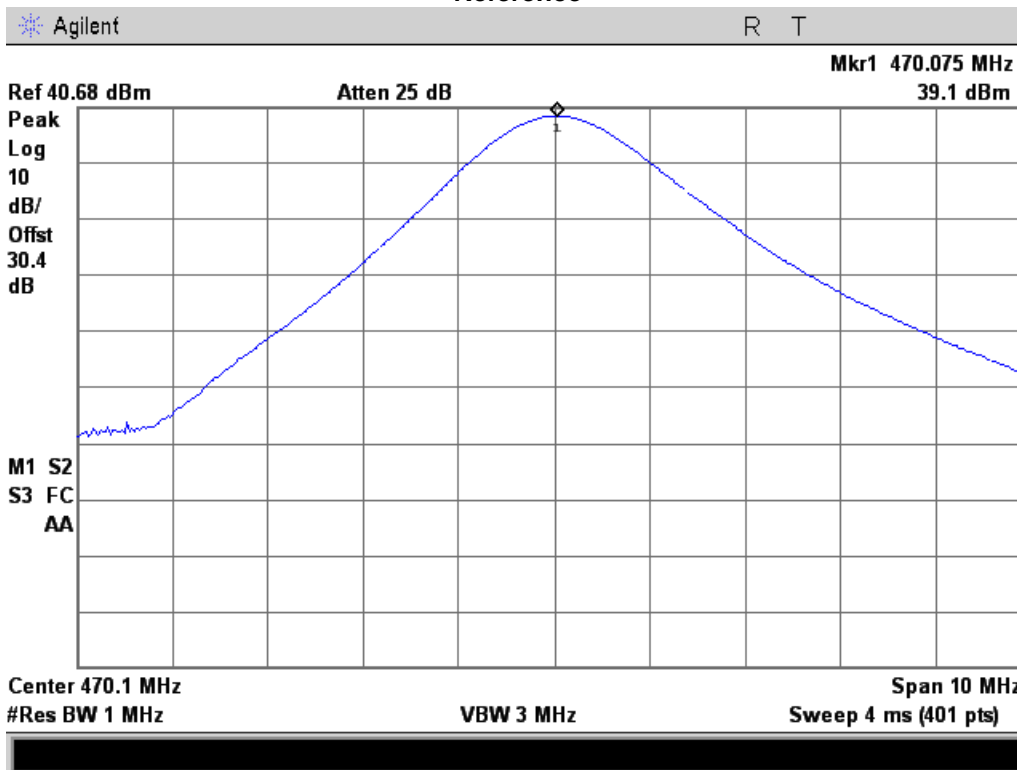

8K10F1D

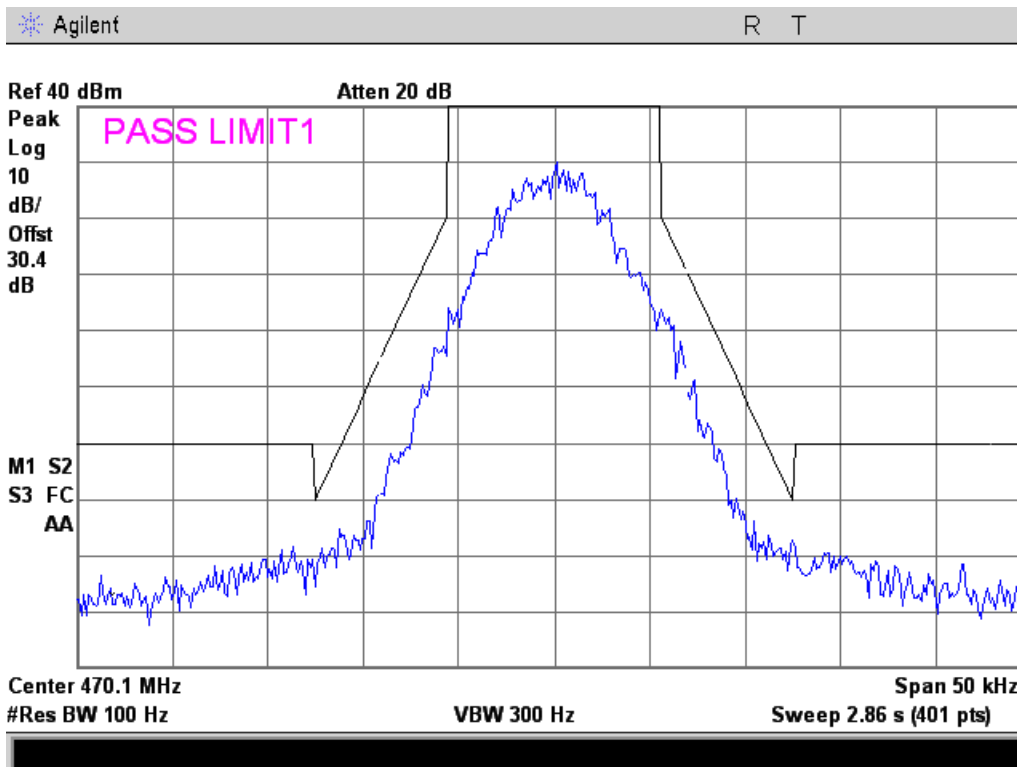



11K0F3E

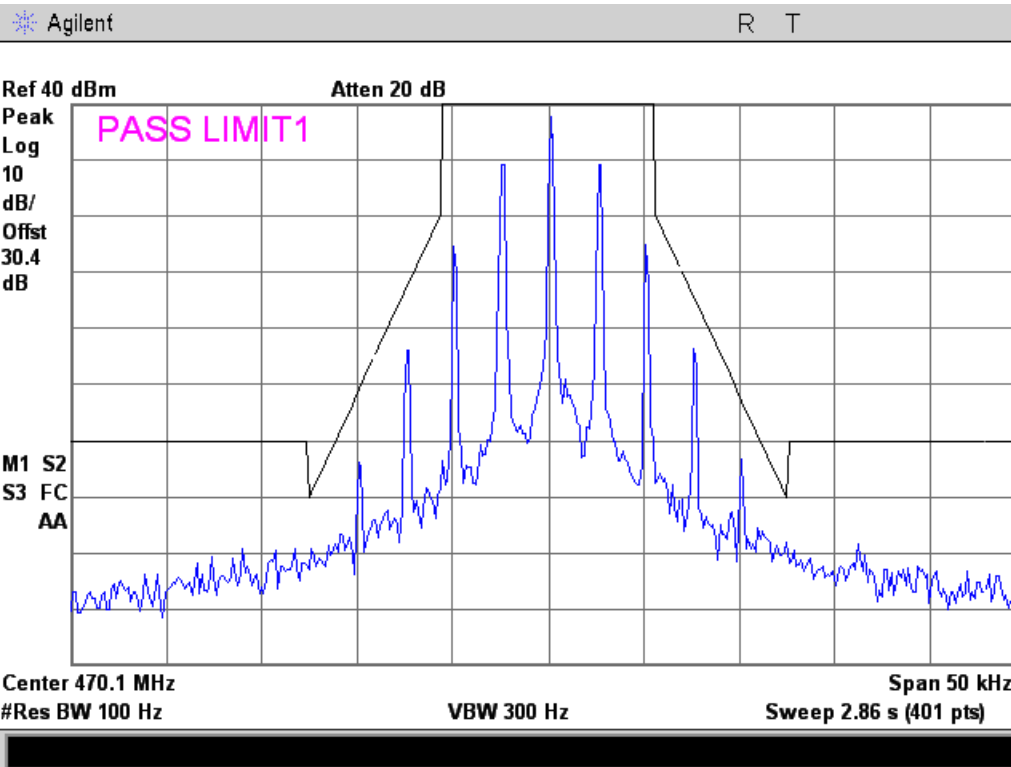

16K0F3E

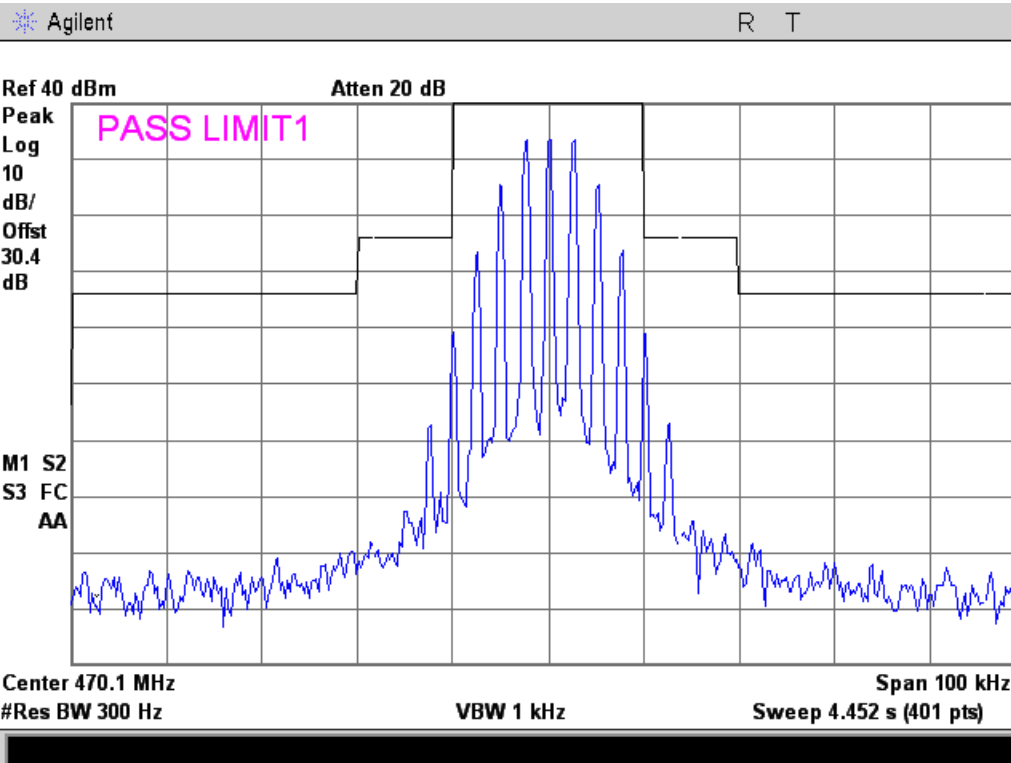



490.05 MHz Reference

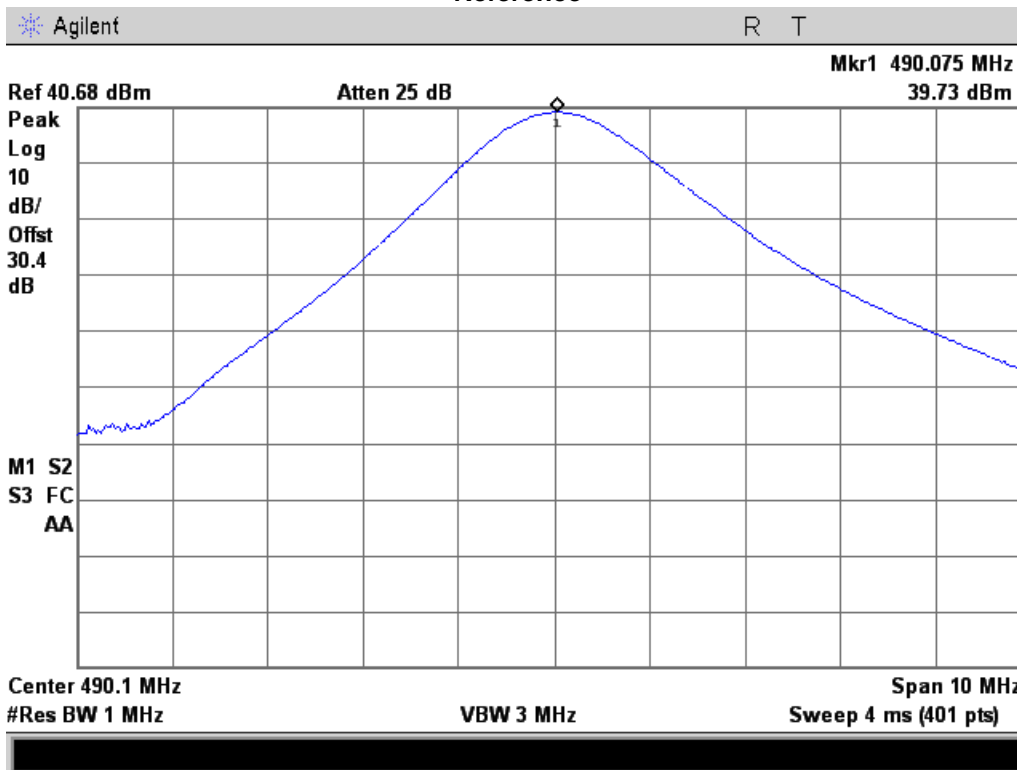

8K10F1D

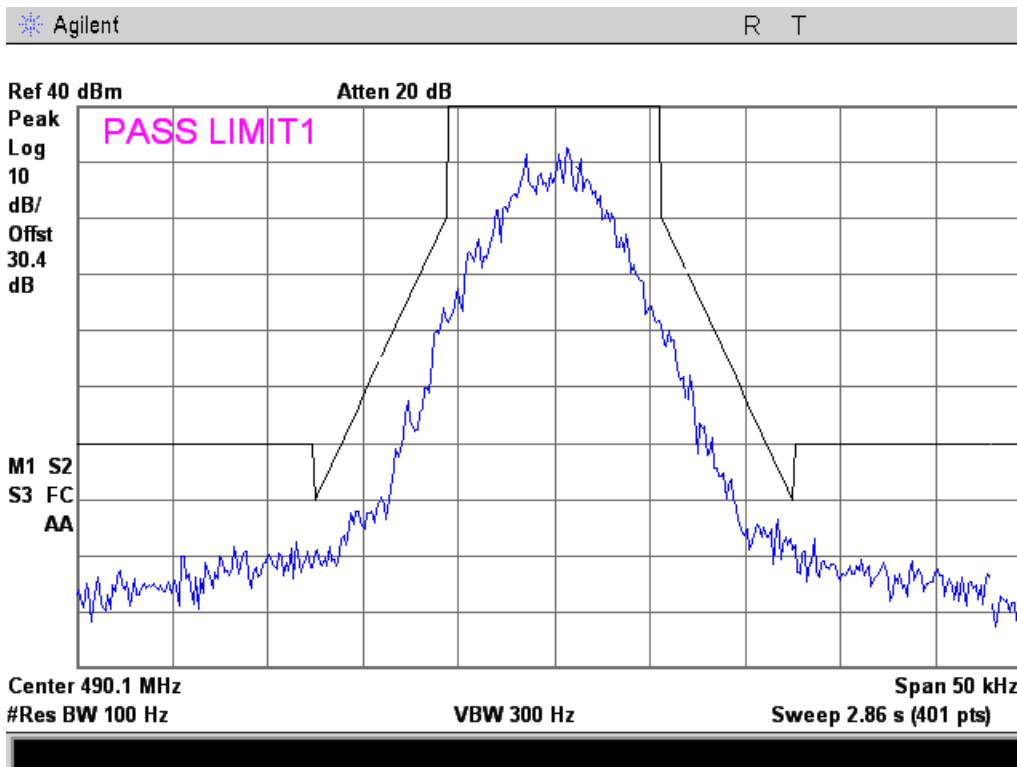



11K0F3E

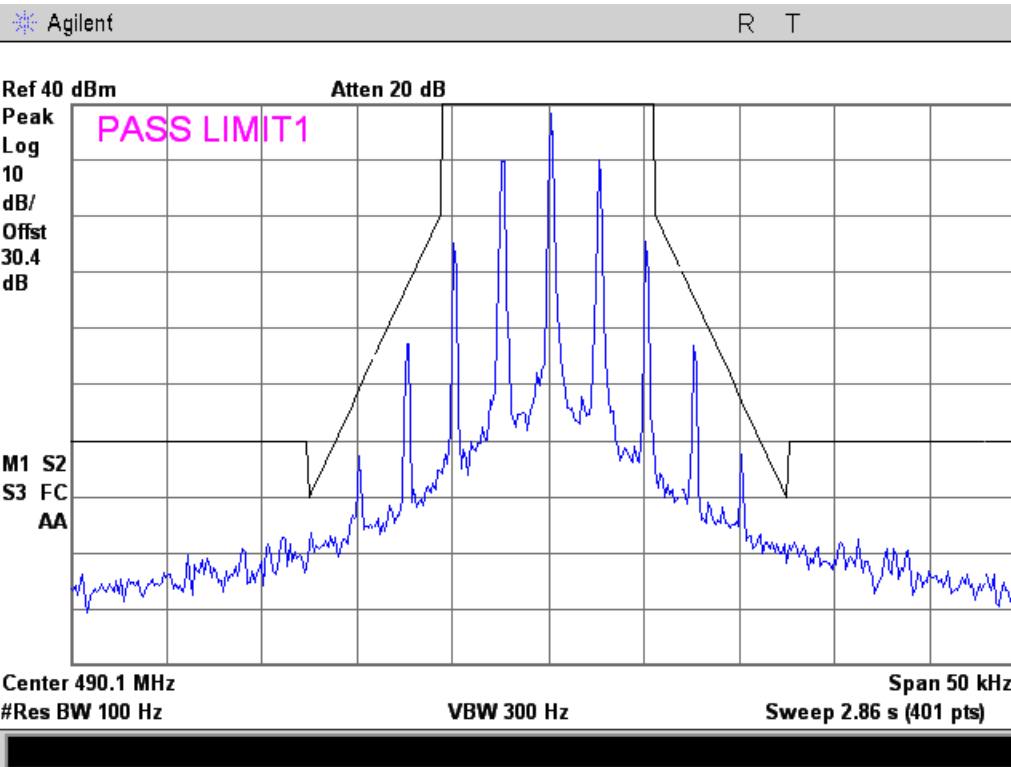

16K0F3E

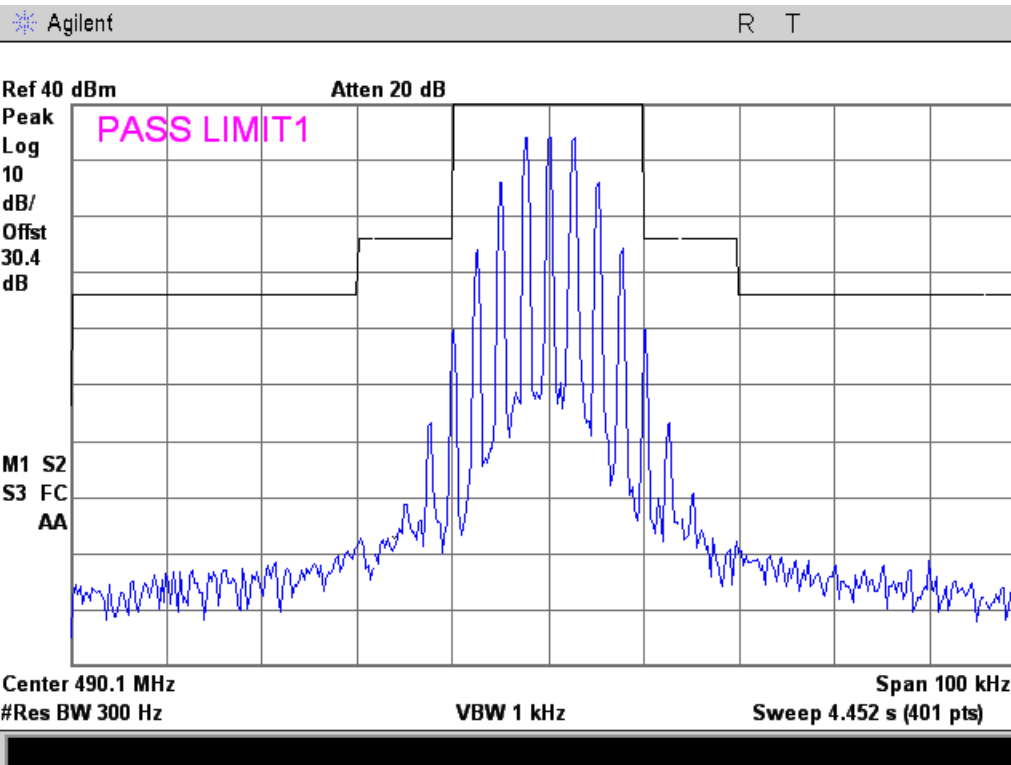



511.95 MHz Reference

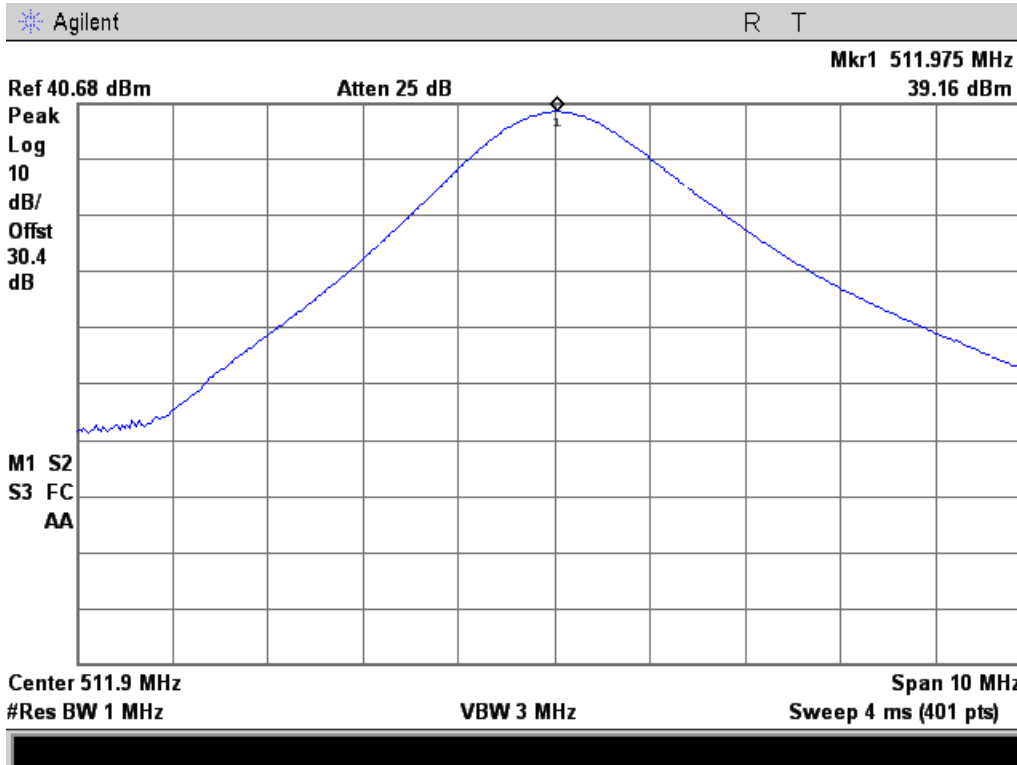

8K10F1D

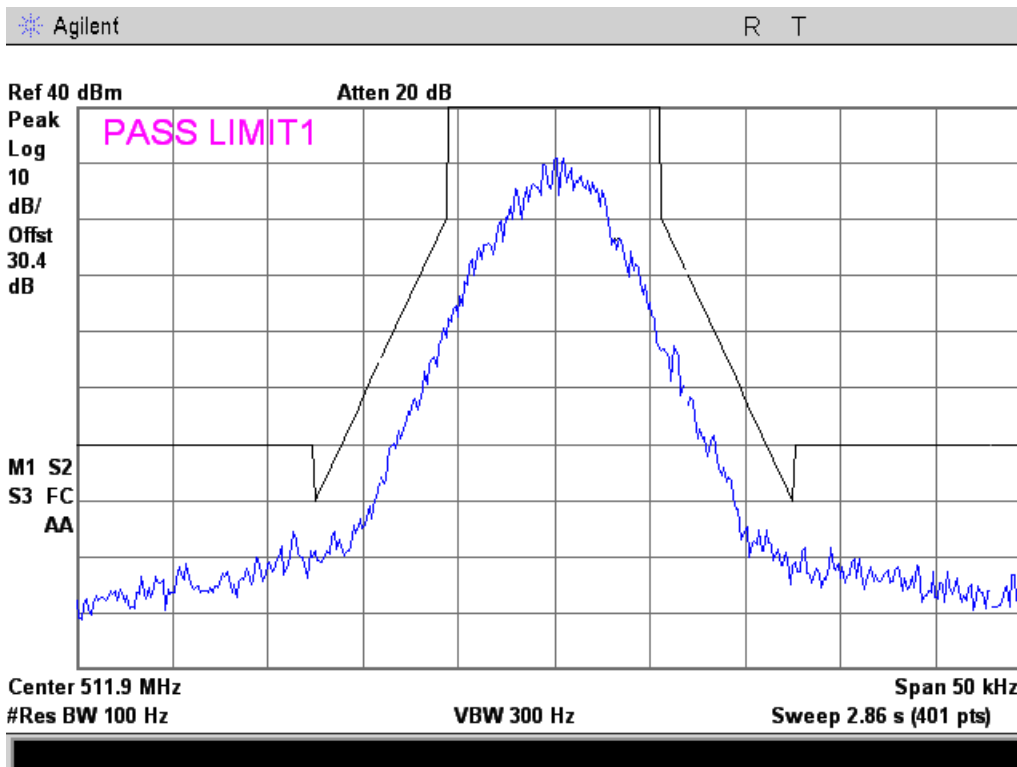



11K0F3E

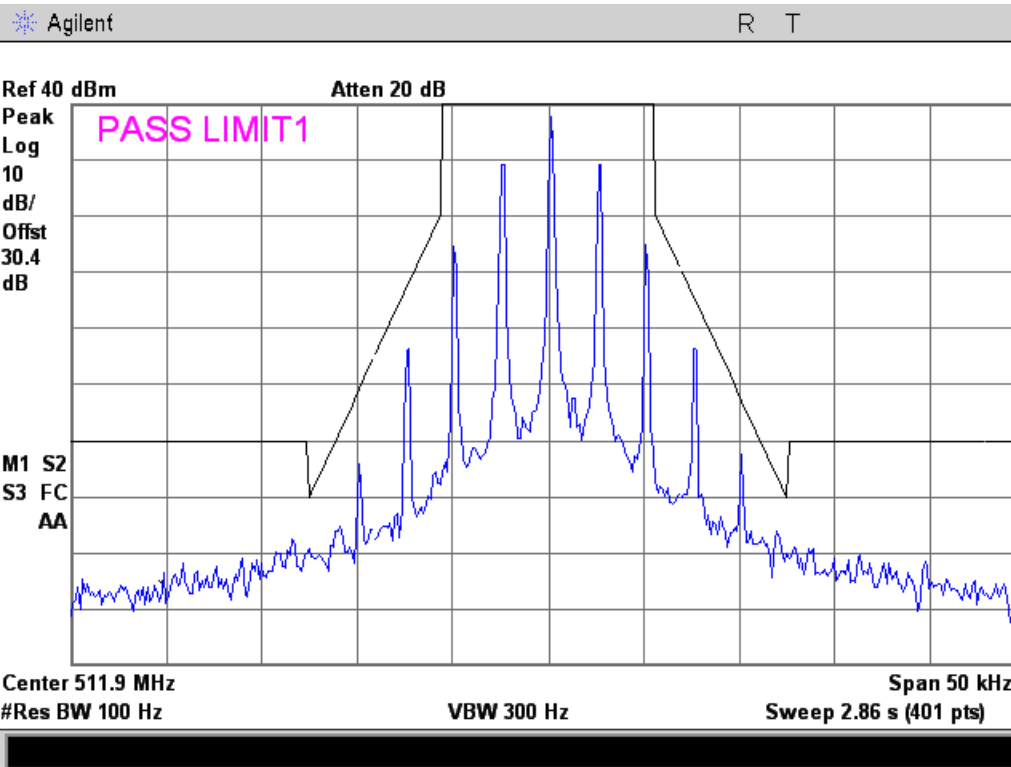

16K0F3E

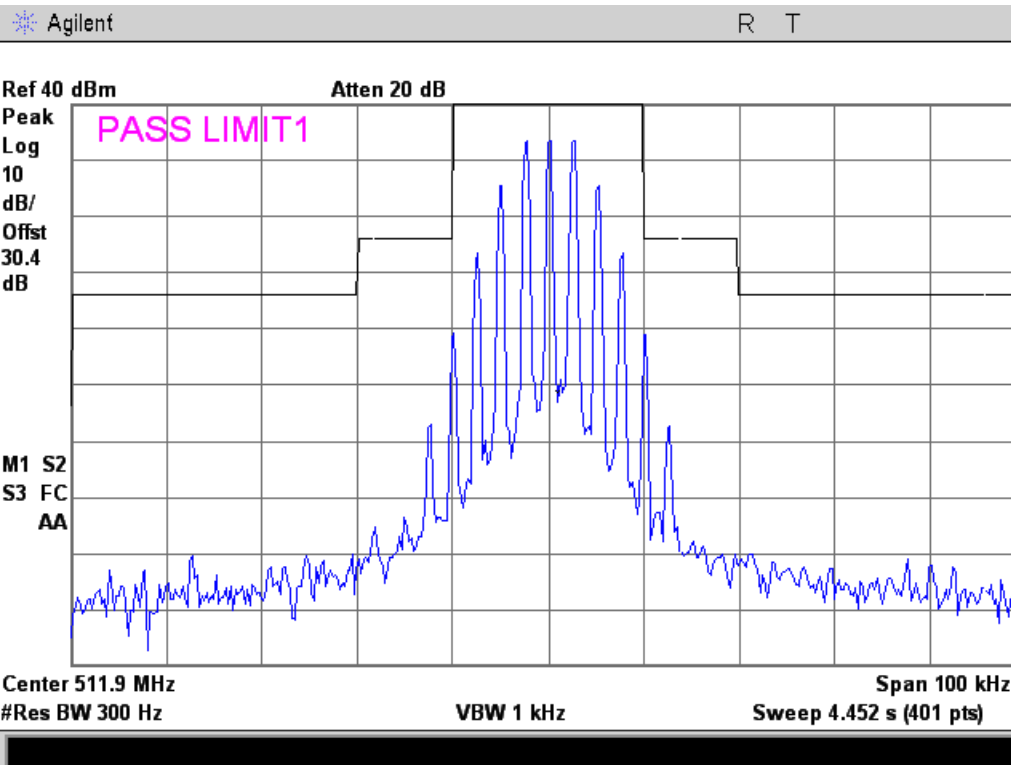



519.95 MHz Reference

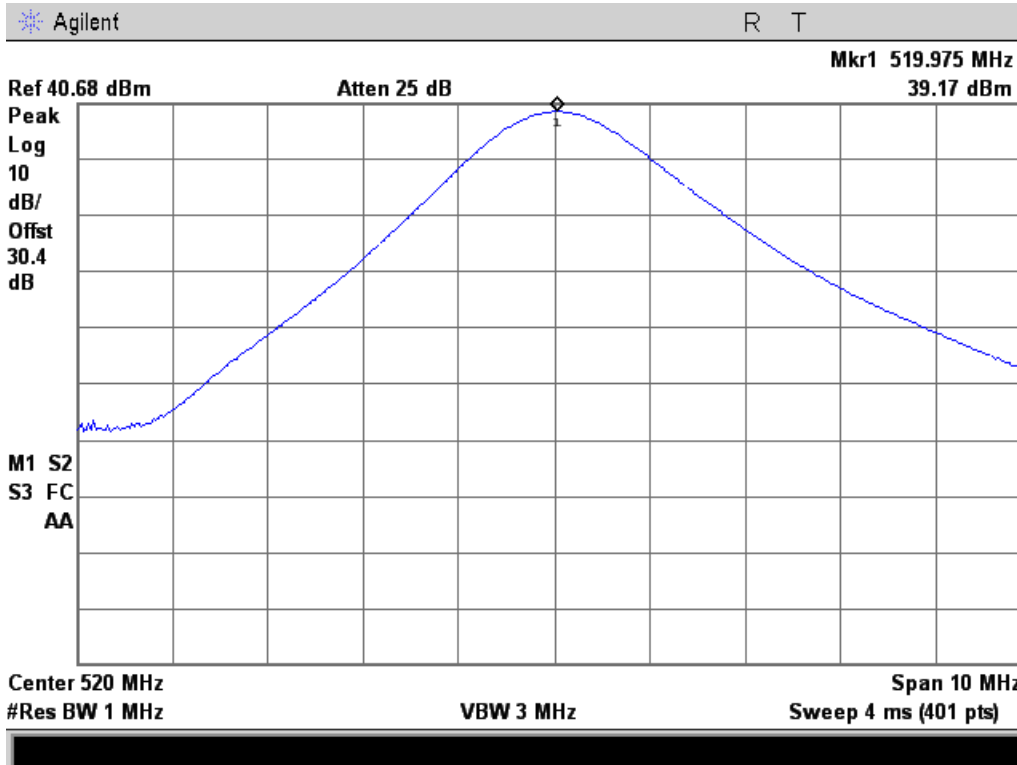

8K10F1D

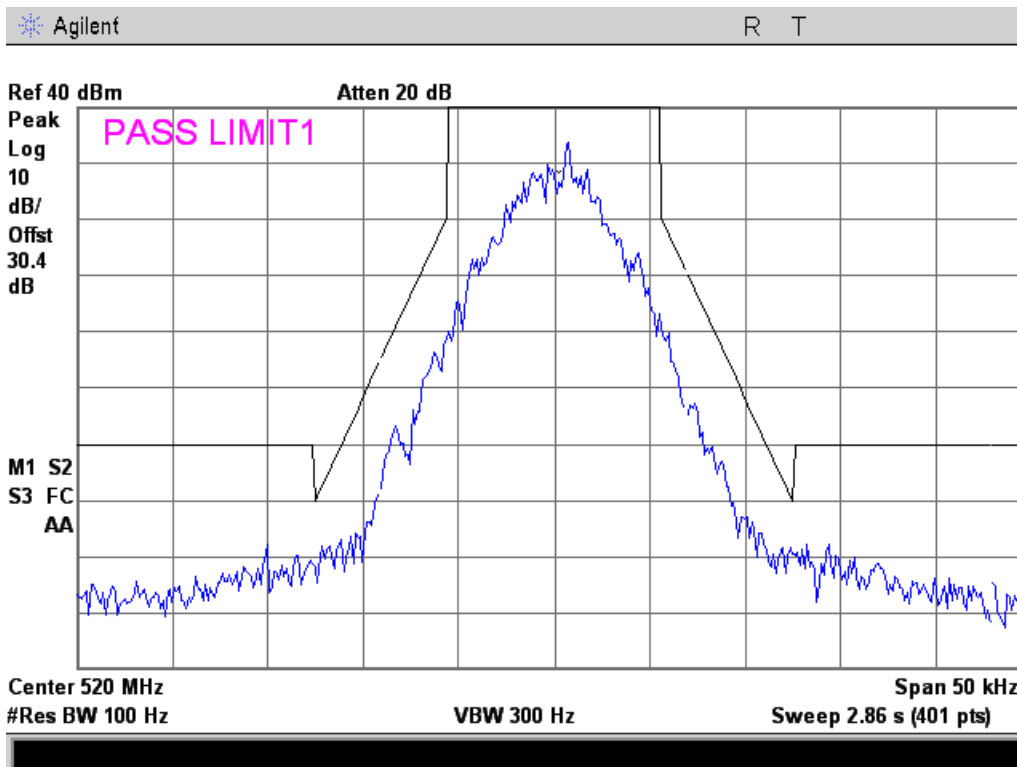



11K0F3E

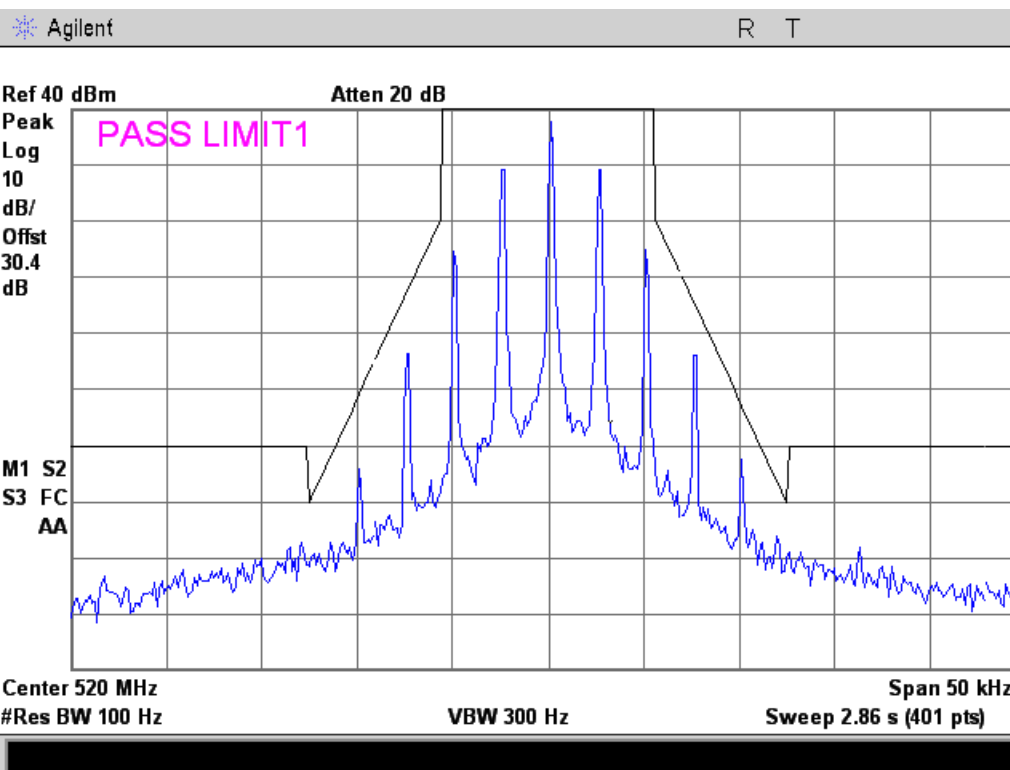

16K0F3E

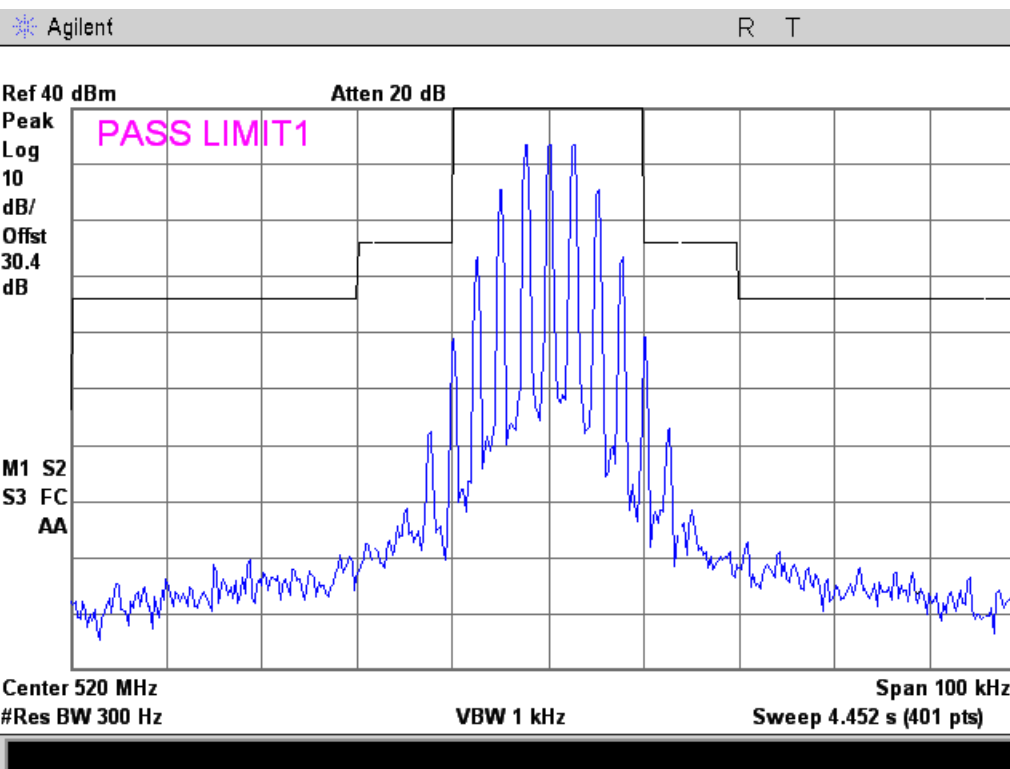



764.05 MHz Reference

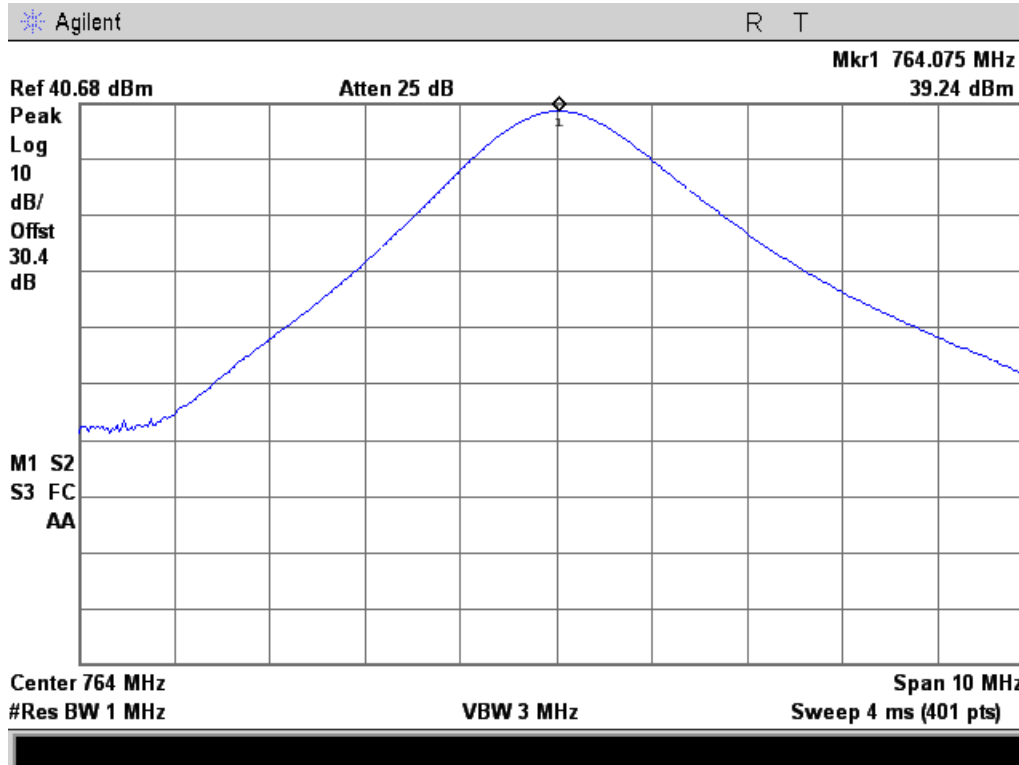

8K10F1D

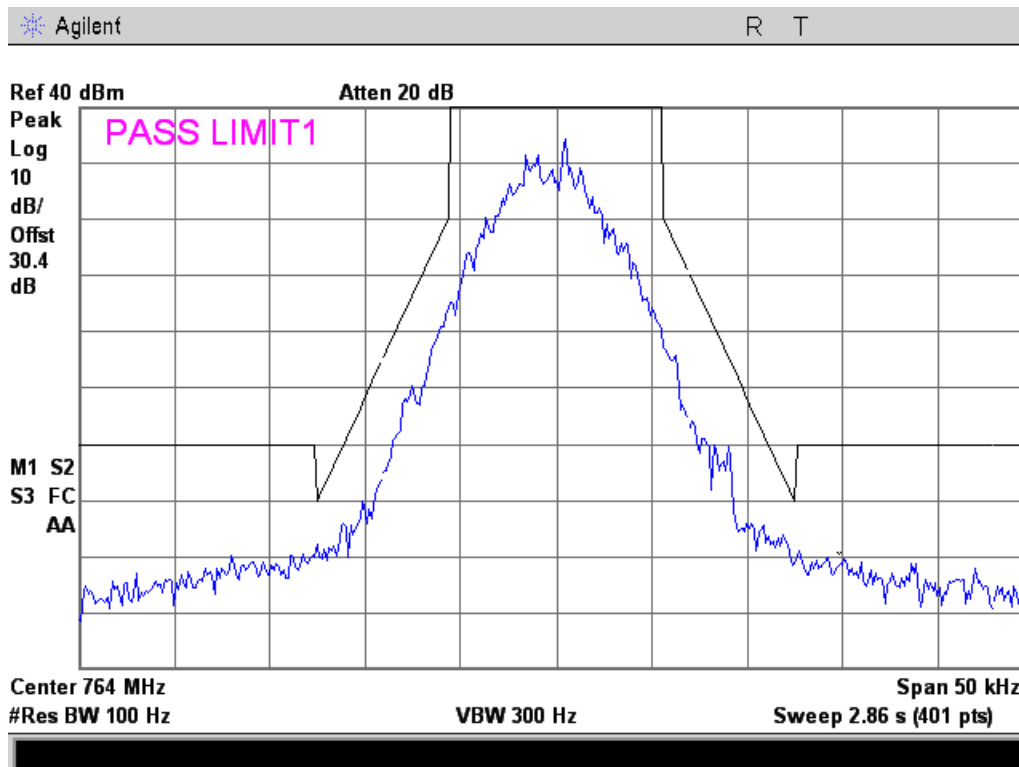



11K0F3E

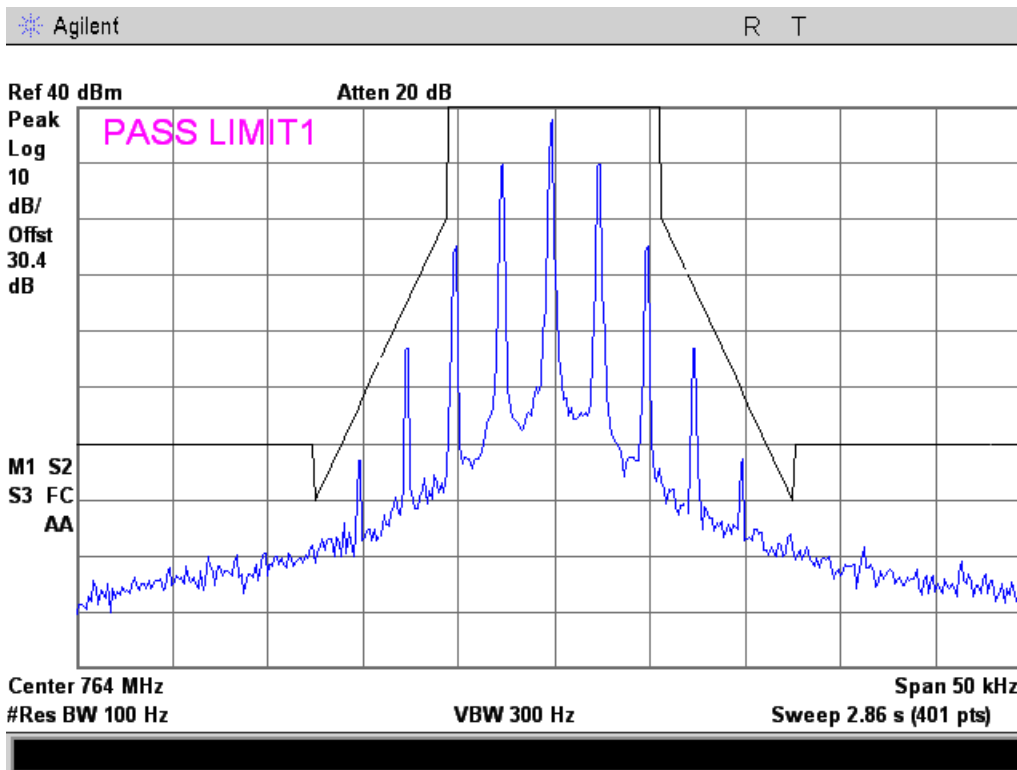

16K0F3E

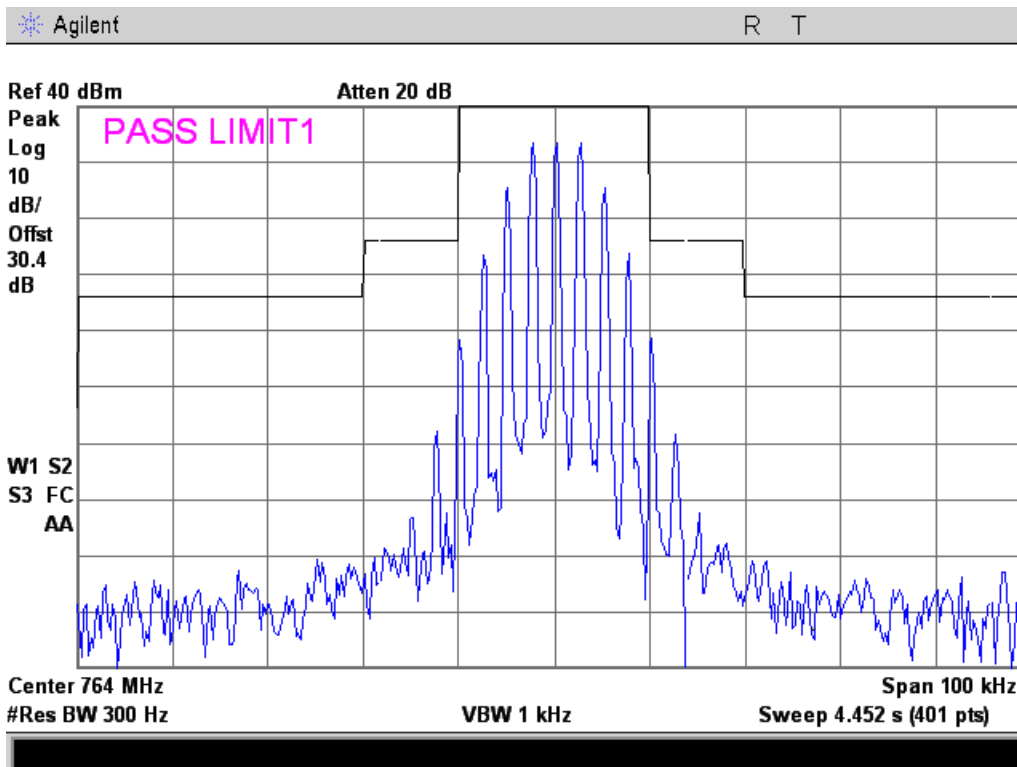



769.95 MHz Reference

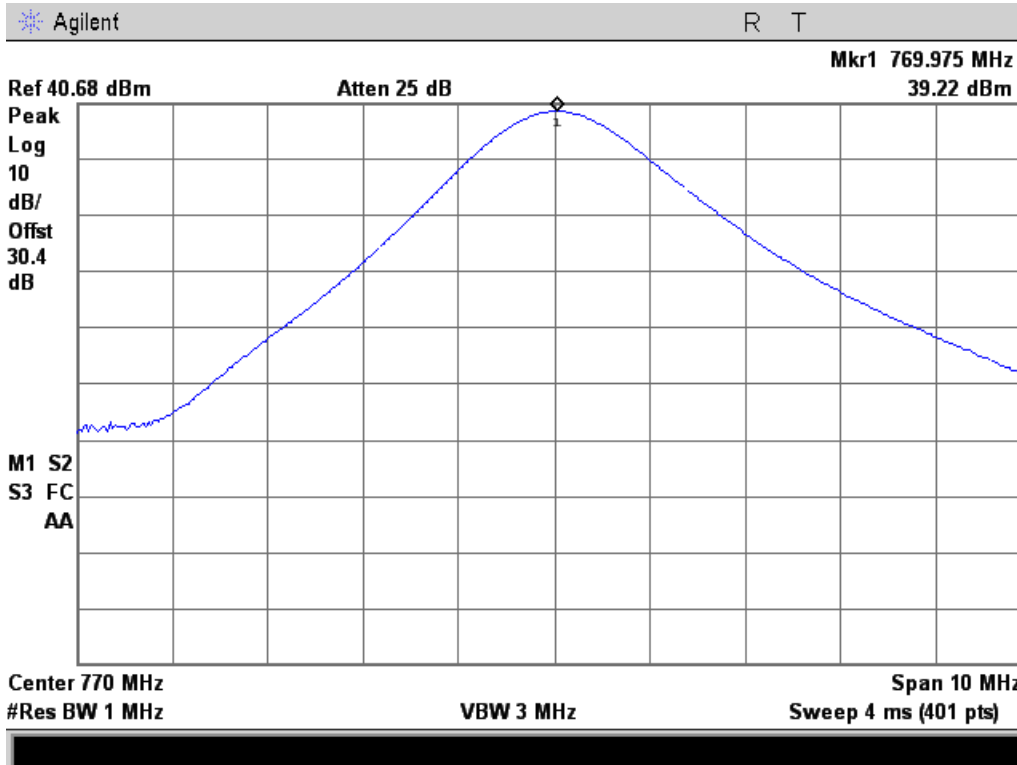

8K10F1D

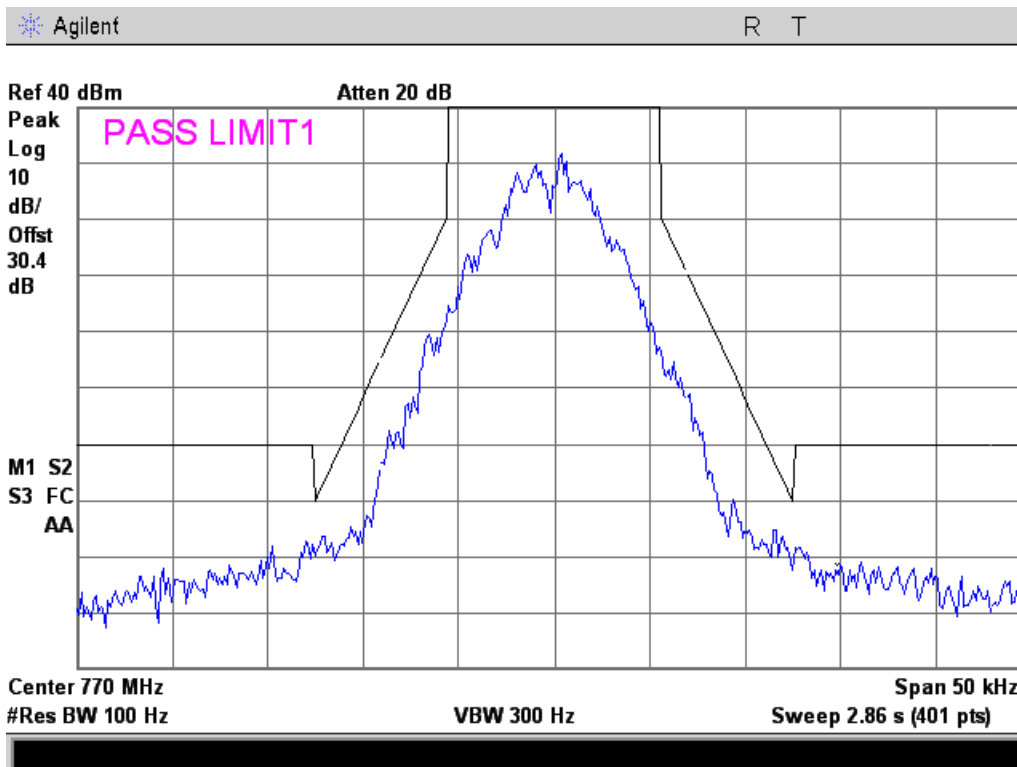



11K0F3E

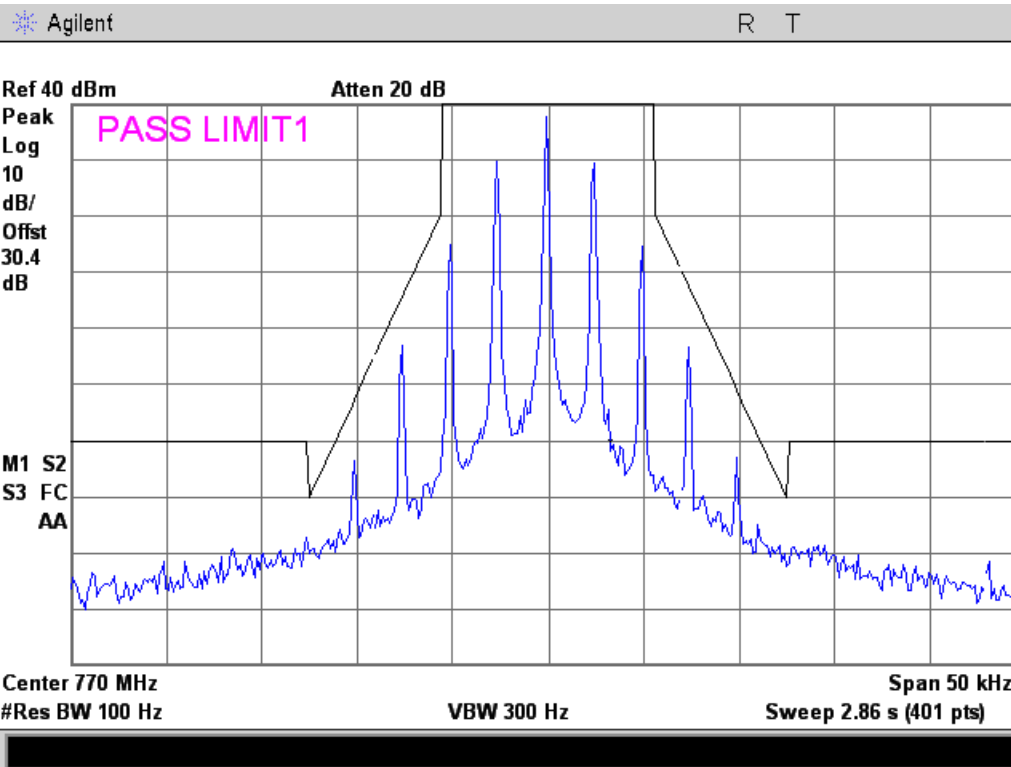

16K0F3E

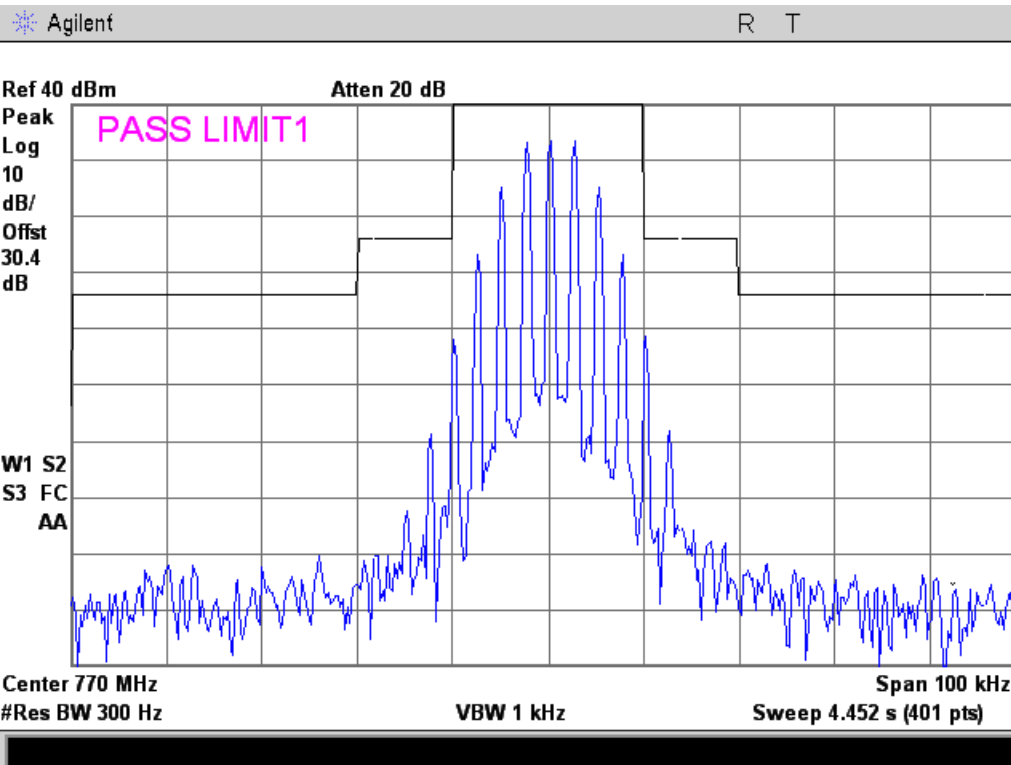



774.95 MHz Reference

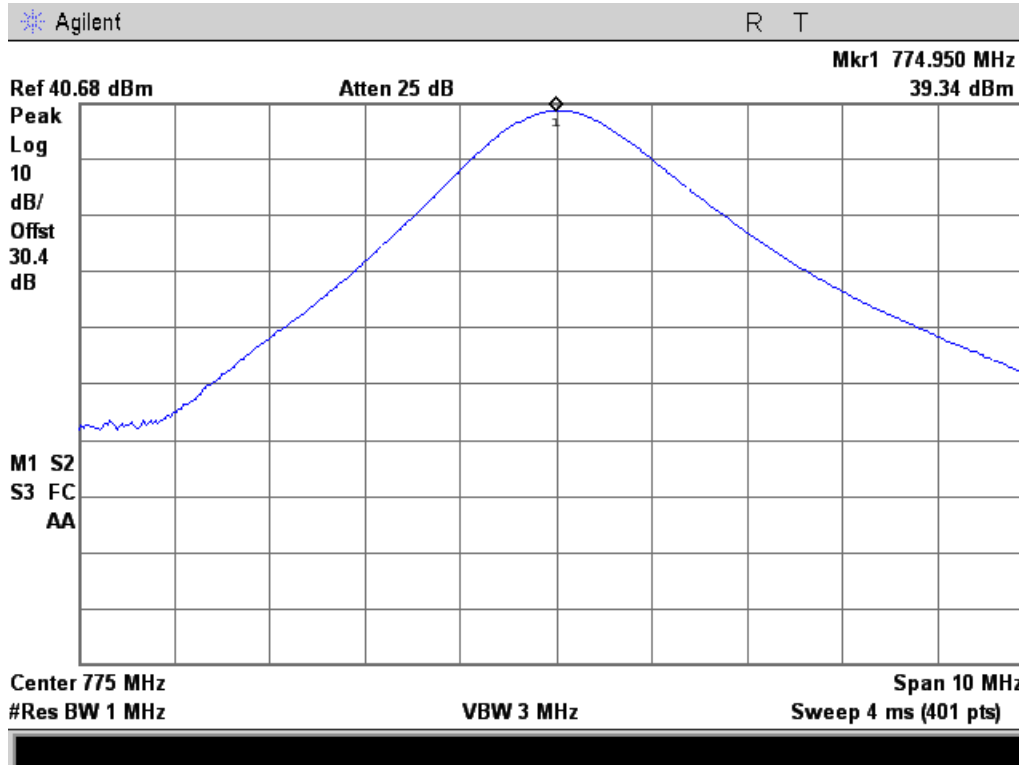

8K10F1D

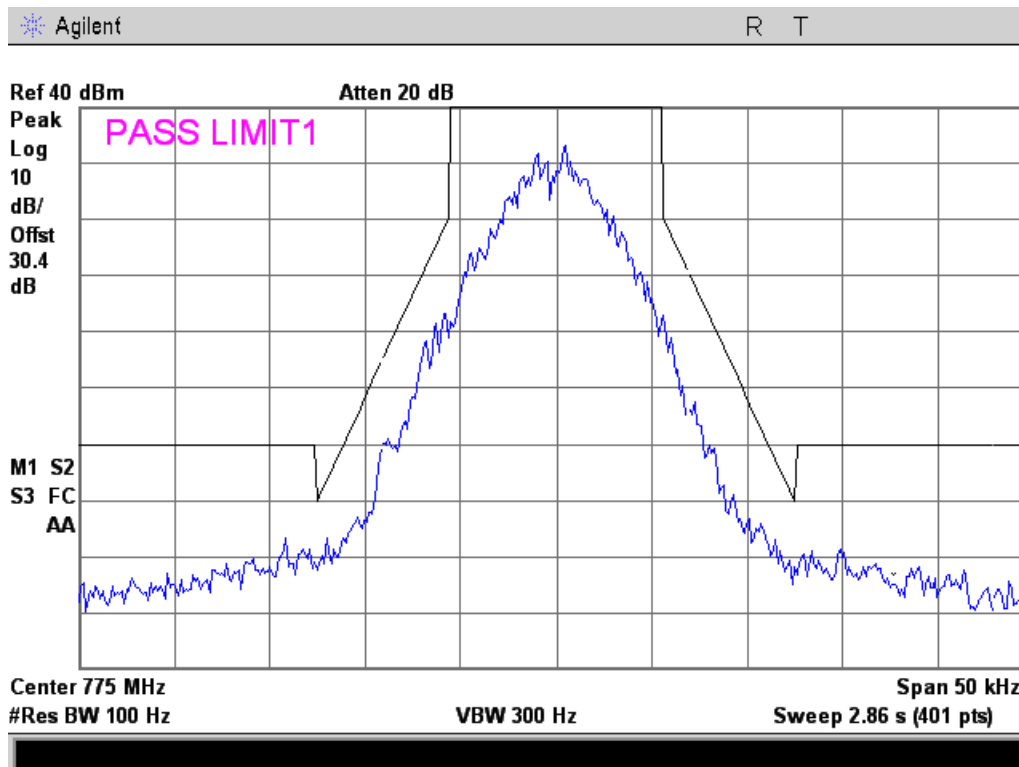



11K0F3E

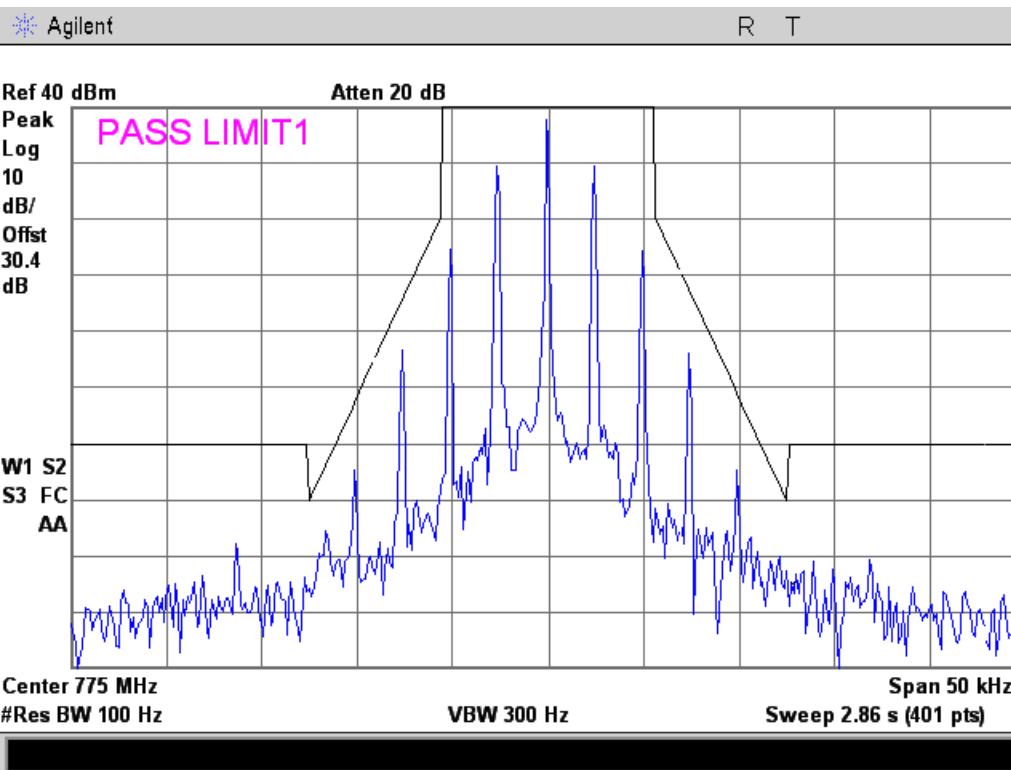

16K0F3E

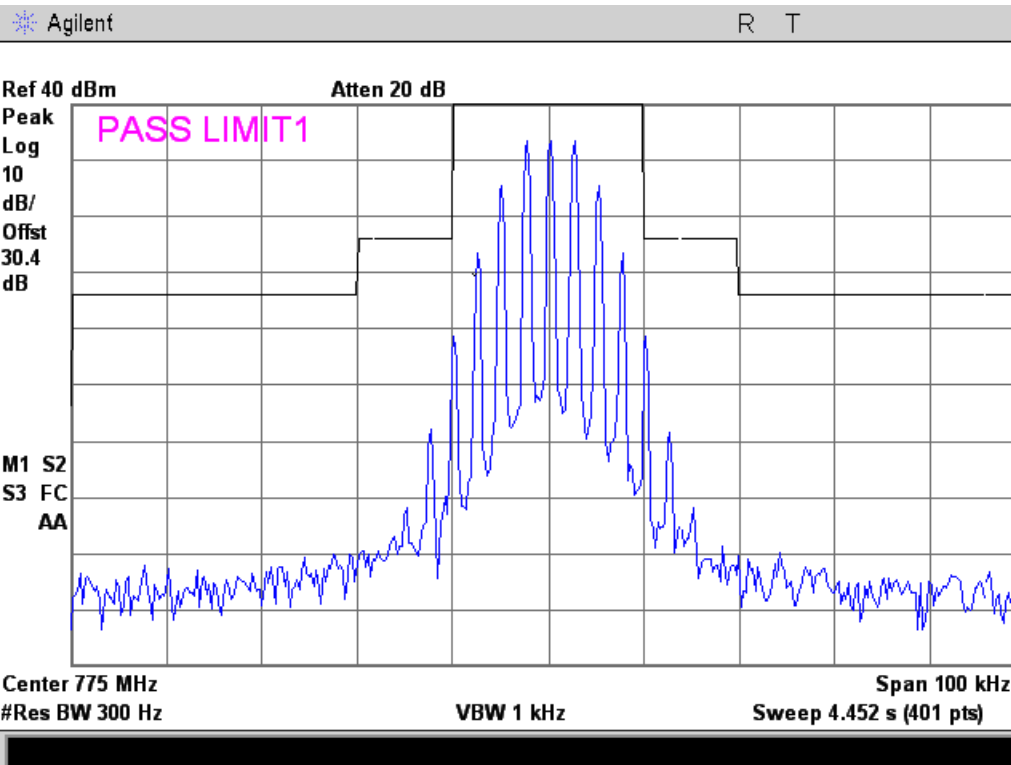



793.05 MHz Reference

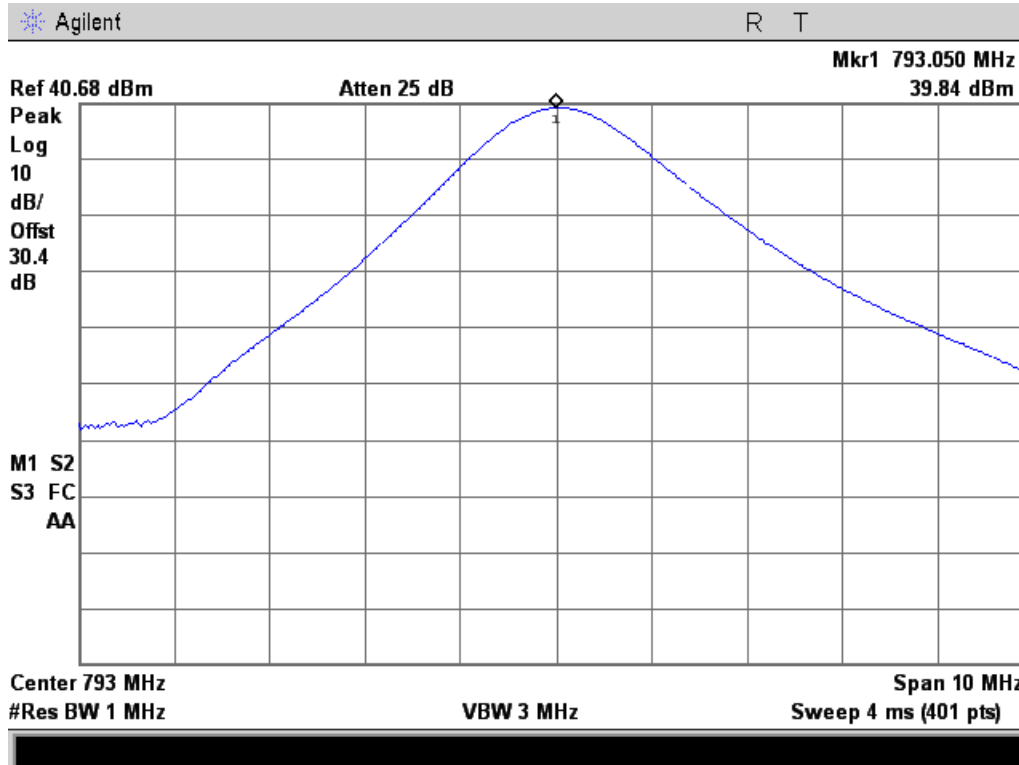

8K10F1D

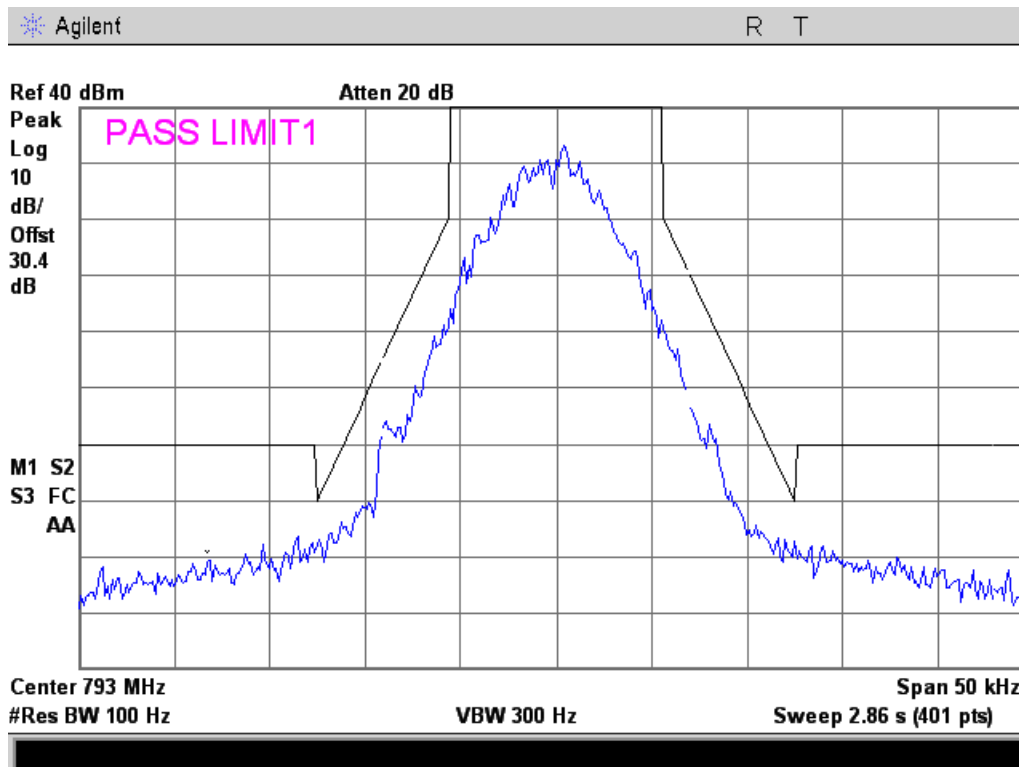



11K0F3E

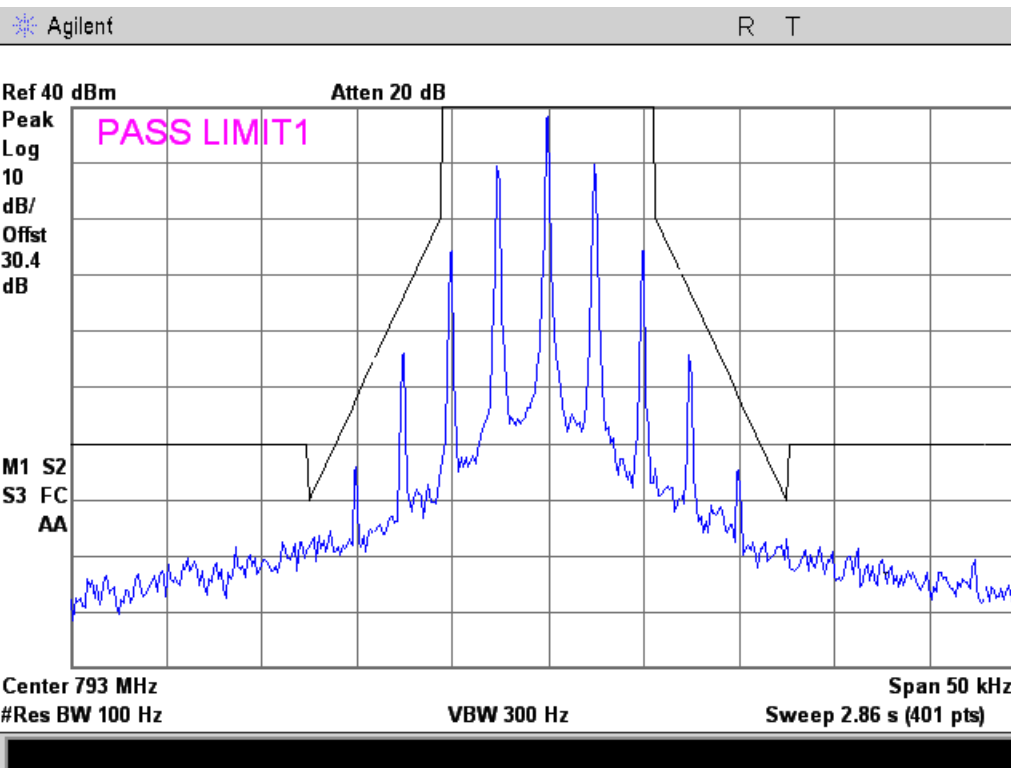

16K0F3E

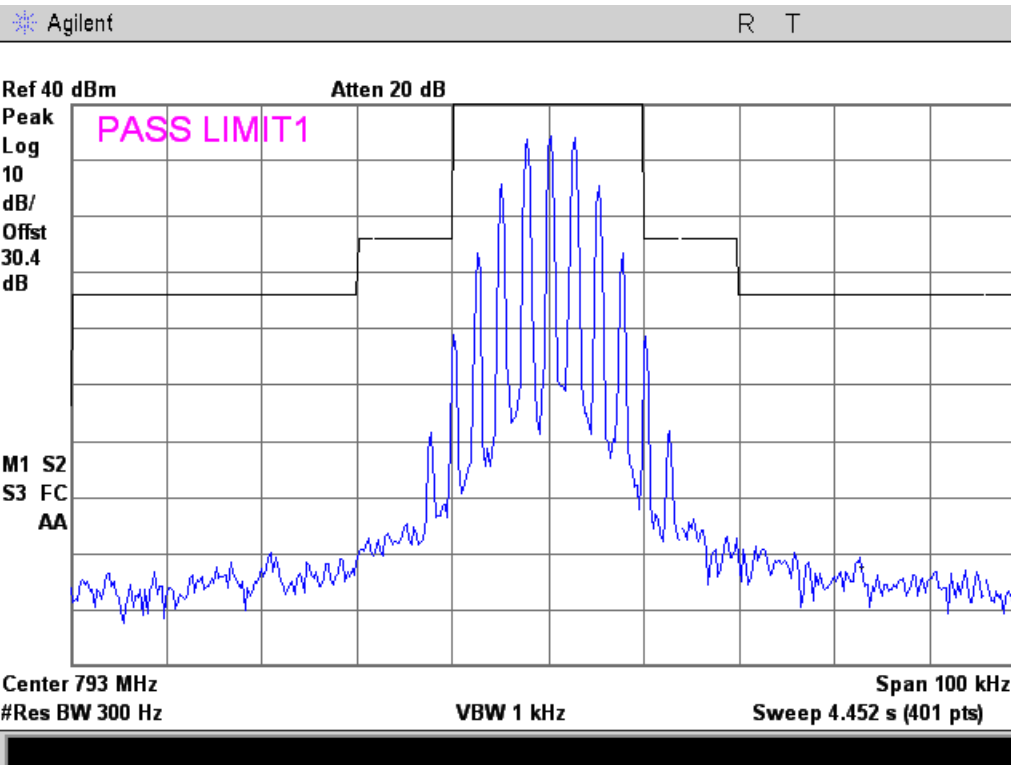



799.95 MHz Reference

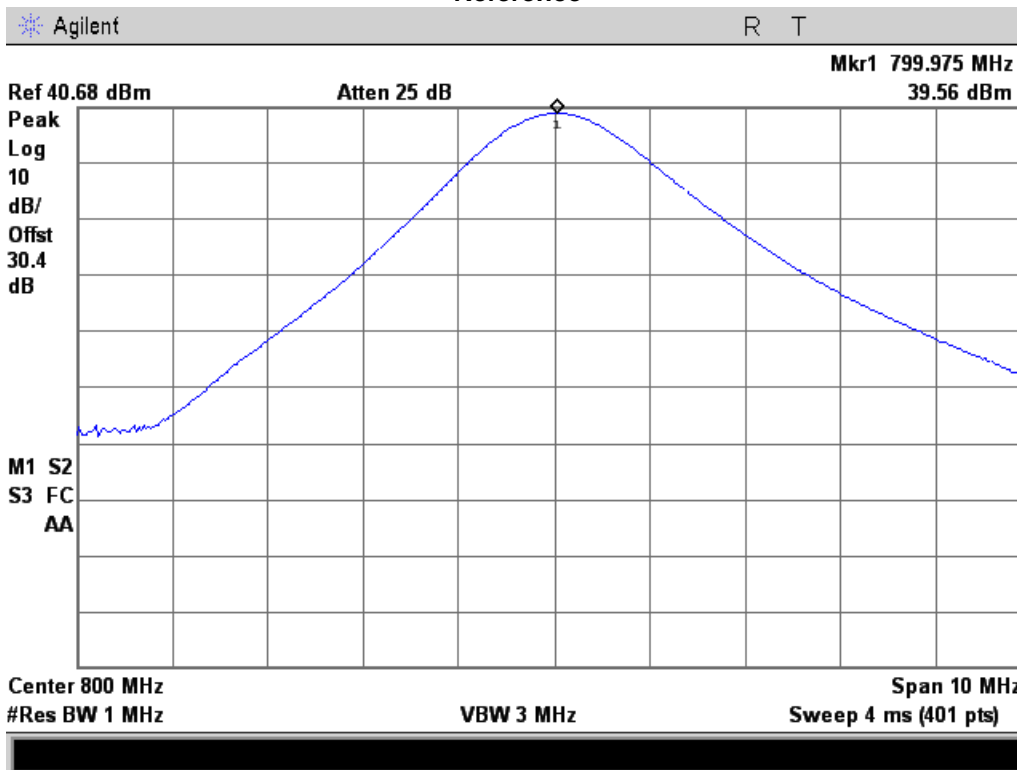

8K10F1D

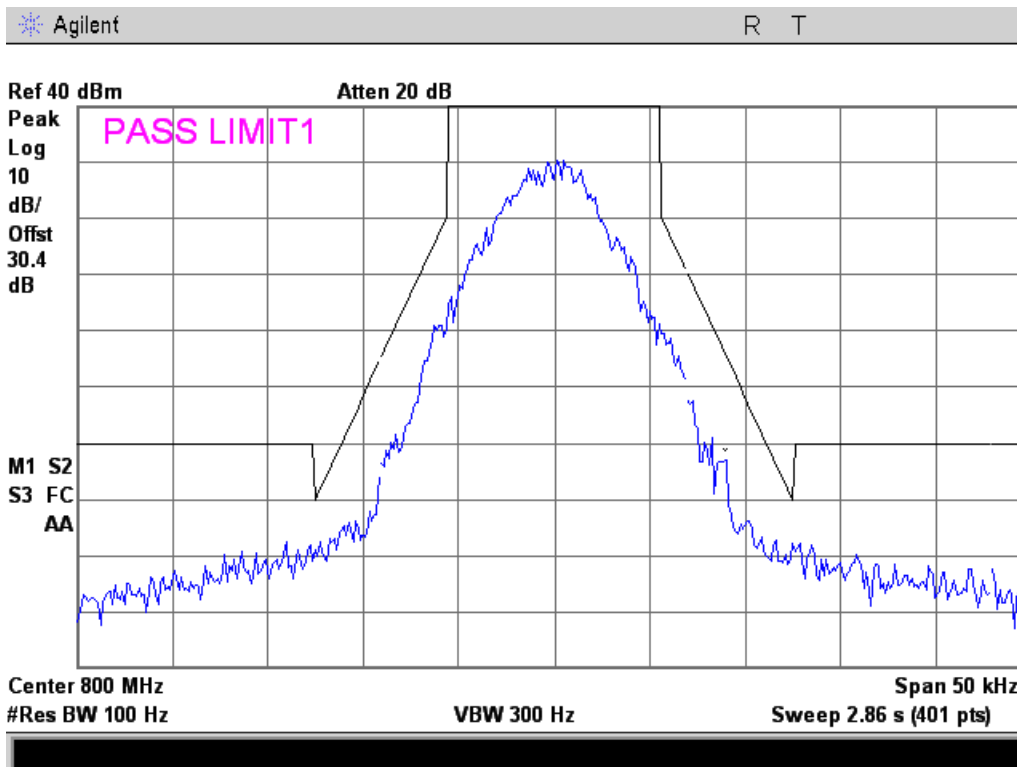



11K0F3E

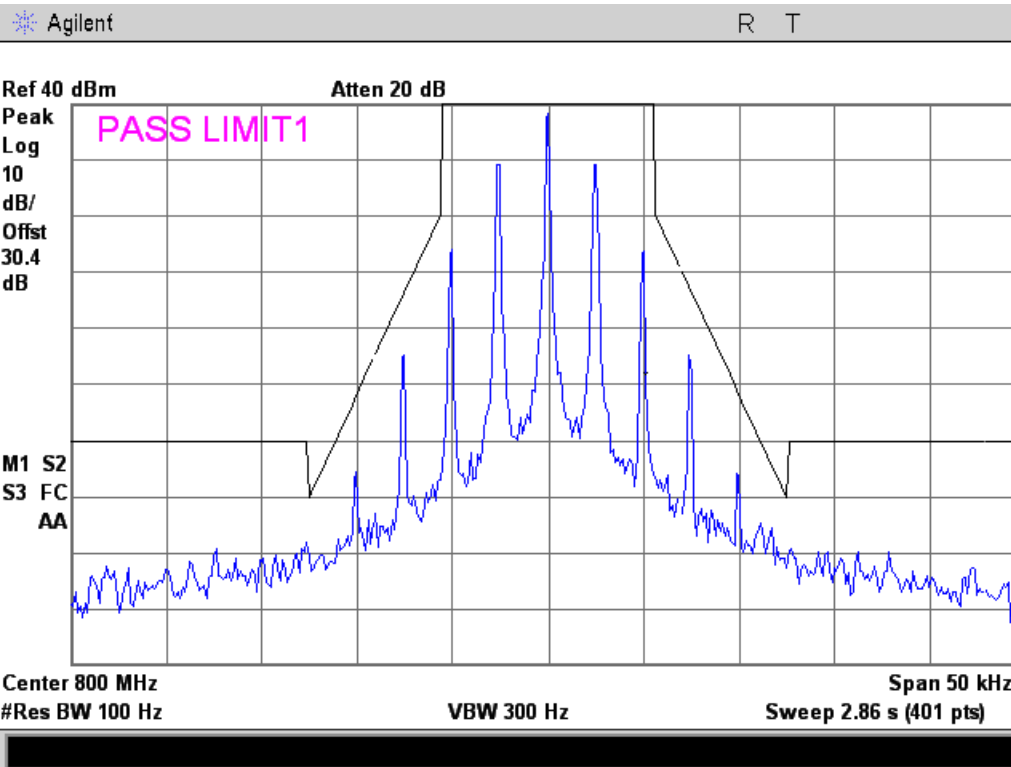

16K0F3E

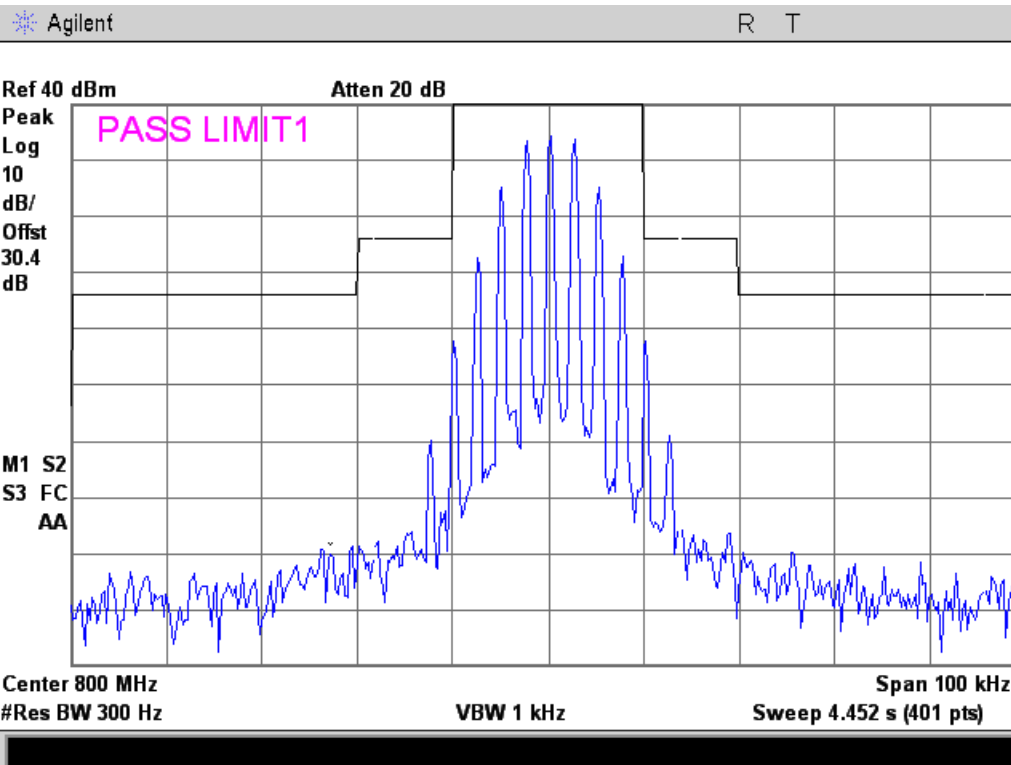



804.95 MHz Reference

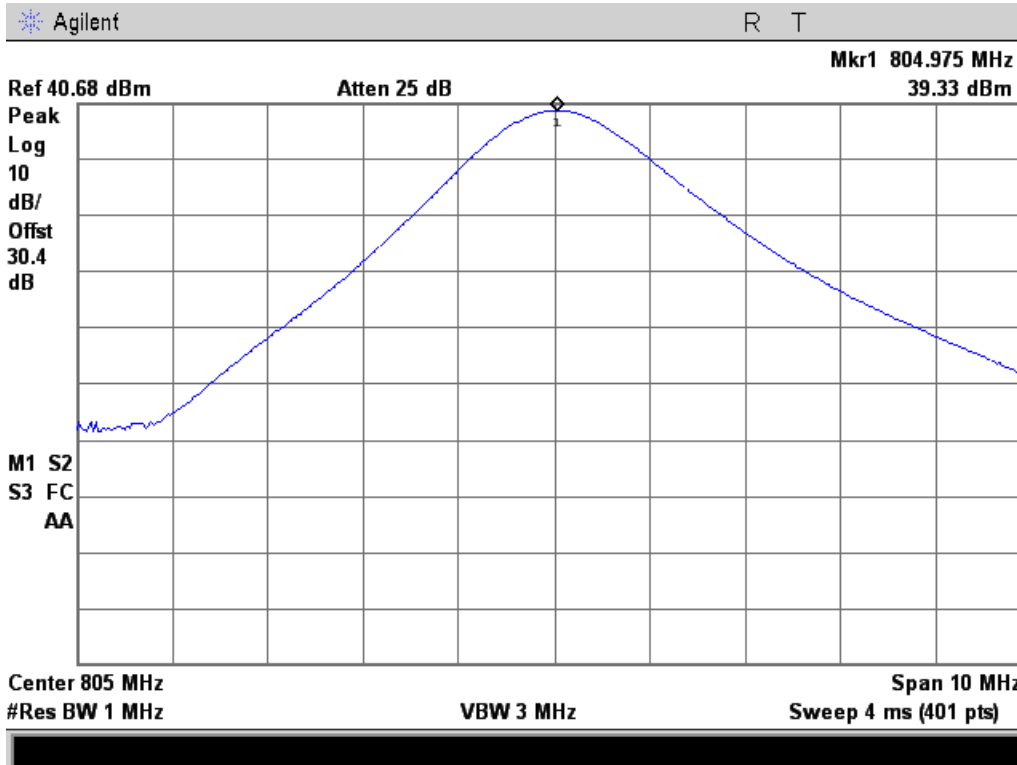

8K10F1D

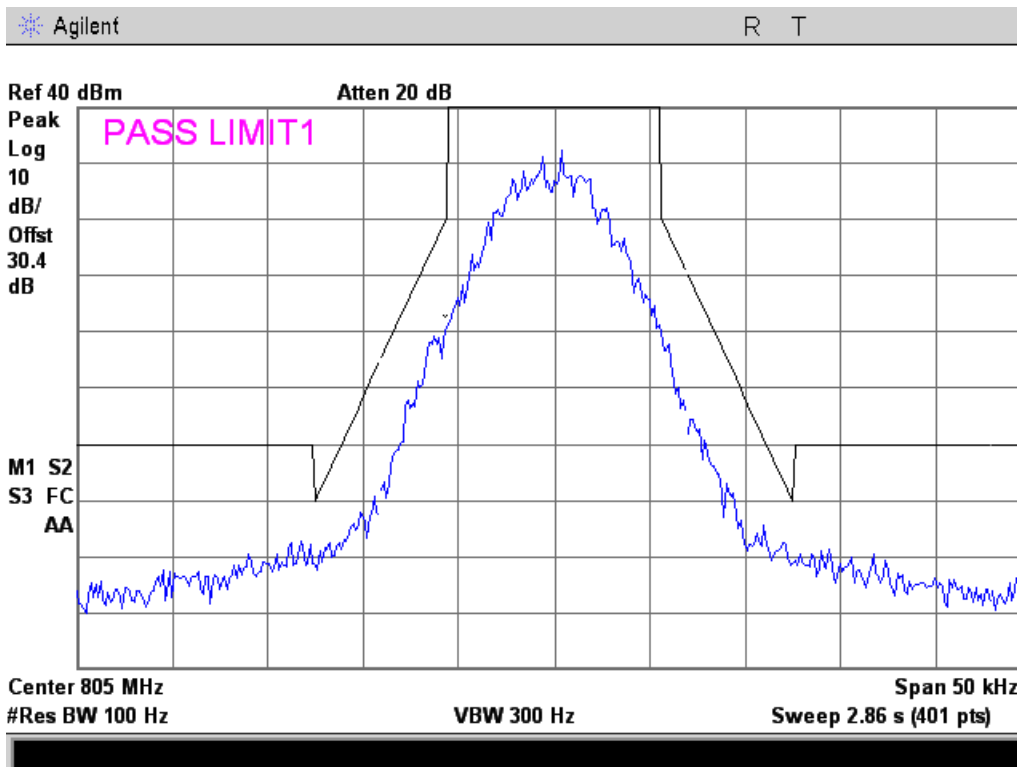



11K0F3E

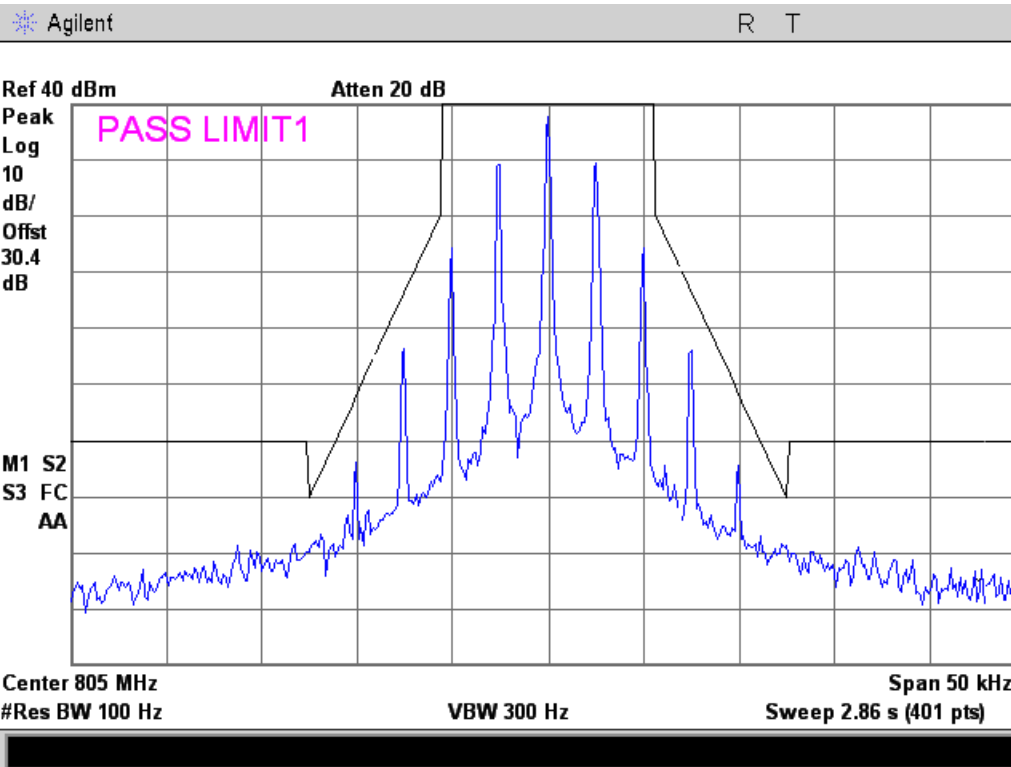

16K0F3E

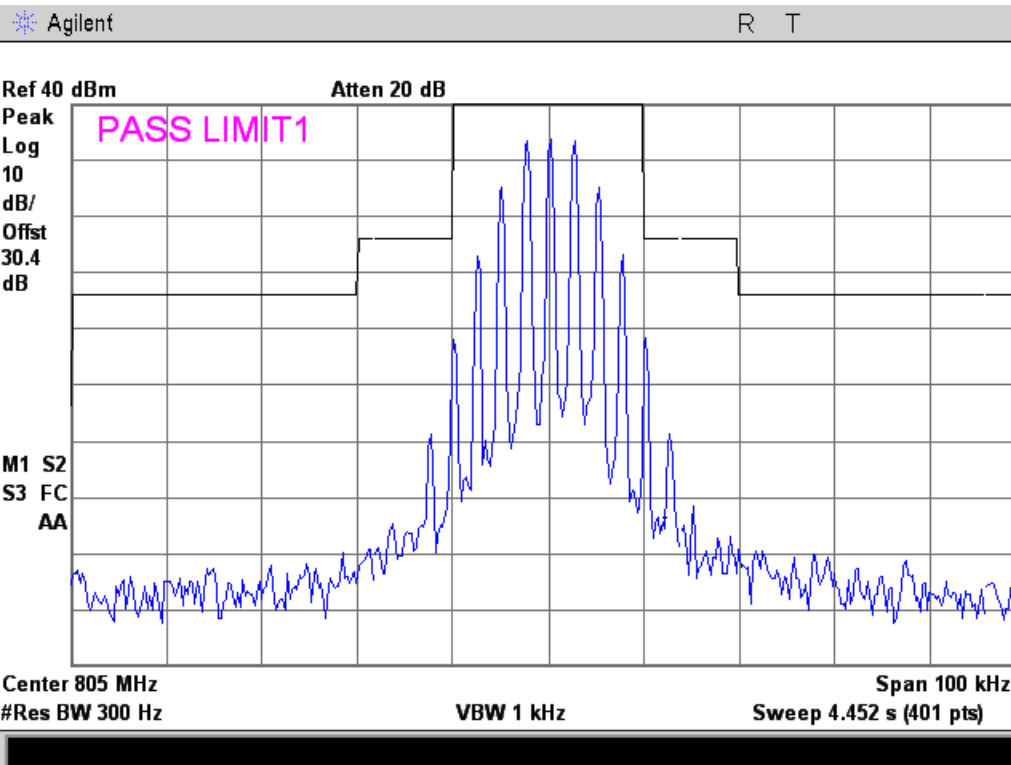



806.05 MHz Reference

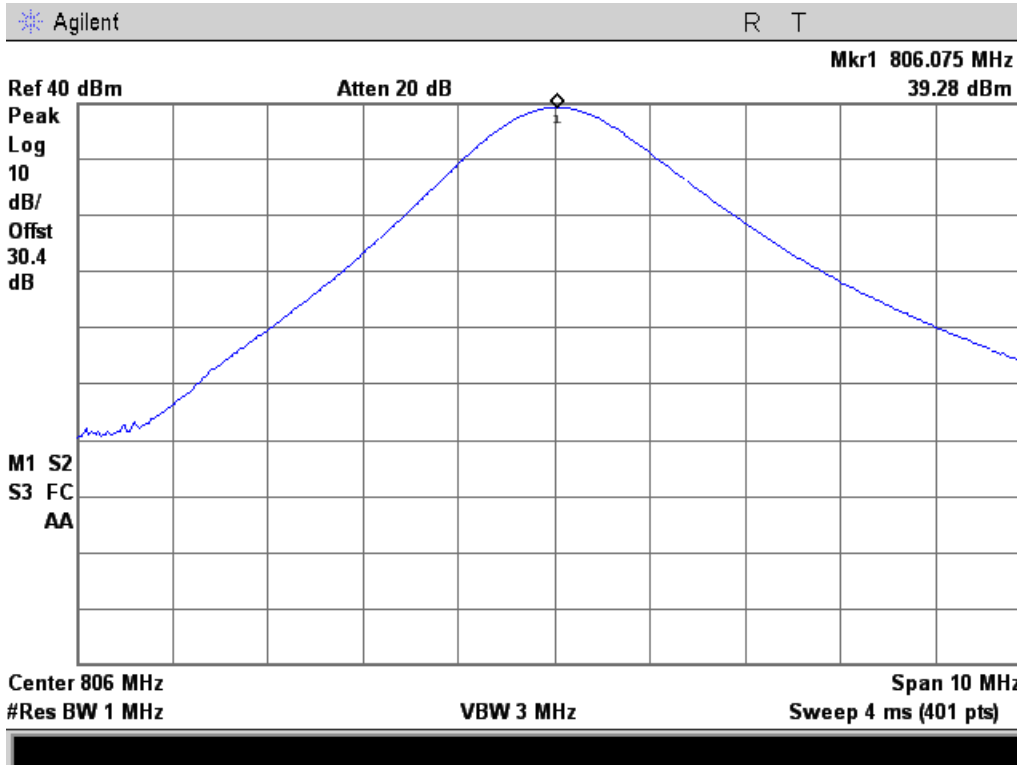

8K10F1D

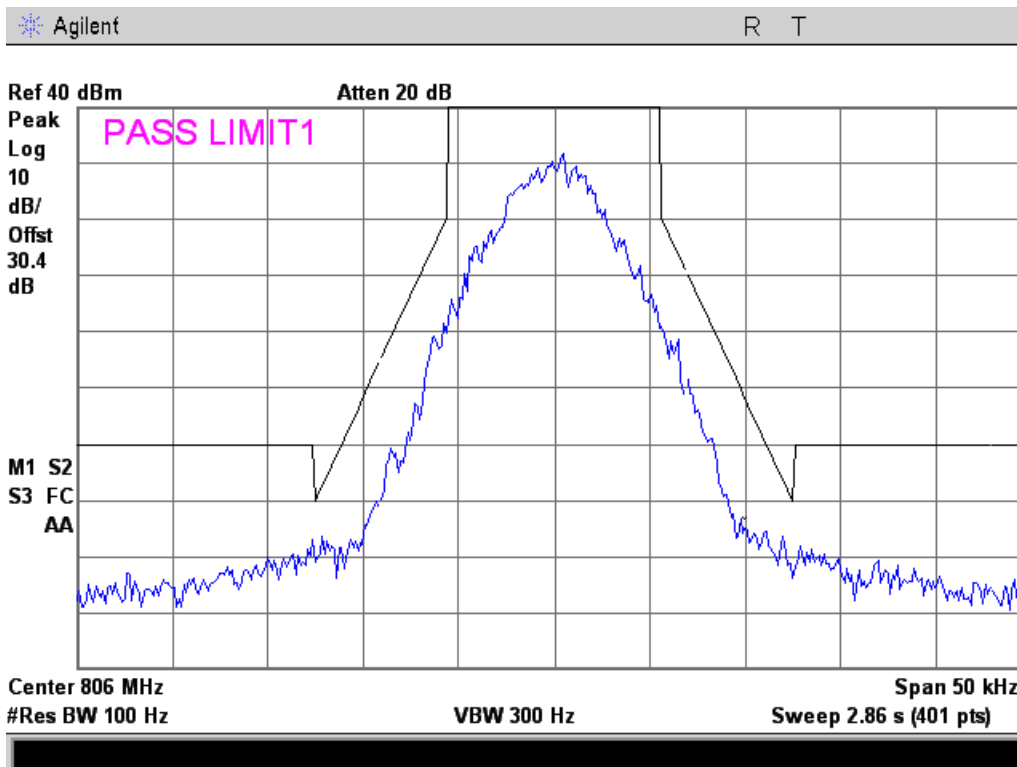



11K0F3E

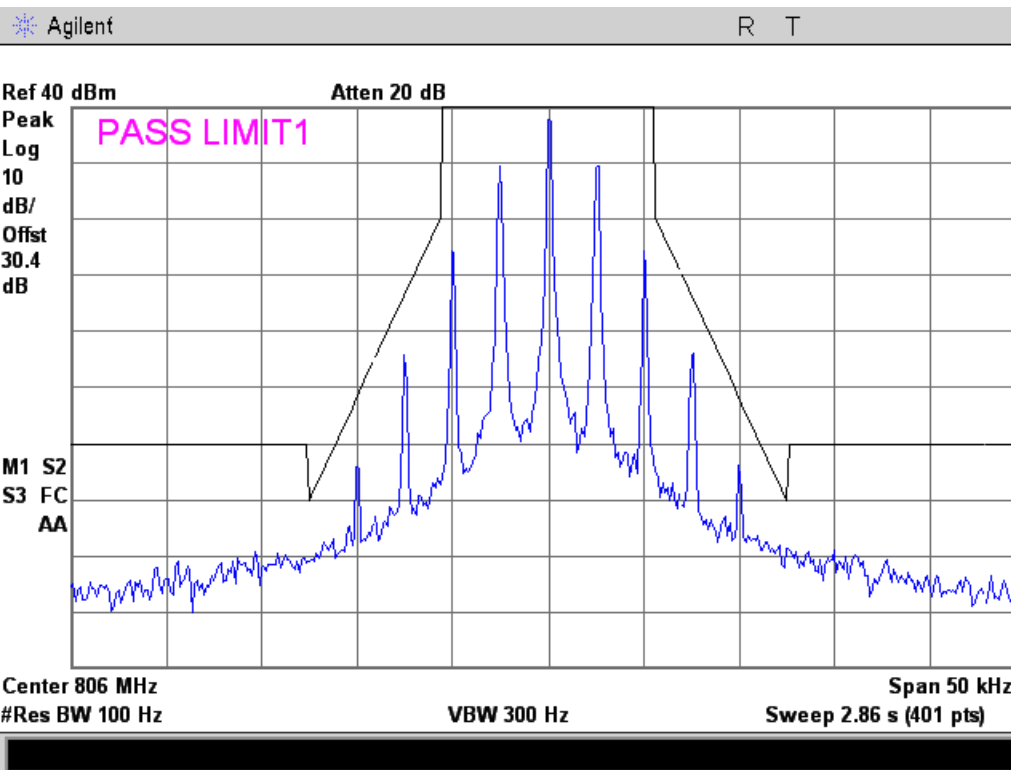

16K0F3E

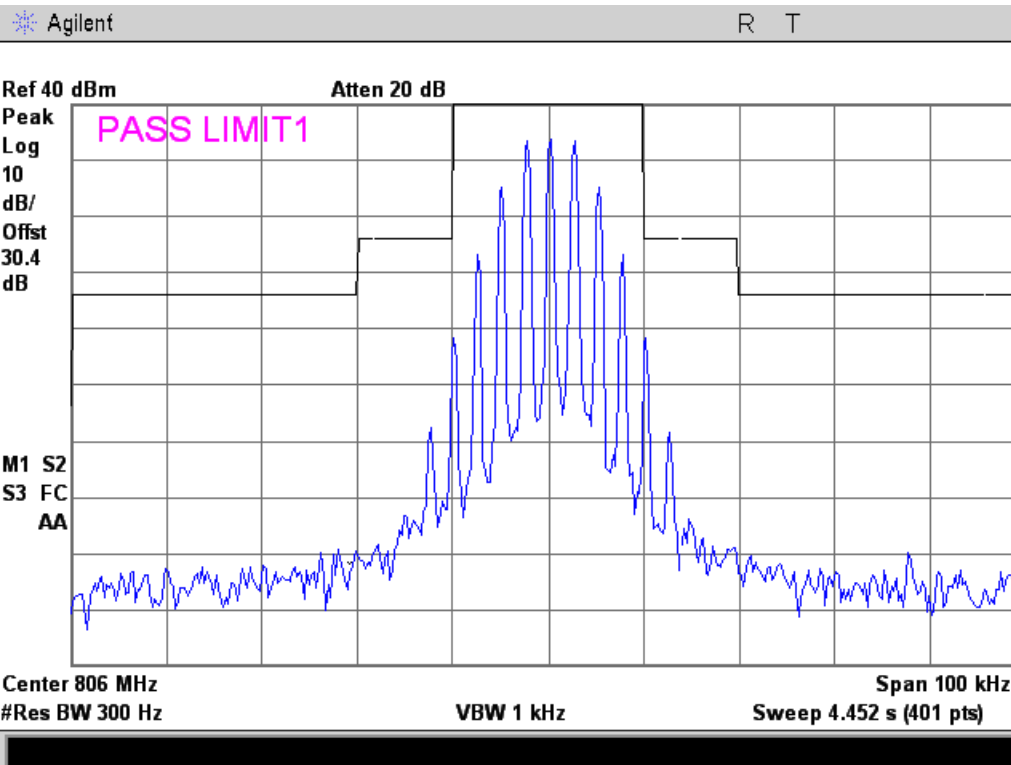



809.05 MHz Reference

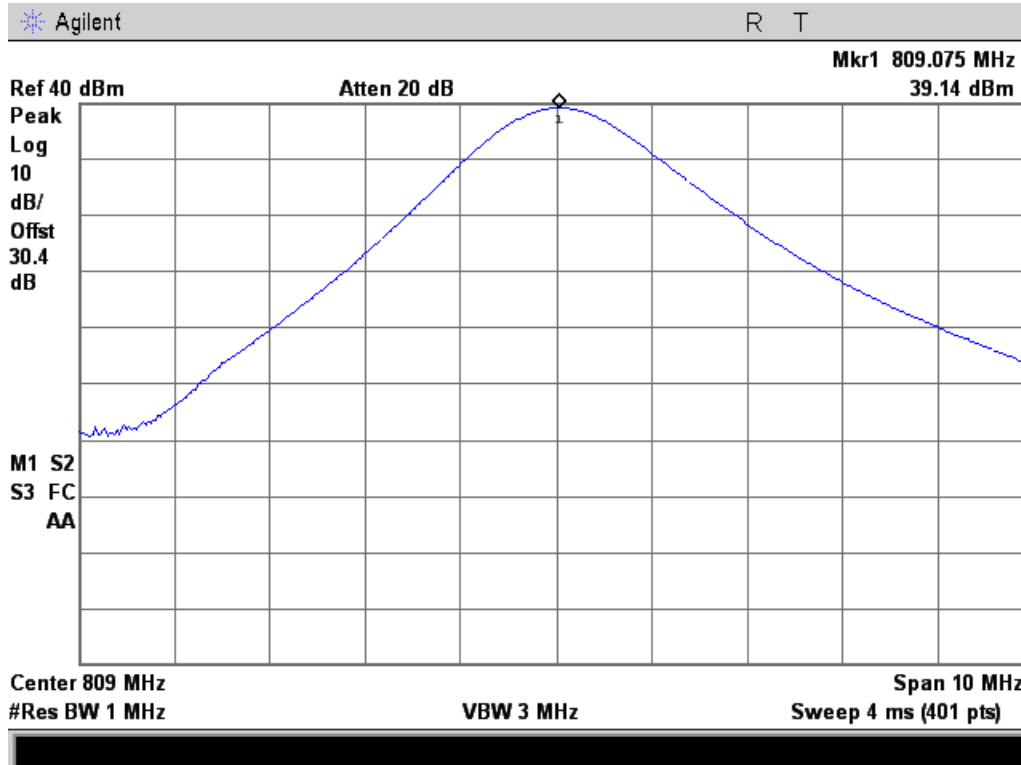

8K10F1D

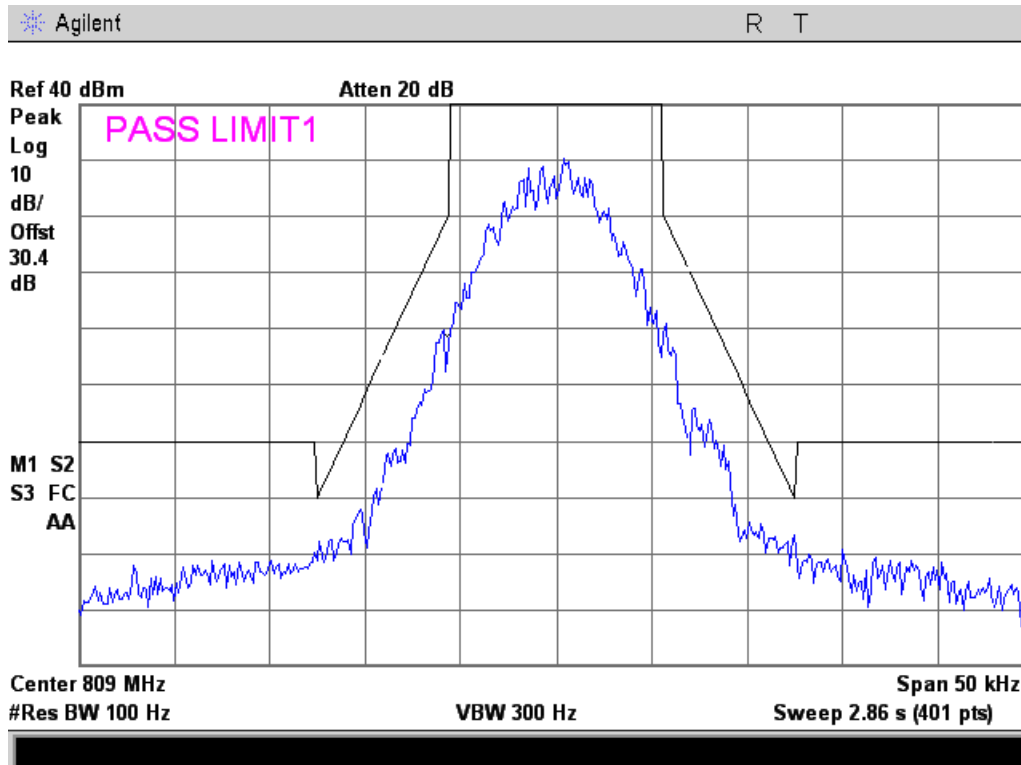



11K0F3E

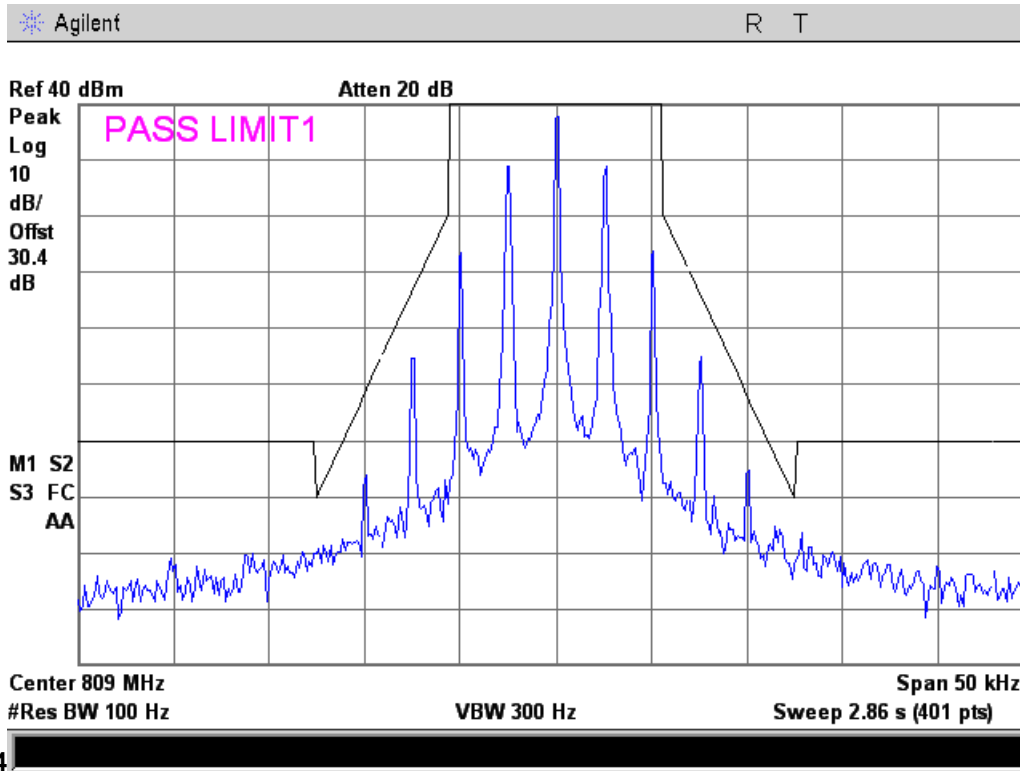

16K0F3E

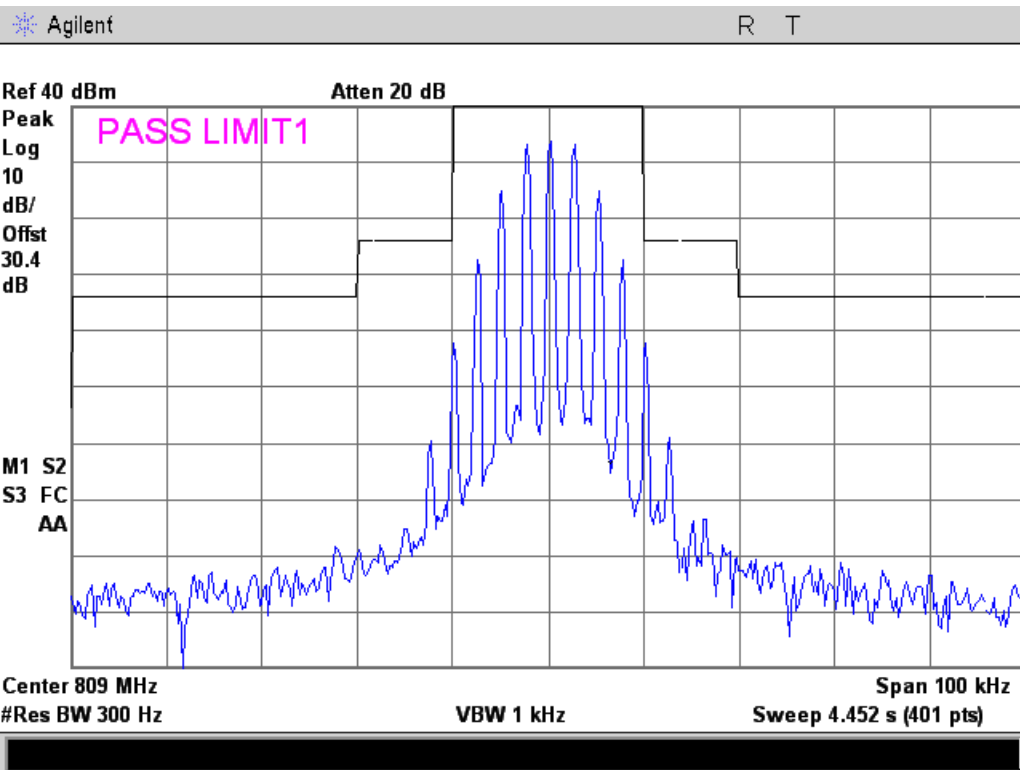



827.05 MHz Reference

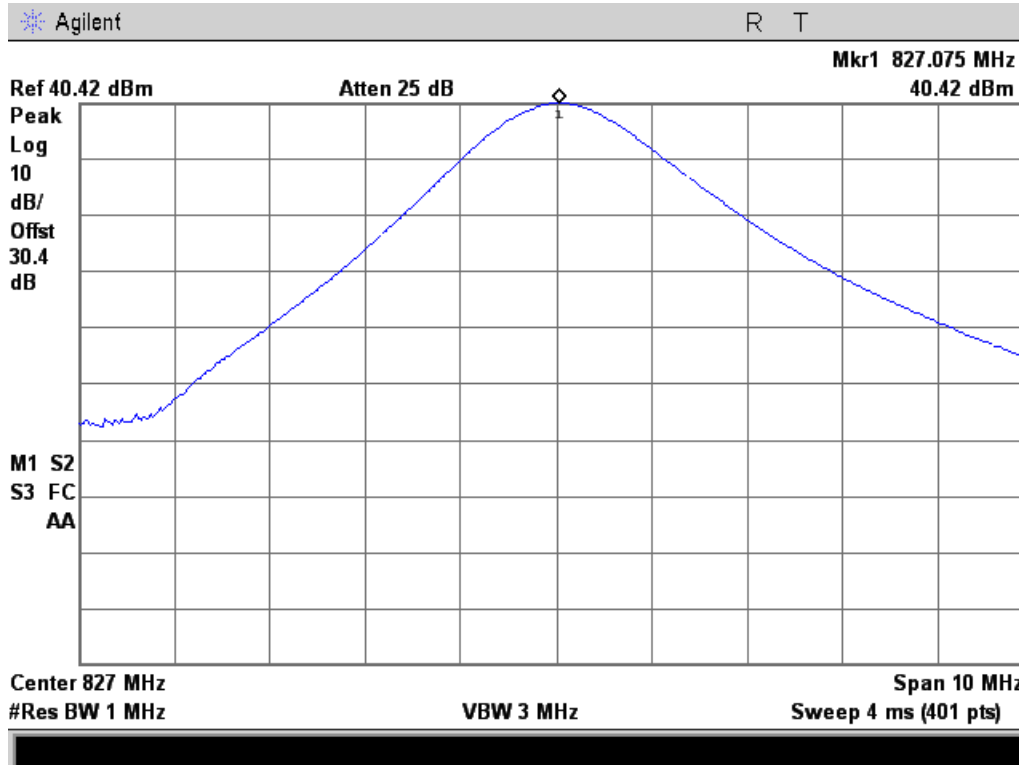

8K10F1D

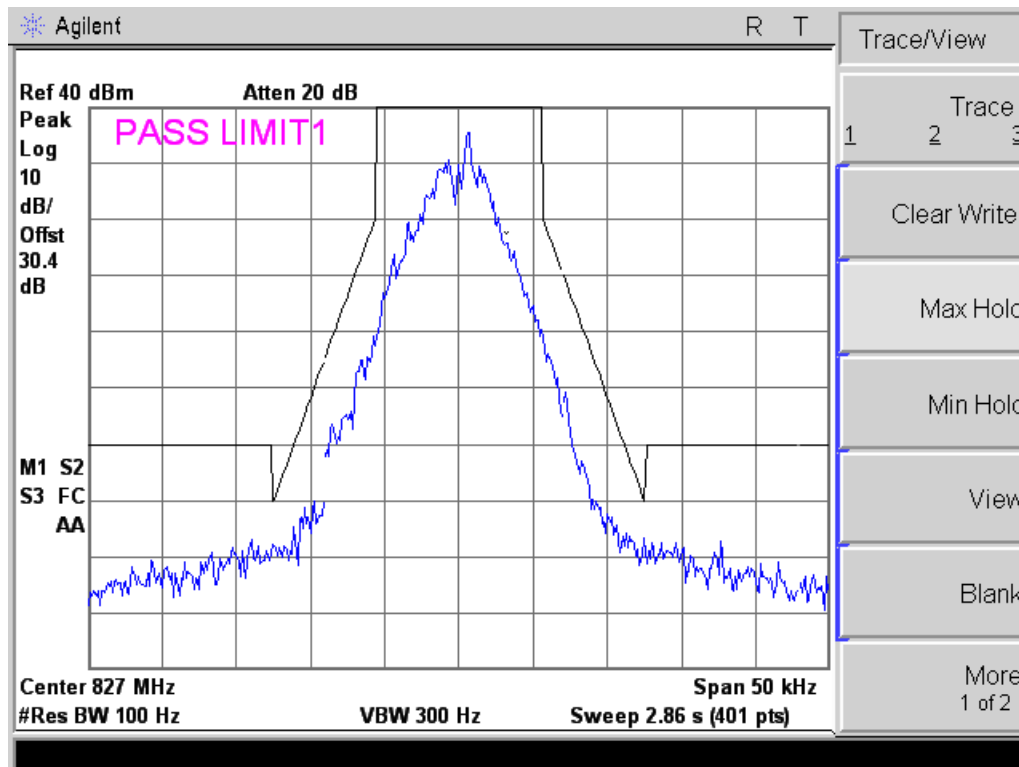



11K0F3E

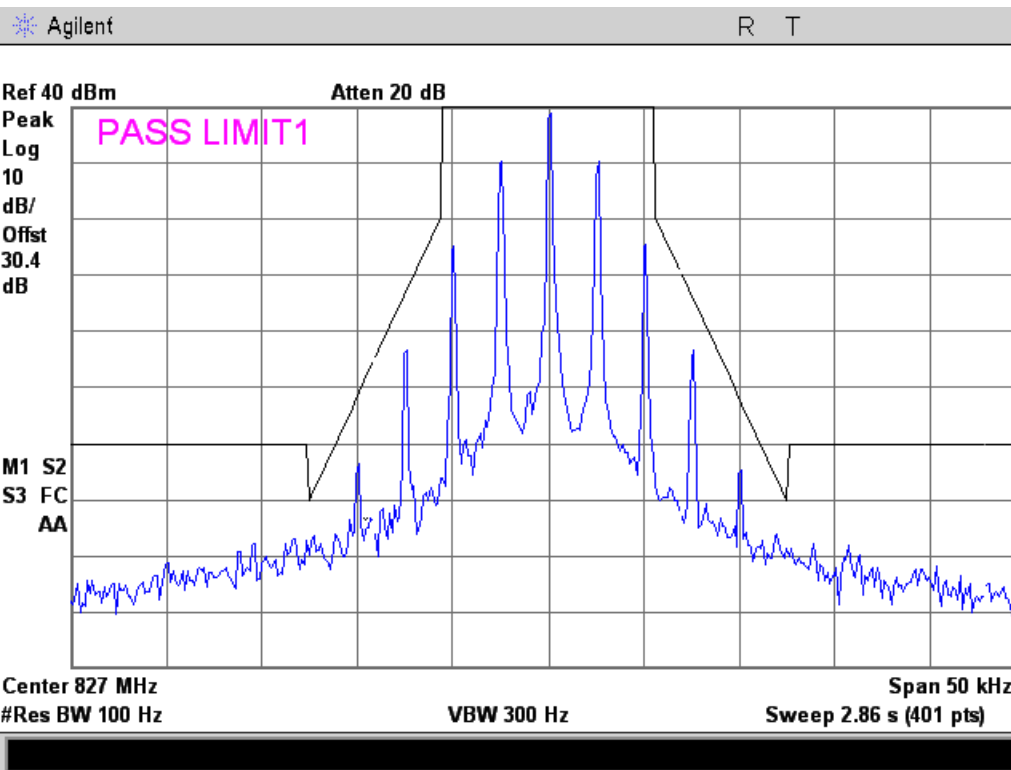

16K0F3E

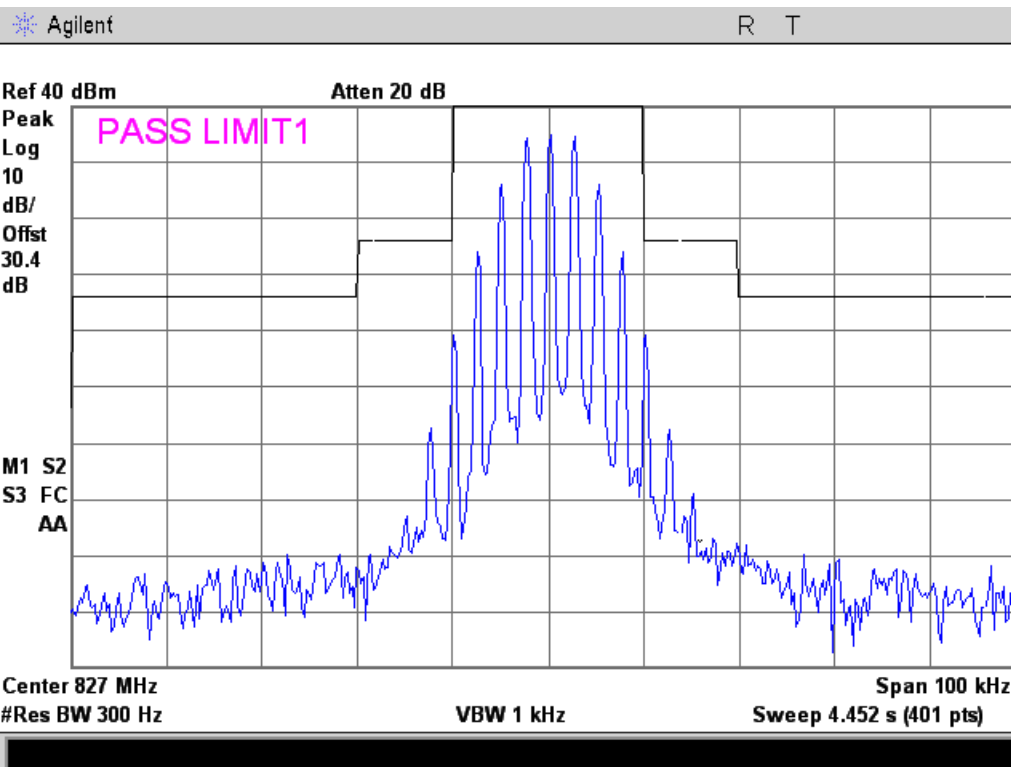



848.95 MHz Reference

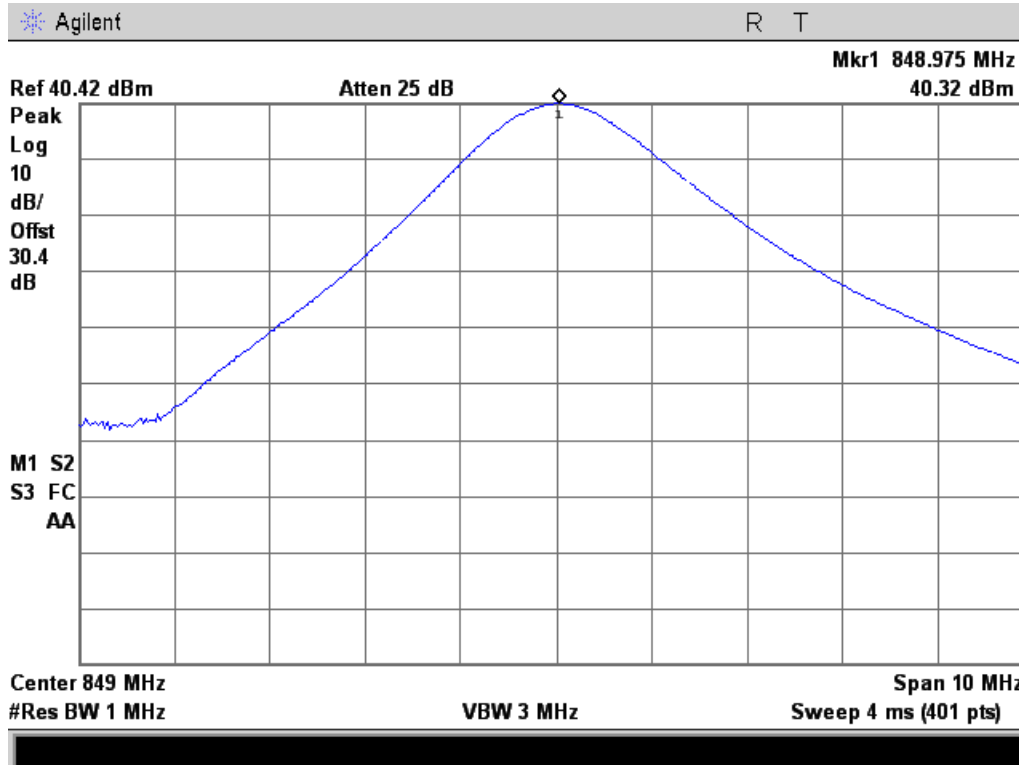

8K10F1D

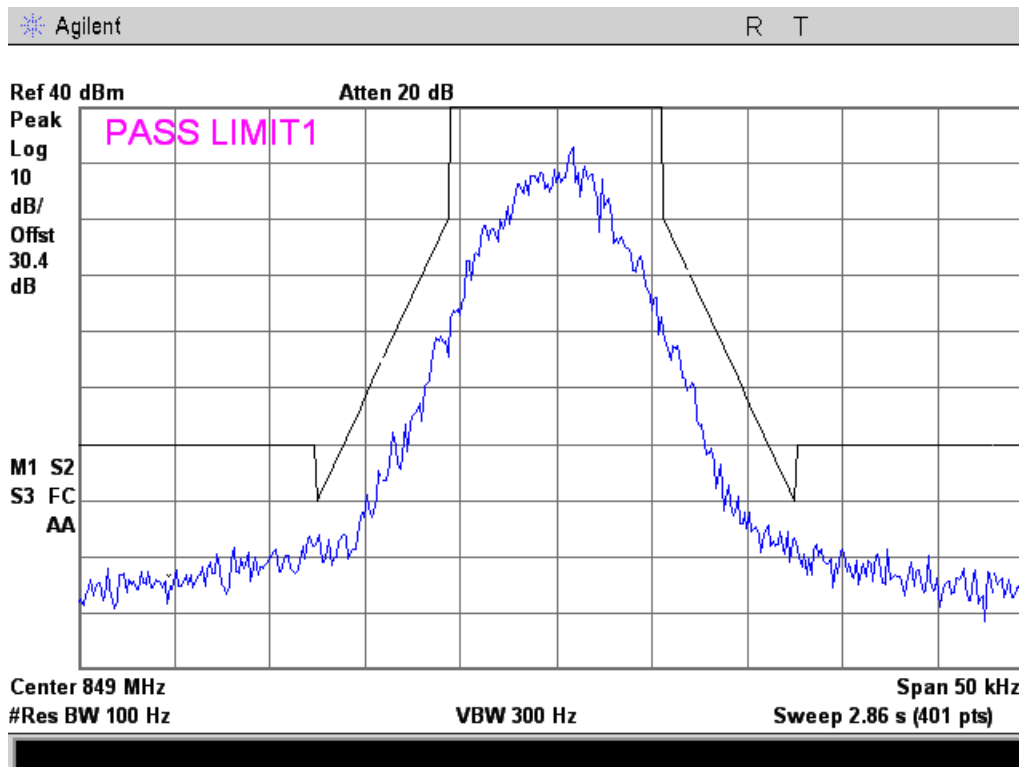



11K0F3E

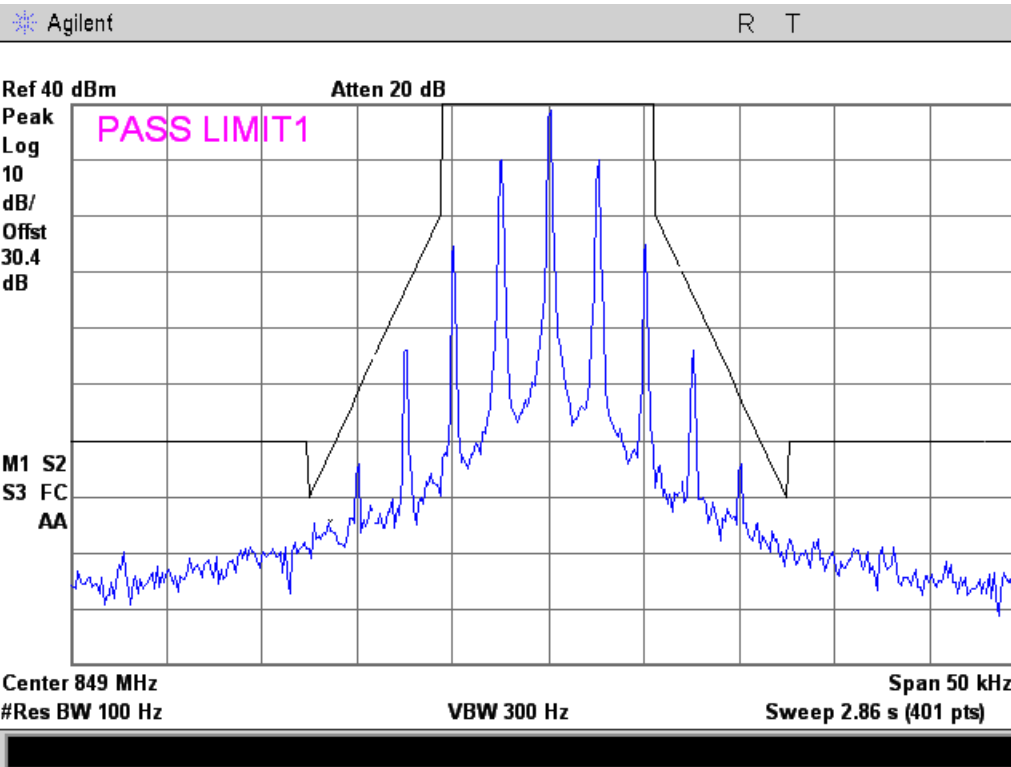

16K0F3E

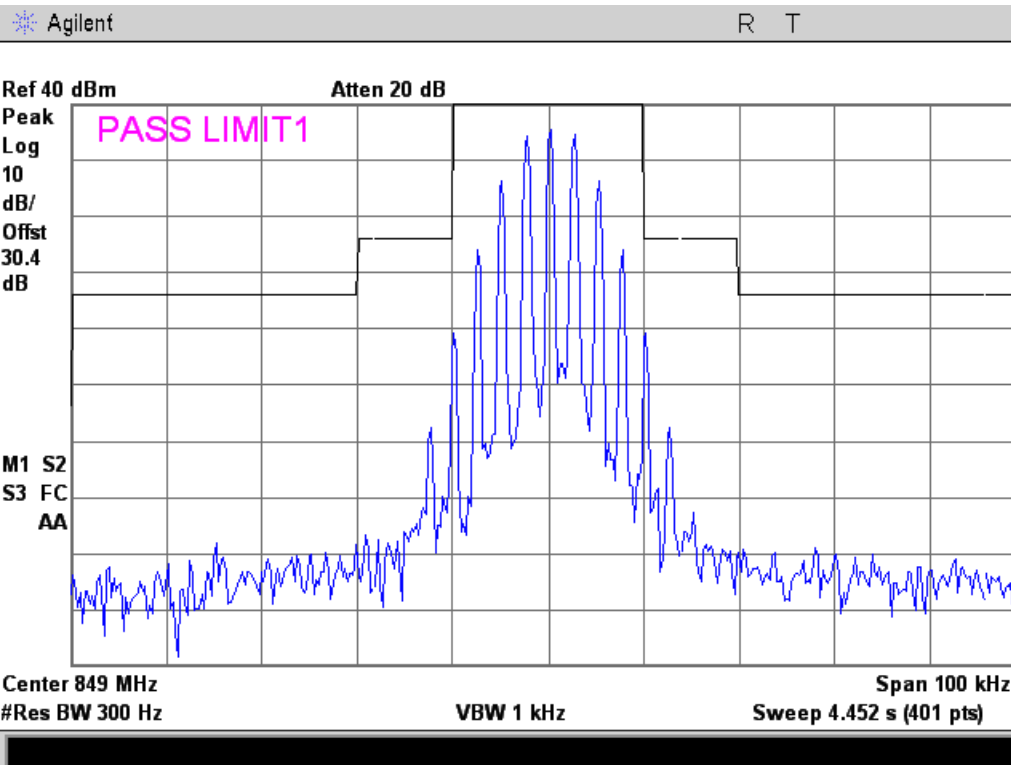



850.95 MHz Reference

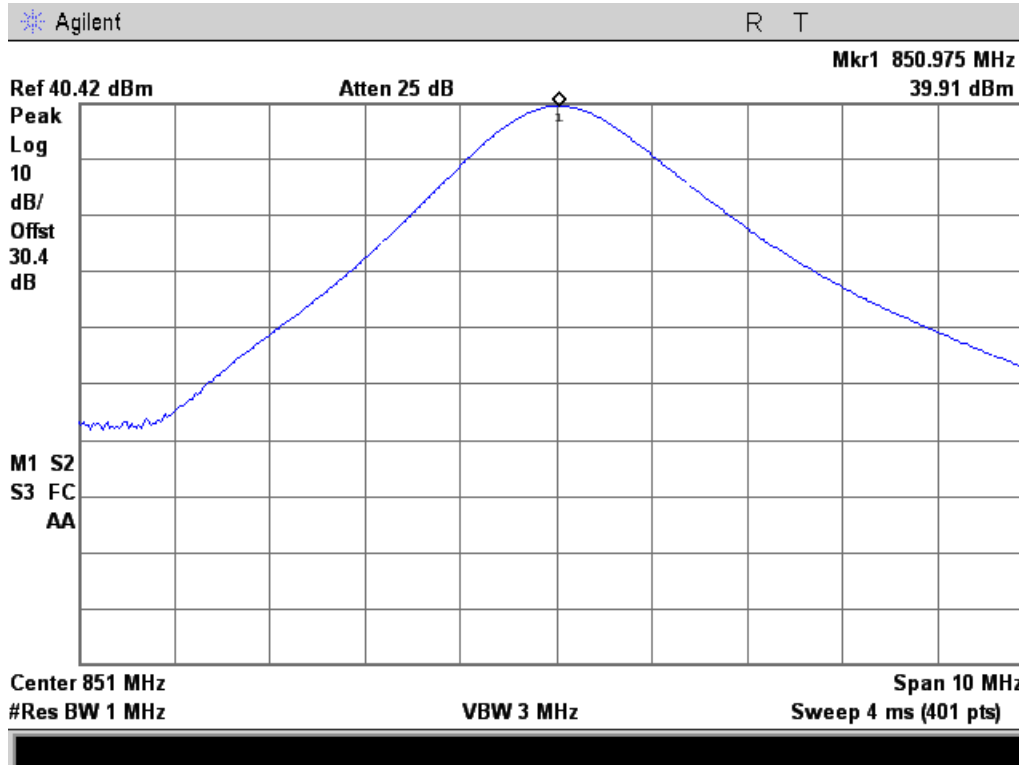

8K10F1D

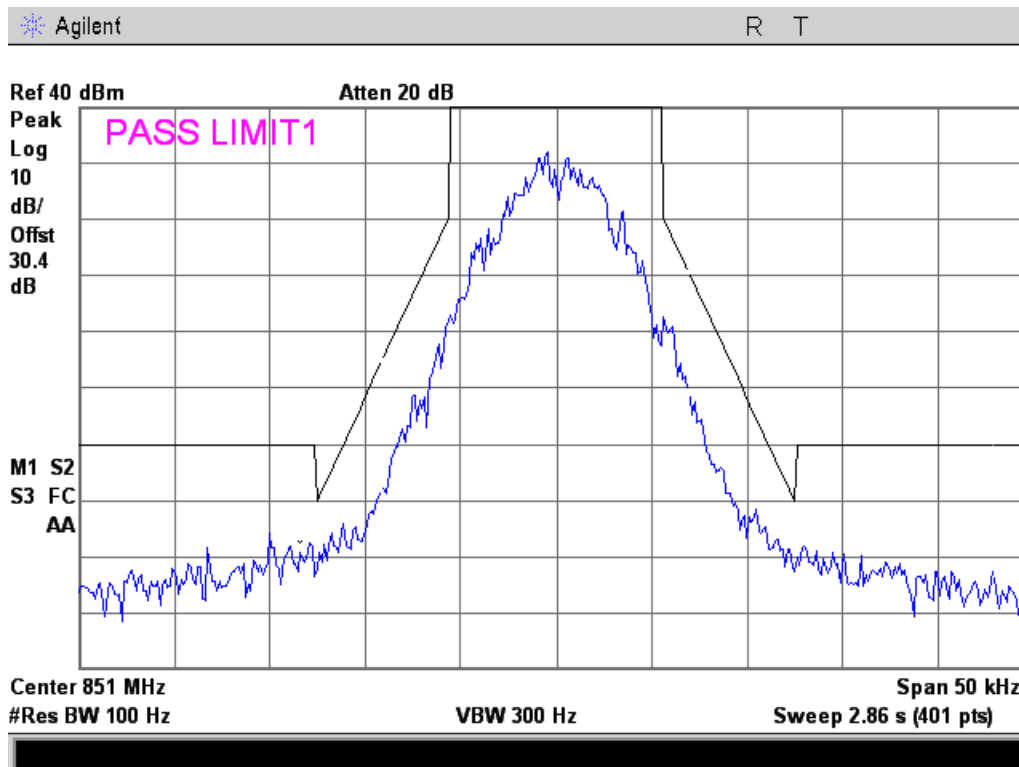



11K0F3E

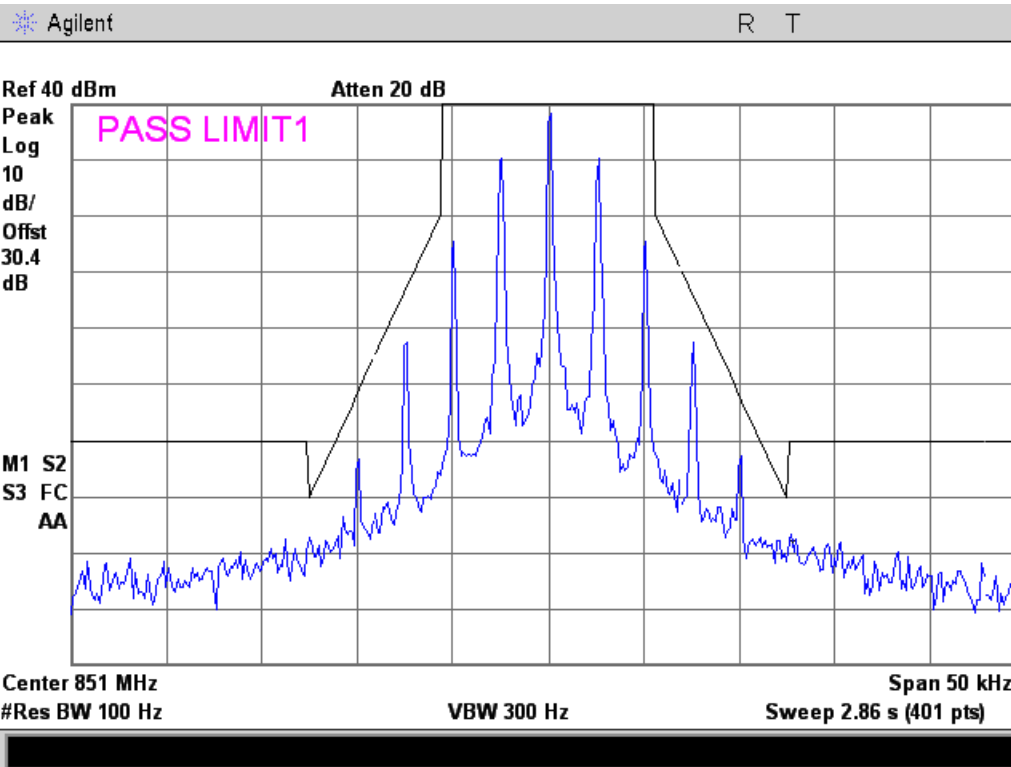

16K0F3E

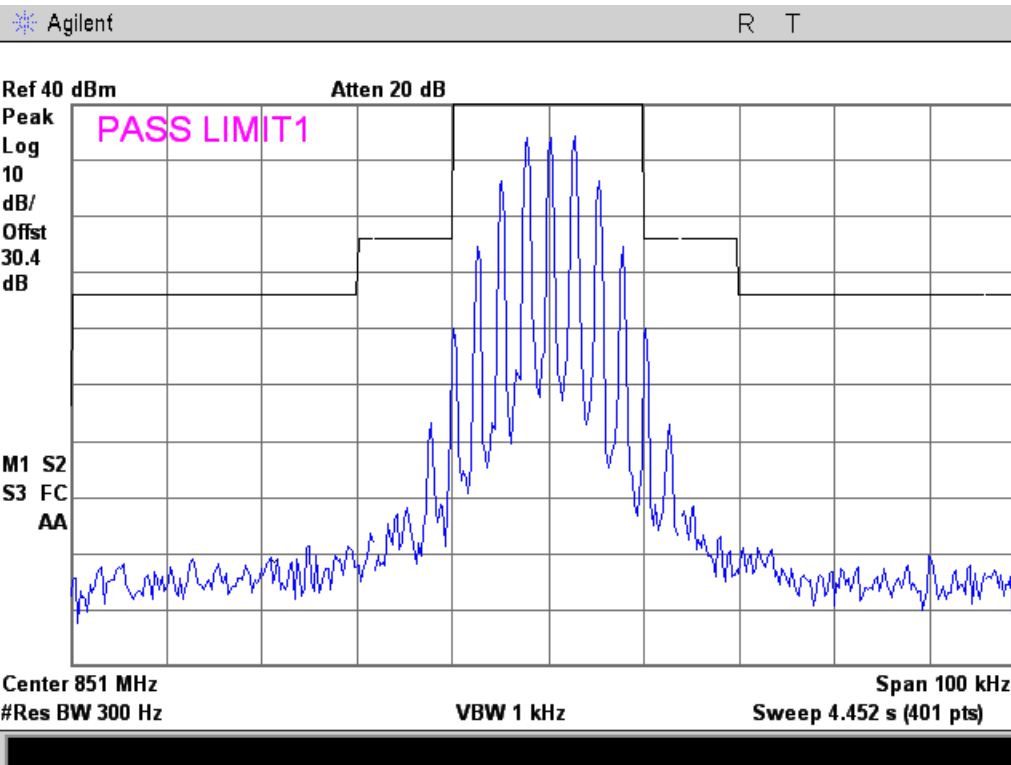



851.05 MHz Reference

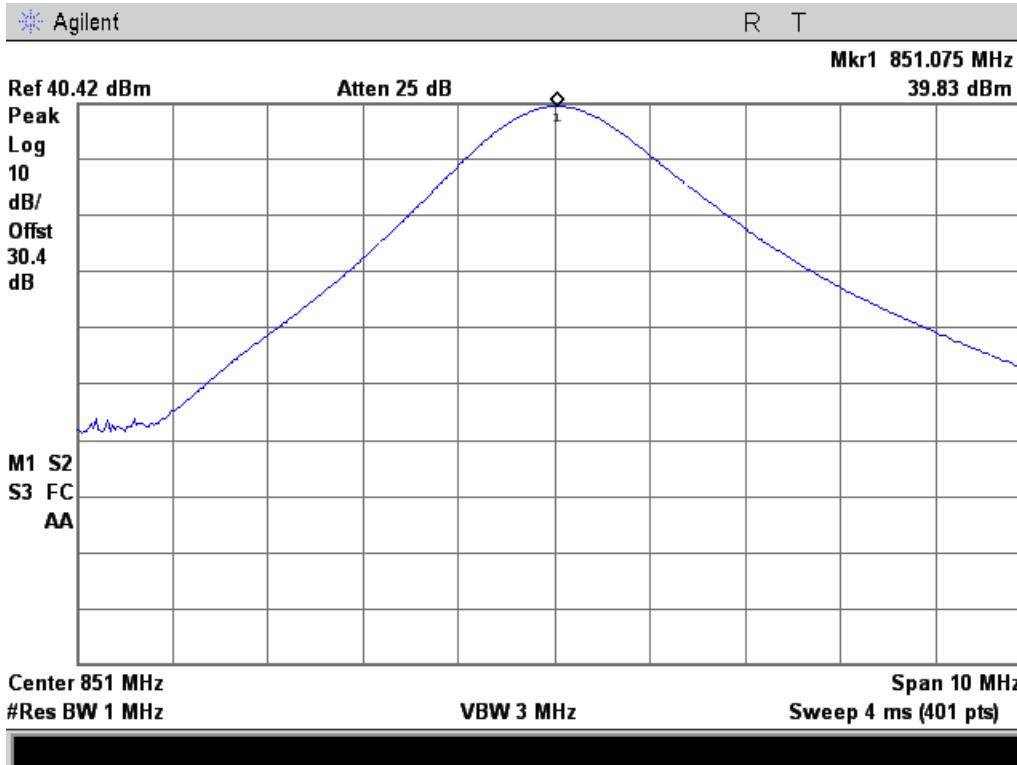

8K10F1D

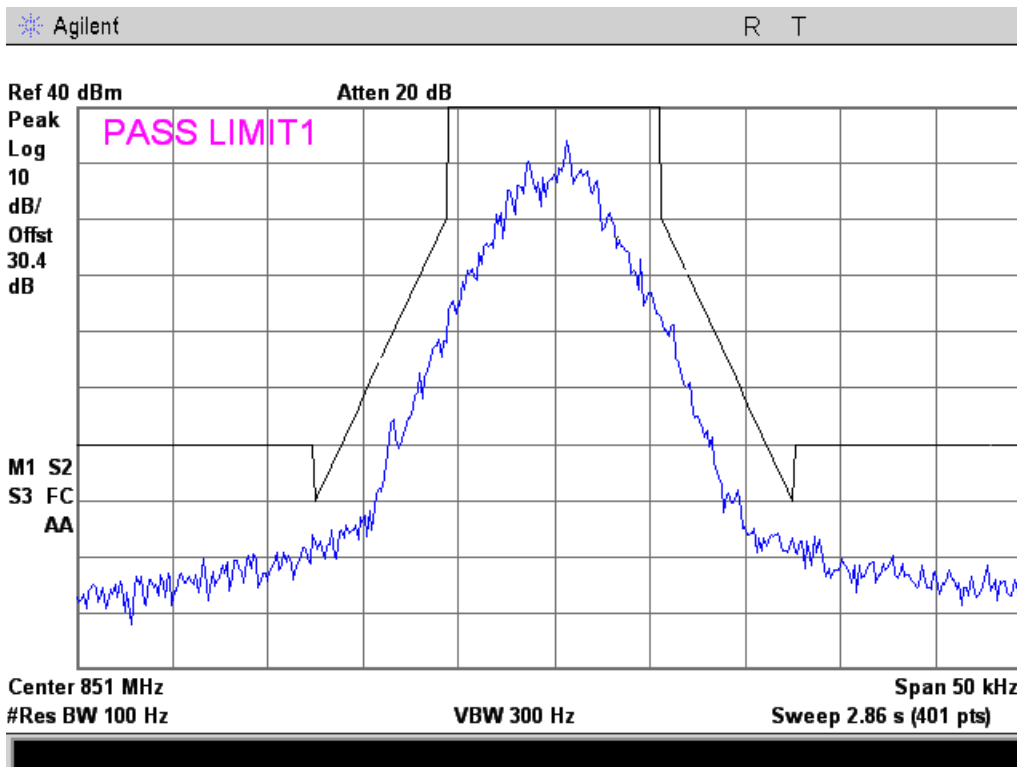



11K0F3E

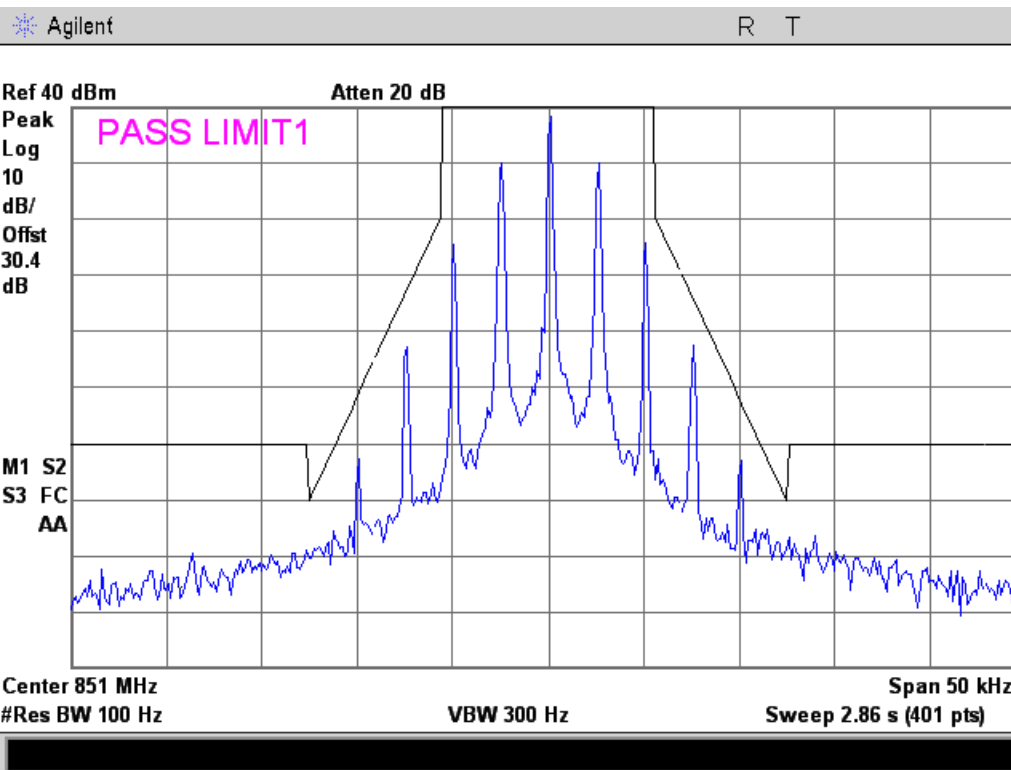

16K0F3E

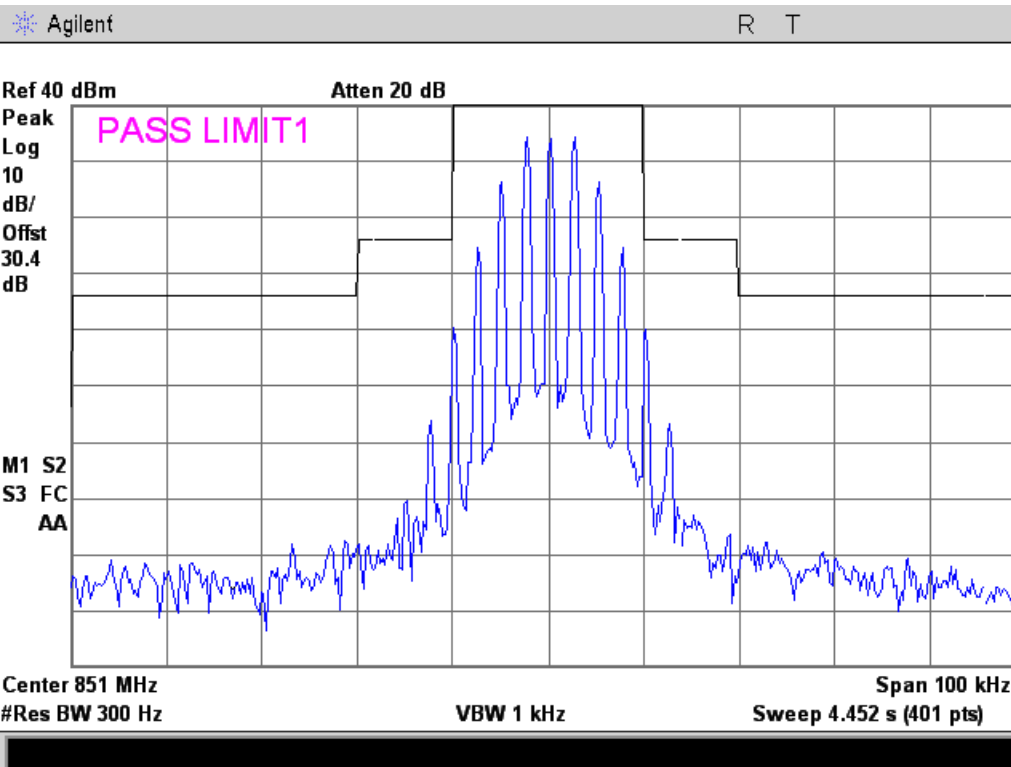



854.05 MHz Reference

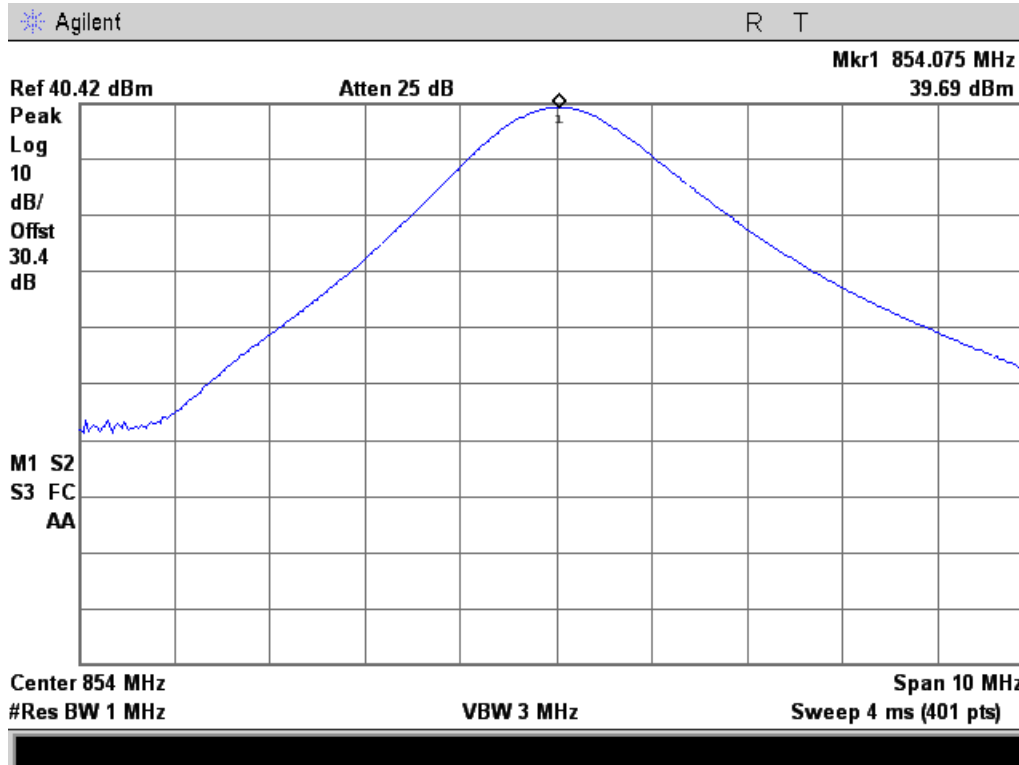

8K10F1D

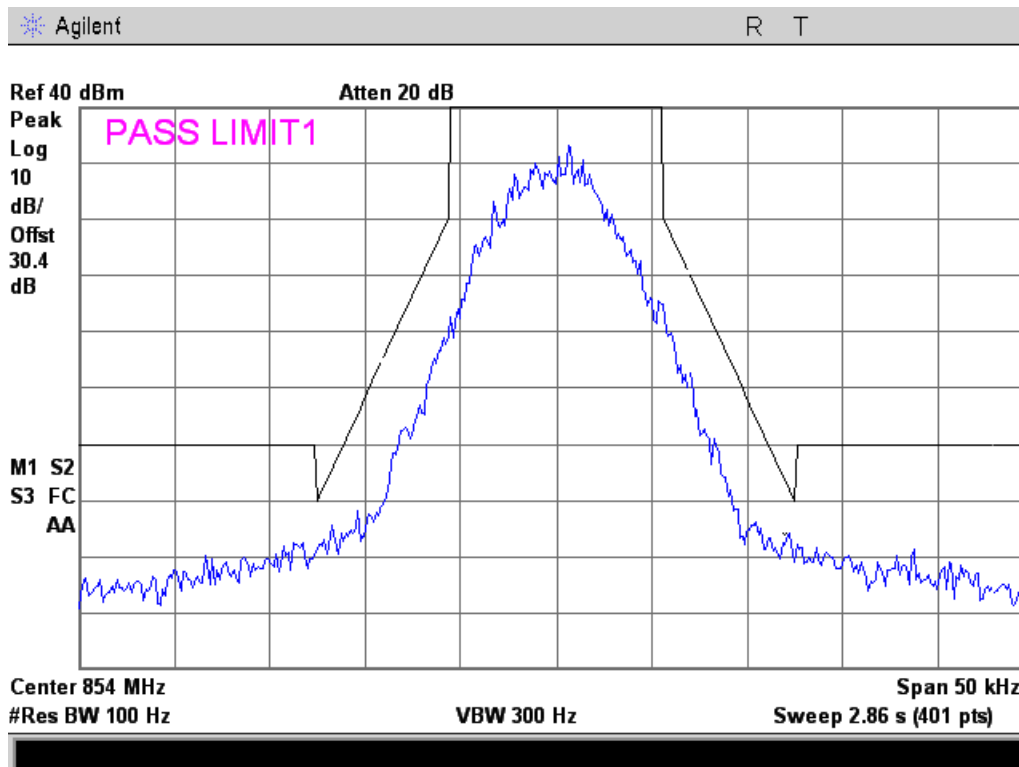



11K0F3E

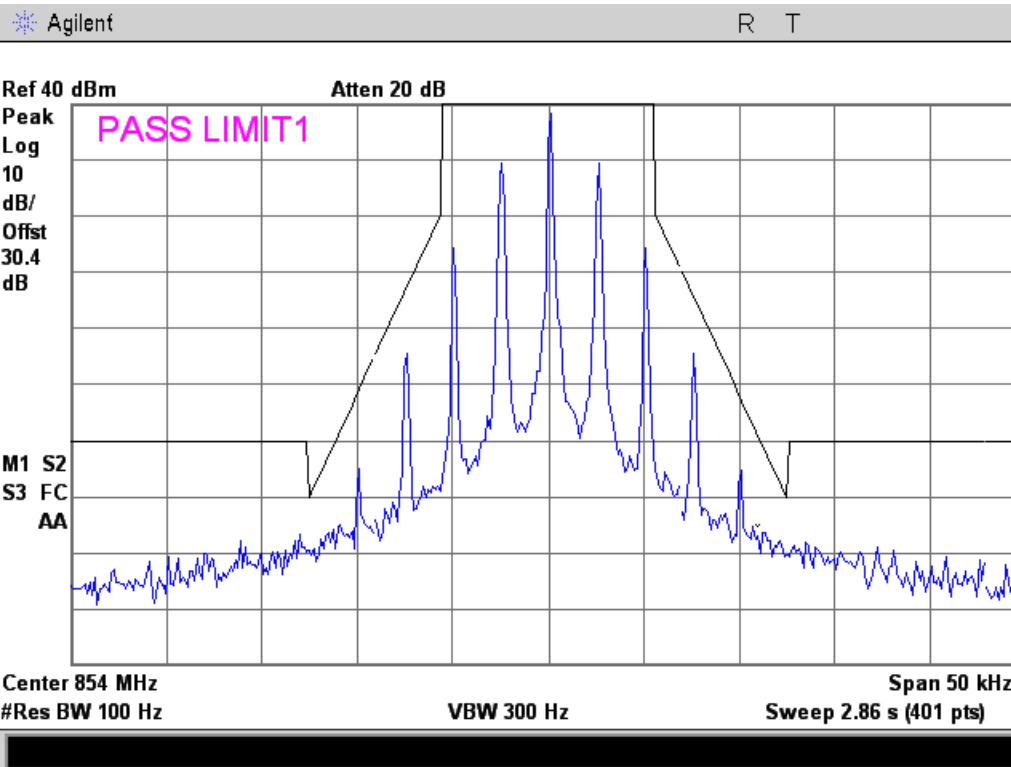

16K0F3E

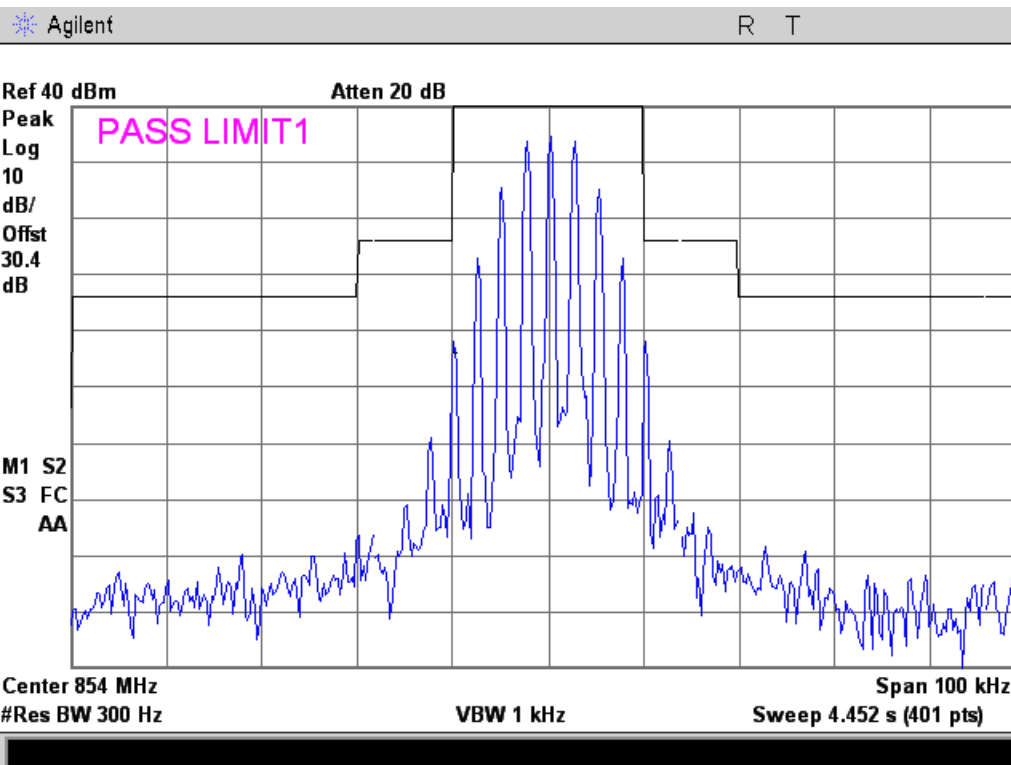



869.95 MHz Reference

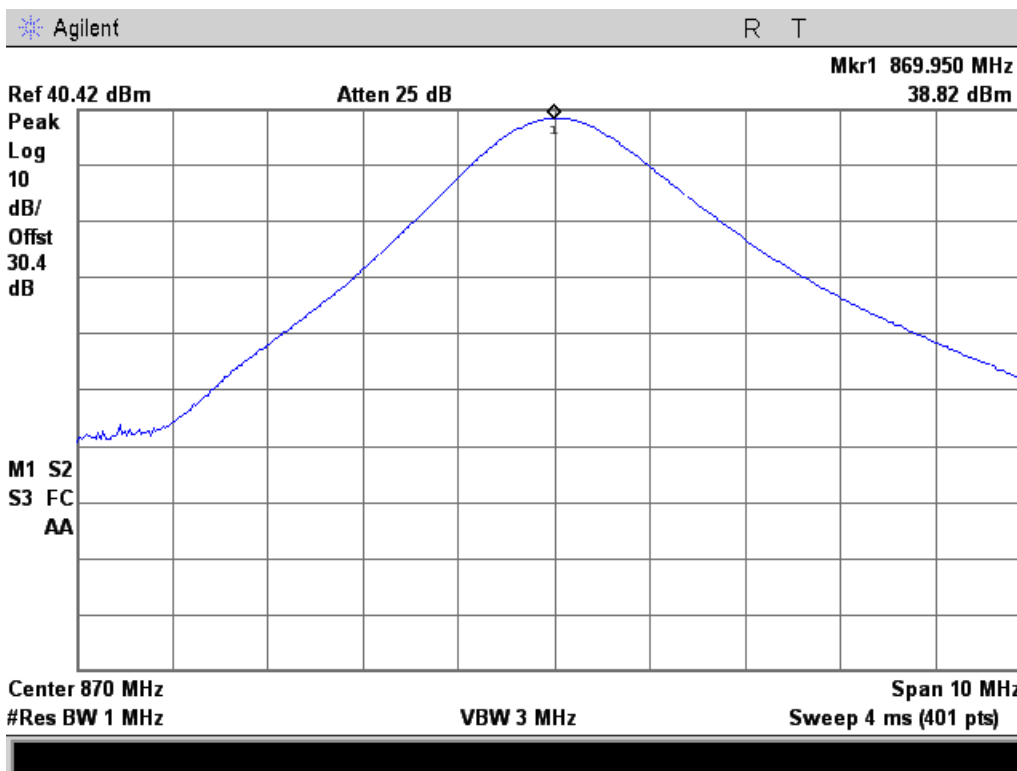

8K10F1D

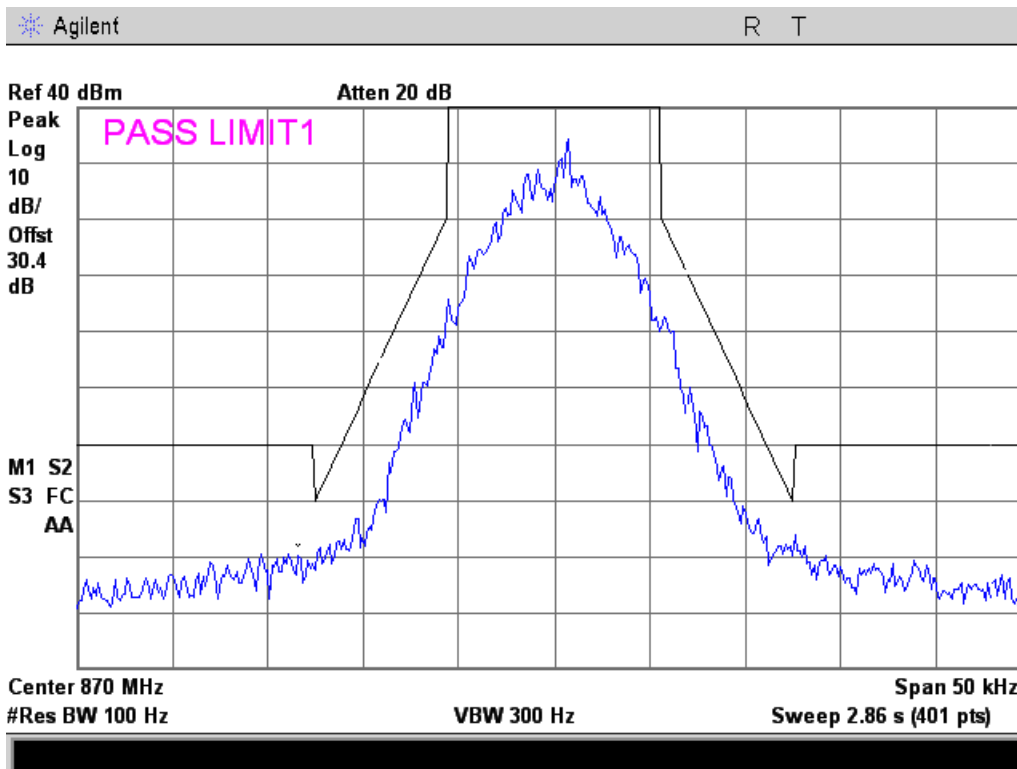



11K0F3E

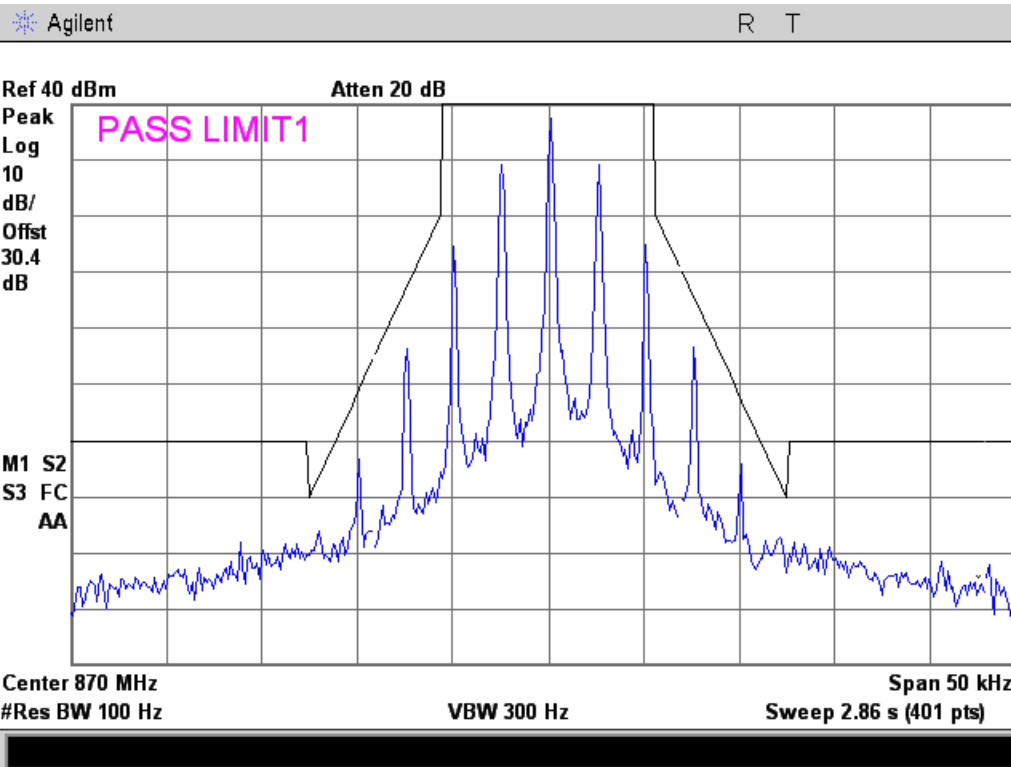

16K0F3E

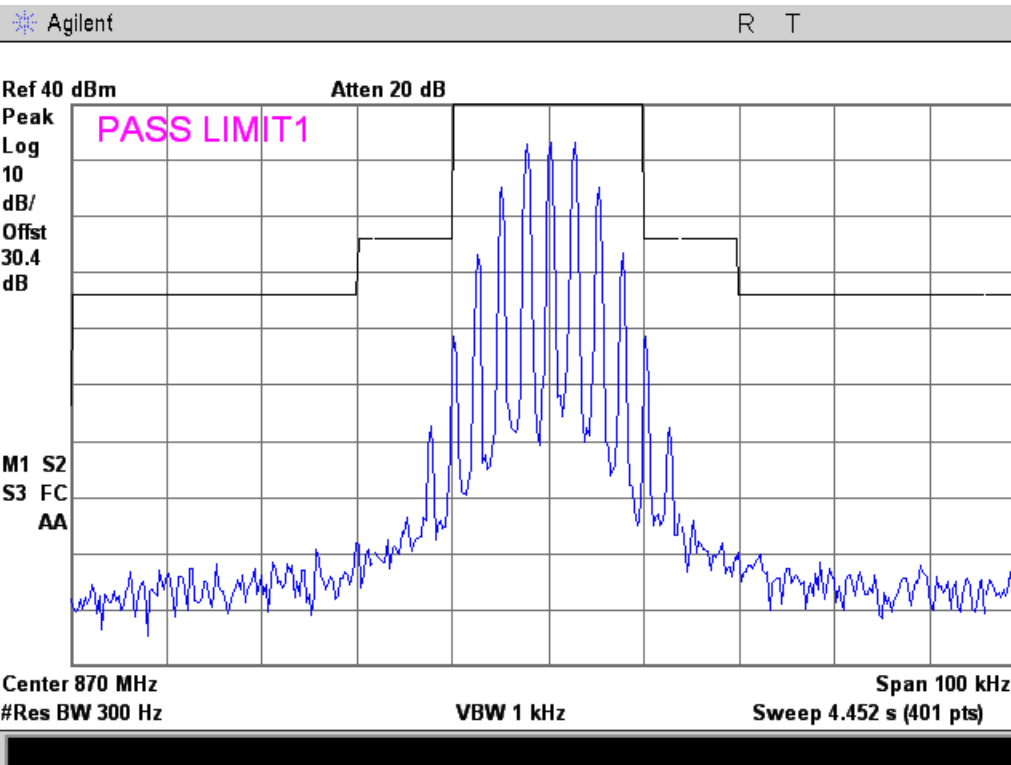



872.05 MHz Reference

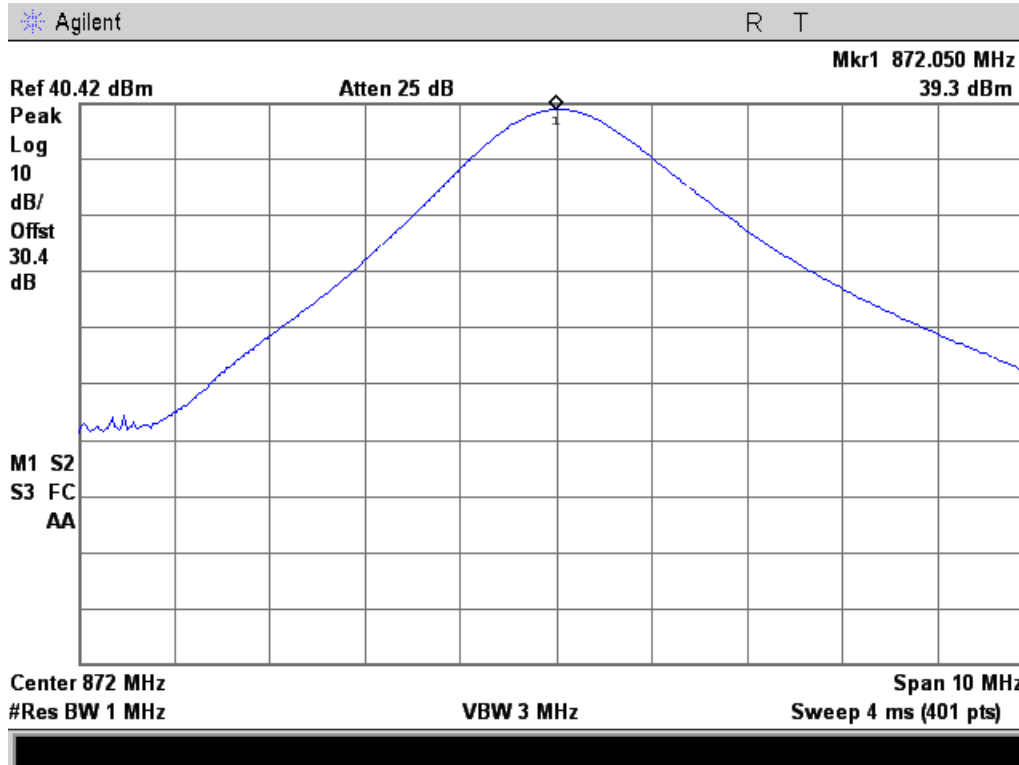

8K10F1D

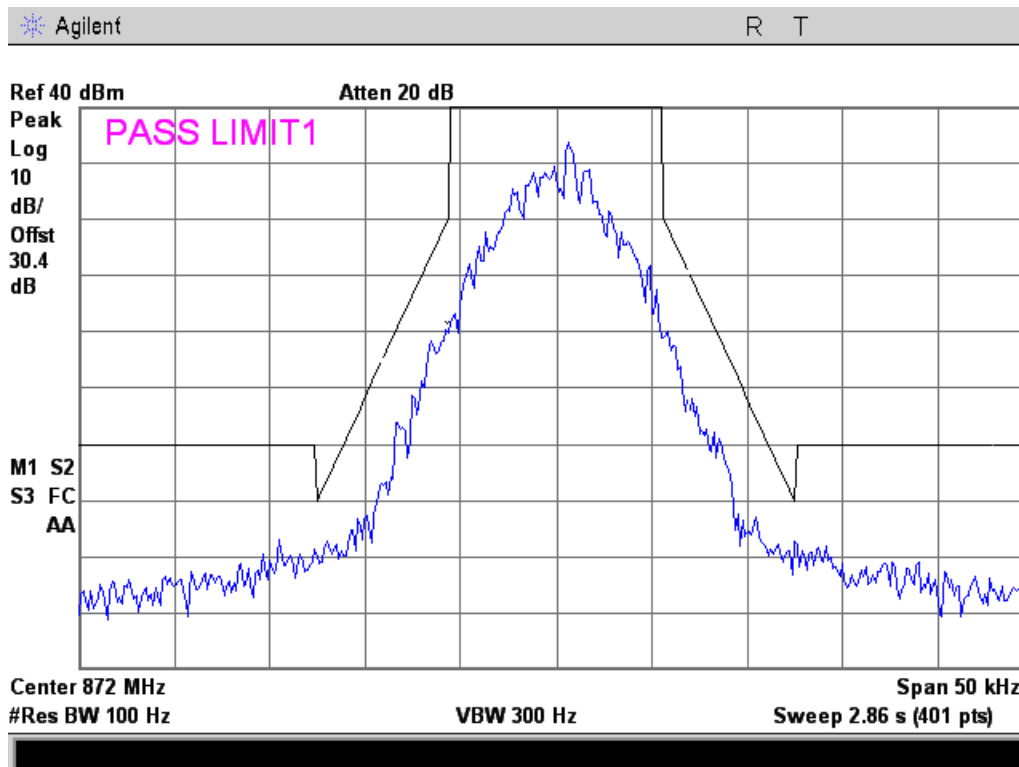



11K0F3E

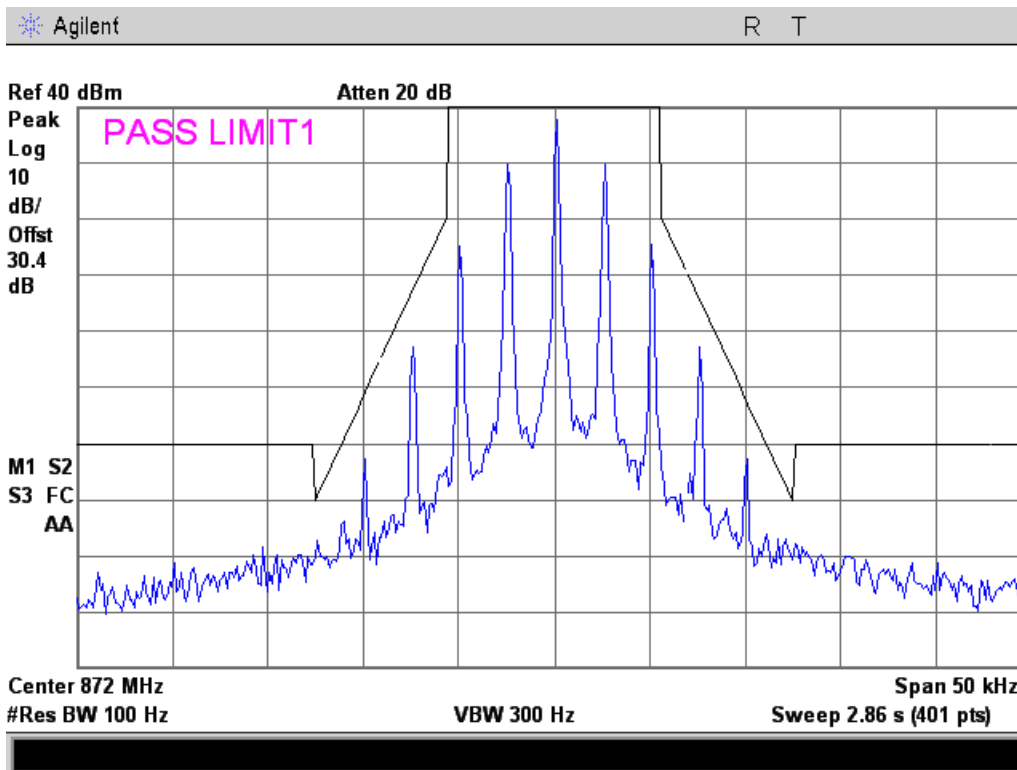

16K0F3E

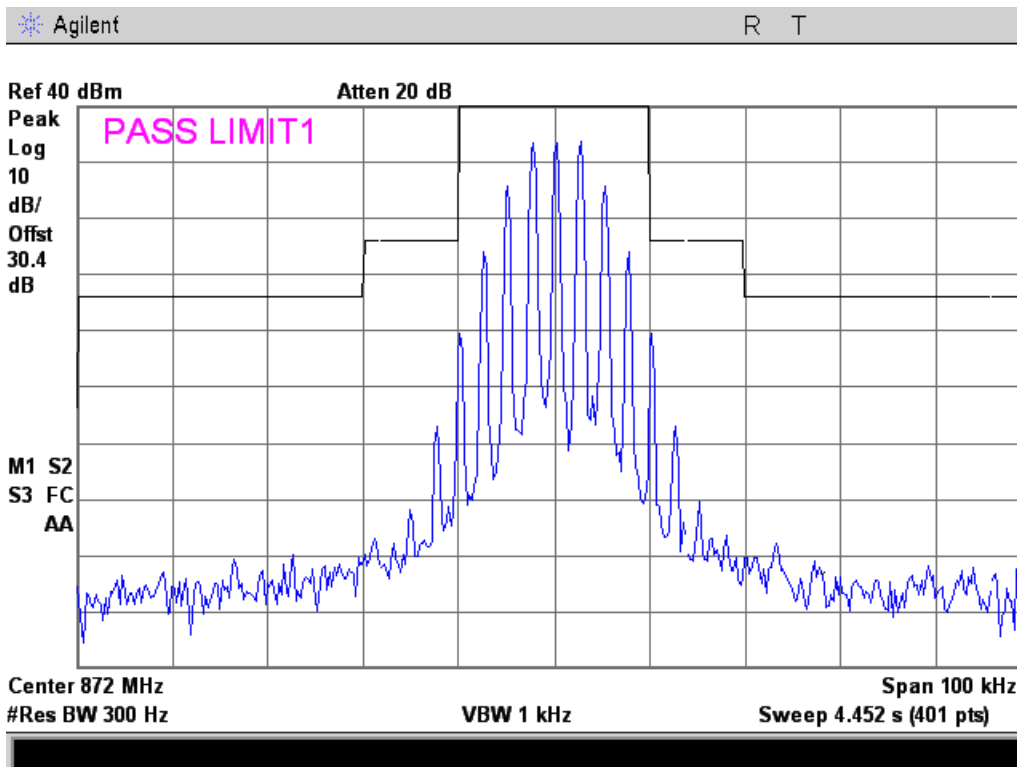



893.95 MHz Reference

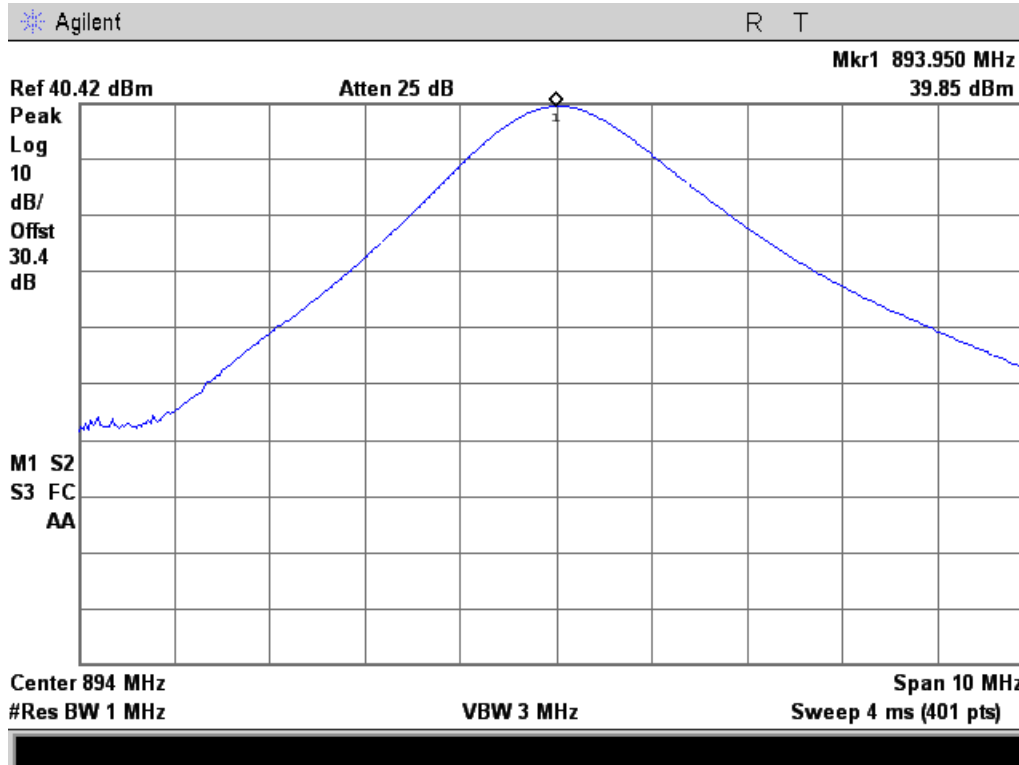

8K10F1D

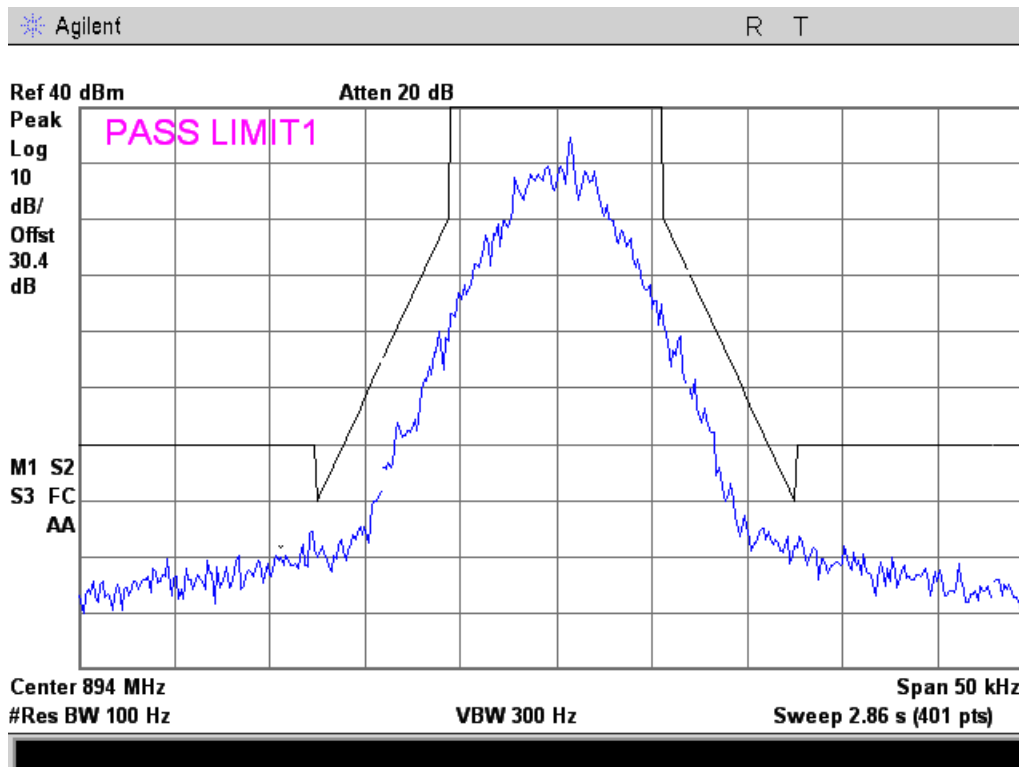



11K0F3E

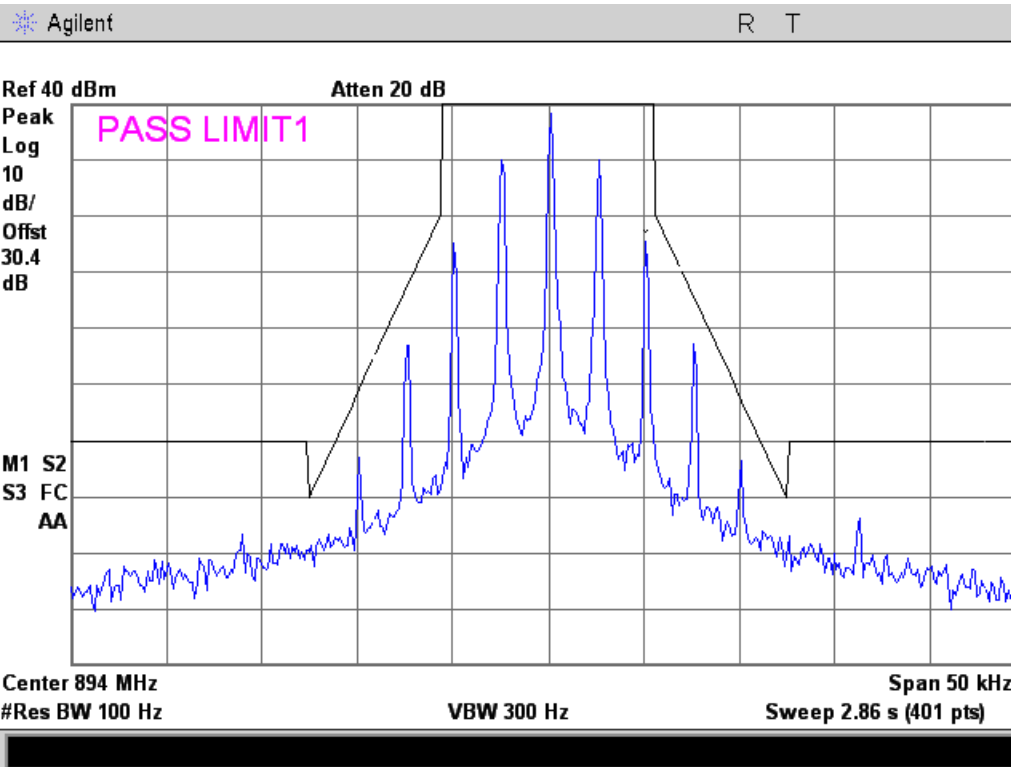

16K0F3E

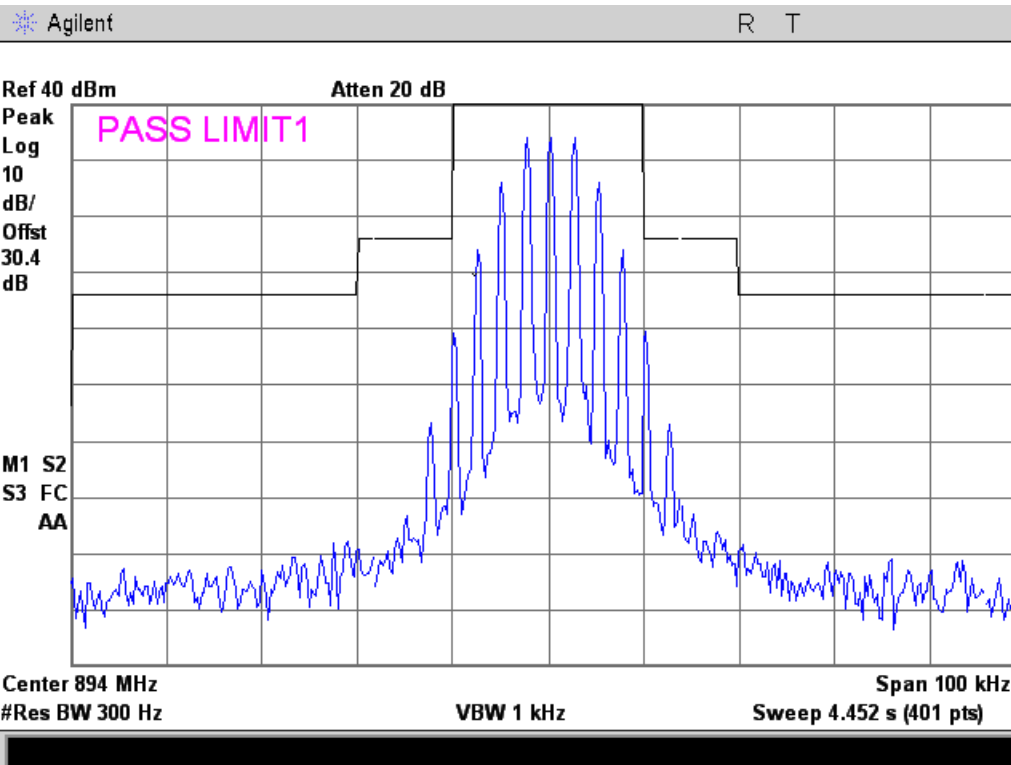



895.95 MHz Reference

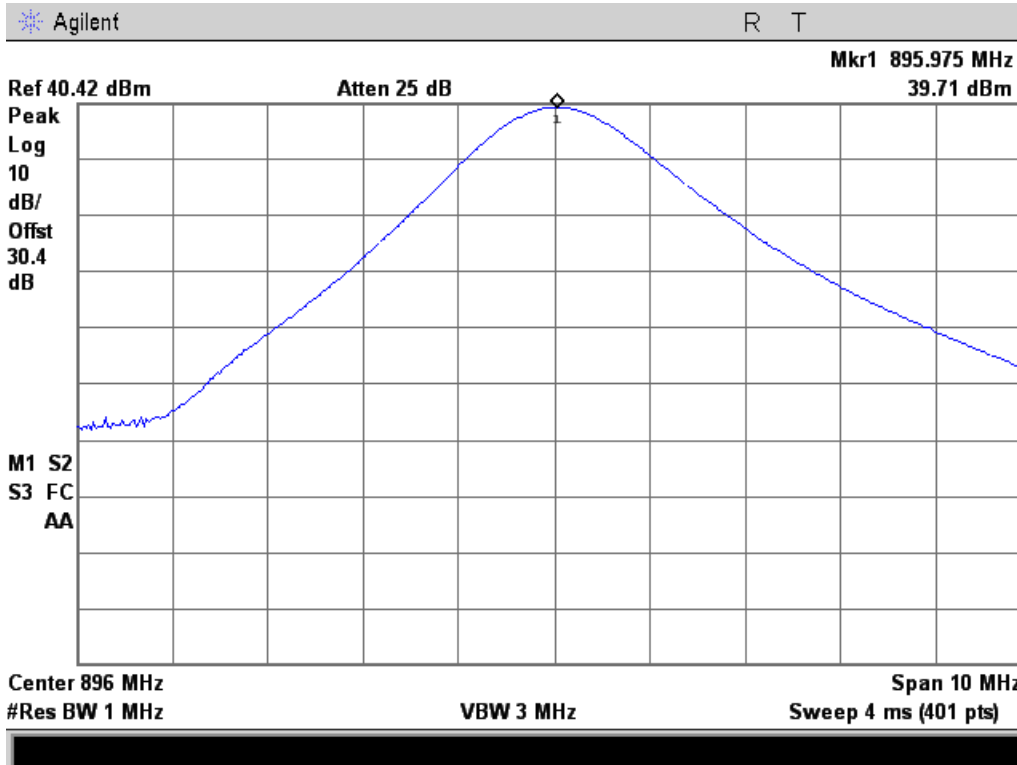

8K10F1D

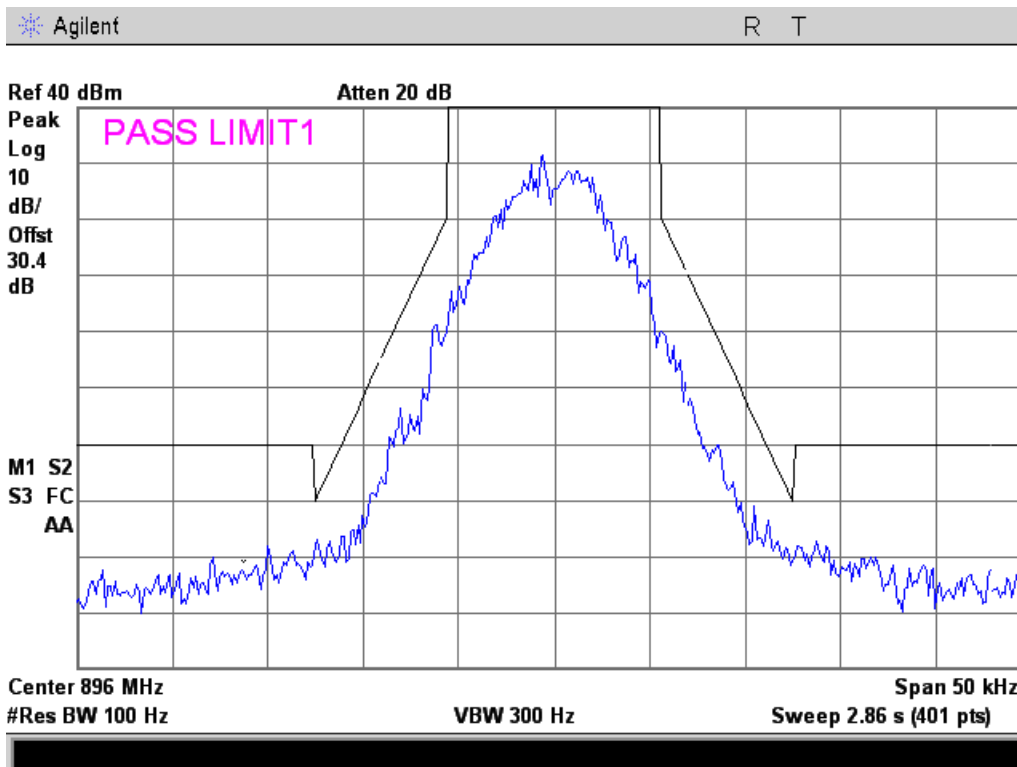



11K0F3E

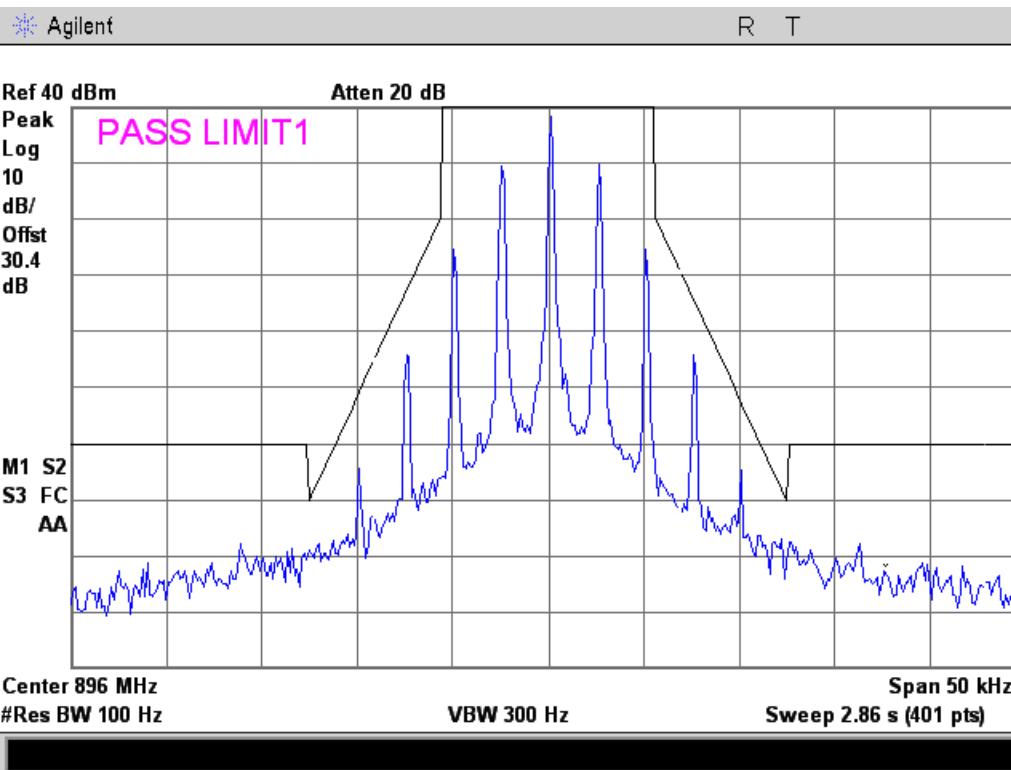

16K0F3E

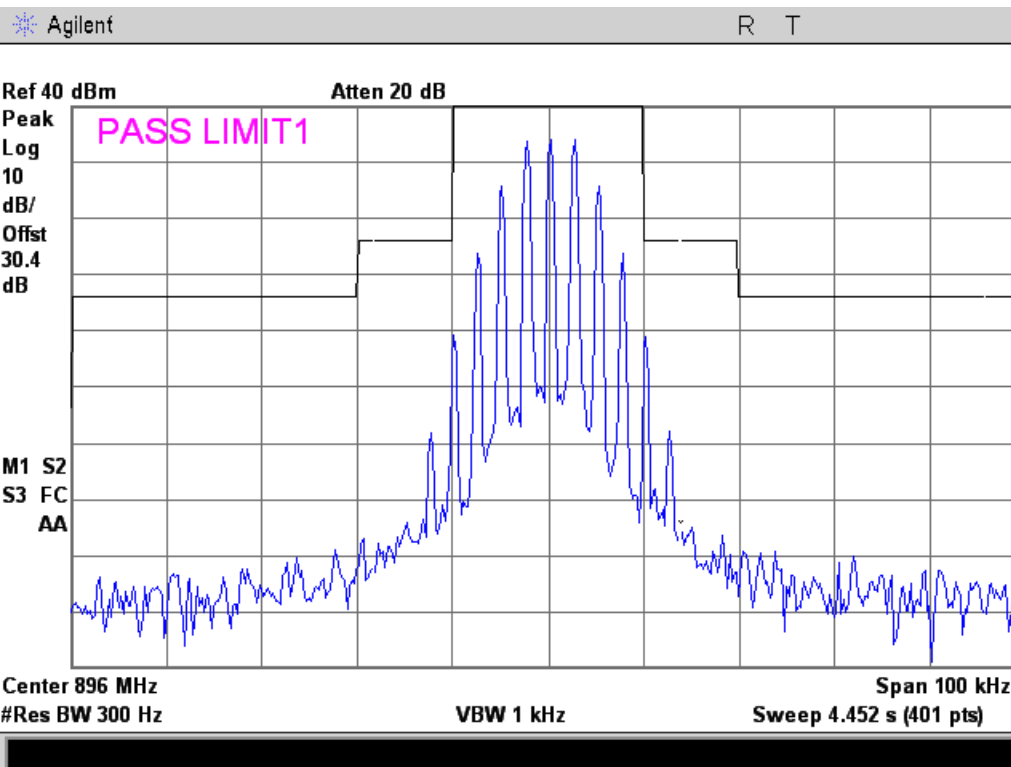



896.05 MHz Reference

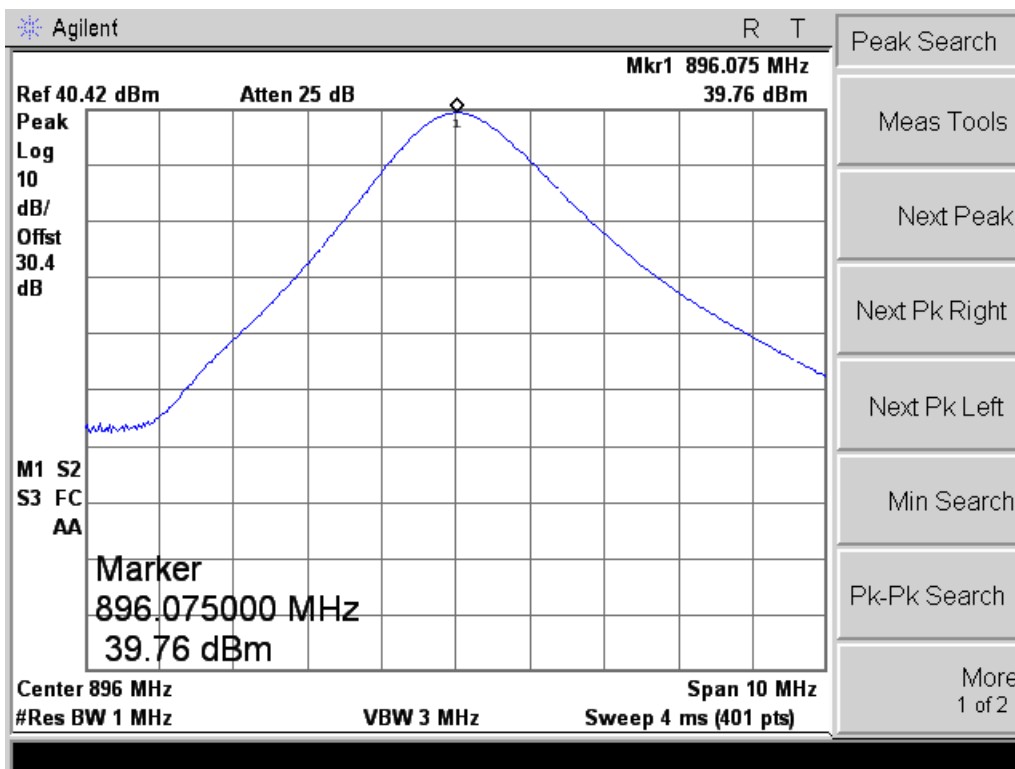

8K10F1D

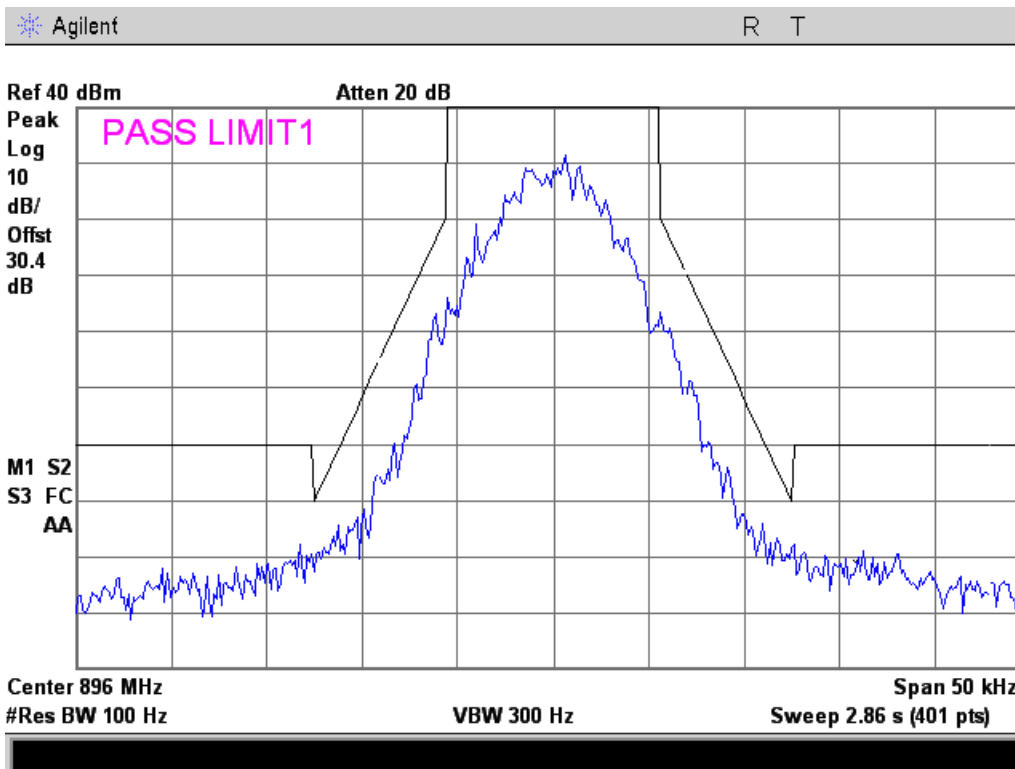



11K0F3E

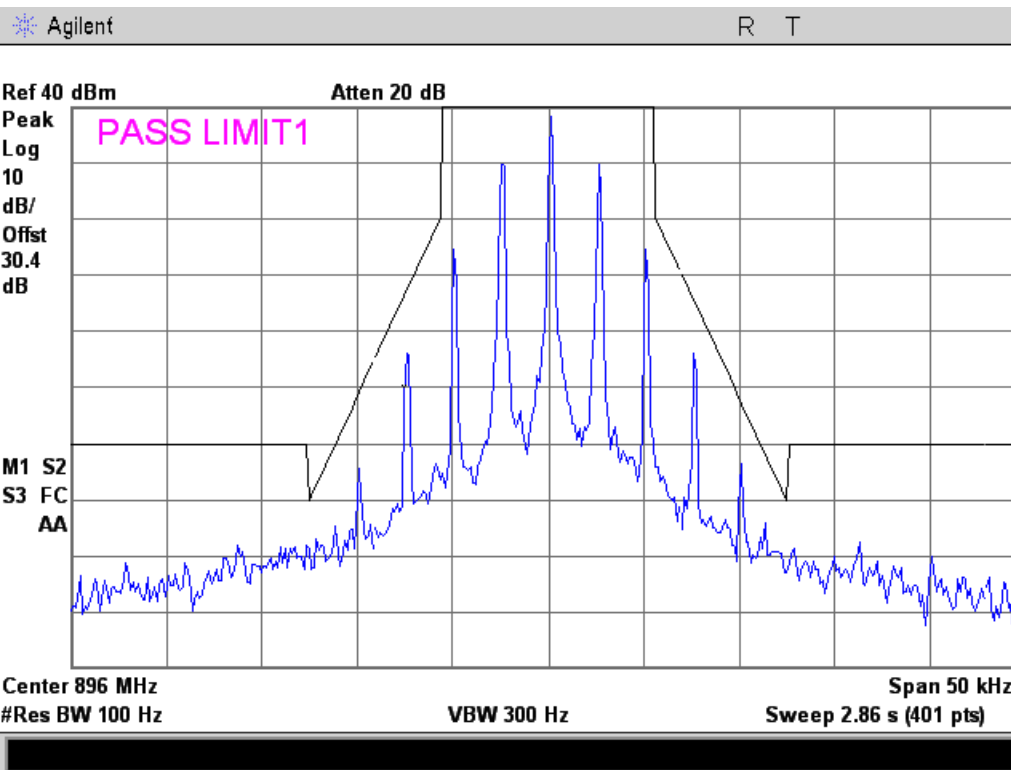

16K0F3E

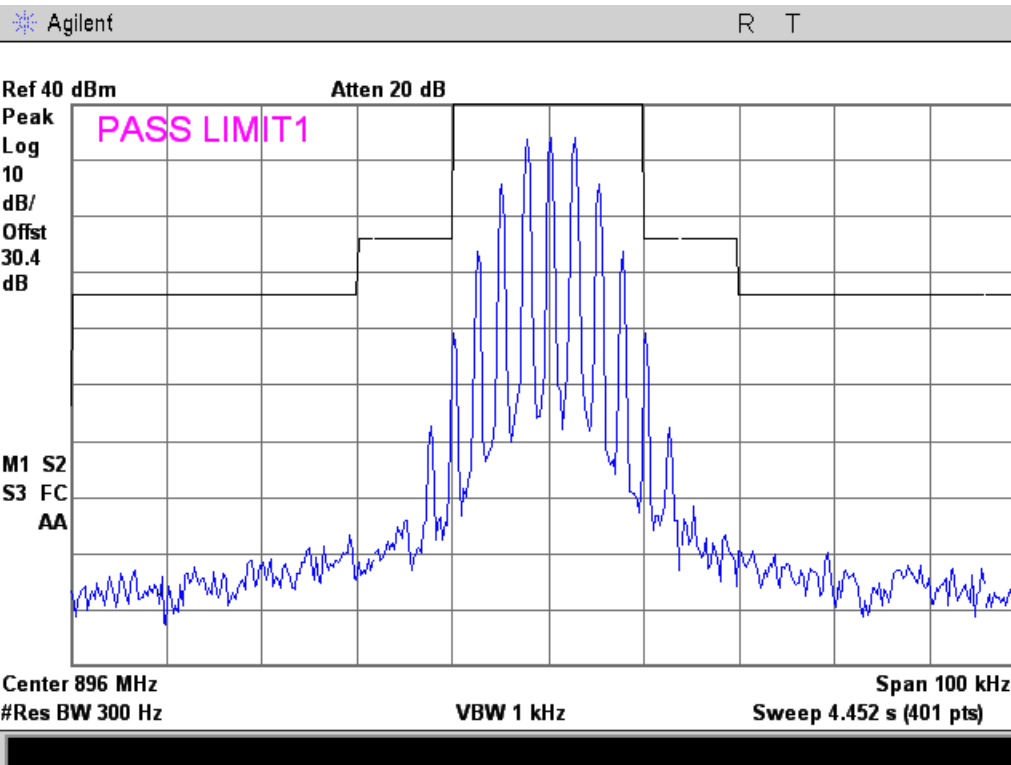



900.95 MHz Reference

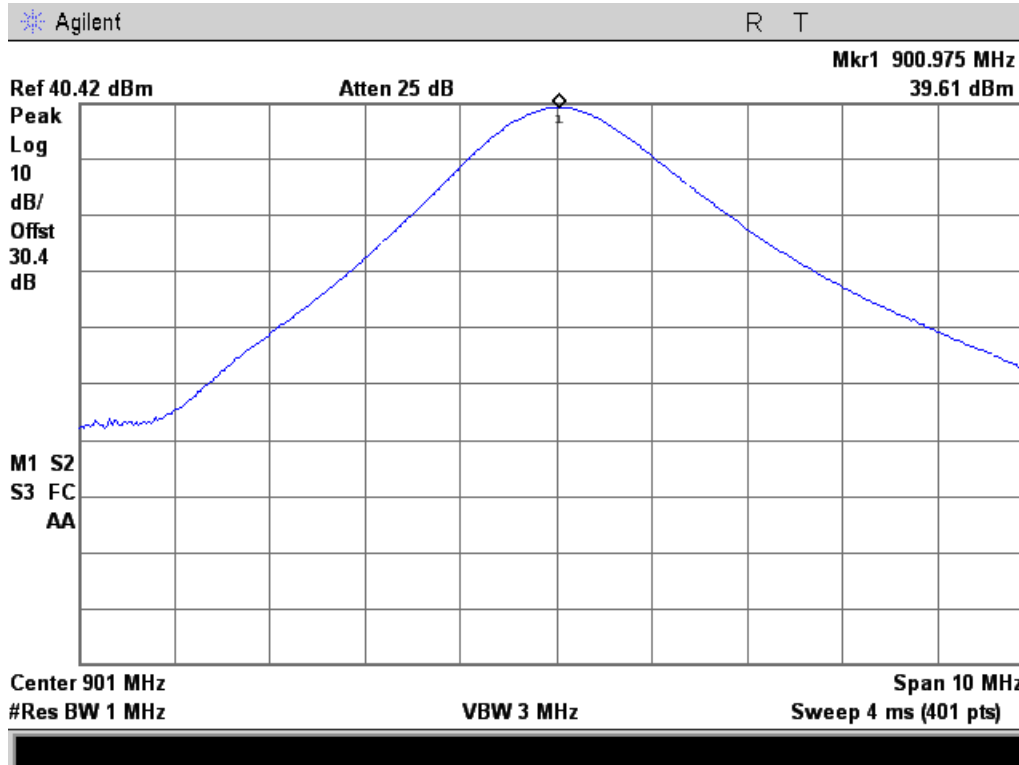

8K10F1D

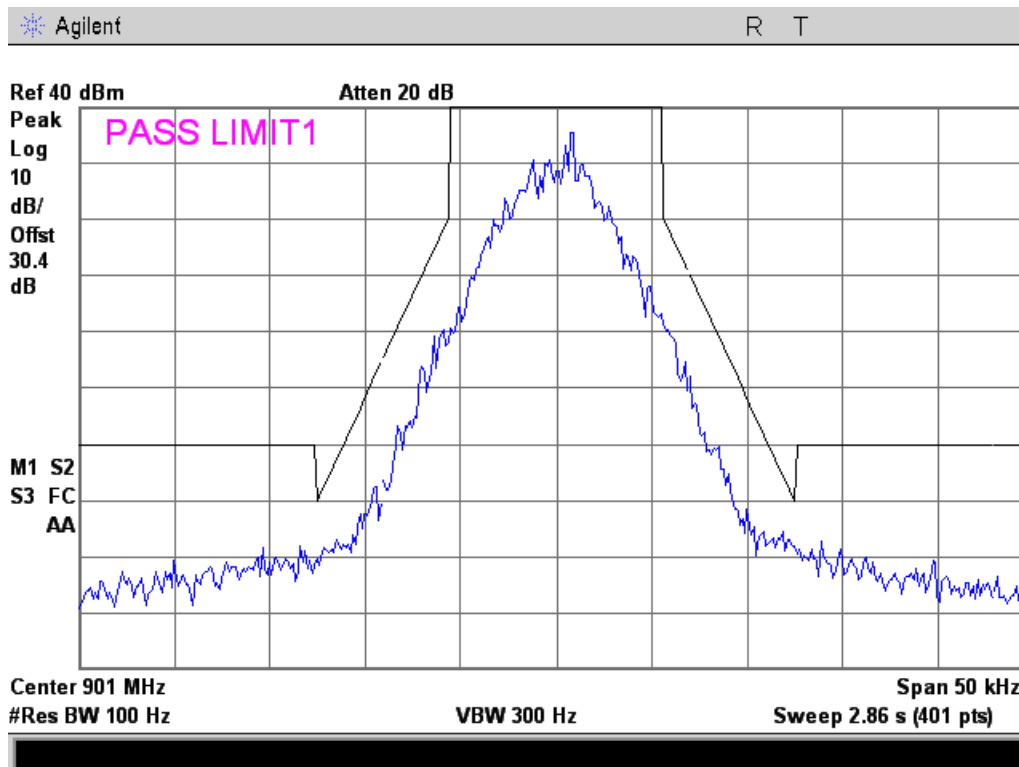



11K0F3E

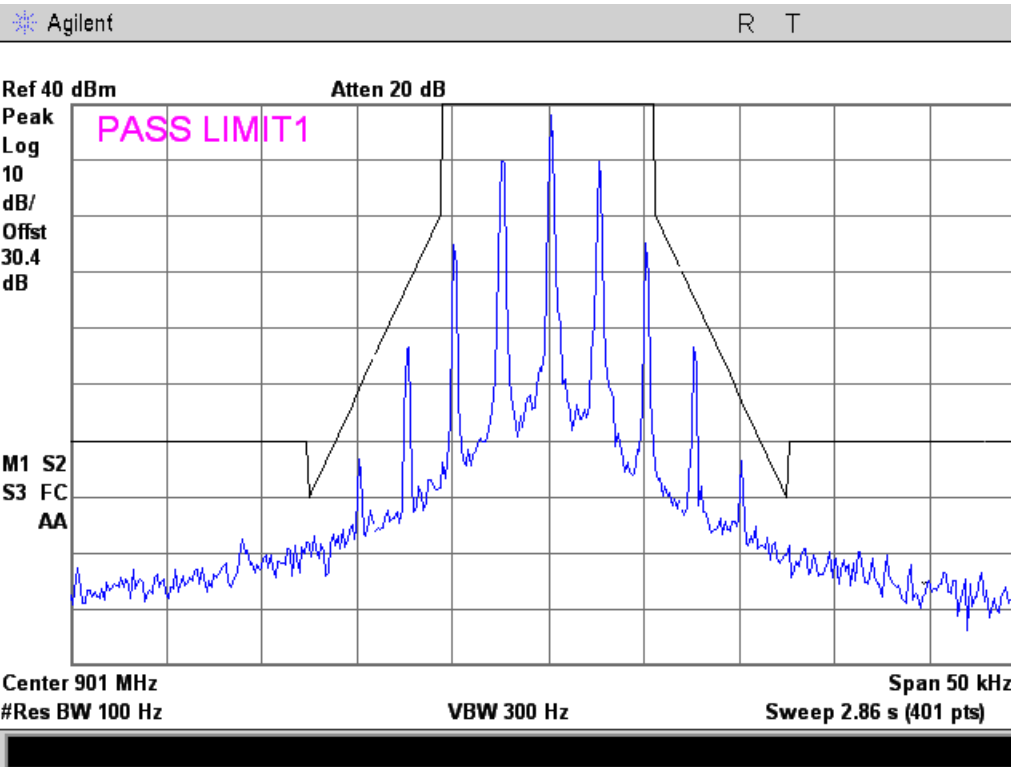

16K0F3E

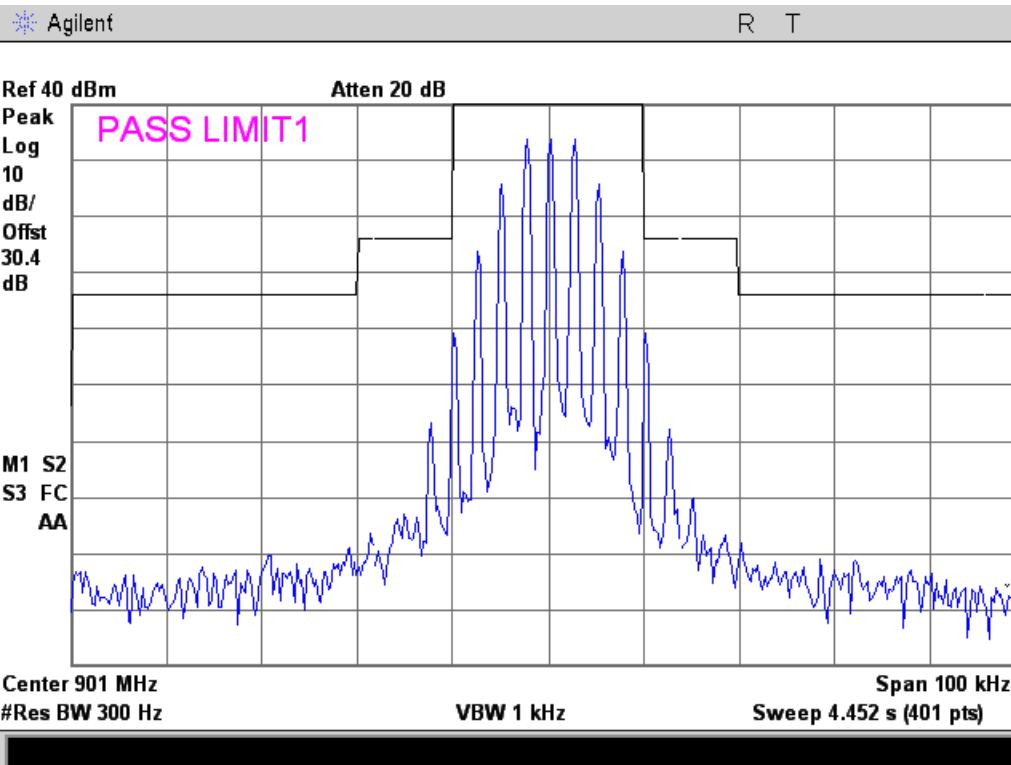



902.05 MHz Reference

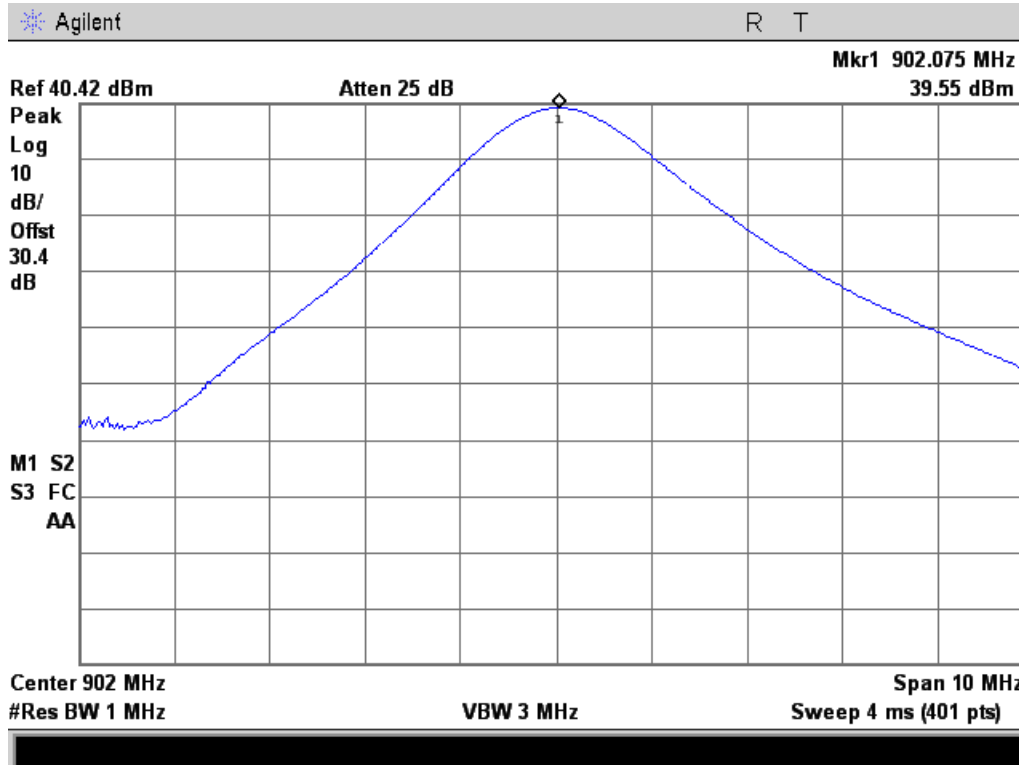

8K10F1D

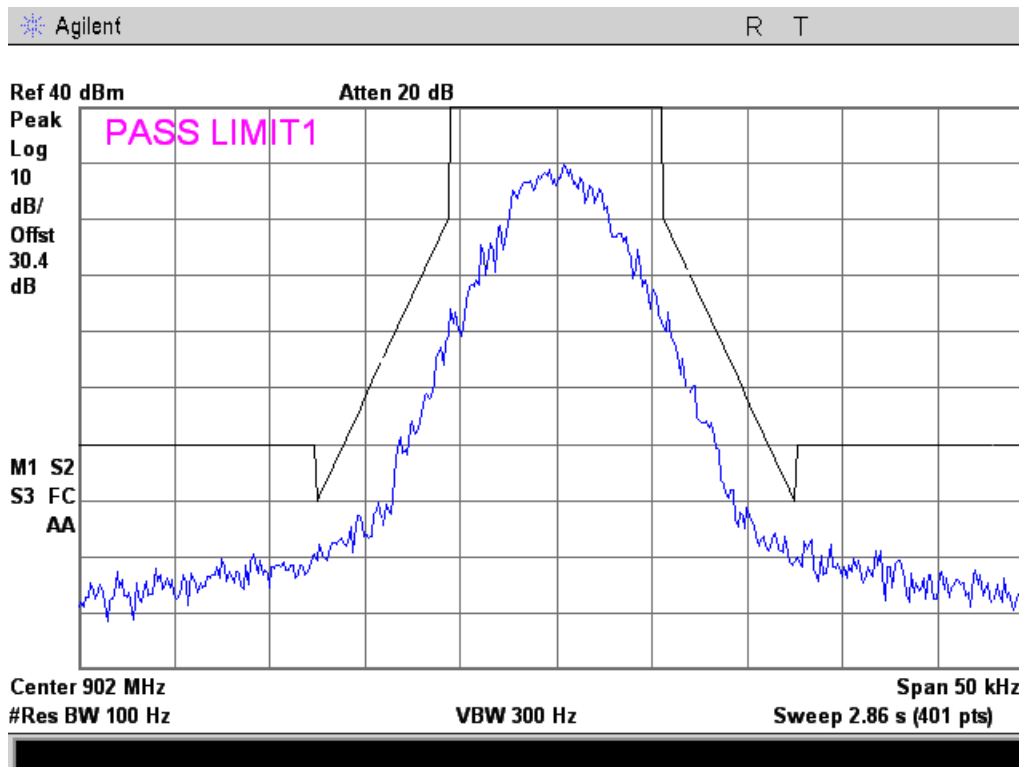



11K0F3E

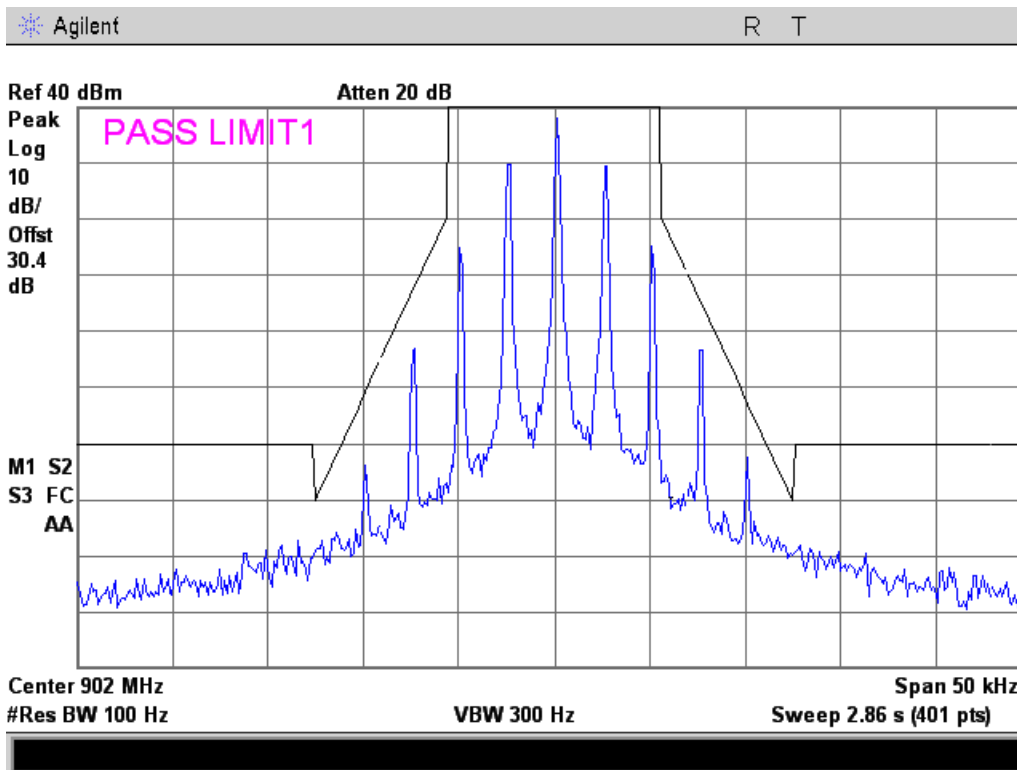

16K0F3E

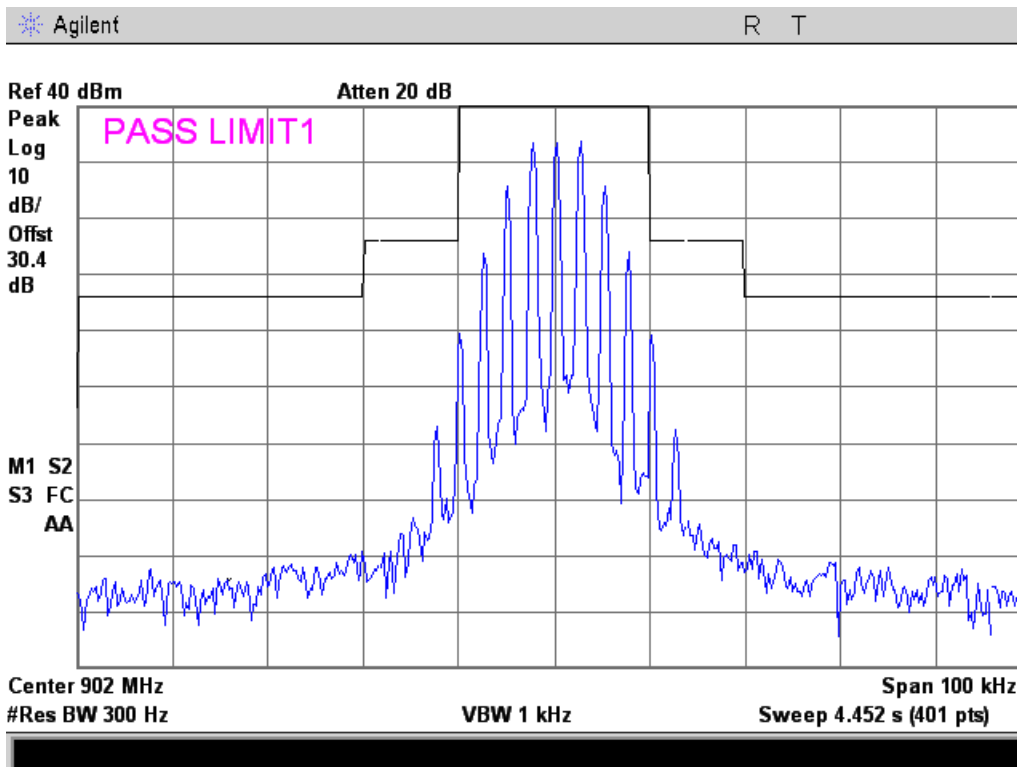



916.05 MHz Reference

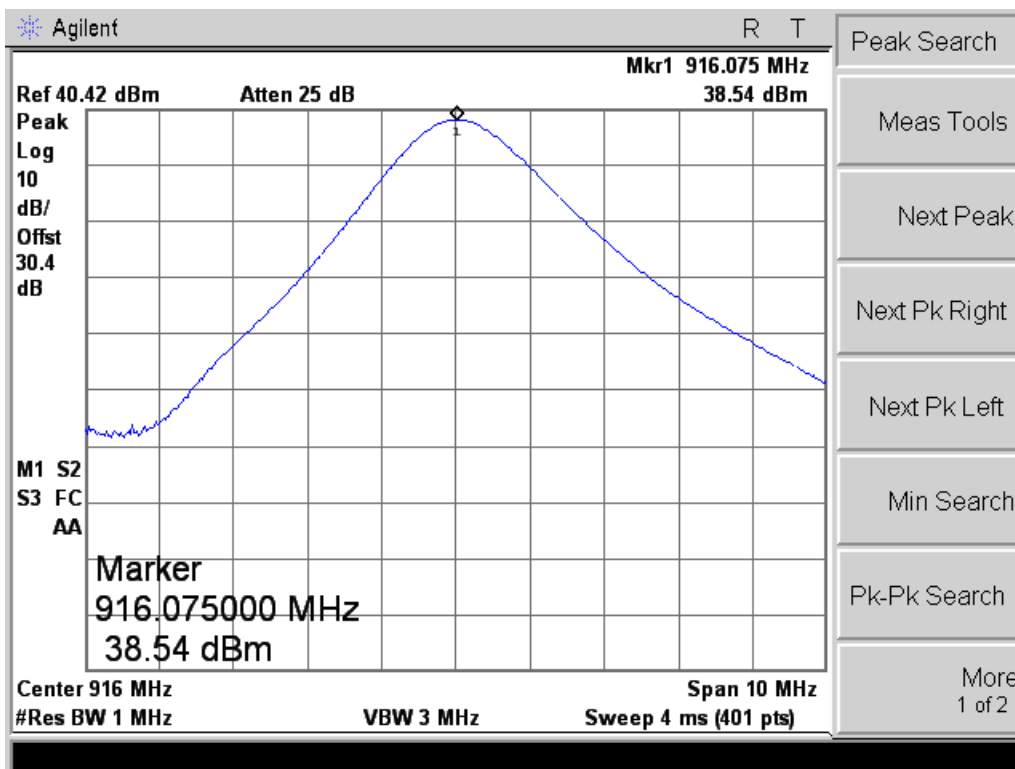

8K10F1D

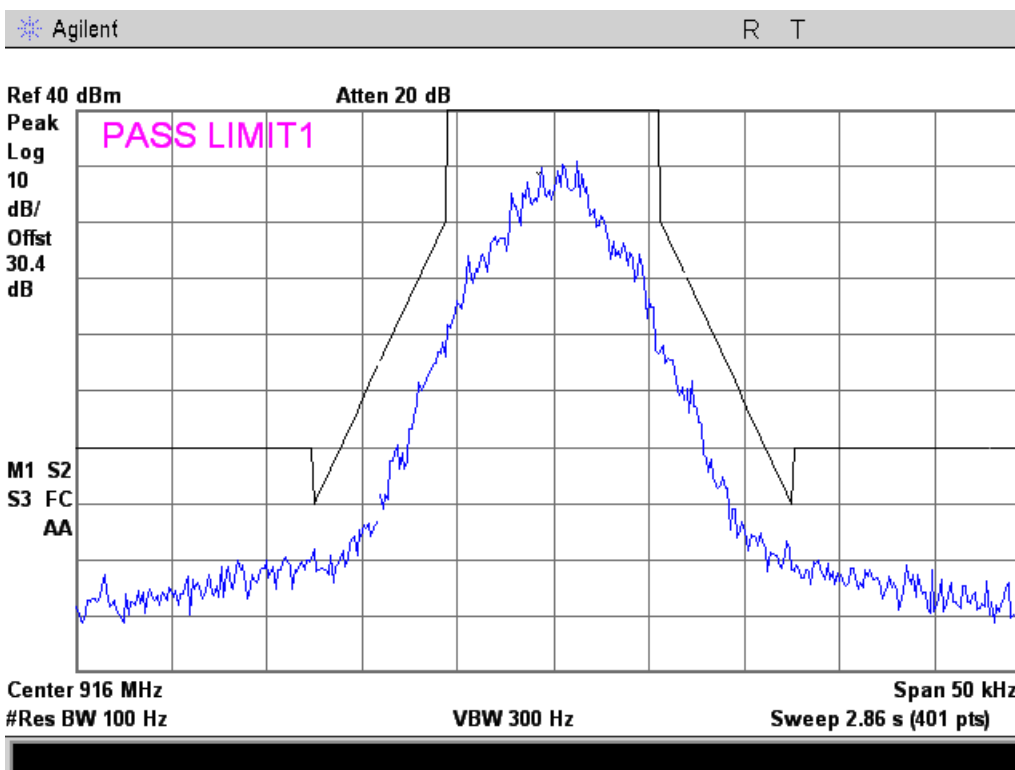



11K0F3E

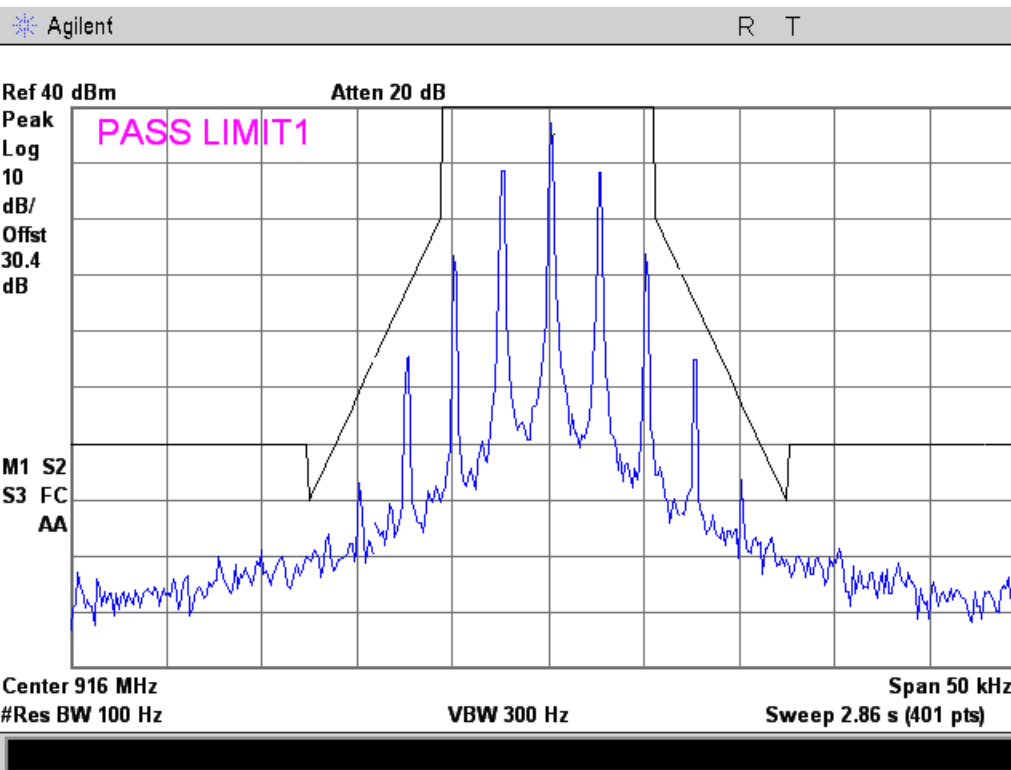

16K0F3E

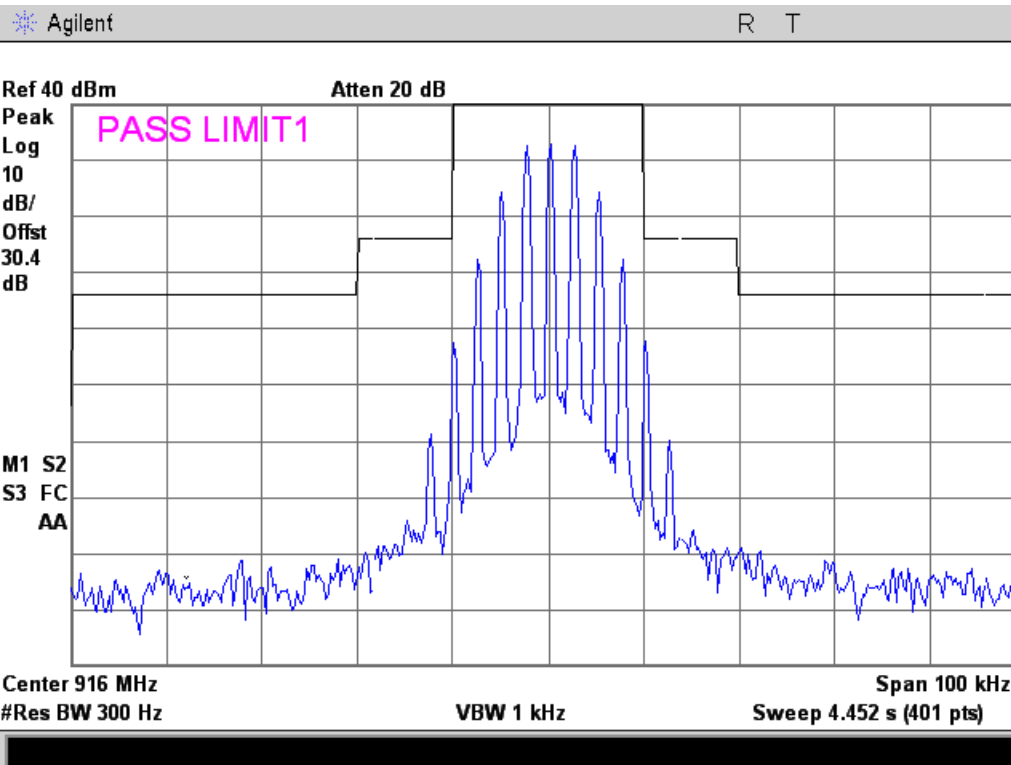



928.05 MHz Reference

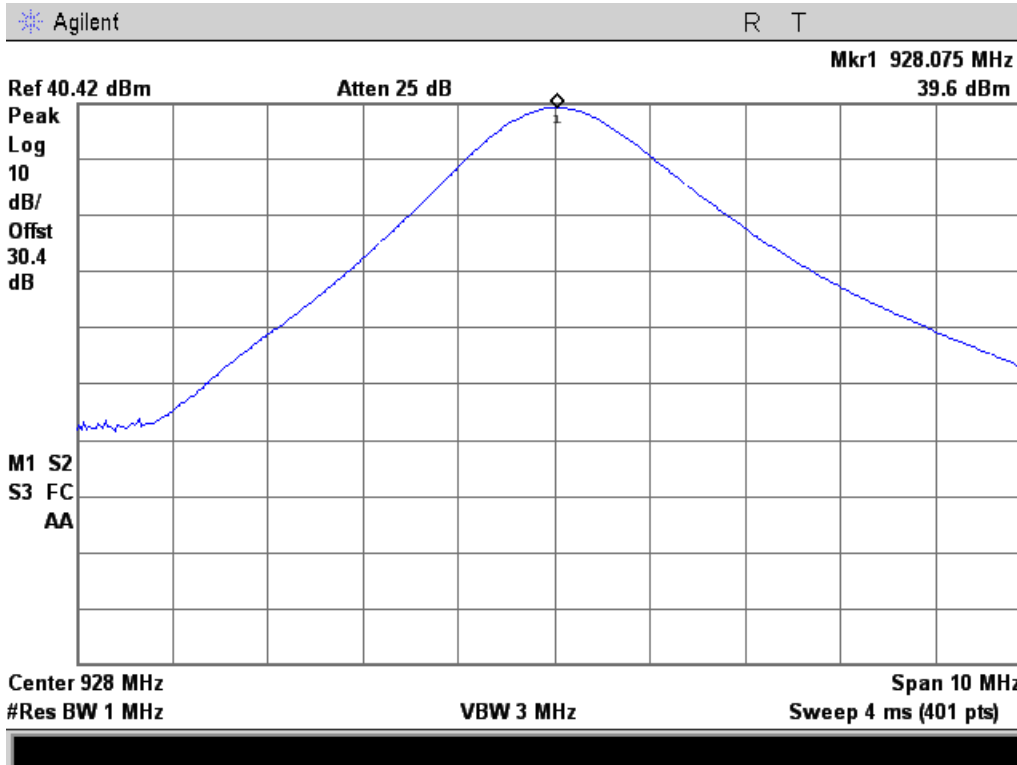

8K10F1D

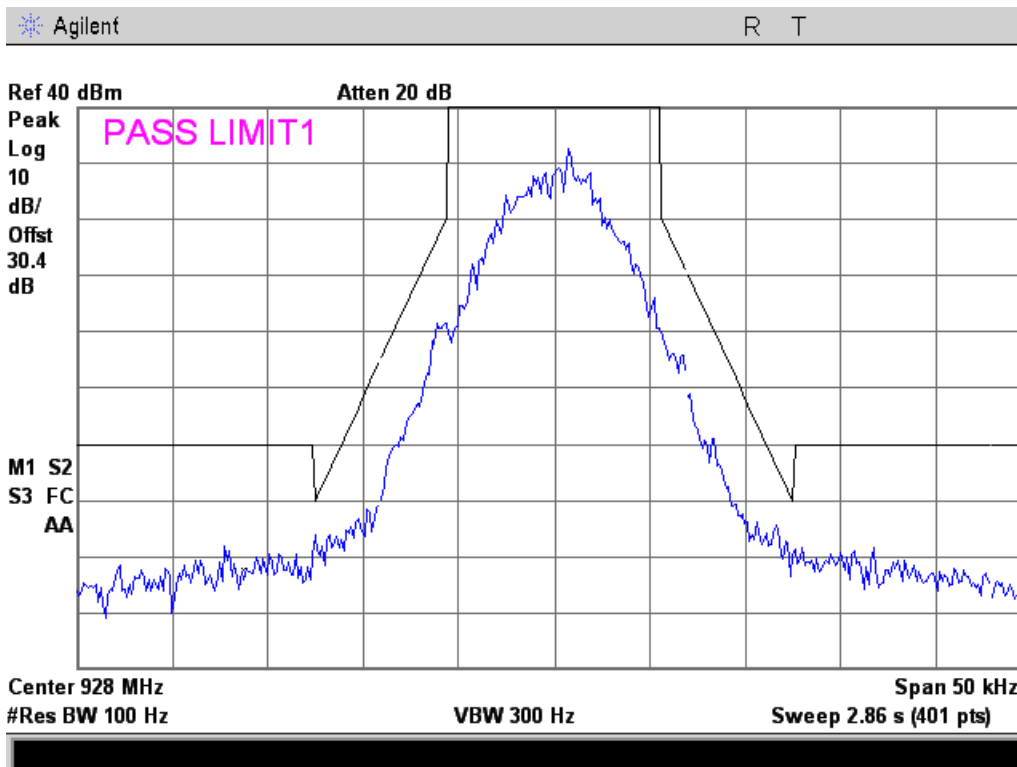



11K0F3E

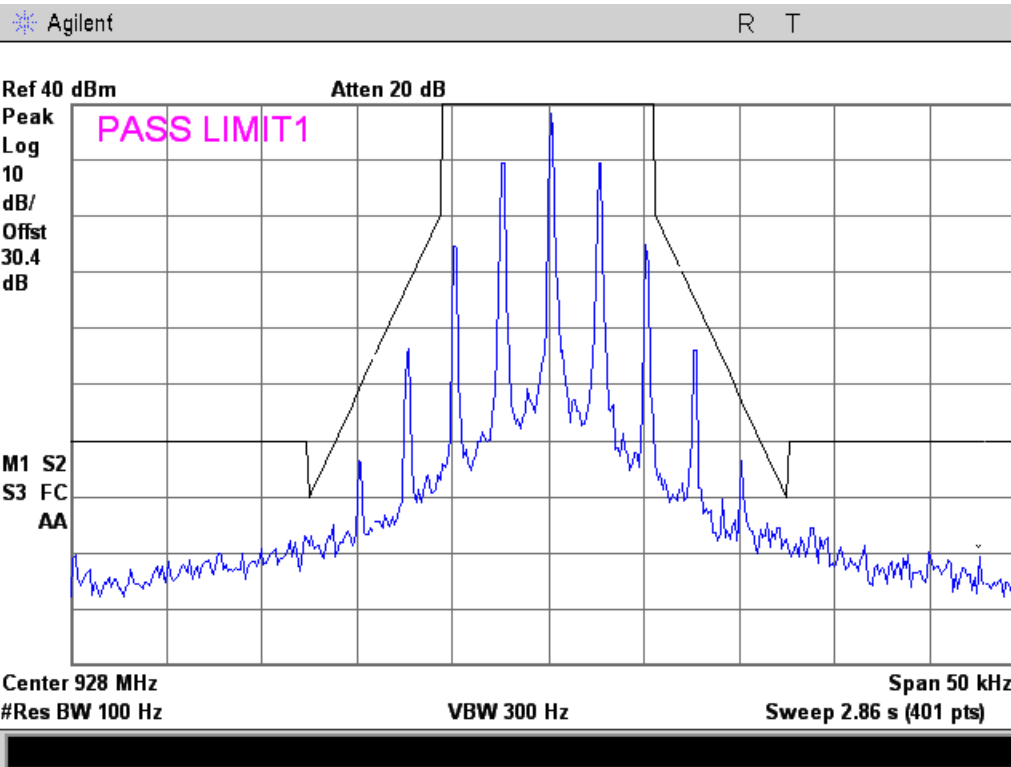

16K0F3E

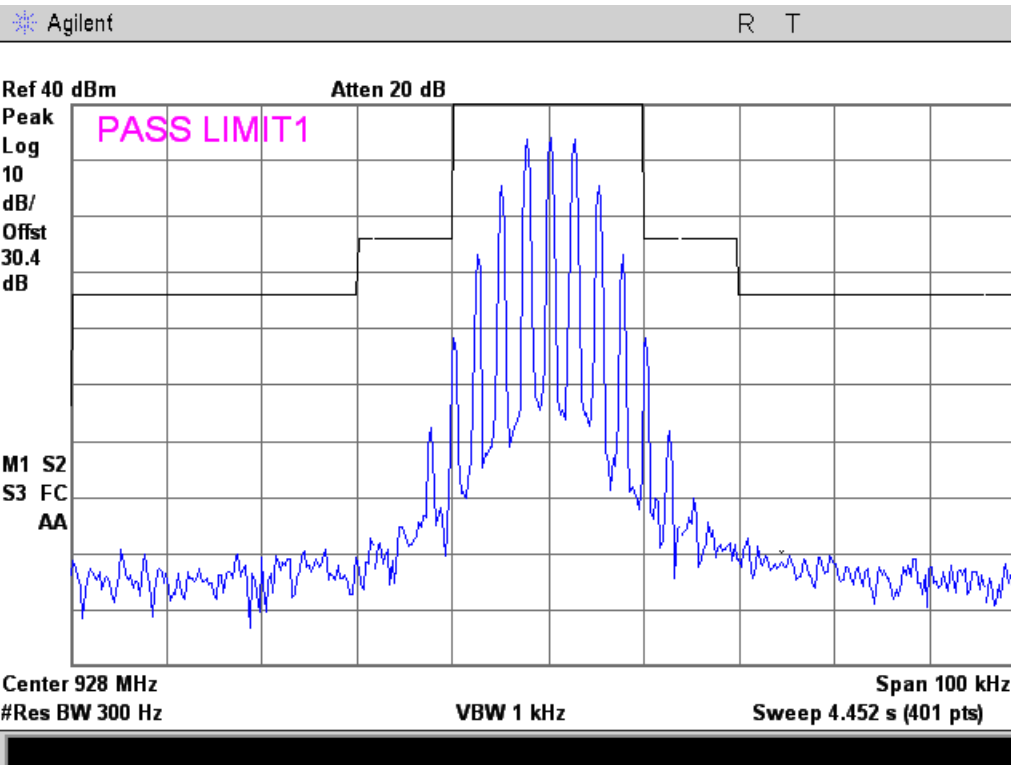



928.95 MHz Reference

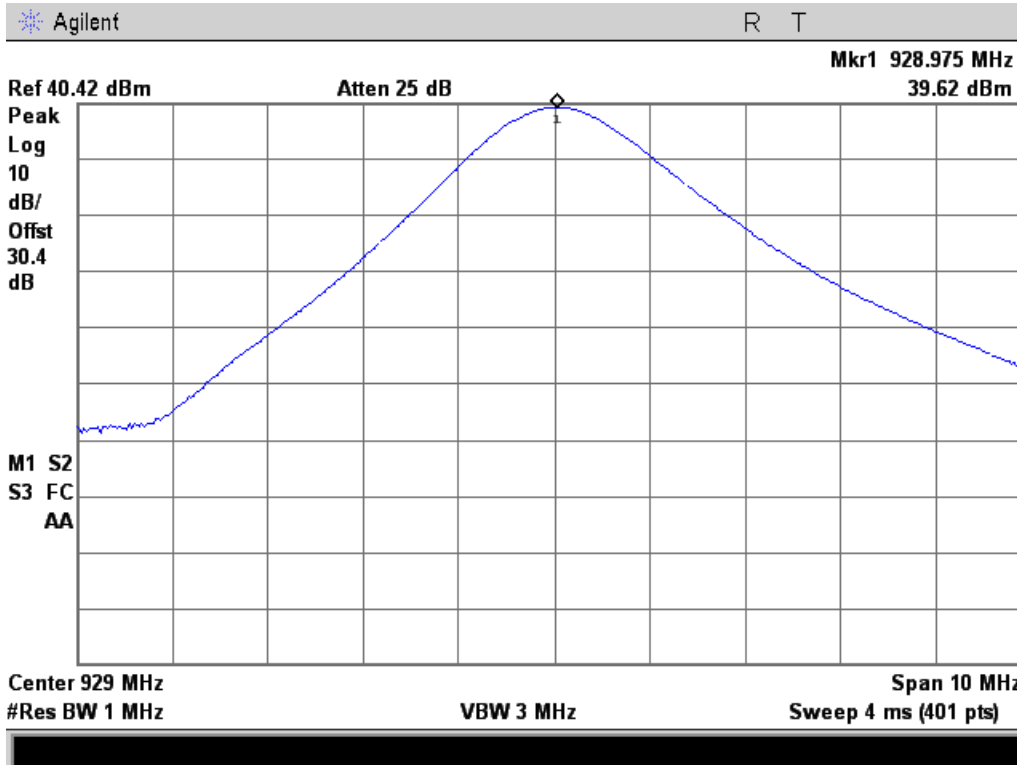

8K10F1D

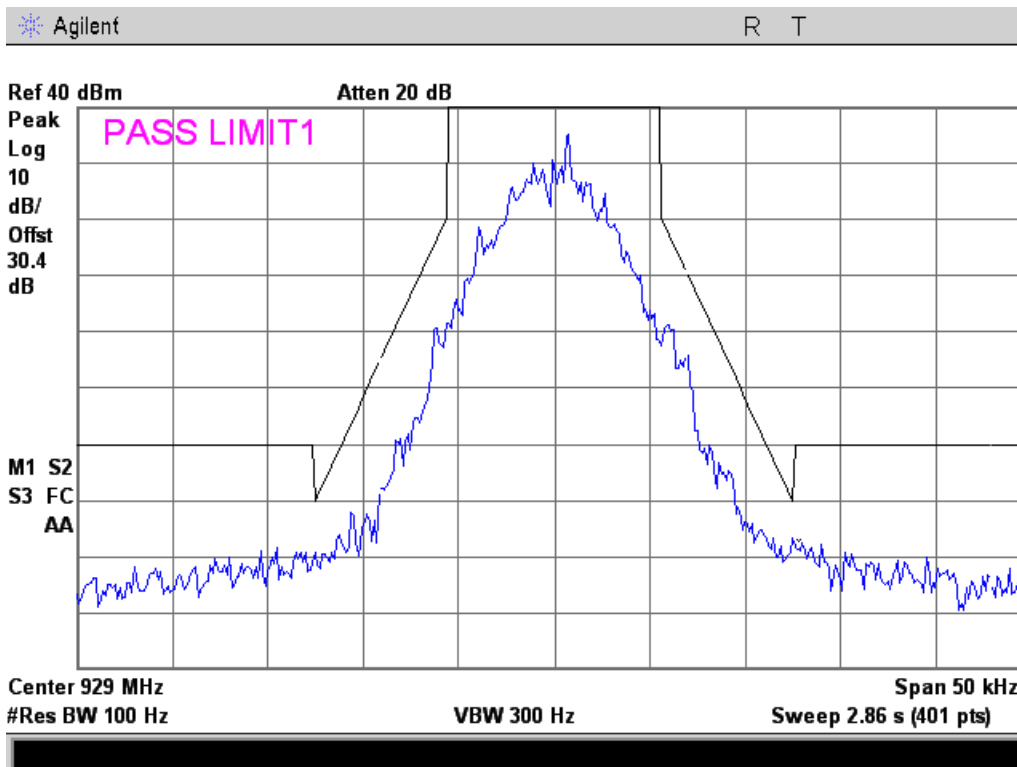



11K0F3E

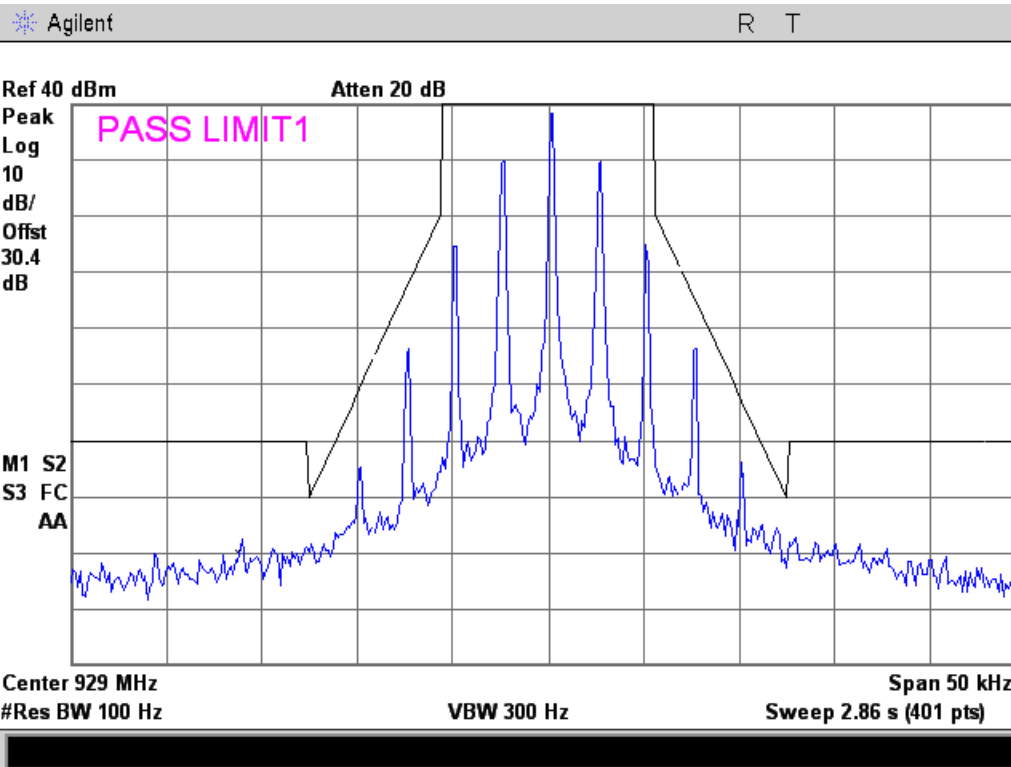

16K0F3E

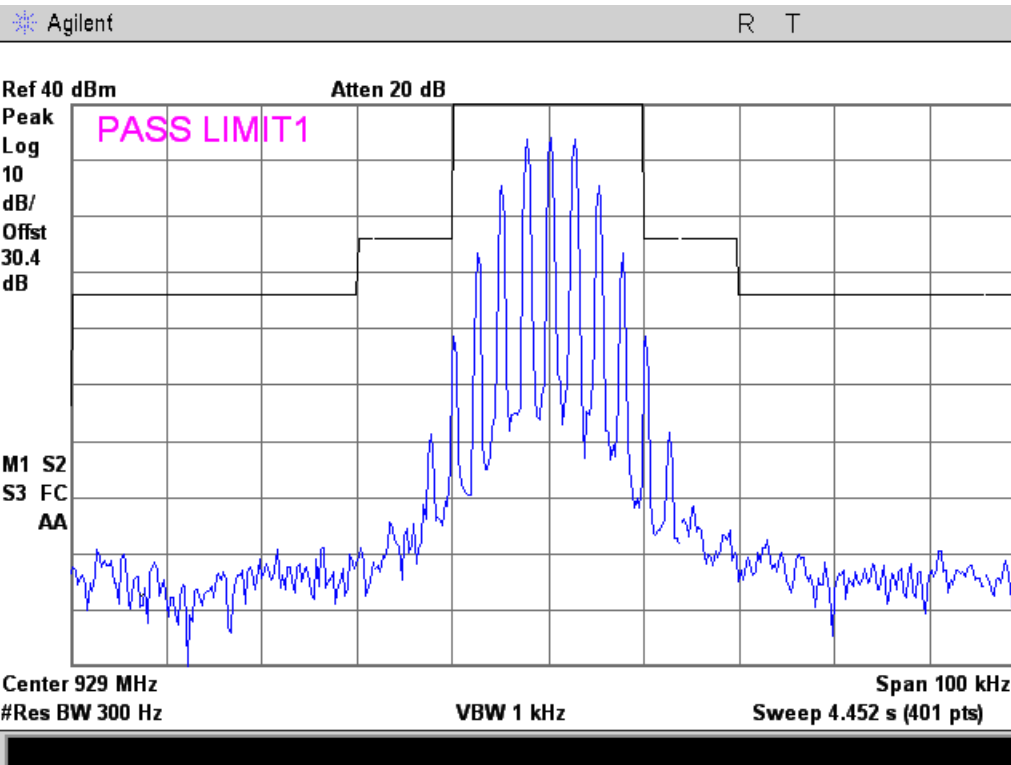



929.95 MHz Reference

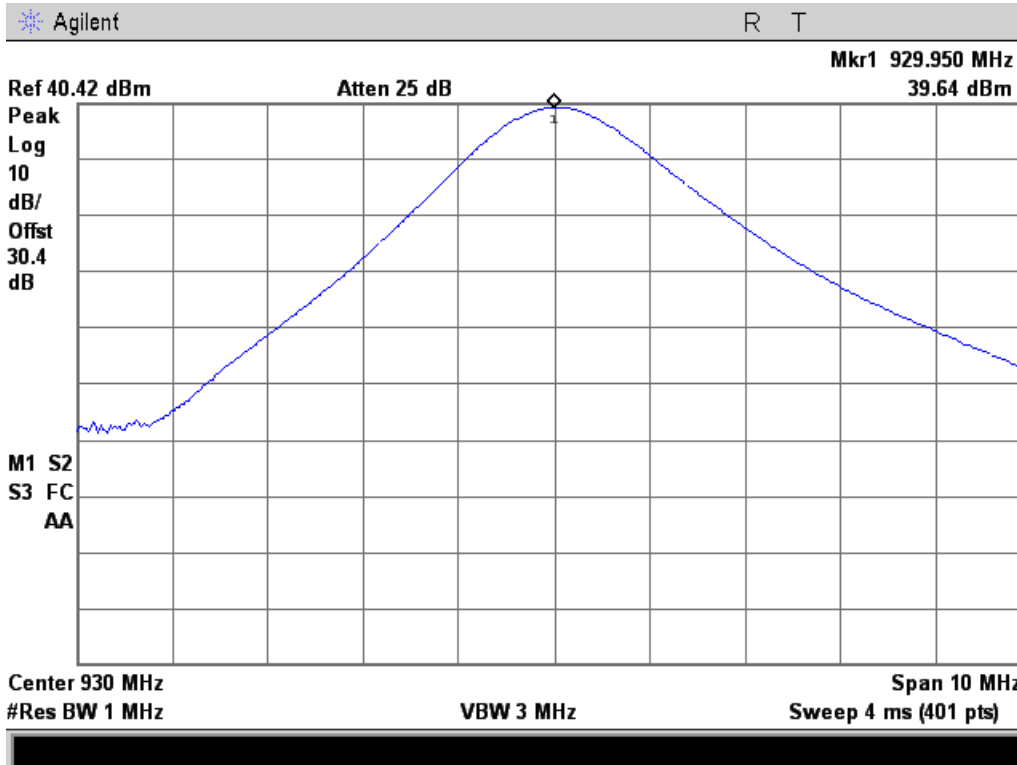

8K10F1D

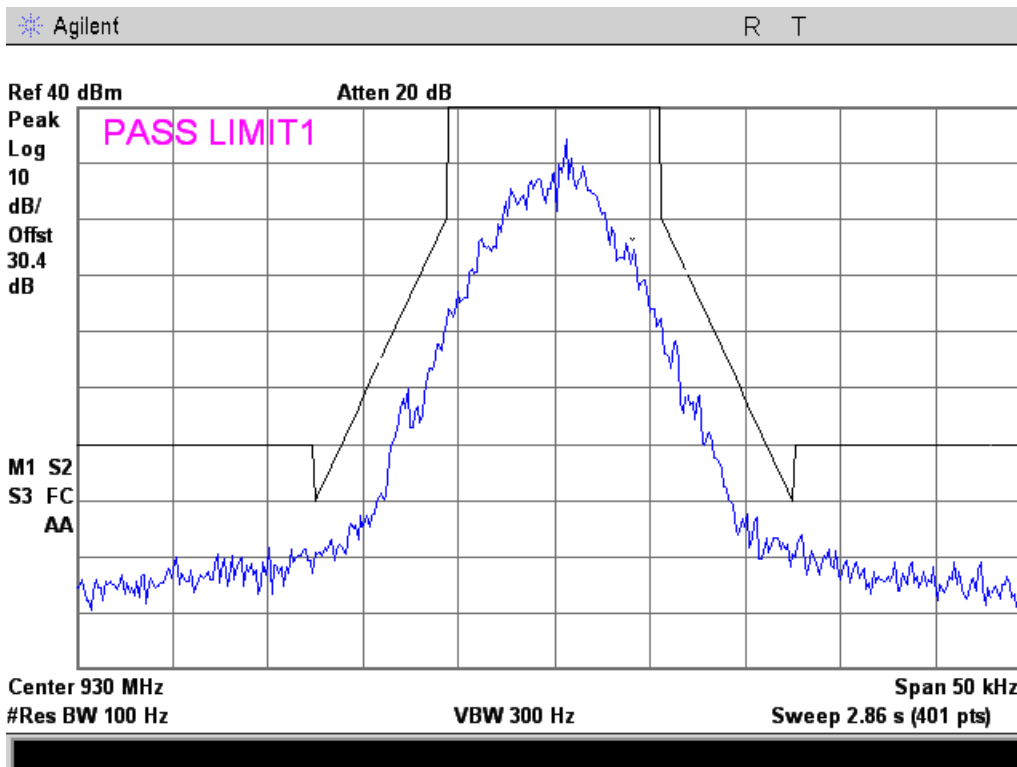



11K0F3E

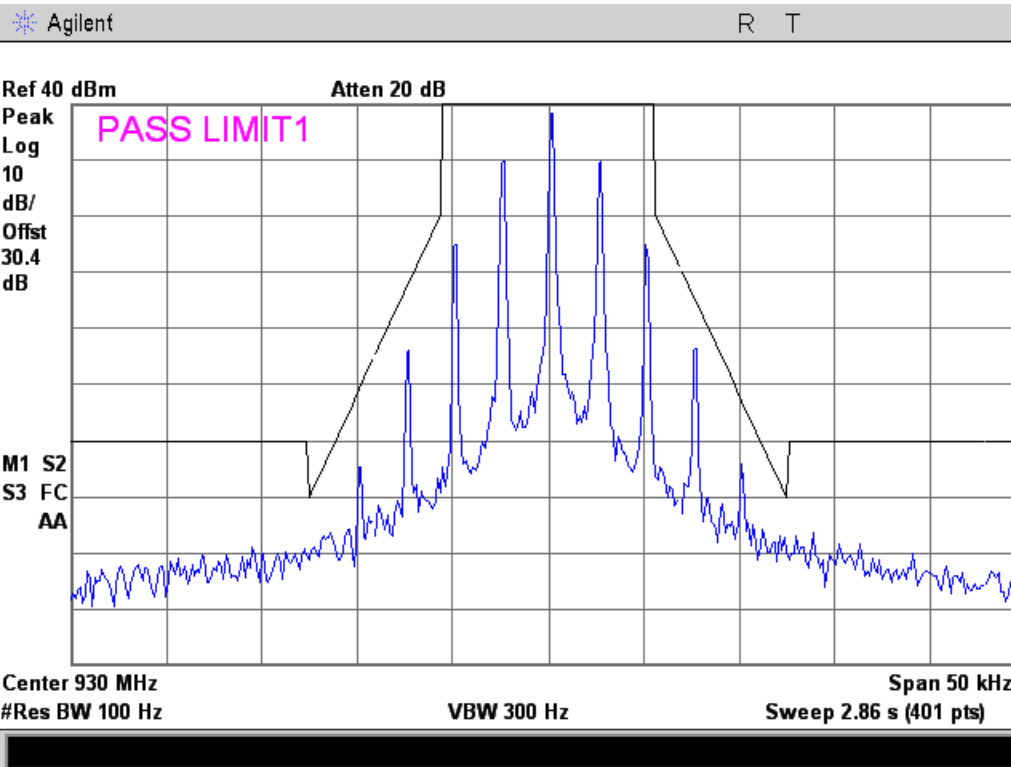

16K0F3E

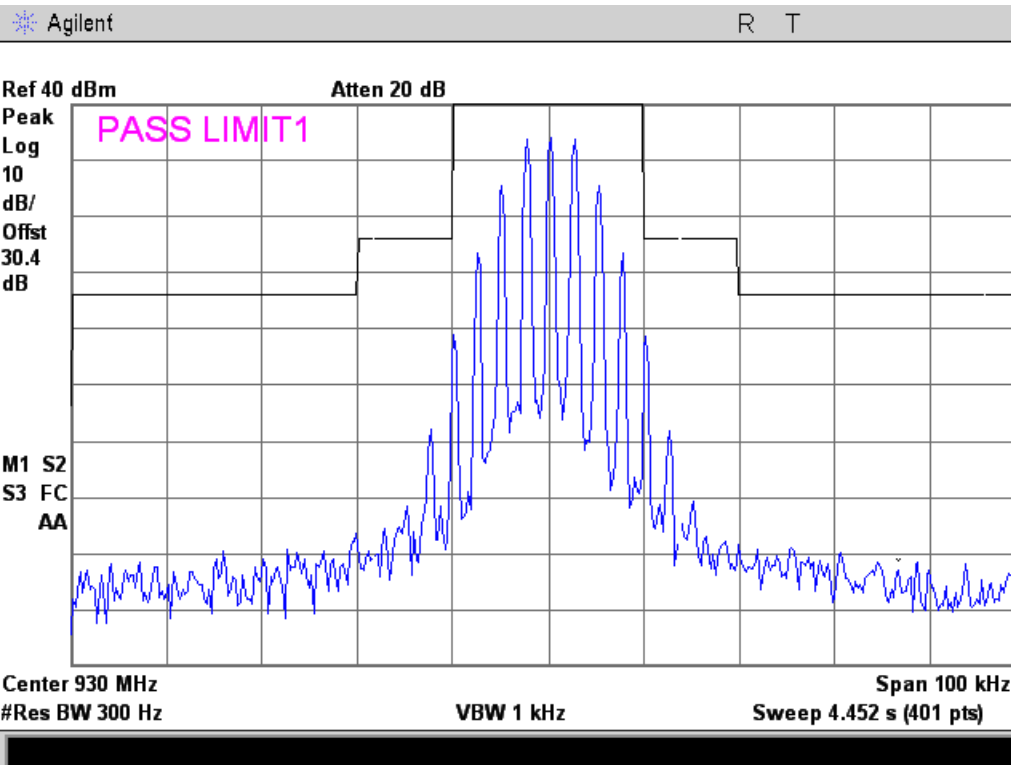



931.05 MHz Reference

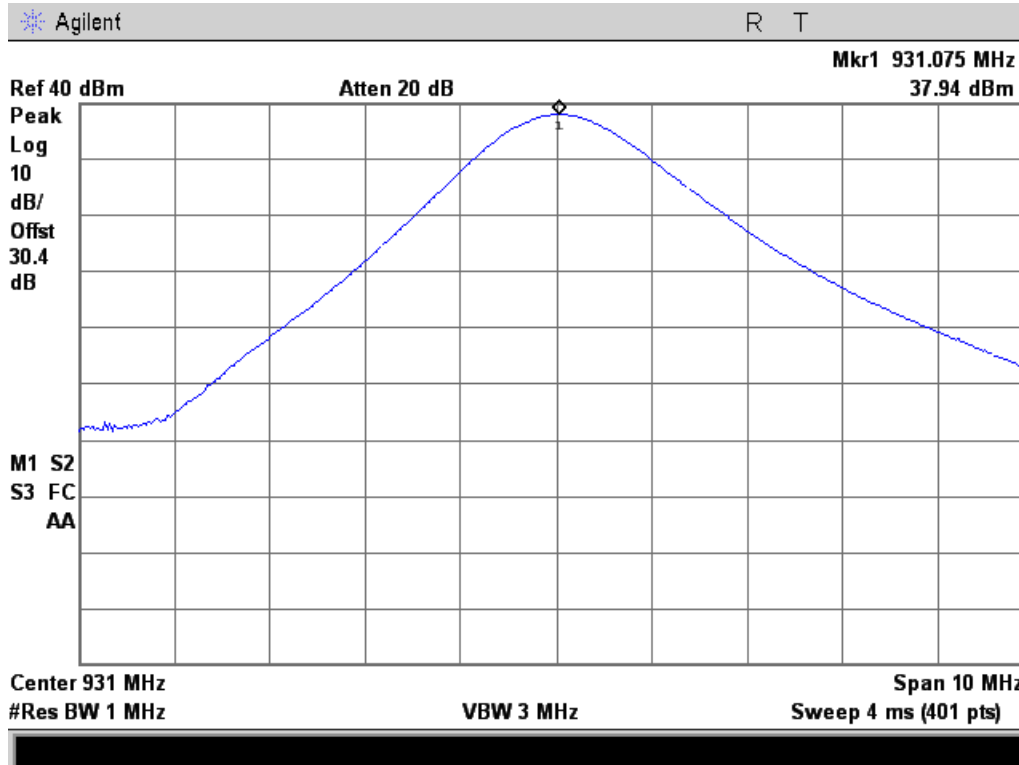

8K10F1D

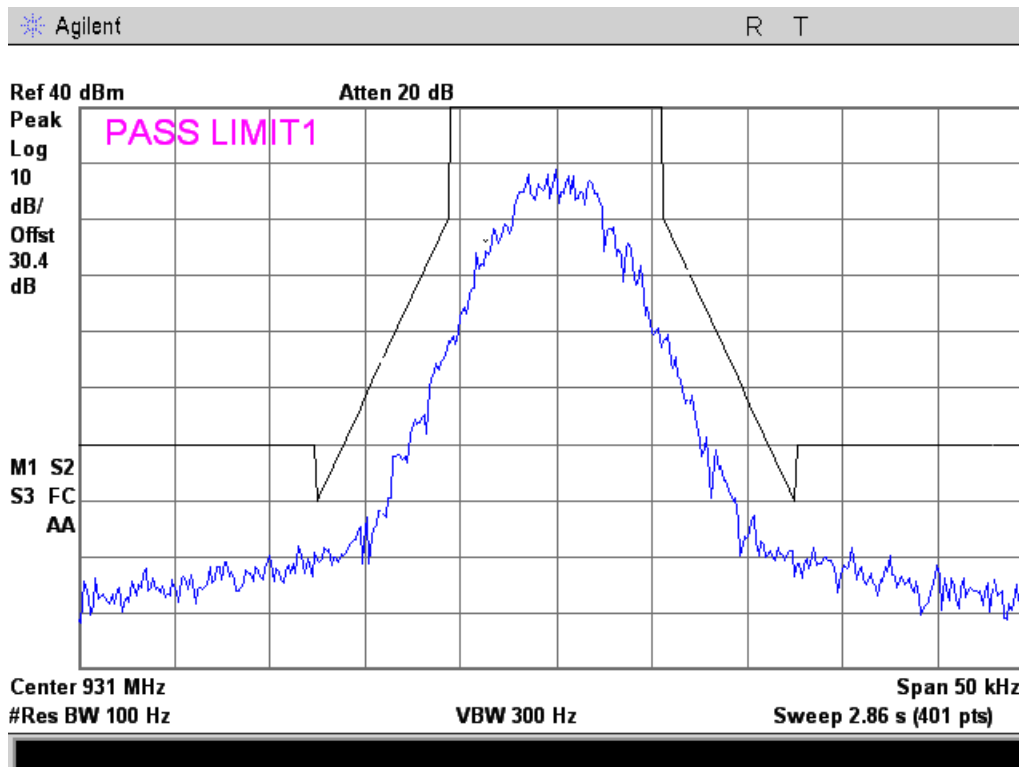



11K0F3E

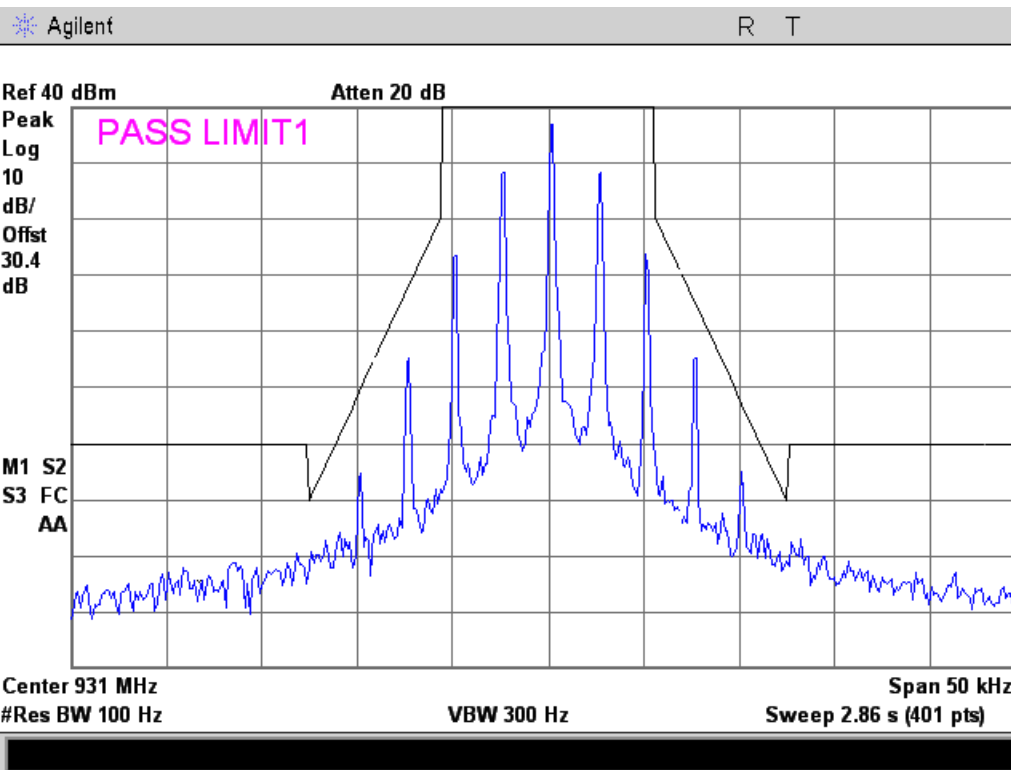

16K0F3E

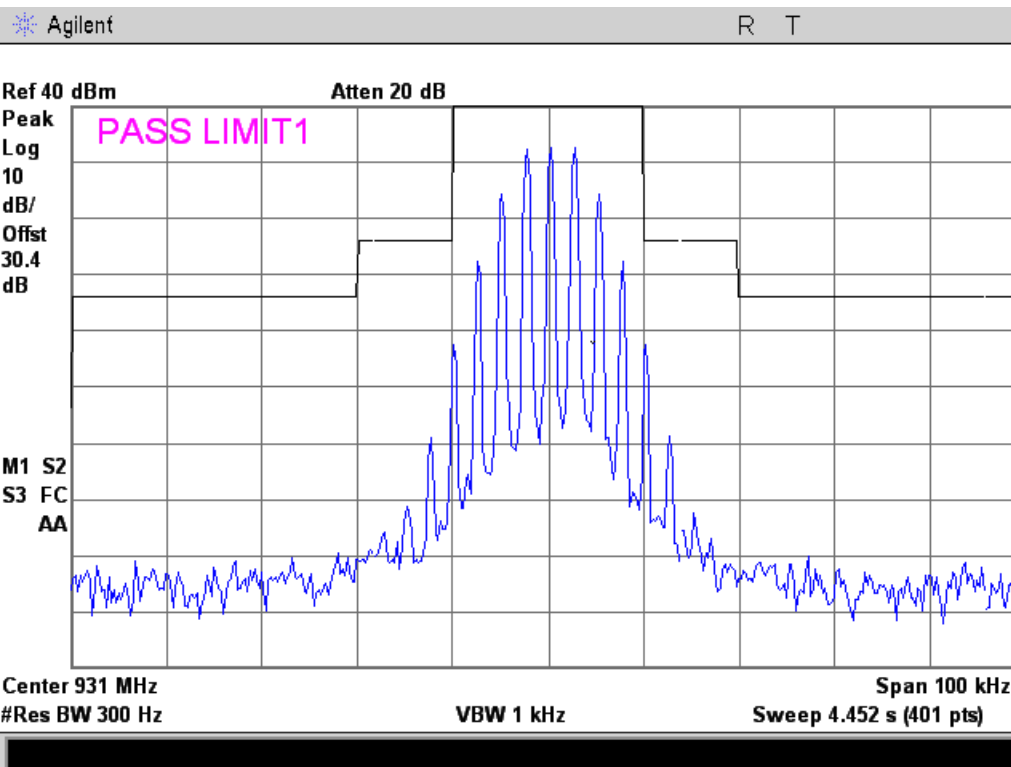



934.95 MHz Reference

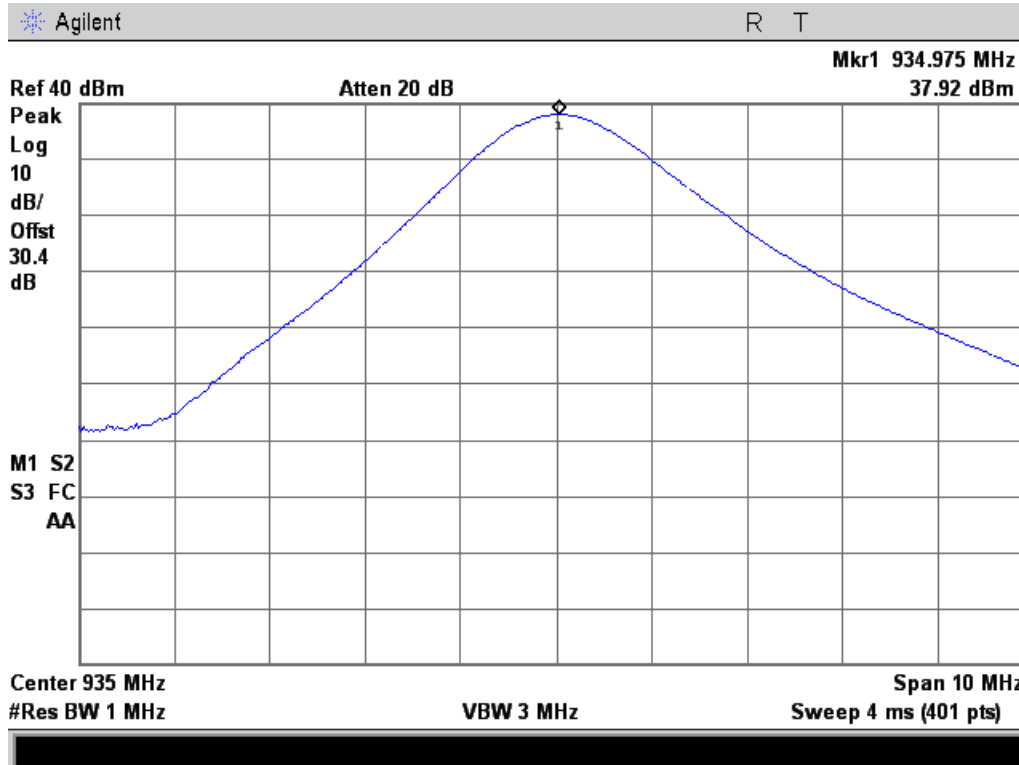

8K10F1D

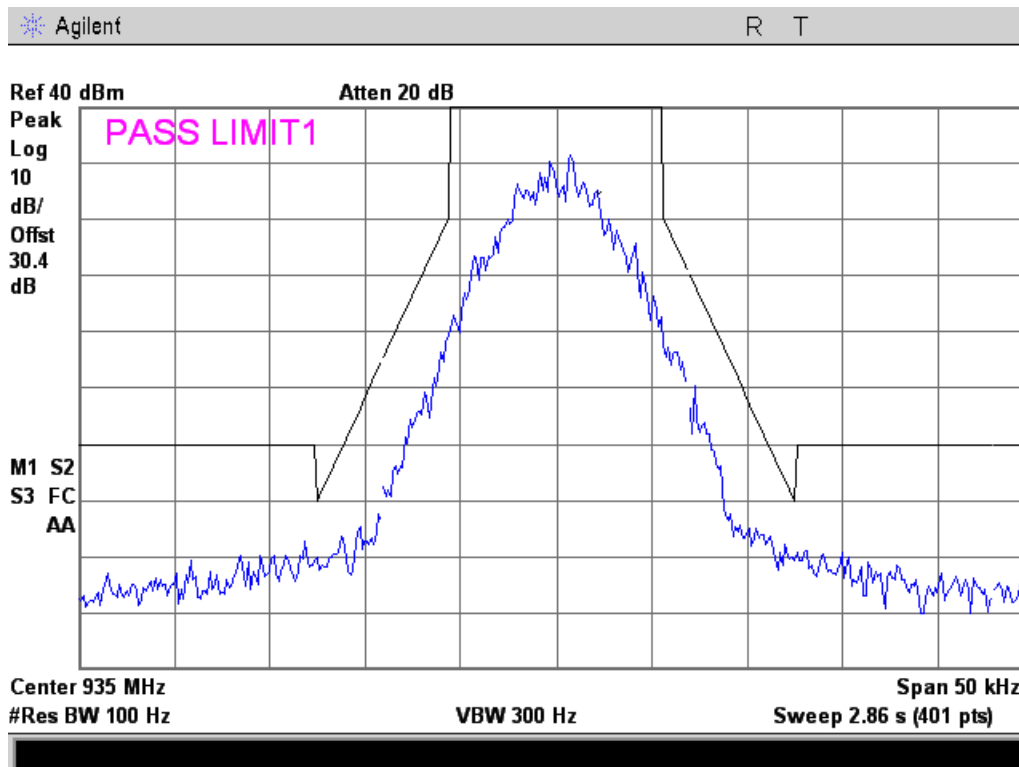



11K0F3E

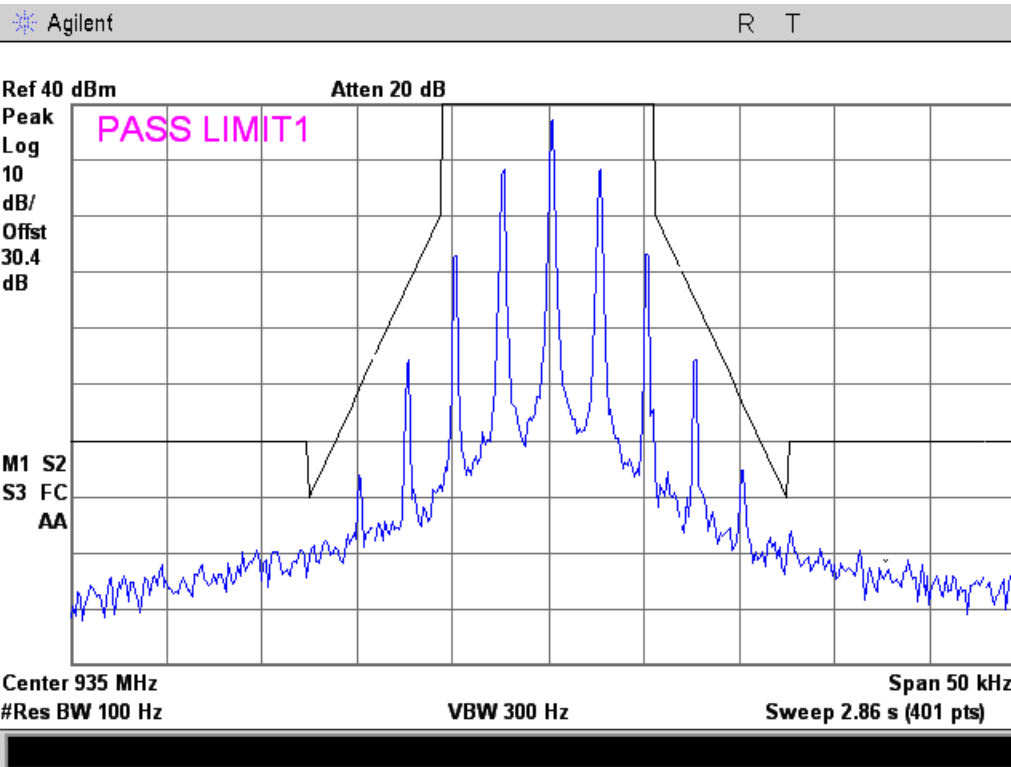

16K0F3E

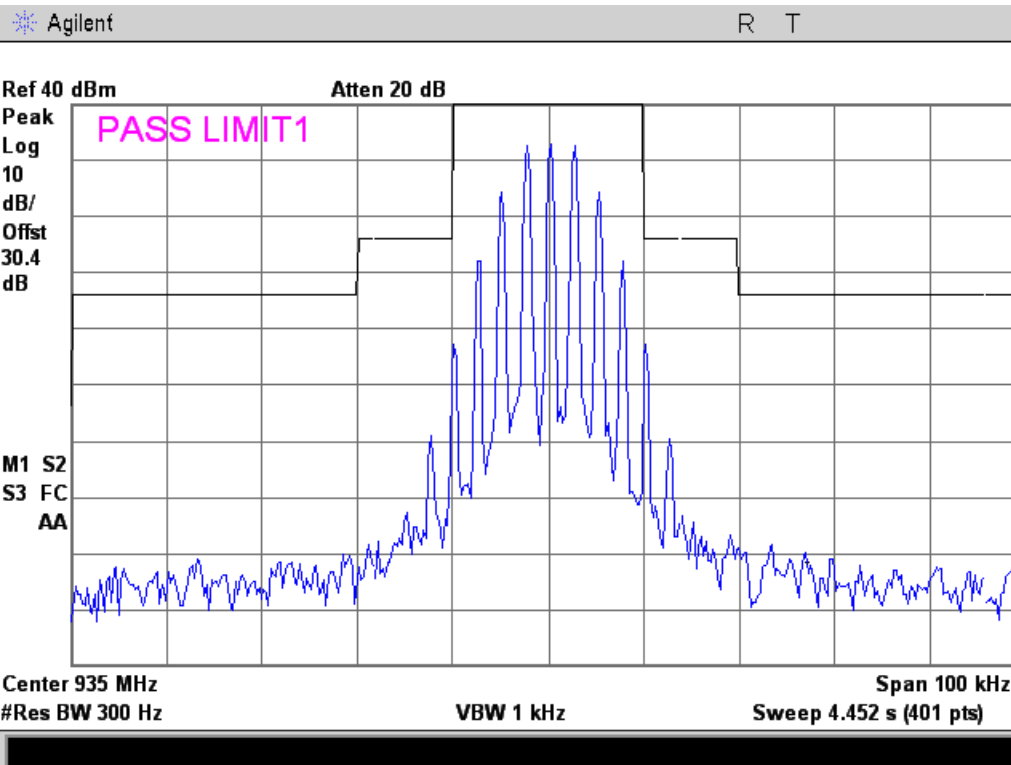



935.05 MHz Reference

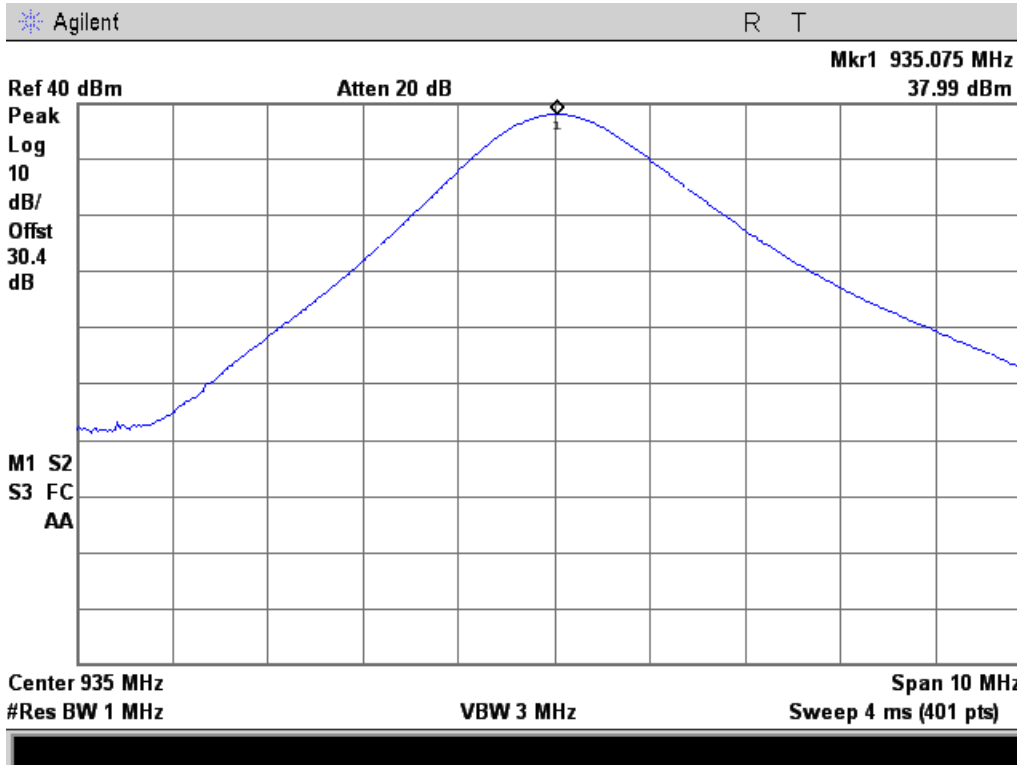

8K10F1D

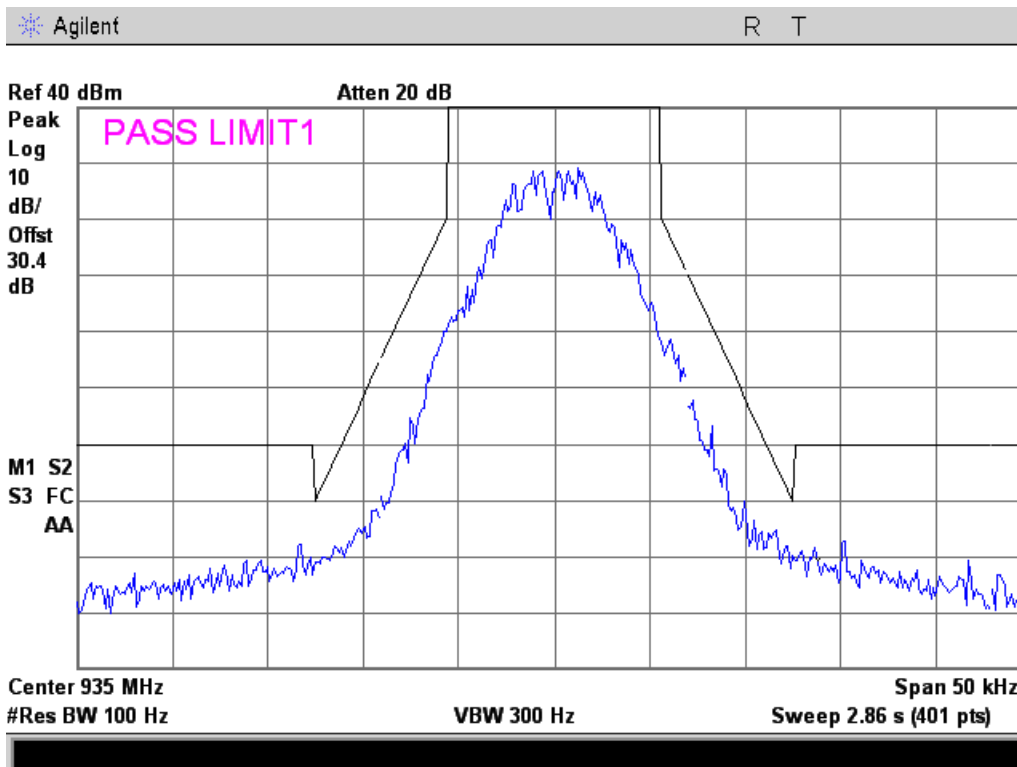



11K0F3E

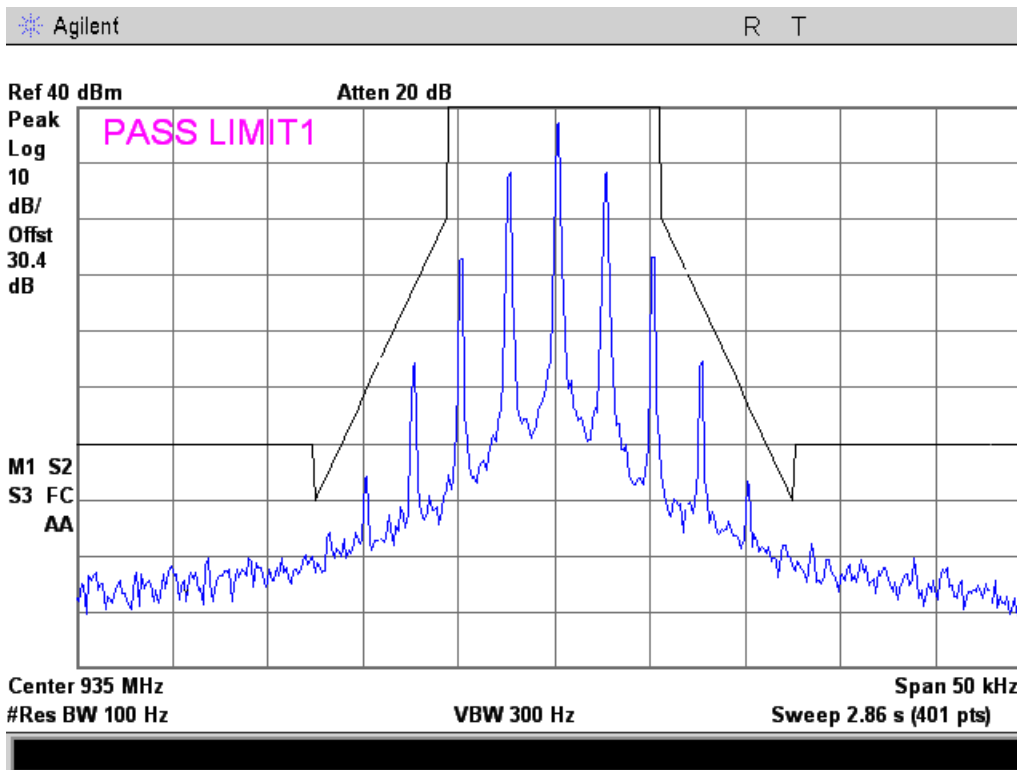

16K0F3E

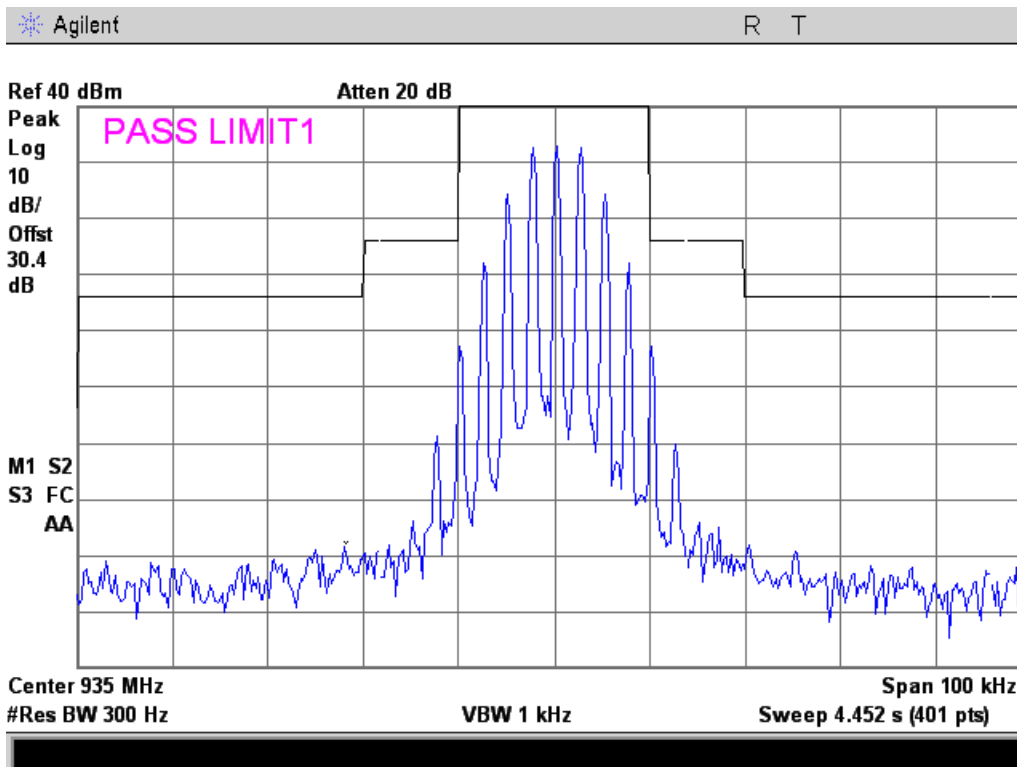



939.95 MHz Reference

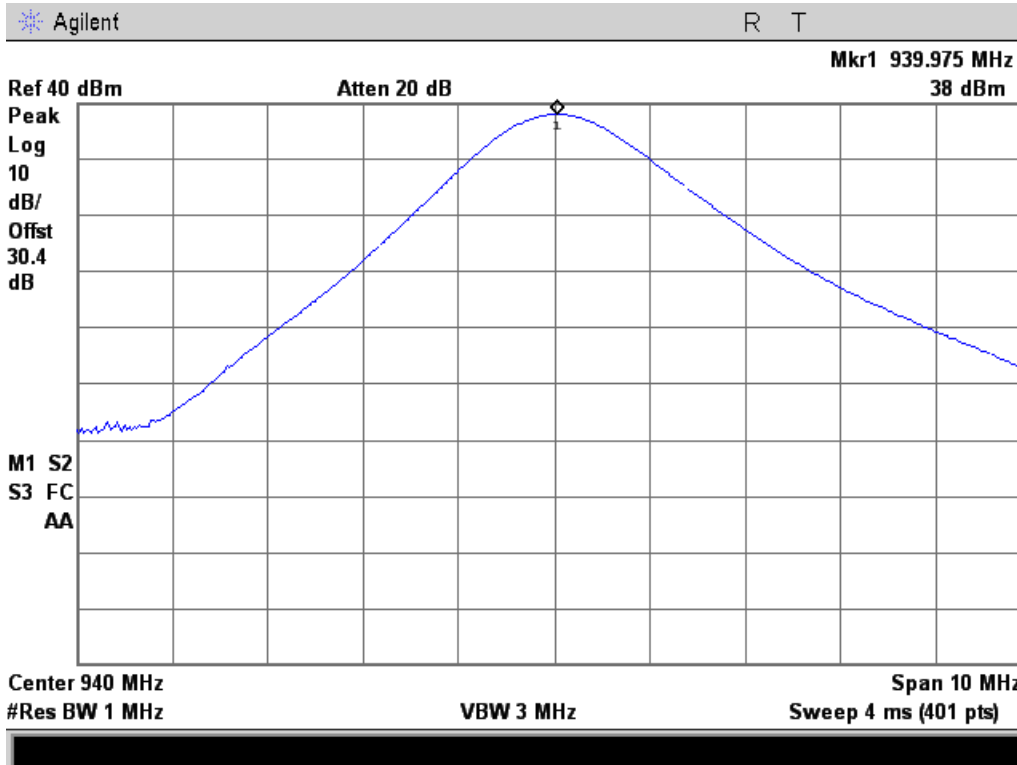

8K10F1D

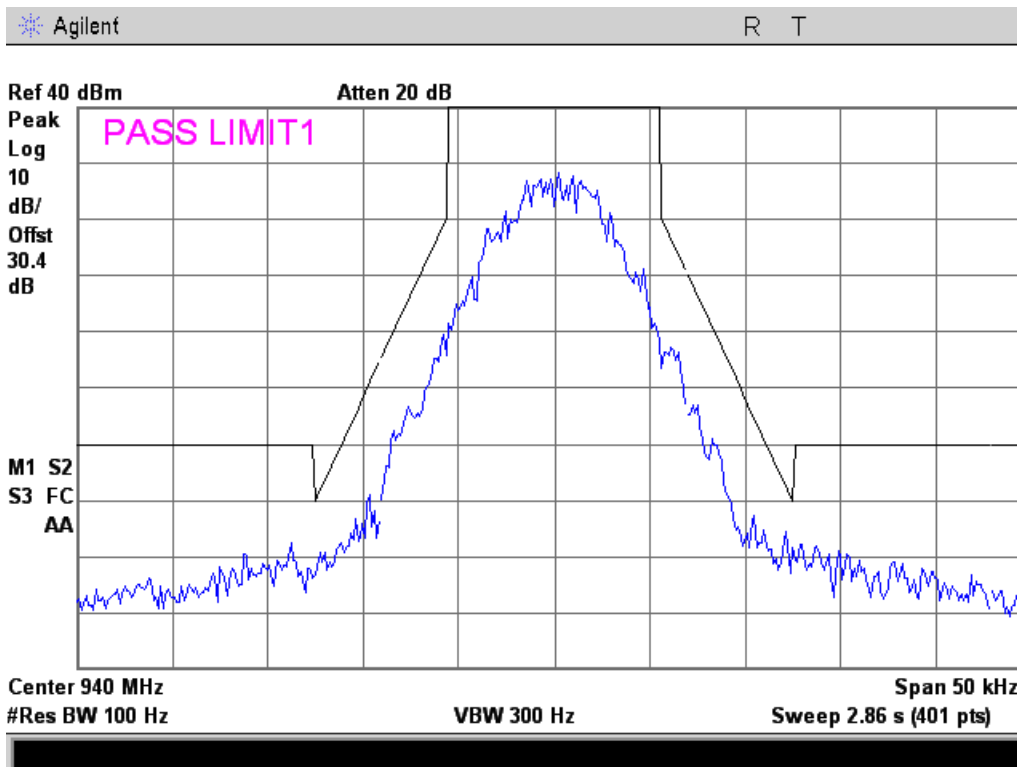



11K0F3E

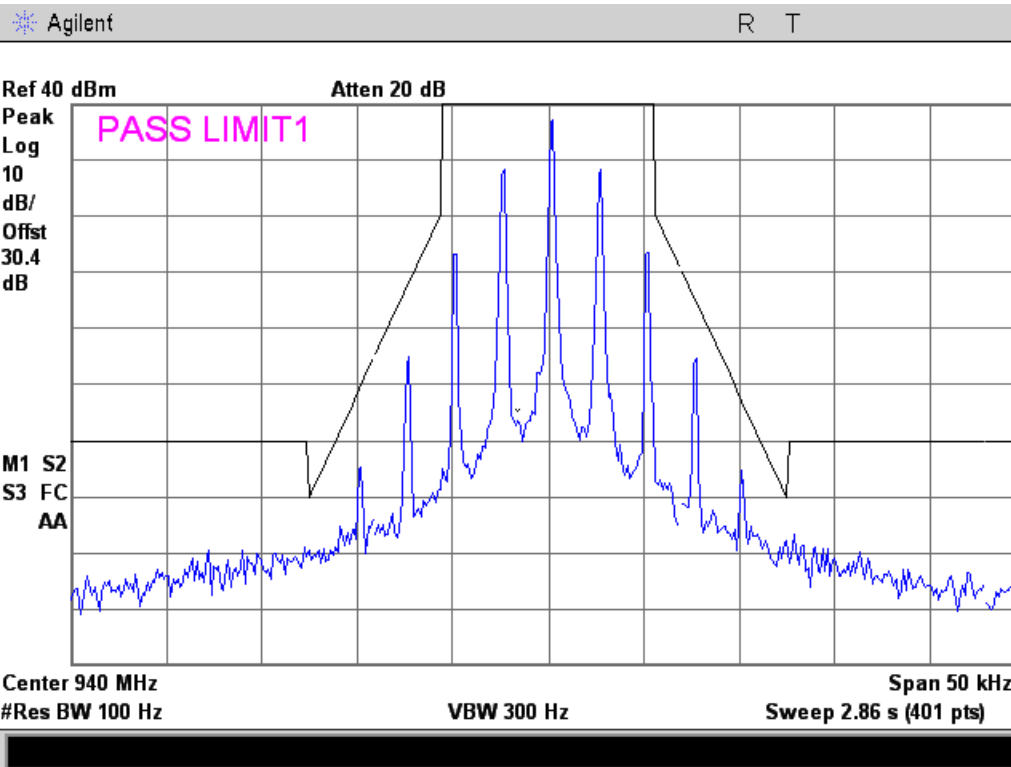

16K0F3E

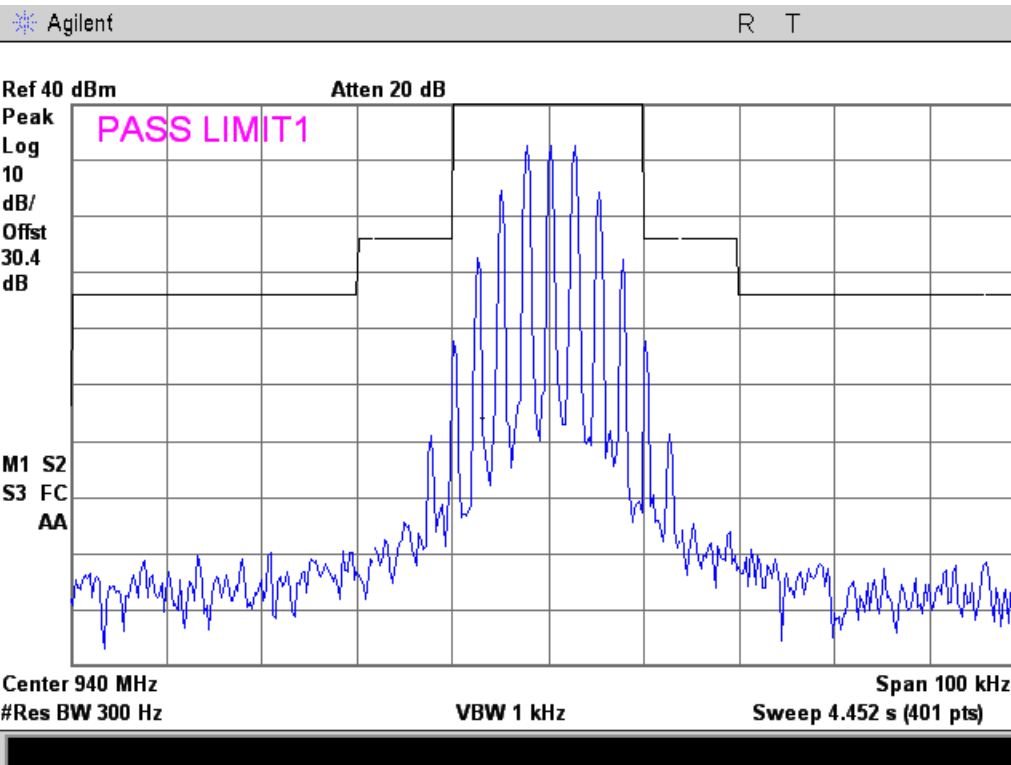



941.05 MHz Reference

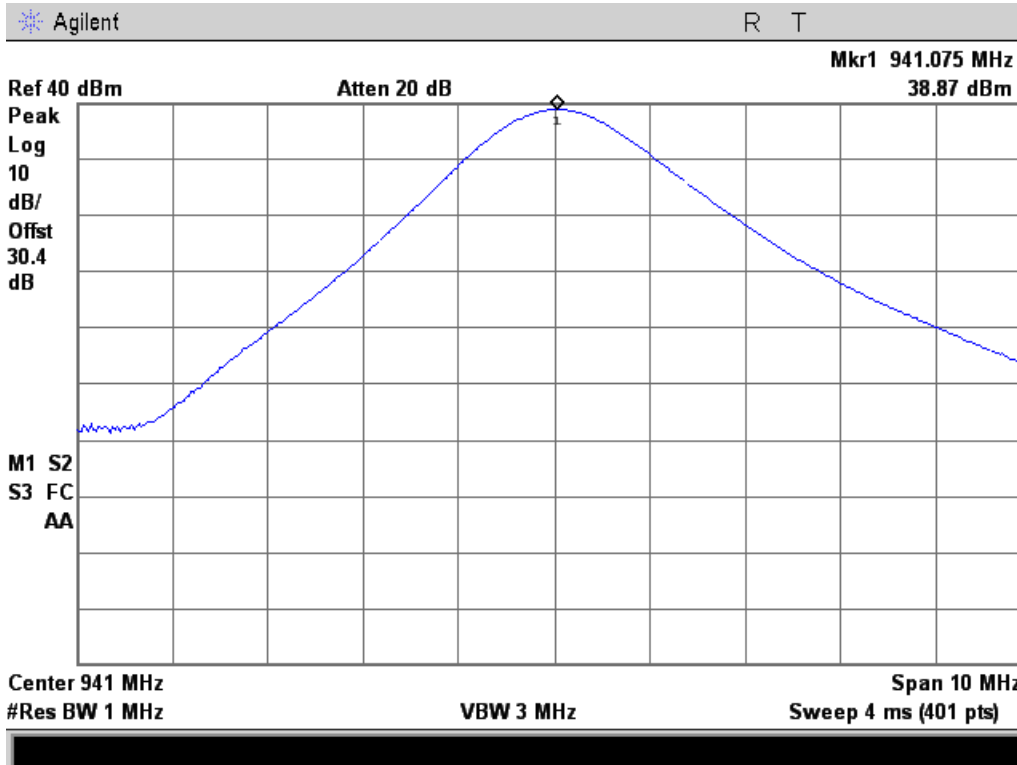

8K10F1D

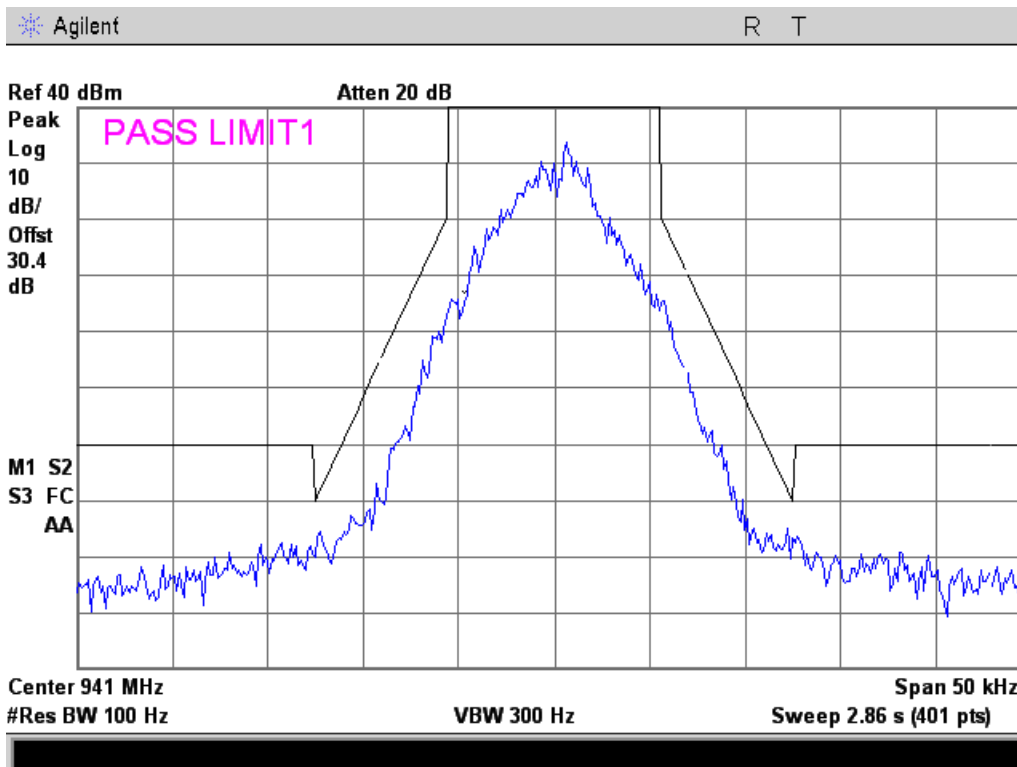



11K0F3E

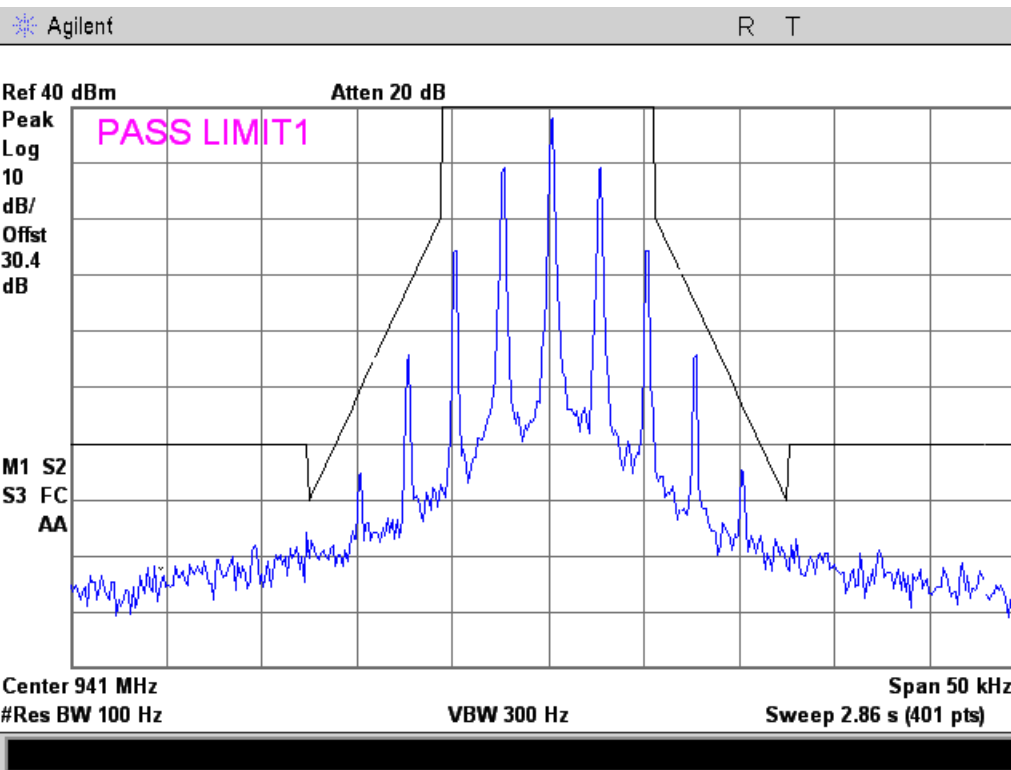

16K0F3E

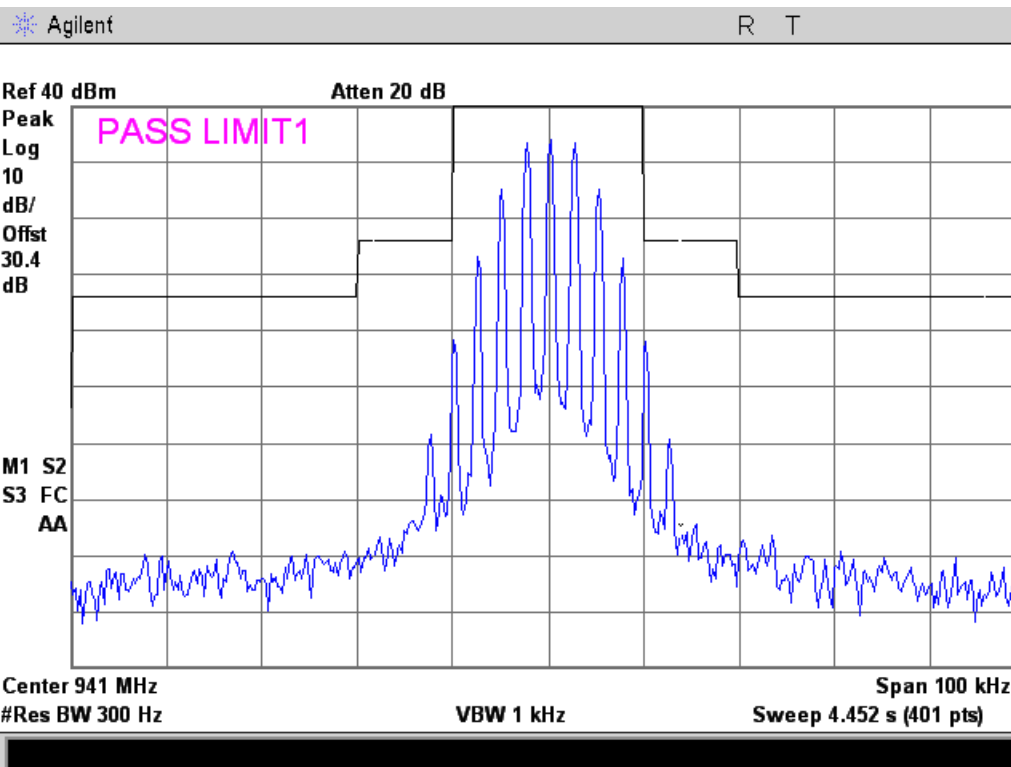



950.05 MHz Reference

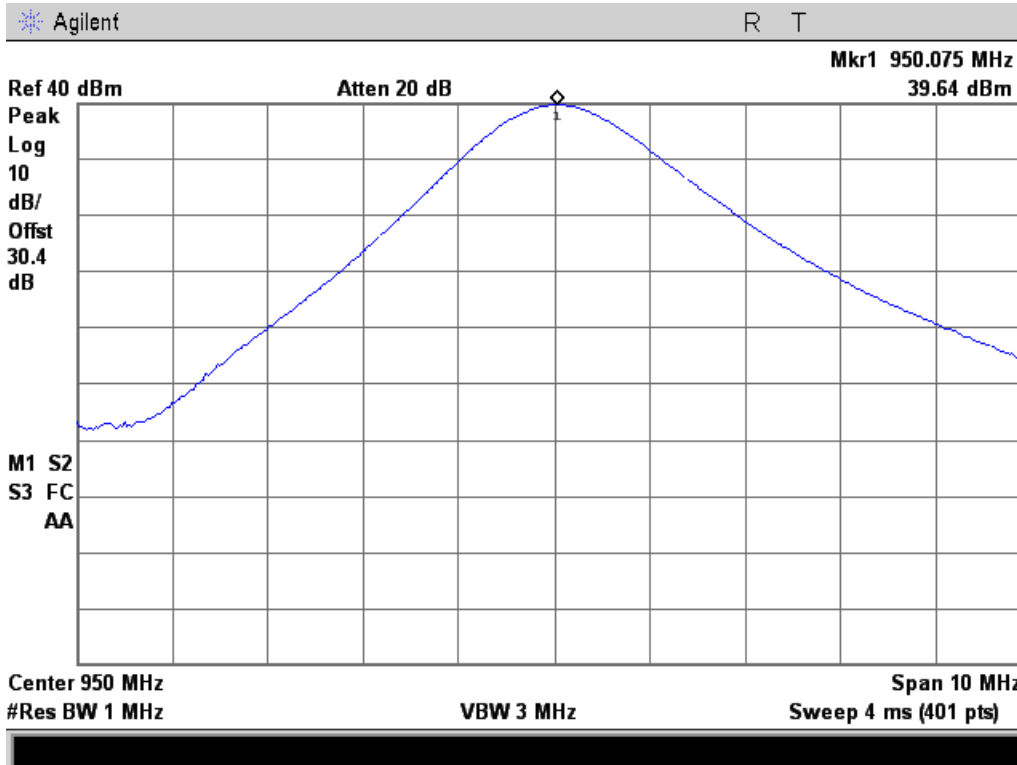

8K10F1D

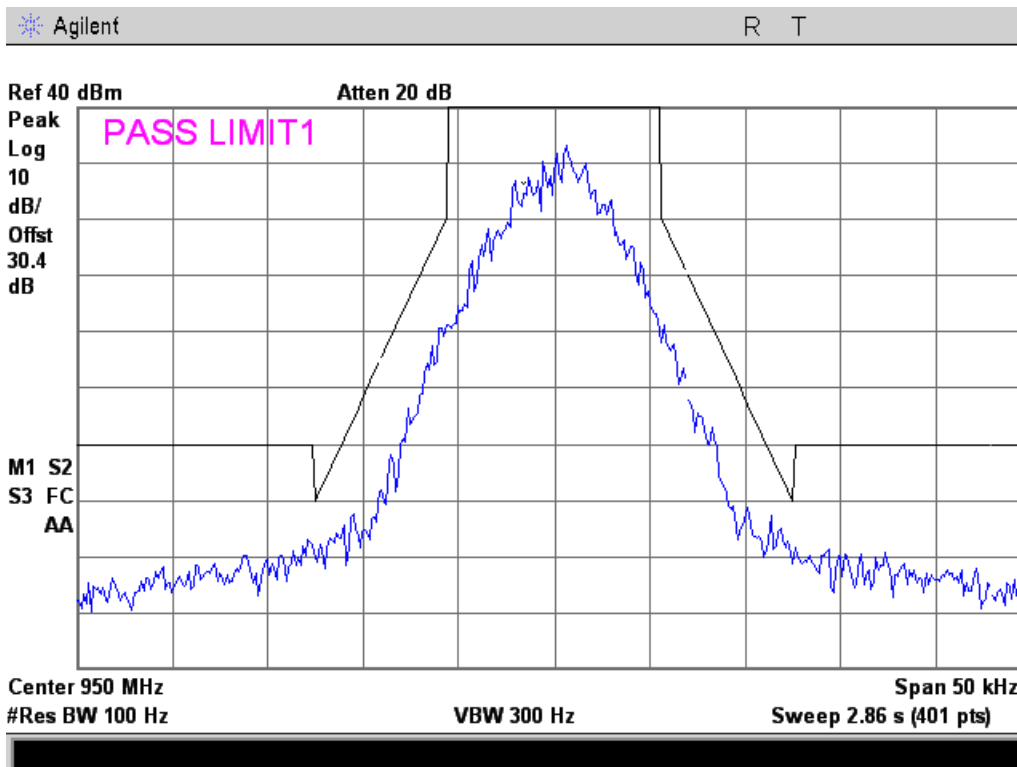



11K0F3E

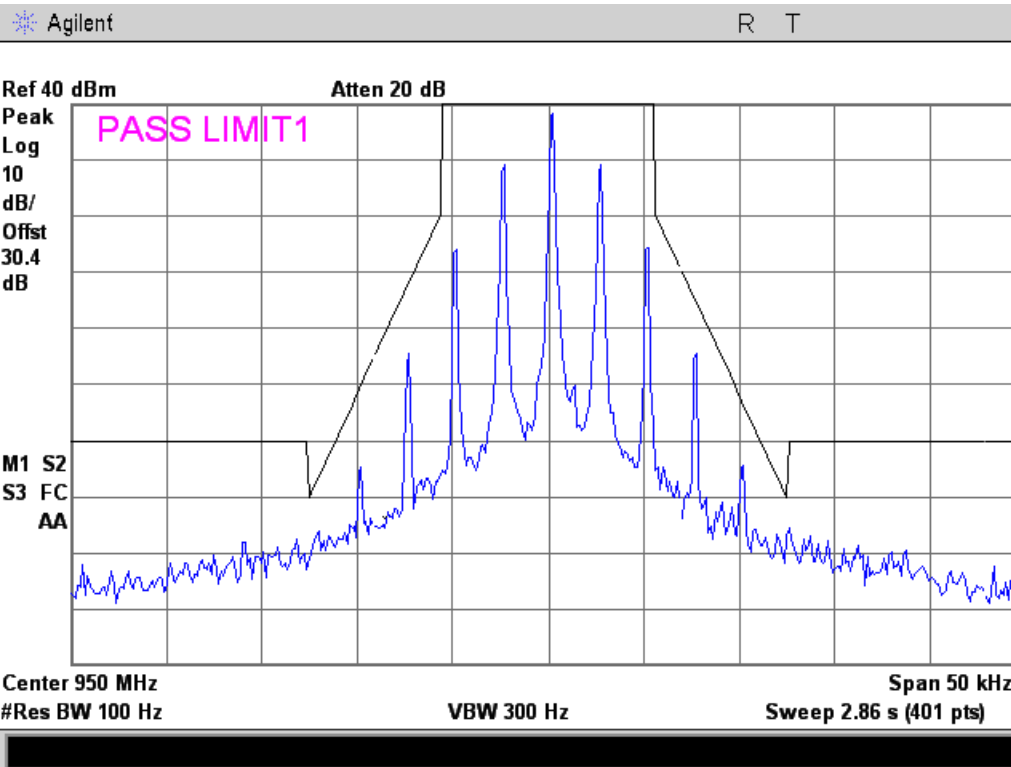

16K0F3E

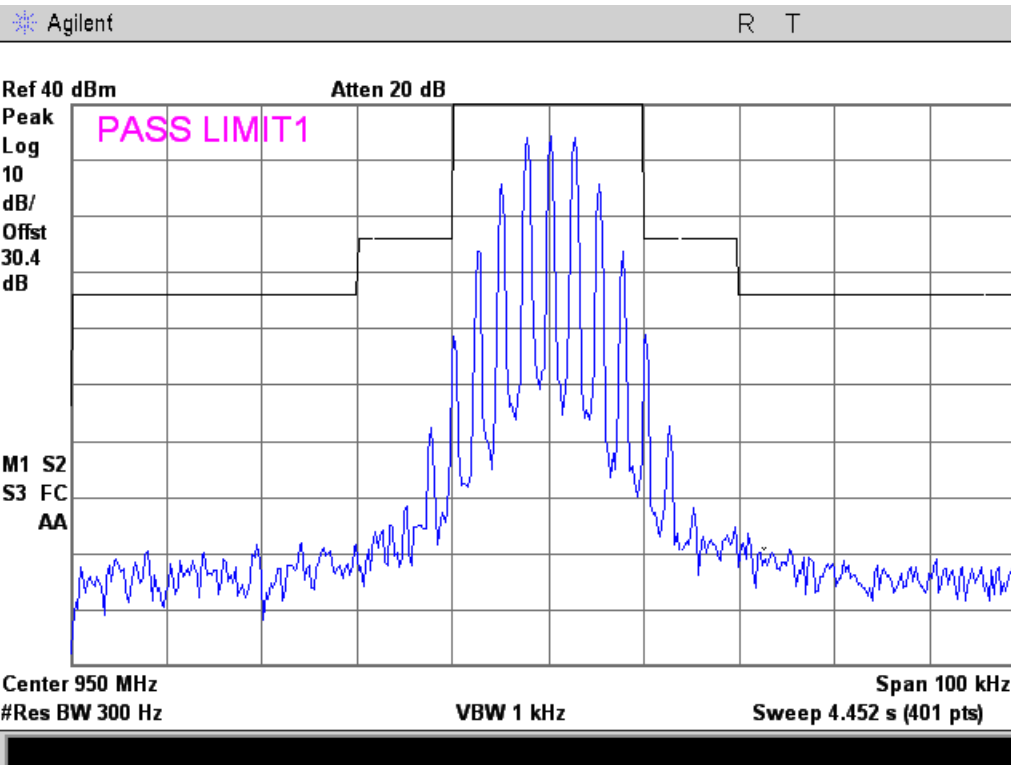



959.95 MHz Reference

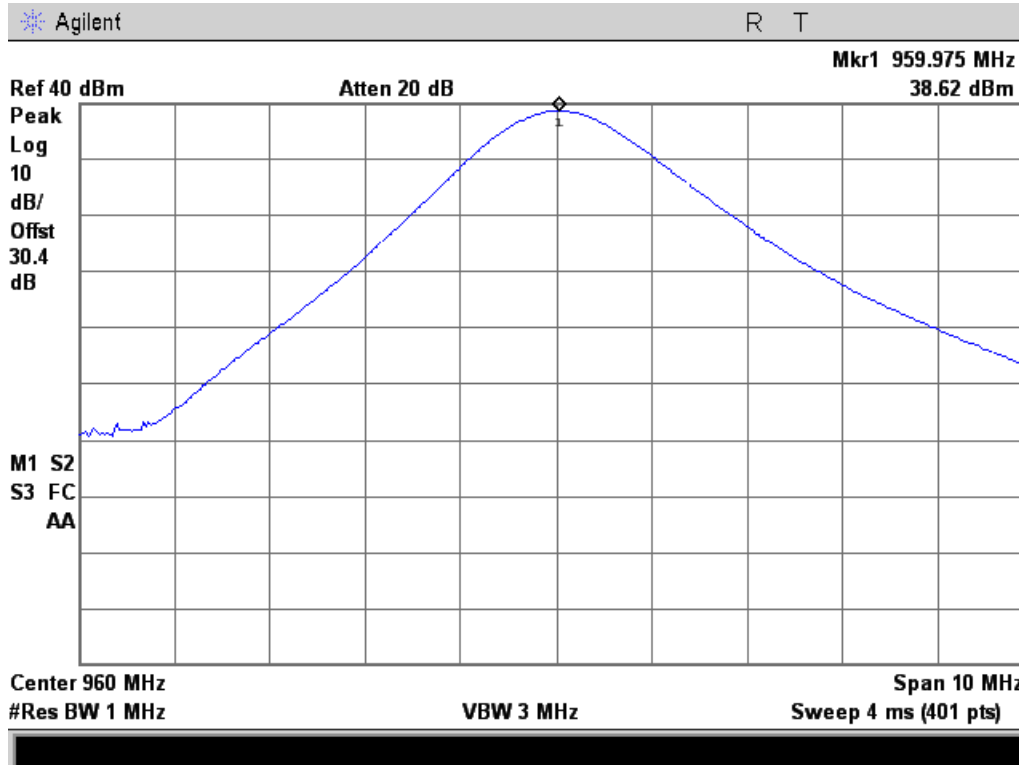

8K10F1D

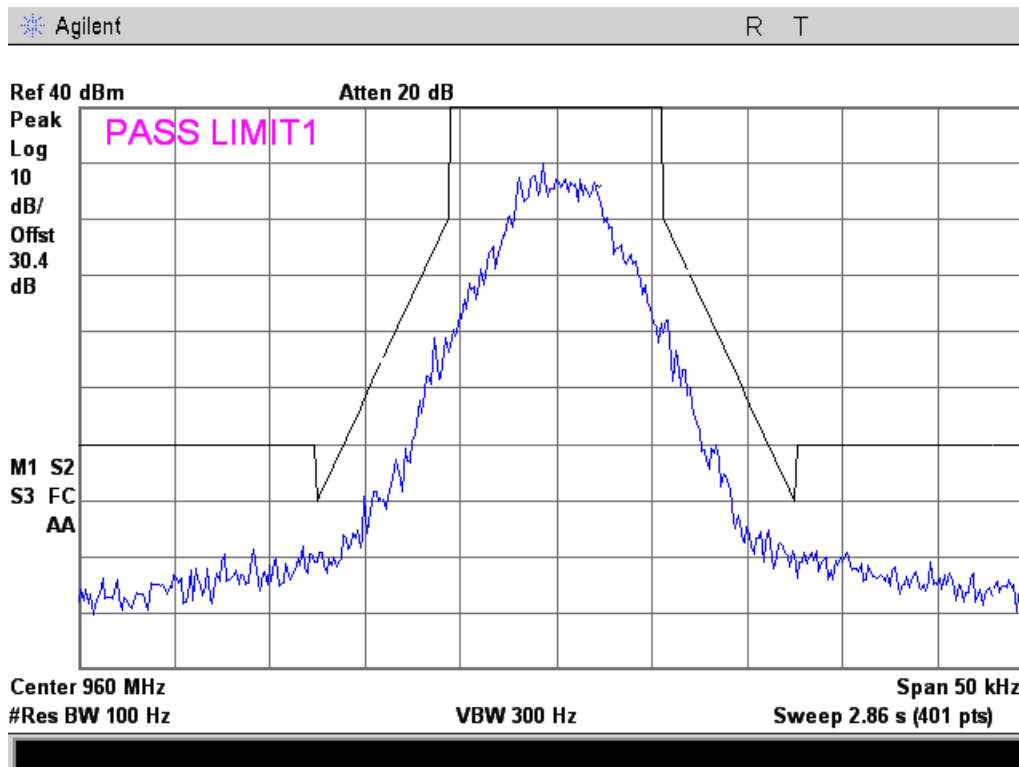



11K0F3E

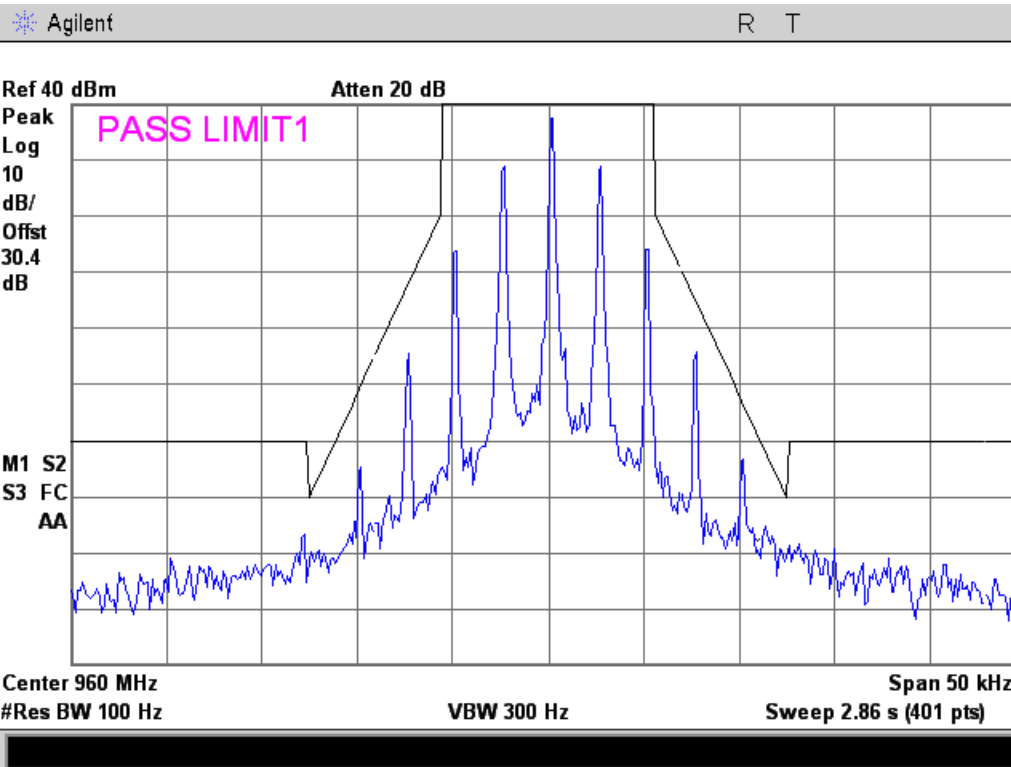

16K0F3E

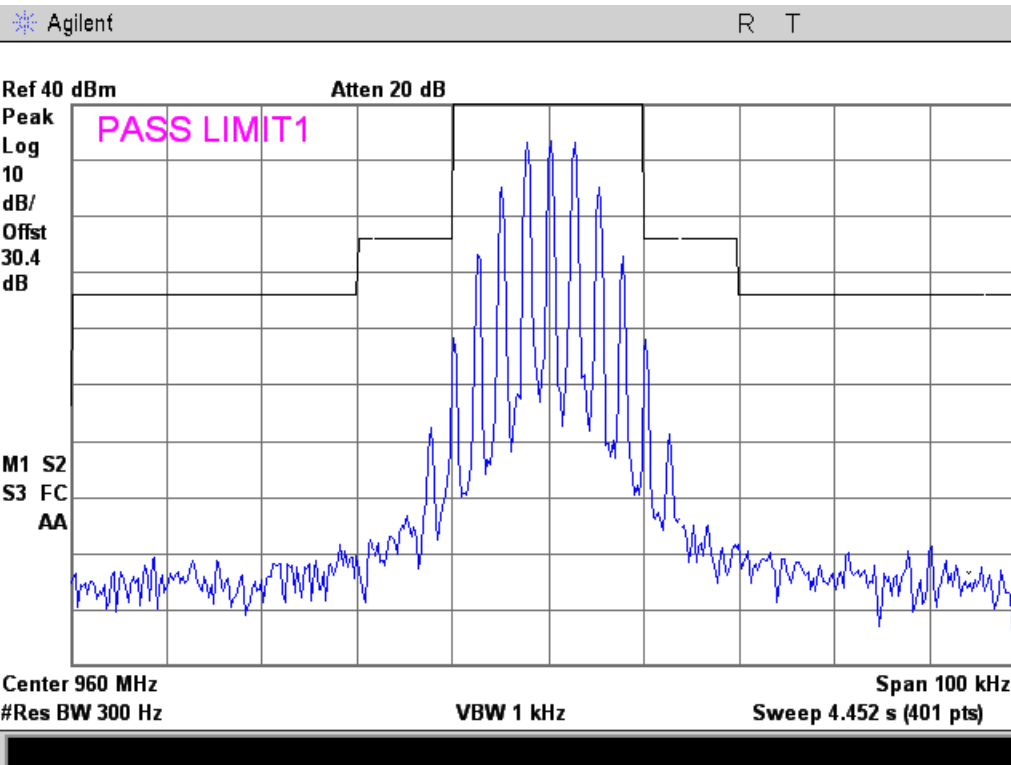



MTM 138.05 MHz Reference

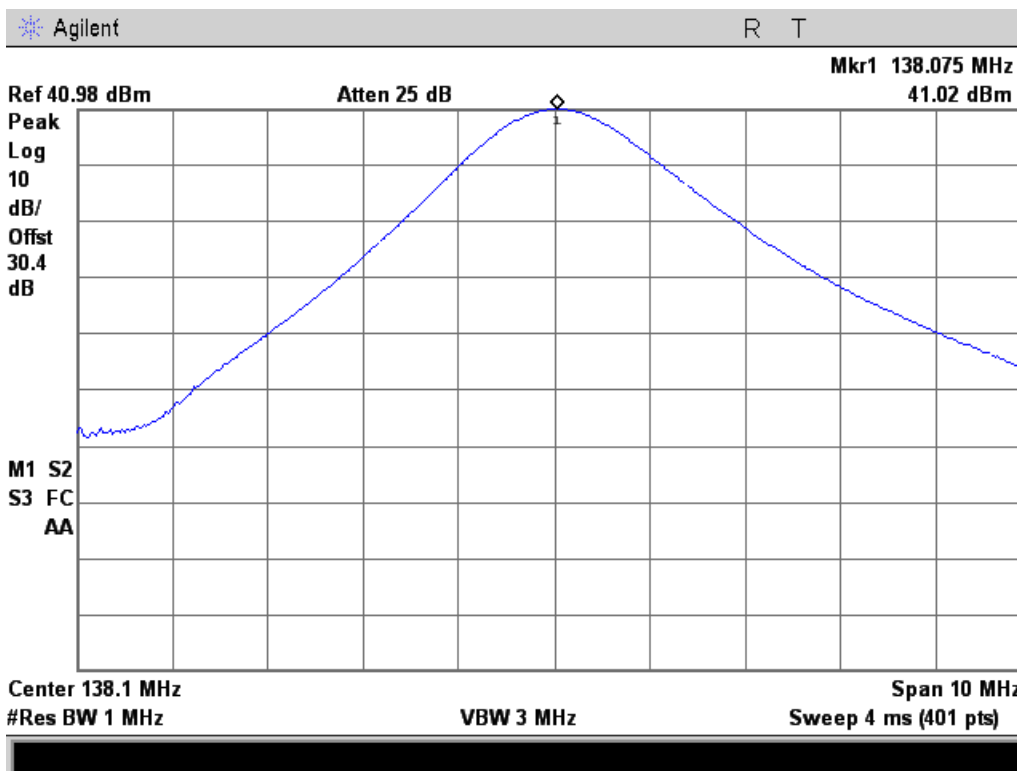

8K10F1D

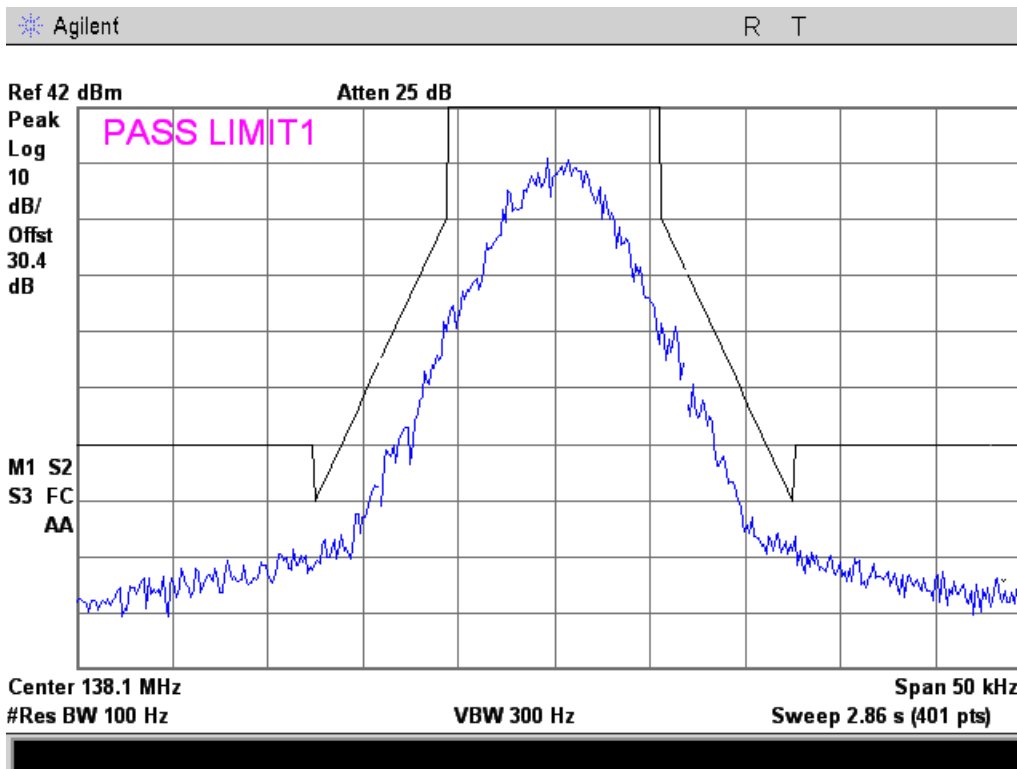



11K0F3E

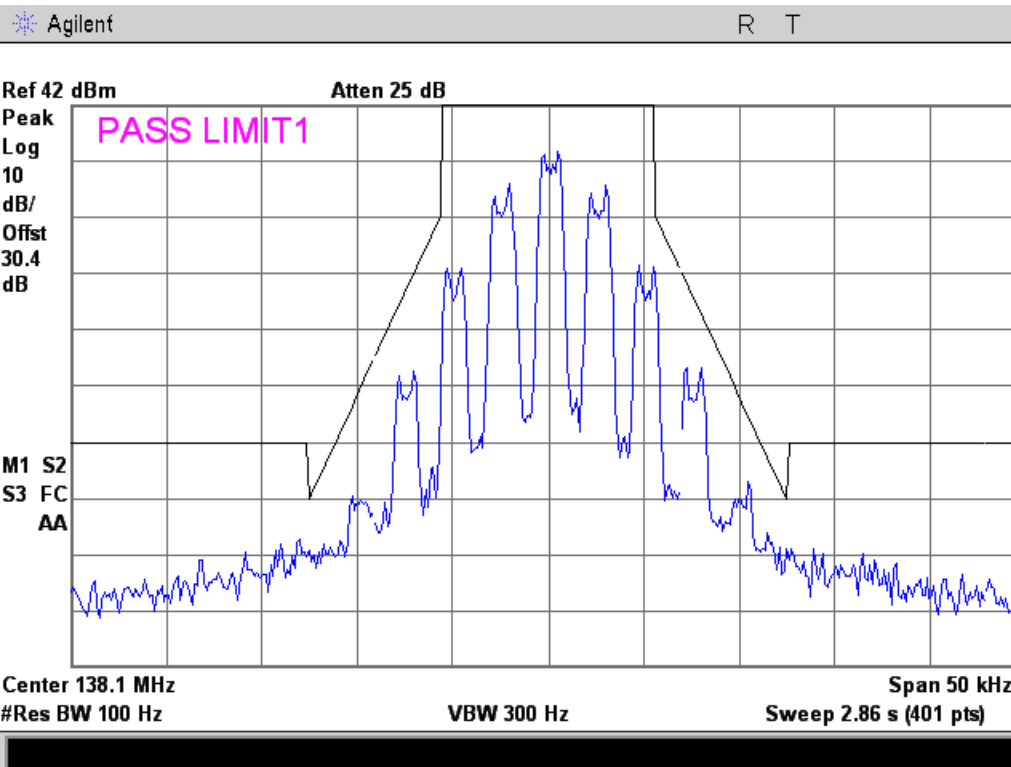

16K0F3E

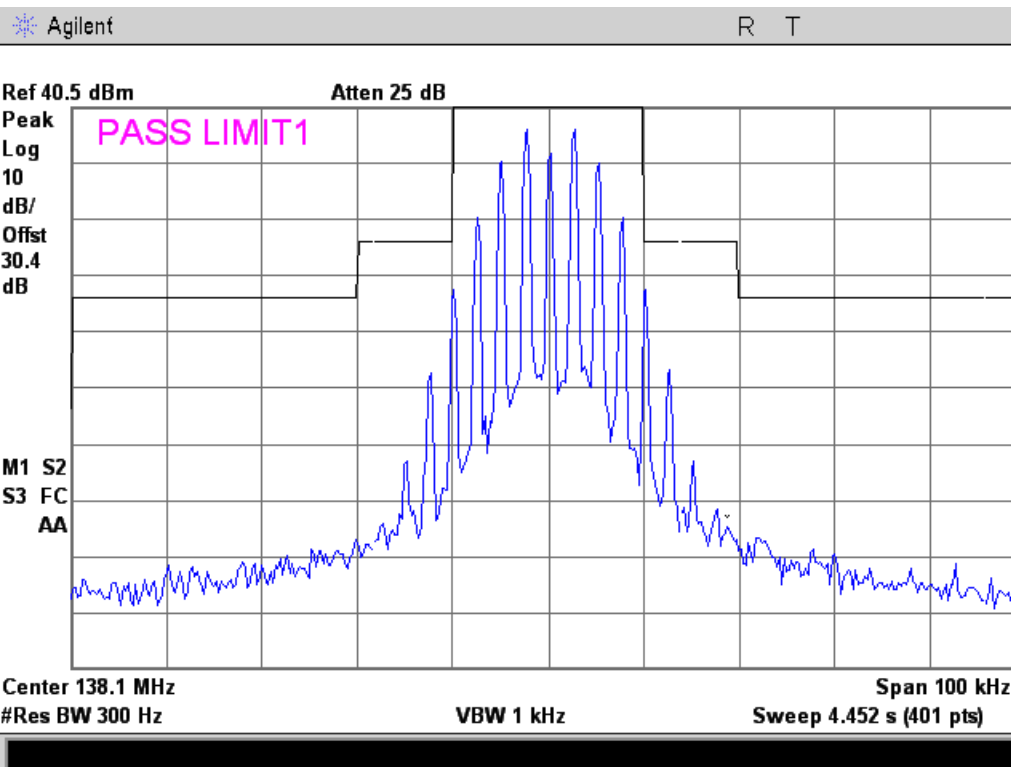



MTM 150.05 MHz Reference

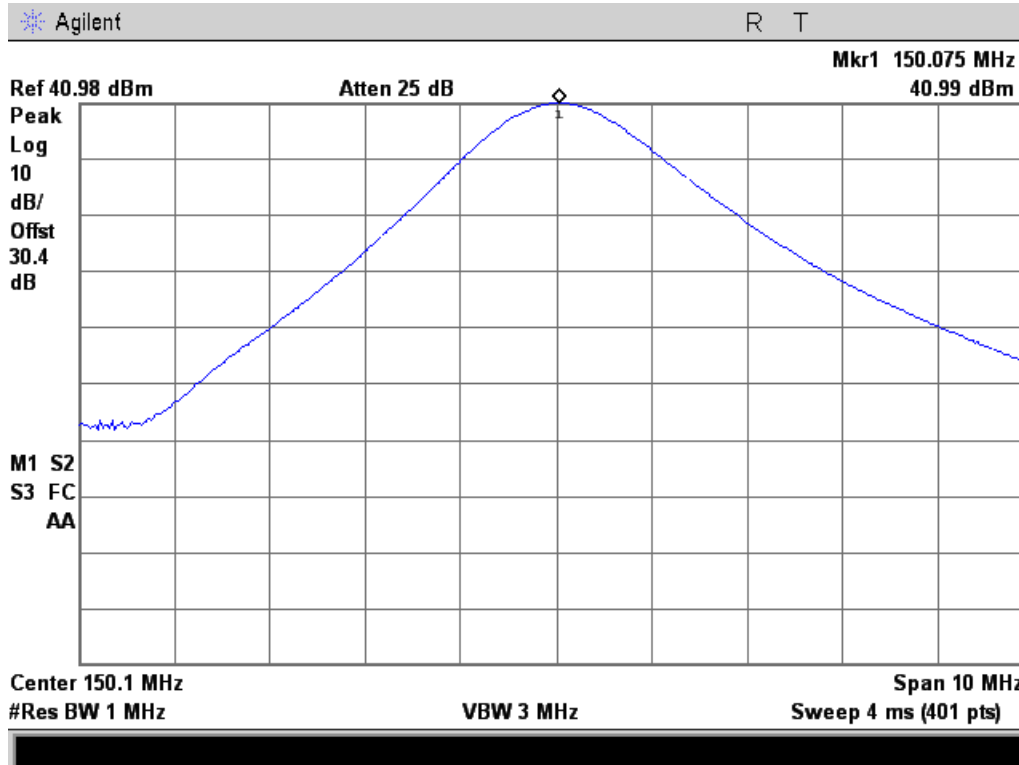

8K10F1D

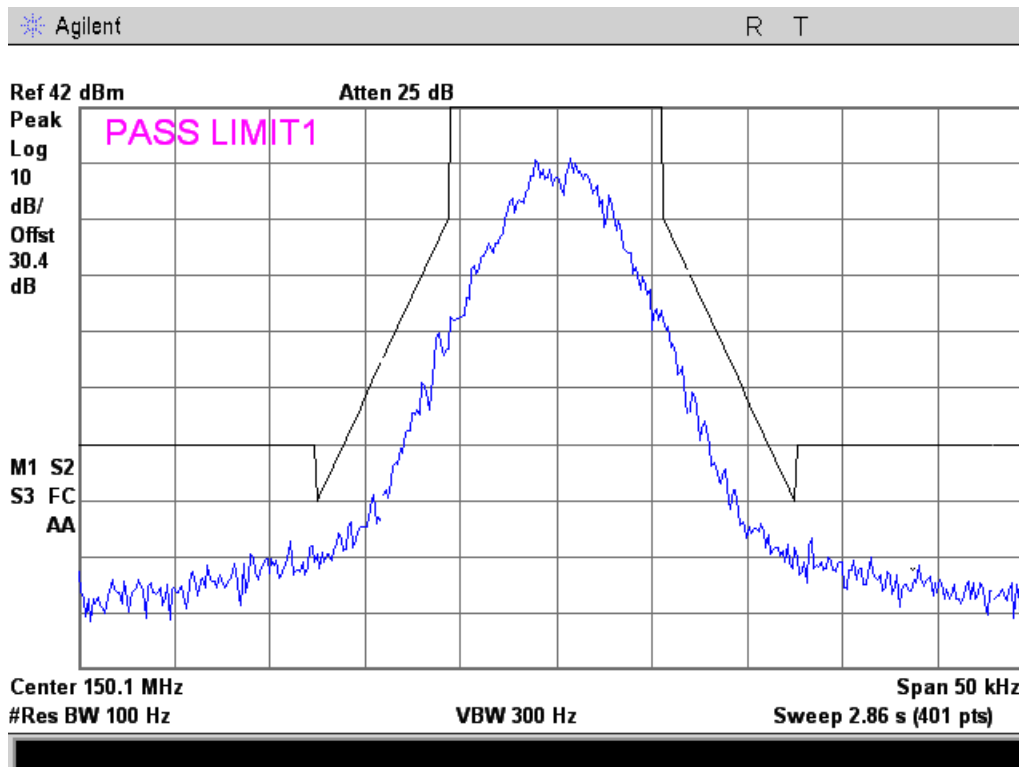



11K0F3E

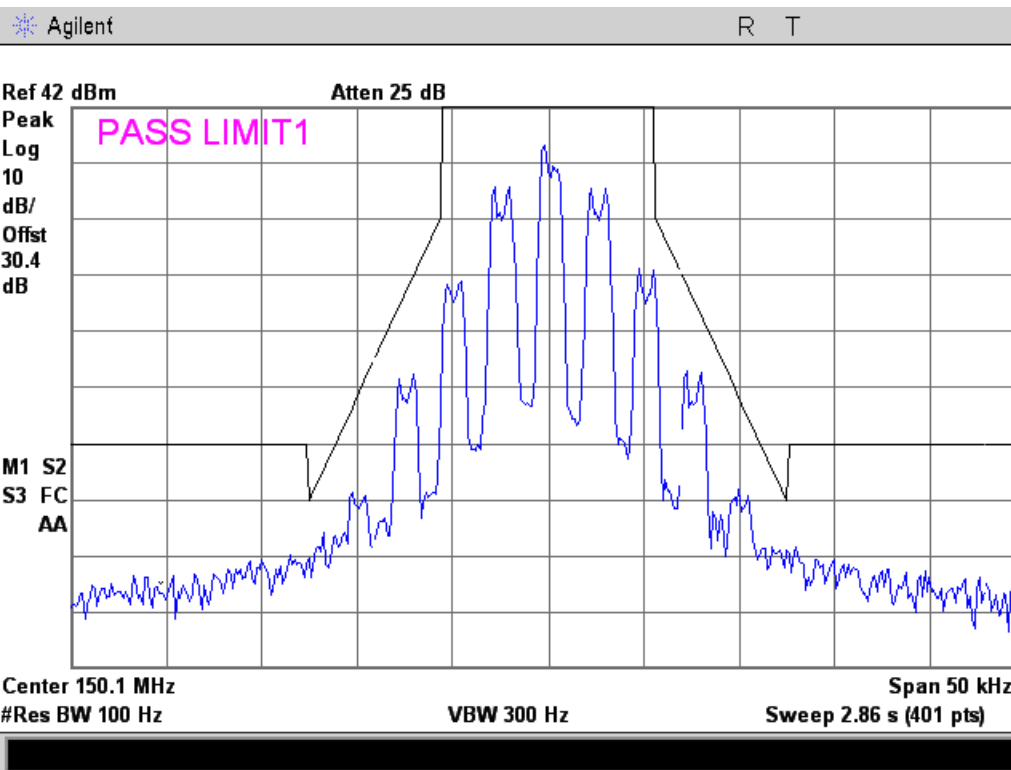

16K0F3E (RSS-119 Only)

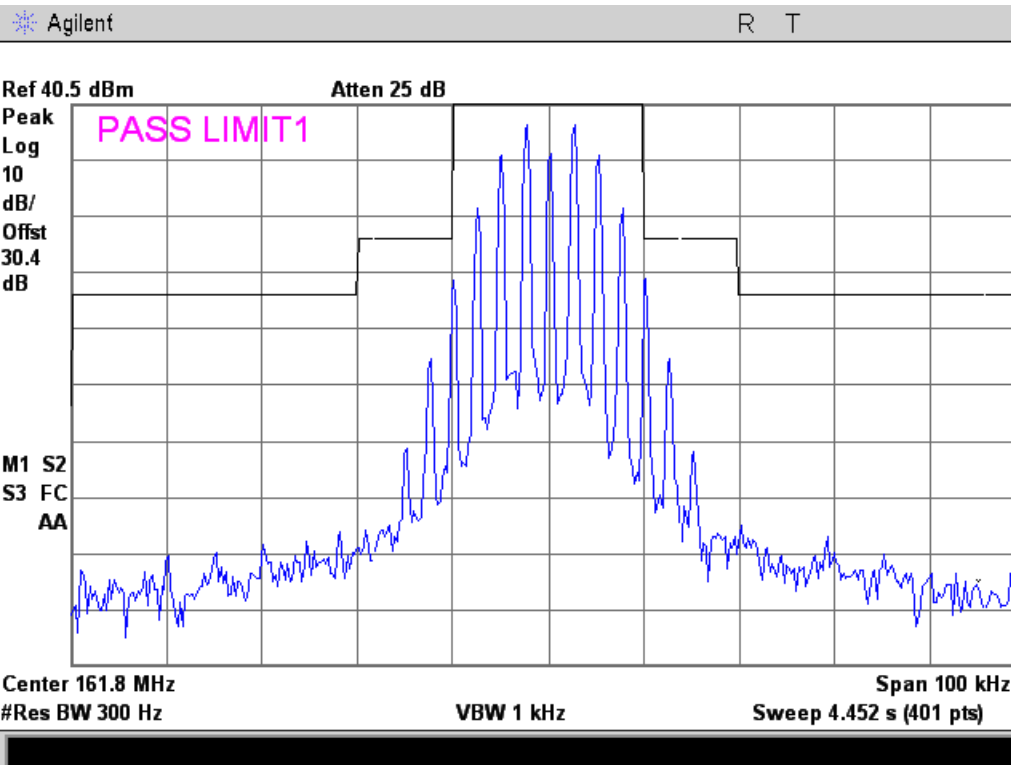



MTM 161.775 MHz Reference

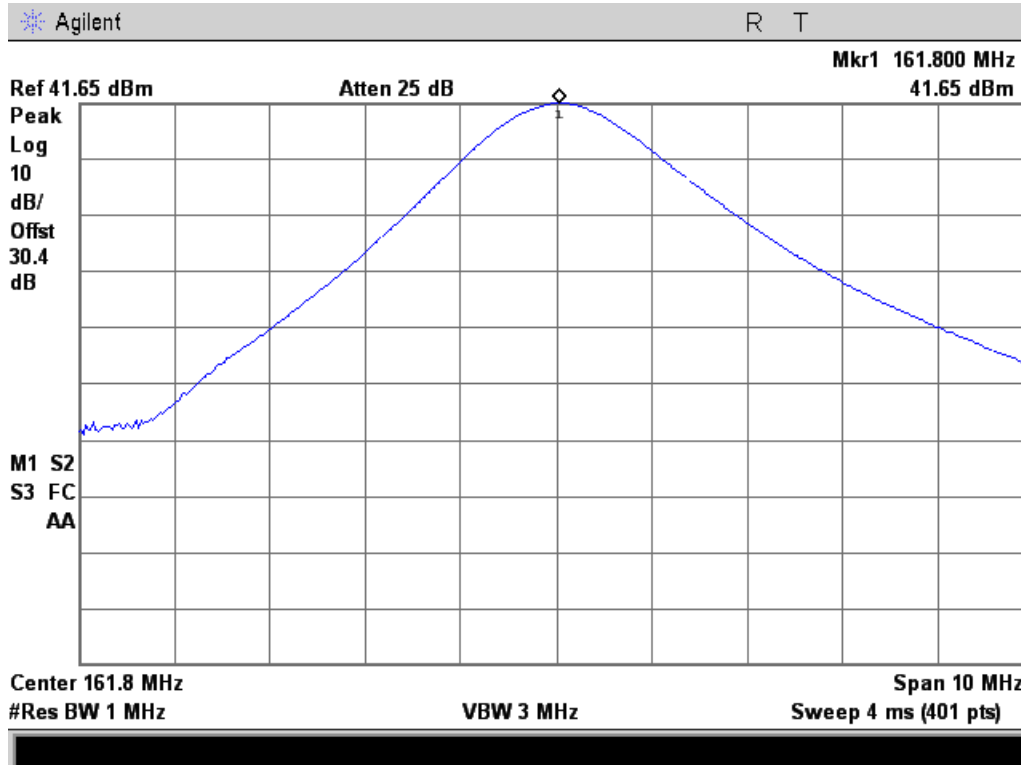

8K10F1D

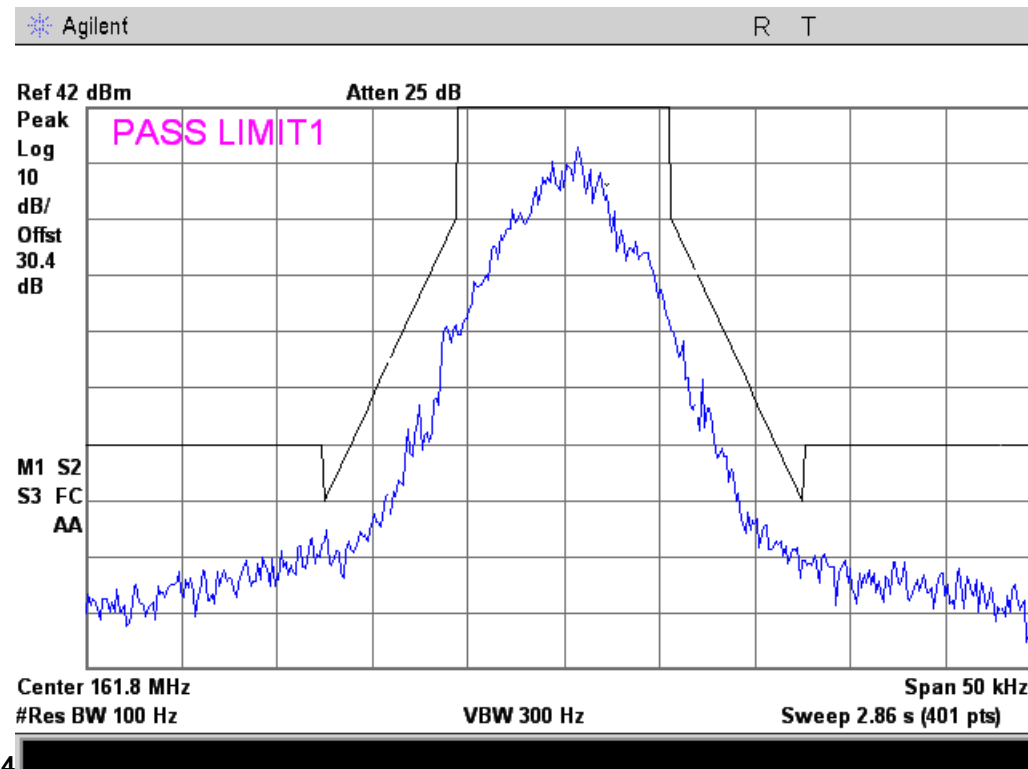

4



11K0F3E

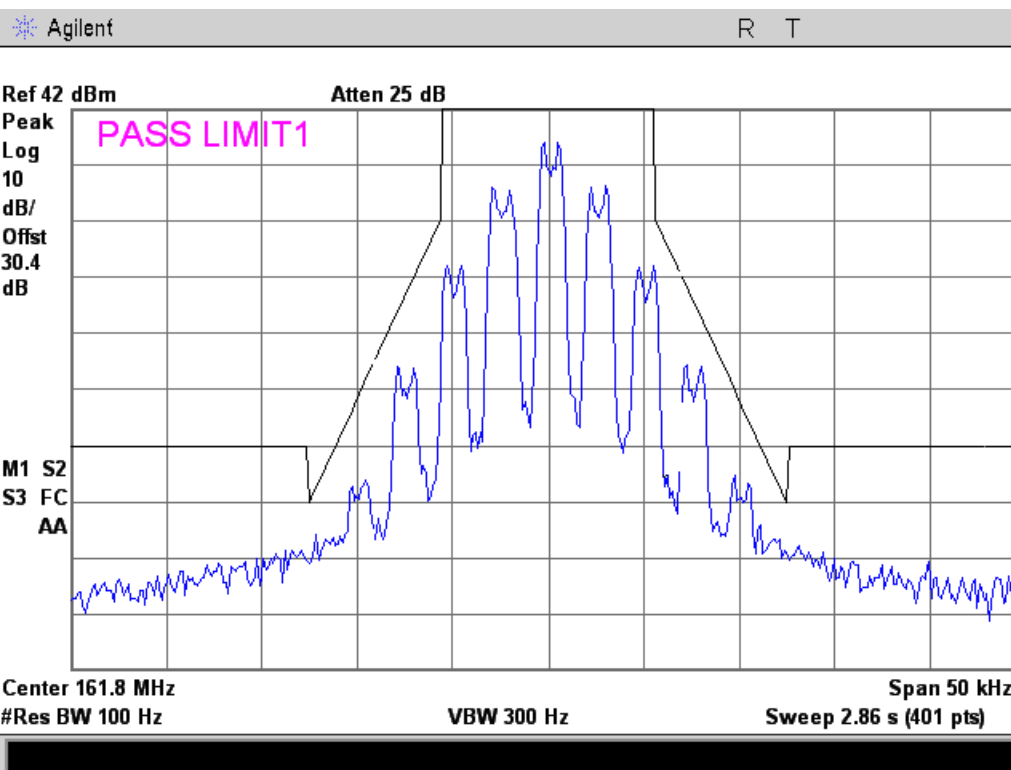

16K0F3E (RSS-119 Only)

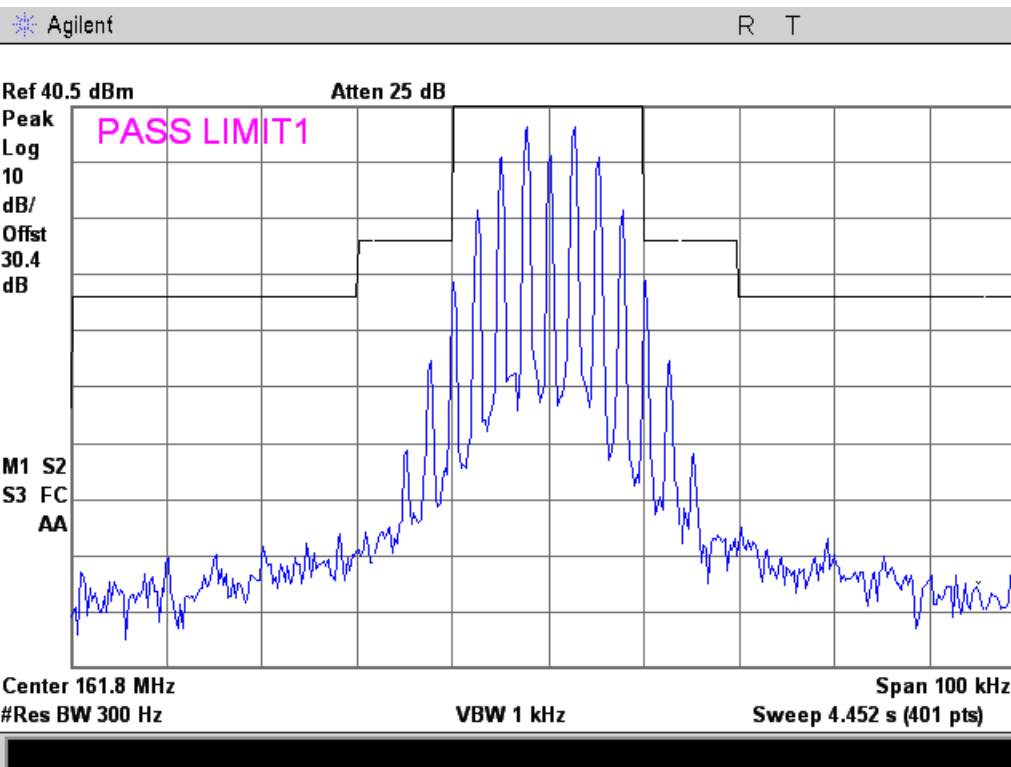



MTM 173.95 MHz Reference

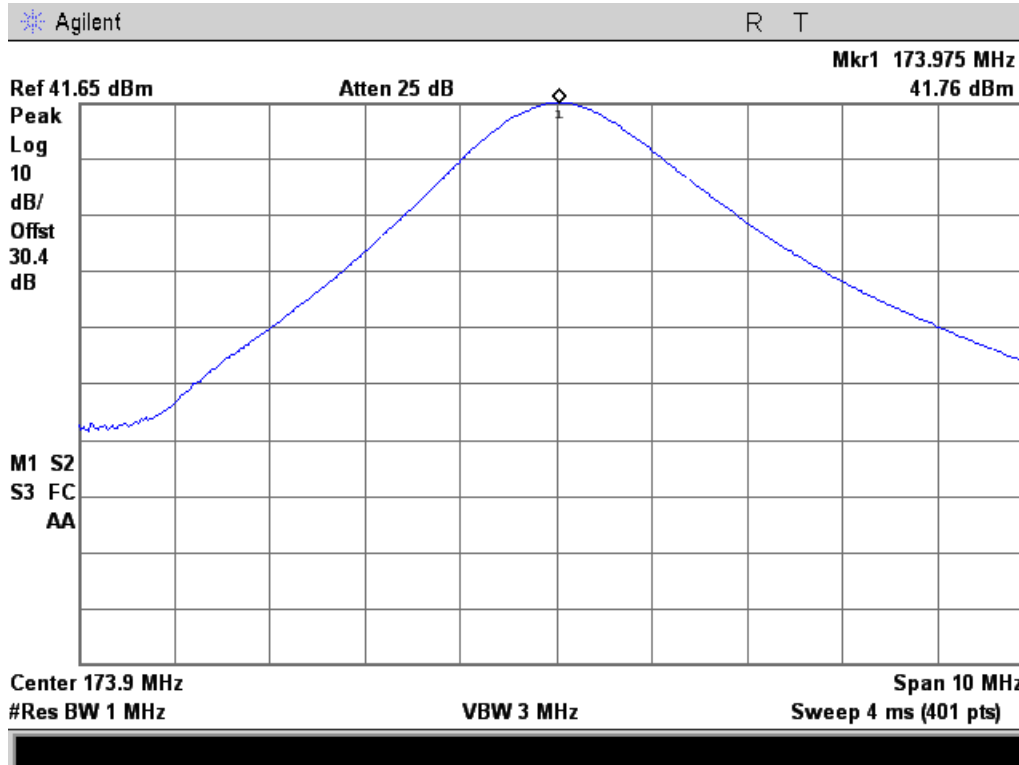

8K10F1D

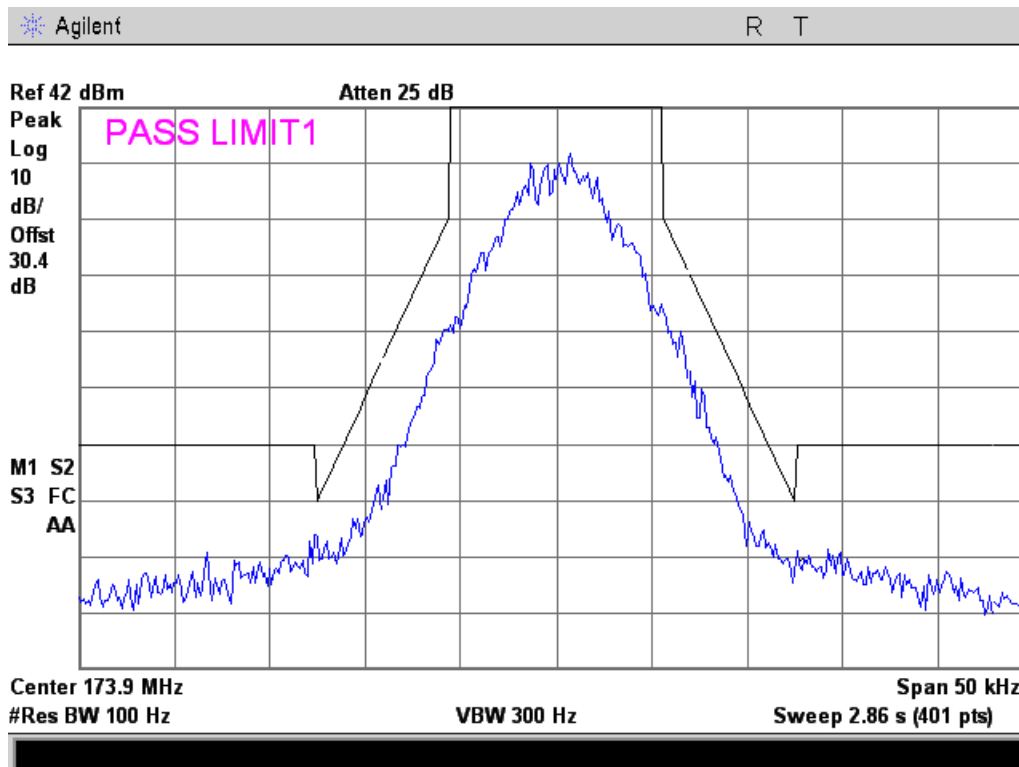



11K0F3E

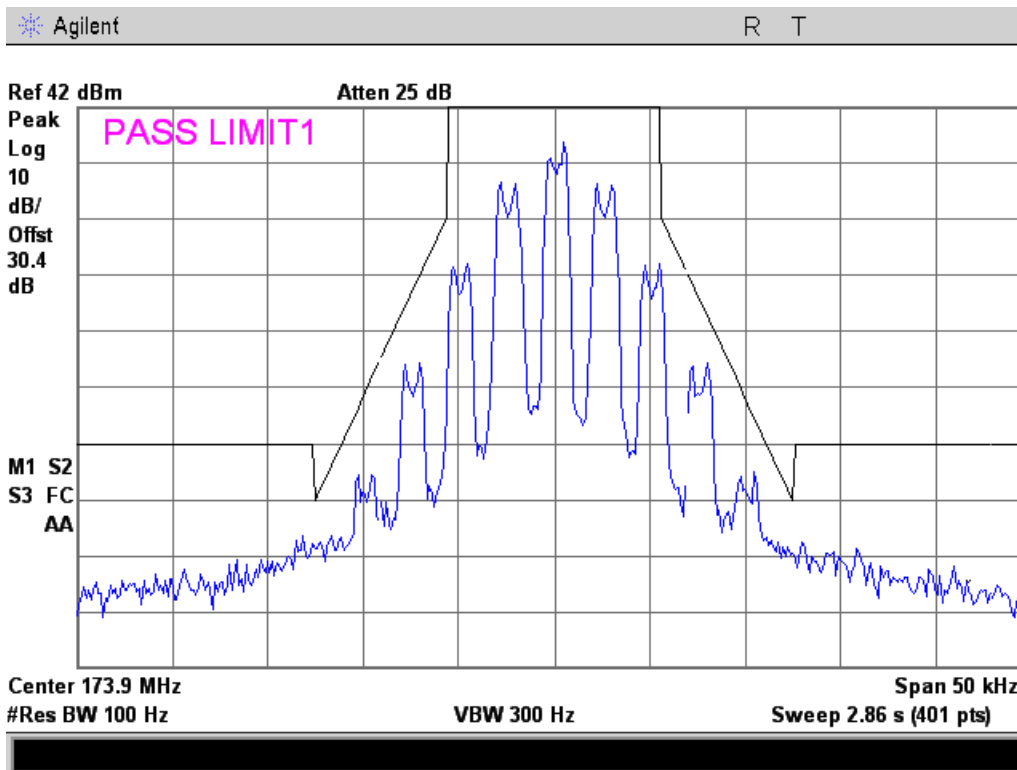

16K0F3E (RSS-119 Only)

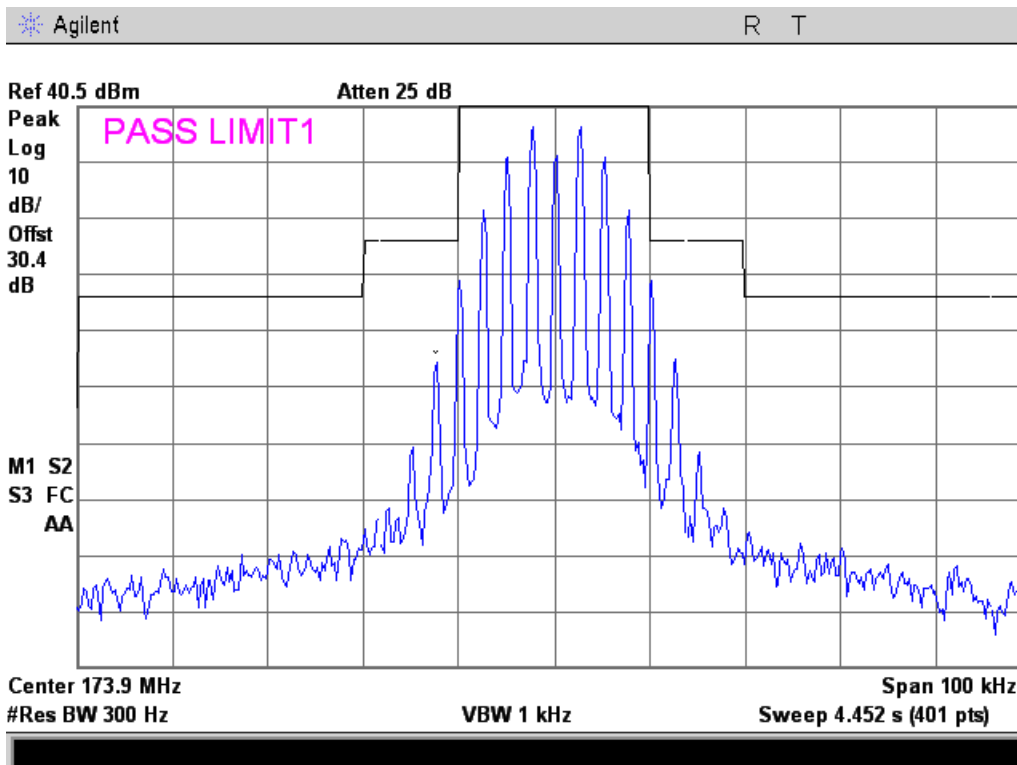



MTM 380.00 MHz Reference

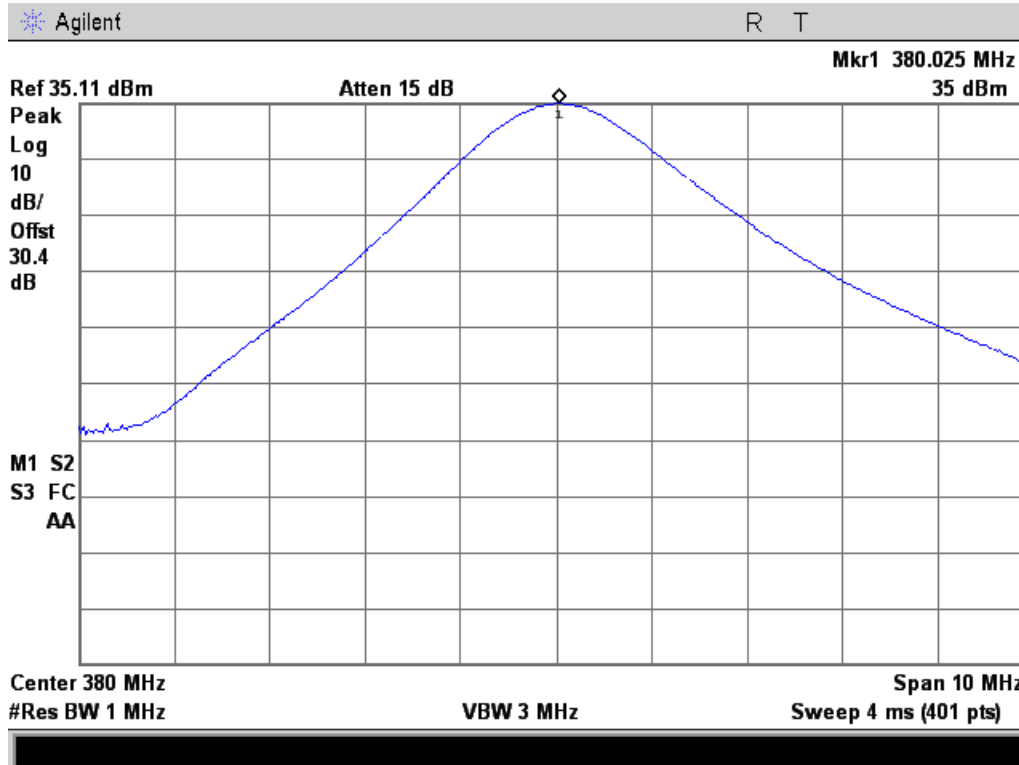

8K10F1D

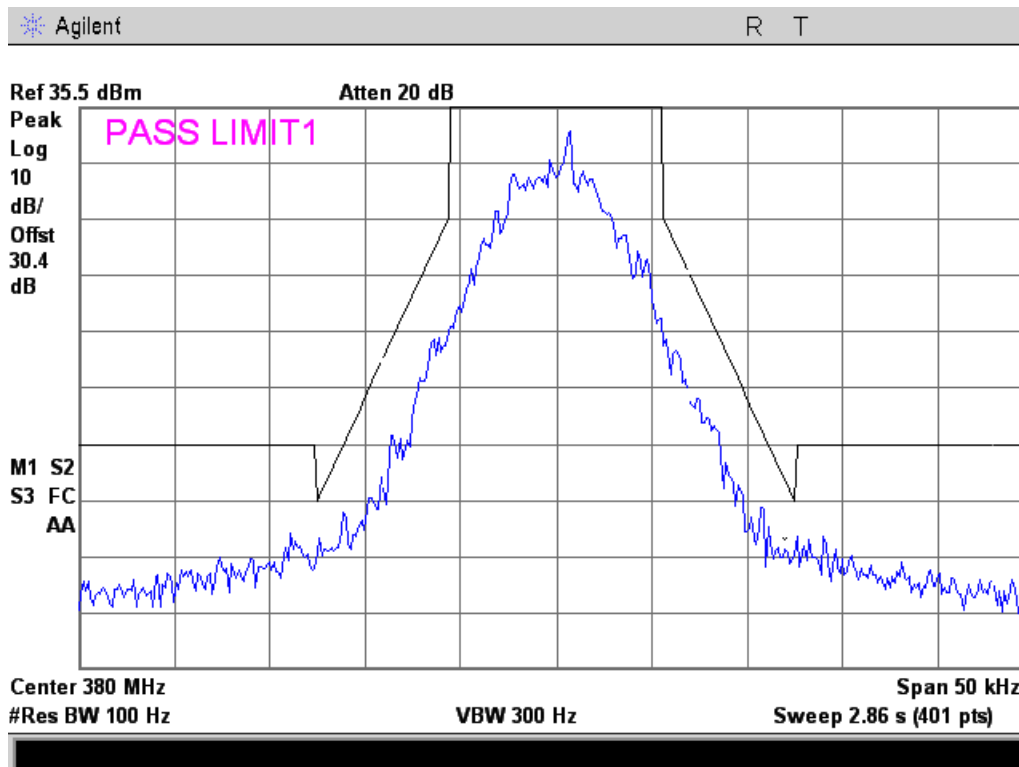



11K0F3E

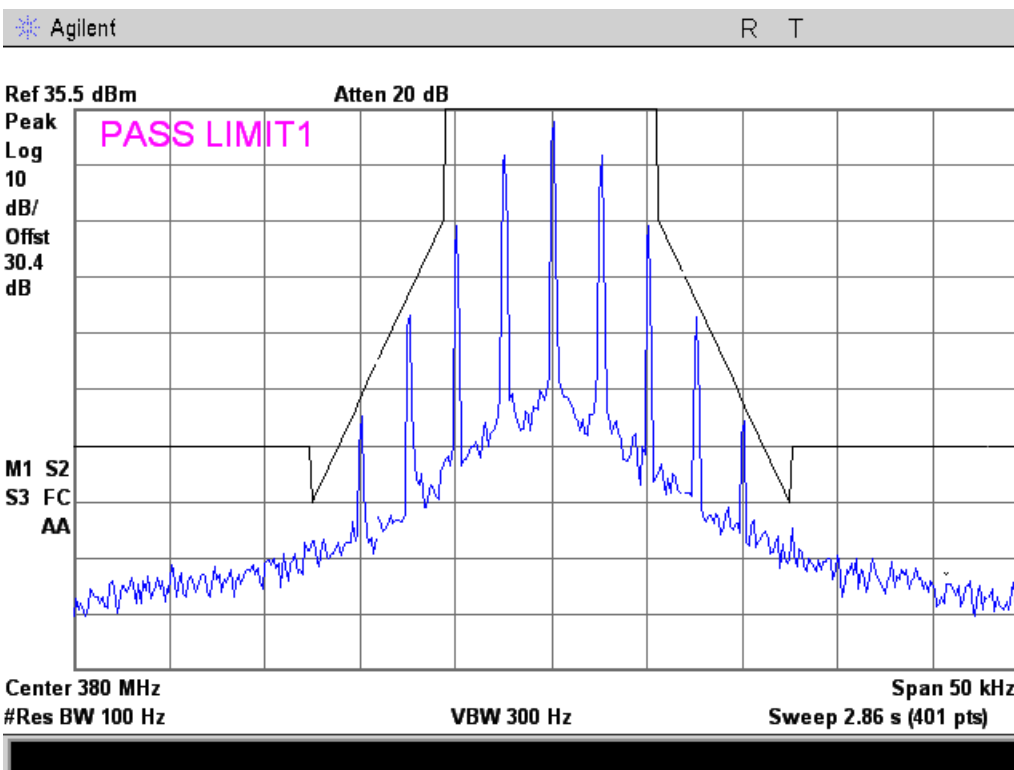

16K0F3E (RSS-119 Only)

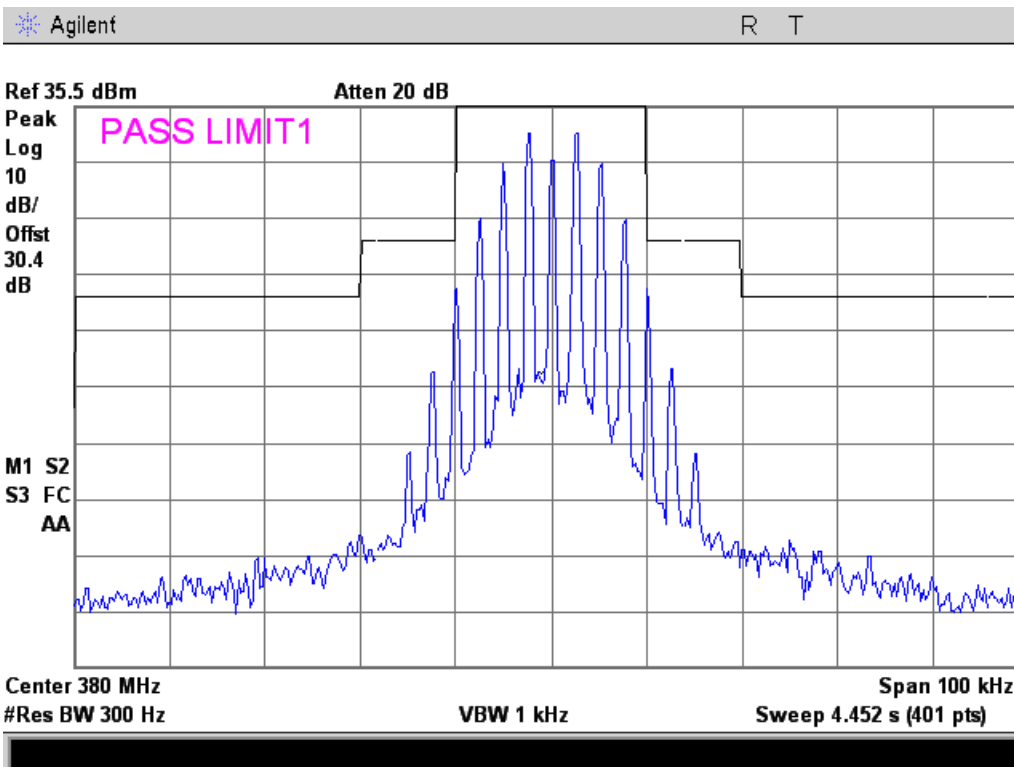



MTM 406.15 MHz Reference

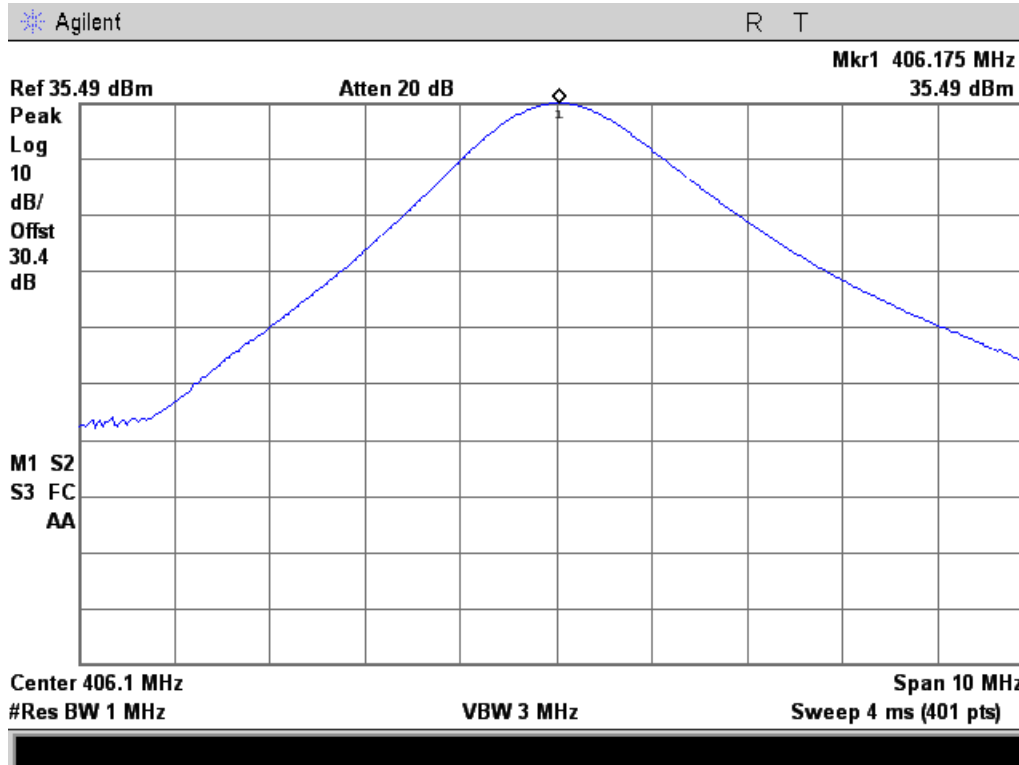

8K10F1D

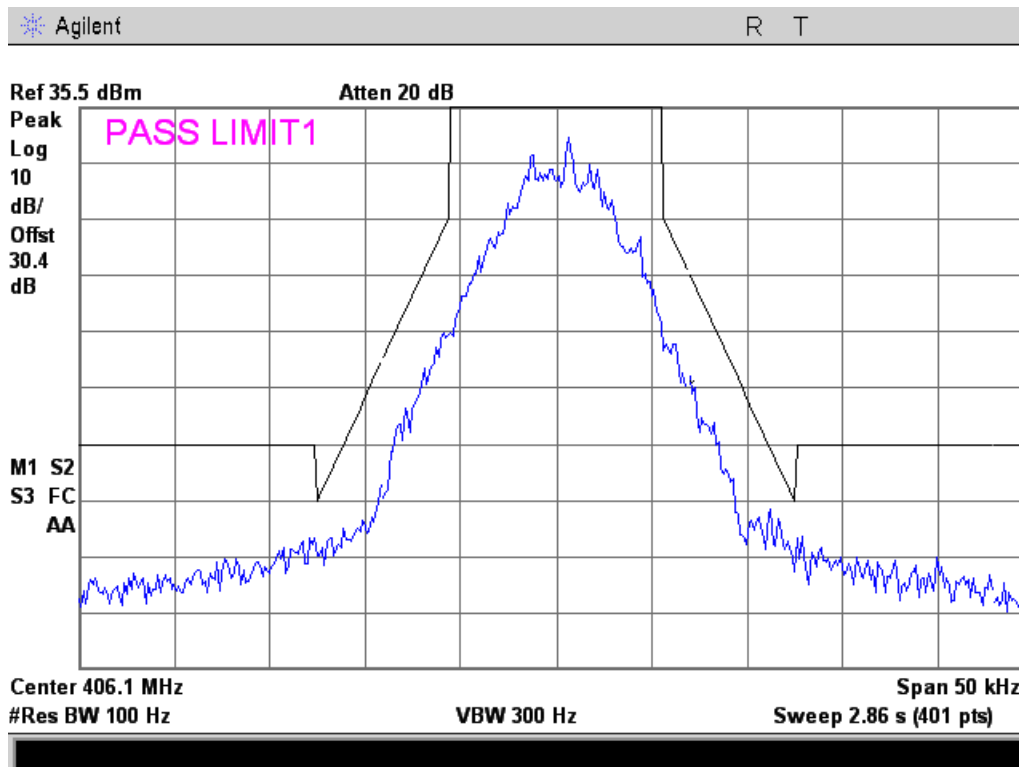



11K0F3E

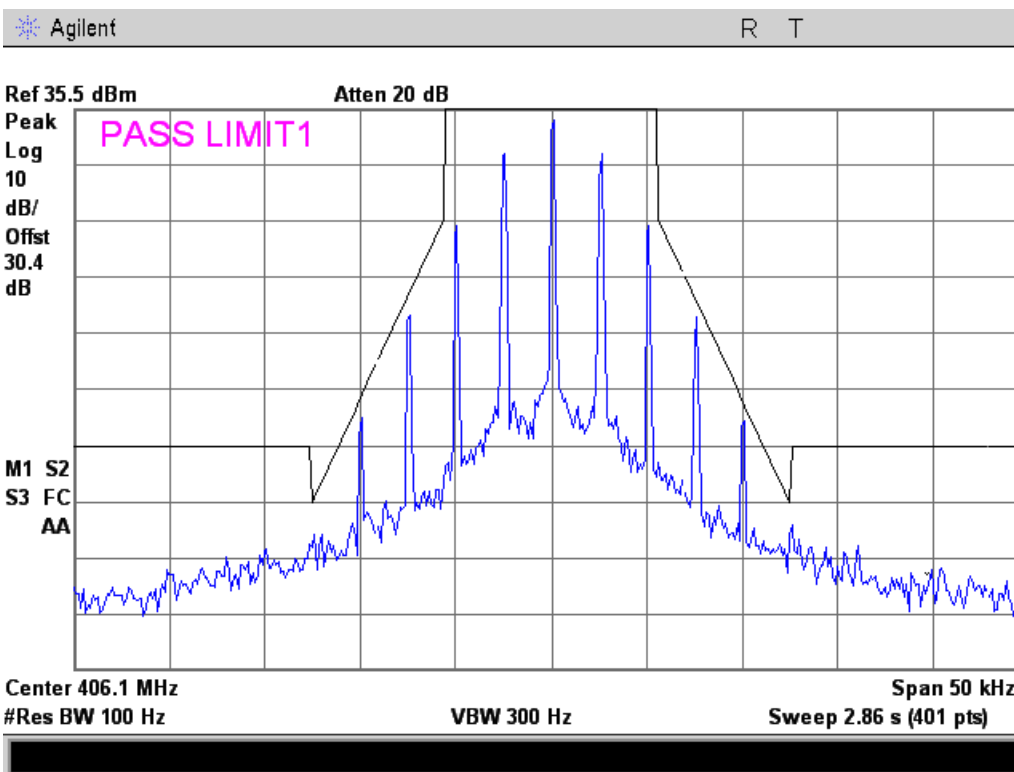

16K0F3E (RSS-119 Only)

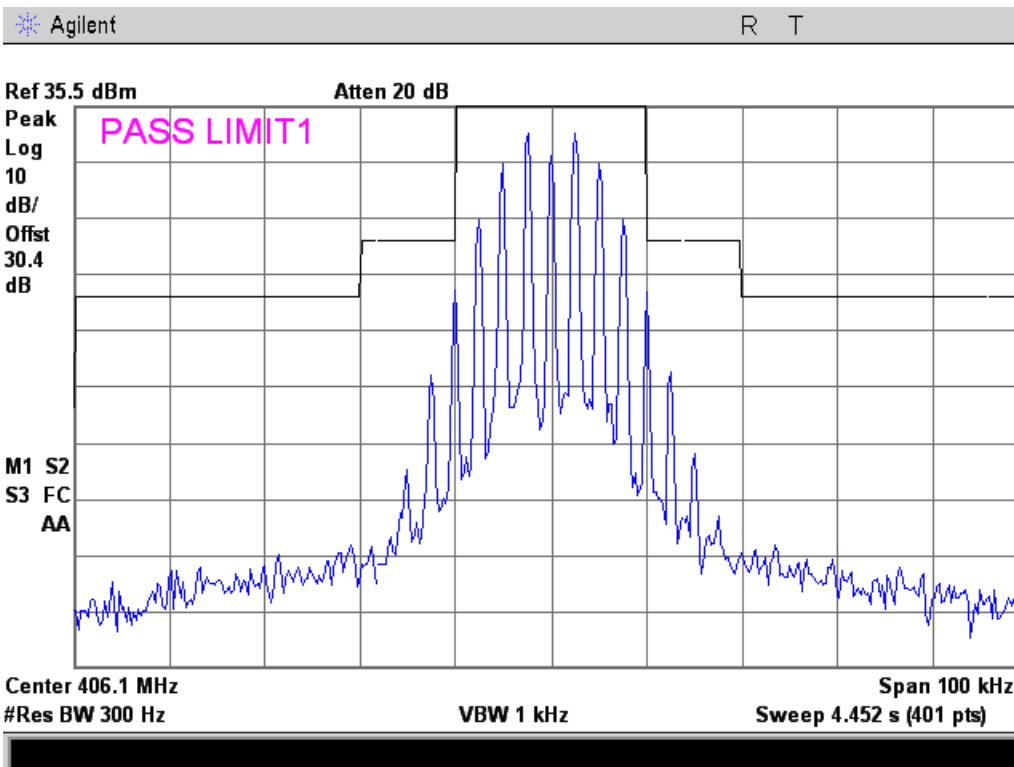



MTM 438.05 MHz Reference

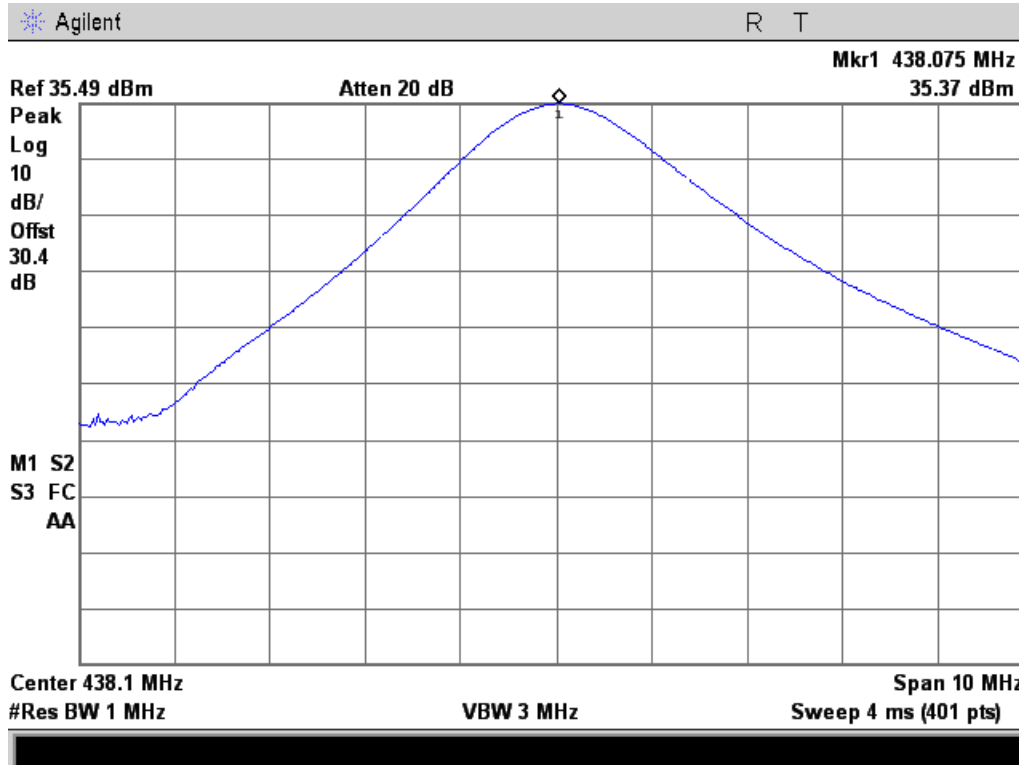

8K10F1D

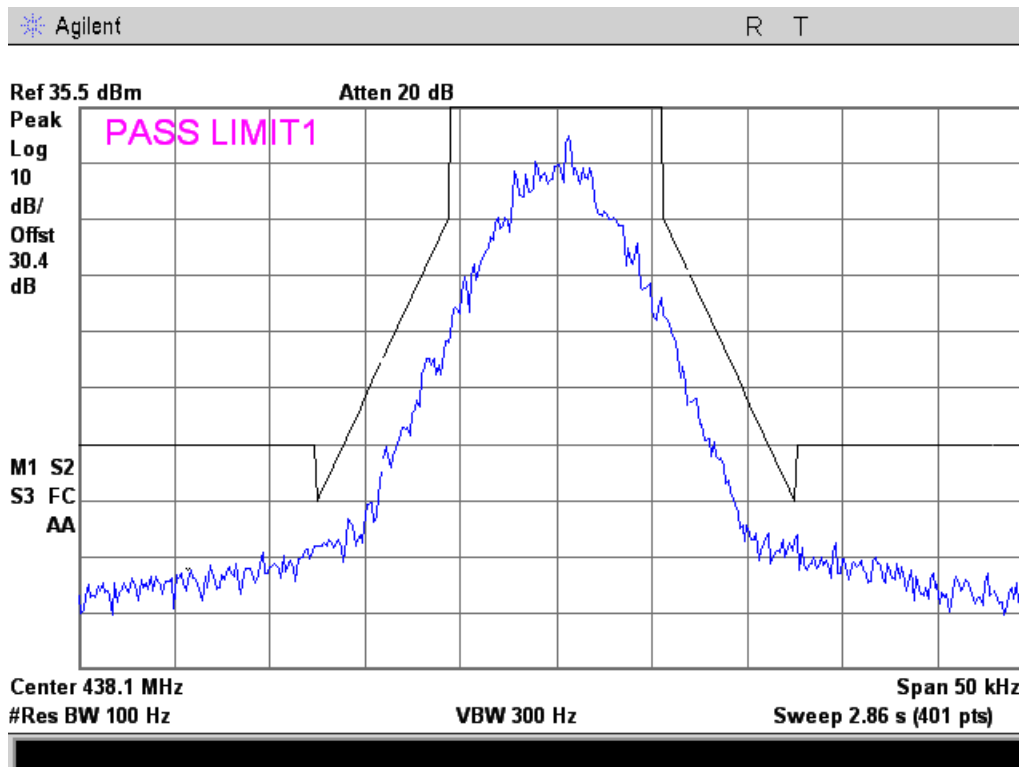



11K0F3E

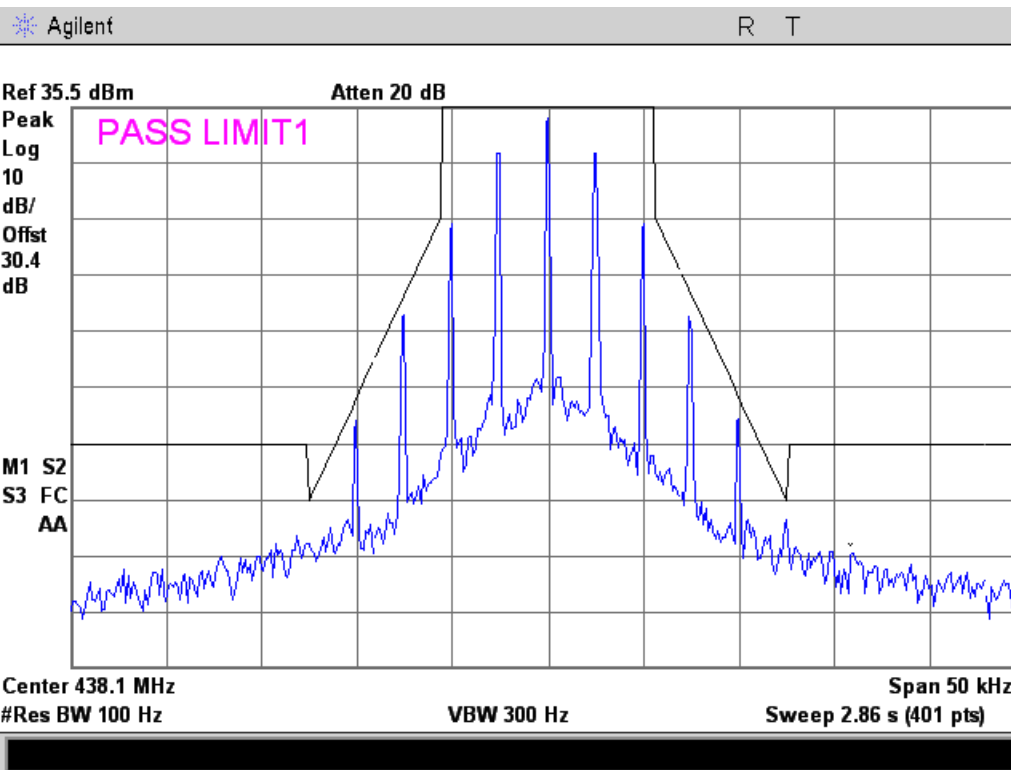

16K0F3E (RSS-119 Only)

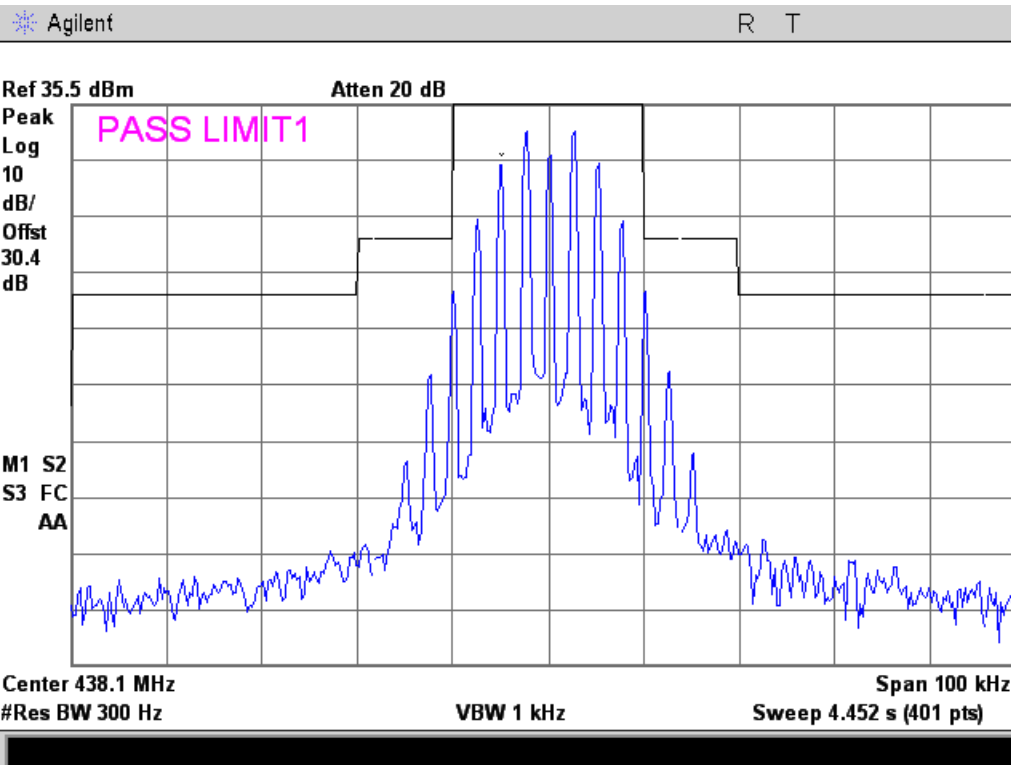



MTM 469.95 MHz Reference

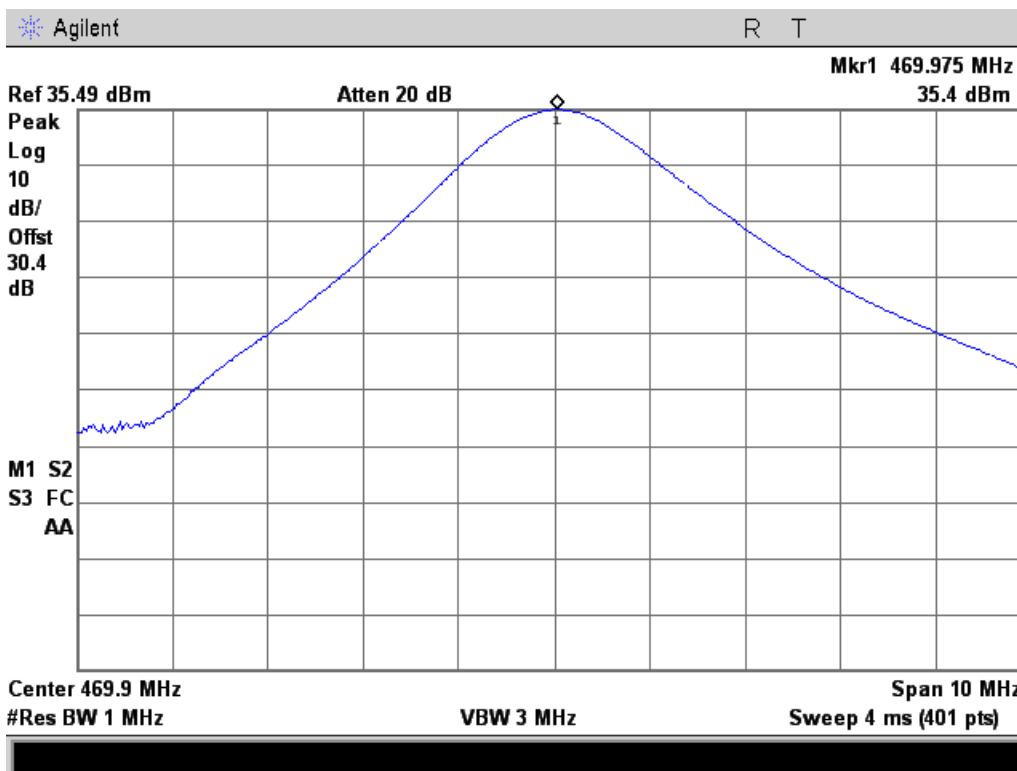

8K10F1D

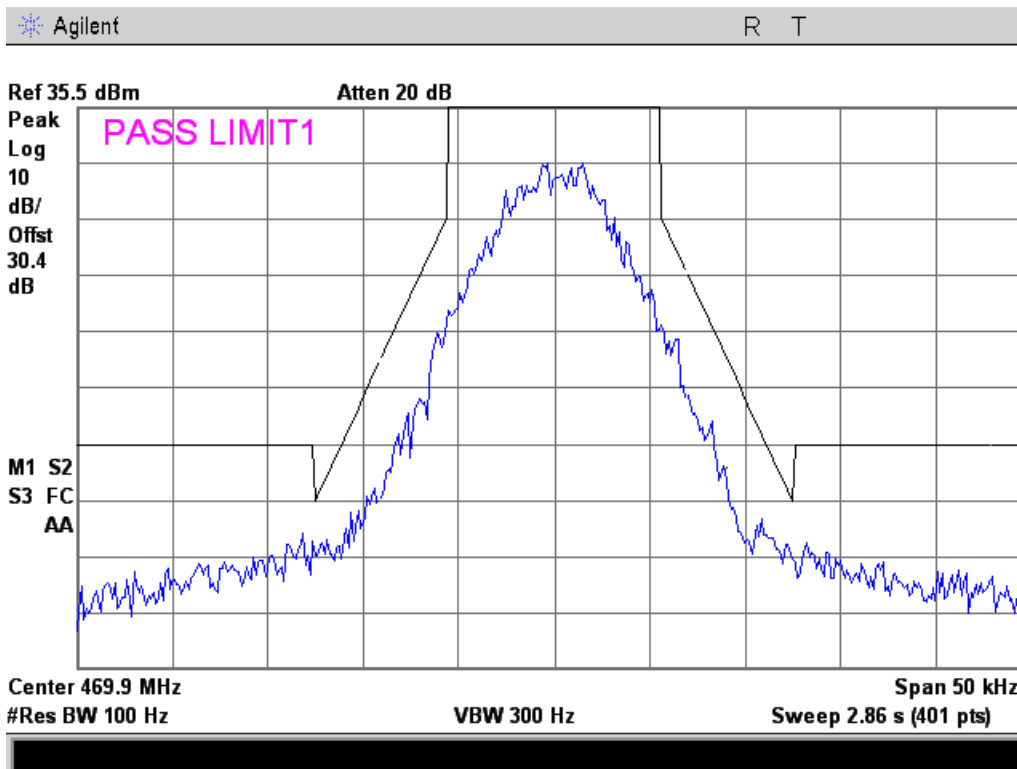



11K0F3E

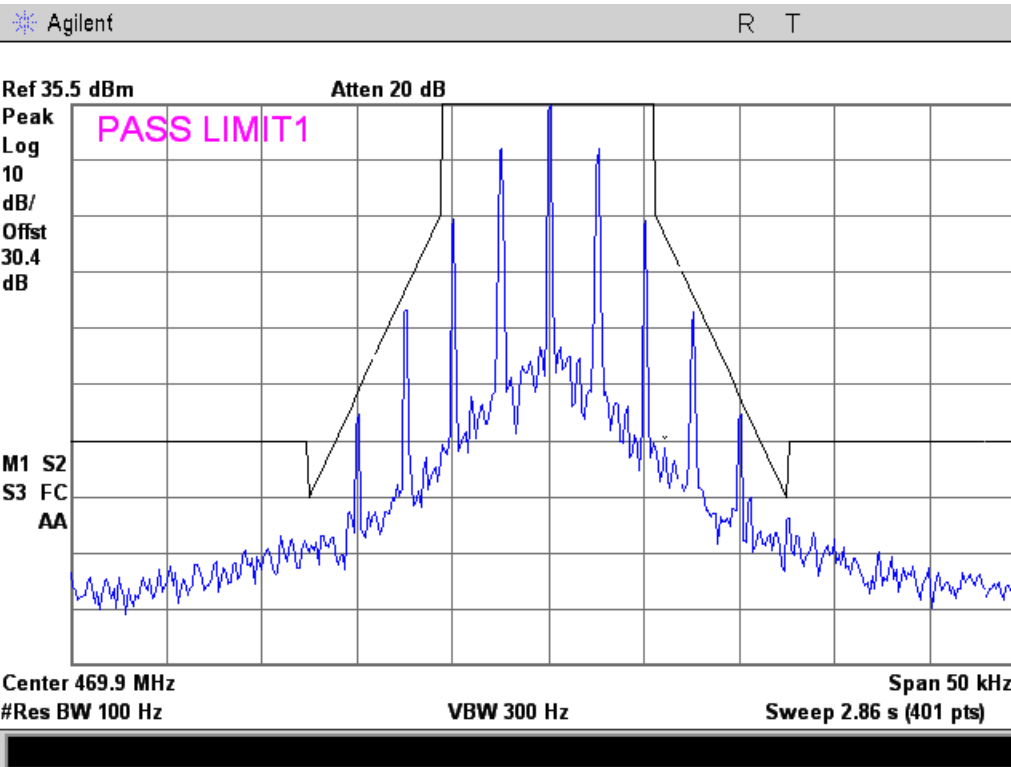

16K0F3E (RSS-119 Only)

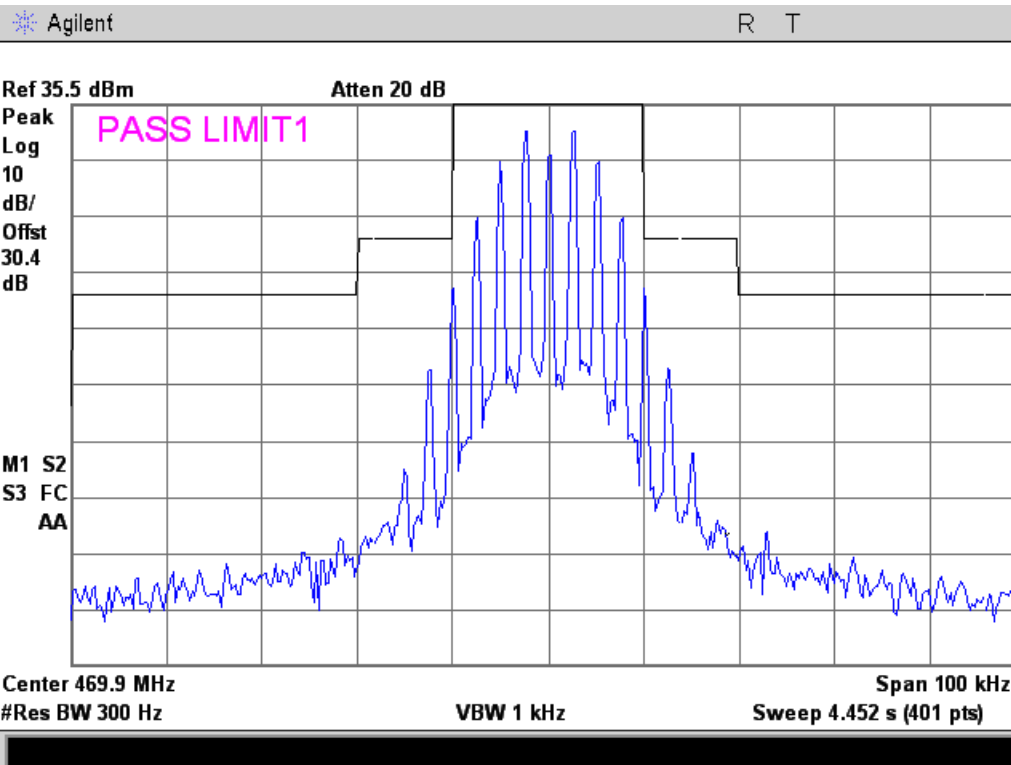



MTM 450.05 MHz Reference

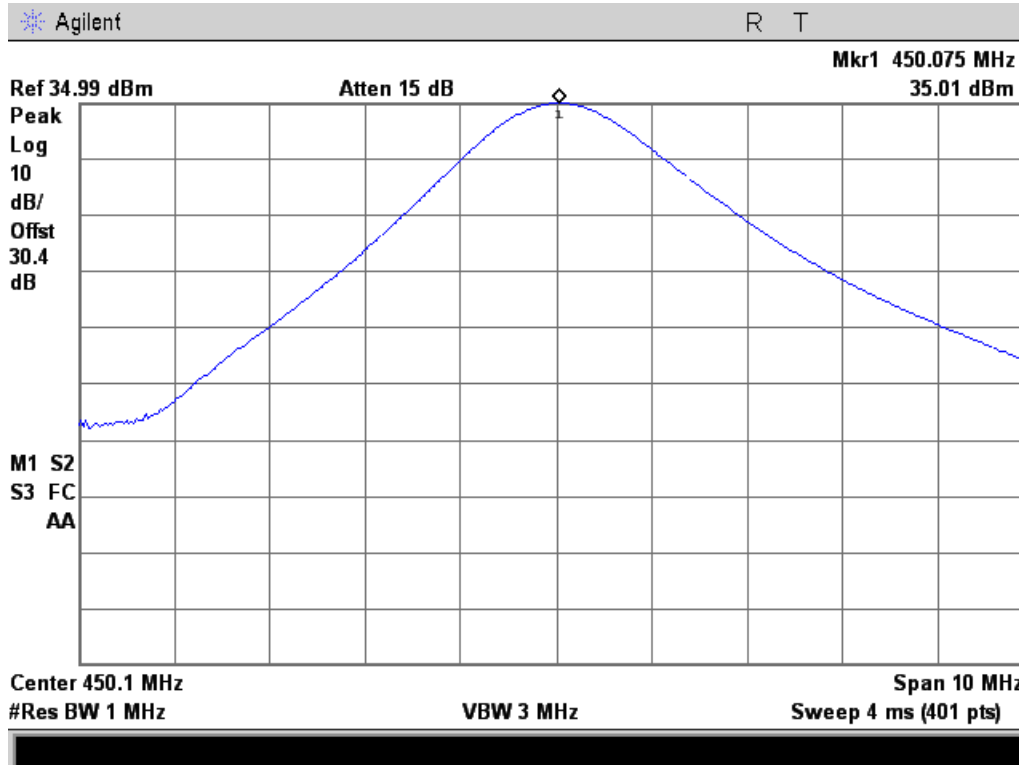

8K10F1D

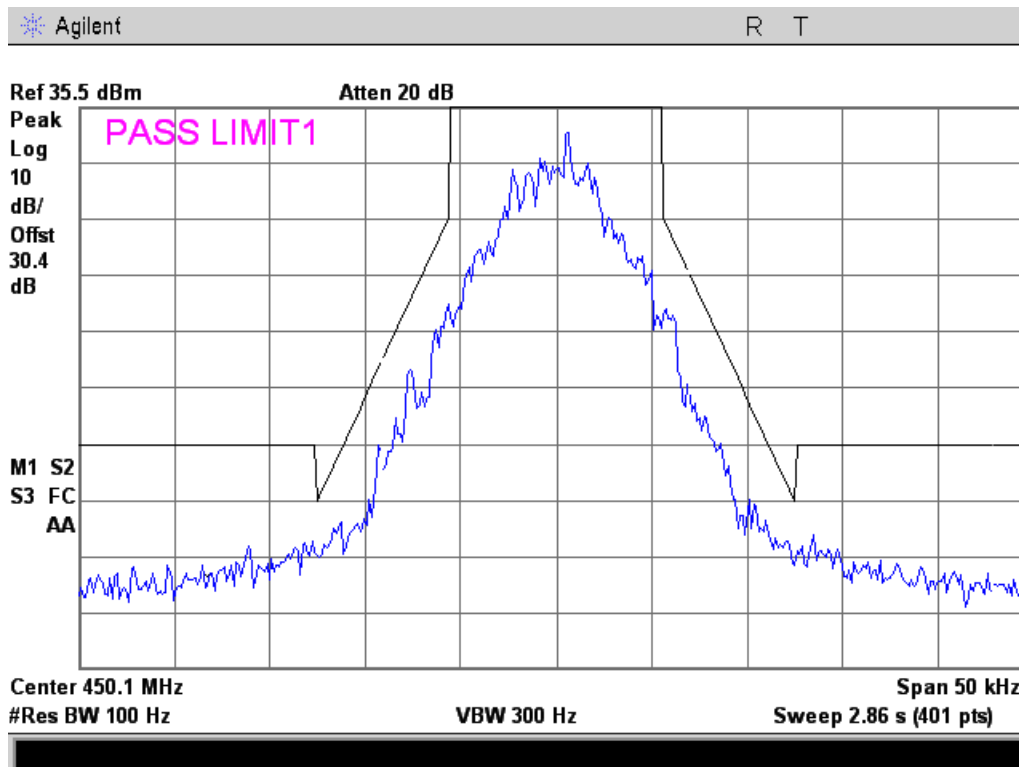



11K0F3E

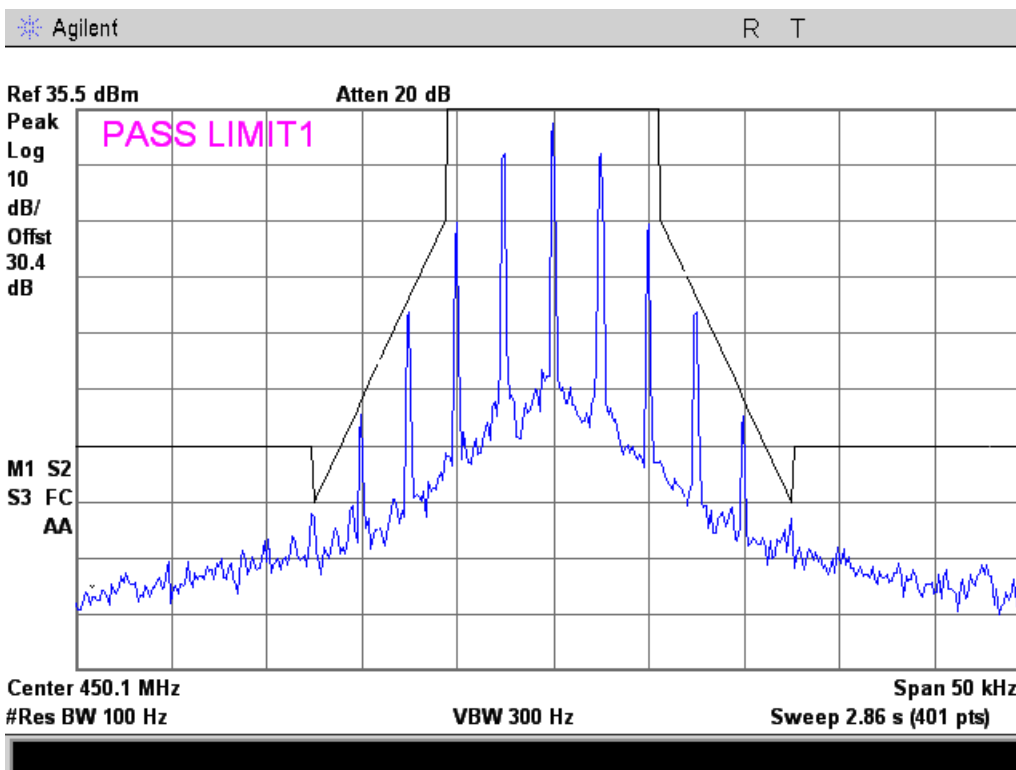

16K0F3E (RSS-119 Only)

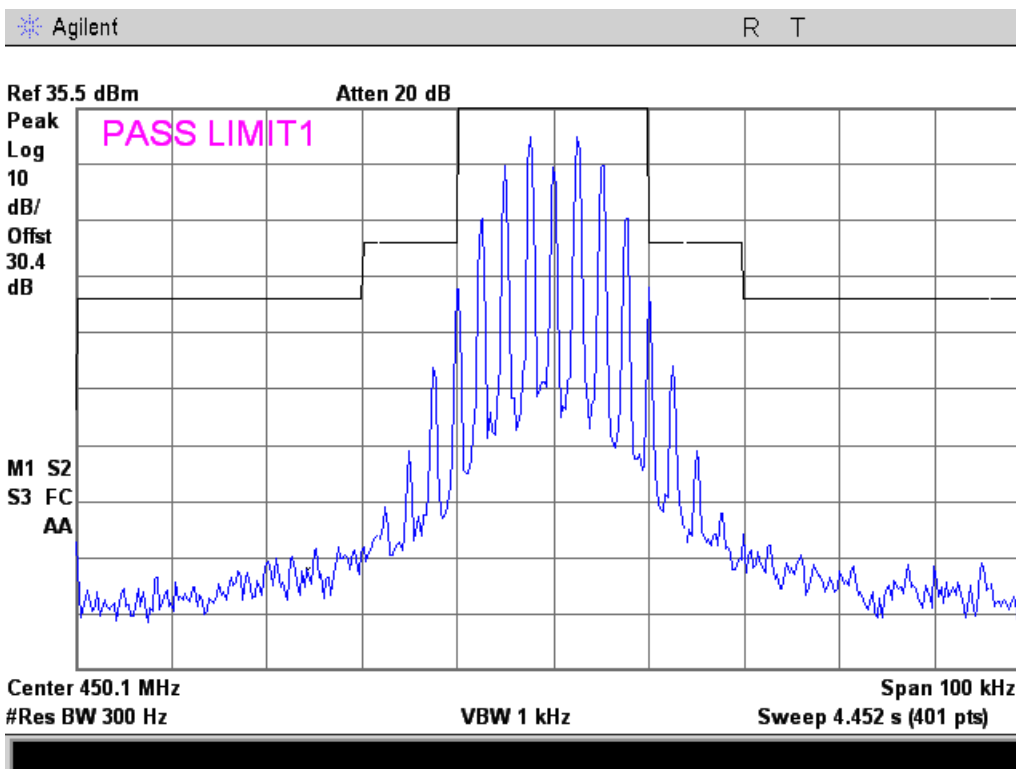



MTM 460.05 MHz Reference

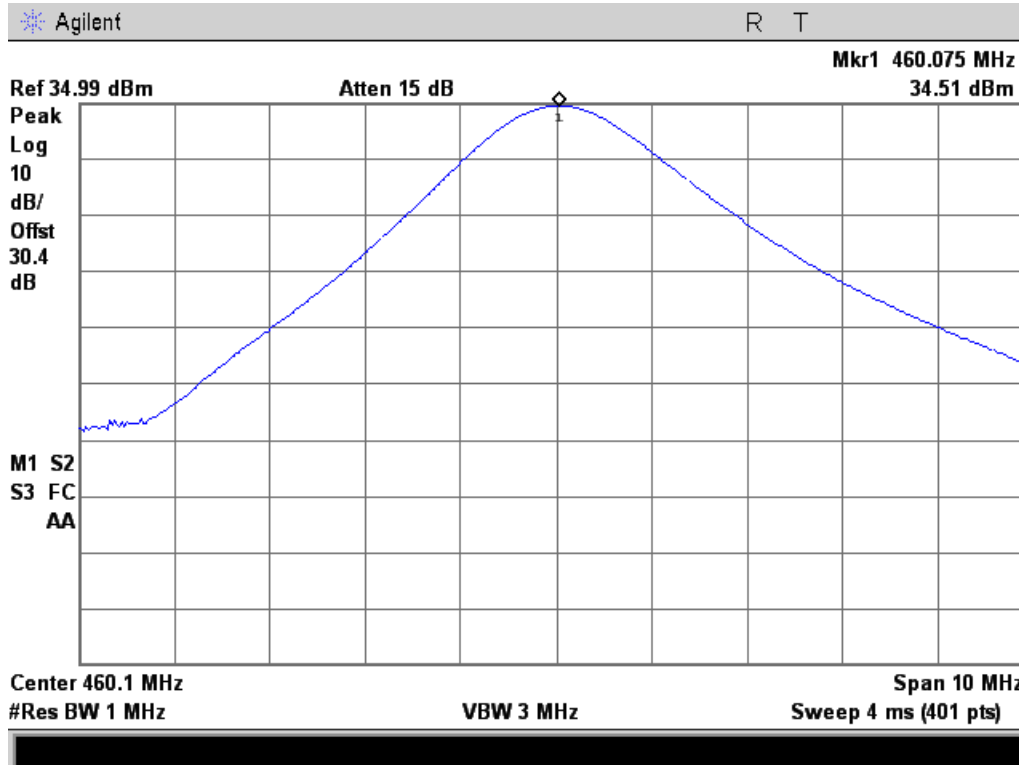

8K10F1D

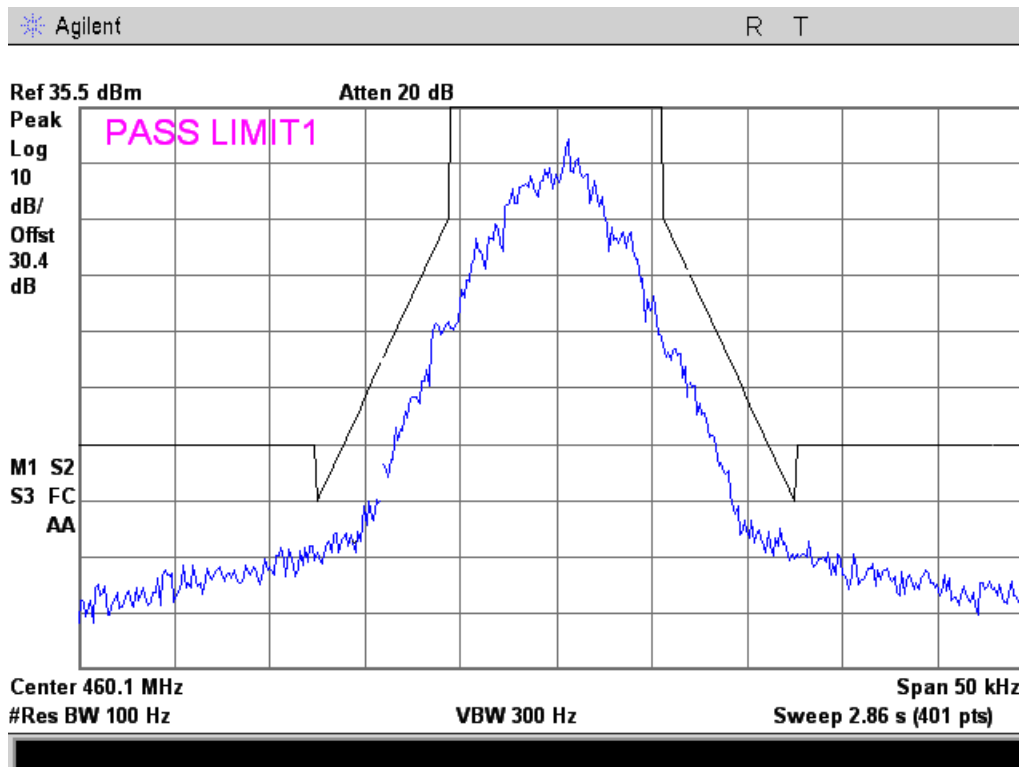



11K0F3E

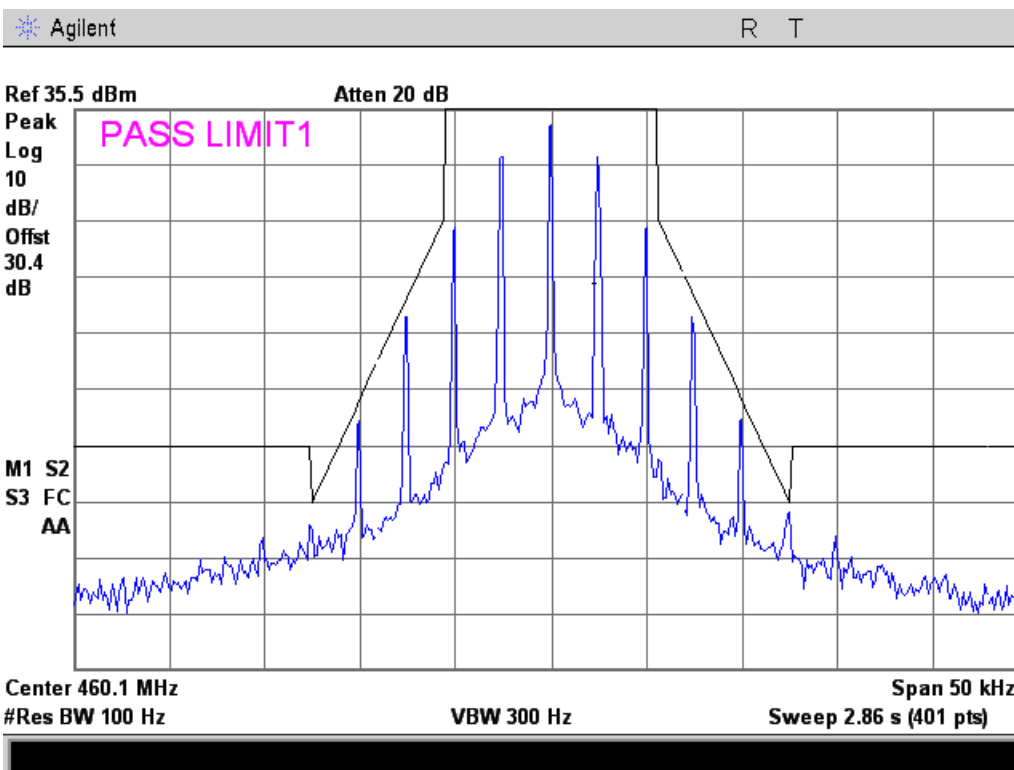

16K0F3E (RSS-119 Only)

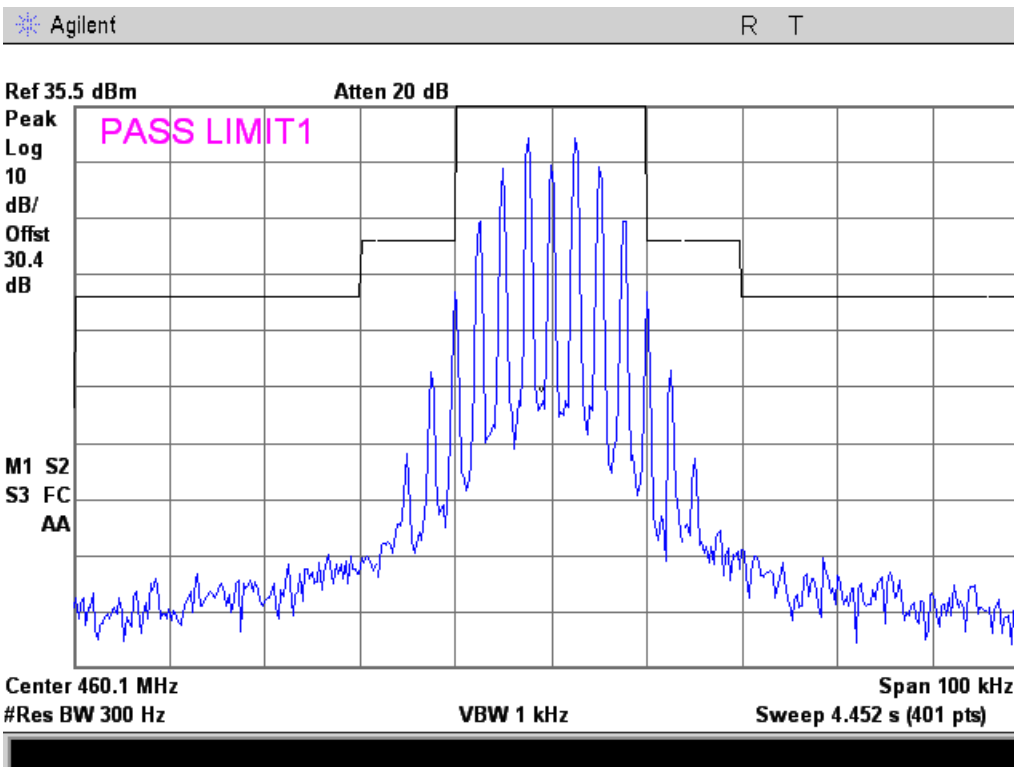



MTM 469.95 MHz Reference

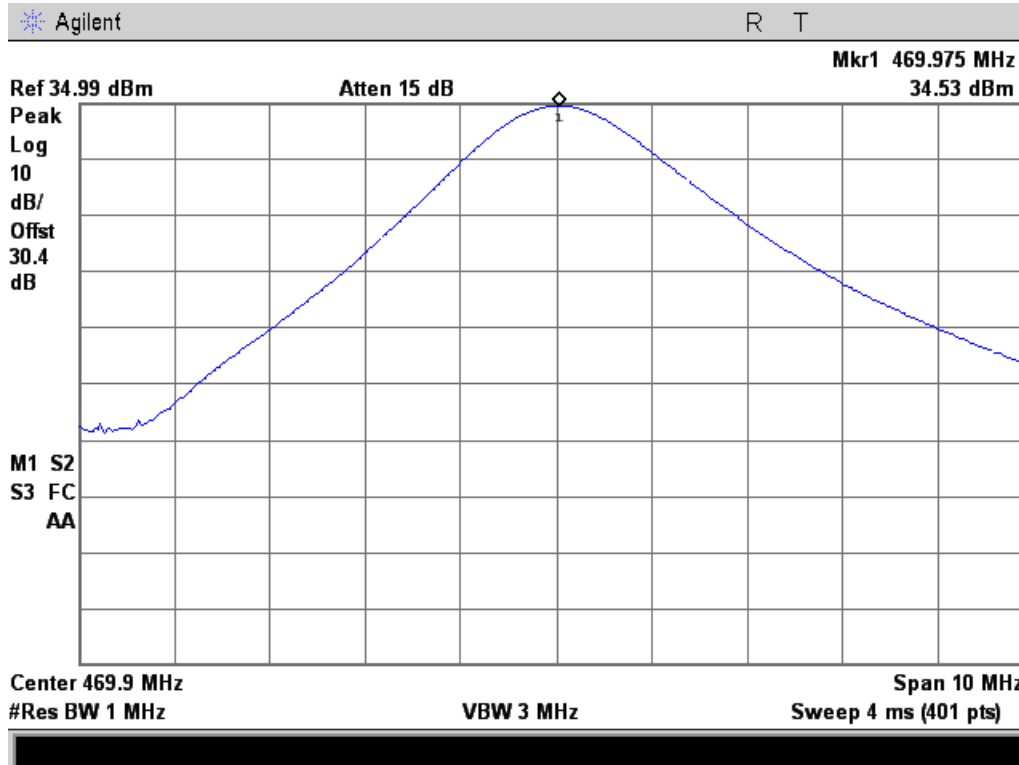

8K10F1D

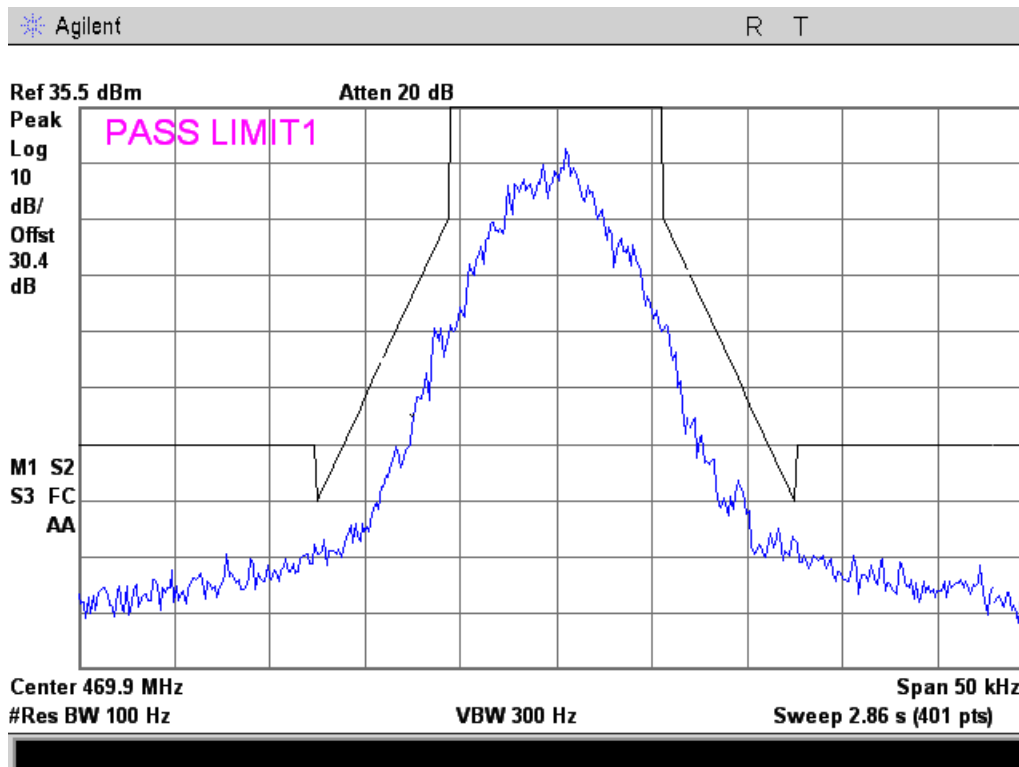



11K0F3E

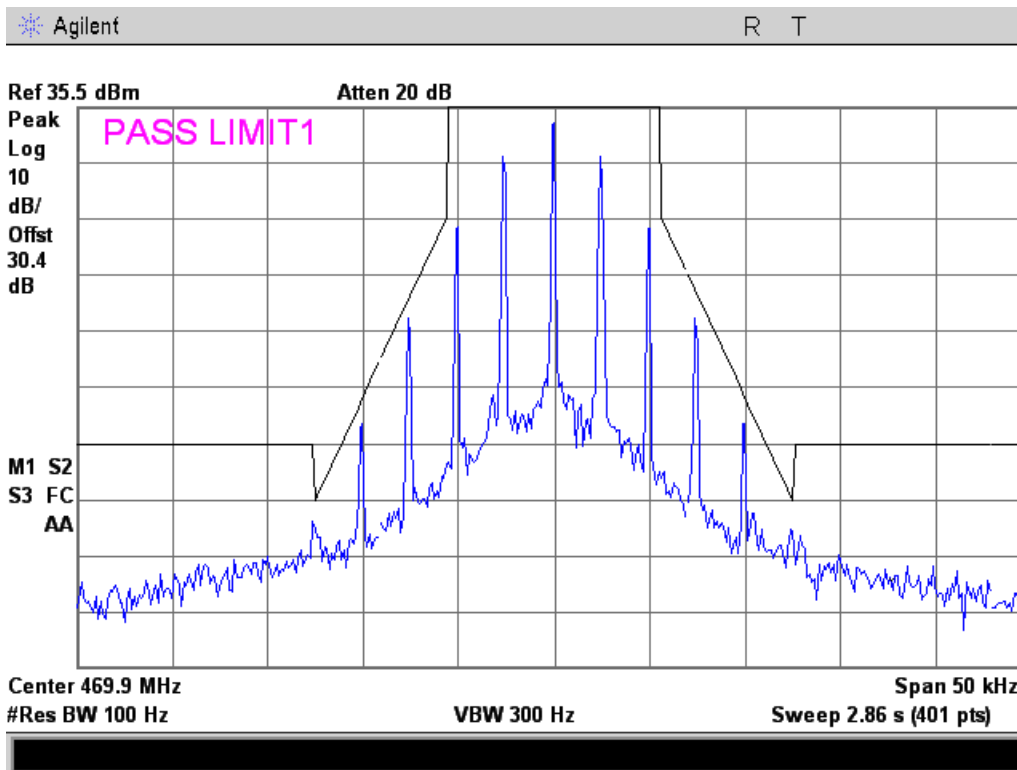

16K0F3E (RSS-119 Only)

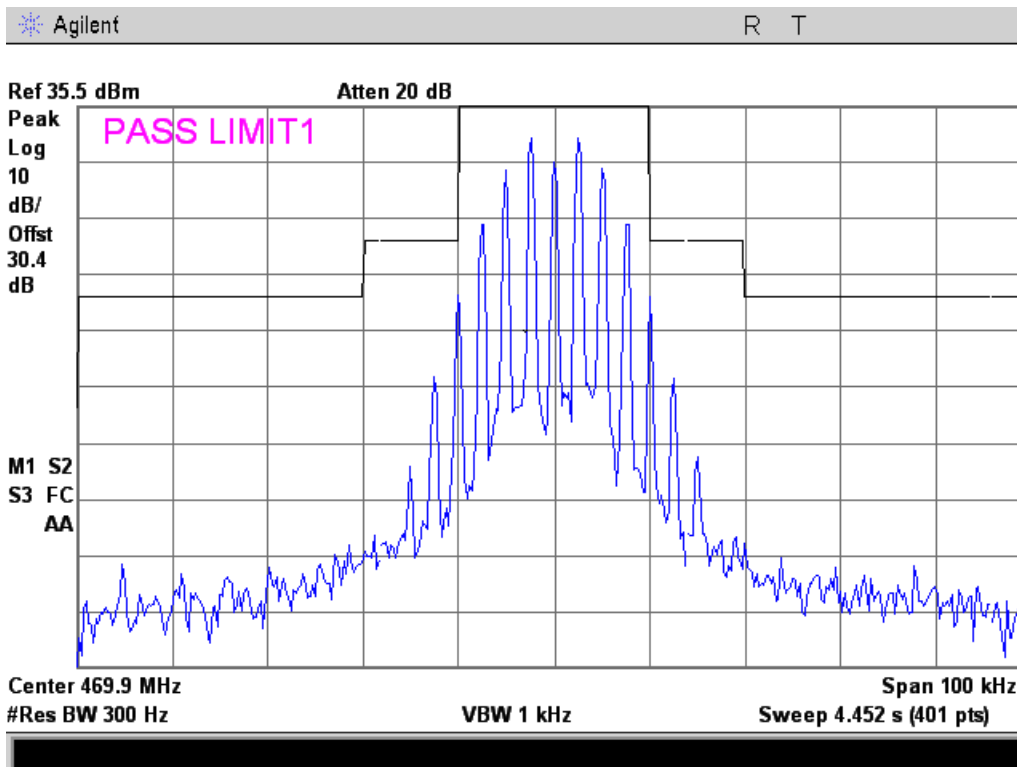



MTM 470.05 MHz Reference

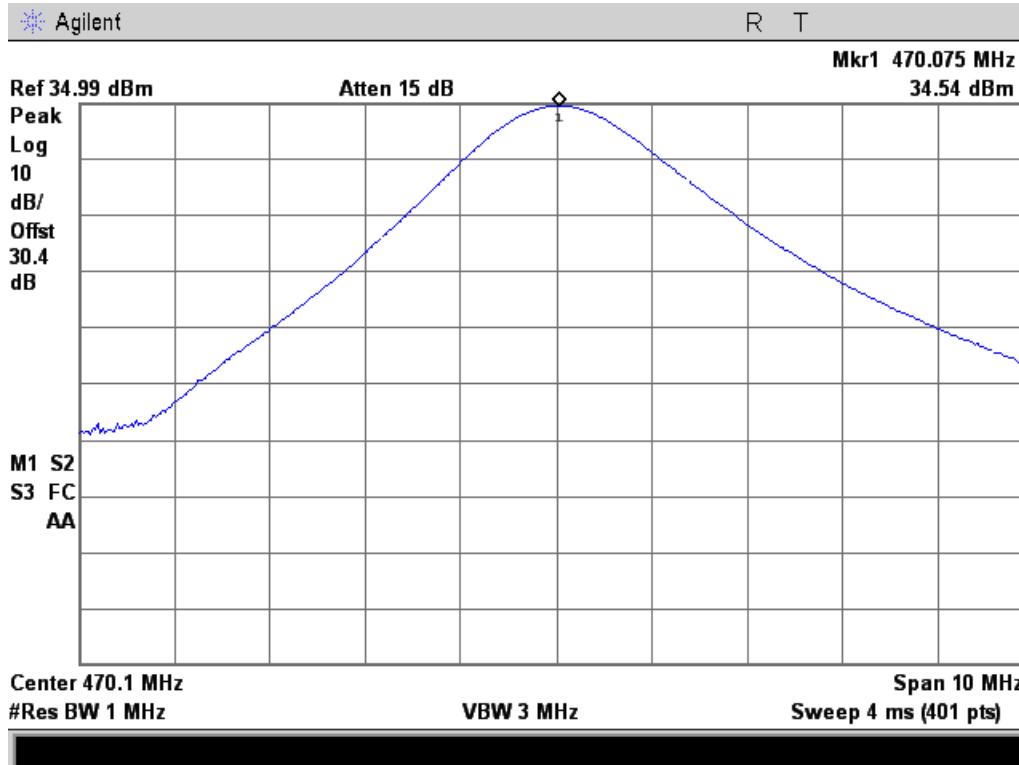

8K10F1D

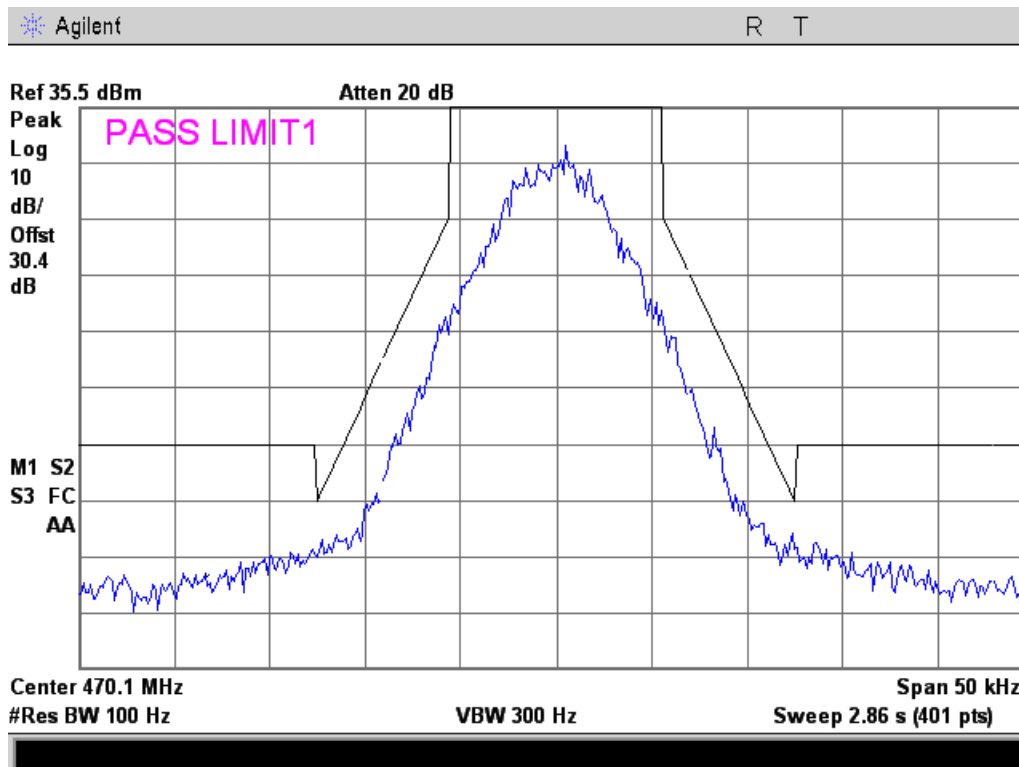



11K0F3E

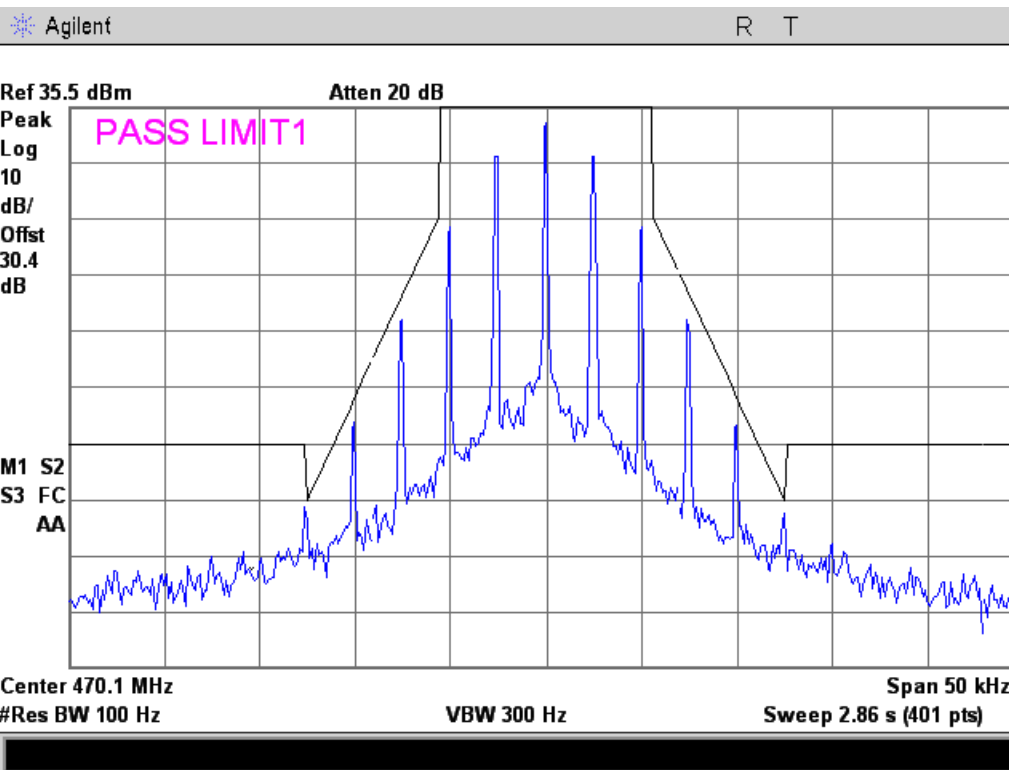

16K0F3E

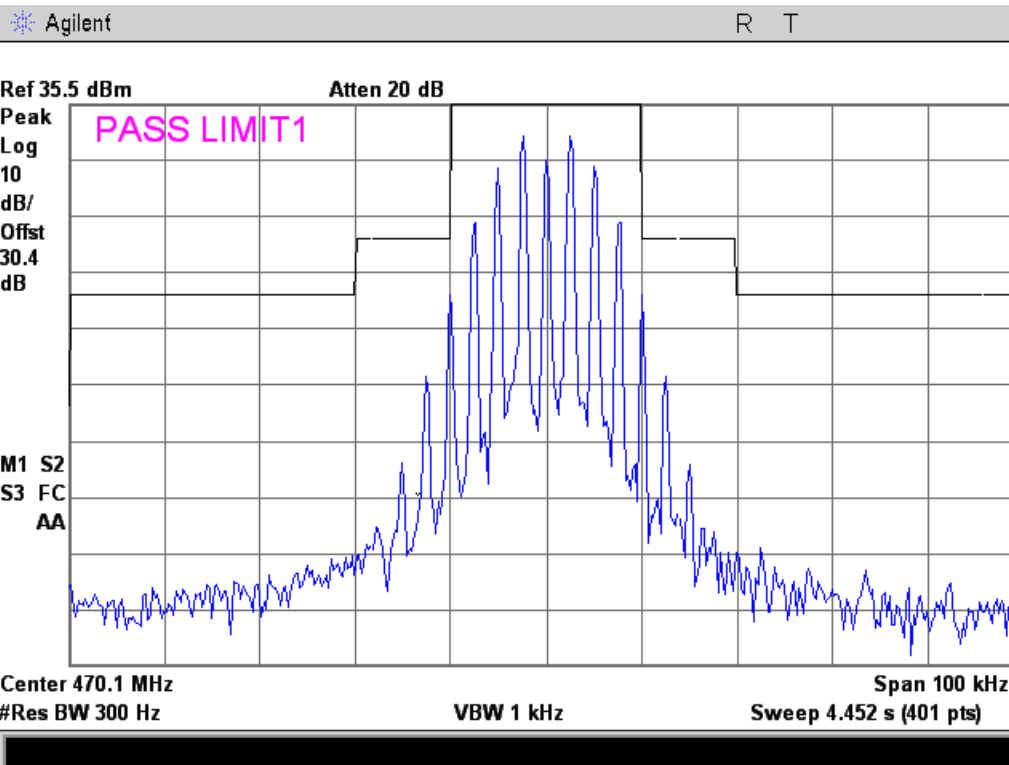



MTM 490.05 MHz Reference

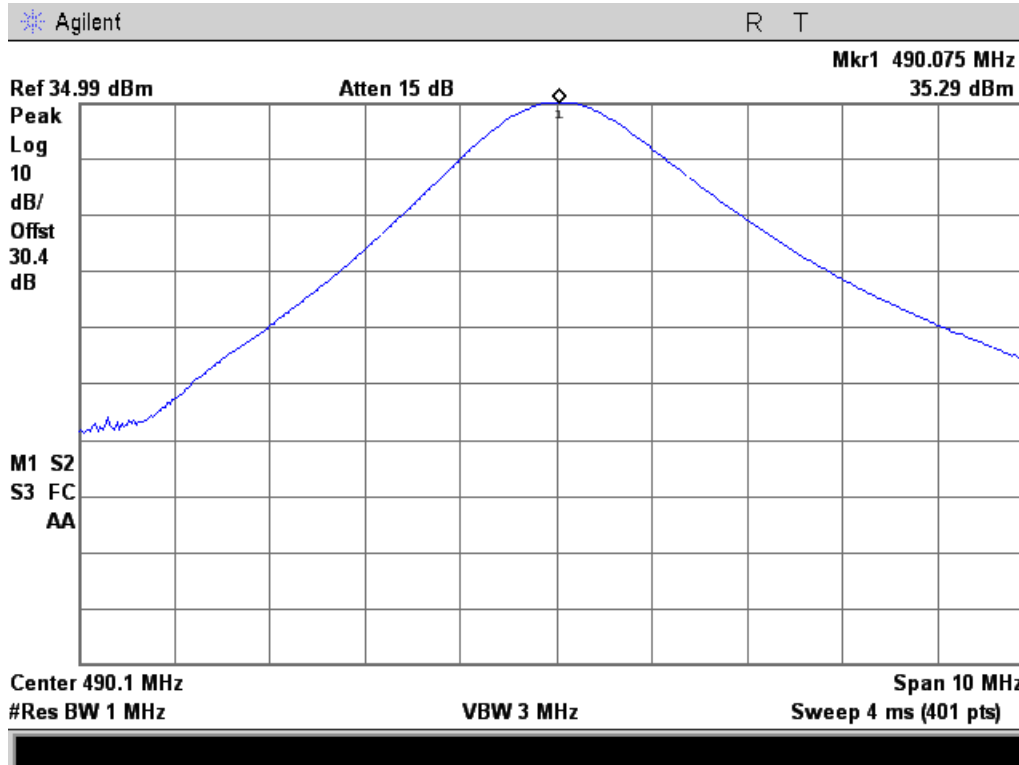

8K10F1D

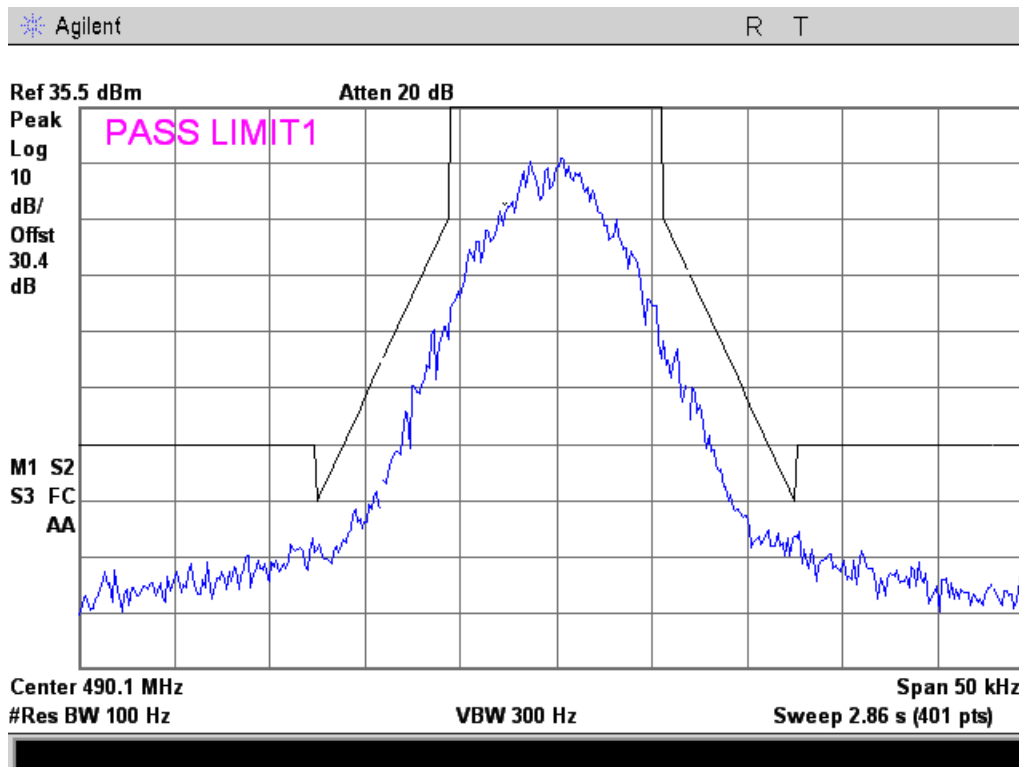



11K0F3E

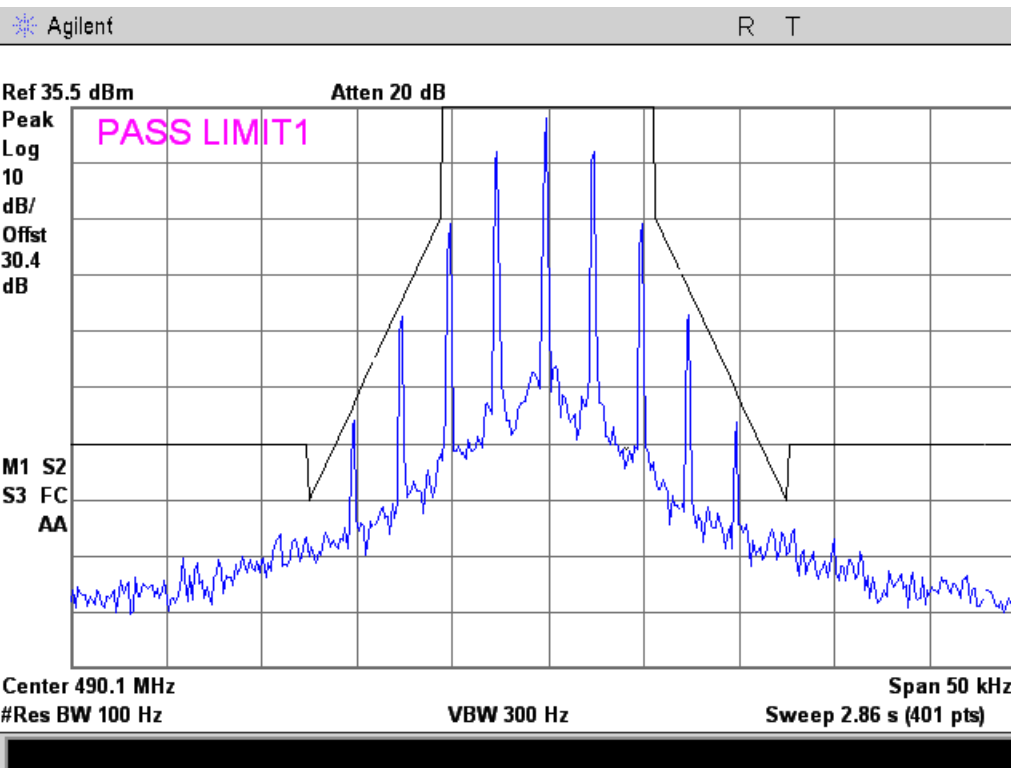

16K0F3E

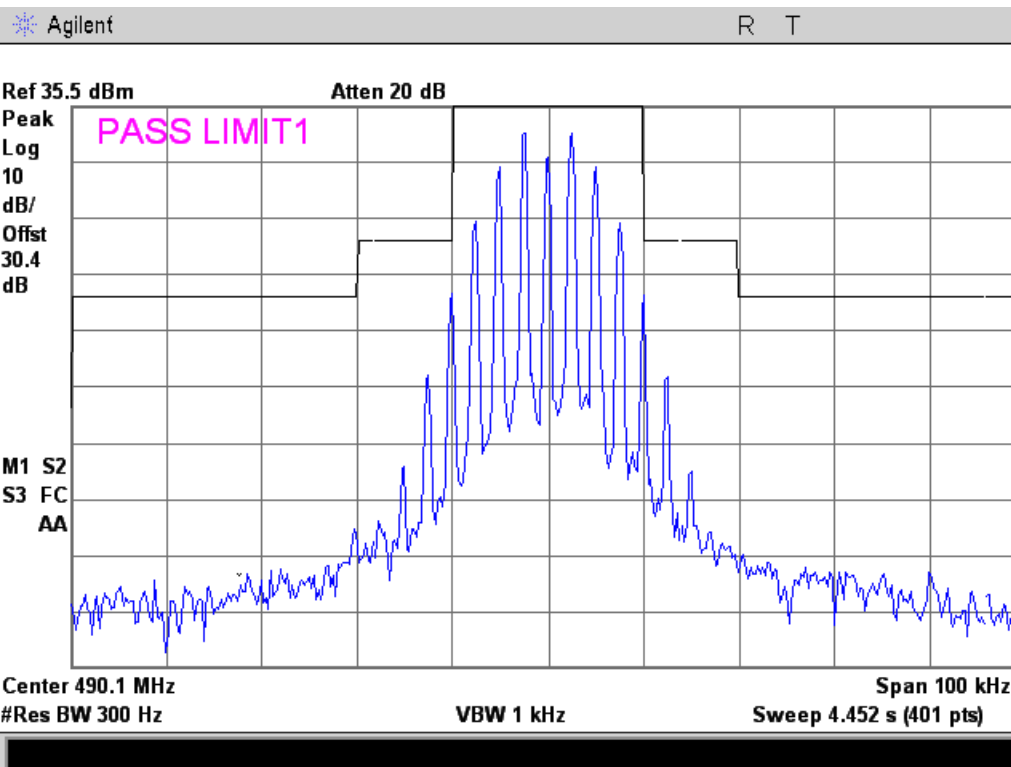



MTM 511.95 MHz Reference

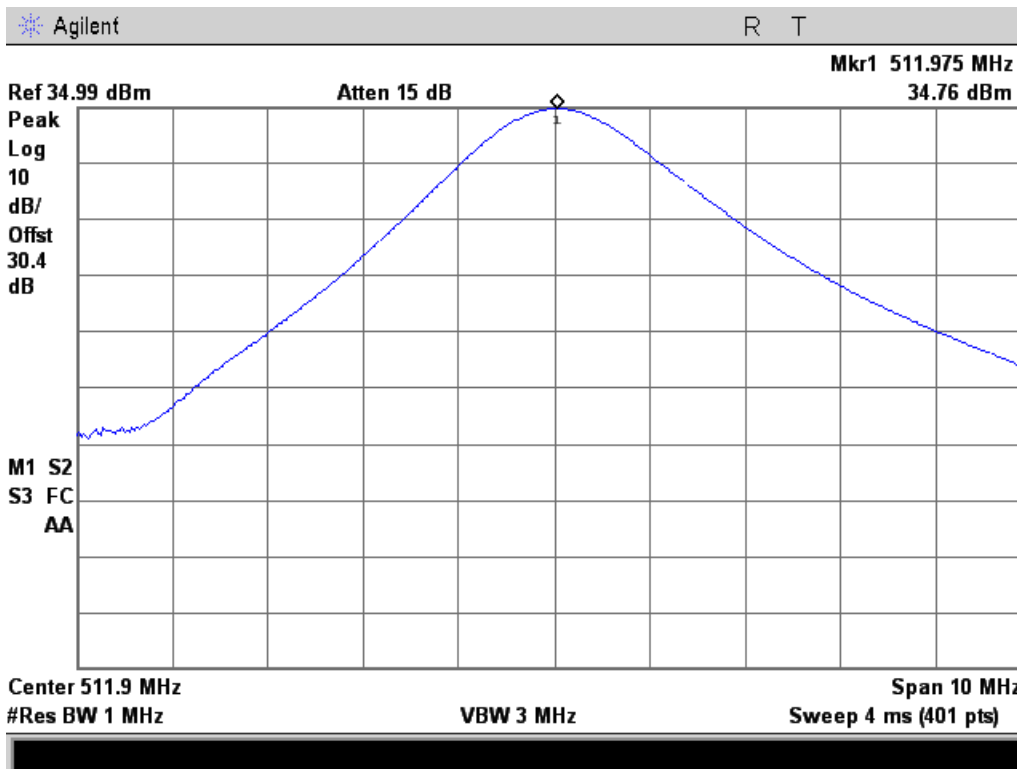

8K10F1D

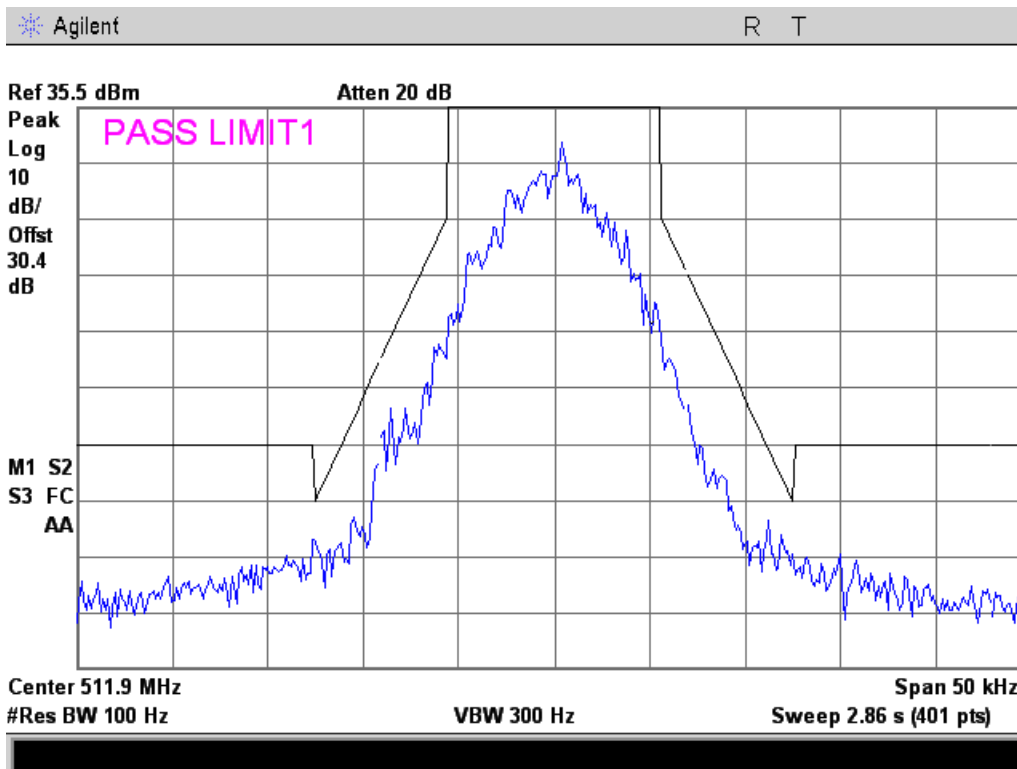



11K0F3E

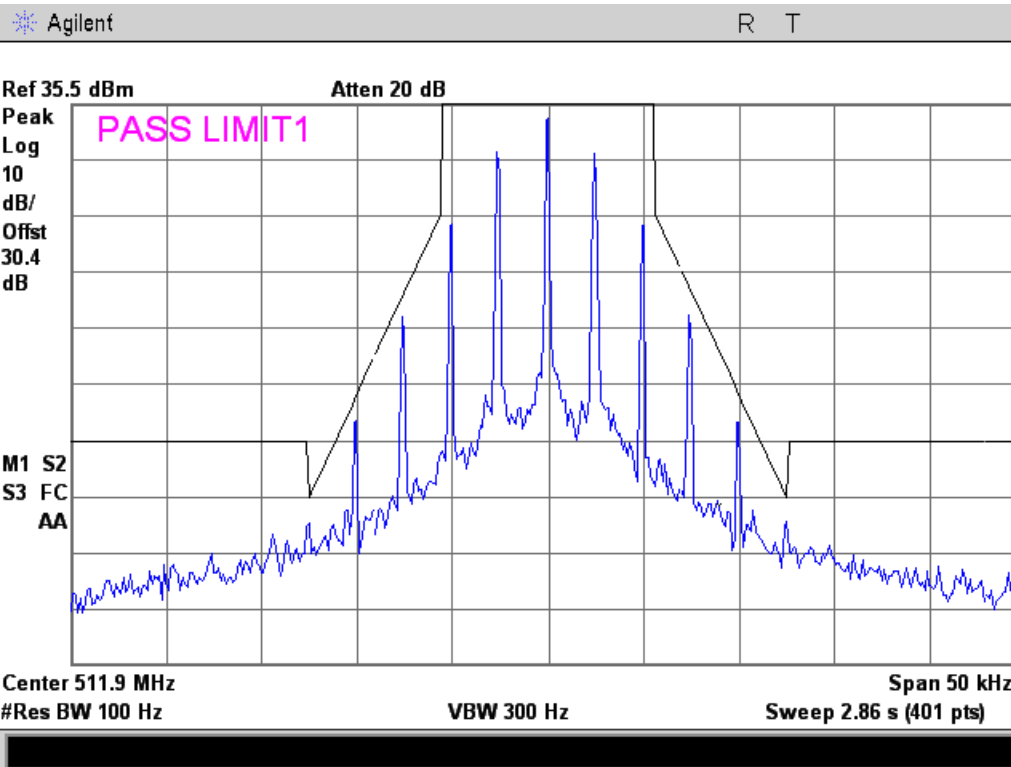

16K0F3E

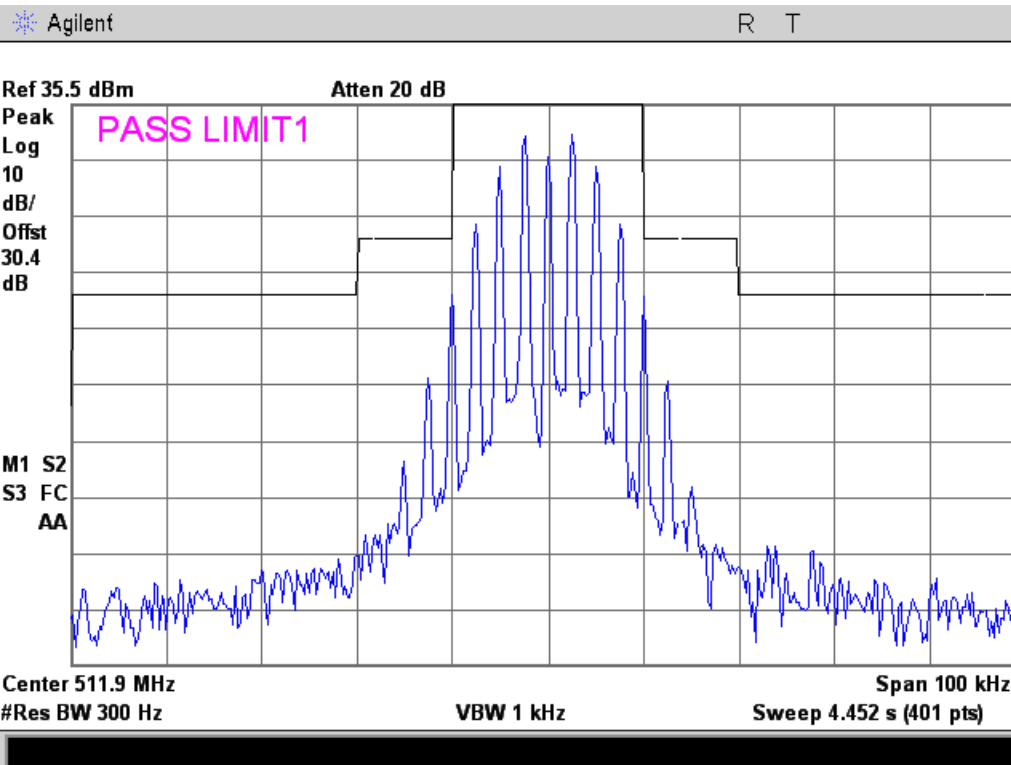



MTM 519.95 MHz Reference

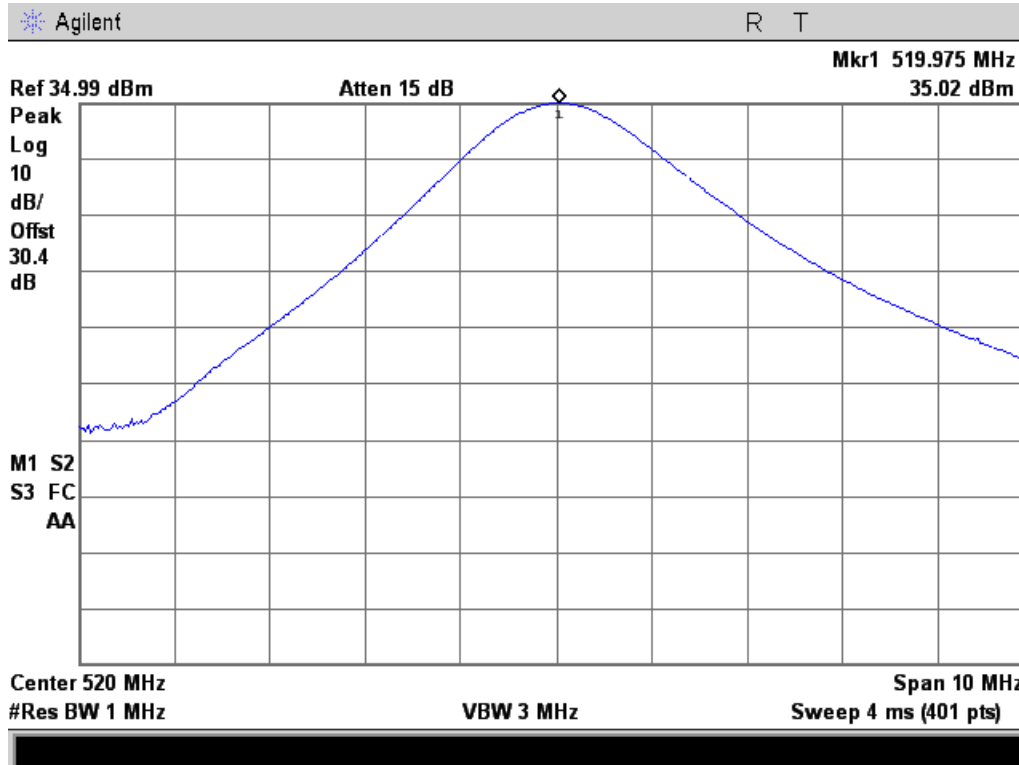

8K10F1D

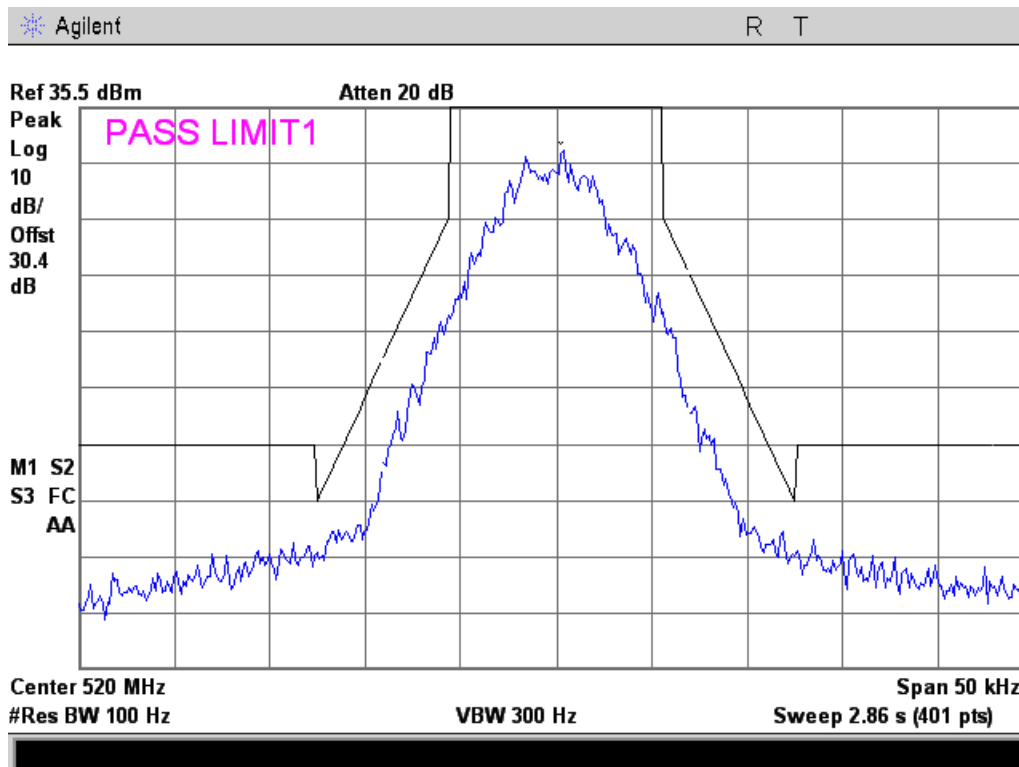



11K0F3E

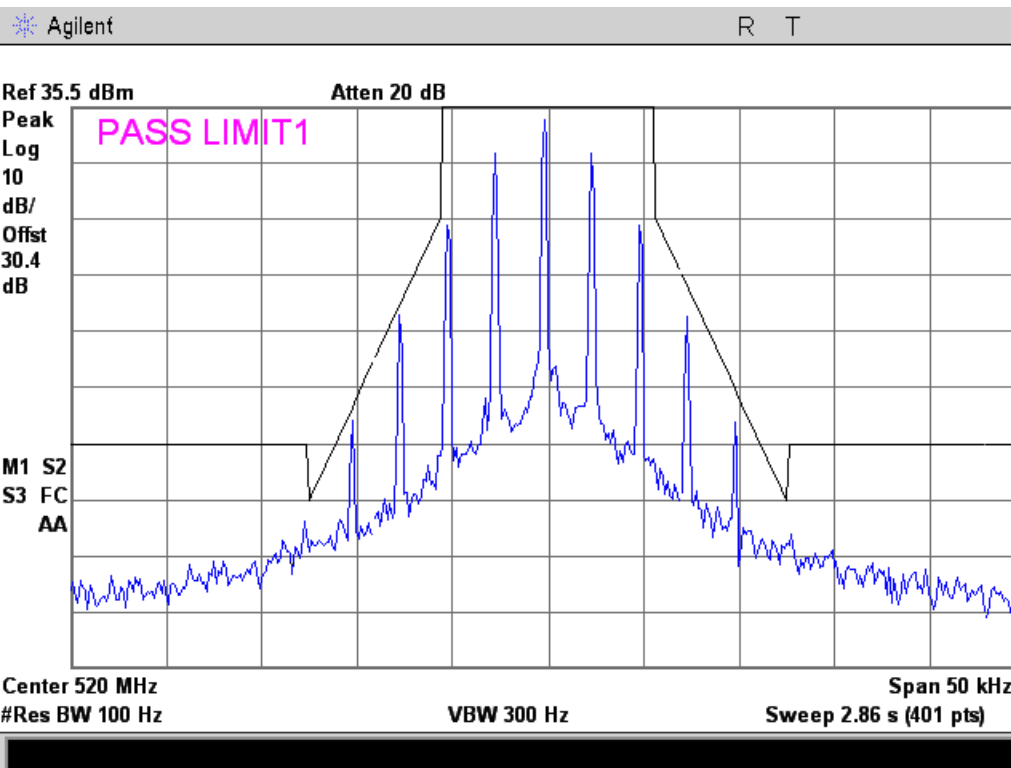

16K0F3E

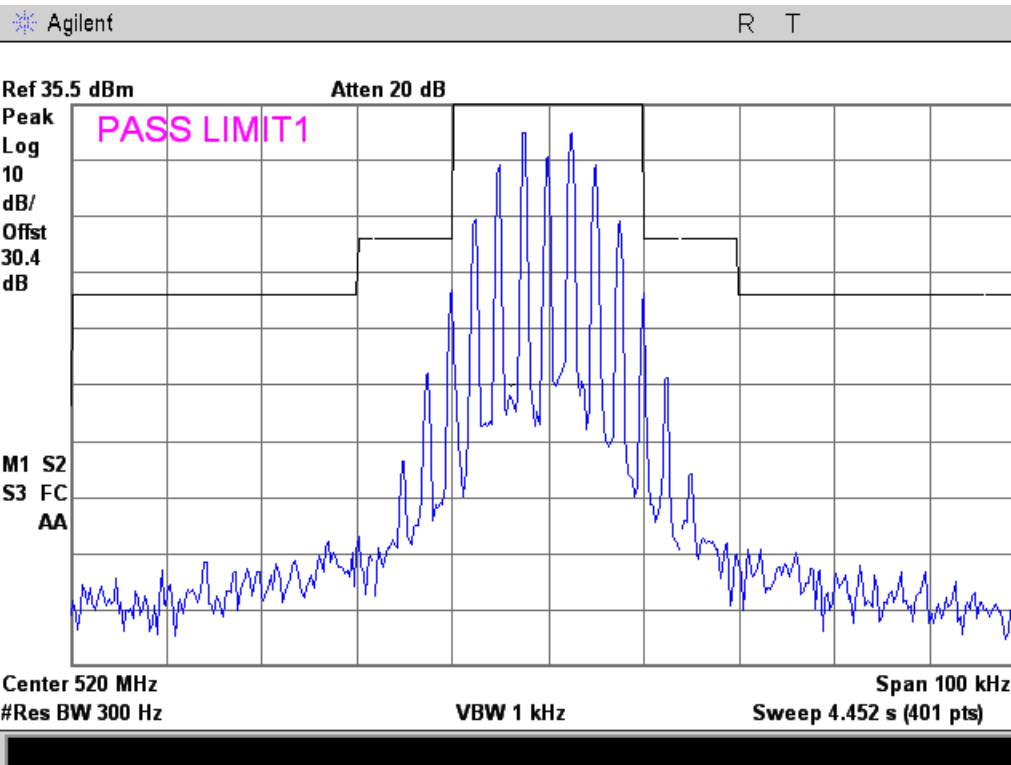



MTM 764.05 MHz Reference

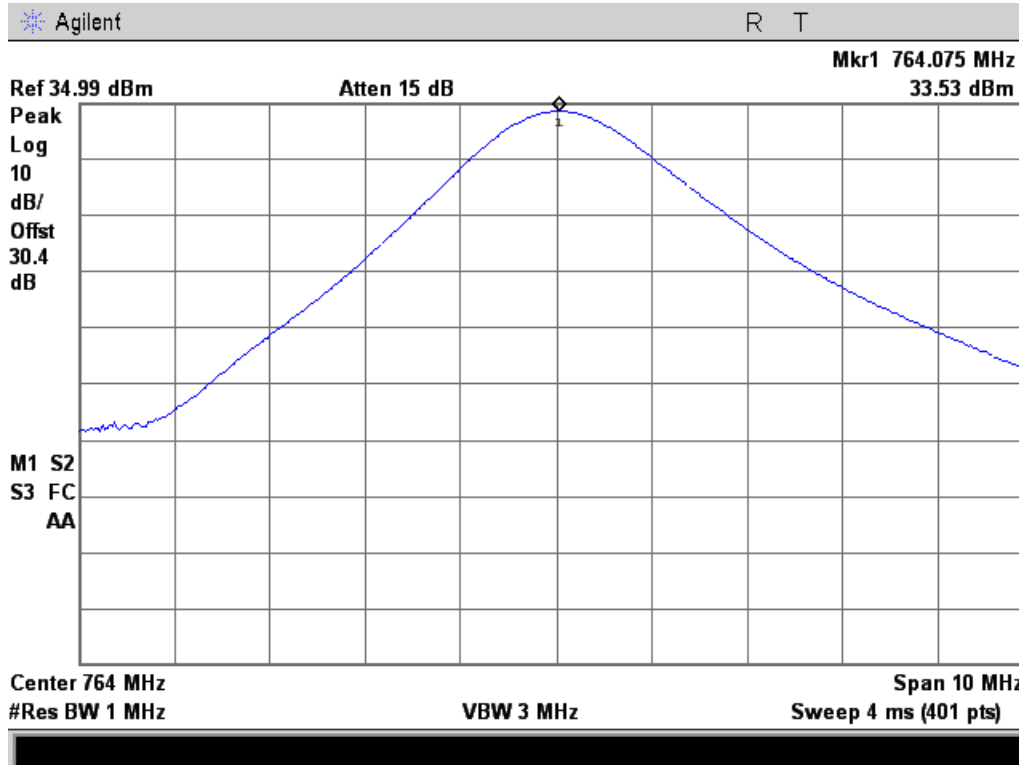

8K10F1D

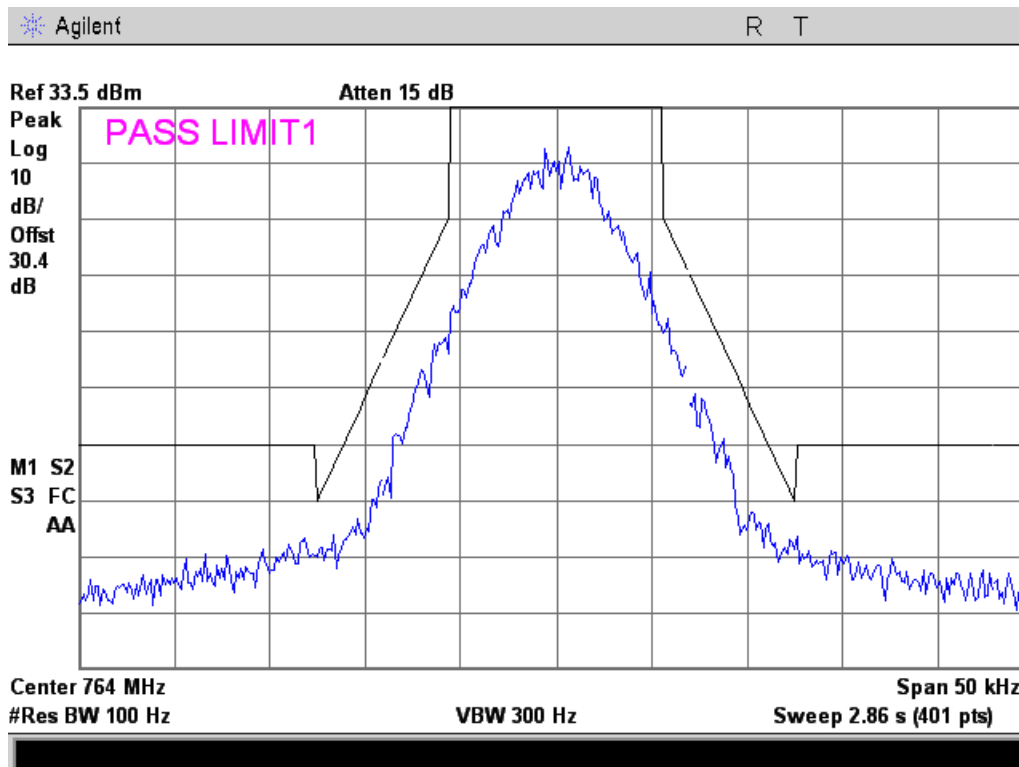



11K0F3E

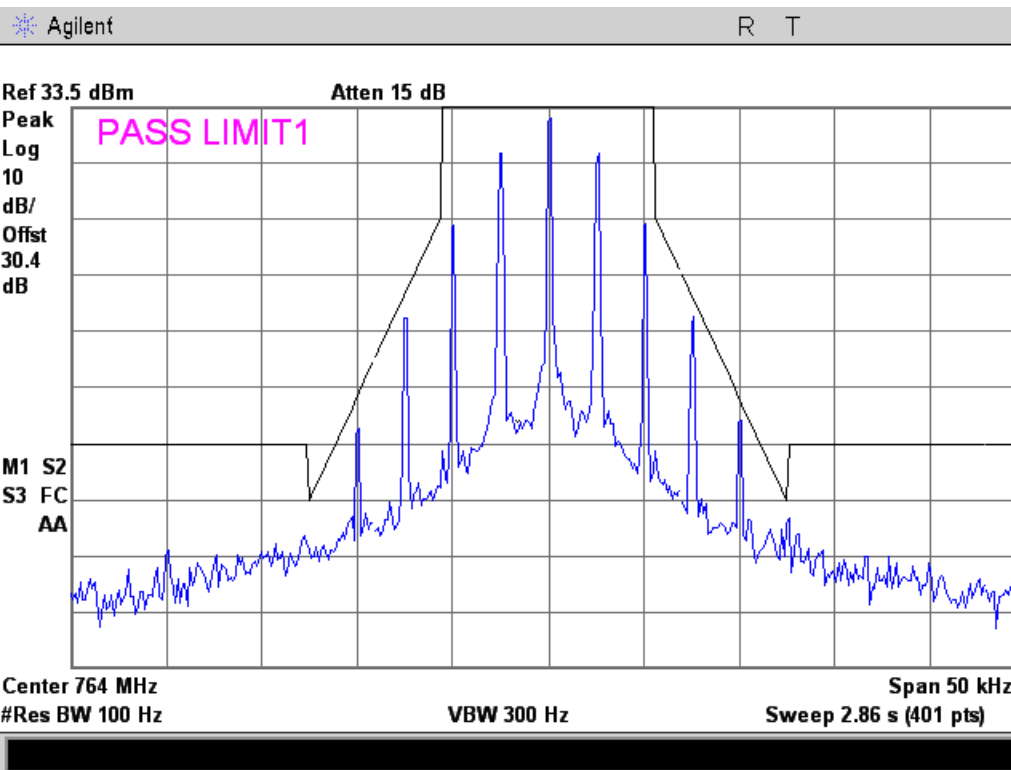

16K0F3E

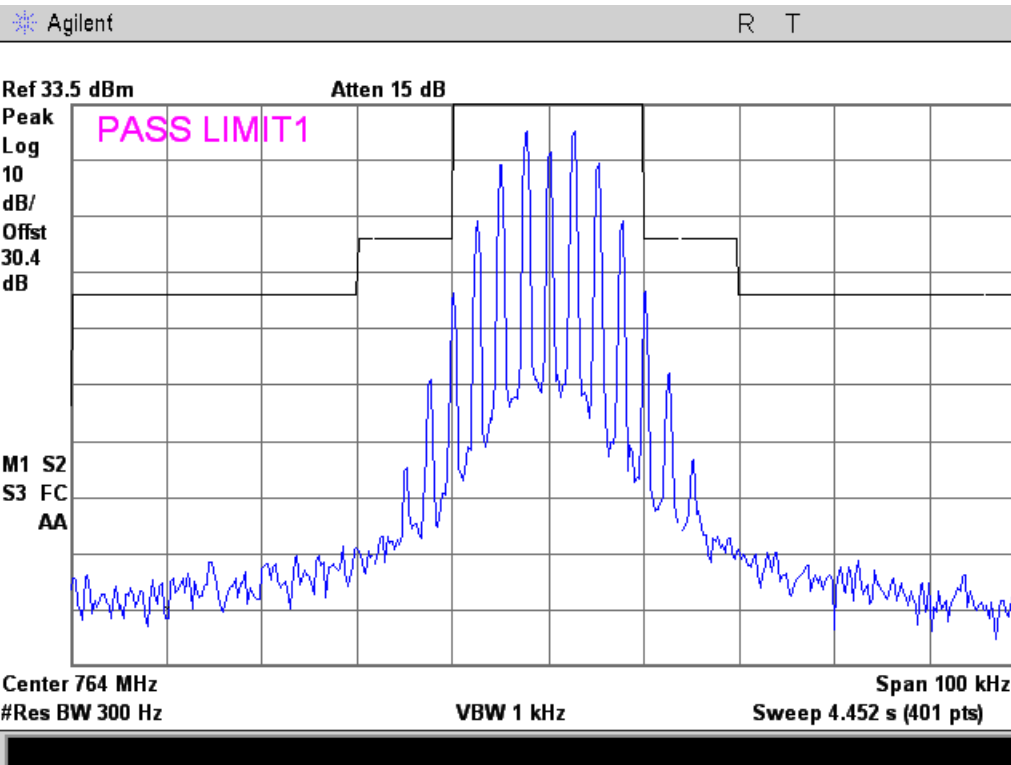



MTM 769.95 MHz Reference

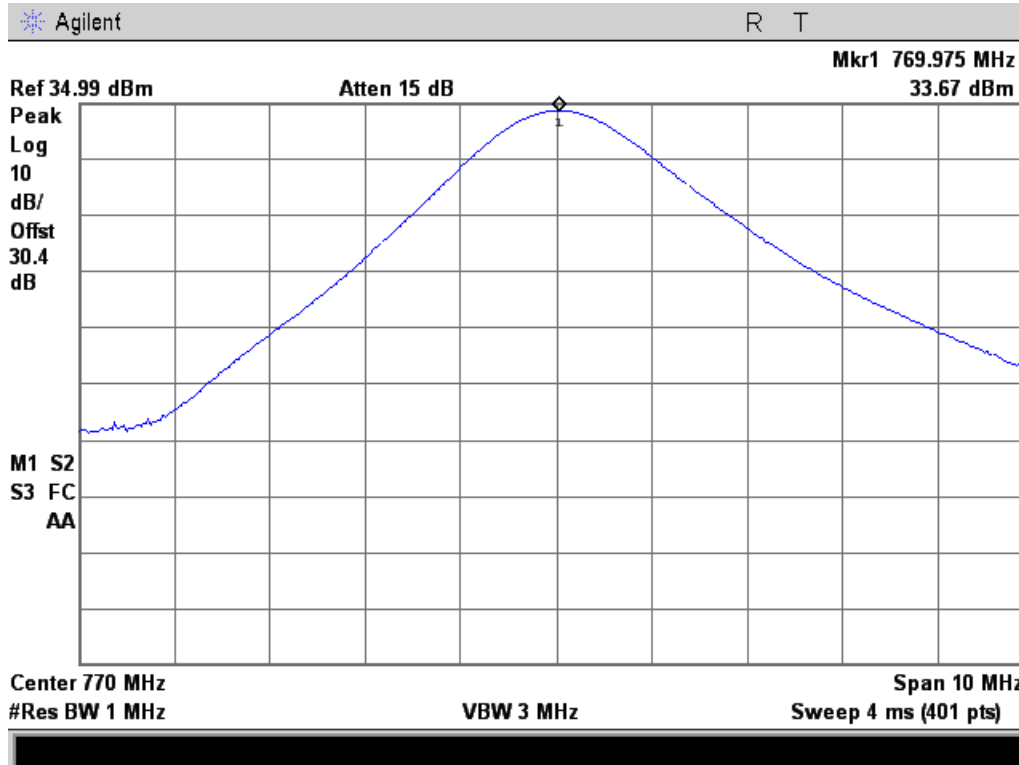

8K10F1D

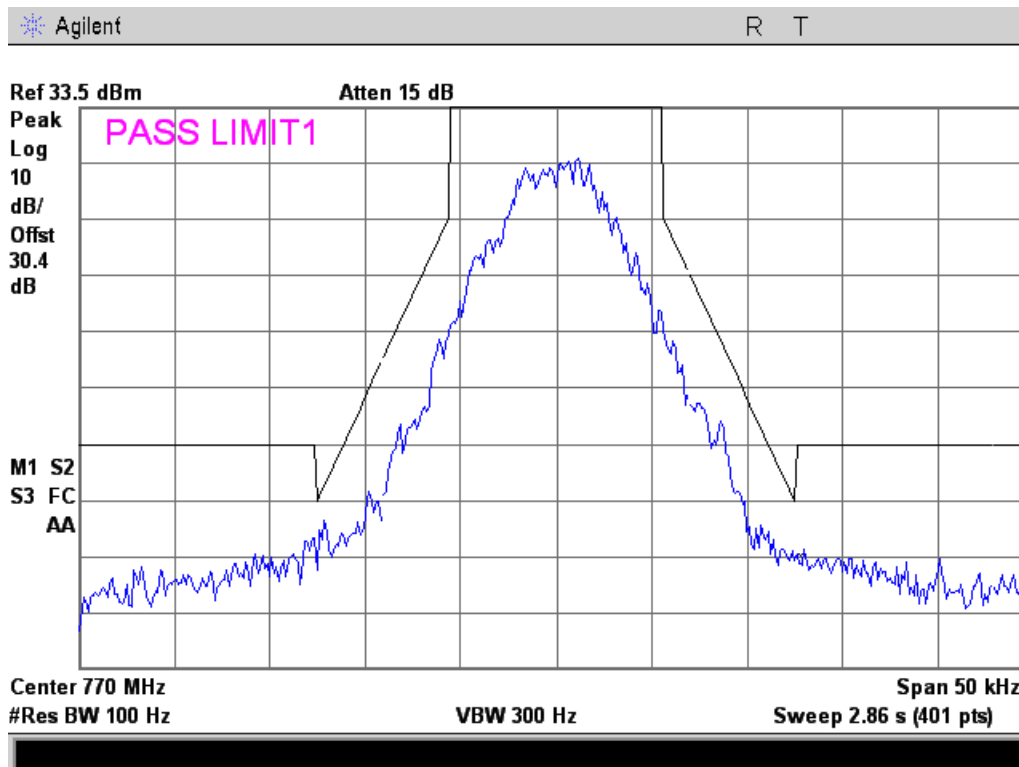



11K0F3E

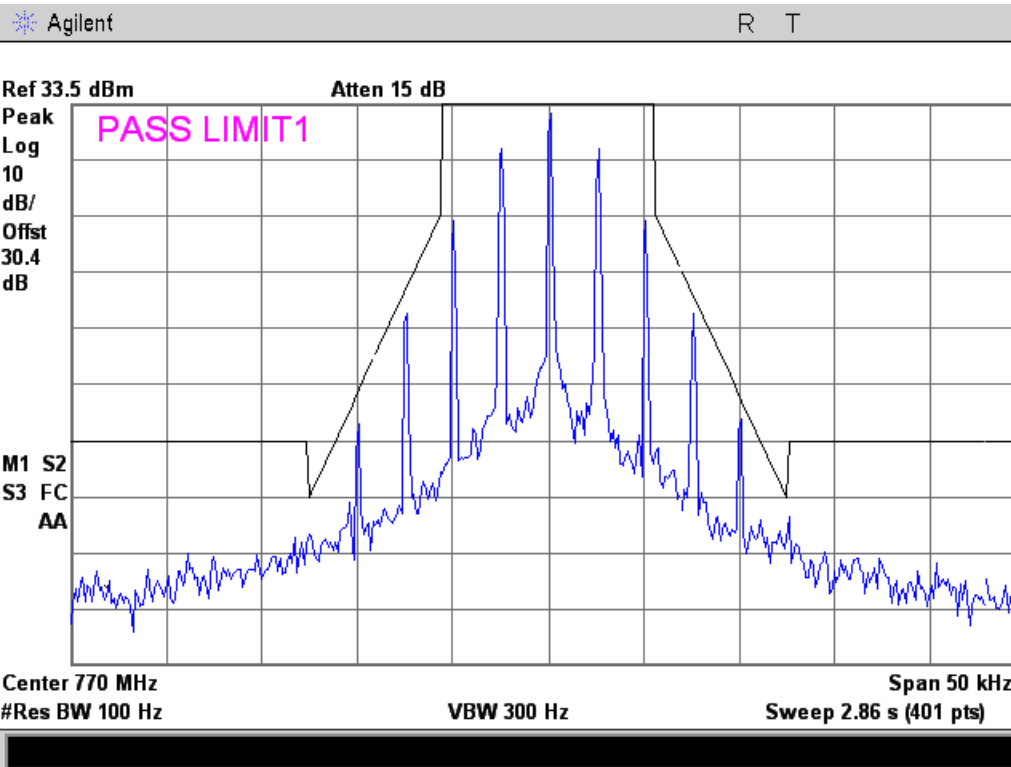

16K0F3E

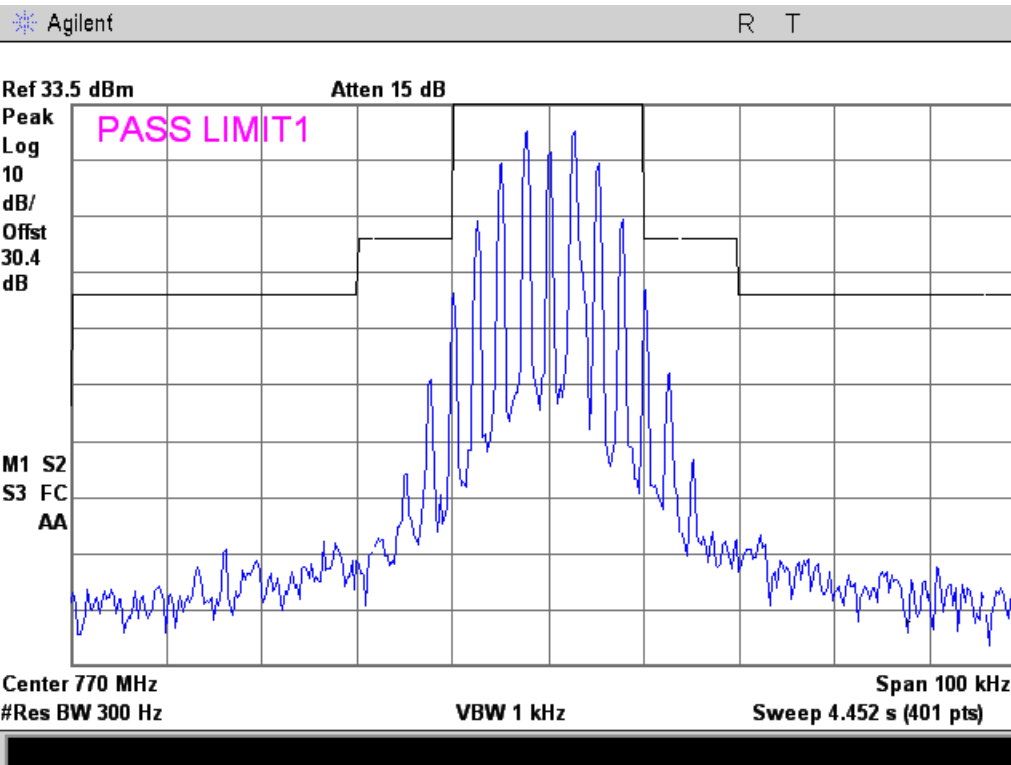



MTM 774.95 MHz Reference

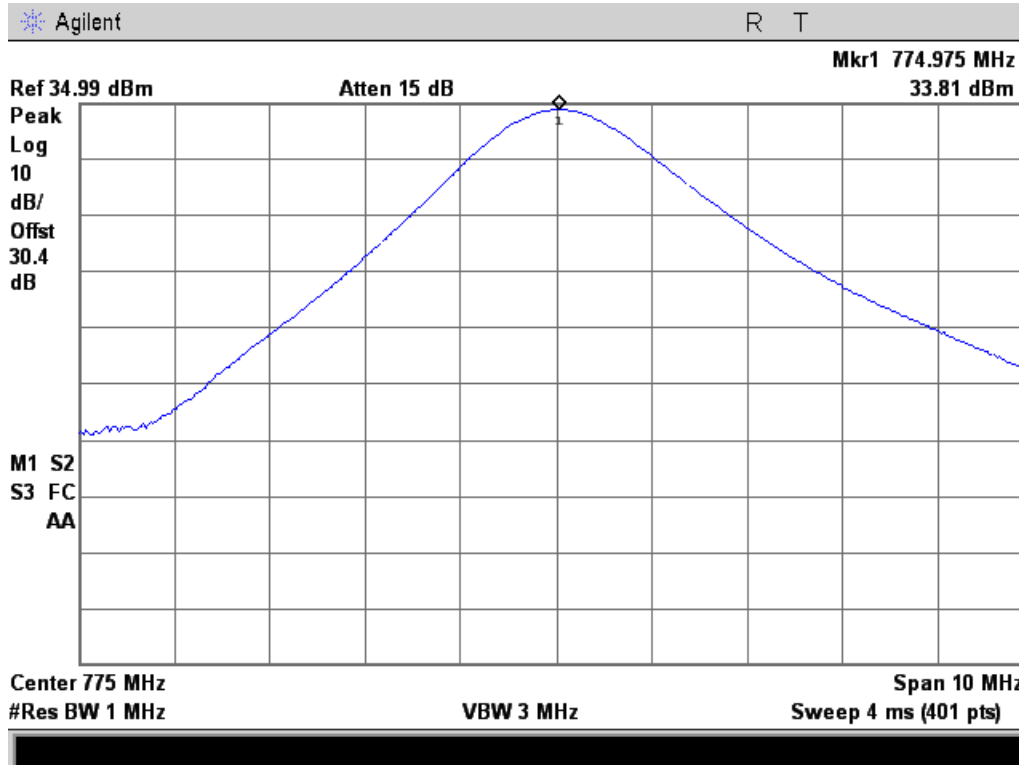

8K10F1D

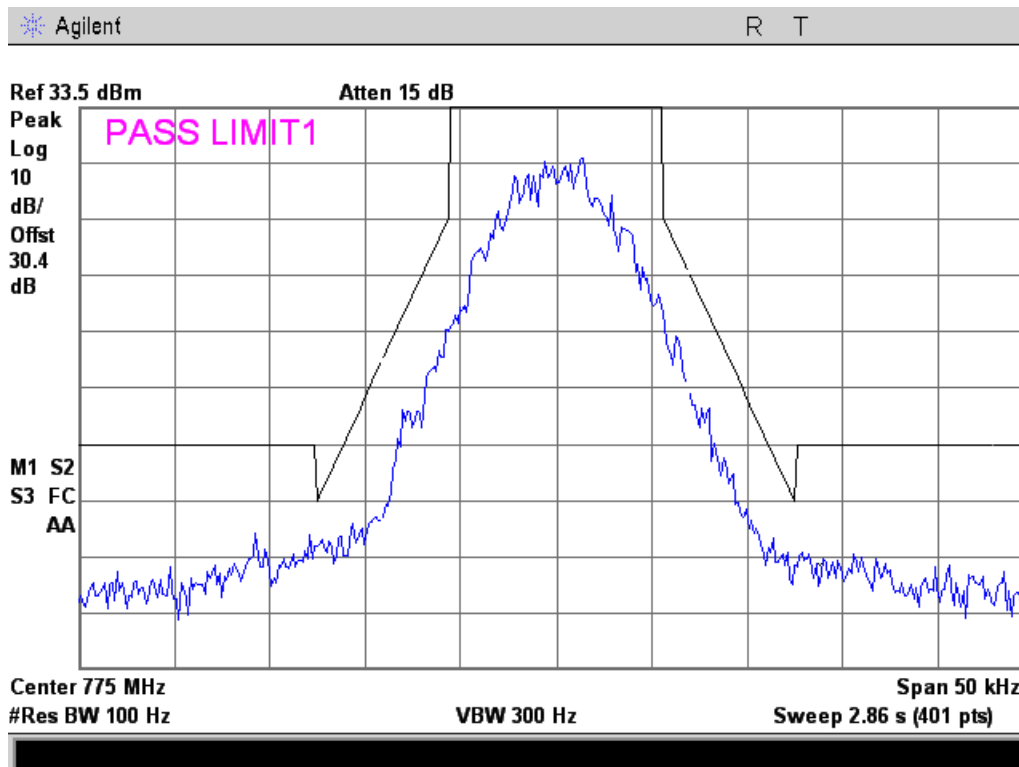



11K0F3E

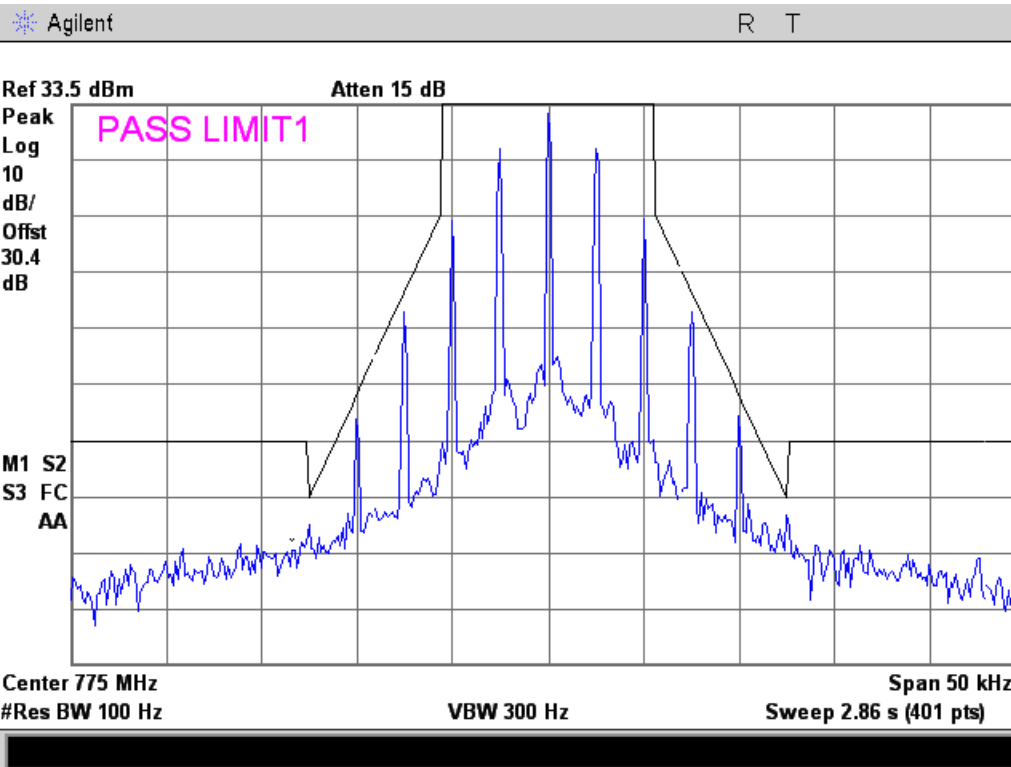

16K0F3E

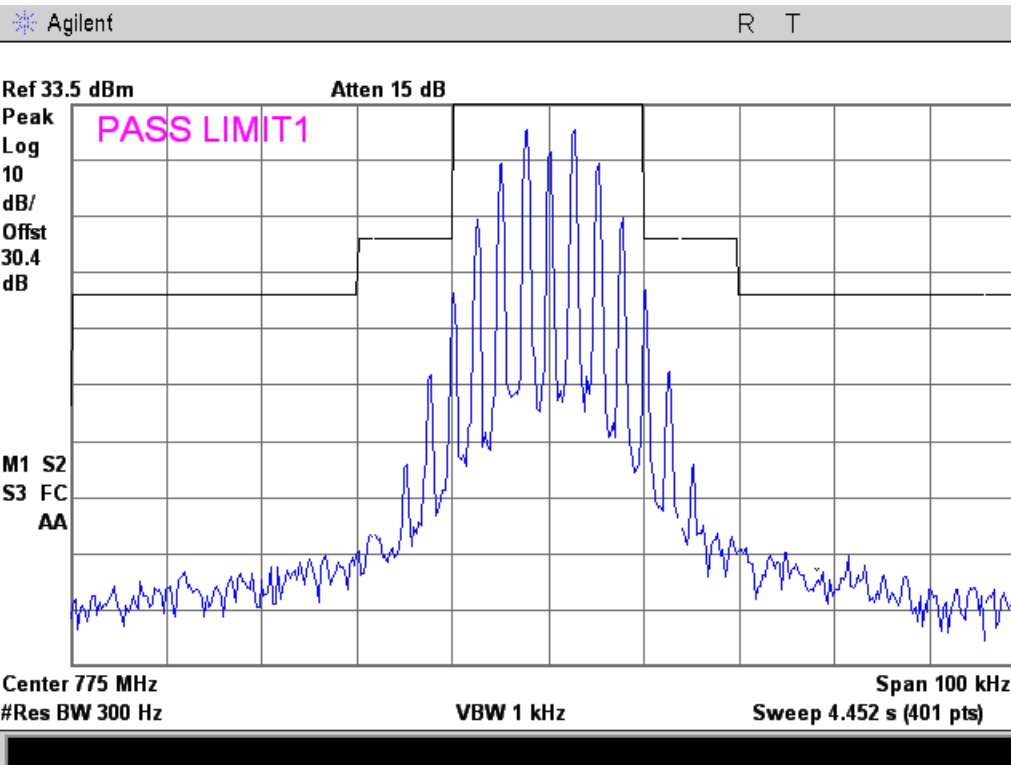



MTM 851.05 MHz Reference

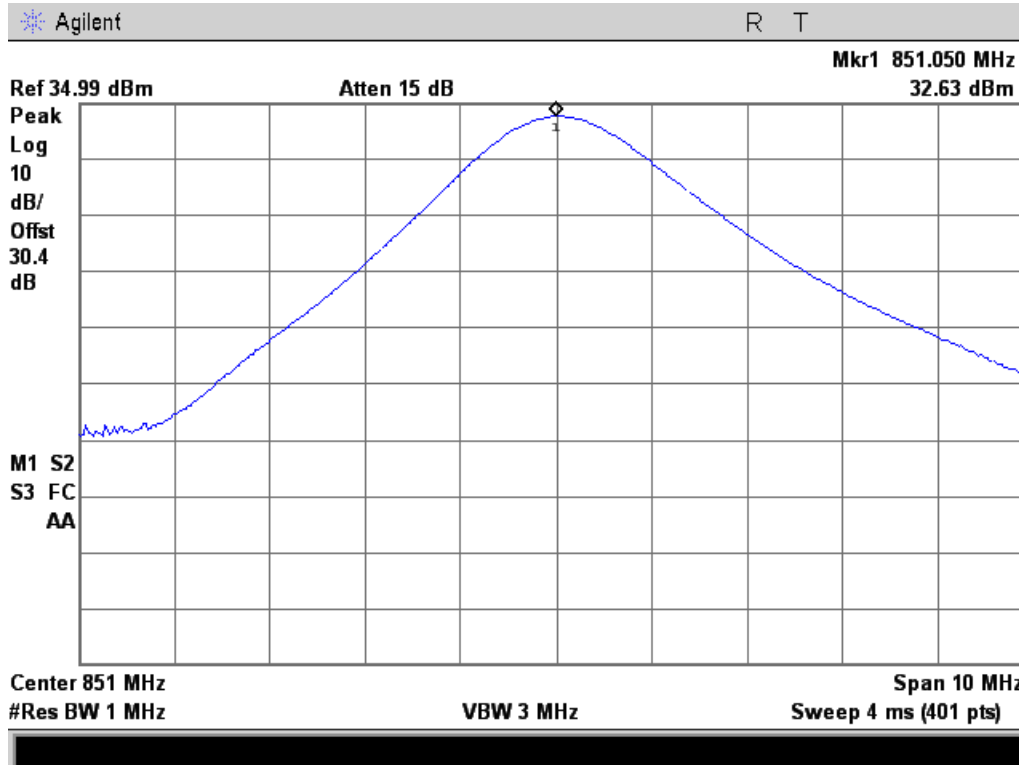

8K10F1D

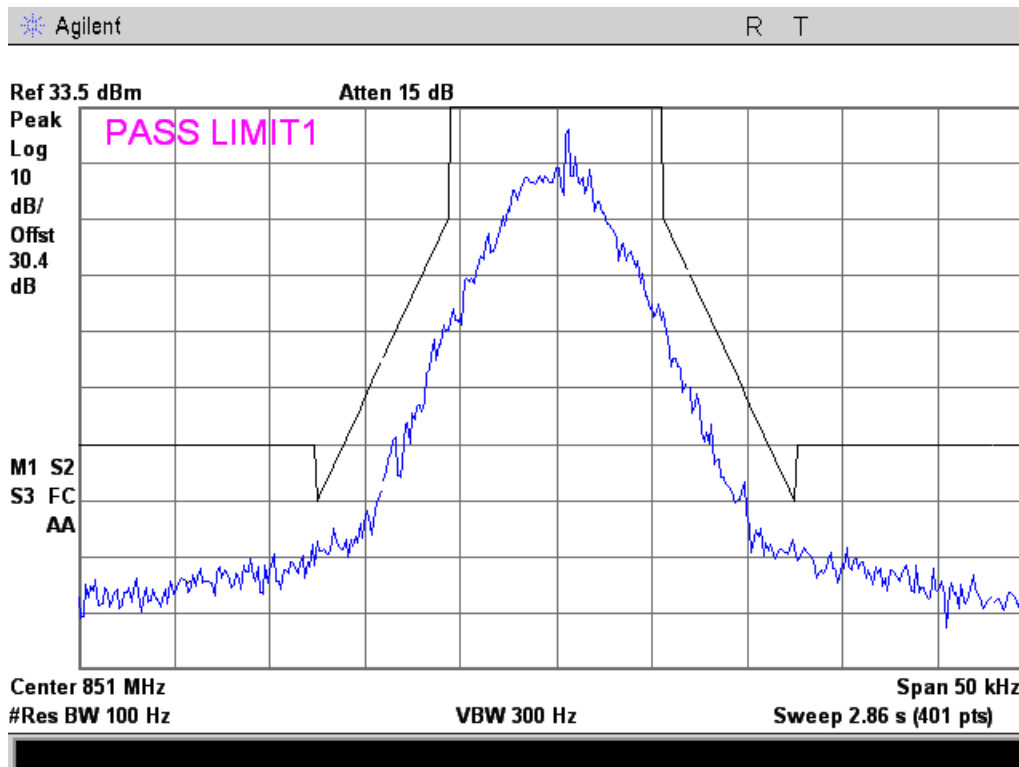



11K0F3E

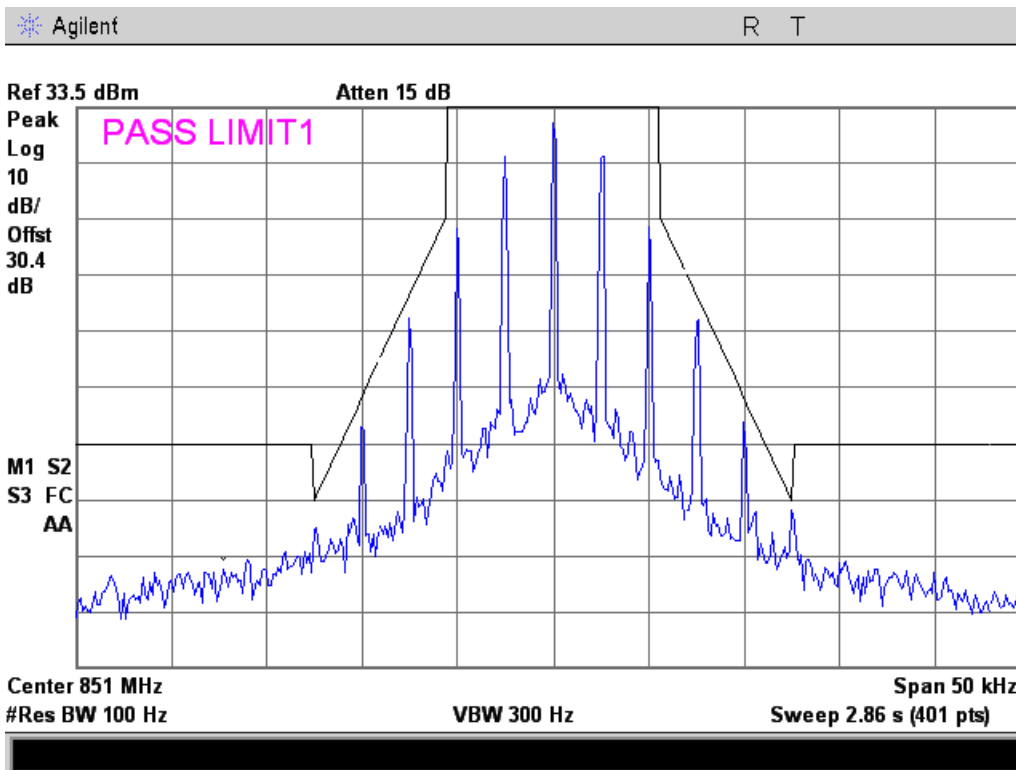

16K0F3E

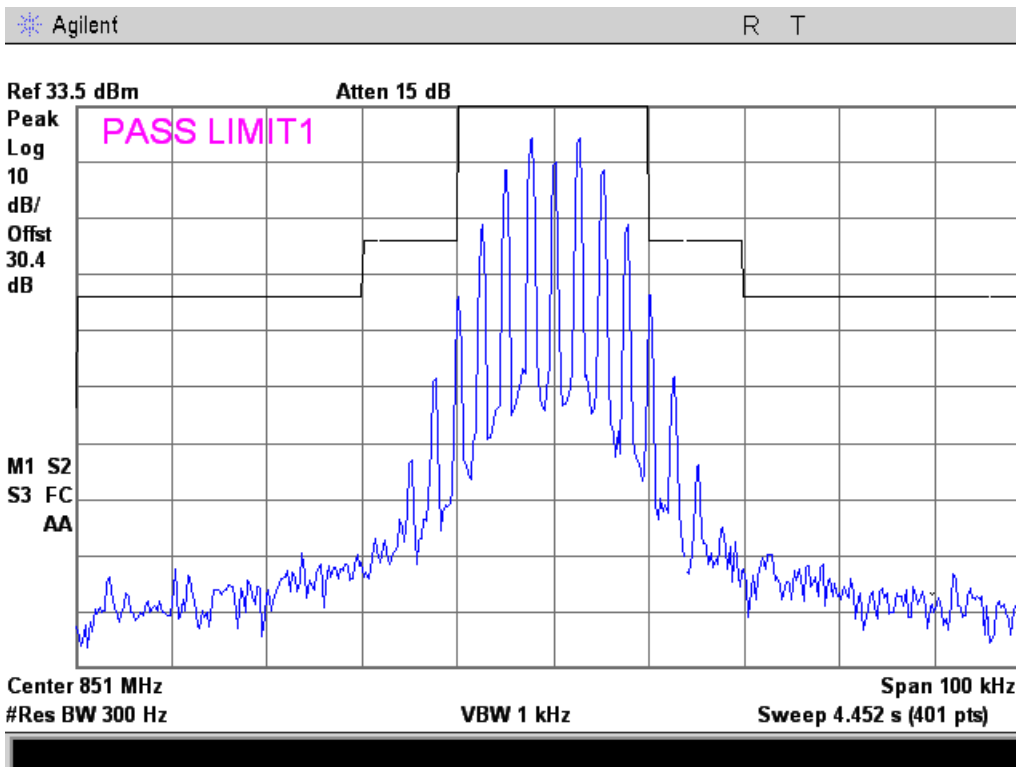



MTM 854.05 MHz Reference

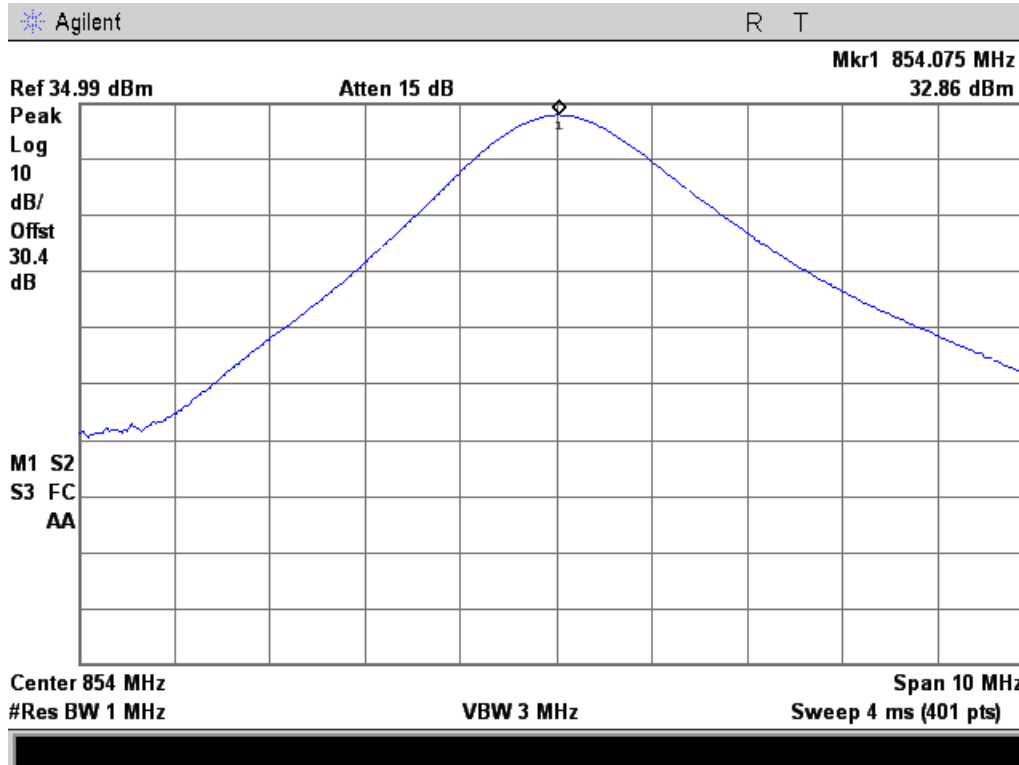

8K10F1D

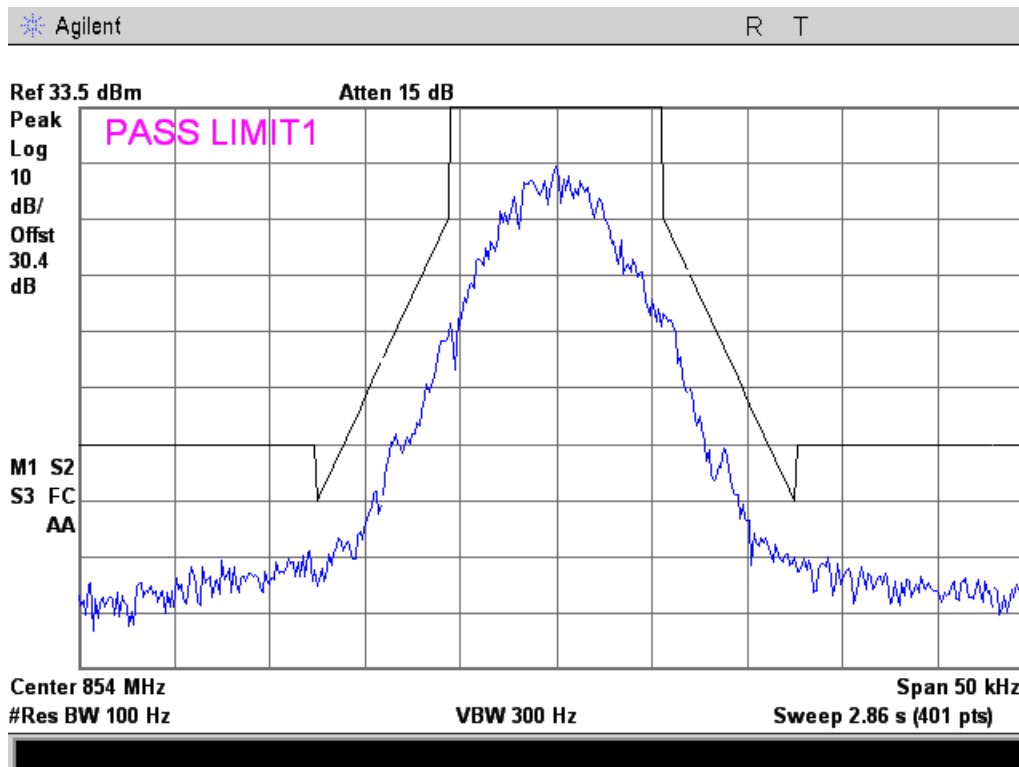



11K0F3E

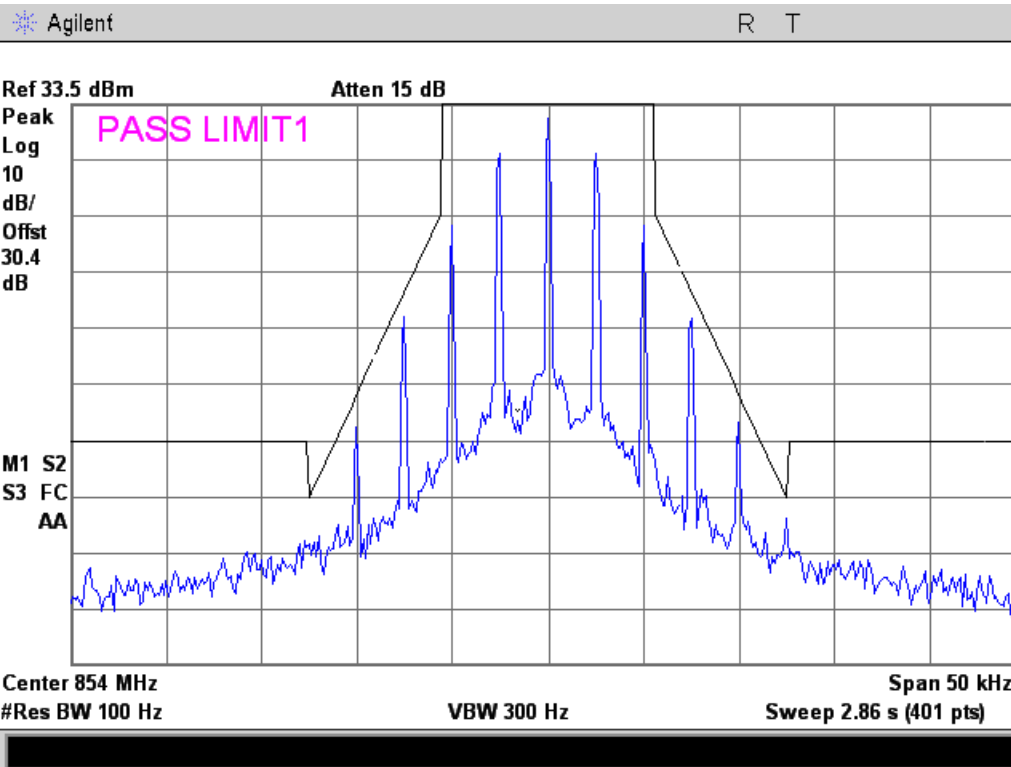

16K0F3E

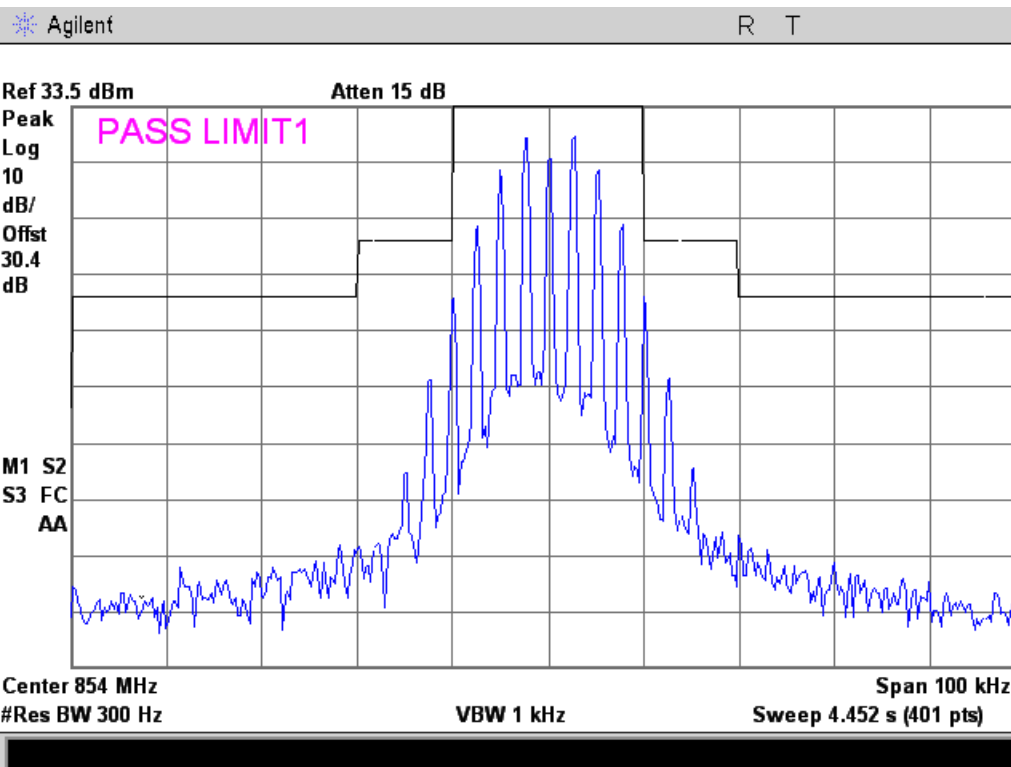



MTM 869.95 MHz Reference

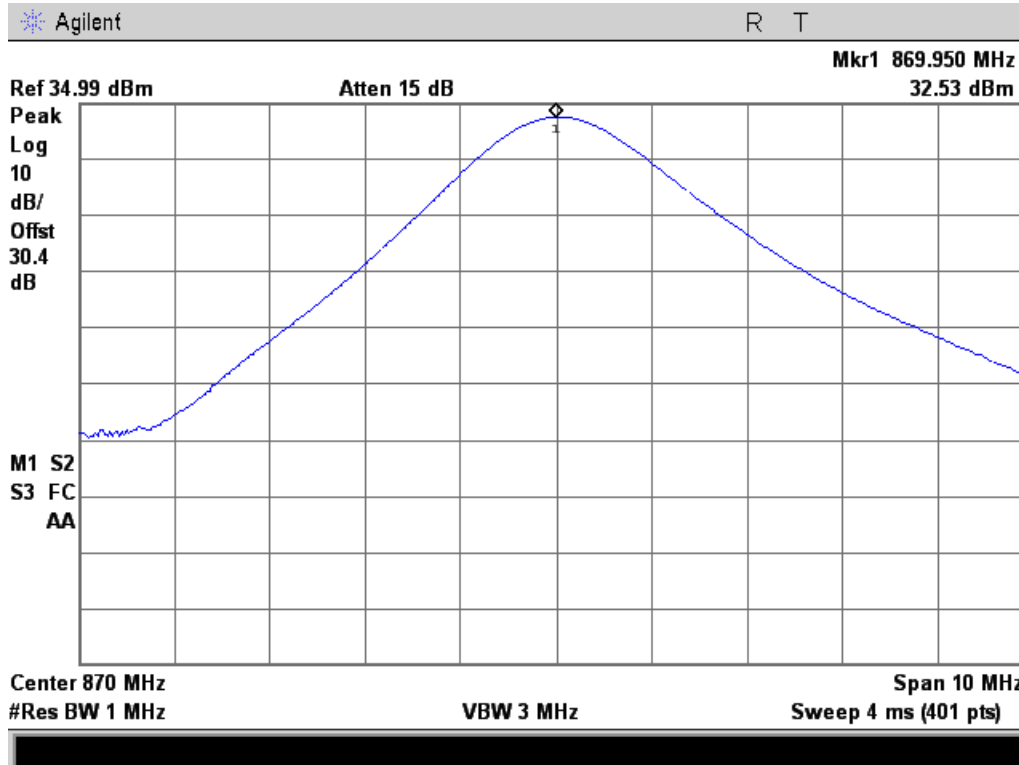

8K10F1D

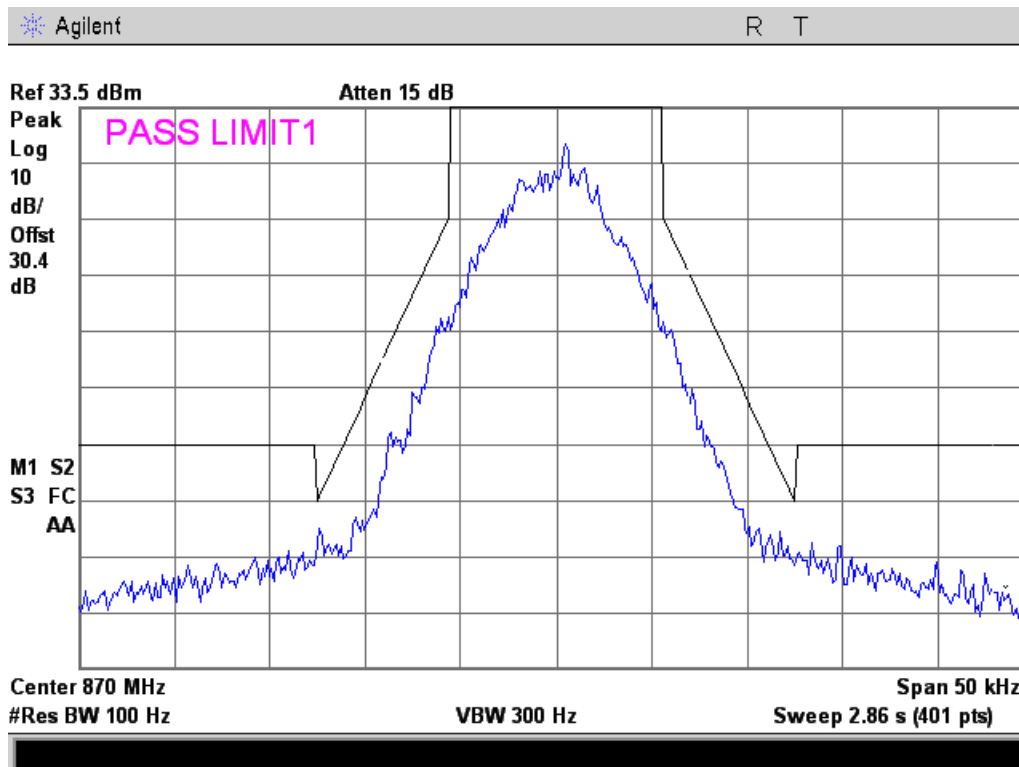



11K0F3E

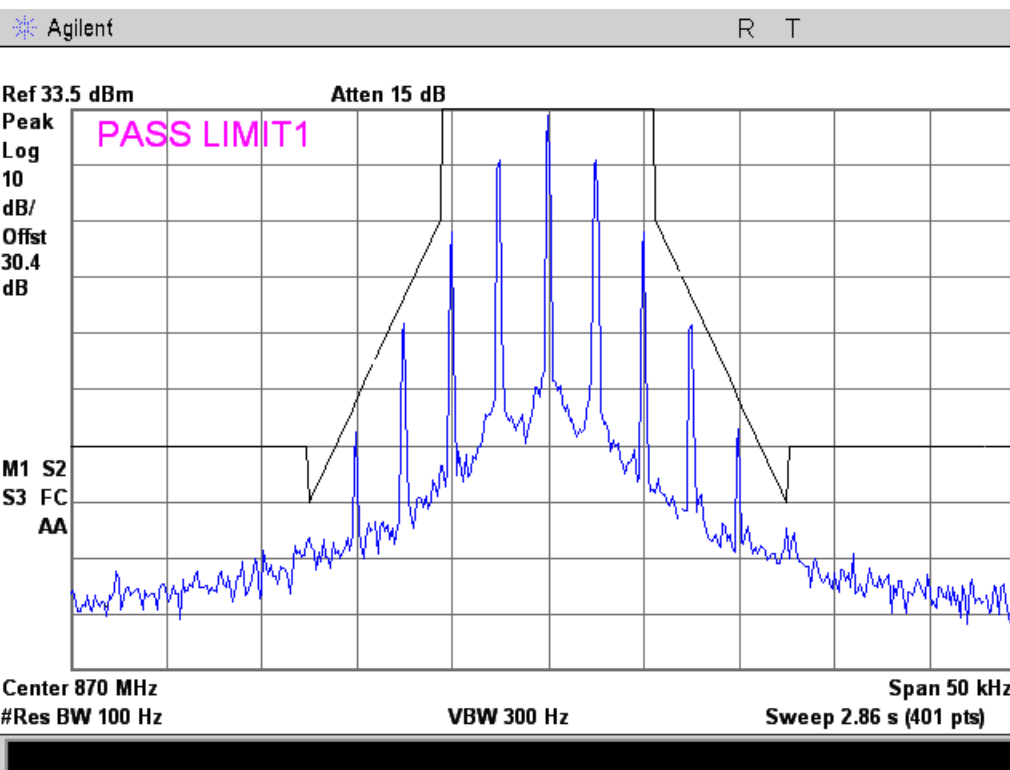

16K0F3E

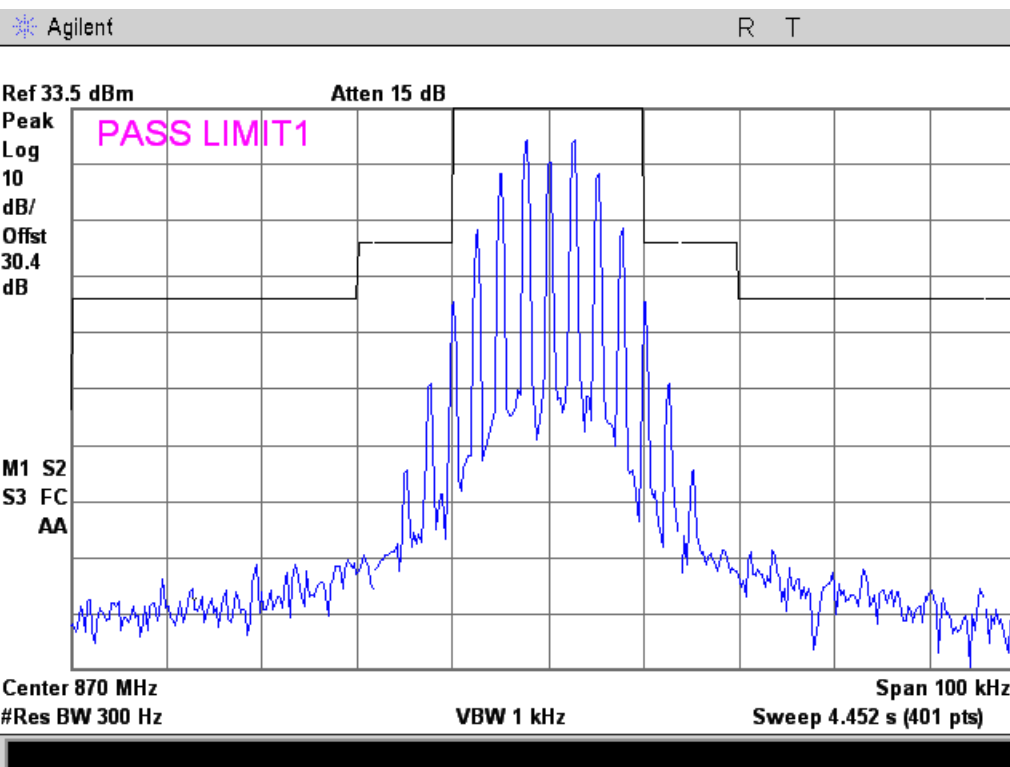



Transient Frequency Behavior

Name of Test: Transient Frequency Behavior

Engineer: John Erhard

Test Equipment Utilized: i00345, i00118

Test Date: 11/28/2012

Test Procedure

The EUT was connected to a modulation analyzer through a 30 dB power attenuator to verify that the EUT meets the required Transient Frequency Behavior response per the specification. The modulation analyzer is a real time spectrum analyzer with integrated demodulation, audio measurement capabilities, and timing analysis. The turn on and turn off transient timing was measured and recorded. As this parameter is not frequency or band dependent the number of frequencies tested was reduced in comparison to previous tests.

Test Setup

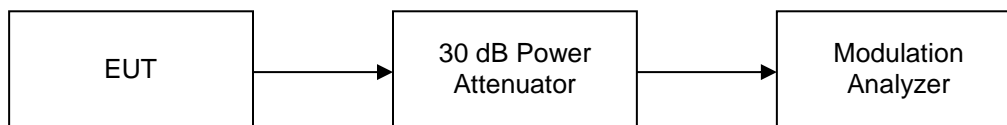



29.7-88 MHz Band

11K0F3E On Time

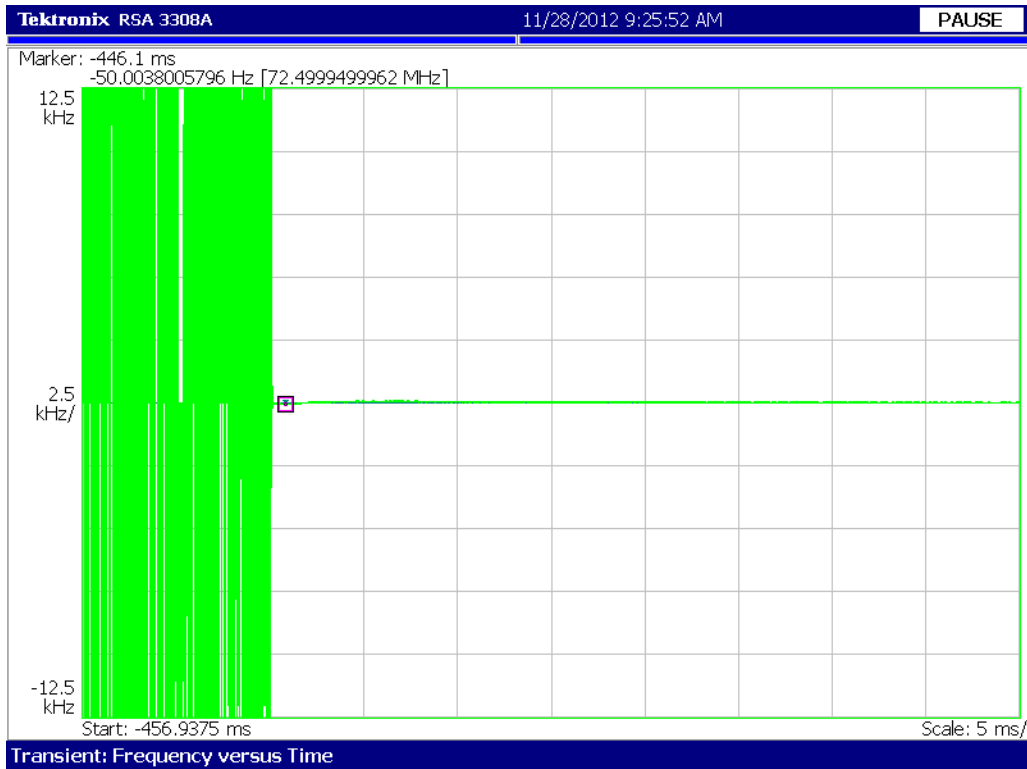

11K0F3E Off Time

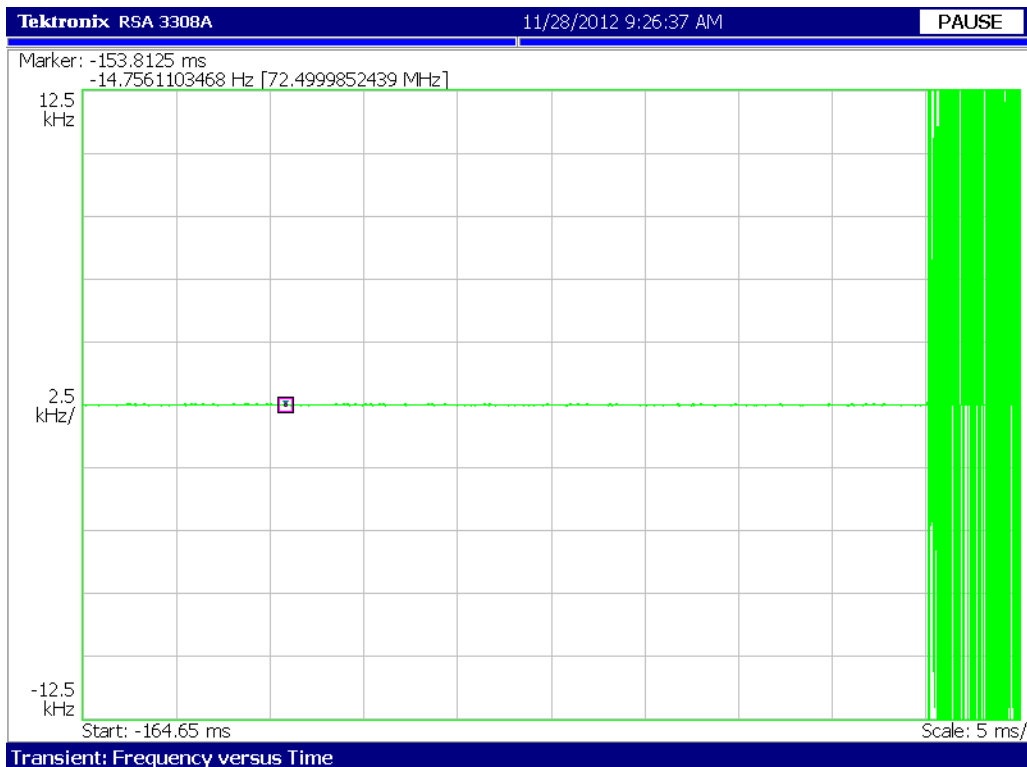



16K0F3E On Time

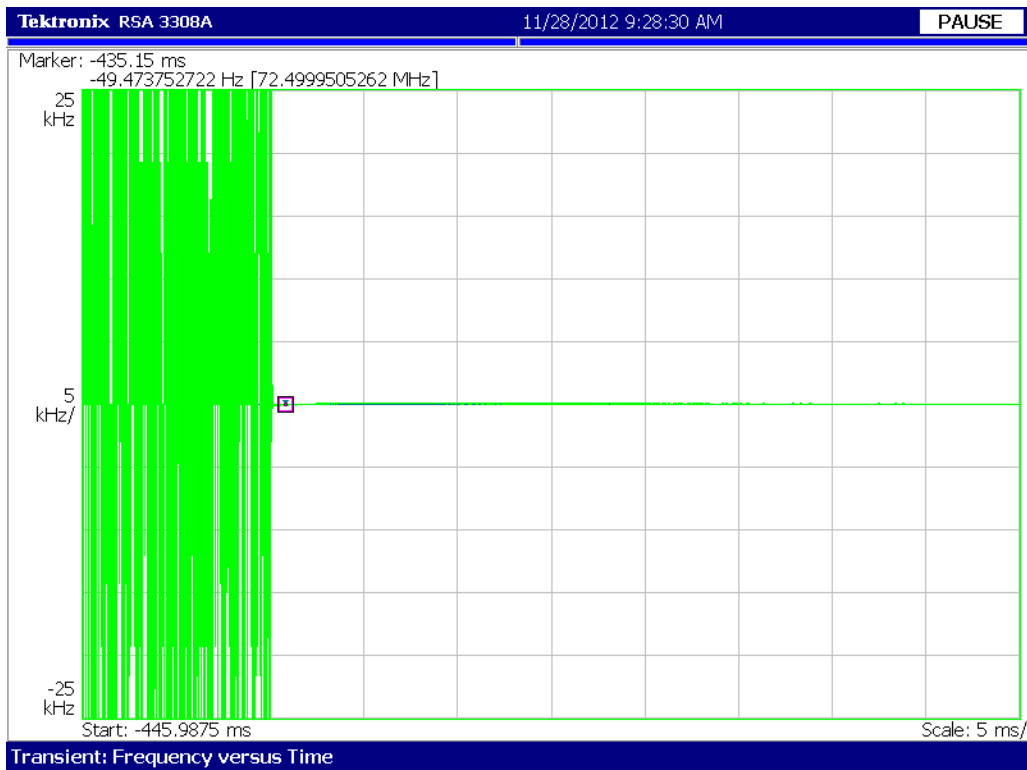

16K0F3E Off Time

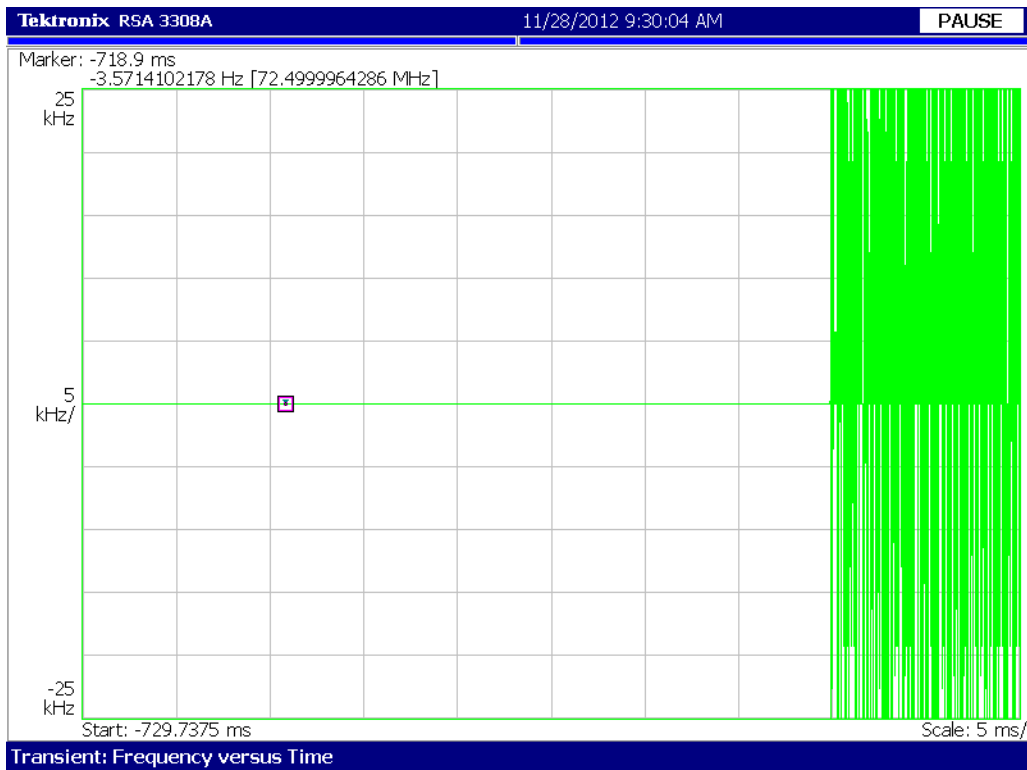



136-174 MHz Band

11K0F3E On Time

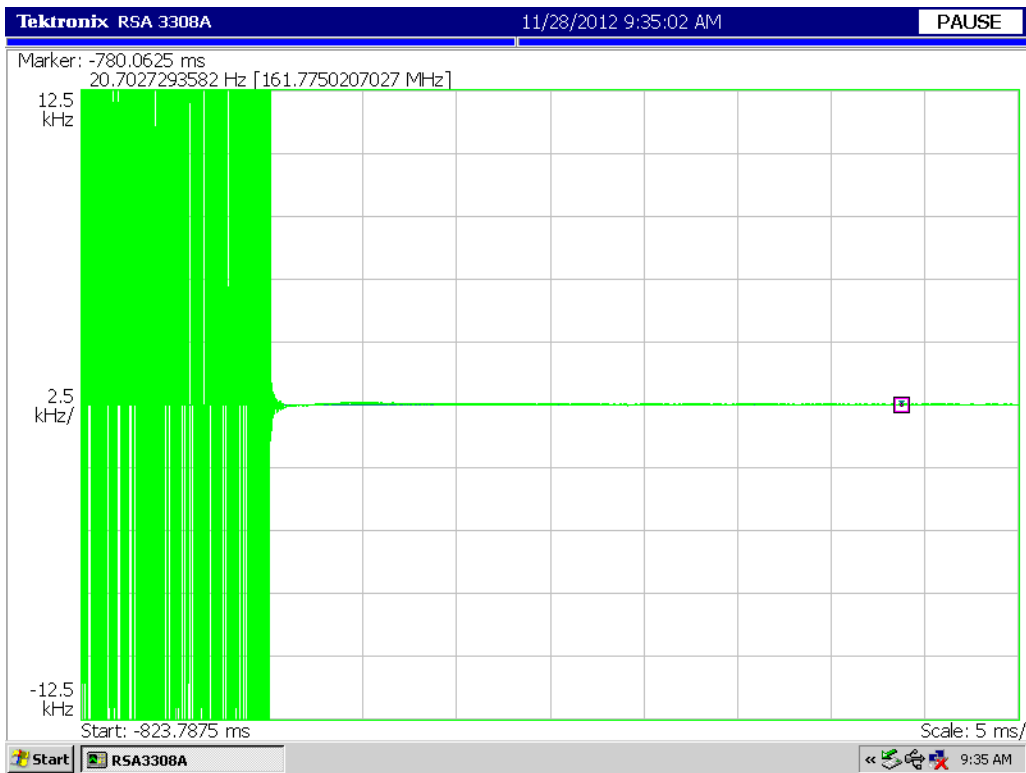

11K0F3E Off Time

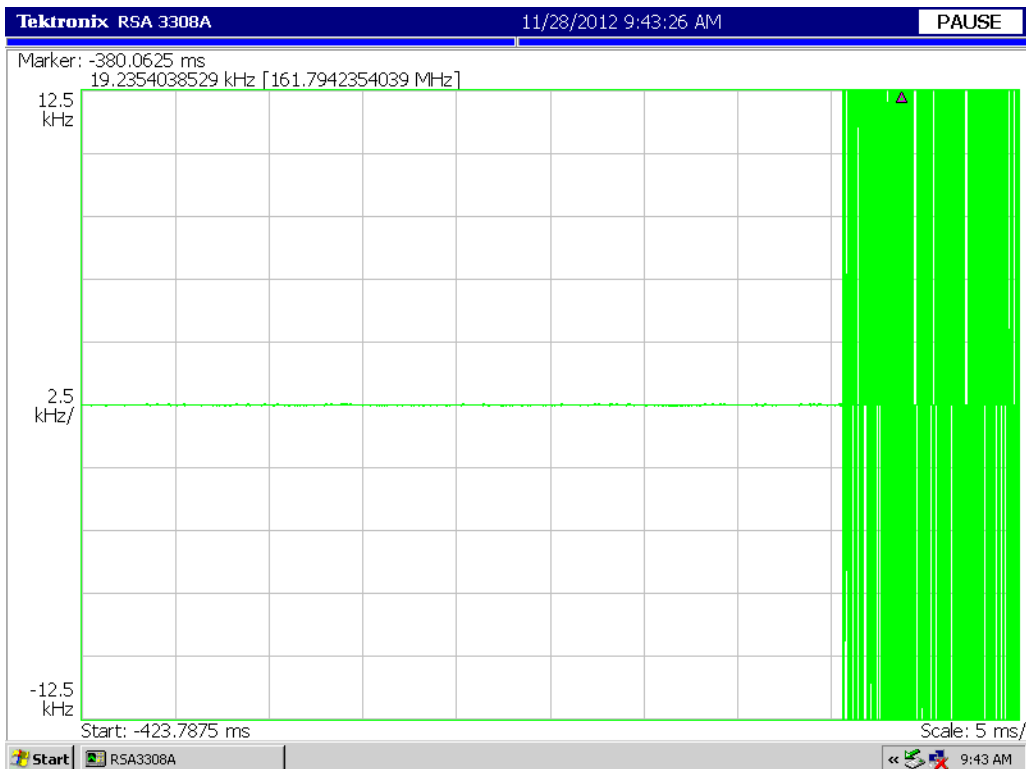



16K0F3E On Time

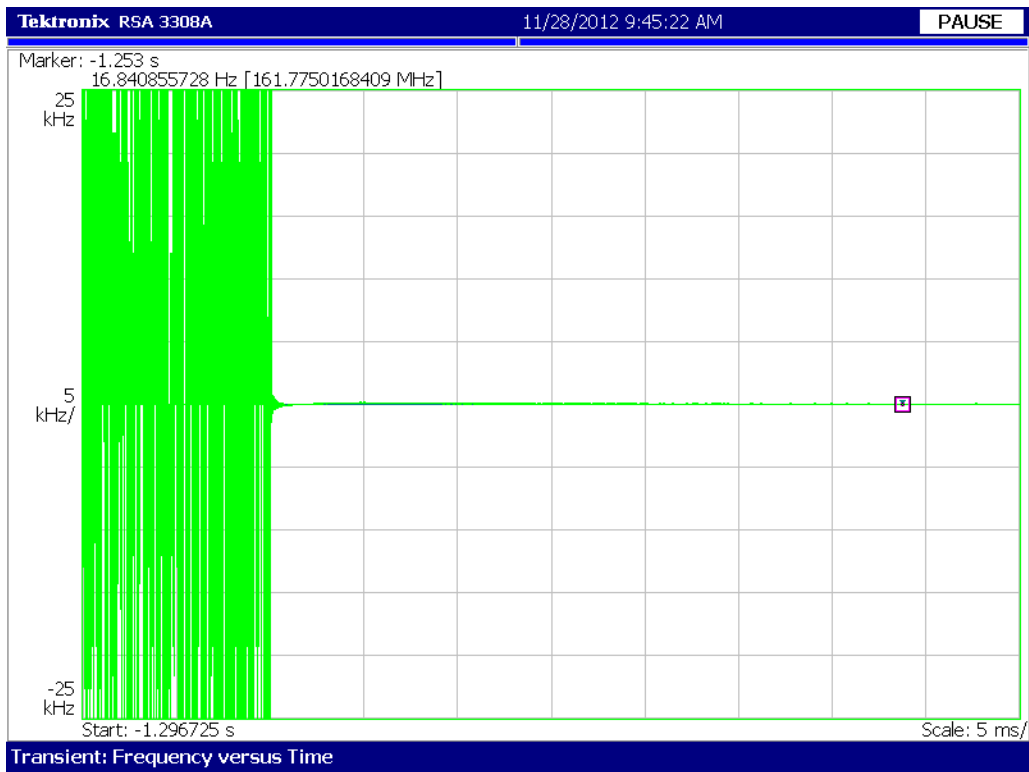

16K0F3E Off Time

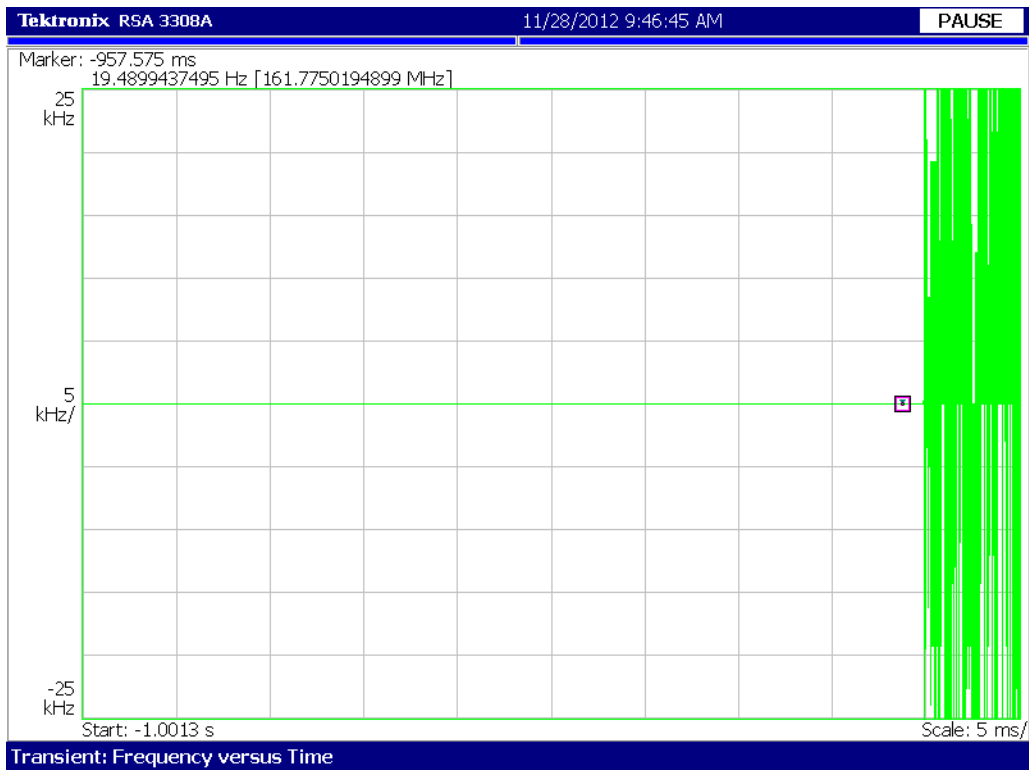



380-520 MHz Band

11K0F3E On Time

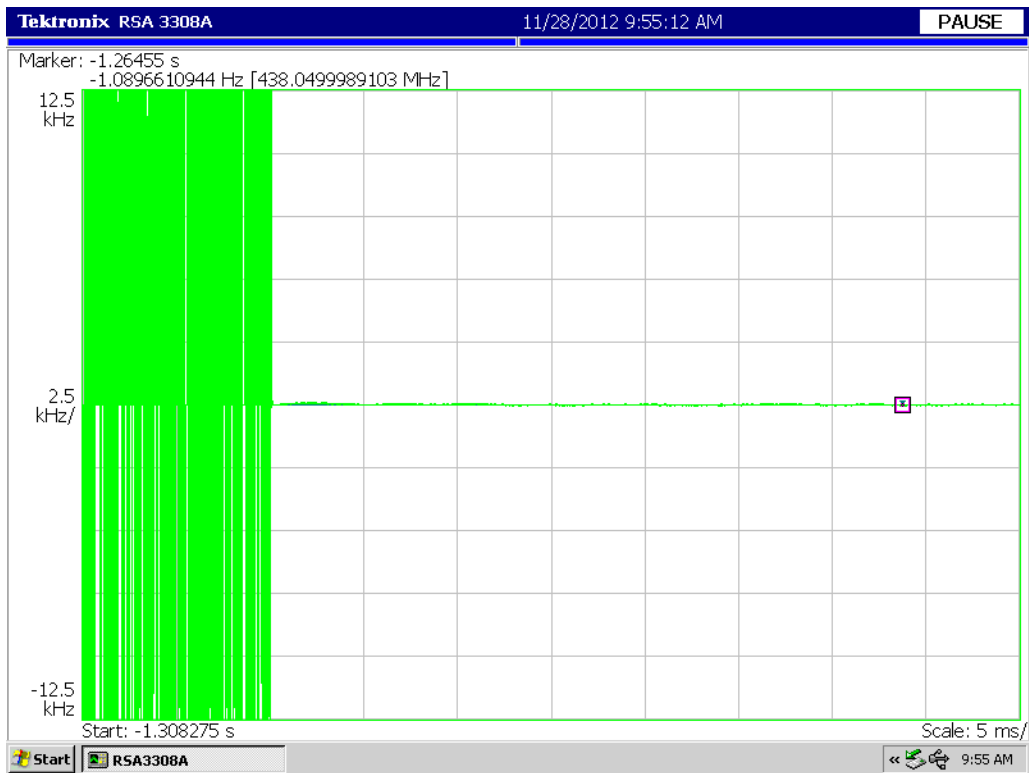

11K0F3E Off Time

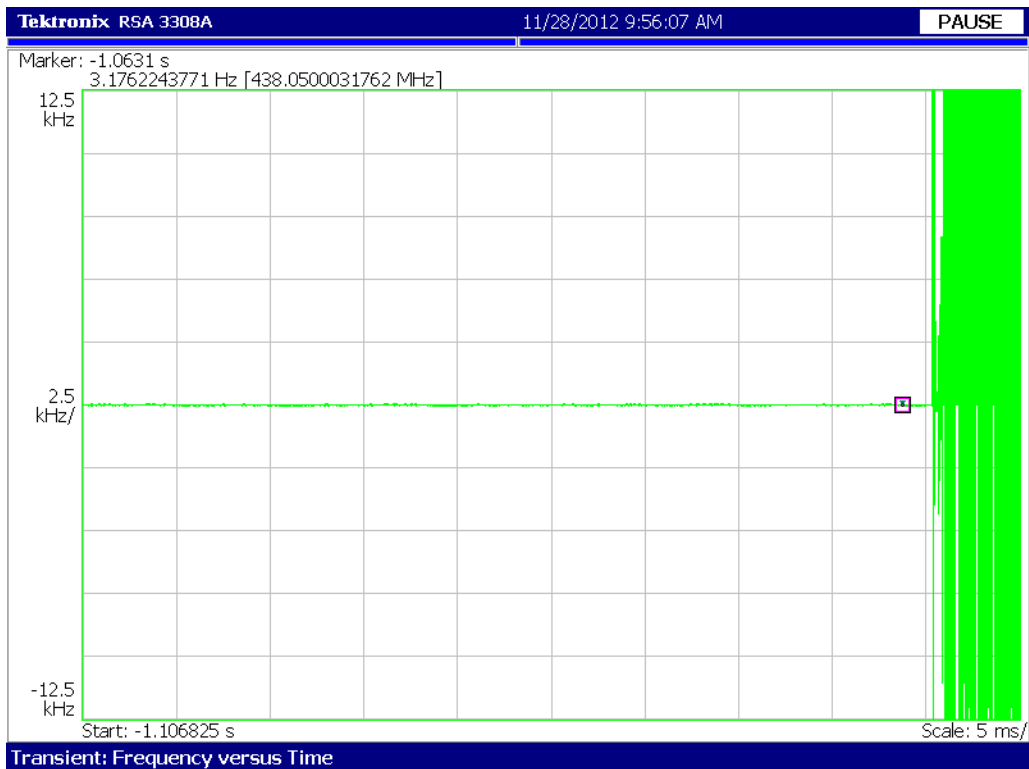



16K0F3E On Time

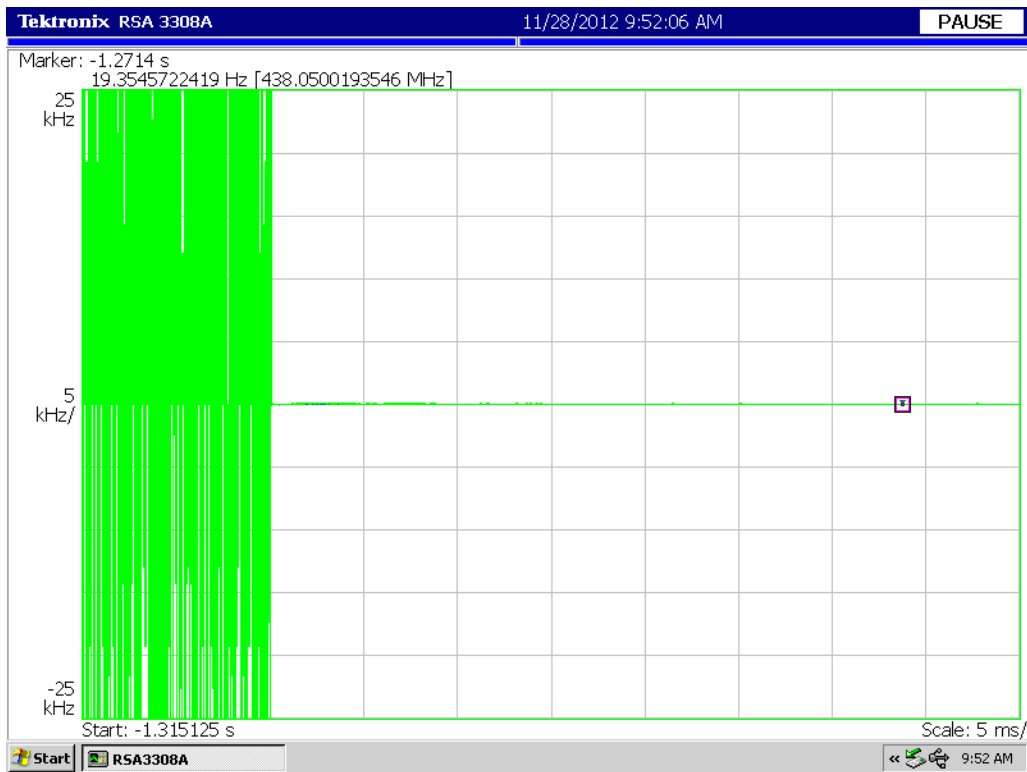

16K0F3E Off Time





MTM 136-174 MHz Band

11K0F3E On Time

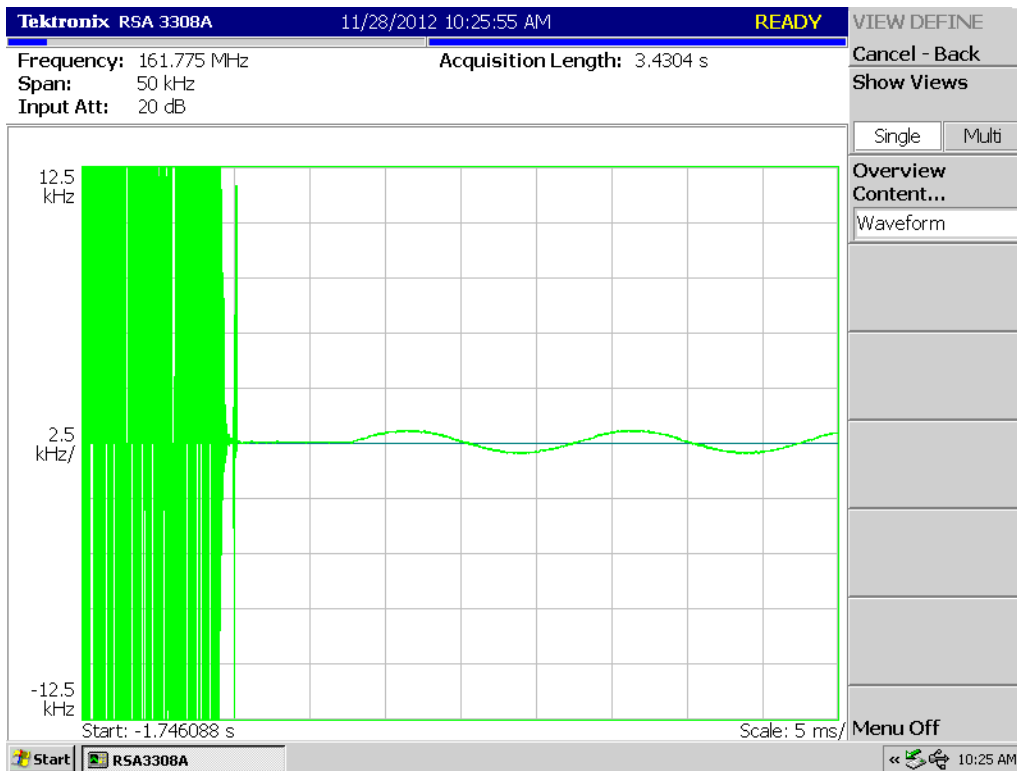

11K0F3E Off Time

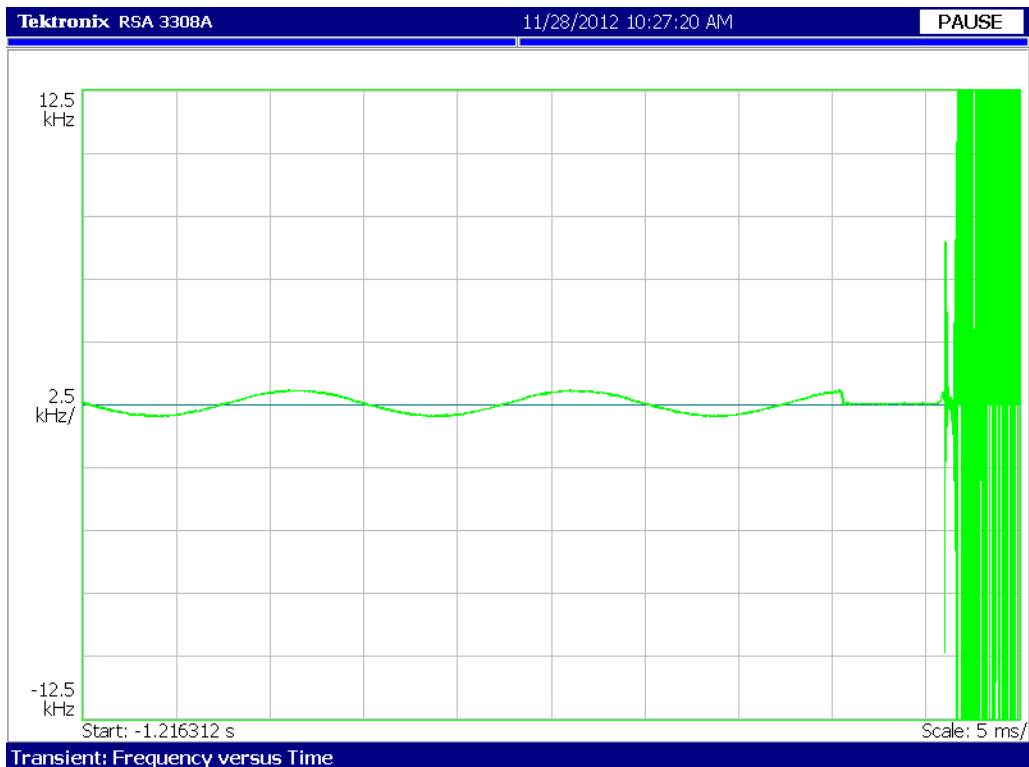



16K0F3E On Time

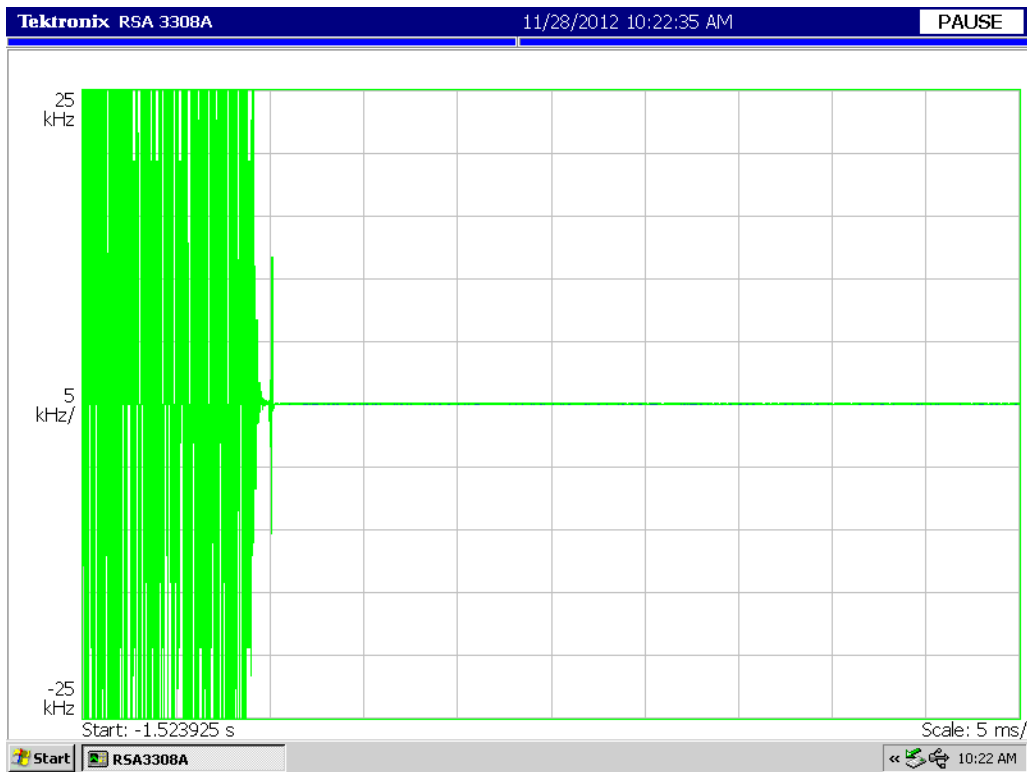

16K0F3E Off Time

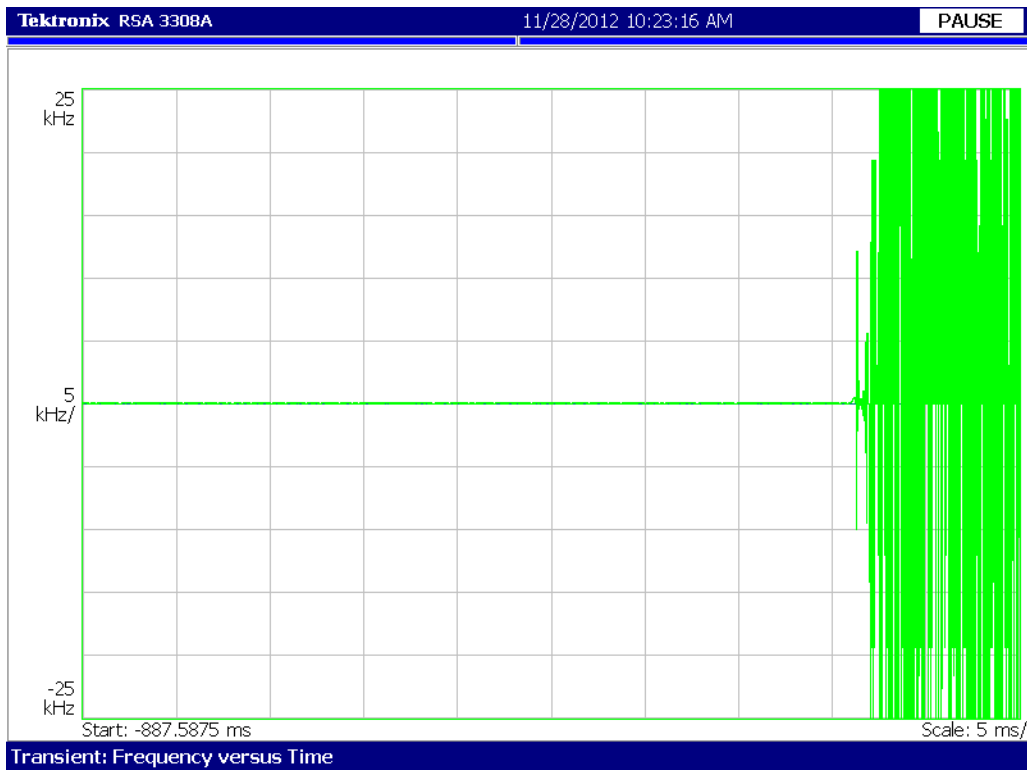



MTM 380-470 MHz Band

11K0F3E On Time

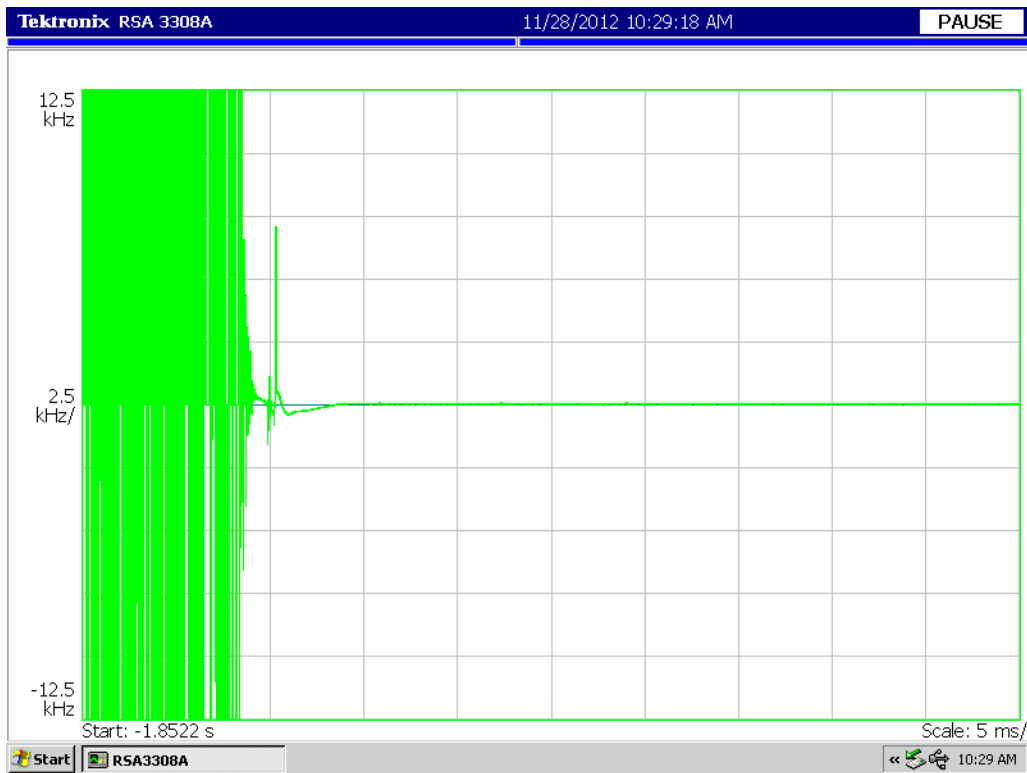

11K0F3E Off Time

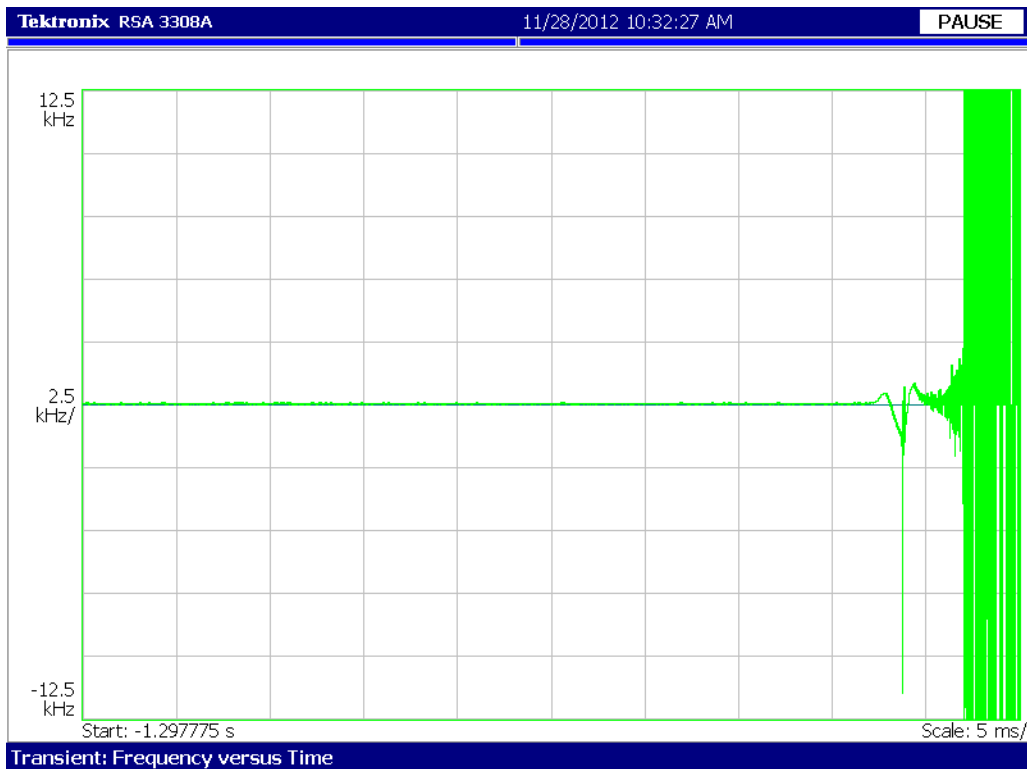



16K0F3E On Time

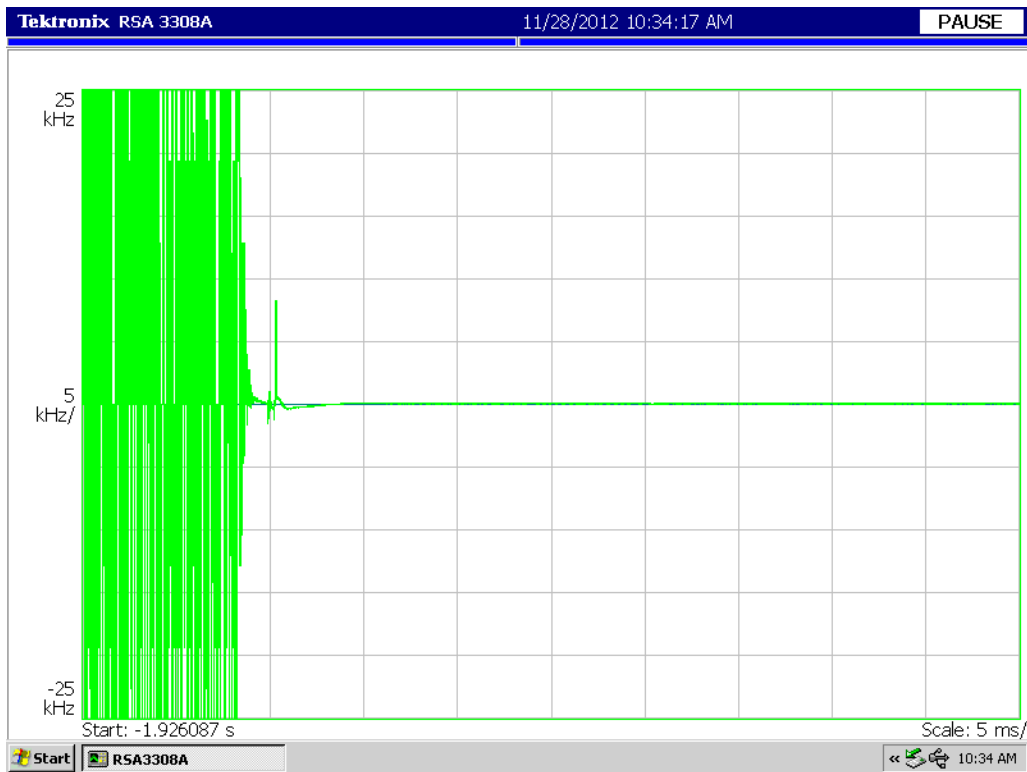

16K0F3E Off Time

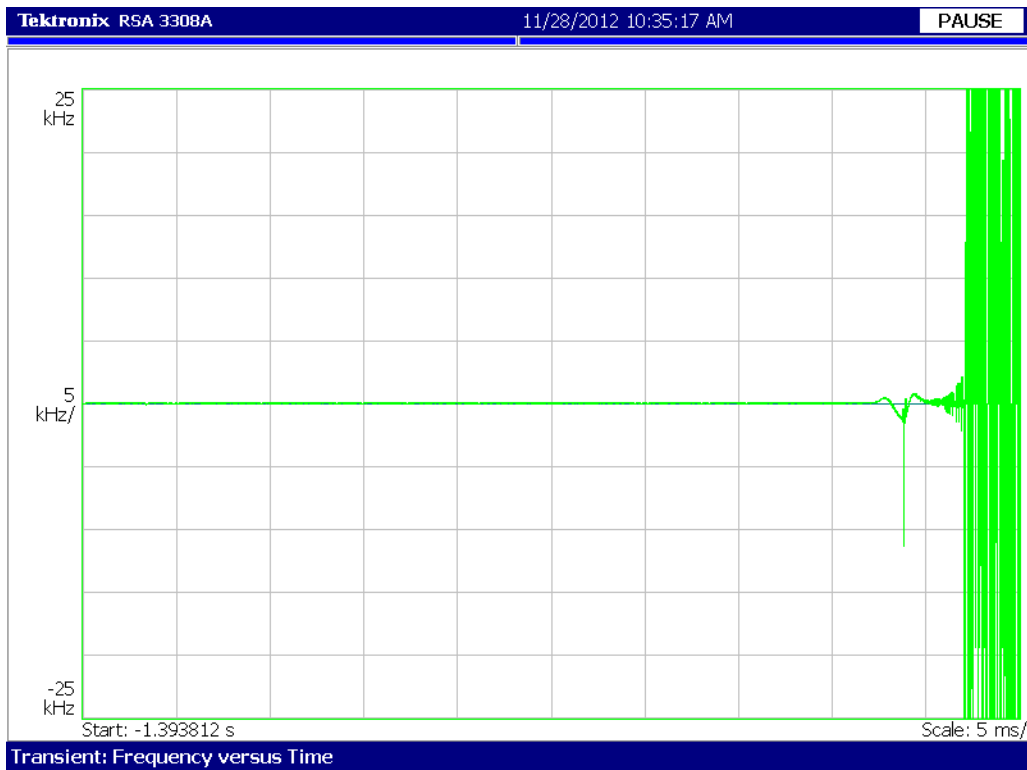



MTM 450-520 MHz Band

11K0F3E On Time

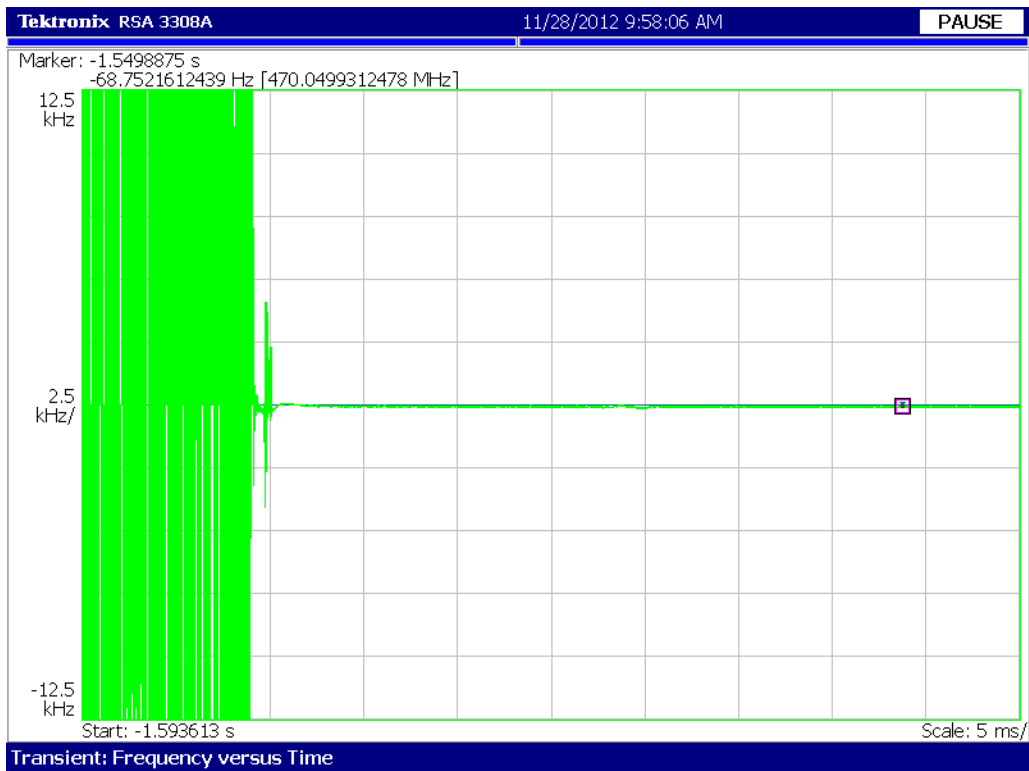

11K0F3E Off Time

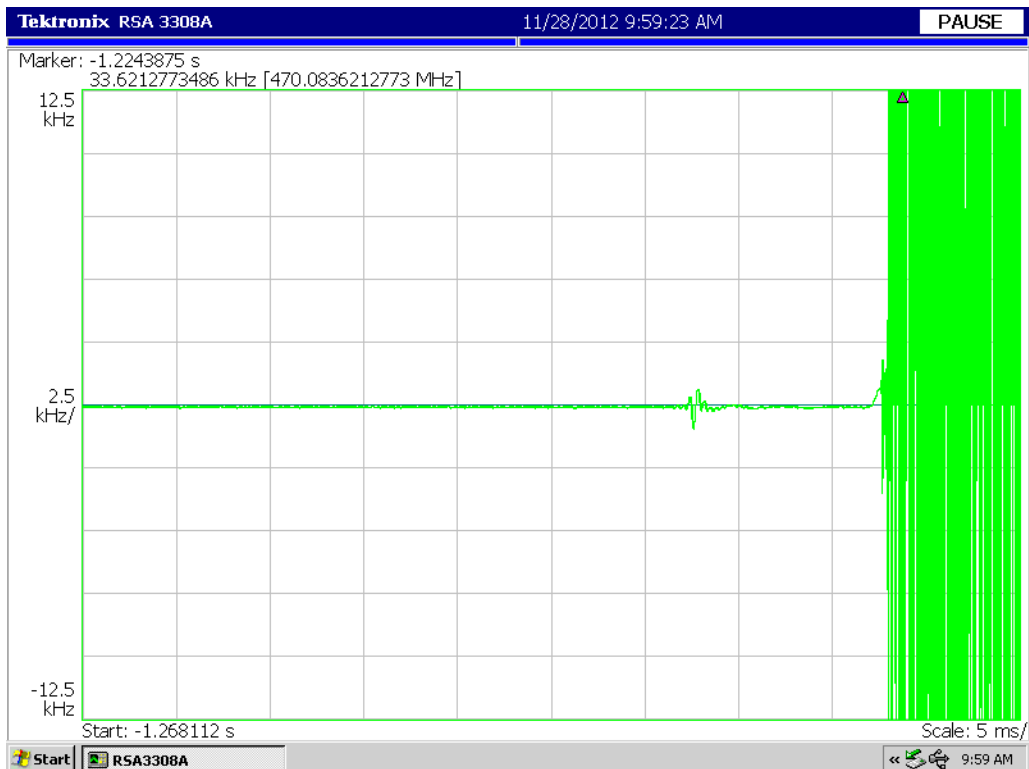



16K0F3E On Time

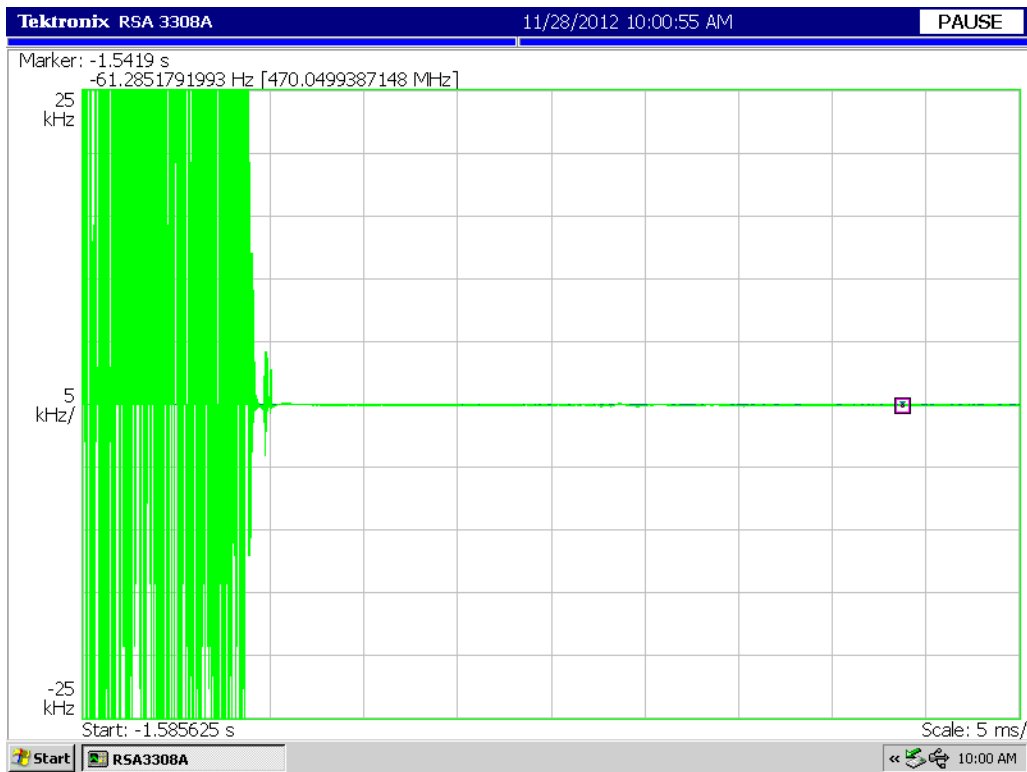

16K0F3E Off Time

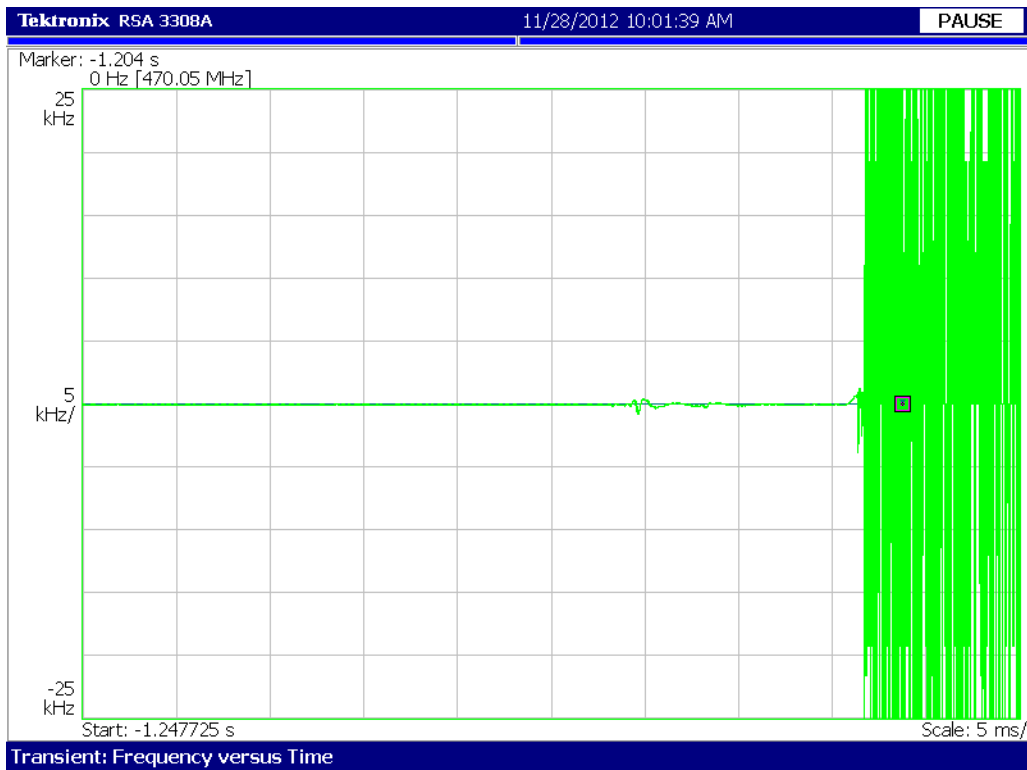



Audio Low Pass Filter (Voice Input)

Name of Test: Audio Low Pass Filter (Voice Input)

Engineer: John Erhard

Test Equipment Utilized: i00345, i00118

Test Date: 11/27/2012

Test Procedure

The EUT was connected to a modulation analyzer through a 30 dB power attenuator. The audio source was tuned across the required audio frequency range and the audio low pass filter response was measured and plotted. The modulation analyzer is a real time spectrum analyzer with integrated demodulation, audio measurement capabilities, and timing analysis. As this parameter is not frequency or band dependent the number of frequencies tested was reduced in comparison to previous tests

Test Setup

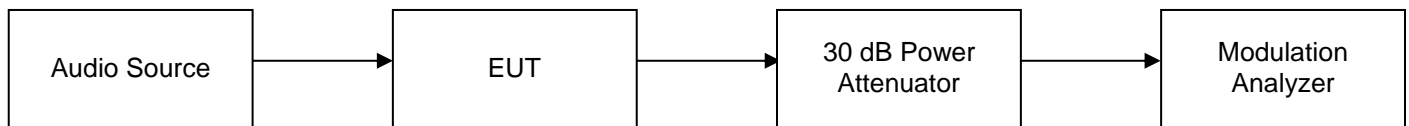



29.7-88 MHz Band

11K0F3E

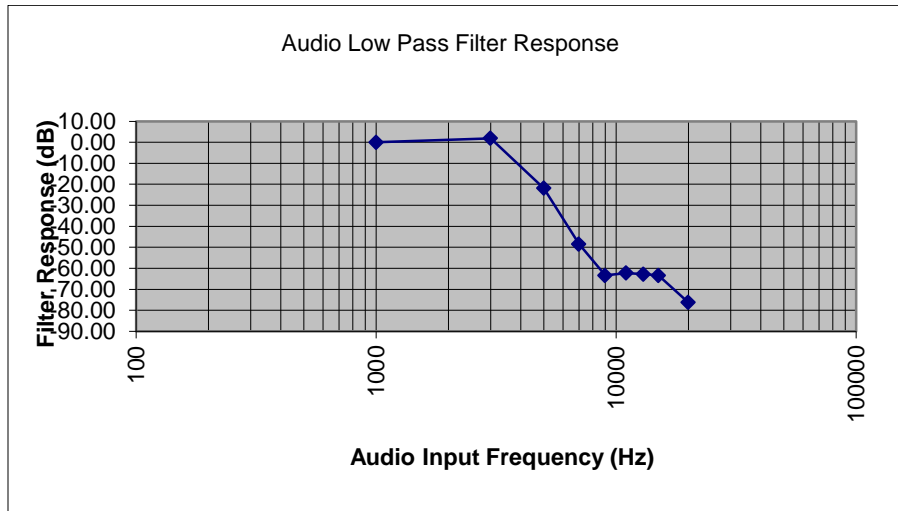

16K0F3E

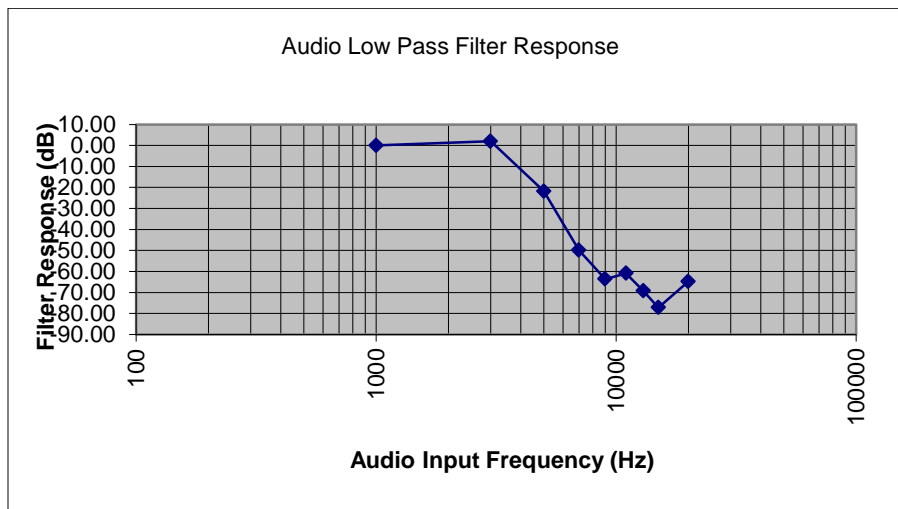



136-174 MHz Band

11K0F3E

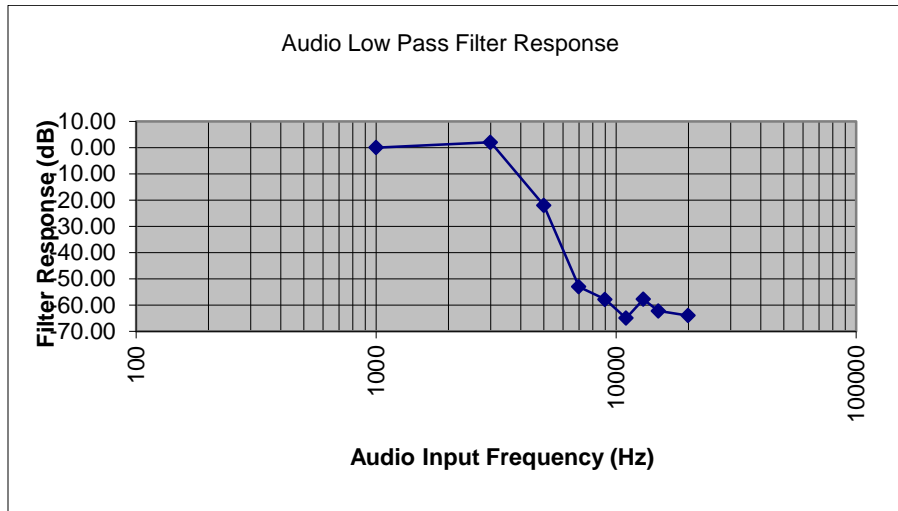

16K0F3E

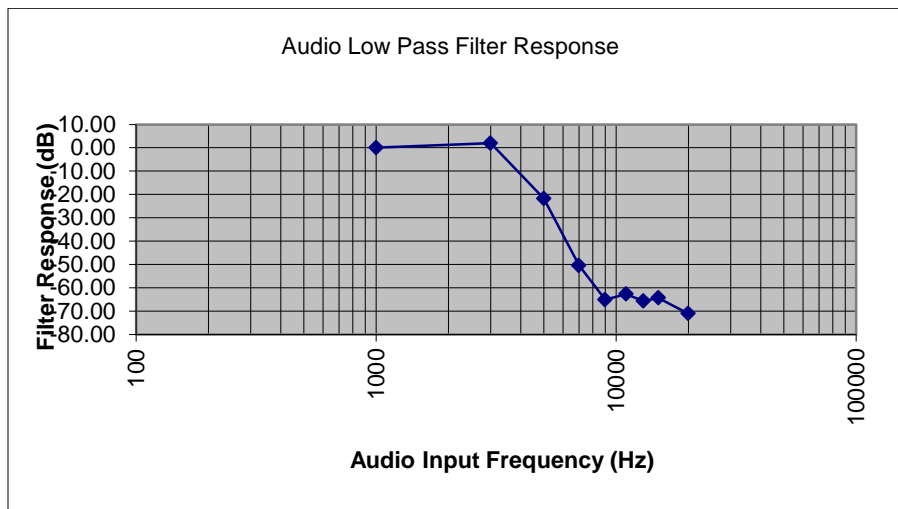



380-520 MHz Band

6K00A3E

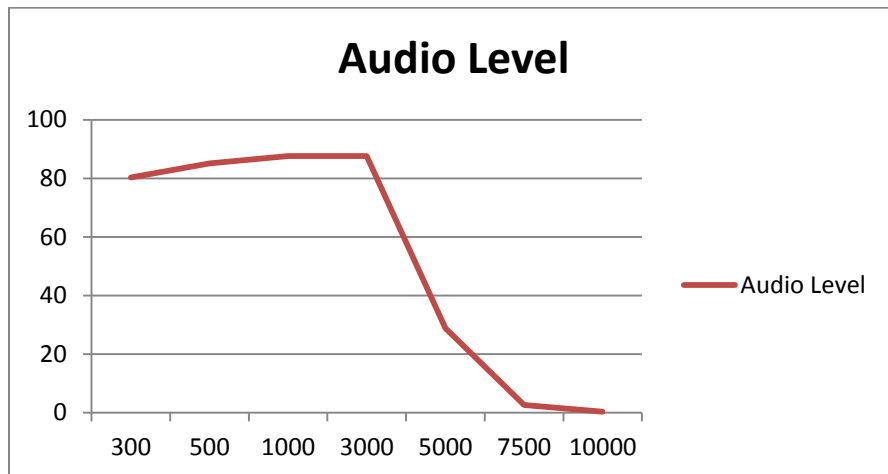

11K0F3E

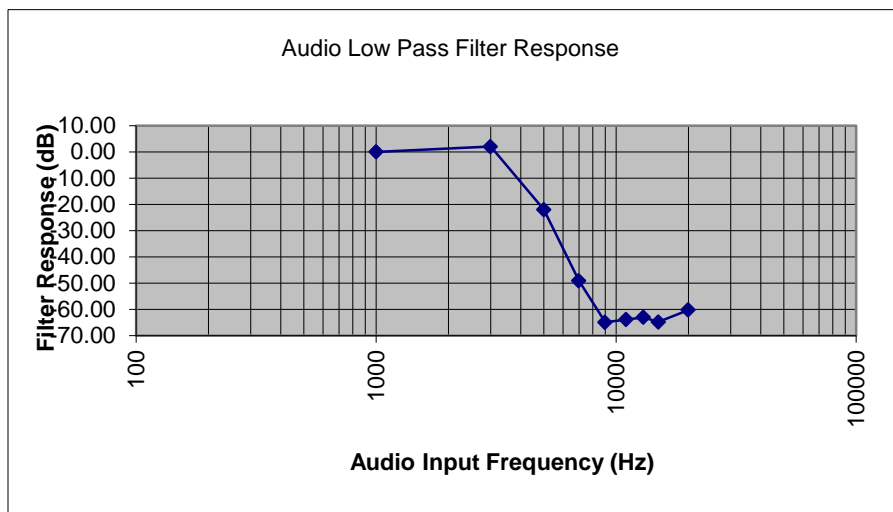

16K0F3E

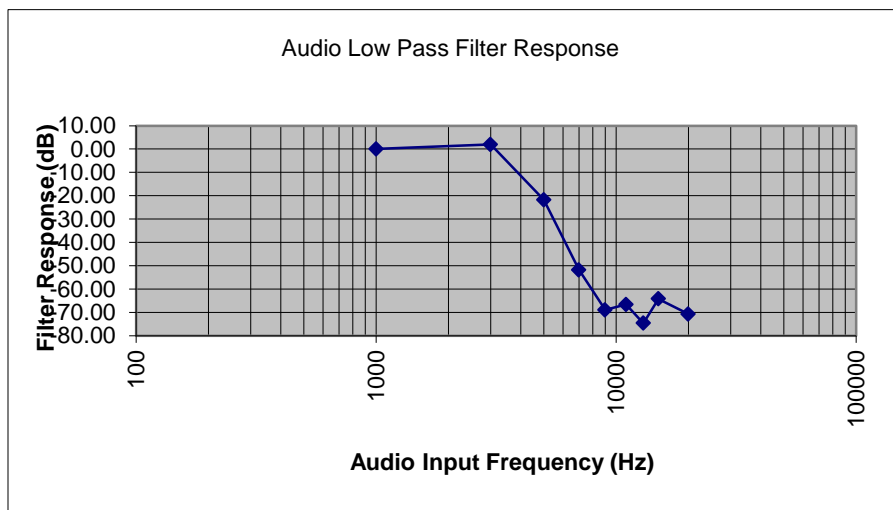



764-806 MHz Band

11K0F3E

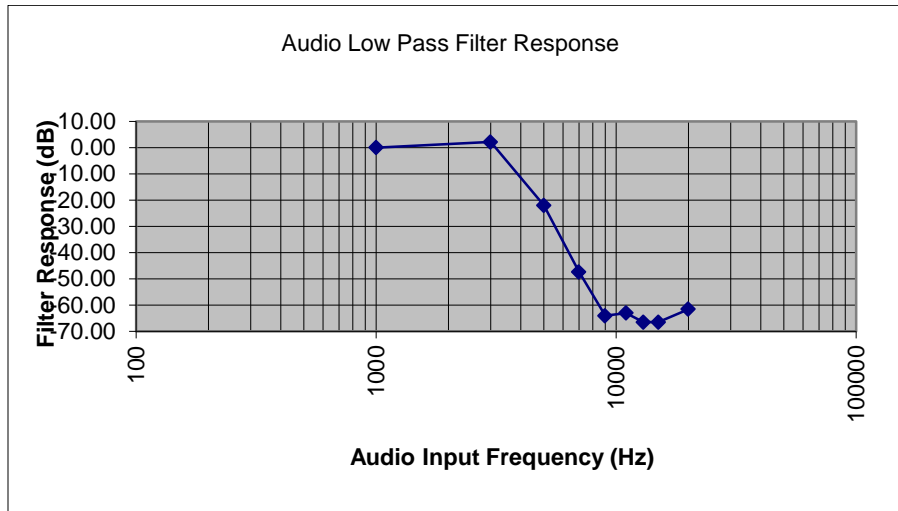

16K0F3E

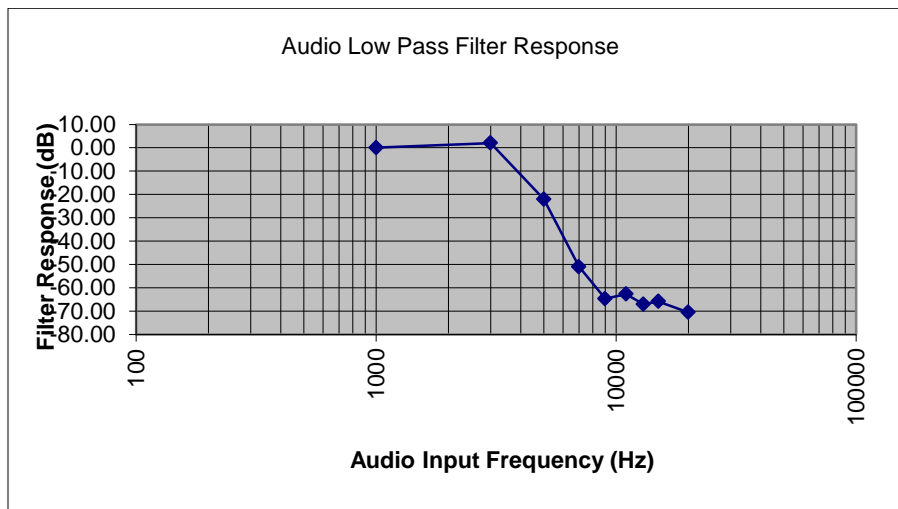



806-960 MHz Band (multiple frequencies tested)

827.05 MHz

11K0F3E

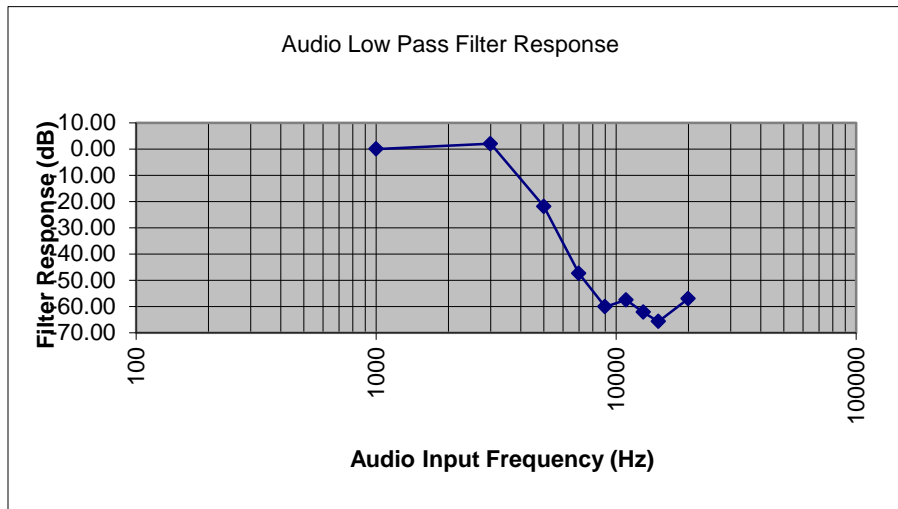

16K0F3E

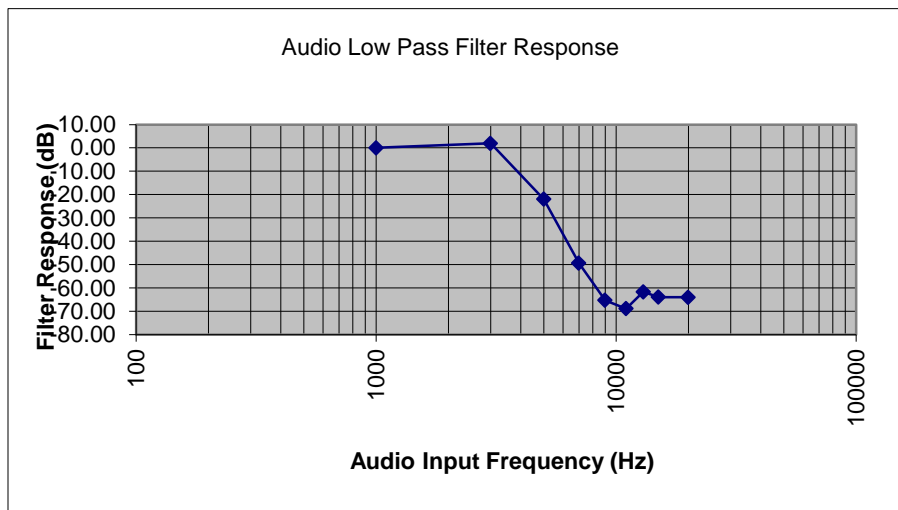



896.05 MHz

11K0F3E

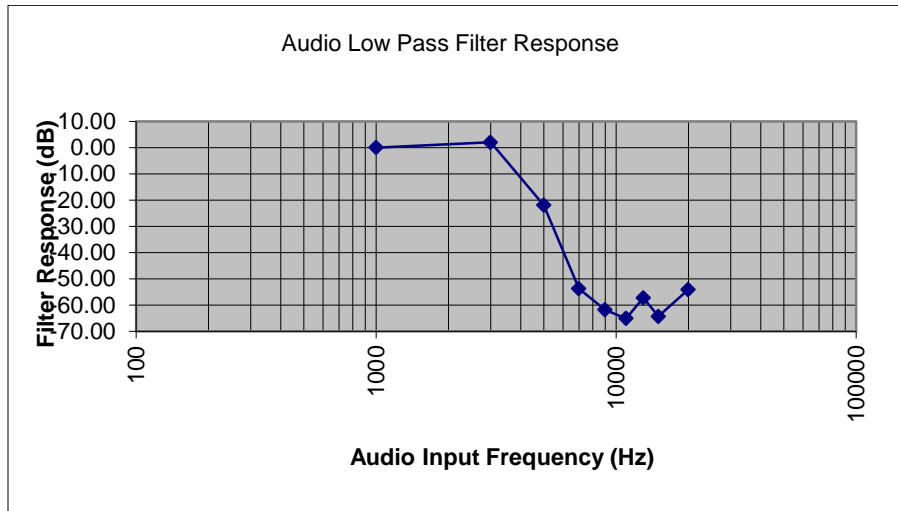

16K0F3E

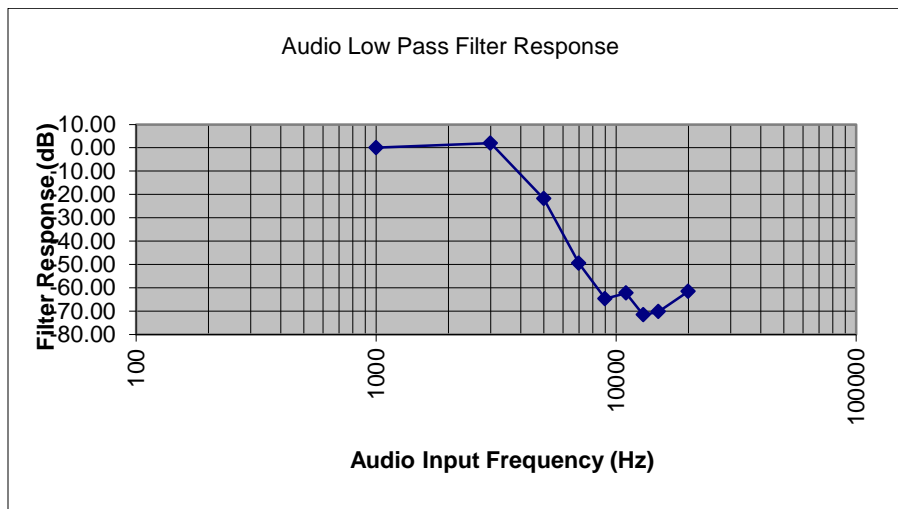



939.95 MHz

11K0F3E

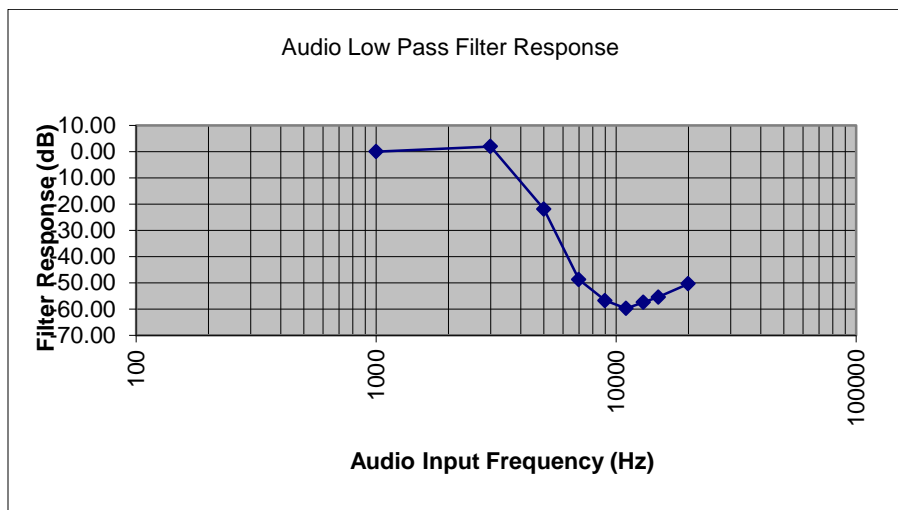

16K0F3E

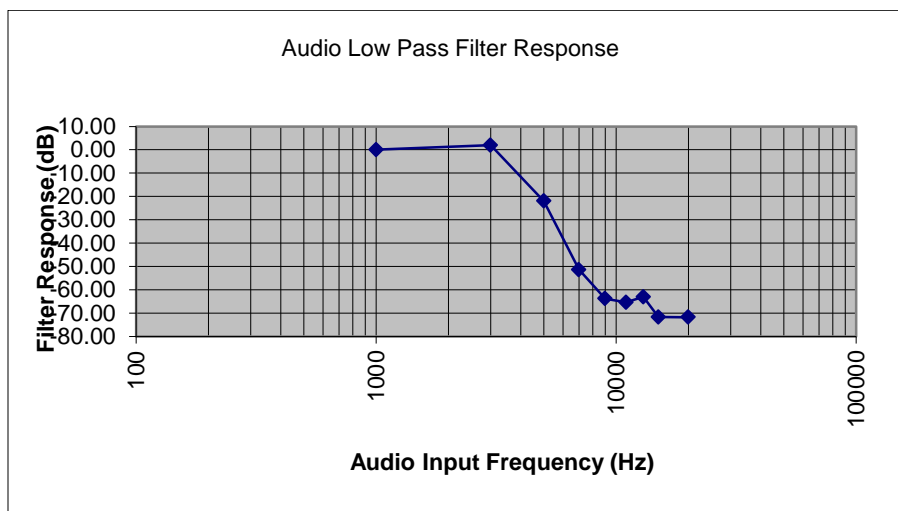



MTM 136-174 MHz Band

11K0F3E

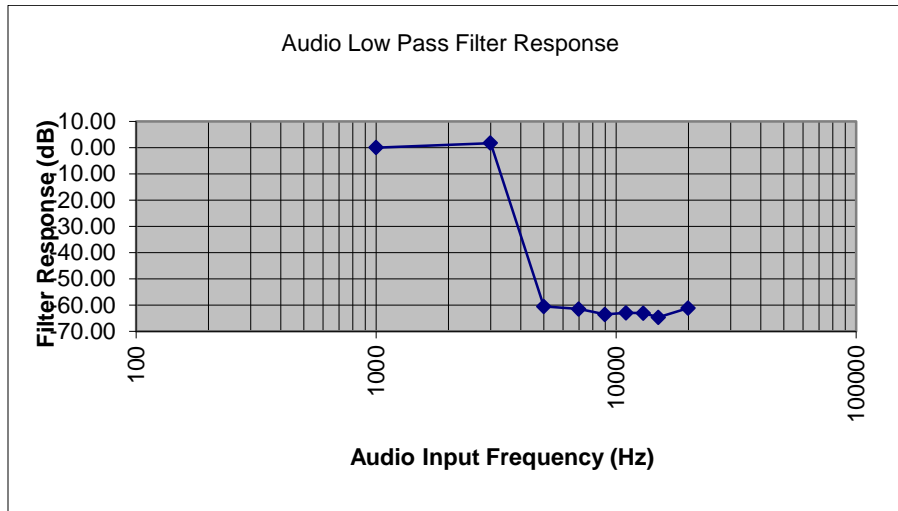

16K0F3E

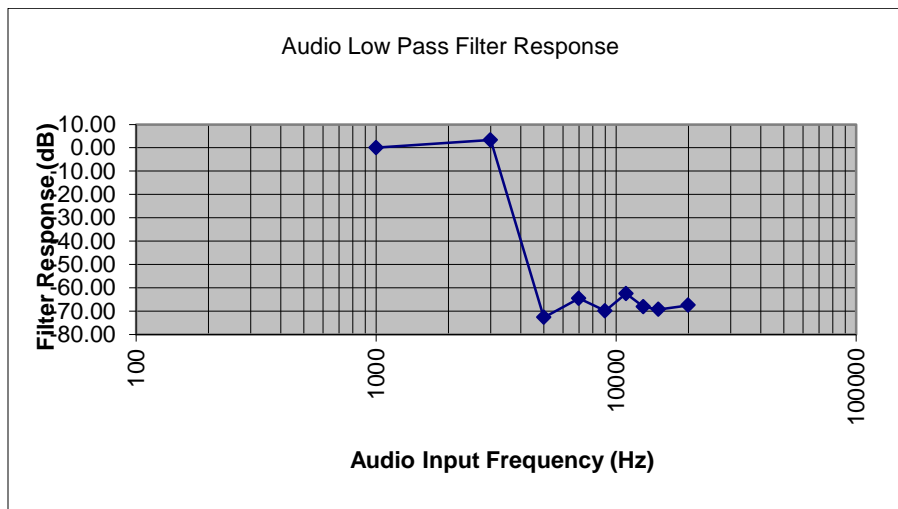



MTM 380-470 MHz Band

11K0F3E

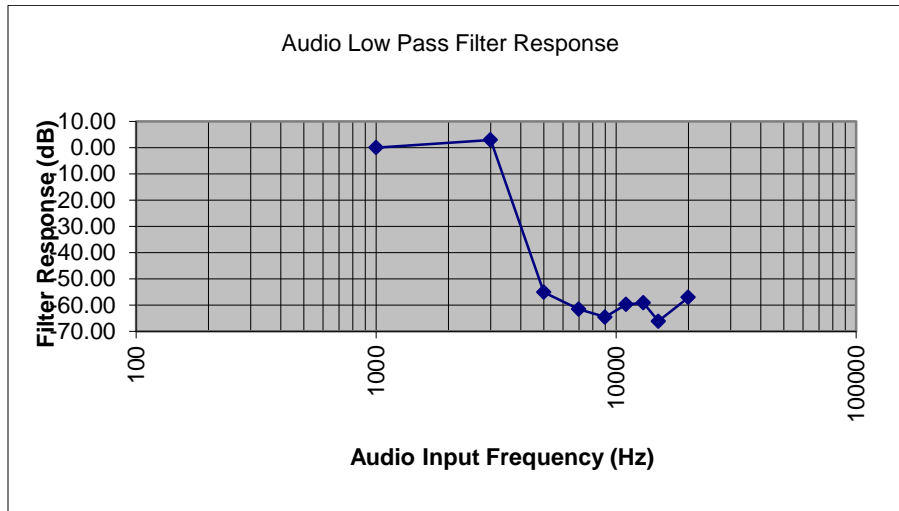

16K0F3E

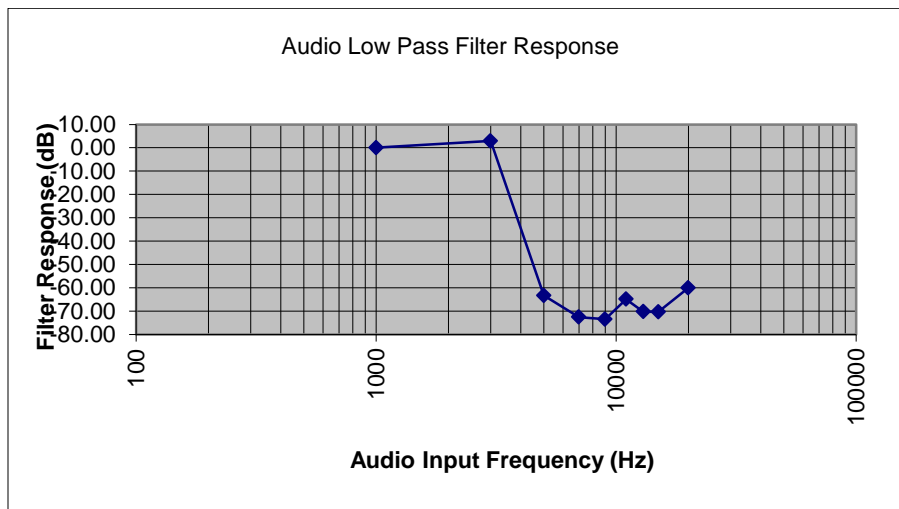



MTM 450-520 MHz Band

11K0F3E

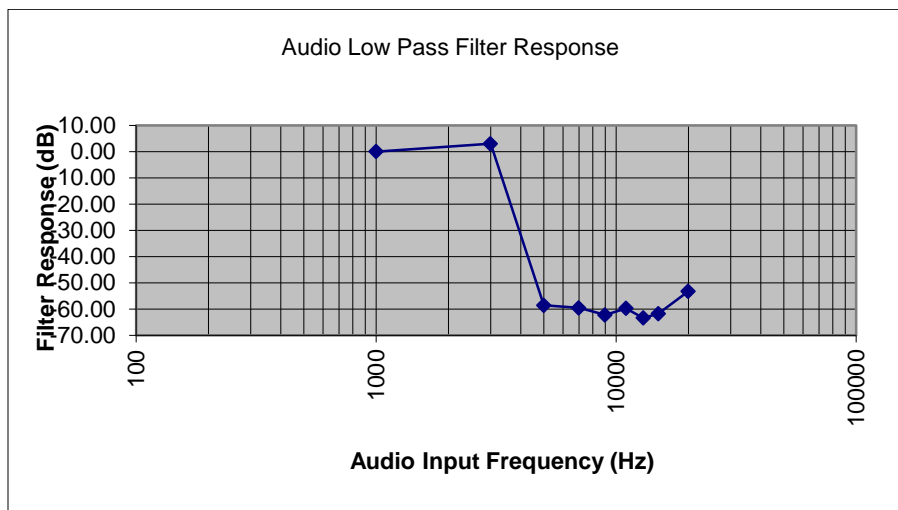

16K0F3E

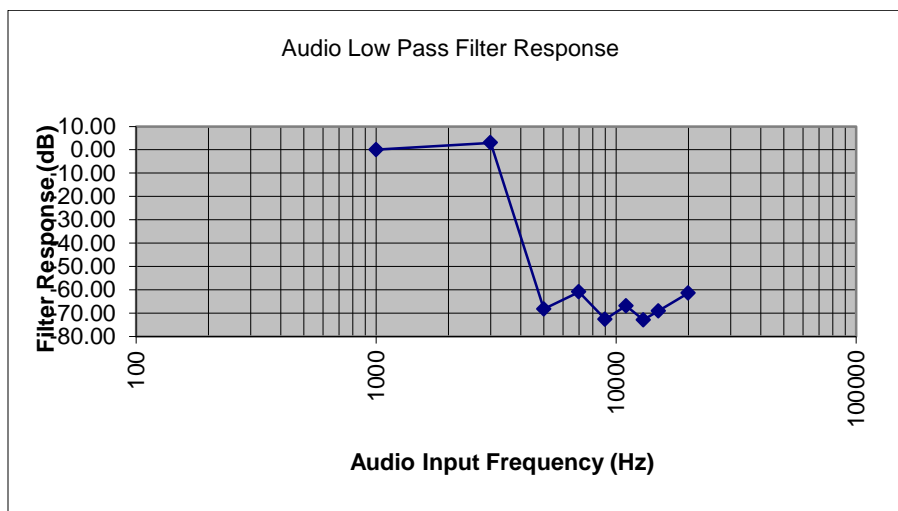



MTM 764-870 MHz Band

11K0F3E

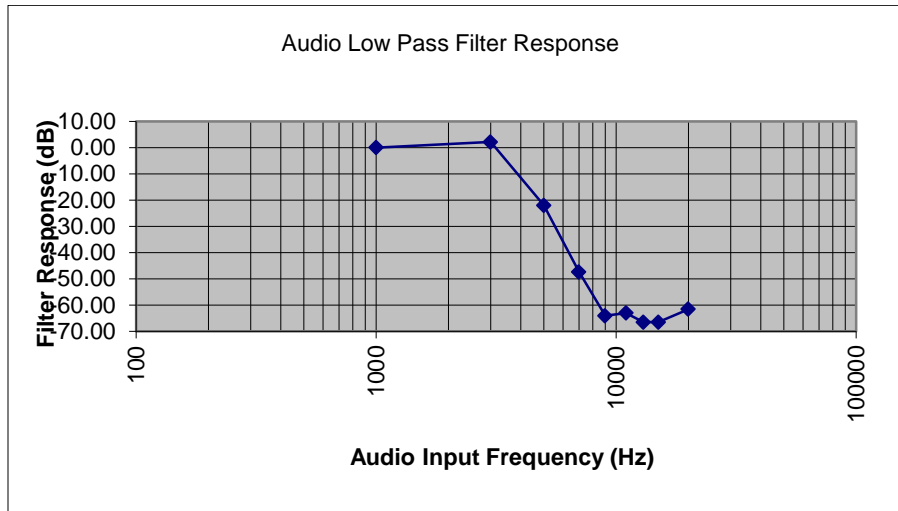

16K0F3E

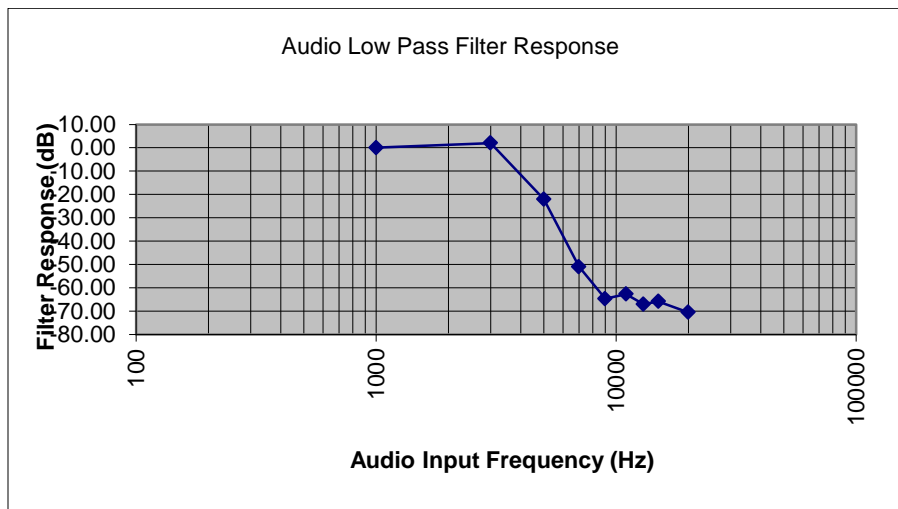



Audio Frequency Response

Name of Tests: Audio Frequency Response

Engineer: John Erhard

Test Equipment Utilized: i00345, i00118

Test Date: 11/27/2012

Measurement Procedure

The EUT was connected directly to a modulation analyzer through an attenuator. The audio source was tuned across the required audio frequency range and the audio frequency response was measured and plotted. The modulation analyzer is a real time spectrum analyzer with integrated demodulation, audio measurement capabilities, and timing analysis. As this parameter is not frequency or band dependent the number of frequencies tested was reduced in comparison to previous tests

Test Setup

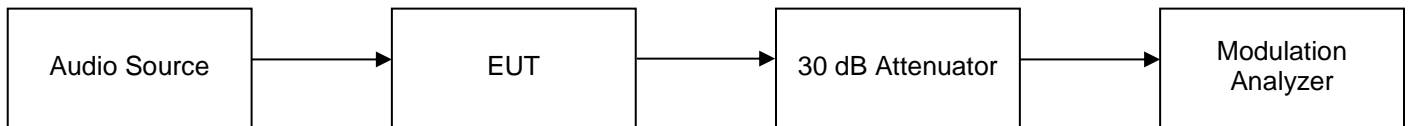



29.7-88 MHz Band

11K0F3E

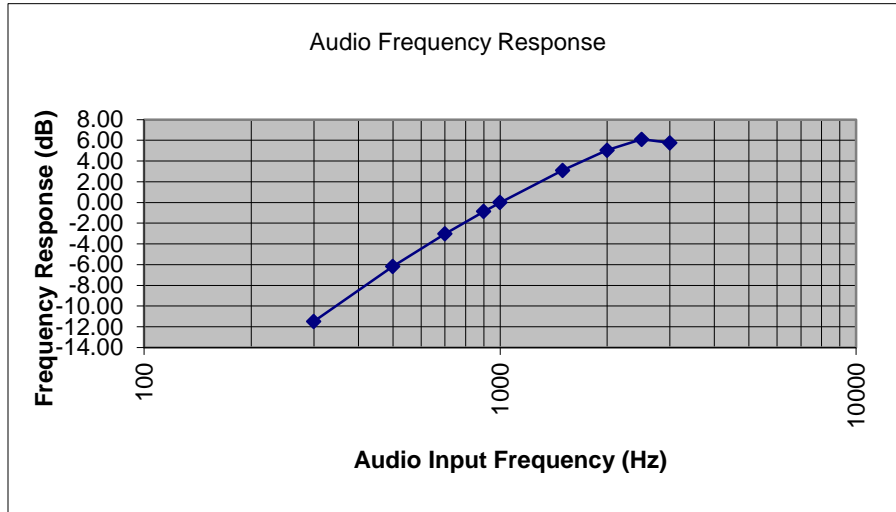

16K0F3E

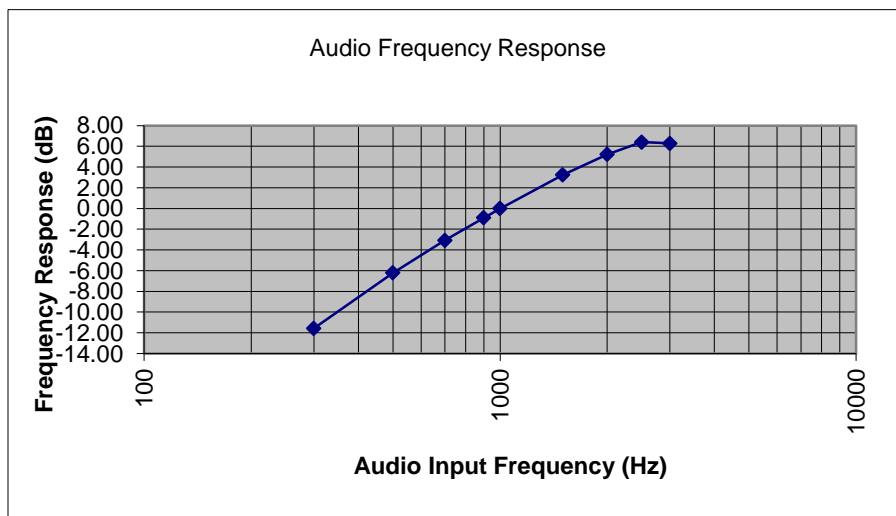



136-174 MHz Band

11K0F3E

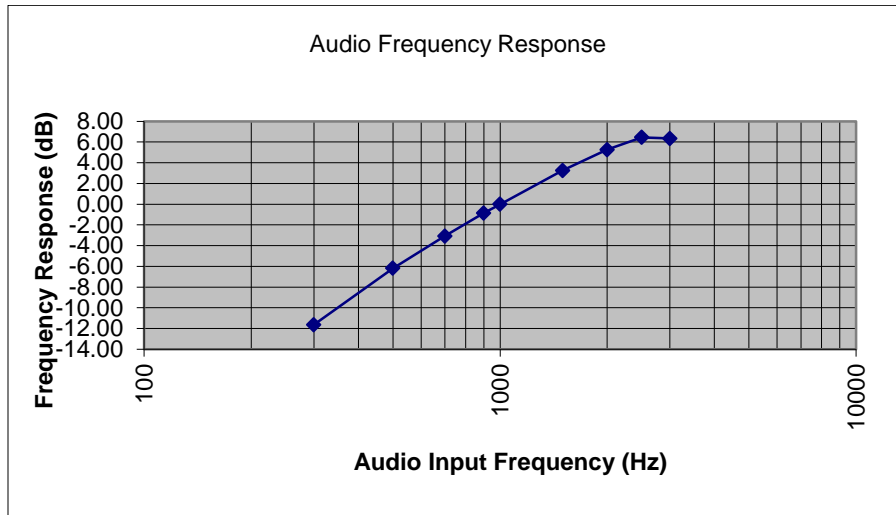

16K0F3E

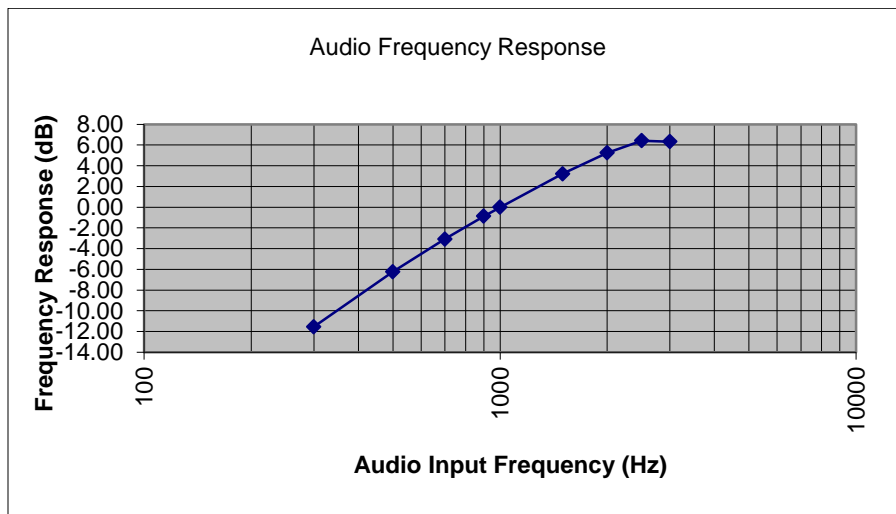



380-520 MHz Band

6K00A3E

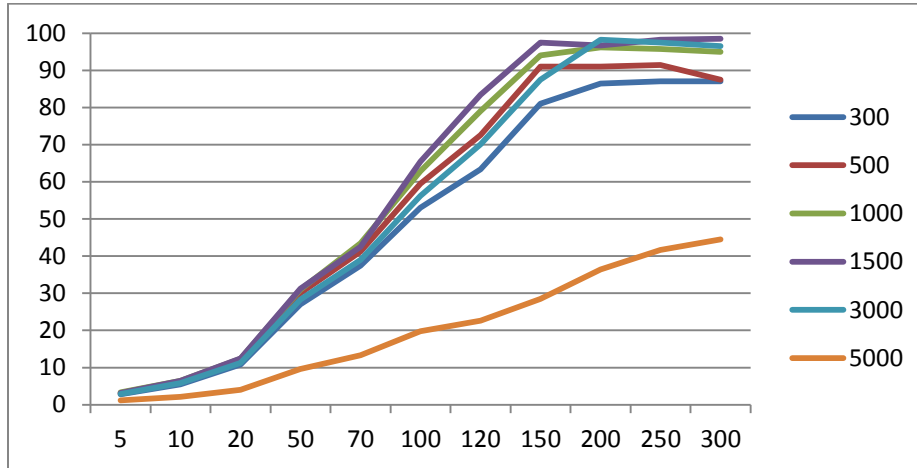

11K0F3E

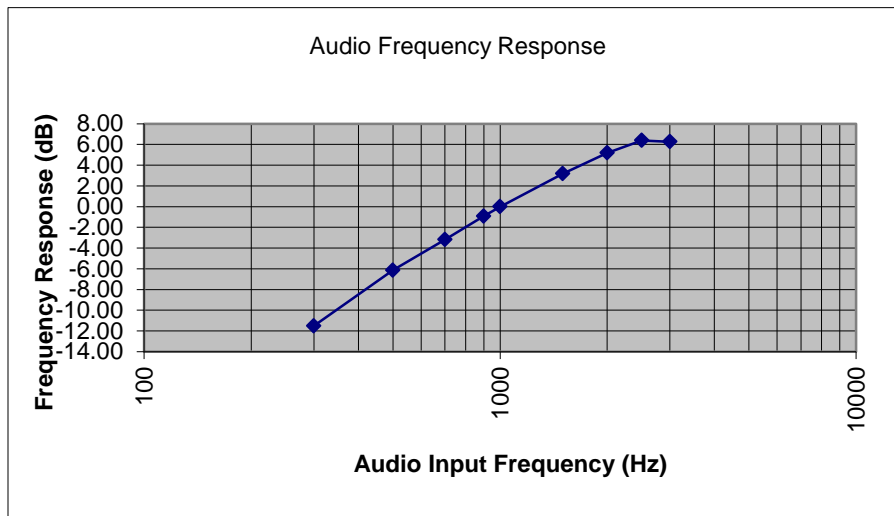

16K0F3E

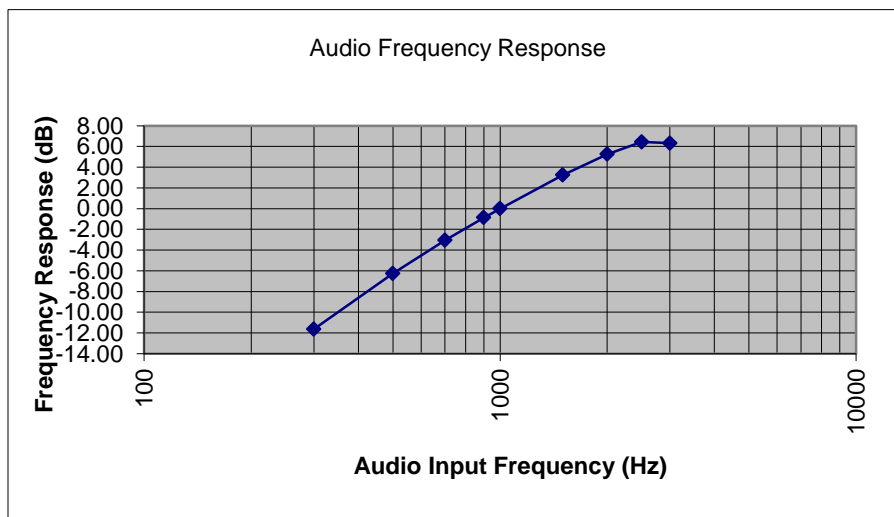



764-806 MHz Band

11K0F3E

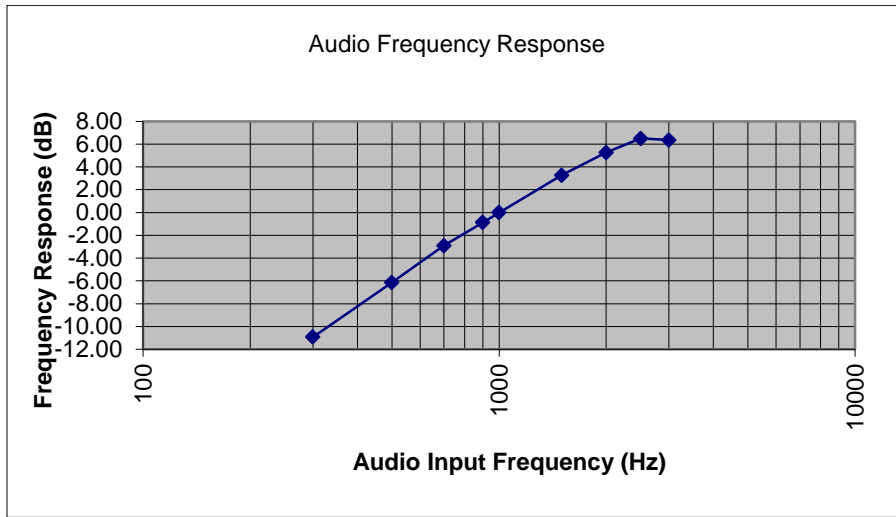

16K0F3E

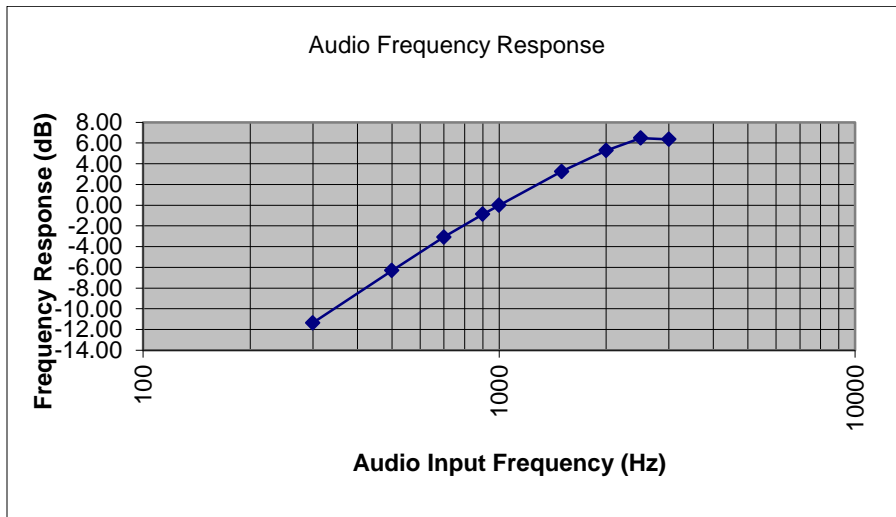



806-960 MHz Band (multiple frequencies tested)

827.05 MHz

11K0F3E

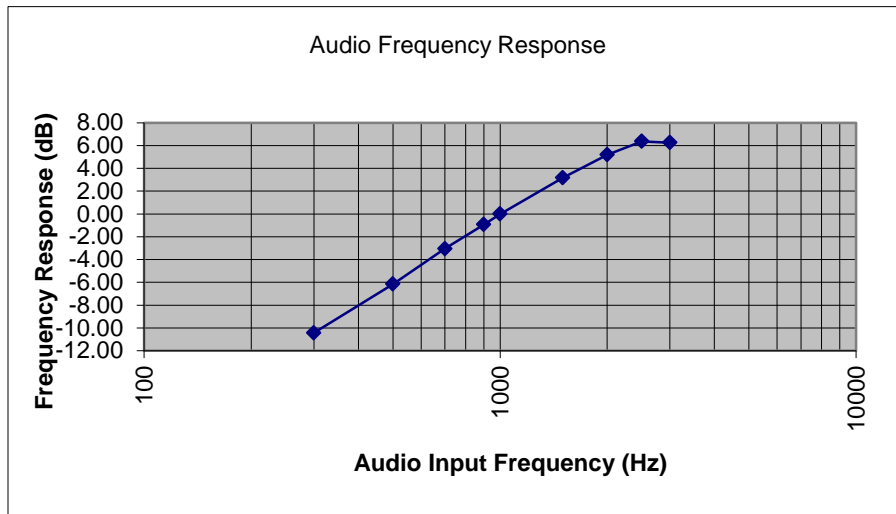

16K0F3E

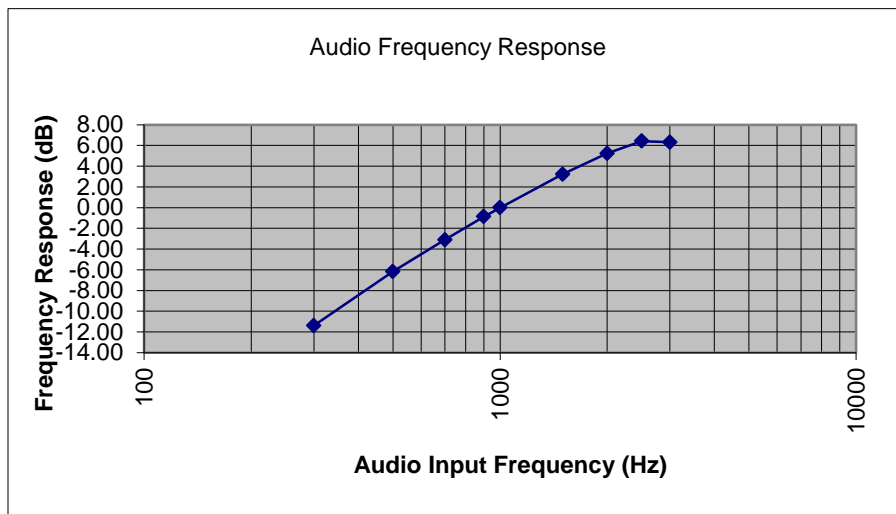



896.05 MHz

11K0F3E

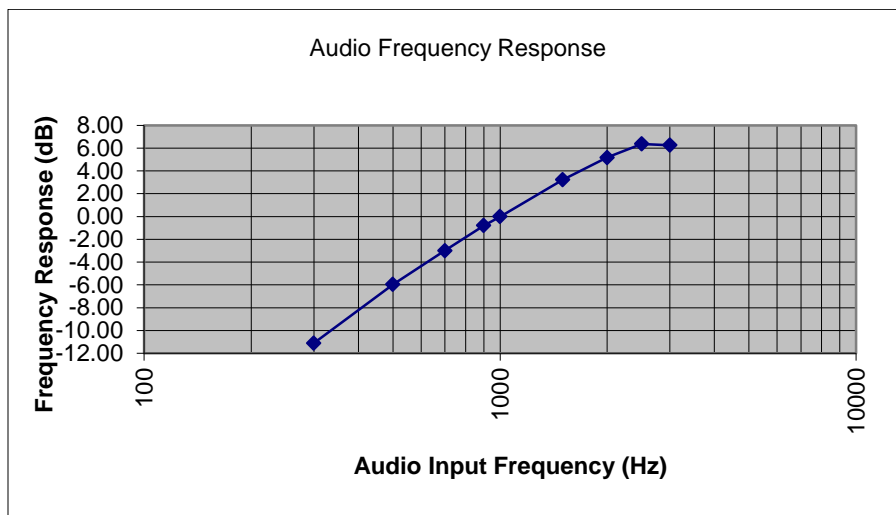

16K0F3E

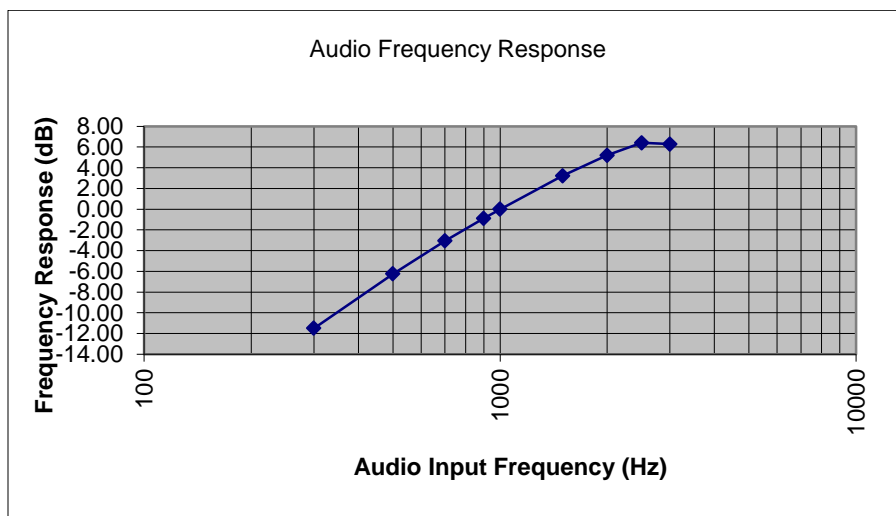



939.95 MHz

11K0F3E

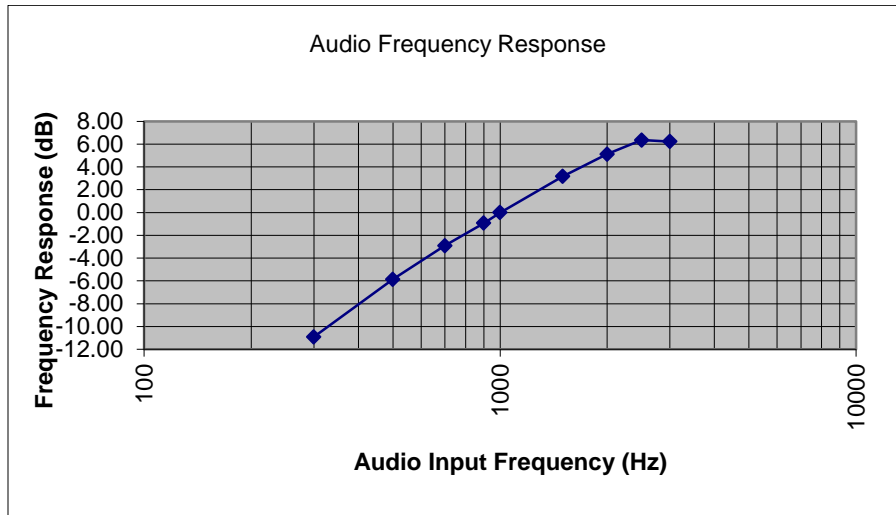

16K0F3E

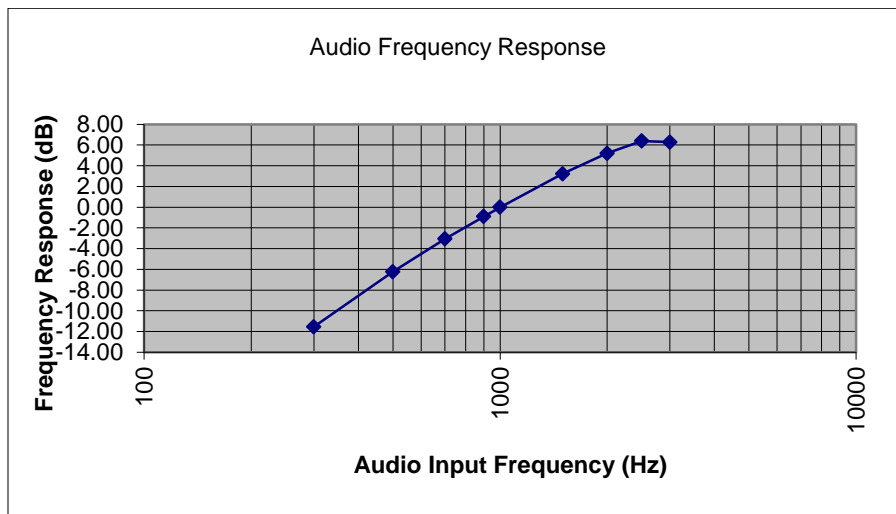



MTM 136-174 MHz Band

11K0F3E

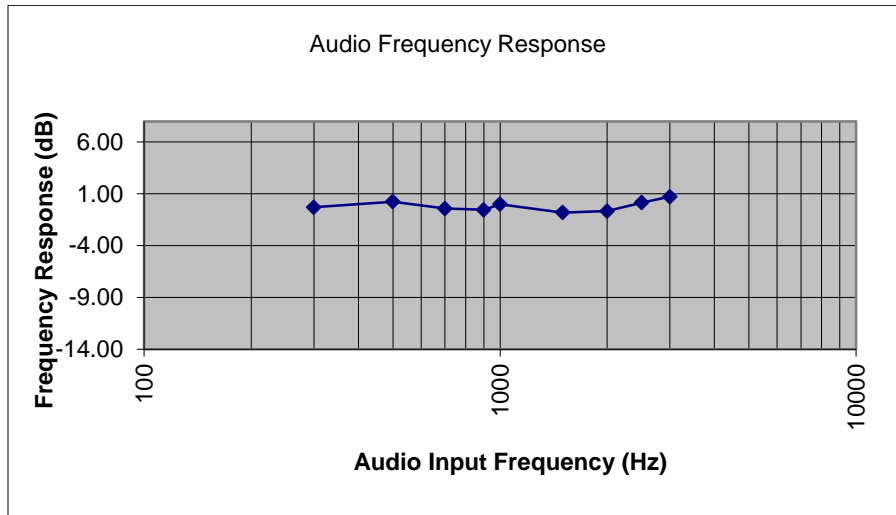

16K0F3E

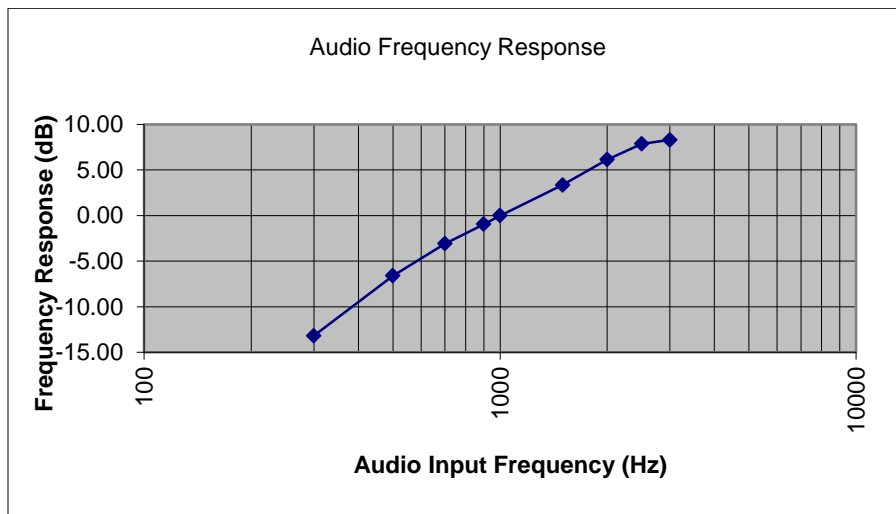



MTM 380-470 MHz Band

11K0F3E

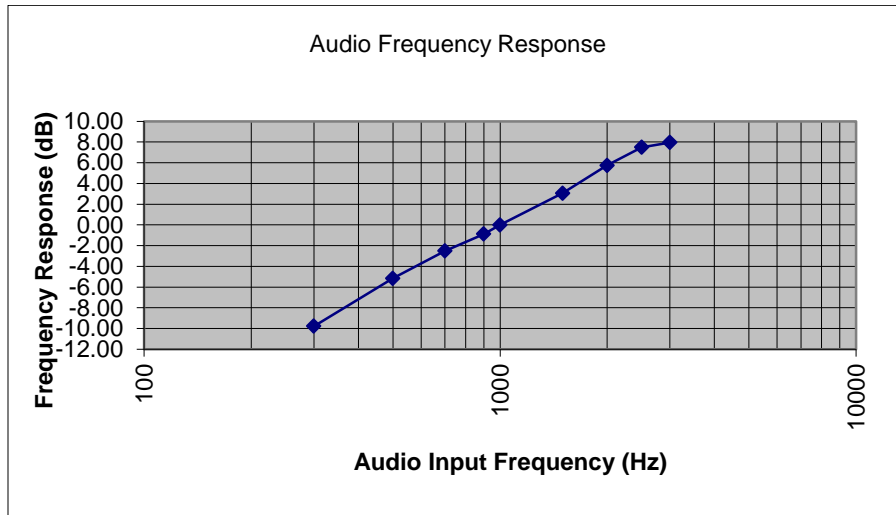

16K0F3E

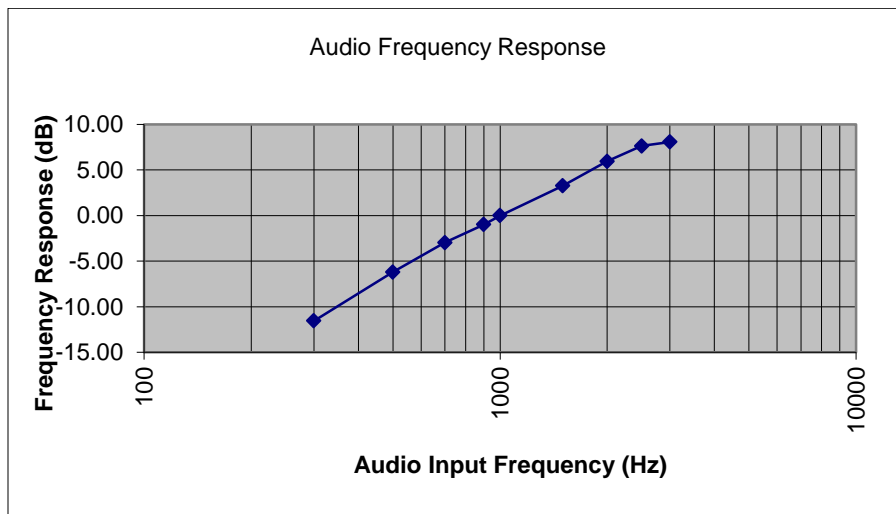



MTM 450-520 MHz Band

11K0F3E

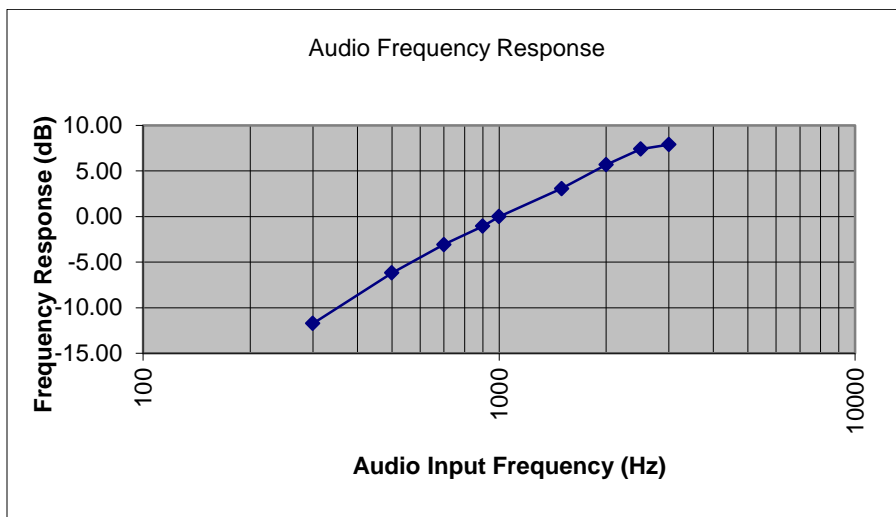

16K0F3E

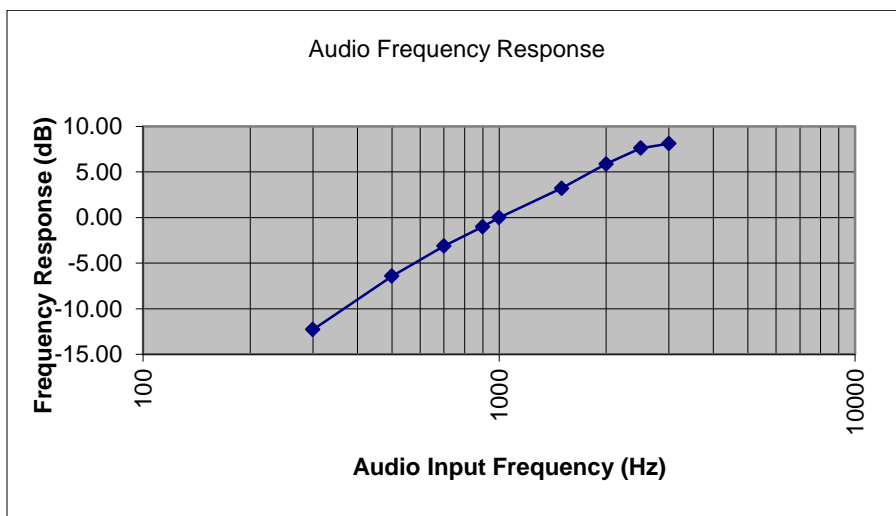



MTM 764-870 MHz Band

11K0F3E

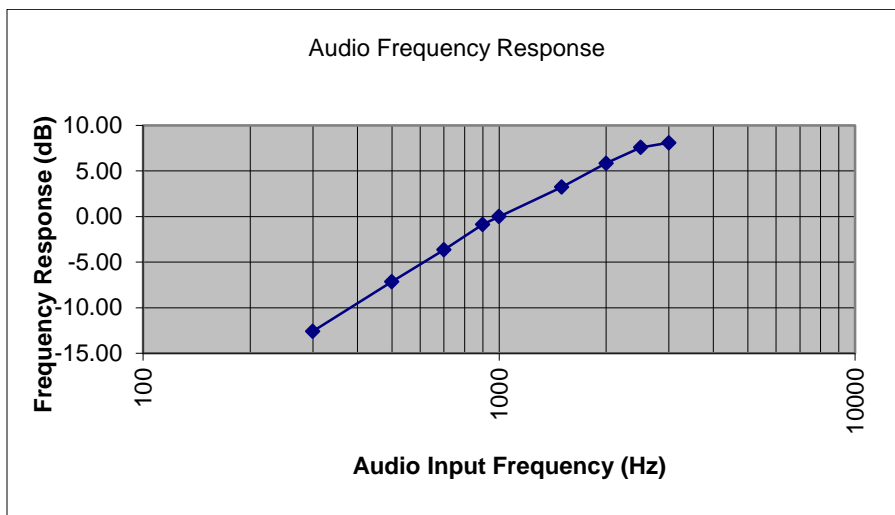

16K0F3E

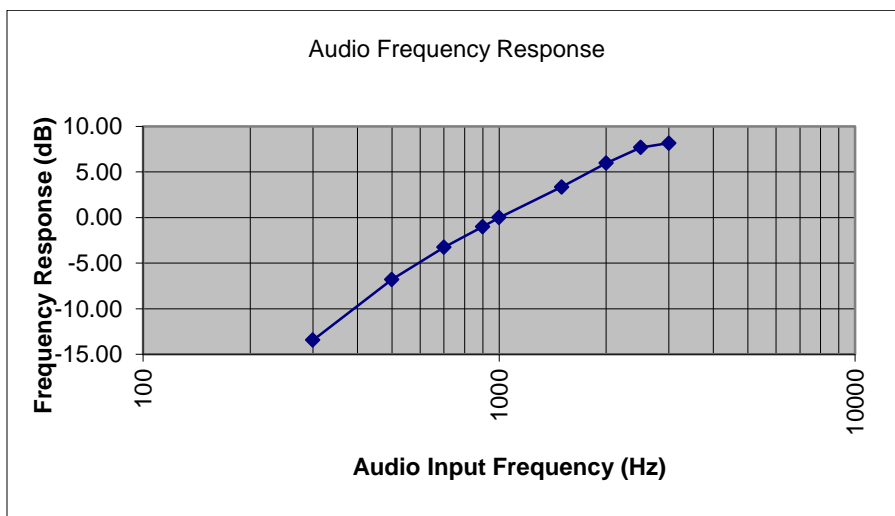



Modulation Limiting

Name of Test: Modulation Limiting

Engineer: John Erhard

Test Equipment Utilized: i00345, i00118

Test Date: 11/27/2012

Test Procedure

The EUT was connected directly to a modulation analyzer through an attenuator. The audio source was tuned across the required audio frequency range and the modulation limiting response was measured and plotted. The modulation analyzer is a real time spectrum analyzer with integrated demodulation, audio measurement capabilities, and timing analysis. As this parameter is not frequency or band dependent the number of frequencies tested was reduces in comparison to previous tests

Test Setup

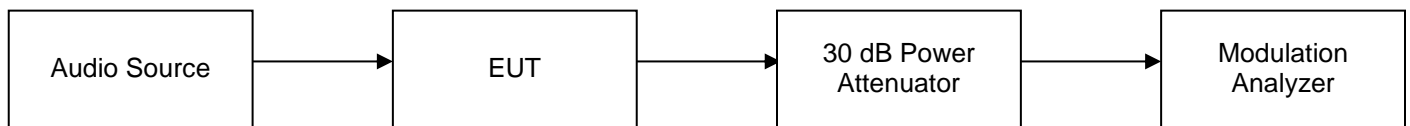



29.7-88 MHz Band

11K0F3E Positive Peaks

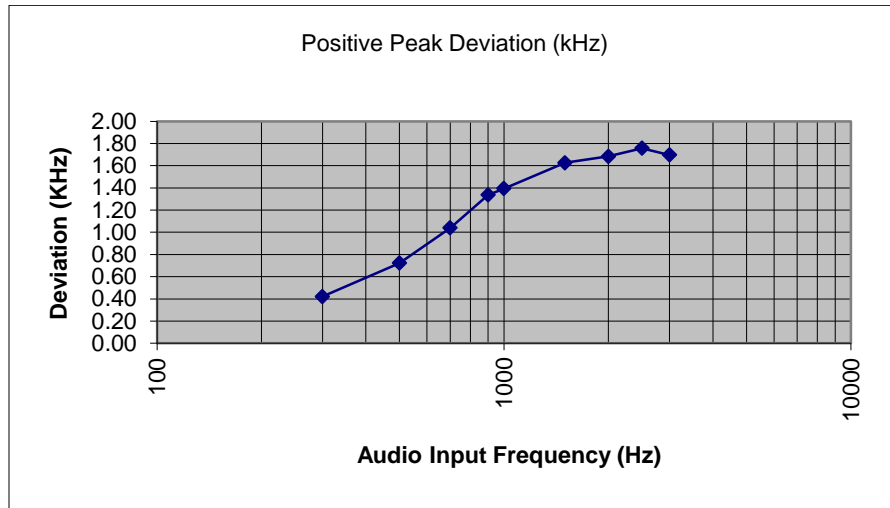

11K0F3E Negative Peaks

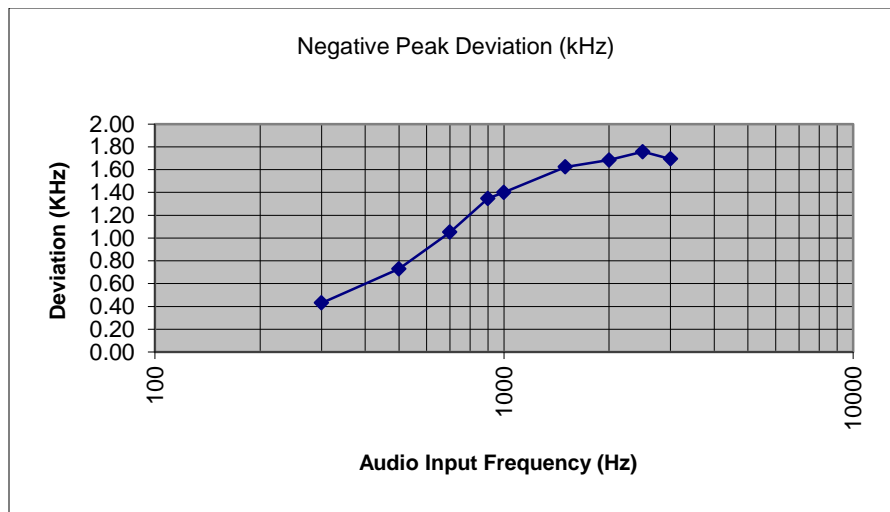



16K0F3E Positive Peaks

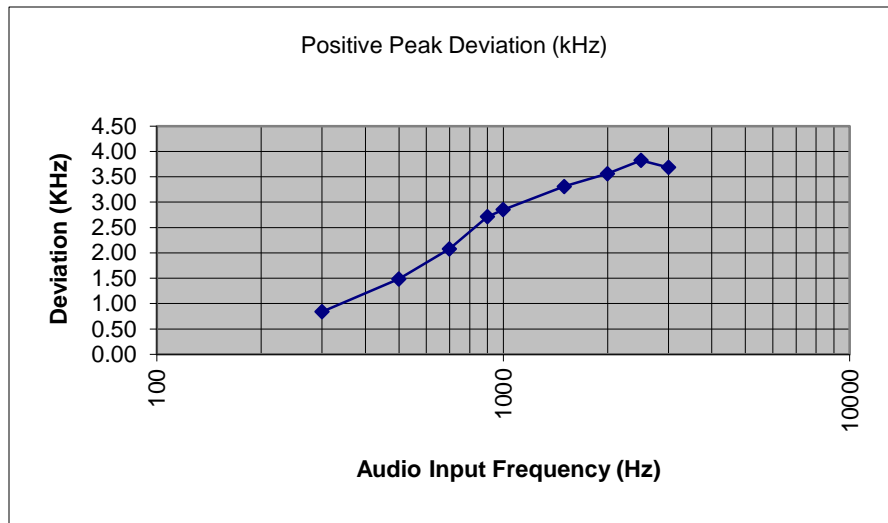

16K0F3E Negative Peaks

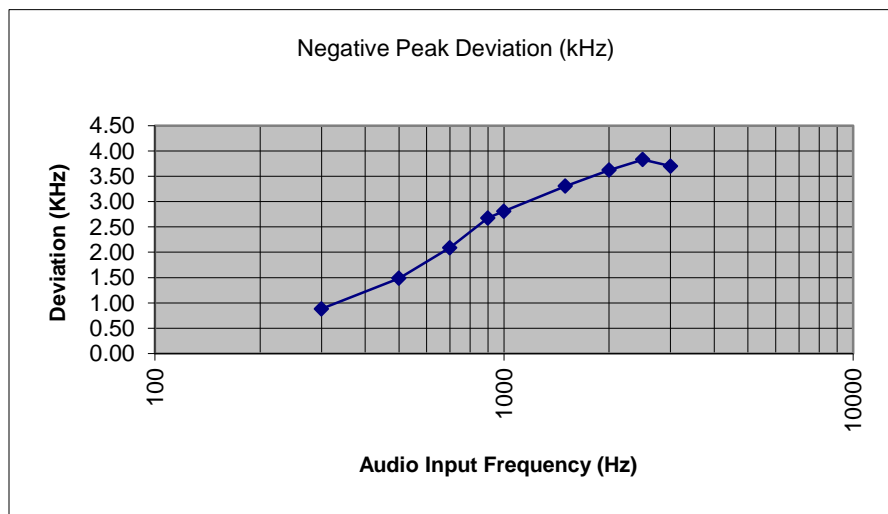



136-174 MHz Band

11K0F3E Positive Peaks

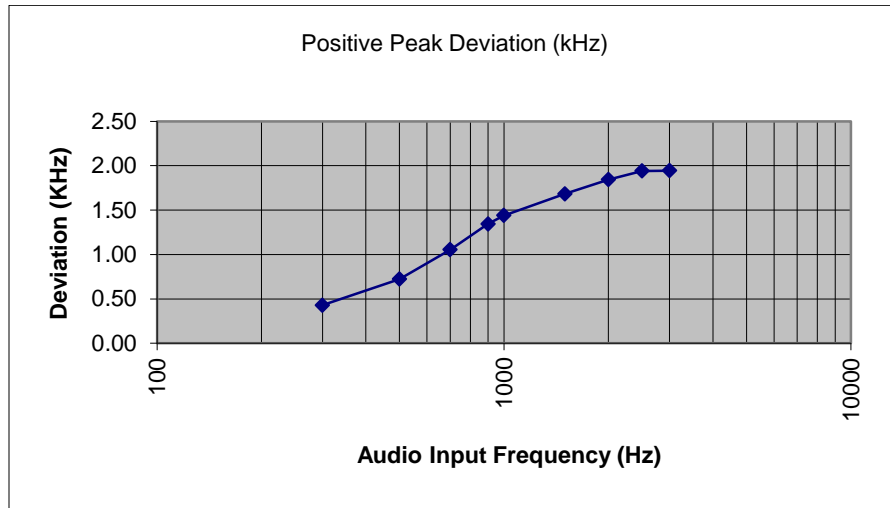

11K0F3E Negative Peaks

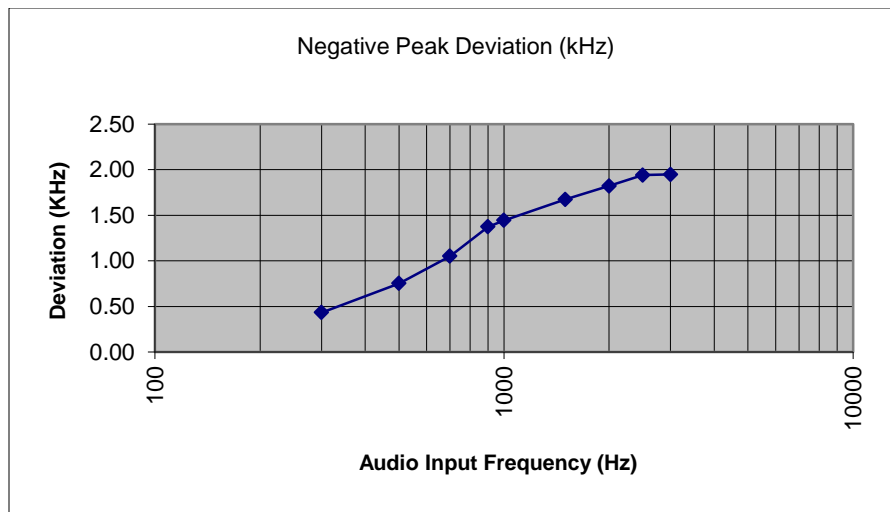



16K0F3E Positive Peaks

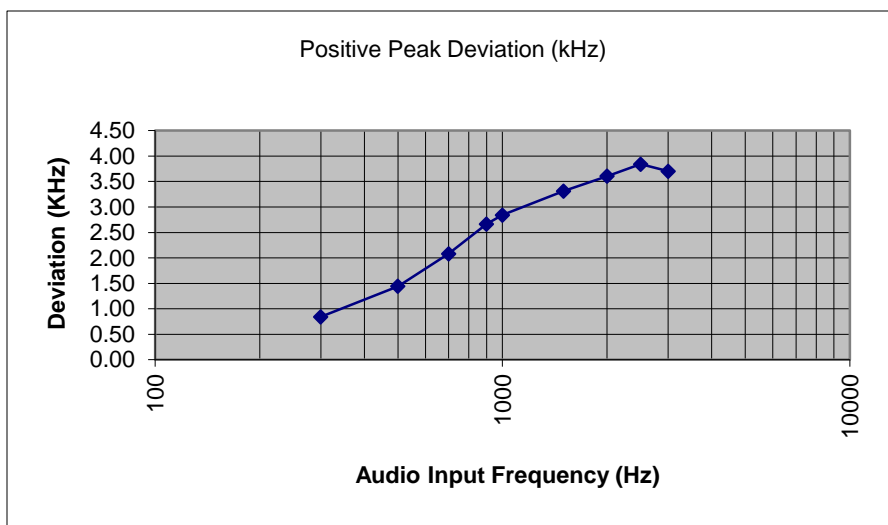

16K0F3E Negative Peaks

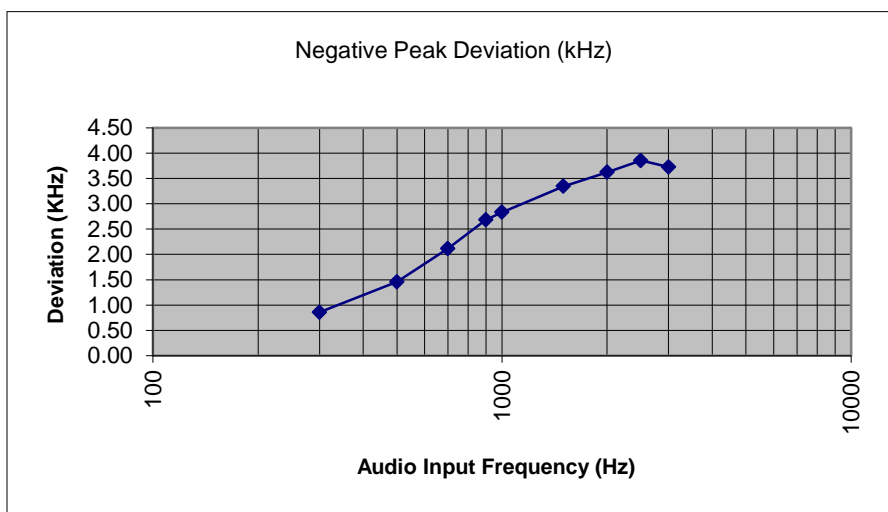



380-520 MHz Band

11K0F3E Positive Peaks

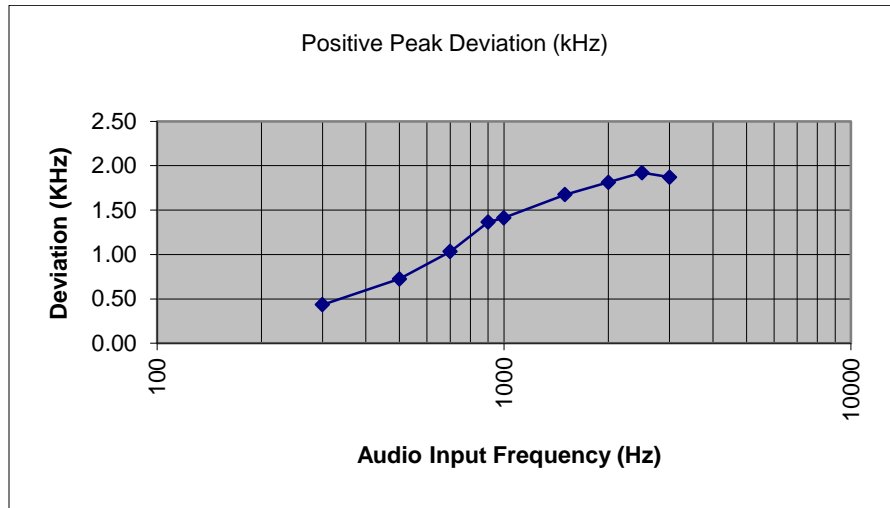

11K0F3E Negative Peaks

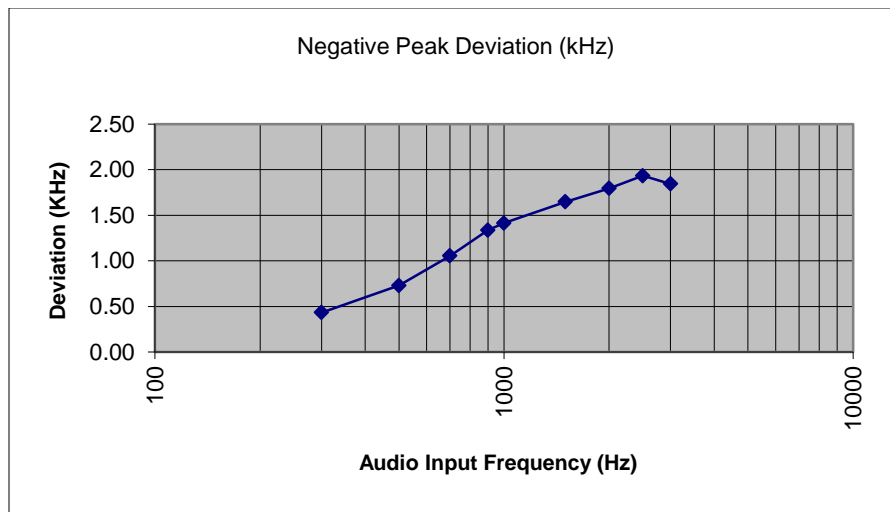



16K0F3E Positive Peaks

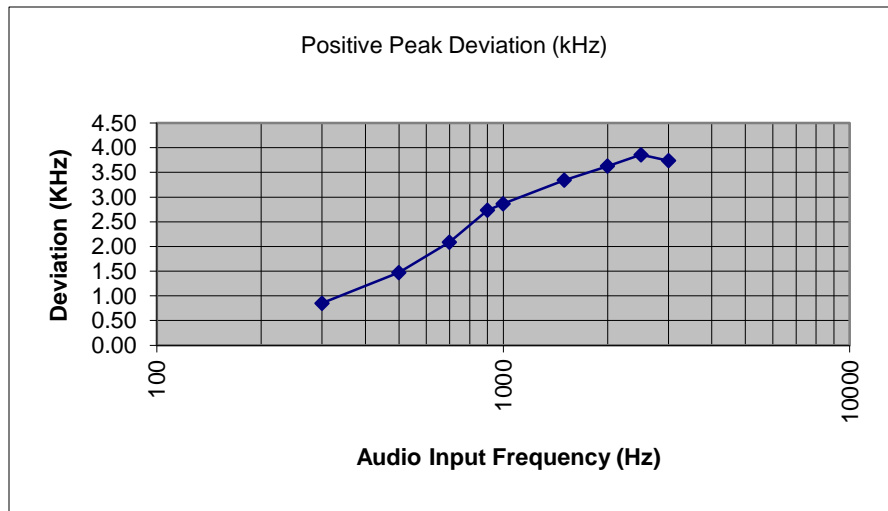

16K0F3E Negative Peaks

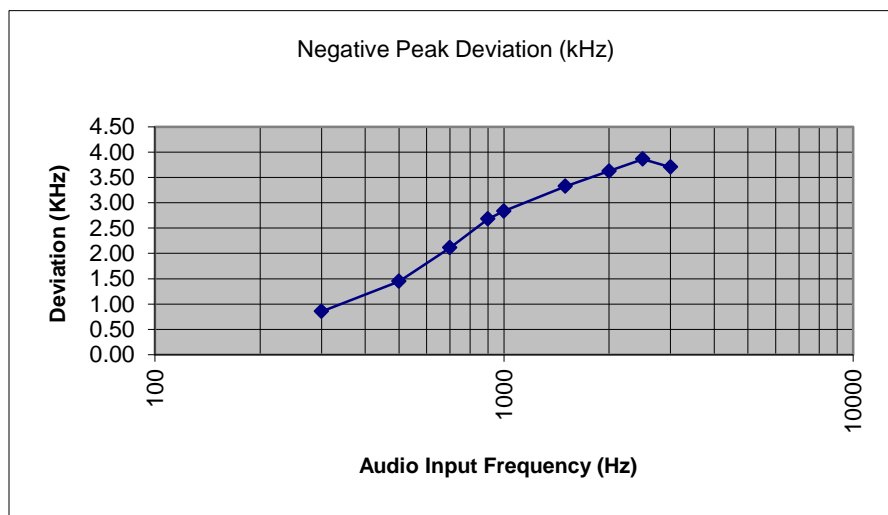



764-806 MHz Band

11K0F3E Positive Peaks

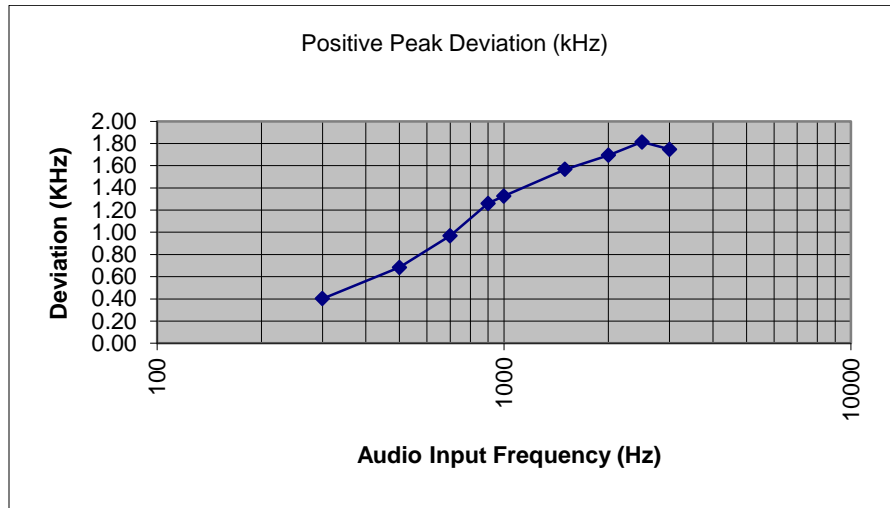

11K0F3E Negative Peaks

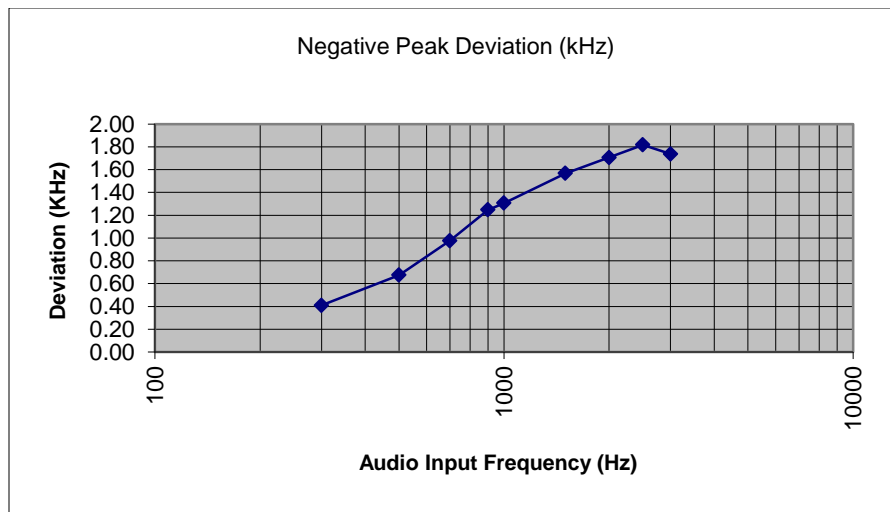



16K0F3E Positive Peaks

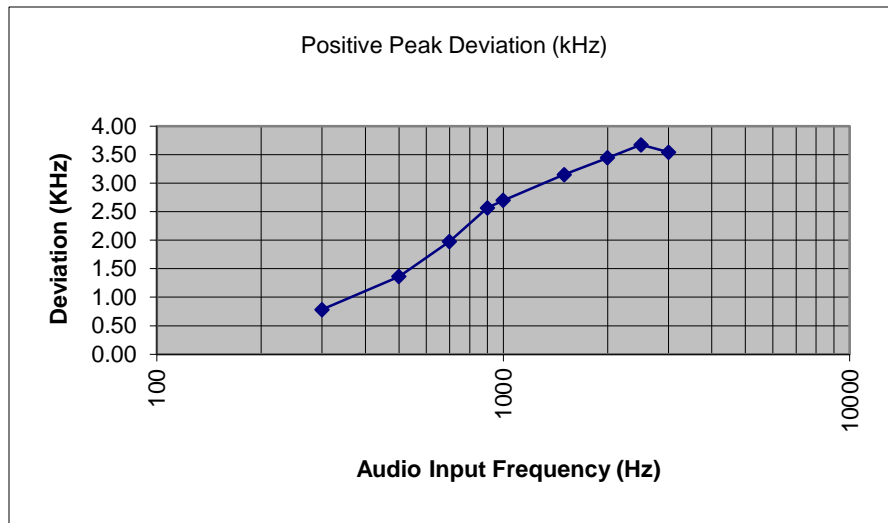

16K0F3E Negative Peaks

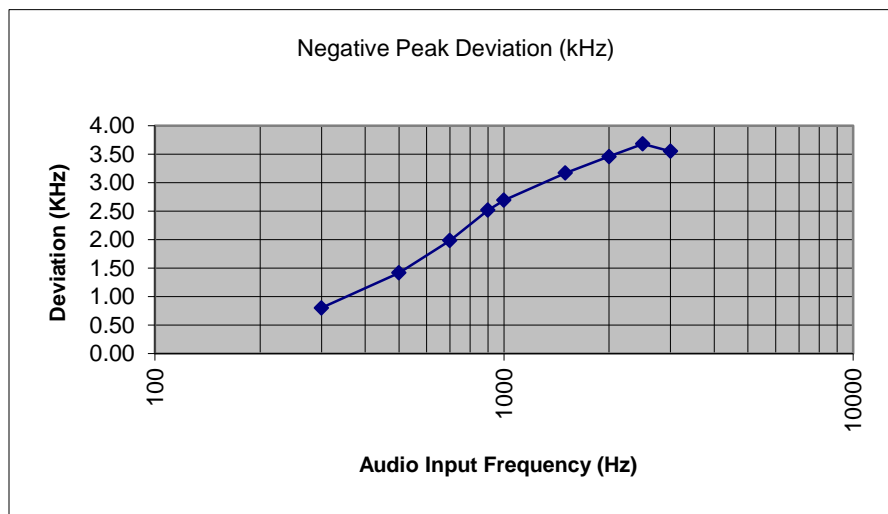



806-960 MHz Band (multiple frequencies tested)

827.05 MHz

11K0F3E Positive Peaks

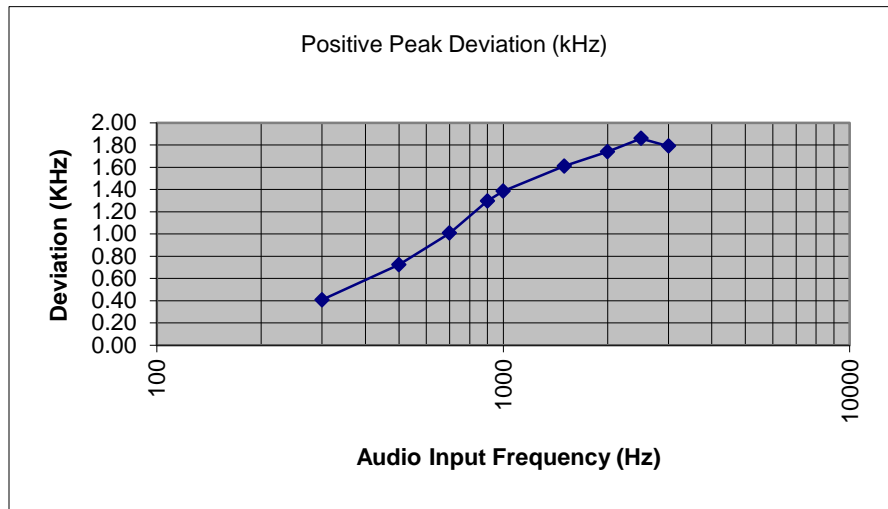

11K0F3E Negative Peaks

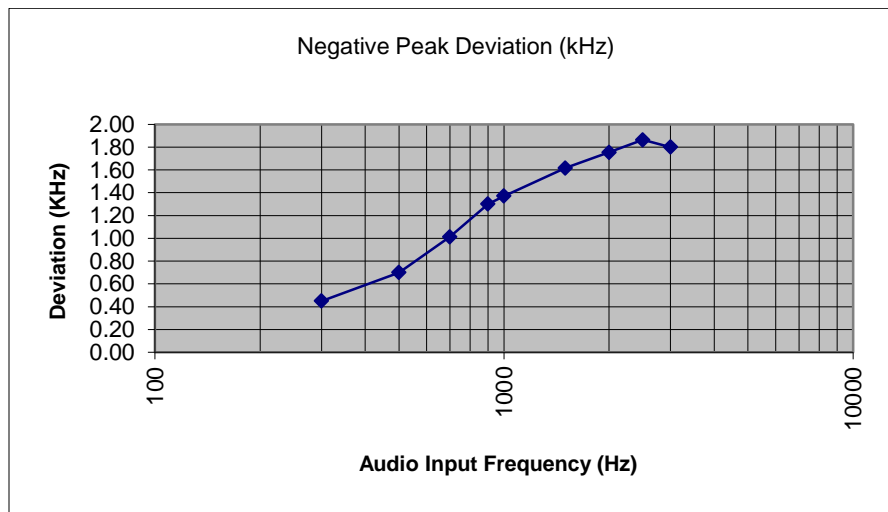



16K0F3E Positive Peaks

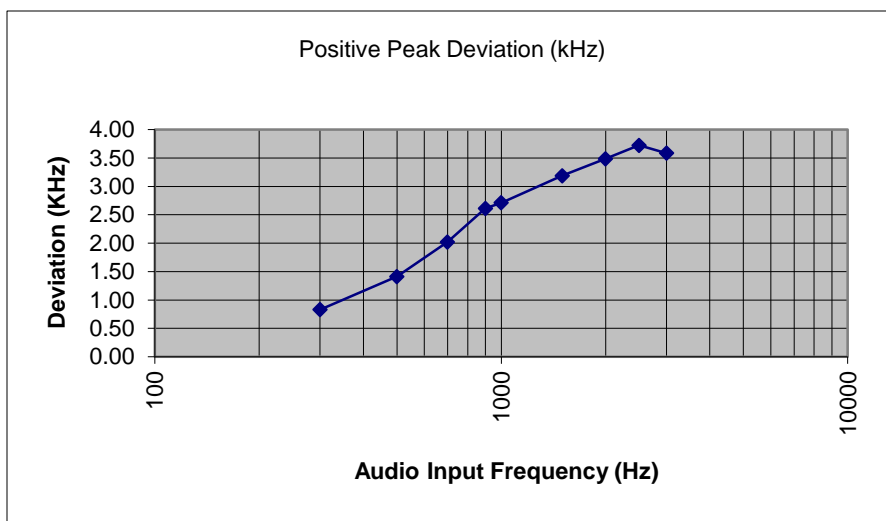

16K0F3E Negative Peaks

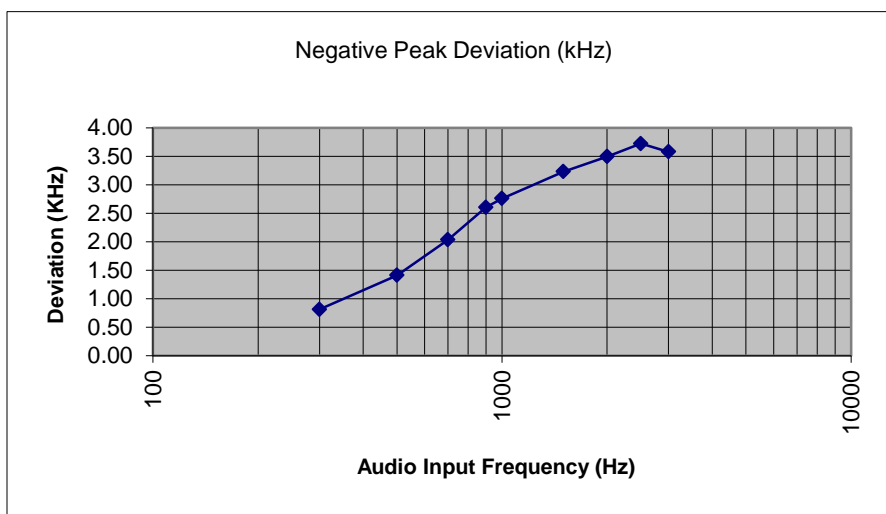



896.05 MHz

11K0F3E Positive Peaks

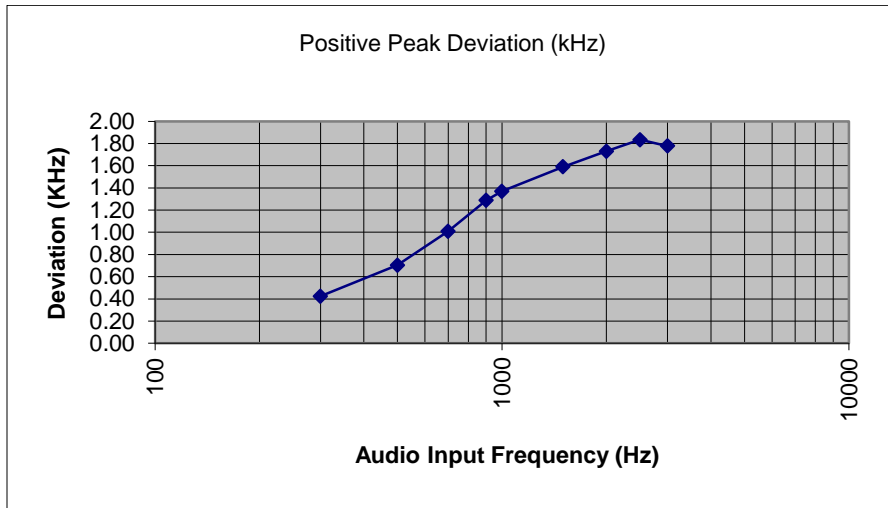

11K0F3E Negative Peaks

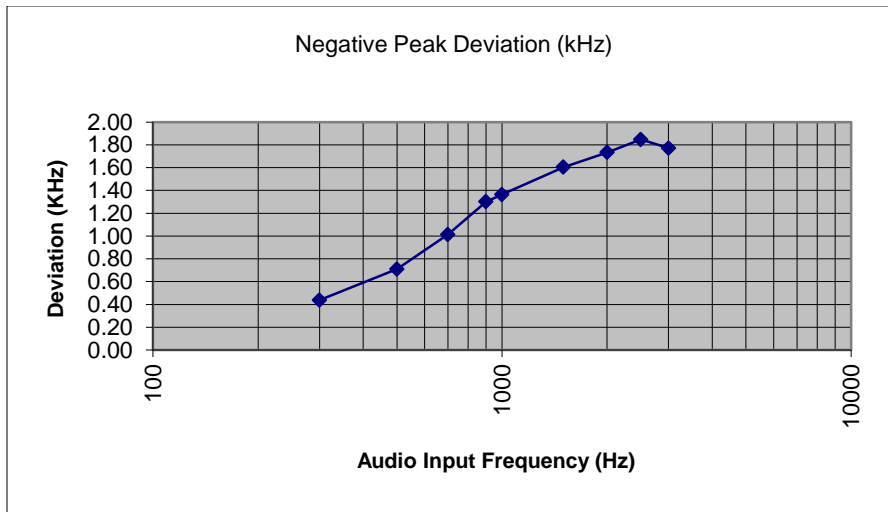



16K0F3E Positive Peaks

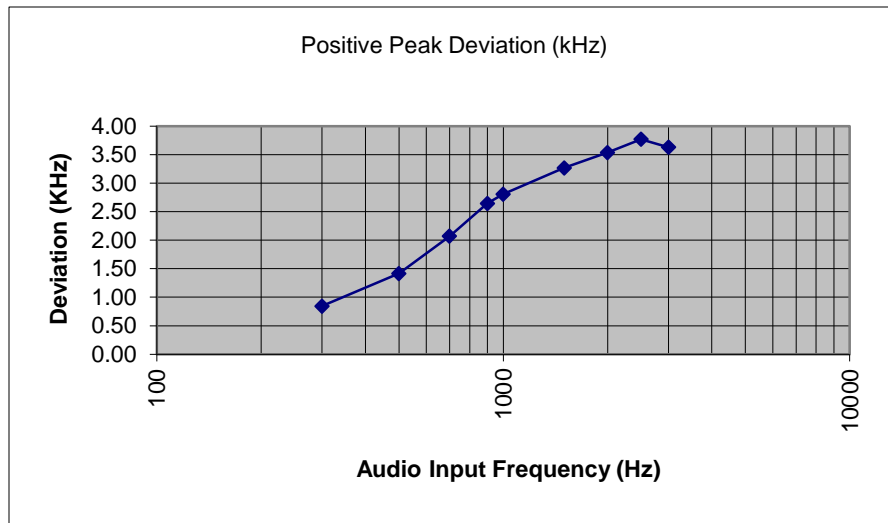

16K0F3E Negative Peaks

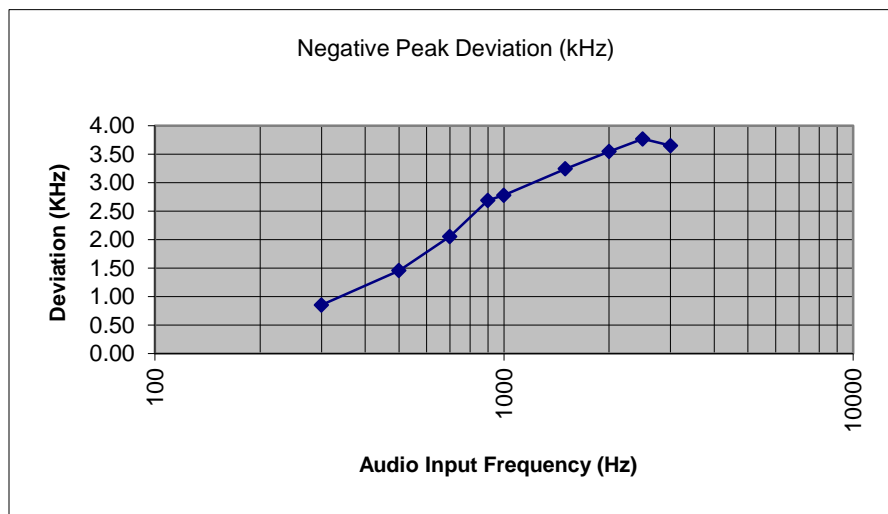



939.95 MHz

11K0F3E Positive Peaks

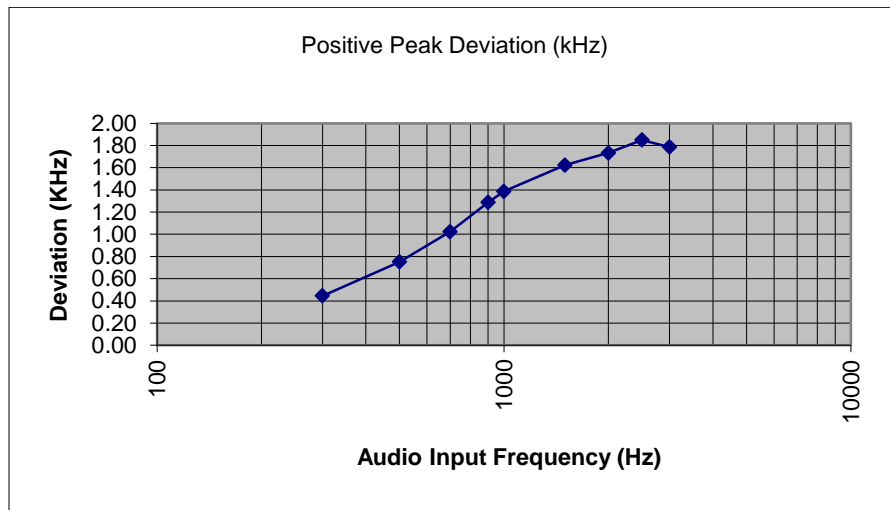

11K0F3E Negative Peaks

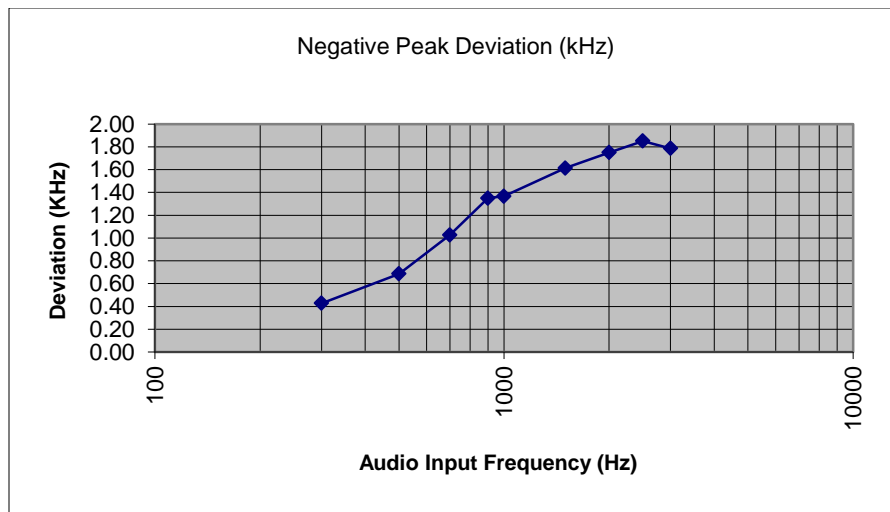



16K0F3E Positive Peaks

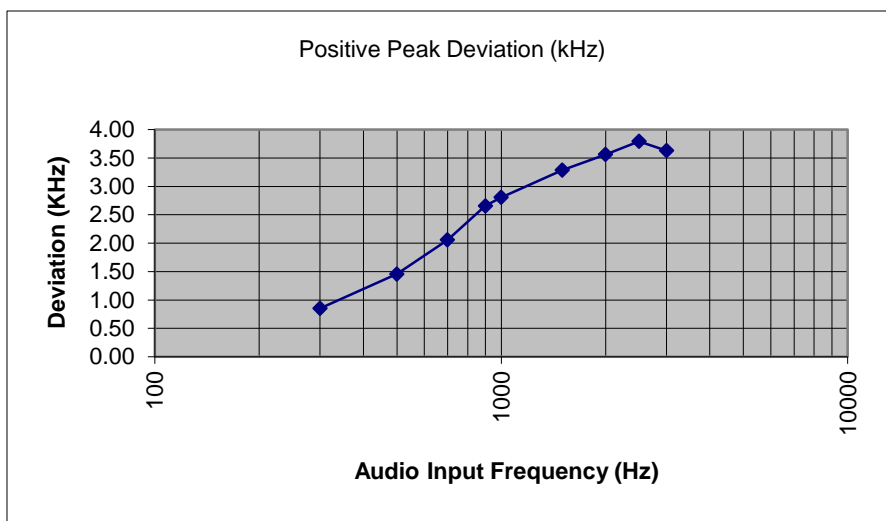

16K0F3E Negative Peaks

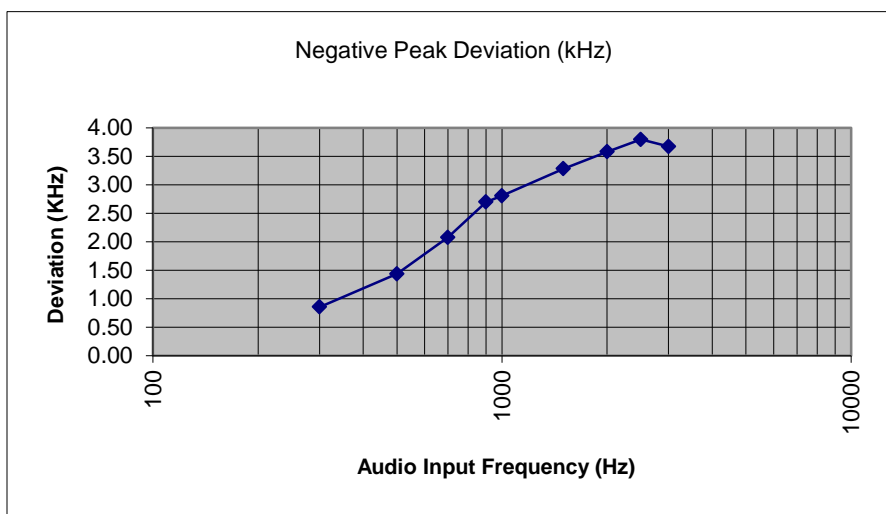



MTM 136-174 MHz Band

11K0F3E Positive Peaks

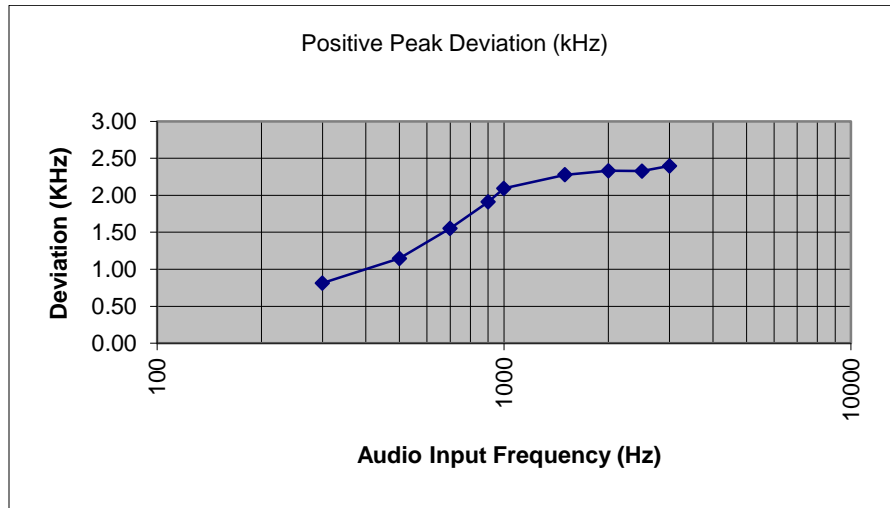

11K0F3E Negative Peaks

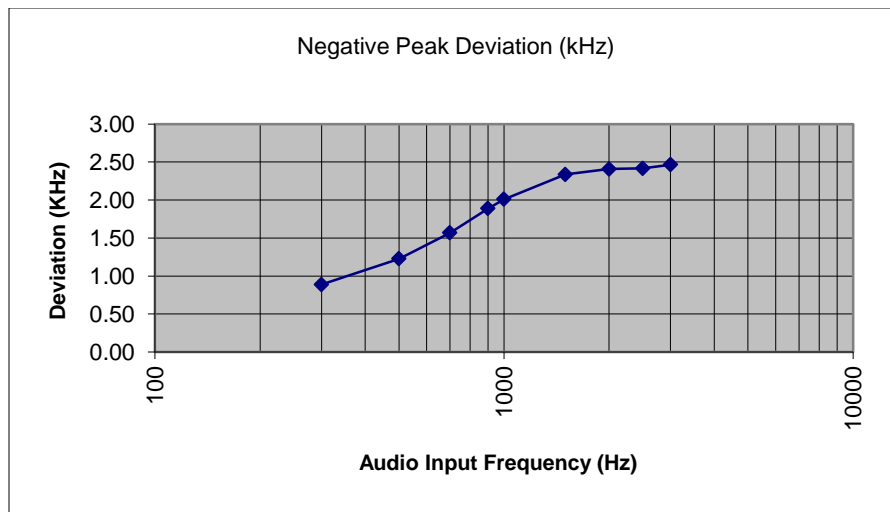



16K0F3E Positive Peaks

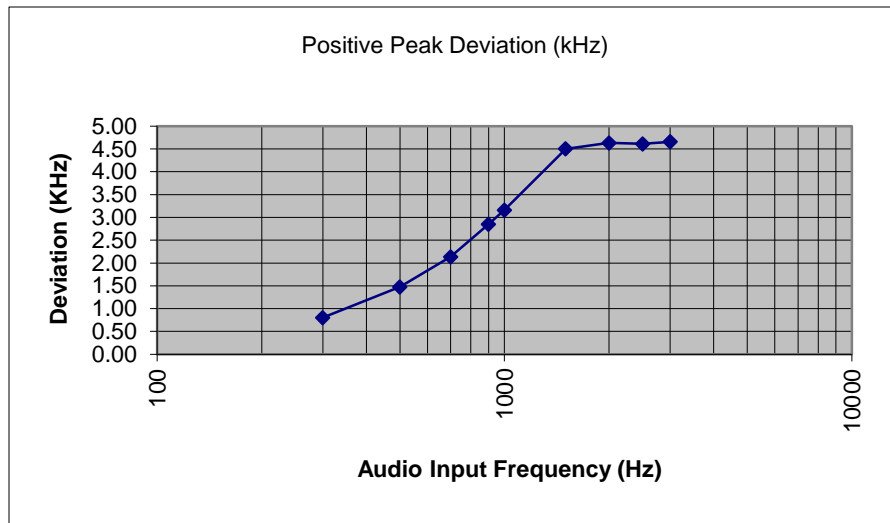

16K0F3E Negative Peaks

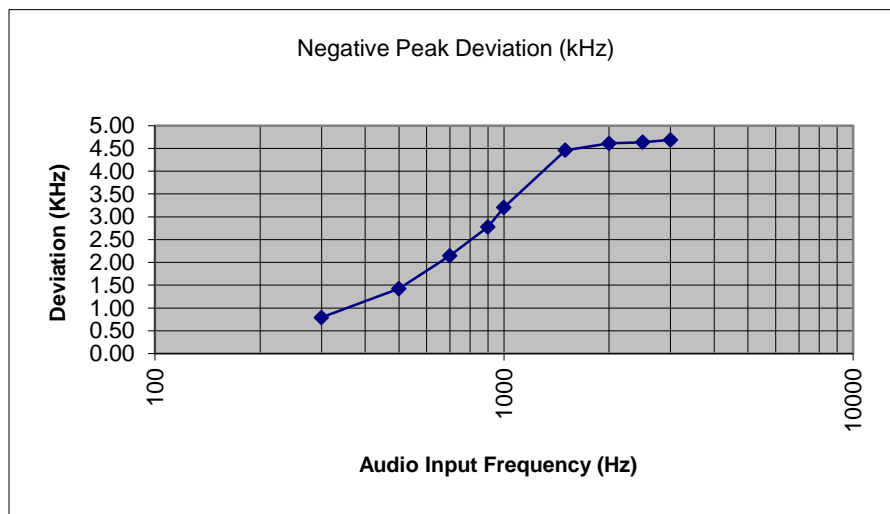



MTM 380-470 MHz Band

11K0F3E Positive Peaks

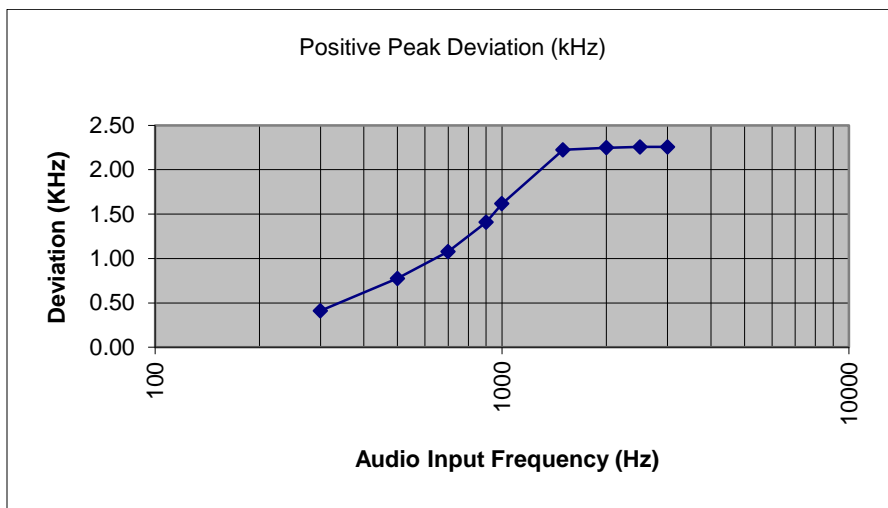

11K0F3E Negative Peaks

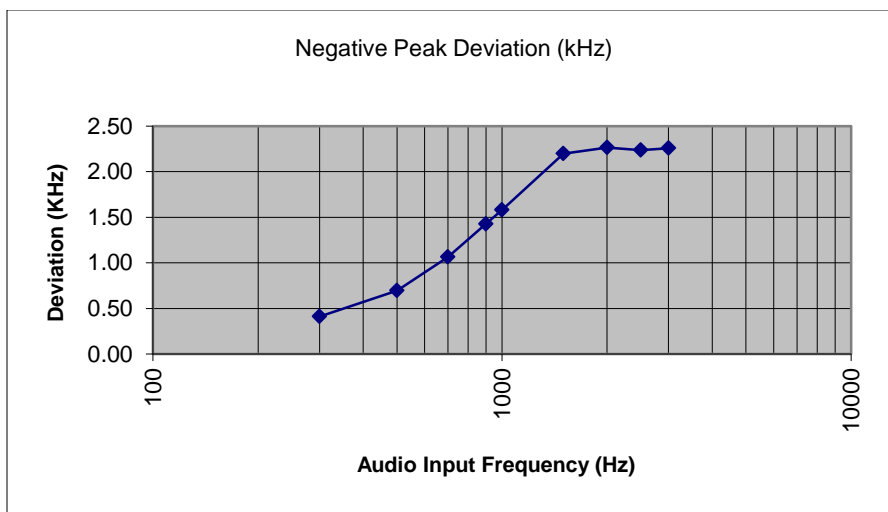



16K0F3E Positive Peaks

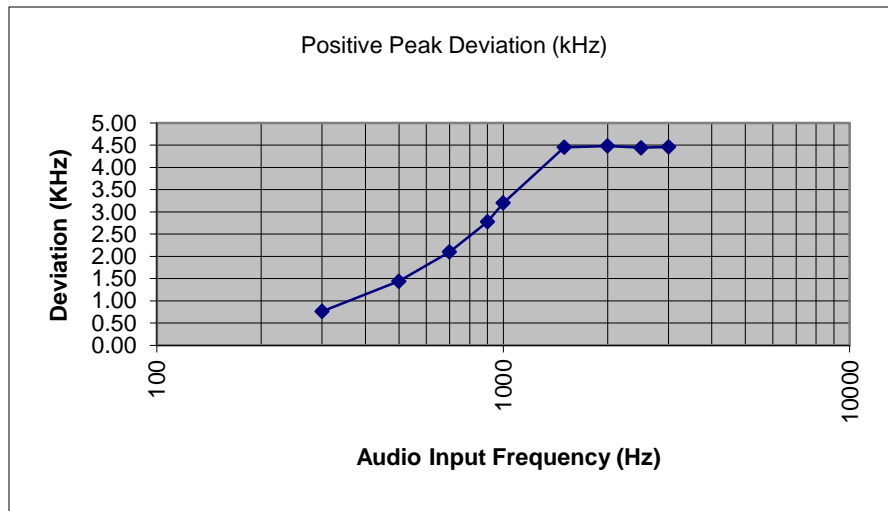

16K0F3E Negative Peaks

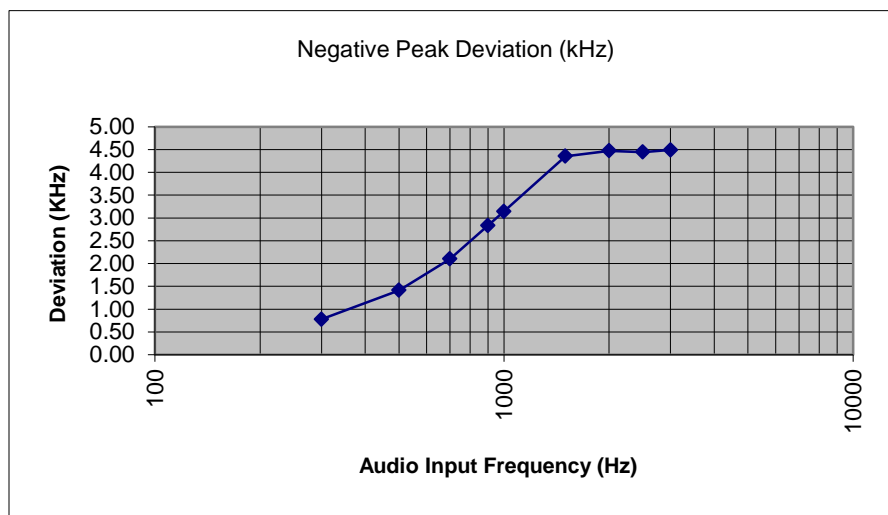



MTM 450-520 MHz Band

11K0F3E Positive Peaks

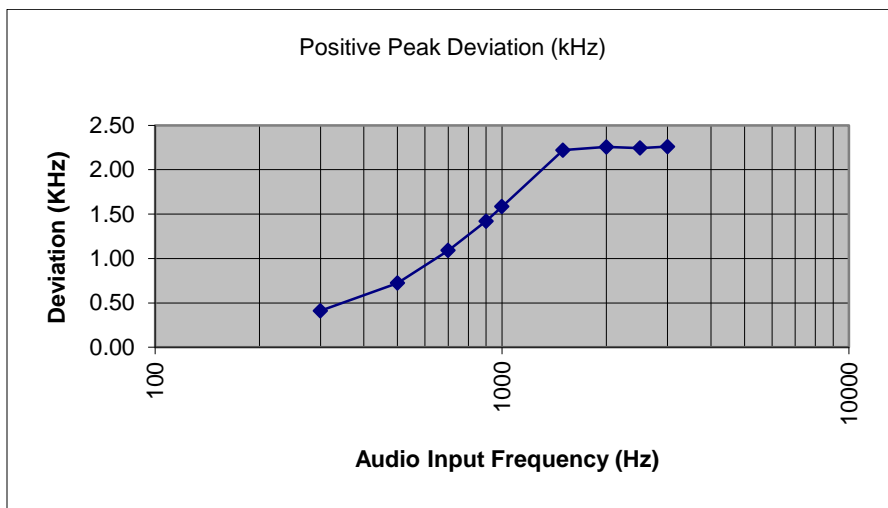

11K0F3E Negative Peaks

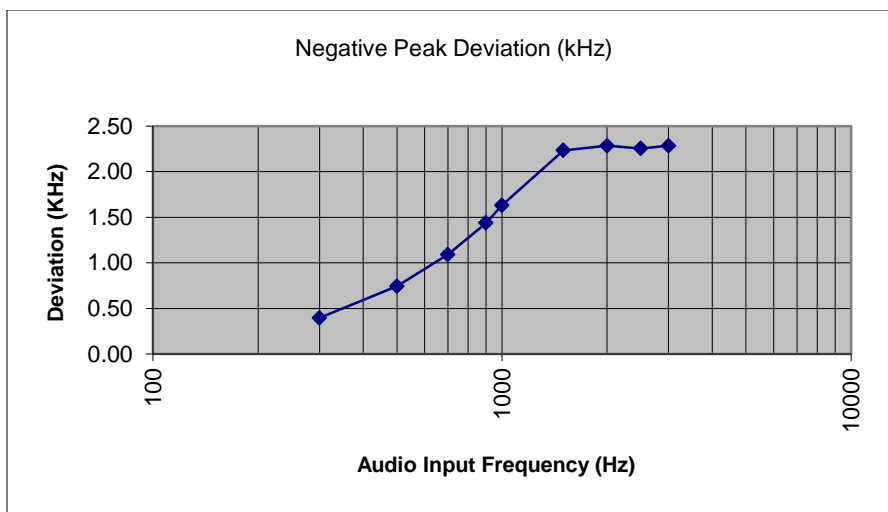



16K0F3E Positive Peaks

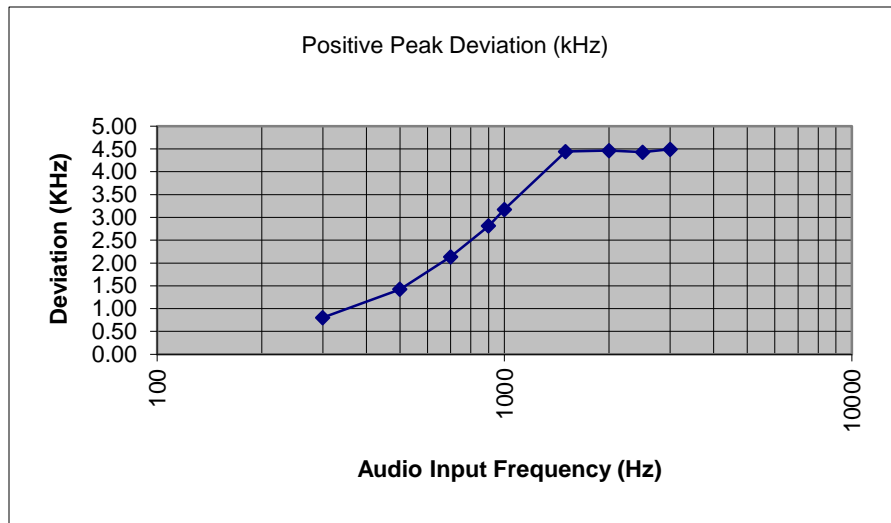

16K0F3E Negative Peaks

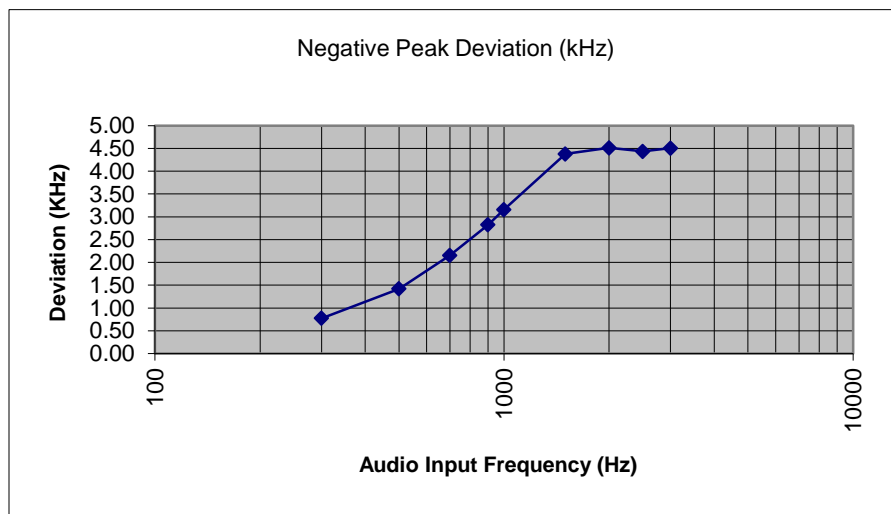



MTM 764-870 MHz Band

11K0F3E Positive Peaks

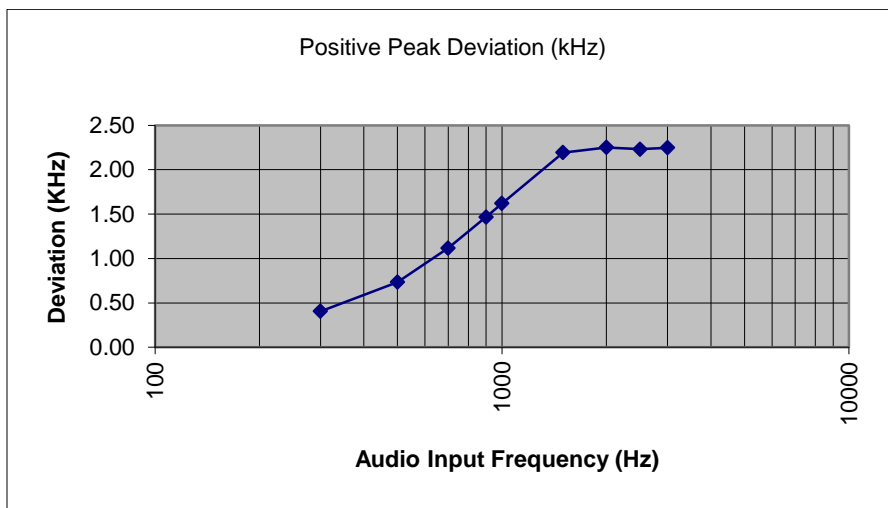

11K0F3E Negative Peaks

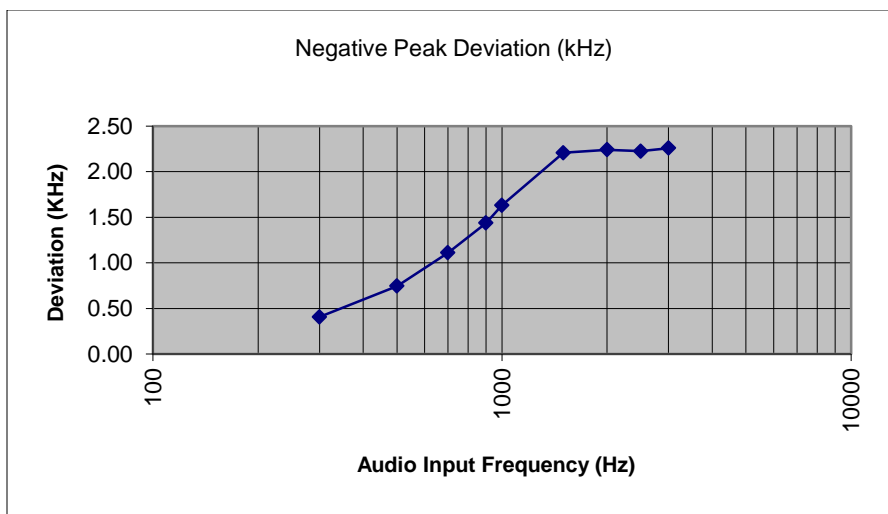



16K0F3E Positive Peaks

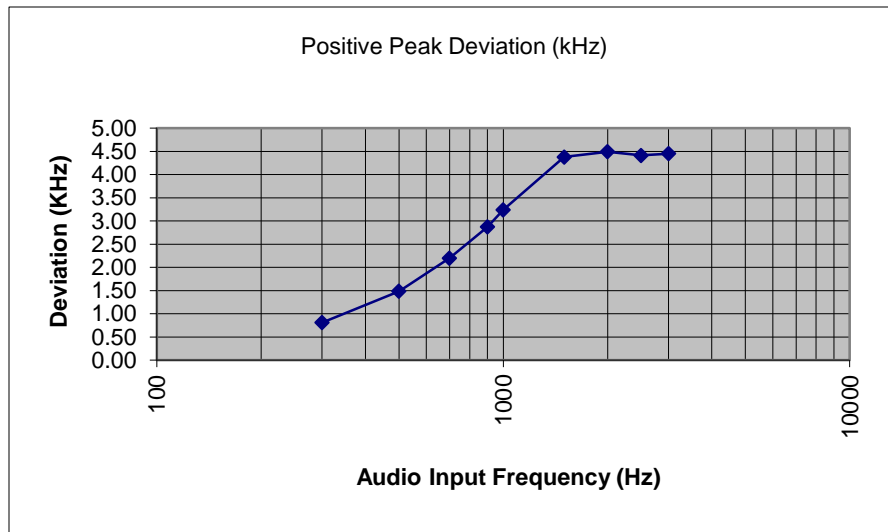

16K0F3E Negative Peaks

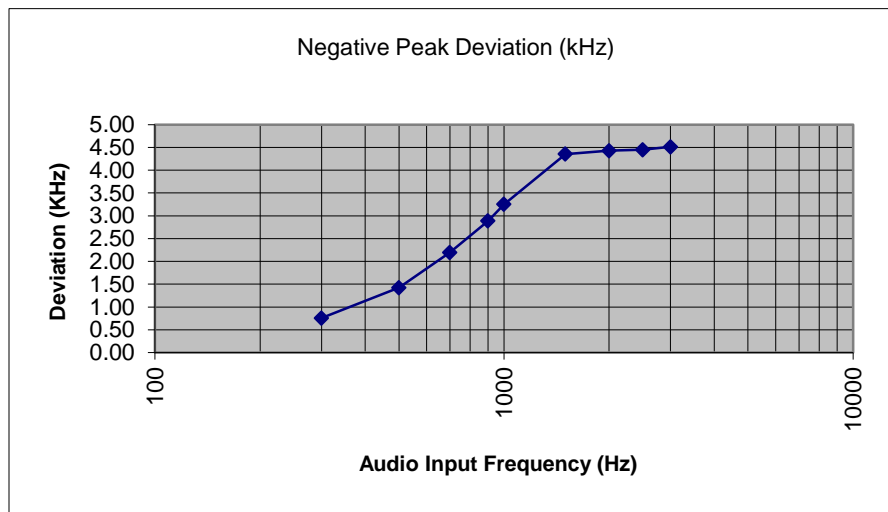



Frequency Stability

Name of Test: Frequency Stability
Test Equipment Utilized: i00019, i00287, i00343, i00191

Engineer: John Erhard
Test Date: 11/21/2012

Test Procedure

The EUT was placed in an environmental test chamber and the RF output was connected to a frequency counter. The temperature was varied from -30°C to 50°C in 10°C increments. After a sufficient time for temperature stabilization the RF output frequency was measured. At 20°C the input voltage was varied to +/- 15% of the nominal input voltage. The number of frequencies tested was reduced to the amount required for variations in frequency tolerance by rule section.

Test Setup (Temperature Variation)

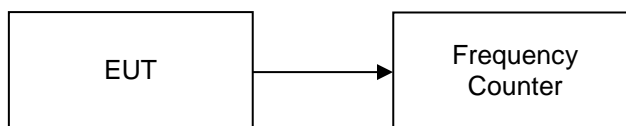

Test Setup (Voltage Variation)

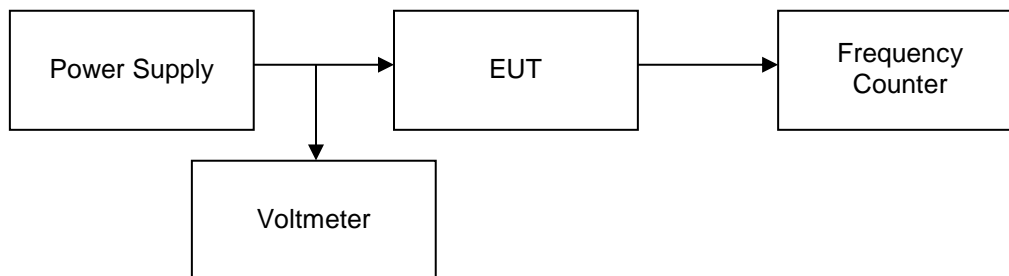



Test Results 29.7-88 MHz Band

Tuned Frequency 72.5 MHz
Limit = 5 PPM
Upper Limit = 72.500363
Lower Limit = 72.499638

Temperature Variation

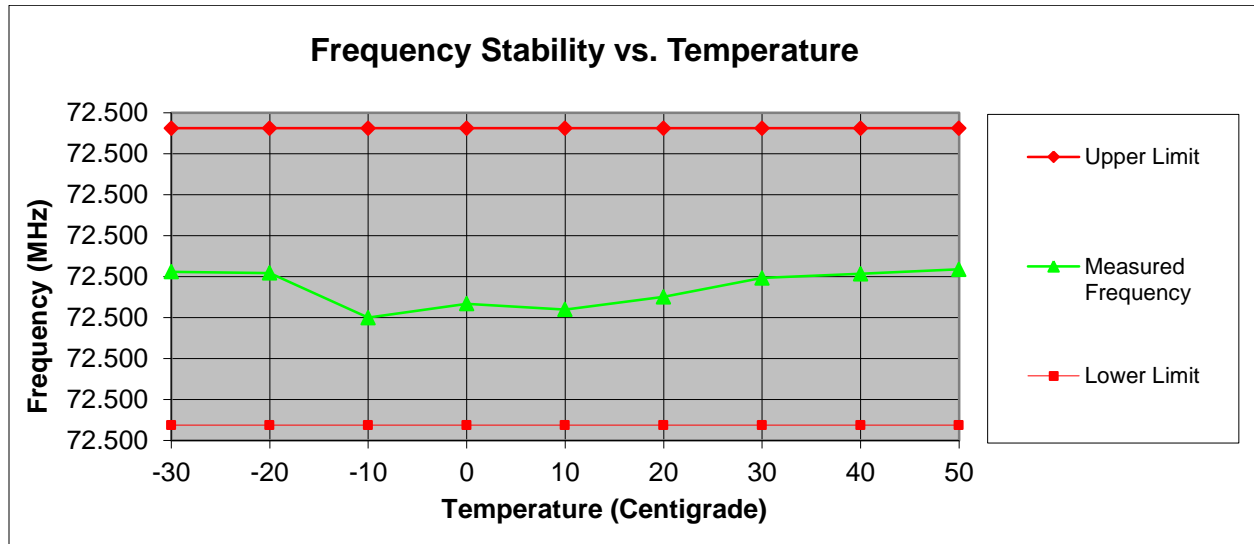

Voltage Variation

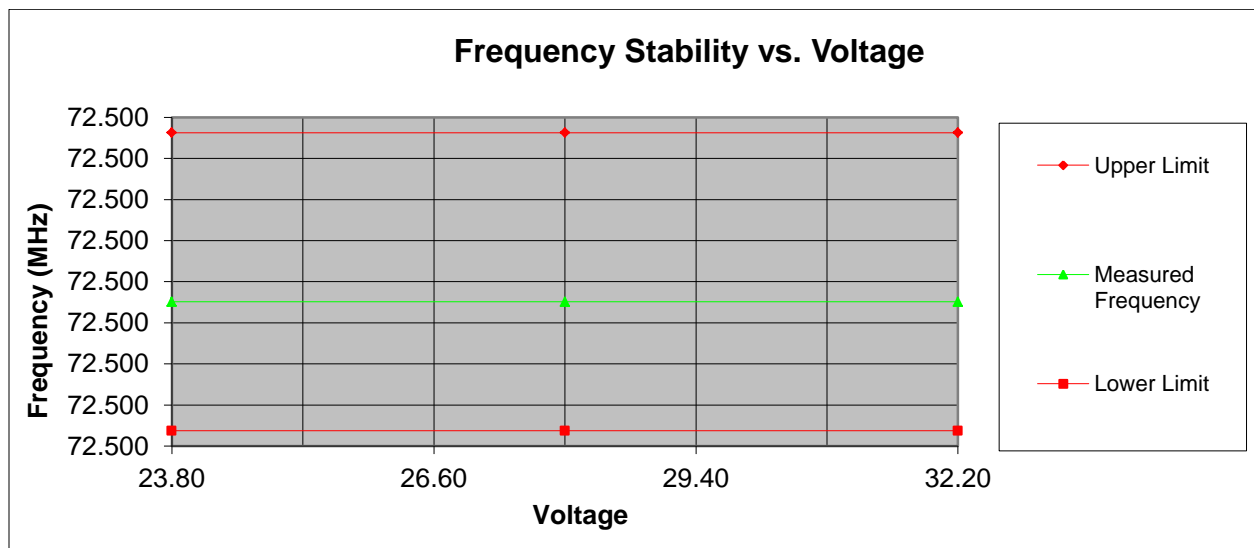



Test Results 136-174 MHz

Tuned Frequency 161.775 MHz

Limit = 2.5 PPM

Upper Limit = 161.775404

Lower Limit = 161.774596

Temperature Variation

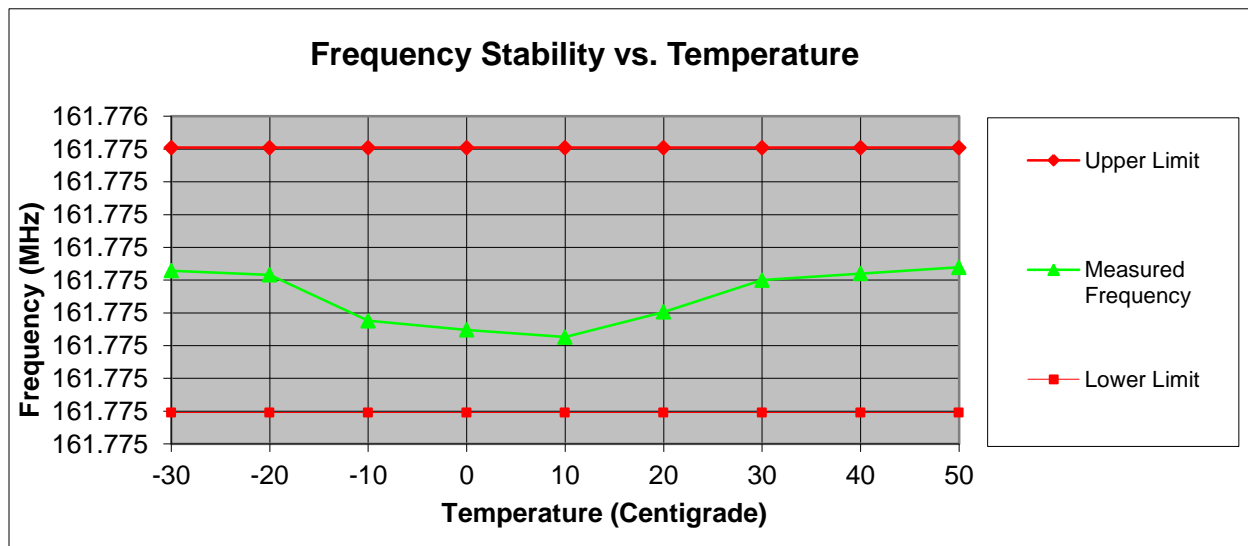

Voltage Variation

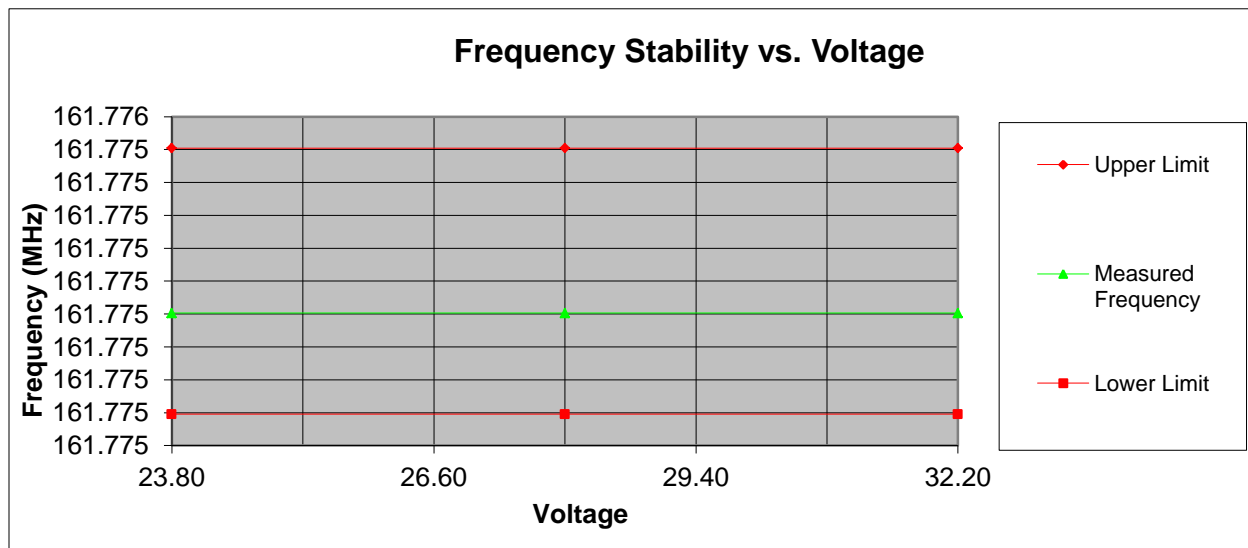



Test Results 380-520 MHz Band

Tuned Frequency 438.05 MHz

Limit = 2.5 PPM

Upper Limit = 438.051095

Lower Limit = 438.048905

Temperature Variation

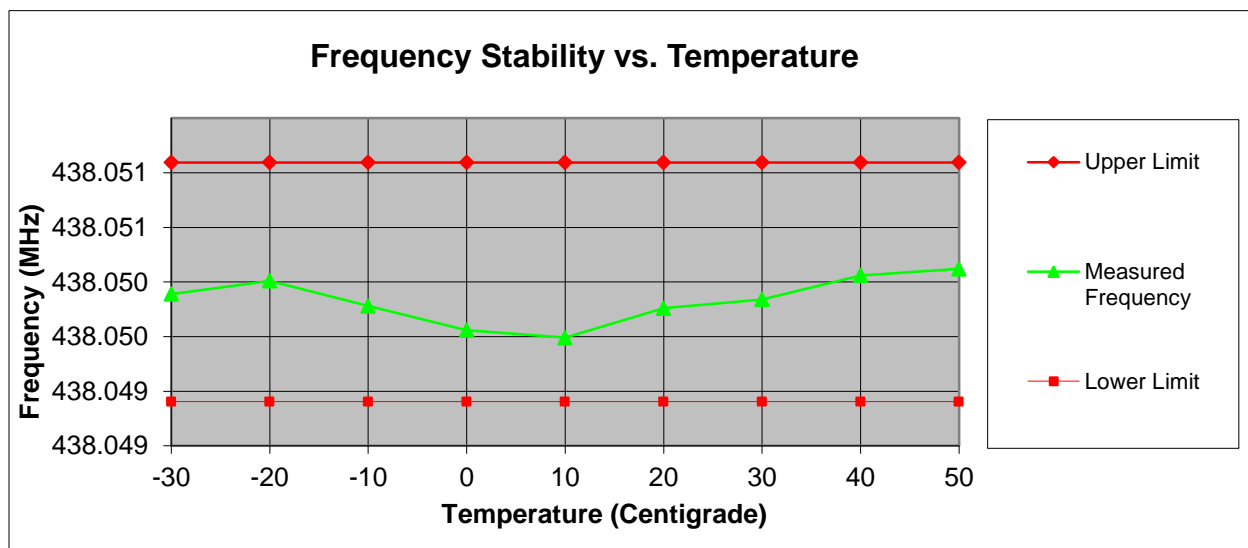

Voltage Variation

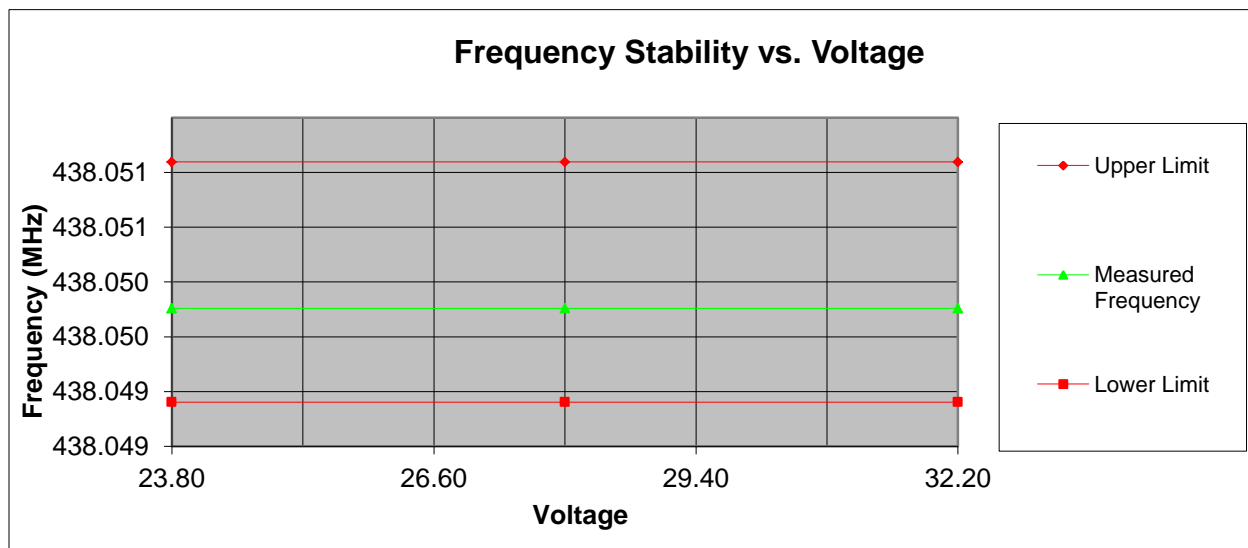



Test Results 764-806 MHz

Tuned Frequency 769.95 MHz

Limit = 1.5 PPM

Upper Limit = 769.951155

Lower Limit = 769.948845

Temperature Variation

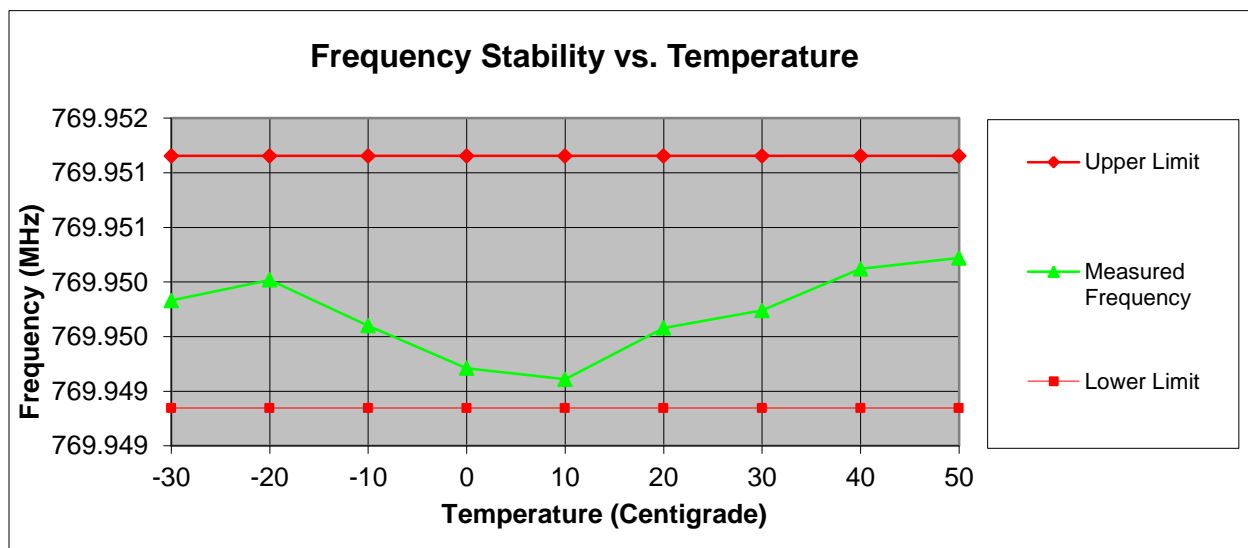

Voltage Variation

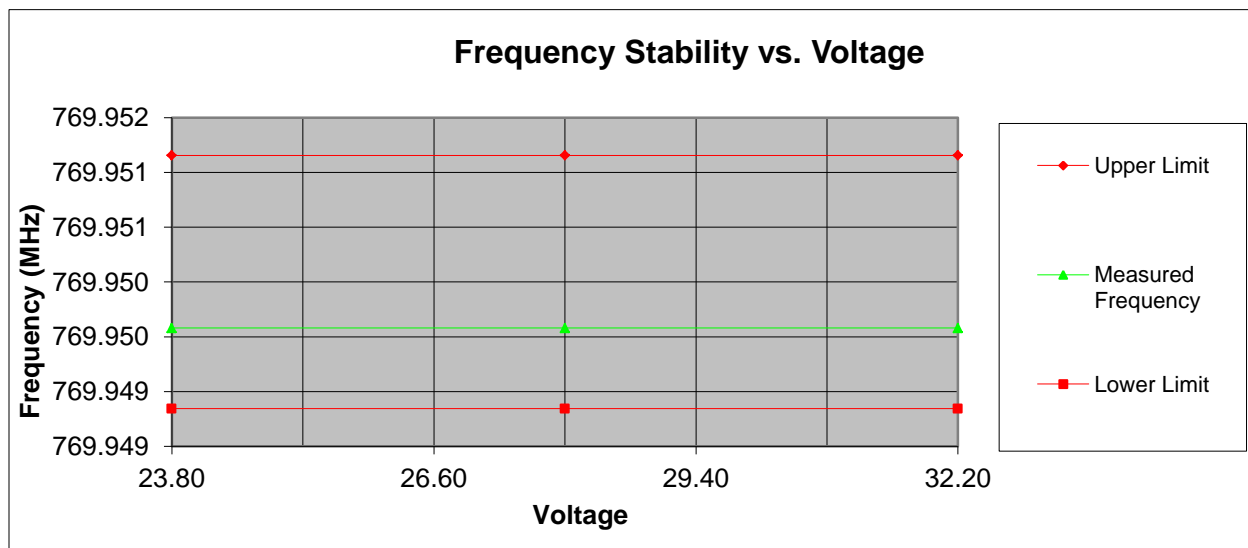



Test Results 764-806 MHz Band

Tuned Frequency 799.95 MHz

Limit = 1.5 PPM

Upper Limit = 799.951200

Lower Limit = 799.948800

Temperature Variation

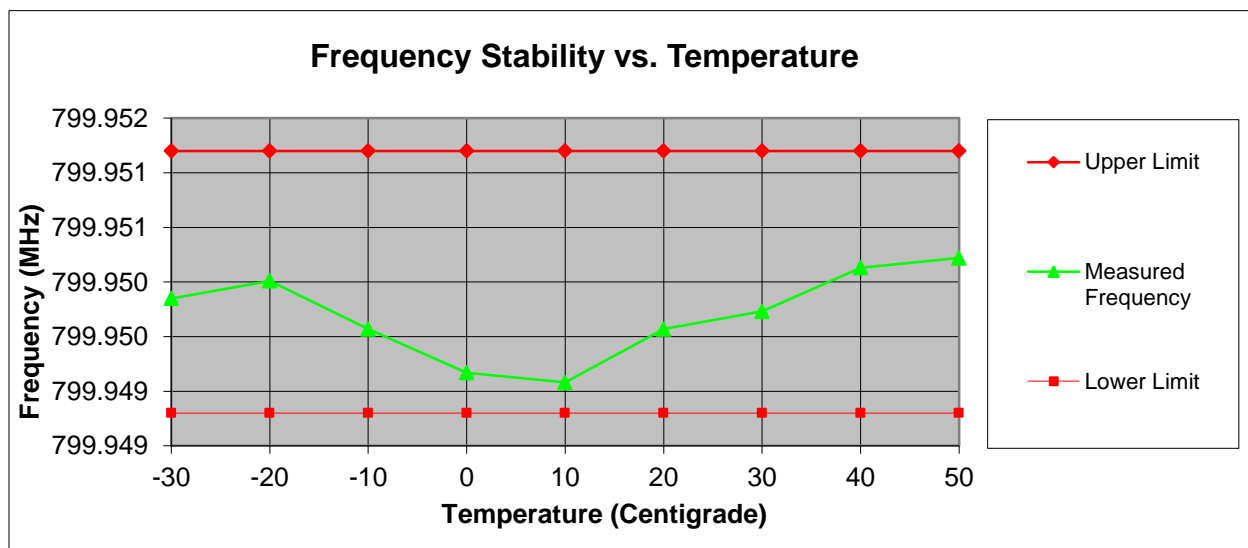

Voltage Variation

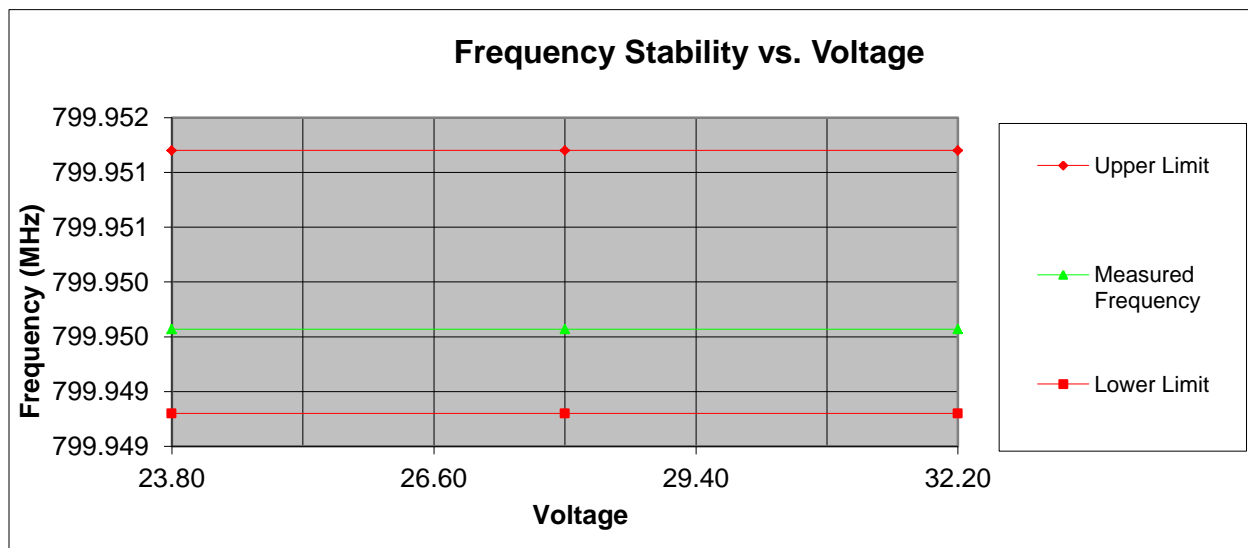



Test Results 806-960 MHz Band

Tuned Frequency 827.05 MHz

Limit = 2.5 PPM

Upper Limit = 827.052068

Lower Limit = 827.047932

Temperature Variation

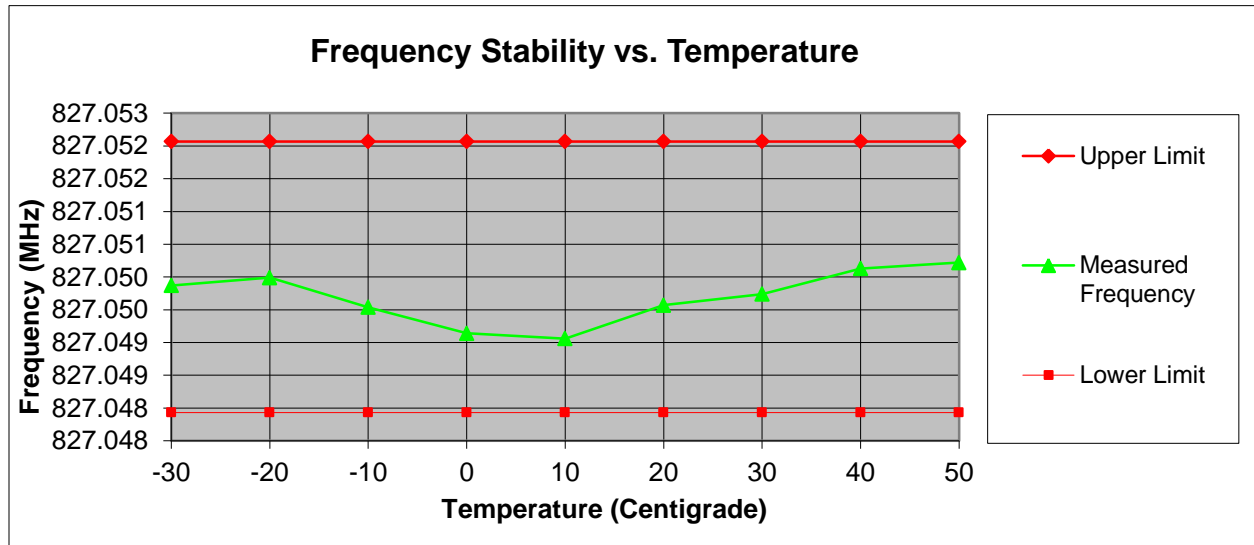

Voltage Variation

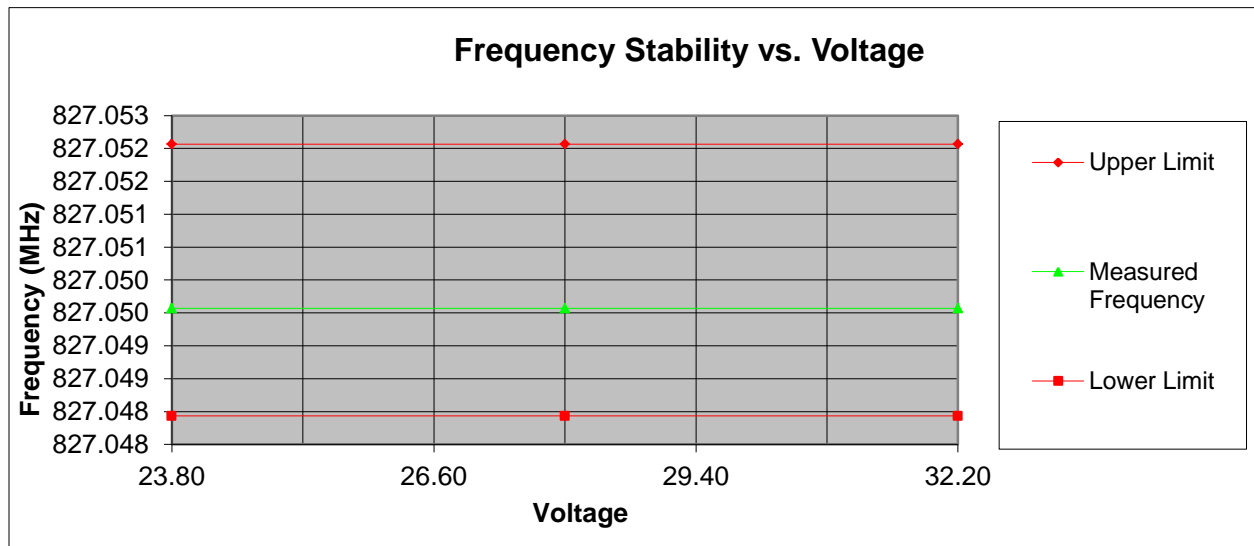



Test Results 806-960 MHz Band

Tuned Frequency 869.95 MHz

Limit = 2.5 PPM

Upper Limit = 869.952175

Lower Limit = 869.947825

Temperature Variation

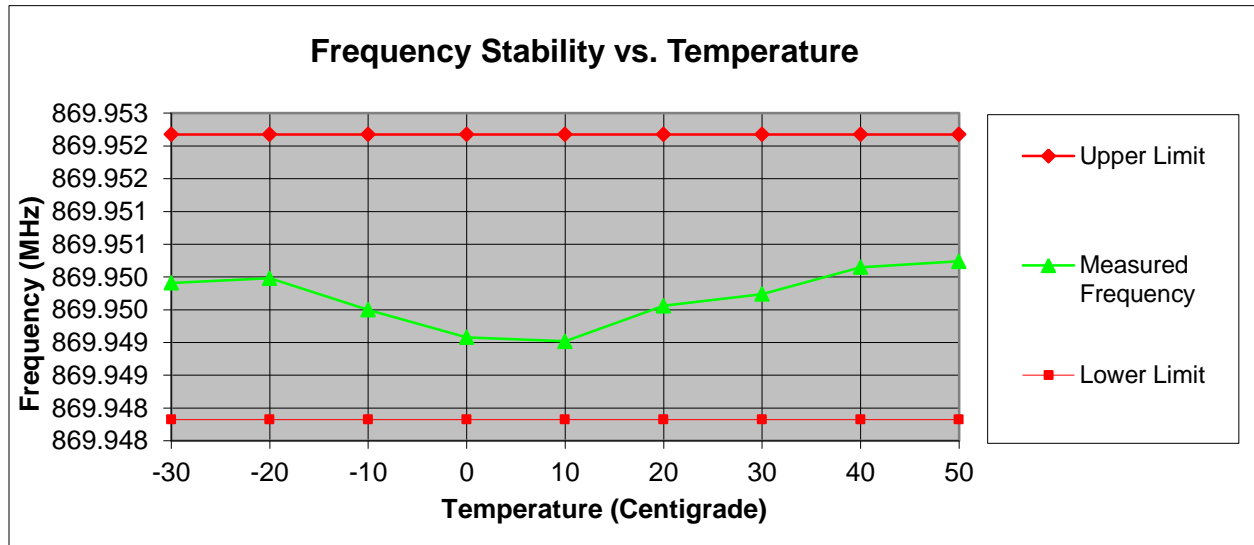

Voltage Variation

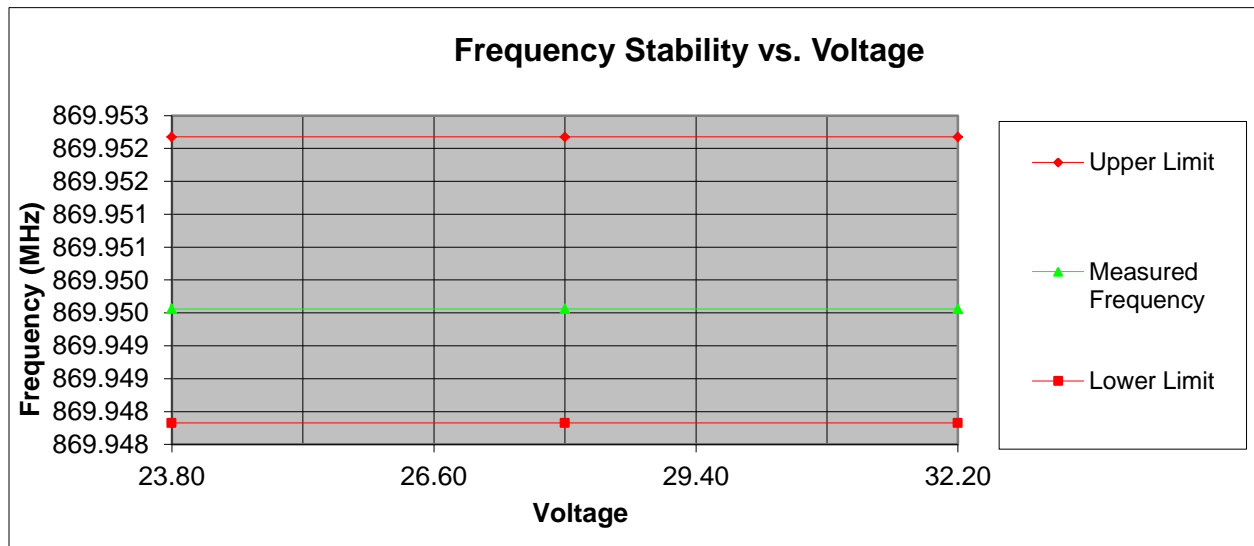



Test Results 806-960 MHz Band

Tuned Frequency 896.05 MHz

Limit = 1.5 PPM

Upper Limit = 896.051344

Lower Limit = 896.048656

Temperature Variation

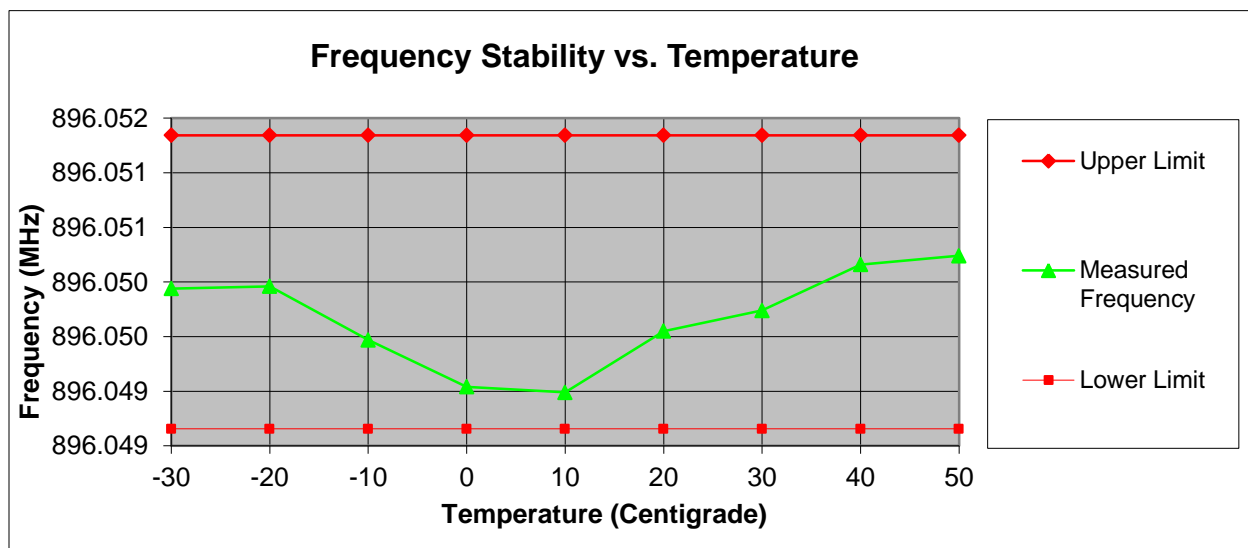

Voltage Variation

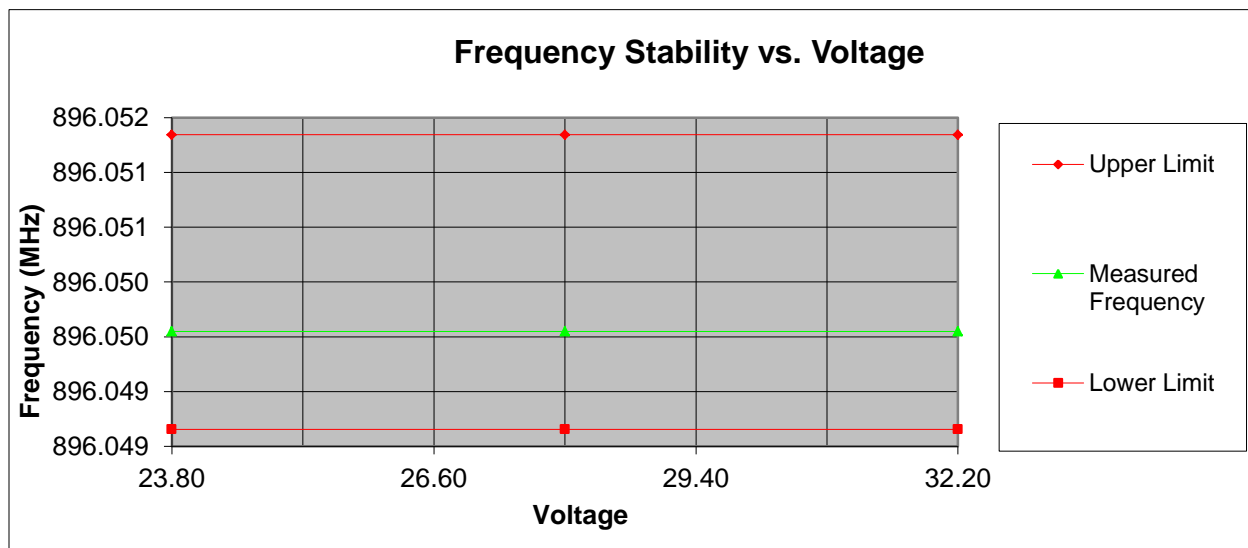



Test Results 806-960 MHz Band

Tuned Frequency 928.95 MHz

Limit = 2.5 PPM

Upper Limit = 928.952322

Lower Limit = 928.947678

Temperature Variation

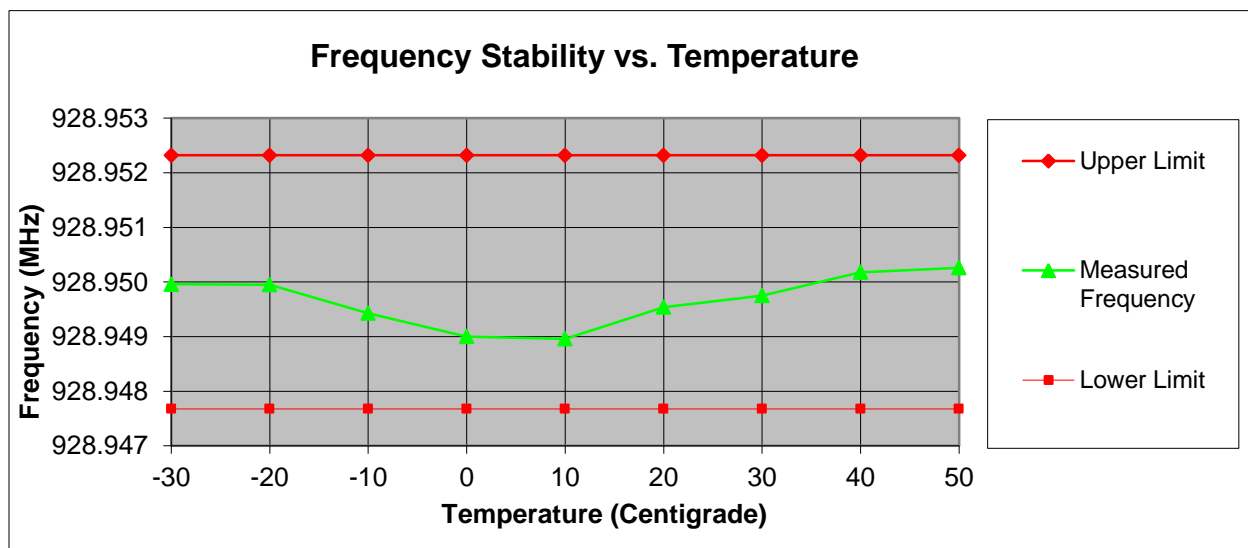

Voltage Variation

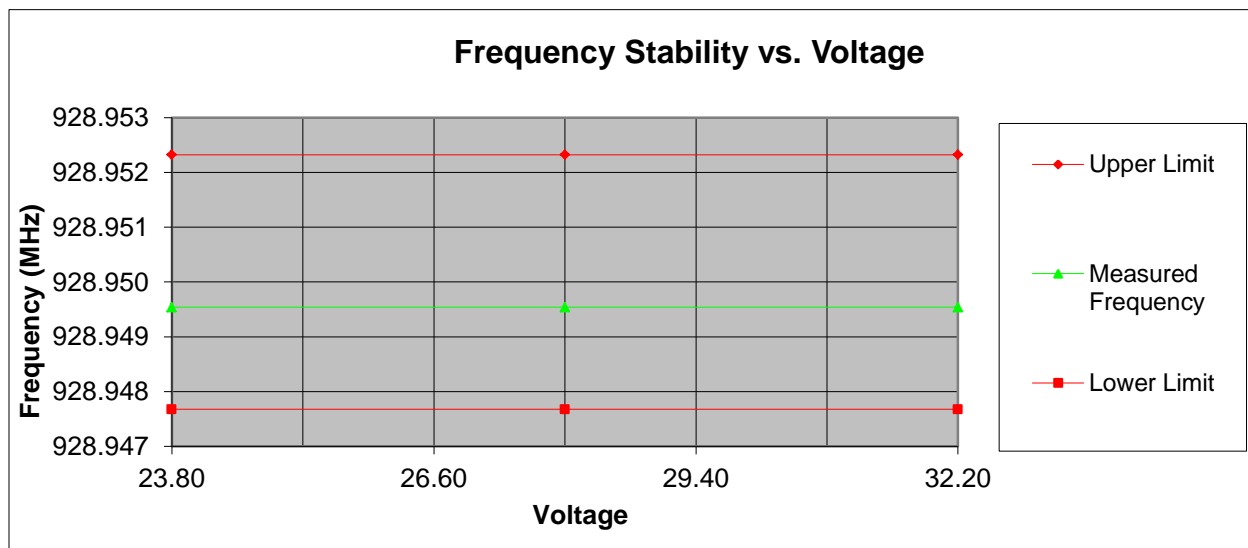



Test Results 806-960 MHz Band

Tuned Frequency 931.05 MHz

Limit = 2.5 PPM

Upper Limit = 931.052328

Lower Limit = 931.047672

Temperature Variation

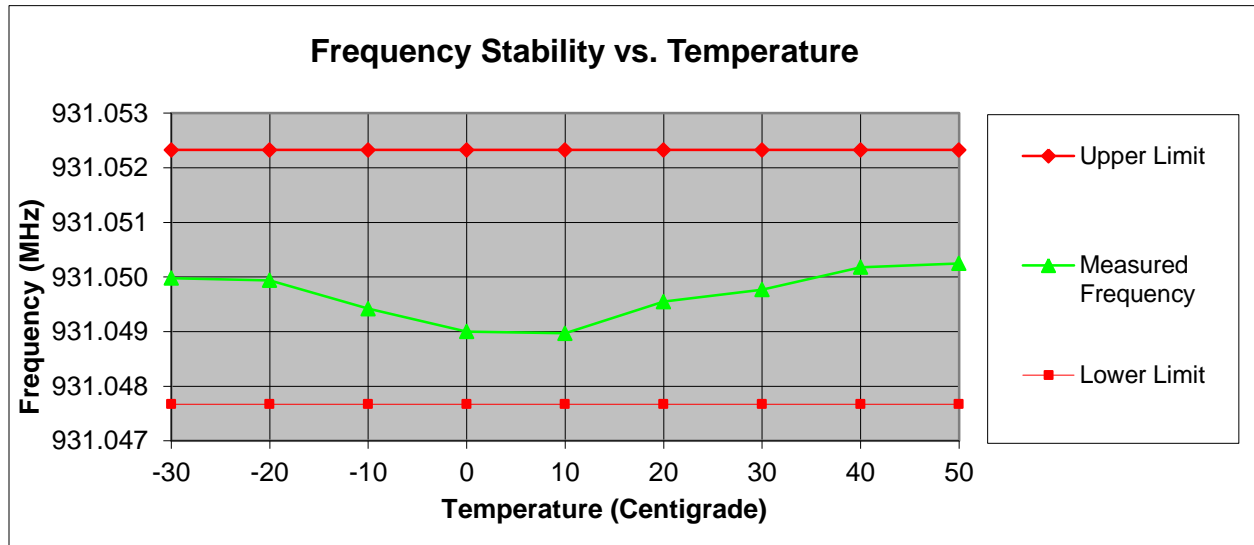

Voltage Variation

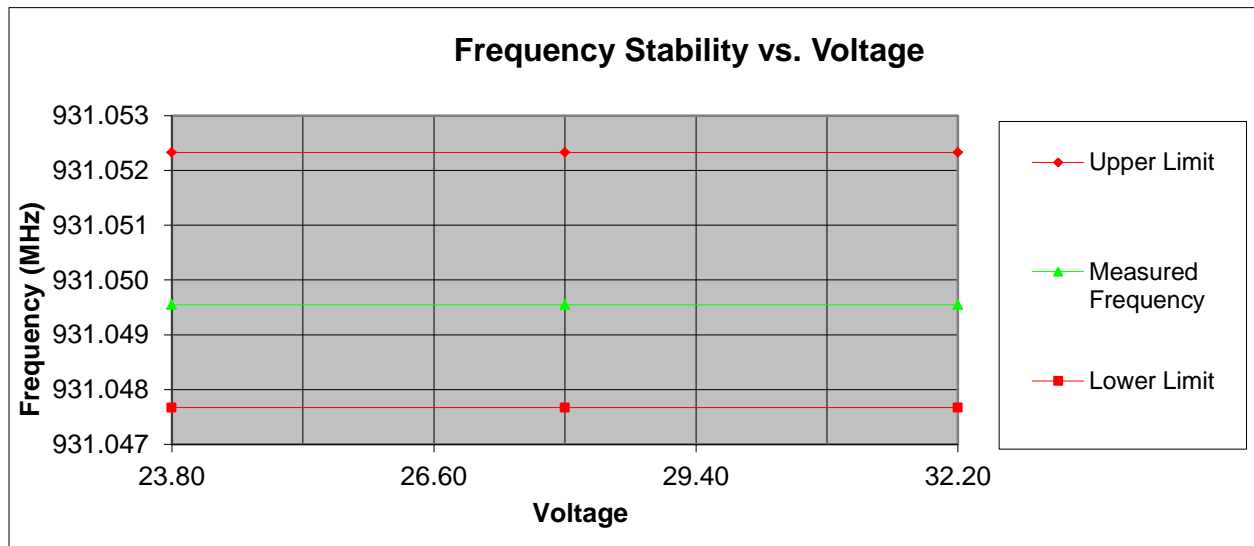



Test Results 806-960 MHz Band

Tuned Frequency 939.95 MHz

Limit = 1.5 PPM

Upper Limit = 939.951410

Lower Limit = 939.948590

Temperature Variation

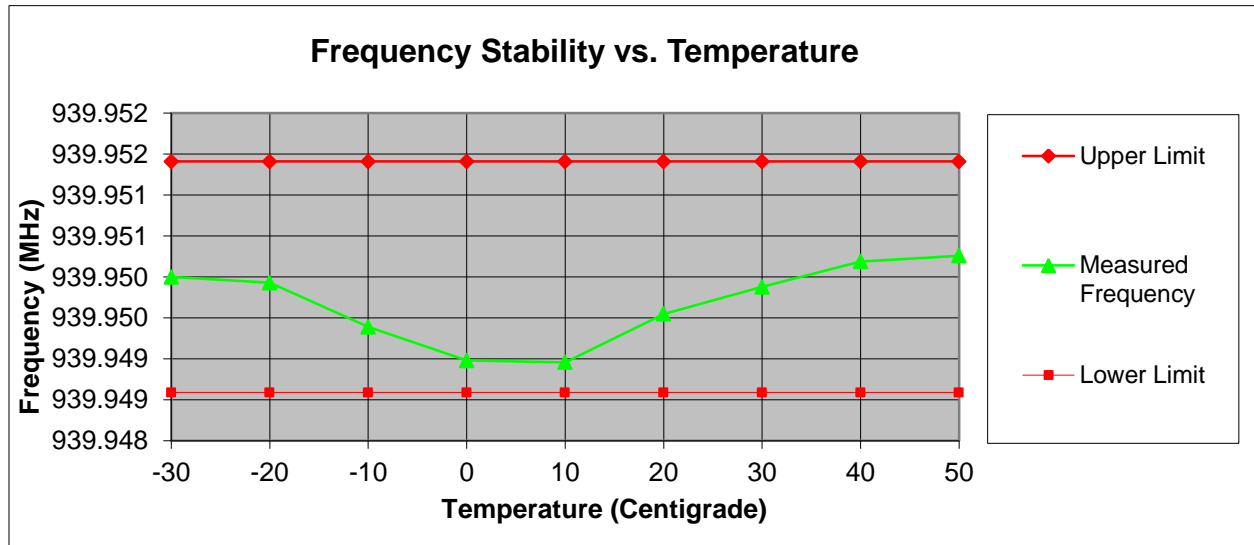

Voltage Variation

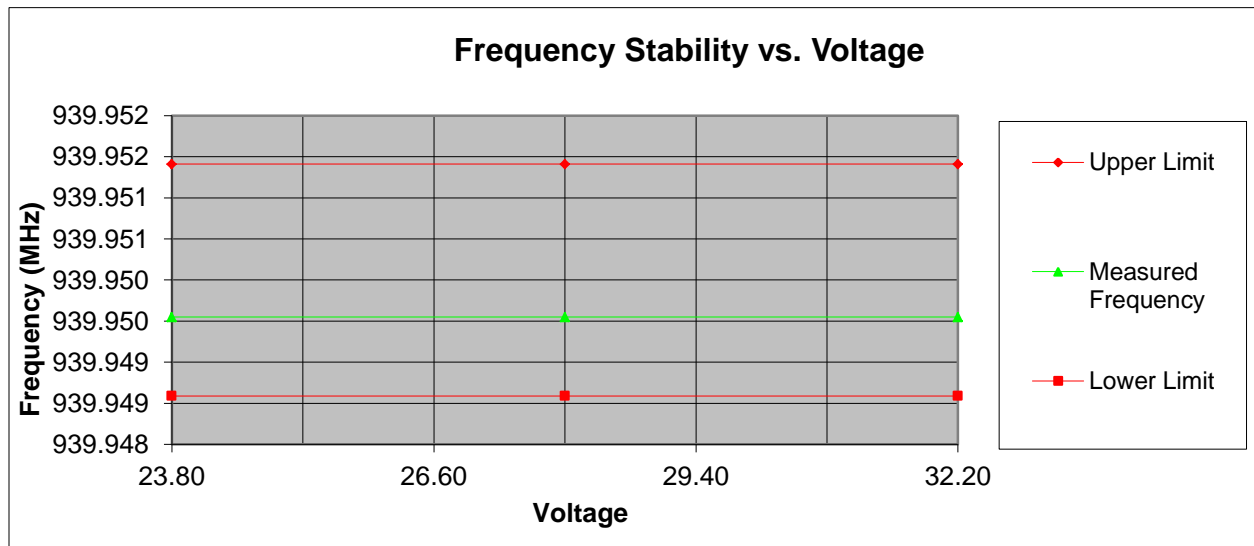



Test Results 806-960 MHz Band

Tuned Frequency 950.05 MHz

Limit = 2.5 PPM

Upper Limit = 950.052375

Lower Limit = 950.047625

Temperature Variation

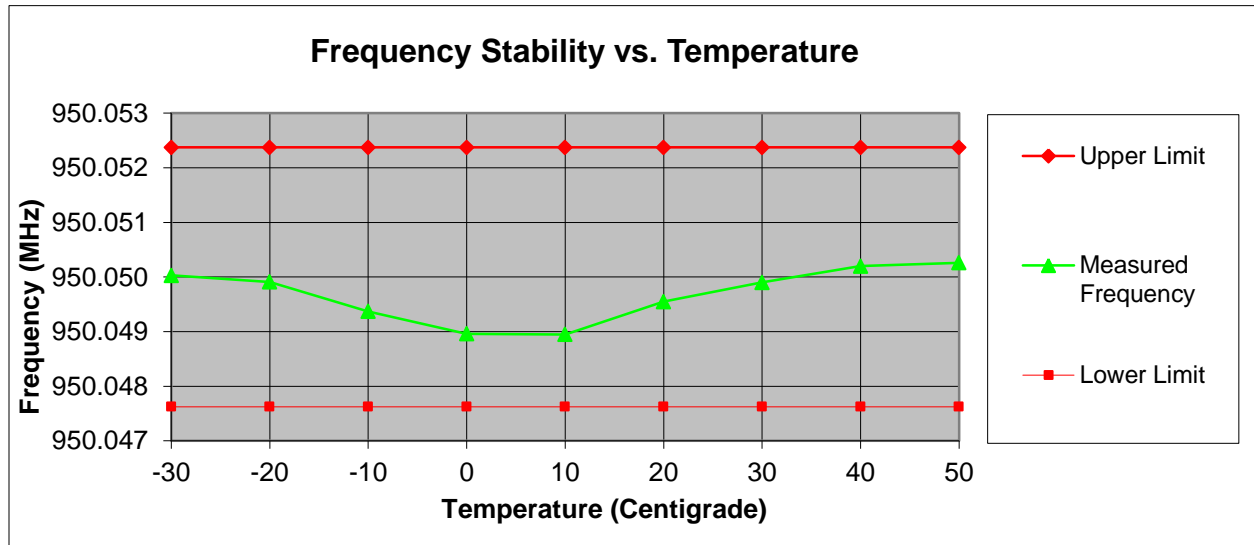

Voltage Variation

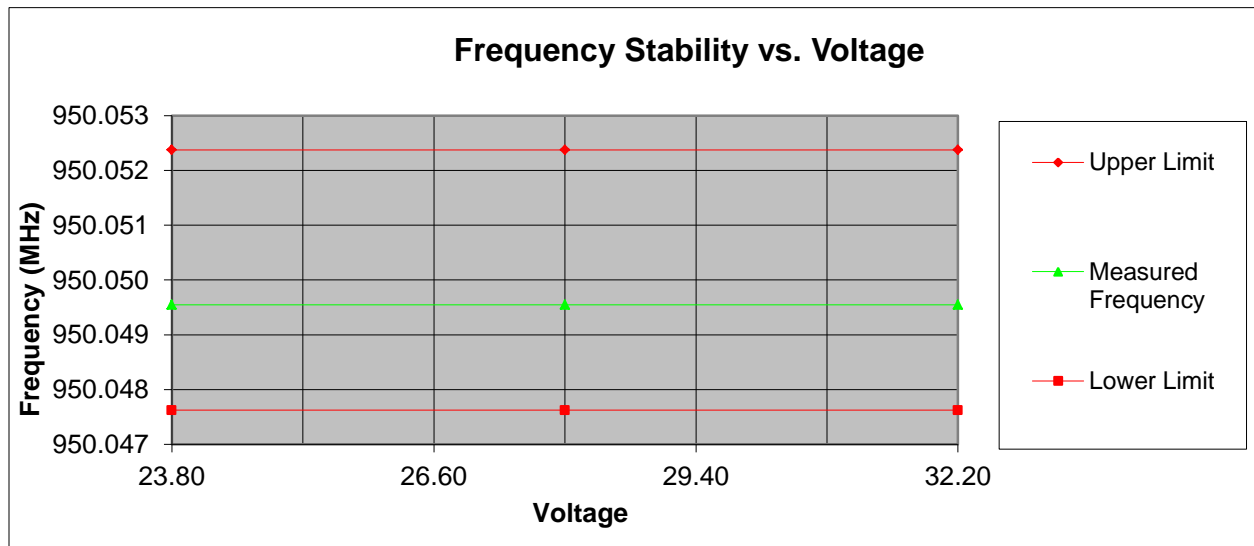



Test Results MTM 136-174 MHz Band

Tuned Frequency 161.775 MHz

Limit = 2.5 PPM

Upper Limit = 161.775404

Lower Limit = 161.774596

Temperature Variation

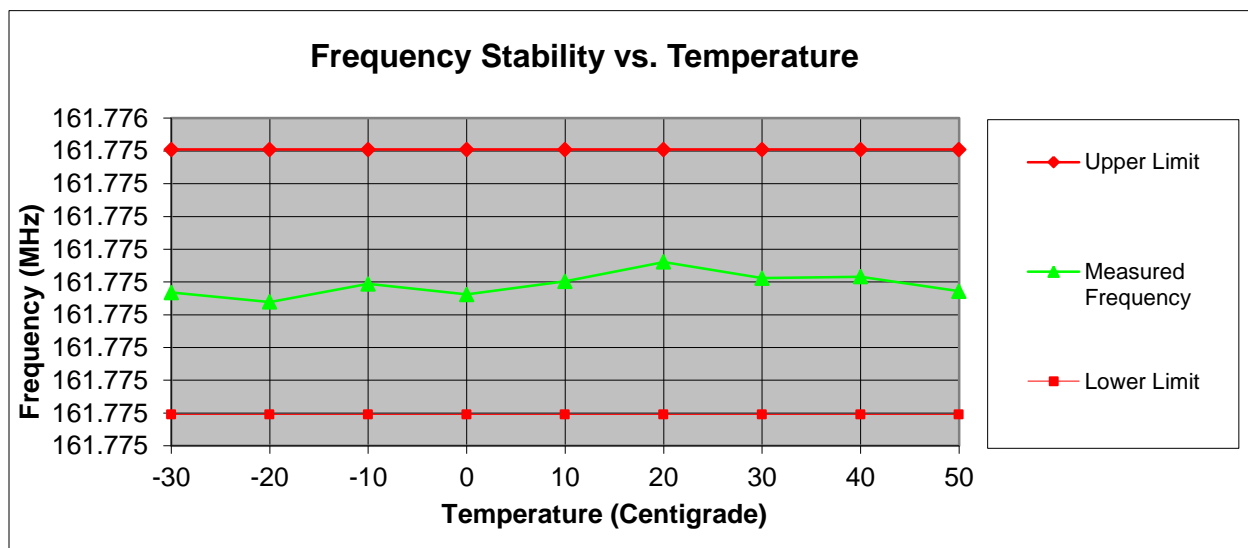

Voltage Variation

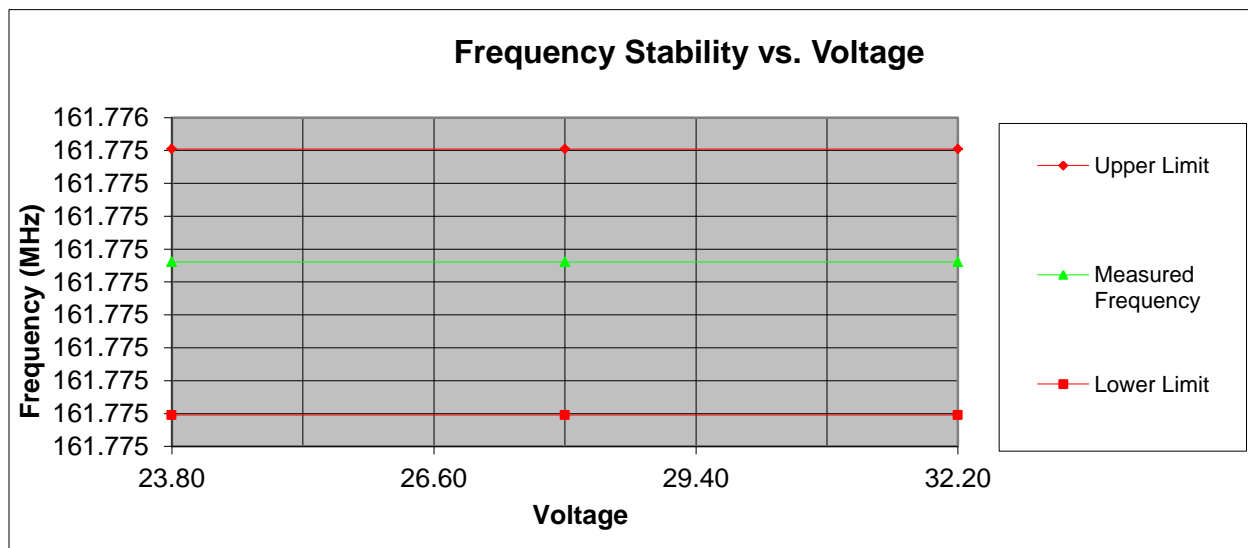



Test Results MTM 380-470 MHz Band

Tuned Frequency 438.05 MHz

Limit = 2.5 PPM

Upper Limit = 438.051095

Lower Limit = 438.048905

Temperature Variation

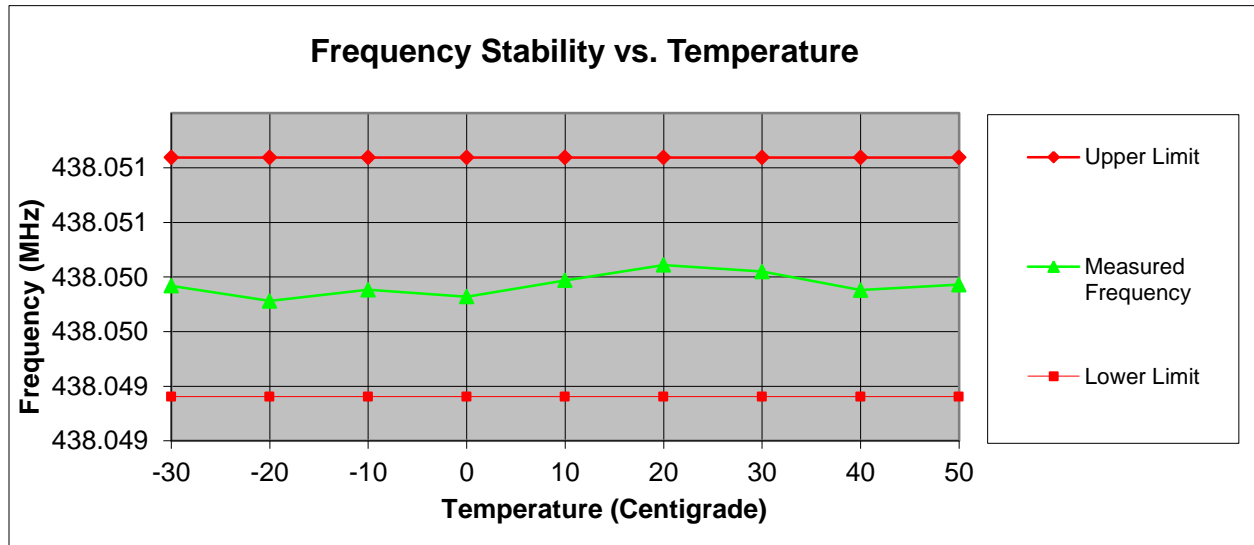

Voltage Variation

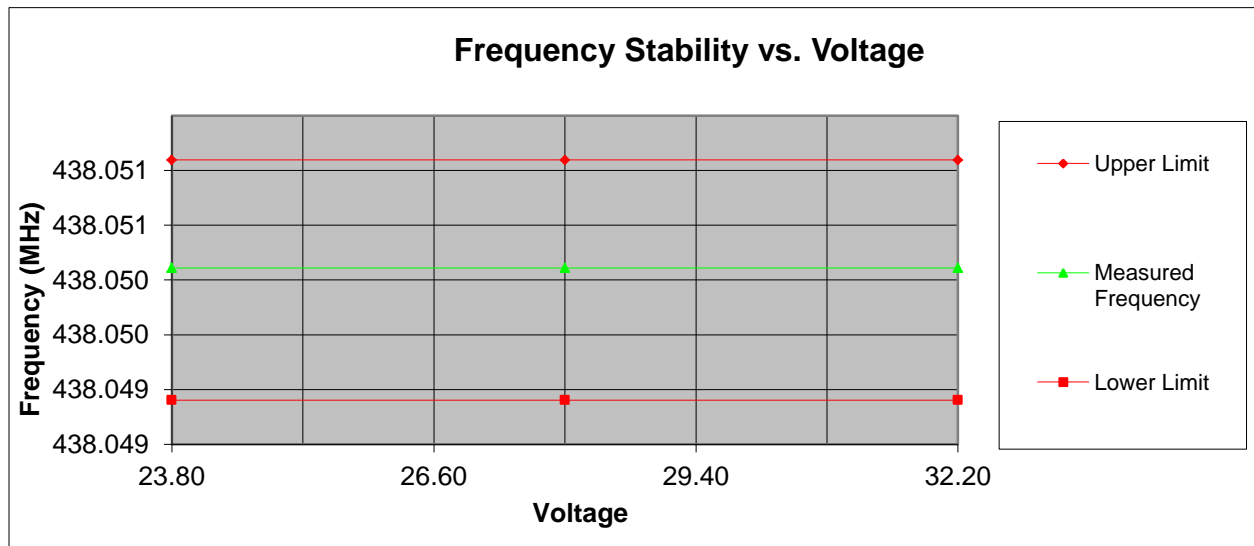



Test Results MTM 450-520 MHz Band

Tuned Frequency 470.05 MHz

Limit = 2.5 PPM

Upper Limit = 470.051175

Lower Limit = 470.048825

Temperature Variation

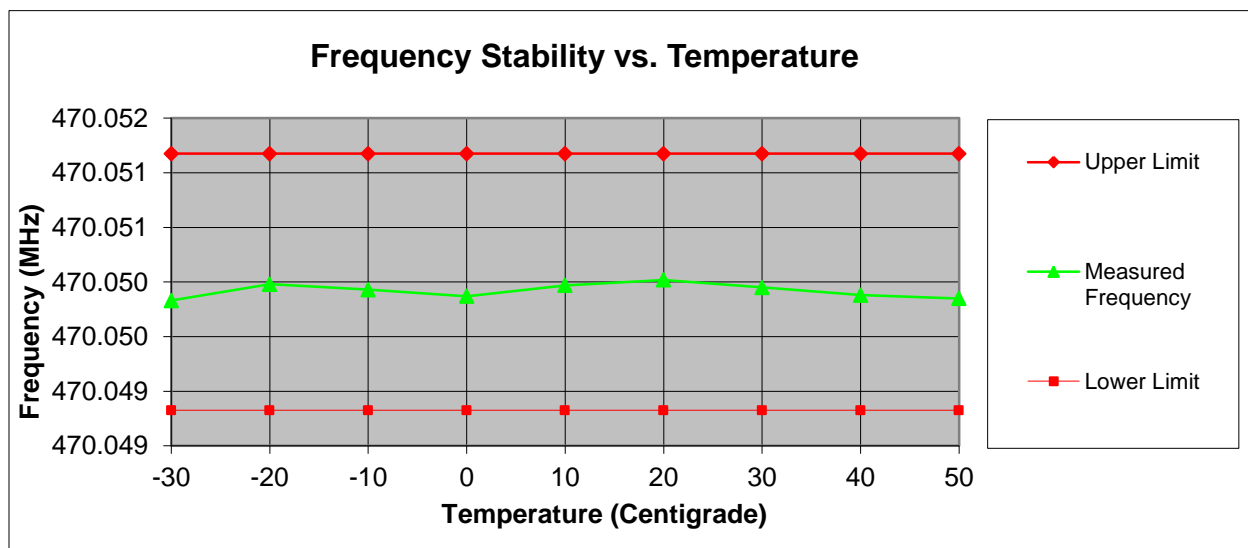

Voltage Variation

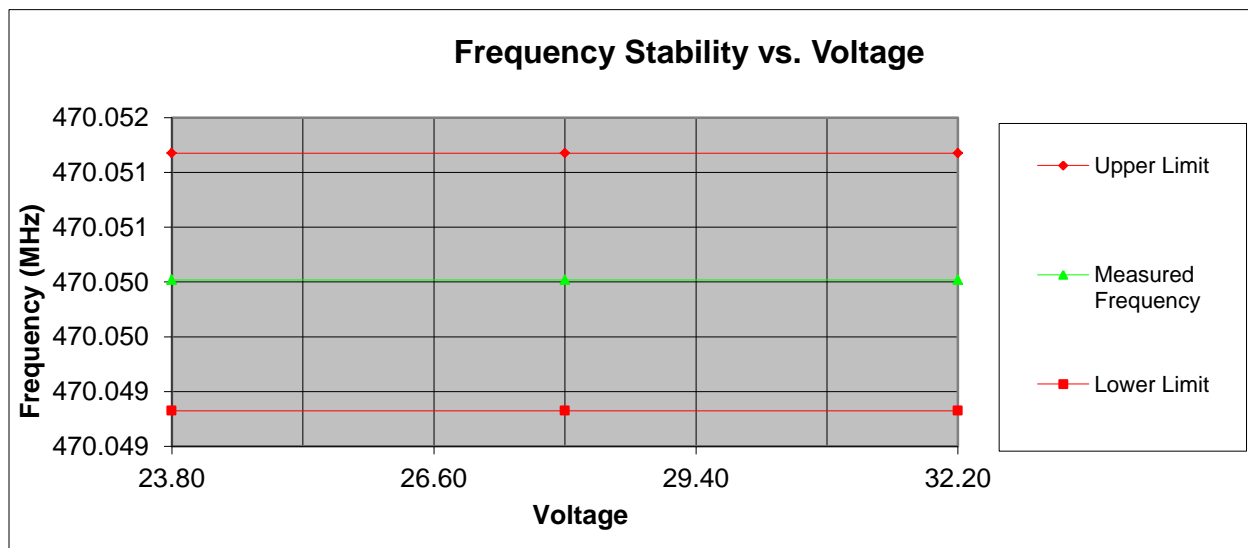



Test Results MTM 764-870 MHz Band

Tuned Frequency 769.95 MHz

Limit = 1.5 PPM

Upper Limit = 769.951155

Lower Limit = 769.948845

Temperature Variation

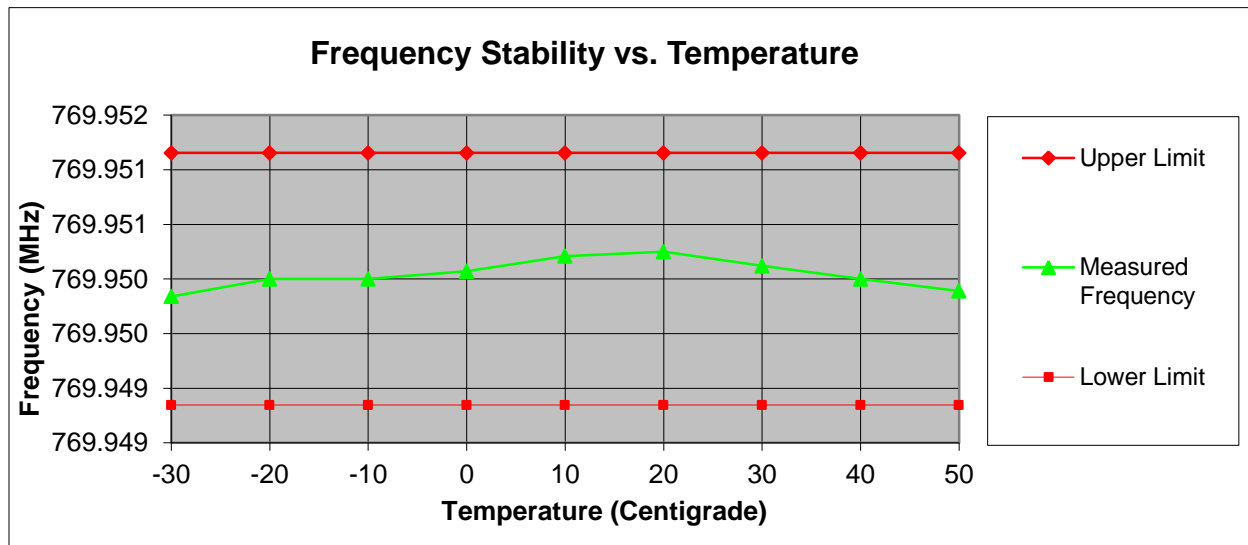

Voltage Variation

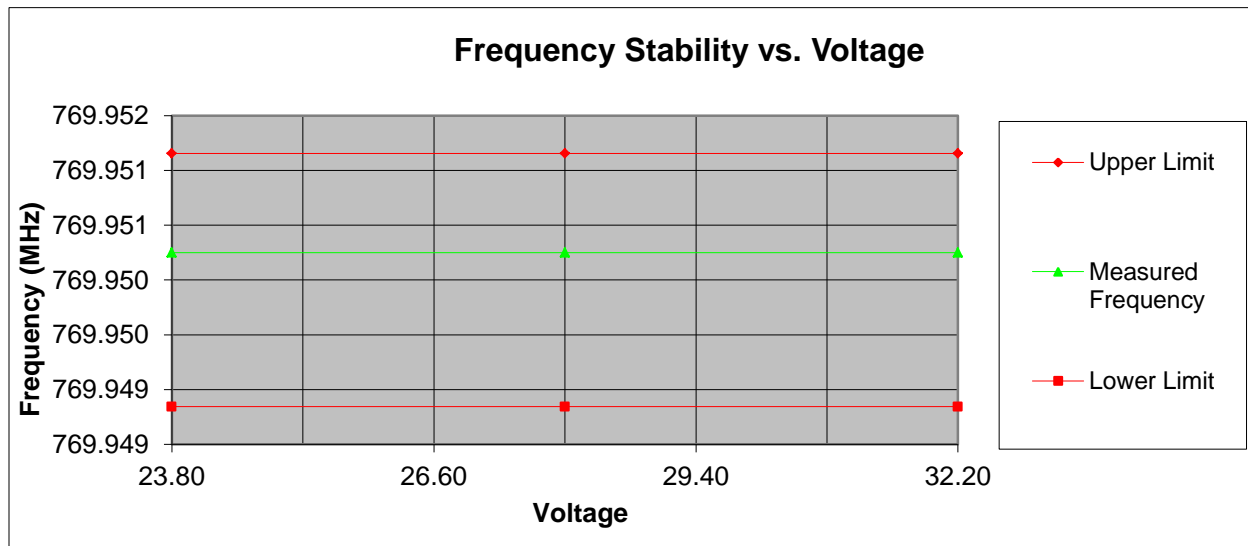



Test Results MTM 764-870 MHz Band

Tuned Frequency 854.05 MHz

Limit = 1.5 PPM

Upper Limit = 854.051281

Lower Limit = 854.048719

Temperature Variation

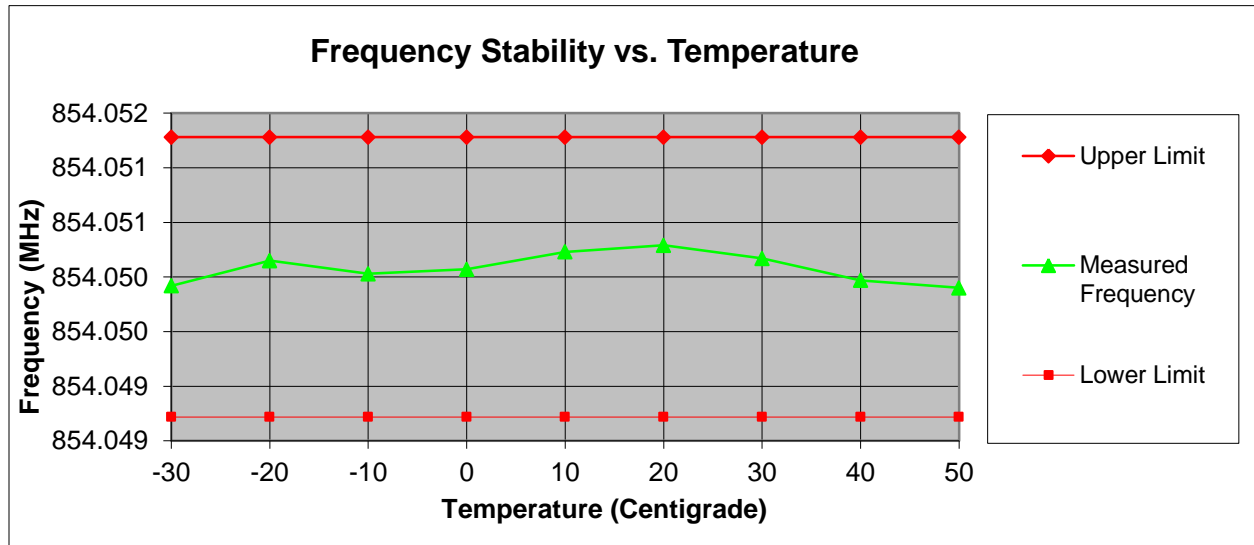

Voltage Variation

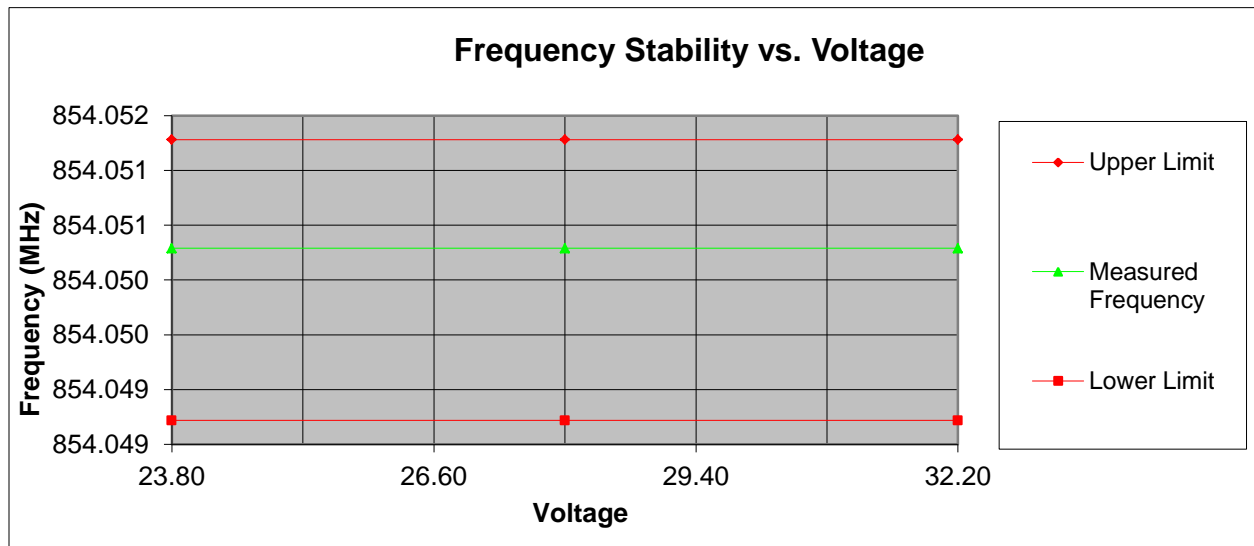



Receiver Spurious Emissions

Name of Test: Receiver Spurious Emissions

Engineer: John Erhard

Test Equipment Utilized: i00331

Test Date: 11/28/2012

Test Procedure

The EUT was connected directly to a spectrum analyzer. The cable loss was input into the analyzer as a reference level offset to ensure accurate readings.

Test Setup

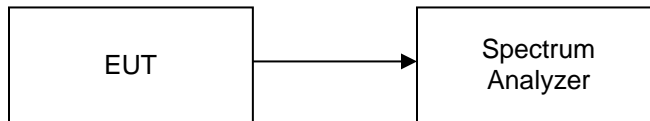

Test Results

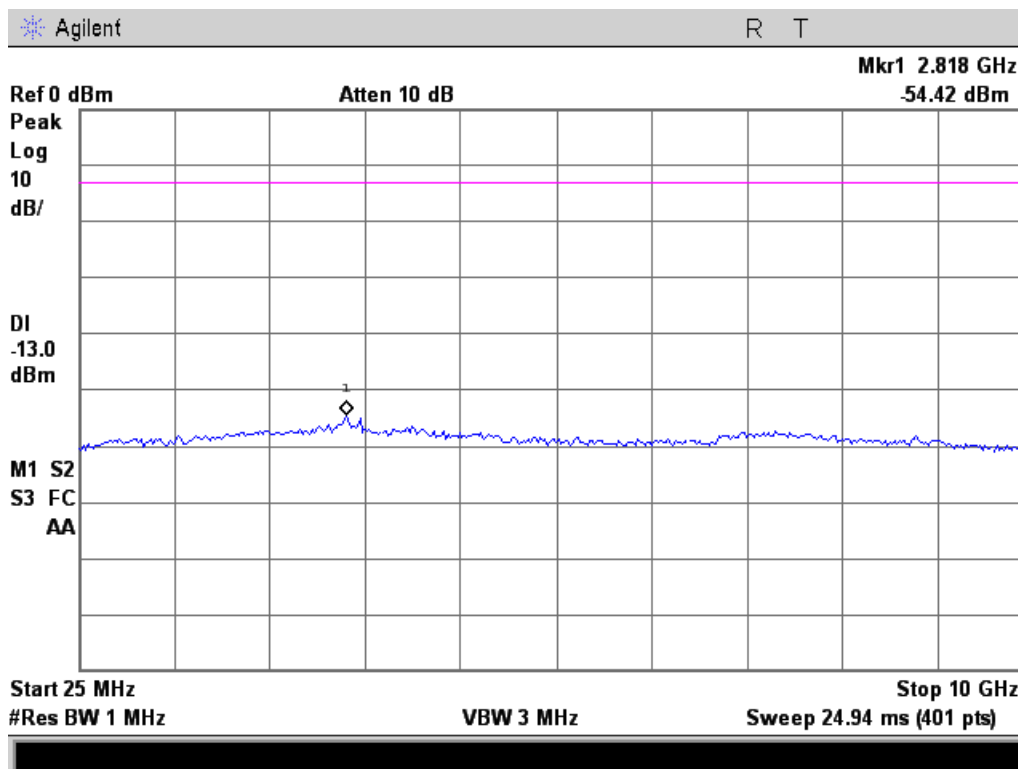



Necessary Bandwidth Calculations

Name of Test: Necessary Bandwidth Calculations

Engineer: John Erhard

Test Specification: 2.202

Test Date: 11/28/2012

Modulation = 6K00A3E		
Necessary Bandwidth Calculation:		
Modulation	=	3000
Necessary Bandwidth (B _N), kHz	=	2M
	=	6000 Hz

Modulation = 8K30F1E		
Necessary Bandwidth Calculation:		
Maximum Modulation (M), kHz	=	1.65
Maximum Deviation (D), kHz	=	2.5
Constant Factor (K)	=	1
Necessary Bandwidth (B _N), kHz	=	(2xM)+(2xDxK)
	=	8.3

Modulation = 8K30F1D		
Necessary Bandwidth Calculation:		
Data Rate (R) Kbps	=	2.3
Maximum Deviation (D), kHz	=	2.5
Necessary Bandwidth (B _N), kHz	=	2.4D+1.0R
	=	8.3

Modulation = 11K0F3E		
Necessary Bandwidth Calculation:		
Maximum Modulation (M), kHz	=	3
Maximum Deviation (D), kHz	=	2.5
Constant Factor (K)	=	1
Necessary Bandwidth (B _N), kHz	=	(2xM)+(2xDxK)
	=	11.0



Modulation = 16K0F3E (RSS-119 Only)		
Necessary Bandwidth Calculation:		
Maximum Modulation (M) kHz	=	3
Maximum Deviation (D), kHz	=	5
Constant Factor (K)	=	1
Necessary Bandwidth (B _N), kHz	=	(2xM)+(2xDxK)
	=	16.0



Test Equipment Utilized

Description	Manufacturer	Model Number	CT Asset #	Last Cal Date	Cal Due Date
Frequency Counter	HP	5334B	i00019	1/10/12	1/10/13
Temperature Chamber	Tenney	Tenney II Benchmaster	i00287	Verified on: 11/21/12	
Horn Antenna	EMCO	3115	i00103	11/5/10	11/5/12**
Function Generator	HP	33120A	i00118	Verified on: 11/16/12	
Tunable Notch Filter	Eagle	TNF-1-(250-850MHz)	i00124	Verified on: 11/16/12	
Tunable Notch Filter	Eagle	TNF-1-(100-500MHz)	i00126	Verified on: 11/16/12	
Monopole Antenna Set	Ailtech	DM-105A-T1,T2,T3	i00142, 147,148	Verified on: 11/29/12	
Power Supply	HP	6673A	i00191	Verified on: 11/16/12	
Signal Generator	Rohde & Schwarz	SMT-03	i00266	12/13/11	12/13/12
Bi-Log Antenna	Schaffner	CBL611C	i00267	12/19/11	12/19/13
Humidity / Temp Meter	Newport	IBTHX-W-5	i00282	11/5/11	11/5/12**
Voltmeter	Fluke	87III	i00319	7/3/12	7/3/13
Spectrum Analyzer	Agilent	E4407B	i00331	4/20/12	4/20/13
Data Logger	Fluke	Hydra Data Bucket	i00343	12/15/11	12/15/12
Spectrum Analyzer	Tektronix	RSA3308A	i00345	10/16/12	10/16/13
Tunable Notch Filter	Eagle	TNF-240MFMF	i00364	Verified on: 11/16/12	

In addition to the above listed equipment standard RF connectors and cables were utilized in the testing of the described equipment. Prior to testing these components were tested to verify proper operation.

**30 day extended calibration

END OF TEST REPORT