

# RADIO TEST REPORT

## FCC 47 CFR PART 15 SUBPART C (Class II Permissive Change)

<b>Test Standard</b>	<b>FCC Part 15.247</b>
<b>FCC ID</b>	<b>FKGX11BKA</b>
<b>Product name</b>	<b>WLAN and BT, 2x2 PCIe M.2 2230 adapter card</b>
<b>Brand Name</b>	<b>DURABOOK</b>
<b>Model No.</b>	<b>9260NGW</b>
<b>Test Result</b>	<b>Pass</b>

The test Result was tested by Compliance Certification Services Inc. The test data, data evaluation, test procedures, and equipment configurations shown in this report were given in ANSI C63.10: 2013 and compliance standards.

The test results of this report relate only to the tested sample (EUT) identified in this report.

The test Report of full or partial shall not copy. Without written approval of Compliance Certification Services Inc.( Wugu Laboratory)



Approved by:

A handwritten signature in black ink, appearing to read "Sam Chuang", written over a horizontal line.

Sam Chuang  
Manager

Tested by:

A handwritten signature in black ink, appearing to read "Jerry Chuang", written over a horizontal line.

Jerry Chuang  
Engineer

## Revision History

Rev.	Issue Date	Revisions	Revised By
00	March 23, 2018	Initial Issue	Doris Chu
01	May 3, 2018	<ol style="list-style-type: none"><li>1. Add Cable Connector in section 1.3 in page 5.</li><li>2. Add loop antenna in page 7.</li><li>3. Revise section 2 in page 9.</li></ol>	Doris Chu
02	May 9, 2018	<ol style="list-style-type: none"><li>1. Revise section 1.3 Antenna connector in page 5.</li></ol>	Doris Chu

---

## Table of contents

1.	GENERAL INFORMATION .....	4
1.1	EUT INFORMATION .....	4
1.2	EUT CHANNEL INFORMATION .....	5
1.3	ANTENNA INFORMATION .....	5
1.4	MEASUREMENT UNCERTAINTY.....	6
1.5	FACILITIES AND TEST LOCATION .....	7
1.6	INSTRUMENT CALIBRATION .....	7
1.7	SUPPORT AND EUT ACCESSORIES EQUIPMENT .....	8
2.	TEST SUMMERY .....	9
3.	DESCRIPTION OF TEST MODES.....	10
3.1	THE WORST MODE OF OPERATING CONDITION .....	10
3.2	THE WORST MODE OF MEASUREMENT .....	11
3.3	EUT DUTY CYCLE.....	12
4.	TEST RESULT .....	13
4.1	AC POWER LINE CONDUCTED EMISSION .....	13
4.2	OUTPUT POWER MEASUREMENT .....	16
4.3	RADIATION BANDEDGE AND SPURIOUS EMISSION .....	18
	APPENDIX 1 - PHOTOGRAPHS OF EUT	

# 1. GENERAL INFORMATION

## 1.1 EUT INFORMATION

Applicant	TWINHEAD INTERNATIONAL CORP. 11F, No. 550, Rueiguang Rd., Neihu, Taipei, Taiwan 114, R.O.C.
Manufacturer	TWINHEAD INTERNATIONAL CORP. 11F, No. 550, Rueiguang Rd., Neihu, Taipei, Taiwan 114, R.O.C.
Equipment	WLAN and BT, 2x2 PCIe M.2 2230 adapter card
Model No.	9260NGW
Model Discrepancy	All the model number was just for marketing purpose only.
Trade Name	DURABOOK
Received Date	December 21, 2017
Date of Test	March 13 ~ 30, 2018
Power Supply	Power form Adapter FSP / FSP065-REBN2 I/P: 100-240VAC, 50-60Hz, 1.5A O/P: 19VDC, 3.42A
Output Power (W)	BLE : 0.0058W
Class II Permissive Change	<p>1. The subject approved module is being used in a specific host. [Product: Fully-Rugged Tablet PC, brand name/model: DURABOOK / X11XXXXXX(X=0~9,A~Z,a~z,Blank), U11XXXXXX(X=0~9,A~Z,a~z,Blank), R11(R5)].</p> <p>2. Power reduction per tune-up procedure is applied in order to comply with exposure requirements.</p> <p>3. The product only installs a WLAN module [X11XXXXXX(X=0~9,A~Z,a~z,Blank), U11XXXXXX(X=0~9,A~Z,a~z,Blank), R11(R5)]</p>

**Remark:**

1. Client consigns only one sample to test (model number: X11BK). Therefore, the testing Lab. just guarantees the unit, which has been tested.

## 1.2 EUT CHANNEL INFORMATION

Frequency Range	2402MHz-2480MHz
Modulation Type	GFSK for BLE-1Mbps
Number of channel	40 Channels

**Remark:**

Refer as ANSI 63.10:2013 clause 5.6.1 Table 4 and RSS-GEN Table A1 for test channels

Number of frequencies to be tested		
Frequency range in which device operates	Number of frequencies	Location in frequency range of operation
<input type="checkbox"/> 1 MHz or less	1	Middle
<input type="checkbox"/> 1 MHz to 10 MHz	2	1 near top and 1 near bottom
<input checked="" type="checkbox"/> More than 10 MHz	3	1 near top, 1 near middle, and 1 near bottom

## 1.3 ANTENNA INFORMATION

Antenna Type	<input checked="" type="checkbox"/> PIFA <input type="checkbox"/> PCB <input type="checkbox"/> Dipole <input type="checkbox"/> Coils
Antenna Gain	Well Green Technology Co., Ltd P/N: 22+600763+0 (Main) / -4.08dBi 22+600764+00 (Aux) / -0.05dBi
Antenna connector	Unique antenna connector with U.FL

## 1.4 MEASUREMENT UNCERTAINTY

PARAMETER	UNCERTAINTY
AC Powerline Conducted Emission	+/- 1.2575
Emission bandwidth, 20dB bandwidth	+/- 1.4003
RF output power, conducted	+/- 1.1372
Power density, conducted	+/- 1.4003
3M Semi Anechoic Chamber / 30M~200M	+/- 4.0138
3M Semi Anechoic Chamber / 200M~1000M	+/- 3.9483
3M Semi Anechoic Chamber / 1G~8G	+/- 2.5975
3M Semi Anechoic Chamber / 8G~18G	+/- 2.6112
3M Semi Anechoic Chamber / 18G~26G	+/- 2.7389
3M Semi Anechoic Chamber / 26G~40G	+/- 2.9683
3M Semi Anechoic Chamber / 40G~60G	+/- 1.8509
3M Semi Anechoic Chamber / 60G~75G	+/- 1.9869
3M Semi Anechoic Chamber / 75G~110G	+/- 2.9651
3M Semi Anechoic Chamber / 110G~170G	+/- 2.7807
3M Semi Anechoic Chamber / 170G~220G	+/- 3.6437
3M Semi Anechoic Chamber / 220G~325G	+/- 4.2982

**Remark:**

1. This uncertainty represents an expanded uncertainty expressed at approximately the 95% confidence level using a coverage factor of  $k=2$
2. ISO/IEC 17025 requires that an estimate of the measurement uncertainties associated with the emissions test results be included in the report.

## 1.5 FACILITIES AND TEST LOCATION

All measurement facilities used to collect the measurement data are located at  
 No.11, Wugong 6th Rd., Wugu Dist., New Taipei City 24891, Taiwan. (R.O.C.)

Test site	Test Engineer	Remark
Radiation	Jerry Chuang	

**Remark:** The sites are constructed in conformance with the requirements of ANSI C63.7, ANSI C63.4 and CISPR Publication 22.

## 1.6 INSTRUMENT CALIBRATION

Wugu 966 Chamber A					
Name of Equipment	Manufacturer	Model	Serial Number	Calibration Date	Calibration Due
Bilog Antenna	Sunol Sciences	JB3	A030105	06/20/2017	06/19/2018
Horn Antenna	ETC	MCTD 1209	DRH13M02003	08/25/2017	08/24/2018
Pre-Amplifier	EMEC	EM330	60609	06/07/2017	06/06/2018
Spectrum Analyzer	Agilent	E4446A	US42510252	11/27/2017	11/26/2018
Loop Ant	COM-POWER	AL-130	121051	03/21/2018	03/20/2019
Antenna Tower	CCS	CC-A-1F	N/A	N.C.R	N.C.R
Controller	CCS	CC-C-1F	N/A	N.C.R	N.C.R
Turn Table	CCS	CC-T-1F	N/A	N.C.R	N.C.R
Pre-Amplifier	HP	8449B	3008A00965	06/27/2017	06/26/2018
Filter	N/A	2400-2500	N/A	N/A	N/A
Filter	N/A	0-6000	N/A	N/A	N/A
Cable	HUBER SUHNER	SUCOFLEX 104PEA	25157	07/31/2017	07/30/2018
Cable	HUBER SUHNER	SUCOFLEX 104PEA	20995	07/31/2017	07/30/2018

AC Conducted Emissions Test Site					
Name of Equipment	Manufacturer	Model	Serial Number	Calibration Date	Calibration Due
LISN	R&S	ENV216	101054	05/18/2017	05/17/2018
LISN	SCHWARZBECK	NSLK 8127	8127-541	02/14/2018	02/13/2019
EMI Test Receiver	R&S	ESCI	100064	05/17/2017	05/16/2018

**Remark:** Each piece of equipment is scheduled for calibration once a year.

## 1.7 SUPPORT AND EUT ACCESSORIES EQUIPMENT

EUT Accessories Equipment					
No.	Equipment	Brand	Model	Series No.	FCC ID
	N/A				

Support Equipment					
No.	Equipment	Brand	Model	Series No.	FCC ID
	N/A				

## 1.8 Test methodology and applied standards

The test methodology, setups and results comply with all requirements in accordance with ANSI C63.10:2013, FCC Part 2, FCC Part 15.247, KDB 558074 D01 v04.



## 2. TEST SUMMERY

<b>FCC Standard Section</b>	<b>Report Section</b>	<b>Test Item</b>	<b>Result</b>
15.203	1.3	Antenna Requirement	Pass
15.207(a)	4.1	AC Conducted Emission	-
15.247(b)	4.2	Output Power Measurement	Pass
15.247(d)	4.3	Radiation Band Edge	Pass
15.247(d)	4.3	Radiation Spurious Emission	Pass

### 3. DESCRIPTION OF TEST MODES

#### 3.1 THE WORST MODE OF OPERATING CONDITION

Operation mode	BT4.0 Mode (1Mbps)
Test Channel Frequencies	1.Lowest Channel : 2402MHz 2.Middle Channel : 2440MHz 3.Highest Channel : 2480MHz

*Remark:*

1. EUT pre-scanned data rate of output power for each mode, the worst data rate were recorded in this report.

.

### 3.2 THE WORST MODE OF MEASUREMENT

Radiated Emission Measurement Above 1G	
Test Condition	Band edge, Emission for Unwanted and Fundamental
Voltage/Hz	120V/60Hz
Test Mode	Mode 1:EUT power by AC adapter via power cable.
Worst Mode	<input checked="" type="checkbox"/> Mode 1 <input type="checkbox"/> Mode 2 <input type="checkbox"/> Mode 3 <input type="checkbox"/> Mode 4
Worst Position	<input type="checkbox"/> Placed in fixed position. <input type="checkbox"/> Placed in fixed position at X-Plane (E2-Plane) <input type="checkbox"/> Placed in fixed position at Y-Plane (E1-Plane) <input checked="" type="checkbox"/> Placed in fixed position at Z-Plane (H-Plane)
Worst Polarity	<input checked="" type="checkbox"/> Horizontal <input type="checkbox"/> Vertical

Radiated Emission Measurement Below 1G	
Test Condition	Radiated Emission Below 1G
Voltage/Hz	120V/60Hz
Test Mode	Mode 1:EUT power by AC adapter via power cable.
Worst Mode	<input checked="" type="checkbox"/> Mode 1 <input type="checkbox"/> Mode 2 <input type="checkbox"/> Mode 3 <input type="checkbox"/> Mode 4

*Remark:*

1. The worst mode was record in this test report.
2. EUT pre-scanned in three axis ,X, Y, Z and two polarity, Horizontal and Vertical for radiated measurement. The worst case(Z-Plane and Horizontal) were recorded in this report
3. For below 1G, AC power line conducted emission and radiation emission were performed the EUT transmit at the highest output power channel as worse case.

### 3.3 EUT DUTY CYCLE

Duty Cycle				
Configuration	TX ON (ms)	TX ALL (ms)	Duty Cycle (%)	Duty Factor(dB)
BLE	0.4800	0.6200	77.42%	1.11

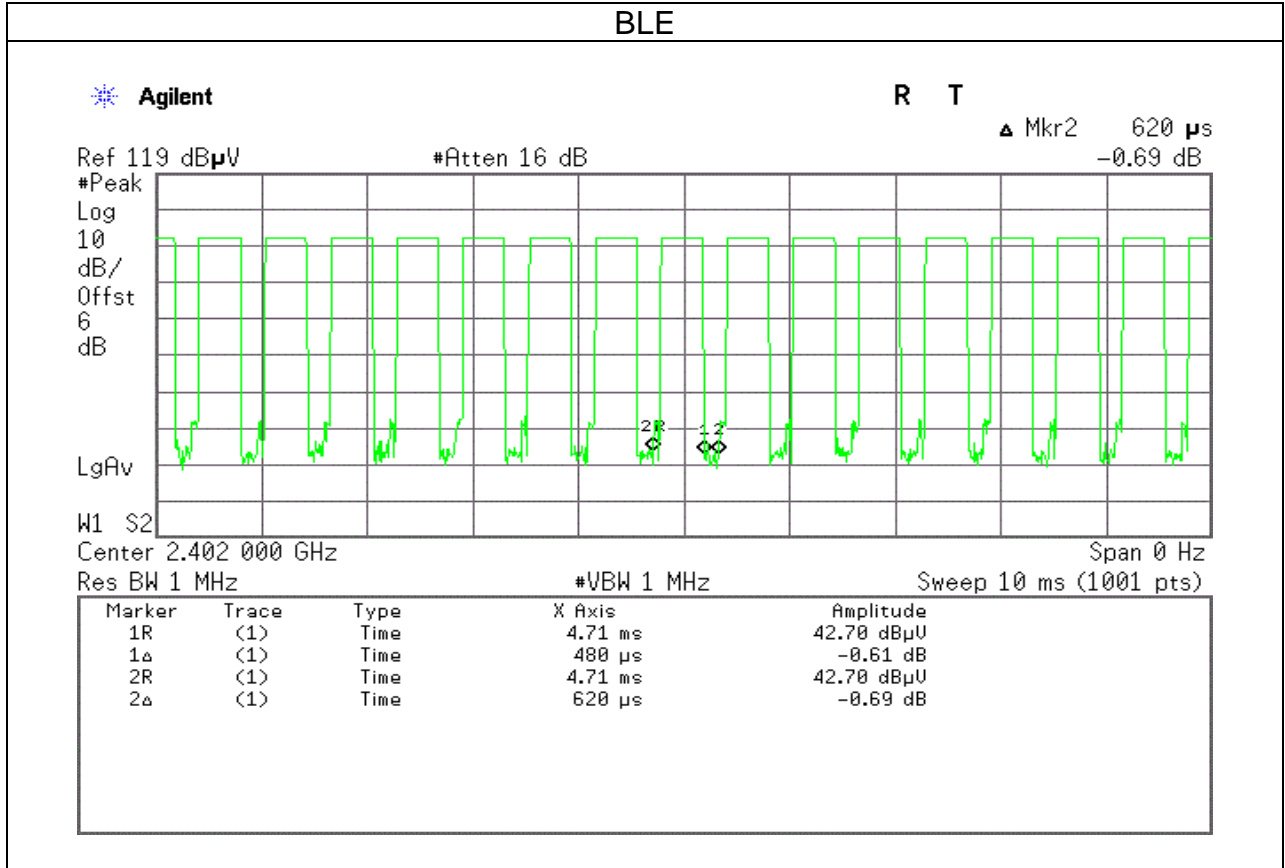

## 4. TEST RESULT

### 4.1 AC POWER LINE CONDUCTED EMISSION

#### 4.1.1 Test Limit

According to §15.207(a)(2)

Frequency Range (MHz)	Limits(dBμV)	
	Quasi-peak	Average
0.15 to 0.50	66 to 56*	56 to 46*
0.50 to 5	56	46
5 to 30	60	50

\* Decreases with the logarithm of the frequency.

#### 4.1.2 Test Procedure

Test method Refer as ANSI 63.10:2013 clause 6.2,

1. The EUT was placed on a non-conducted table, which is 0.8m above horizontal ground plane and 0.4m above vertical ground plane.
2. EUT connected to the line impedance stabilization network (LISN)
3. Receiver set RBW of 9kHz and Detector Peak, and note as quasi-peak and average.
4. Maximum procedure was performed on the six highest emissions to ensure EUT compliance.
5. Recorded Line for Neutral and Line.

#### 4.1.3 Test Setup

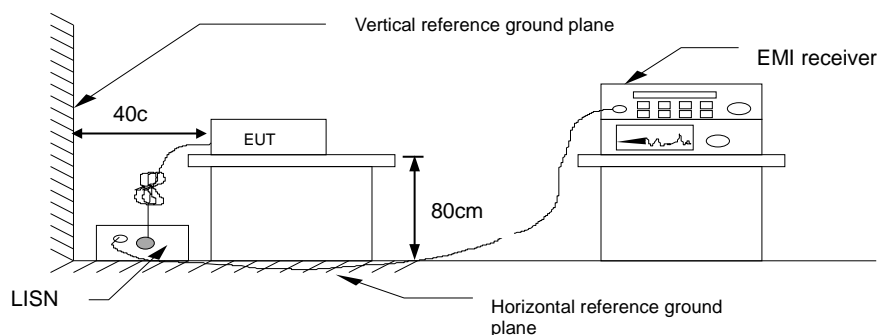

#### 4.1.4 Test Result

**Pass.**

**Test Data**

Test Mode:	Mode 1	Temp/Hum	24(°C)/ 50%RH
Test Voltage:	120Vac / 60Hz	Test Date	March 30, 2018
Phase:	Line	Test Engineer	Dally Hong

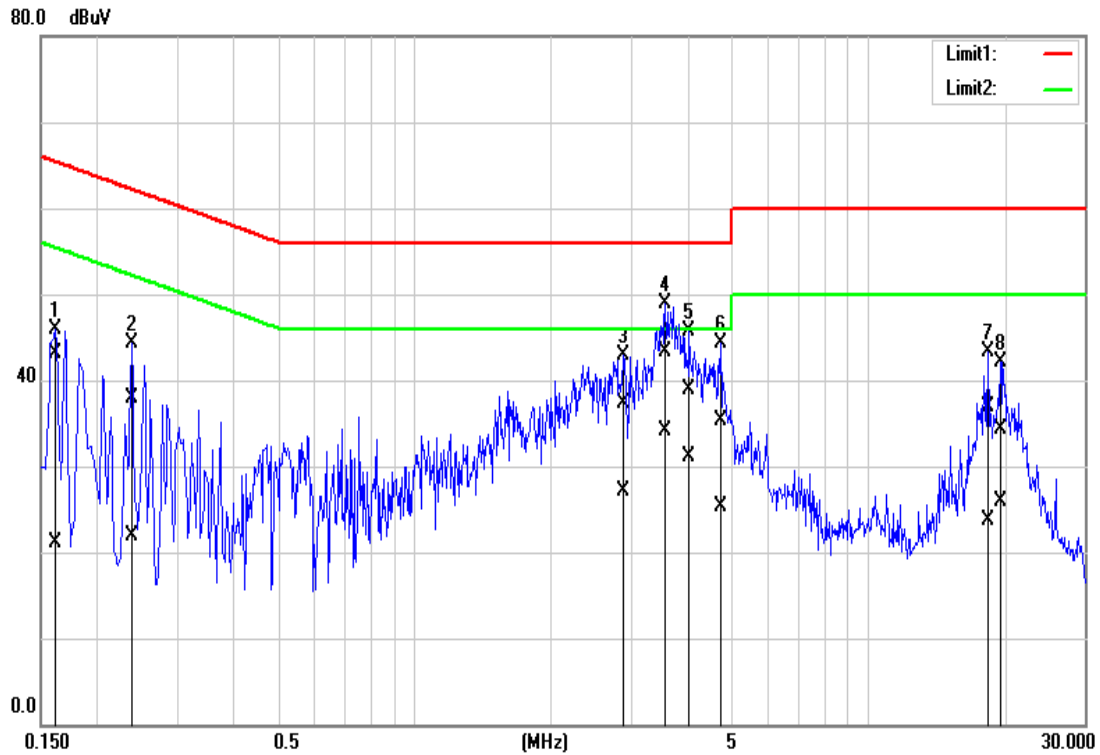

No.	Frequency (MHz)	QuasiPeak reading (dBuV)	Average reading (dBuV)	Correction factor (dB)	QuasiPeak result (dBuV)	Average result (dBuV)	QuasiPeak limit (dBuV)	Average limit (dBuV)	QuasiPeak margin (dB)	Average margin (dB)
1	0.1620	33.53	11.54	9.66	43.19	21.20	65.36	55.36	-22.17	-34.16
2	0.2380	28.17	12.22	9.67	37.84	21.89	62.16	52.17	-24.32	-30.28
3	2.8940	27.56	17.32	9.73	37.29	27.05	56.00	46.00	-18.71	-18.95
4	3.5660	33.60	24.31	9.75	43.35	34.06	56.00	46.00	-12.65	-11.94
5	4.0300	29.17	21.41	9.75	38.92	31.16	56.00	46.00	-17.08	-14.84
6	4.7220	25.52	15.62	9.77	35.29	25.39	56.00	46.00	-20.71	-20.61
7	18.3540	26.93	13.80	9.99	36.92	23.79	60.00	50.00	-23.08	-26.21
8	19.5820	24.29	15.83	10.01	34.30	25.84	60.00	50.00	-25.70	-24.16

Test Mode:	Mode 1	Temp/Hum	24(°C)/ 50%RH
Test Voltage:	120Vac / 60Hz	Test Date	March 30, 2018
Phase:	Neutral	Test Engineer	Dally Hong

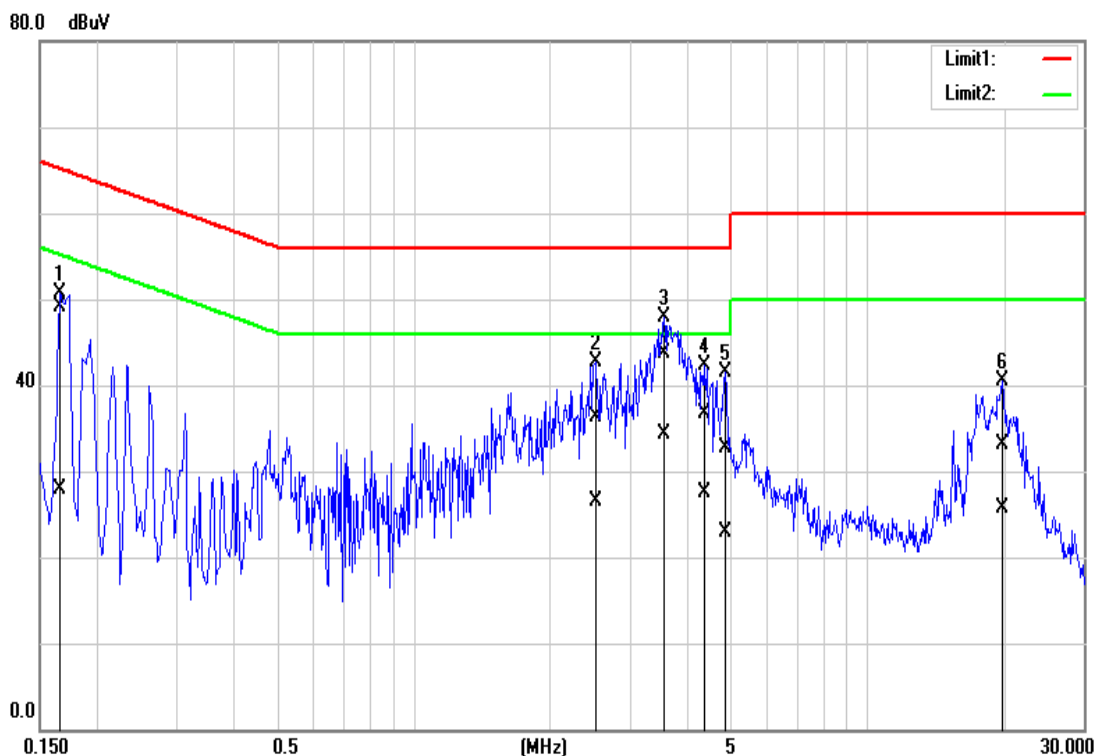

No.	Frequency (MHz)	QuasiPeak reading (dBuV)	Average reading (dBuV)	Correction factor (dB)	QuasiPeak result (dBuV)	Average result (dBuV)	QuasiPeak limit (dBuV)	Average limit (dBuV)	QuasiPeak margin (dB)	Average margin (dB)
1	0.1660	39.43	18.21	9.71	49.14	27.92	65.15	55.16	-16.01	-27.24
2	2.5220	26.52	16.73	9.77	36.29	26.50	56.00	46.00	-19.71	-19.50
3	3.5700	33.82	24.58	9.79	43.61	34.37	56.00	46.00	-12.39	-11.63
4	4.3620	26.88	17.67	9.79	36.67	27.46	56.00	46.00	-19.33	-18.54
5	4.8780	22.98	13.01	9.81	32.79	22.82	56.00	46.00	-23.21	-23.18
6	19.9340	23.00	15.72	10.06	33.06	25.78	60.00	50.00	-26.94	-24.22

## 4.2 OUTPUT POWER MEASUREMENT

### 4.2.1 Test Limit

According to §15.247(b)

**Peak output power :**

For systems using digital modulation in the 2400-2483.5 MHz, and 5725-5850 MHz bands: 1 Watt(30 dBm), base on the use of antennas with directional gain not exceed 6 dBi If transmitting antennas of directional gain greater than 6dBi are used the peak output power the conducted output power from the intentional radiator shall be reduced by the amount in dB that the directional gain of the antenna exceeds 6 dBi. In case of point-to-point operation, the limit has to be reduced by 1dB for every 3 dB that the directional gain of the antenna exceeds 6 dBi.

Limit	<input checked="" type="checkbox"/> Antenna not exceed 6 dBi : 30dBm <input type="checkbox"/> Antenna with DG greater than 6 dBi [ Limit = 30 – (DG – 6) ] <input type="checkbox"/> Point-to-point operation
-------	---

**Average output power :** For reporting purposes only.

### 4.2.2 Test Procedure

Test method Refer as KDB 558074 D01 v04, section 9.1.2.

1. The EUT RF output connected to the power meter by RF cable.
2. Setting maximum power transmit of EUT.
3. The path loss was compensated to the results for each measurement.
4. Measure and record the result of Peak output power and Average output power. in the test report.

### 4.2.3 Test Setup

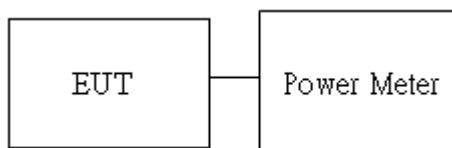



### 4.2.4 Test Result

**Peak output power :**

BLE Mode					
Config.	CH	Freq. (MHz)	PK Power (dBm)	PK Power (W)	Limit (dBm)
BLE Data rate: 1Mbps	0	2402	7.24	0.0053	30
	19	2440	7.36	0.0054	
	39	2480	7.60	0.0058	

**Average output power :**

BLE Mode			
Config.	CH	Freq. (MHz)	AV Power (dBm)
BLE Data rate: 1Mbps	0	2402	5.12
	19	2440	5.26
	39	2480	5.41

### 4.3 RADIATION BANDEGE AND SPURIOUS EMISSION

#### 4.3.1 Test Limit

FCC according to §15.247(d), §15.209 and §15.205,

In any 100 kHz bandwidth outside the authorized frequency band, all harmonic and spurious must be least 20 dB below the highest emission level with the authorized frequency band. Radiation emission which fall in the restricted bands must also follow the FCC section 15.209 as below limit in table.

#### Below 30 MHz

Frequency	Field Strength (microvolts/m)	Magnetic H-Field (microamperes/m)	Measurement Distance (metres)
9-490 kHz	2,400/F (F in kHz)	2,400/F (F in kHz)	300
490-1,705 kHz	24,000/F (F in kHz)	24,000/F (F in kHz)	30
1.705-30 MHz	30	N/A	30

#### Above 30 MHz

Frequency (MHz)	Field Strength microvolts/m at 3 metres (watts, e.i.r.p.)	
	Transmitters	Receivers
30-88	100 (3 nW)	100 (3 nW)
88-216	150 (6.8 nW)	150 (6.8 nW)
216-960	200 (12 nW)	200 (12 nW)
Above 960	500 (75 nW)	500 (75 nW)

Remark:

Although these tests were performed other than open area test site, adequate comparison measurements were confirmed against 30 m open are test site. Therefore sufficient tests were made to demonstrate that the alternative site produces results that correlate with the ones of tests made in an open field based on KDB 937606.

### 4.3.2 Test Procedure

Test method Refer as KDB 558074 D01 v04, Section 12.1.

1. The EUT is placed on a turntable, Above 1 GHz is 1.5m and below 1 GHz is 0.8m above ground plane. The EUT Configured un accordance with ANSI C63.10, and the EUT set in a continuous mode.
2. The turntable shall be rotated for 360 degrees to determine the position of maximum emission level. And EUT is set 3m away from the receiving antenna, which is scanned from 1m to 4m above the ground plane to find out the highest emissions. Measurement are made polarized in both the vertical and the horizontal positions with antenna.
3. Span shall wide enough to full capture the emission measured. The SA from 9KHz to 26.5GHz set to the low, Mid and High channels with the EUT transmit.
4. No emission found between lowest internal used/generated frequency to 30MHz (9KHz~30MHz)

Remark:

Although these tests were performed other than open area test site, adequate comparison measurements were confirmed against 30 m open are test site. Therefore sufficient tests were made to demonstrate that the alternative site produces results that correlate with the ones of tests made in an open field based on KDB 937606.

5. The SA setting following :

- (1) Below 1G : RBW = 100kHz, VBW ≥ 3 RBW, Sweep = Auto, Detector = Peak, Trace = Max hold.
- (2) Above 1G :
  - (2.1) For Peak measurement : RBW = 1MHz, VBW ≥ 3 RBW, Sweep = Auto, Detector = Peak, Trace = Max hold.
  - (2.2) For Average measurement : RBW = 1MHz, VBW
    - If Duty Cycle ≥ 98%, VBW=10Hz.
    - If Duty Cycle < 98%, VBW=1/T.

Configuration	Duty Cycle (%)	T(ms)	1/T (kHz)	VBW Setting
BLE	77%	0.4800	2.083	2.2KHz

### 4.3.3 Test Setup

#### 9kHz ~ 30MHz

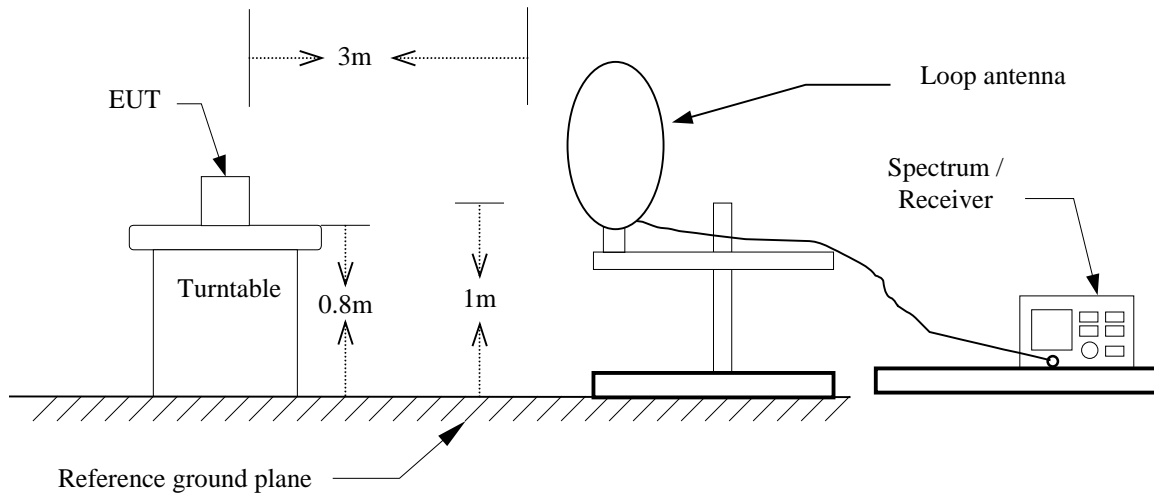

#### 30MHz ~ 1GHz

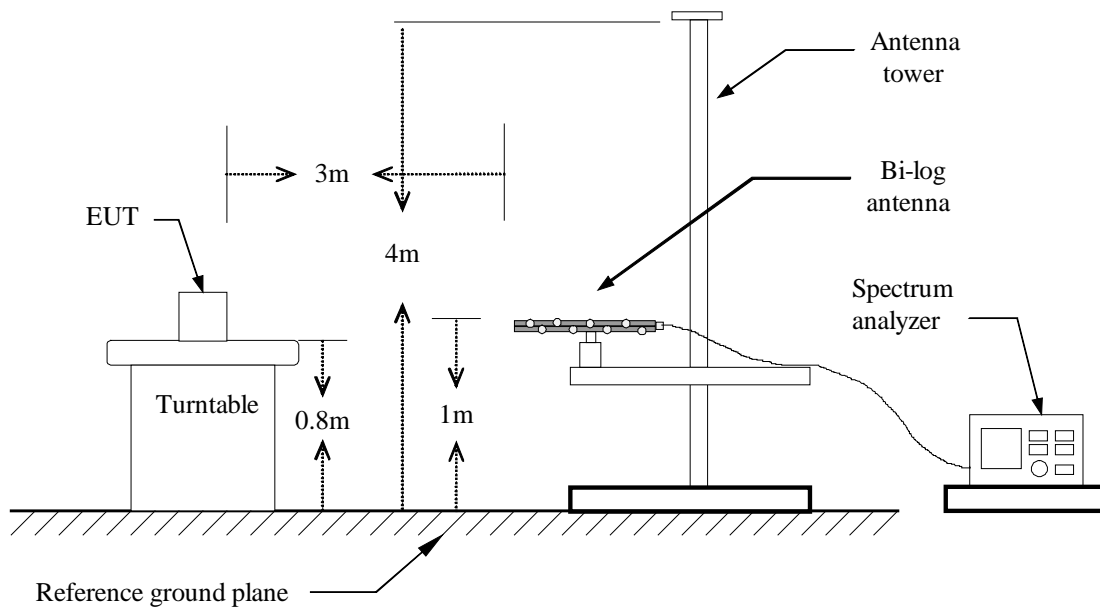

**Above 1 GHz**

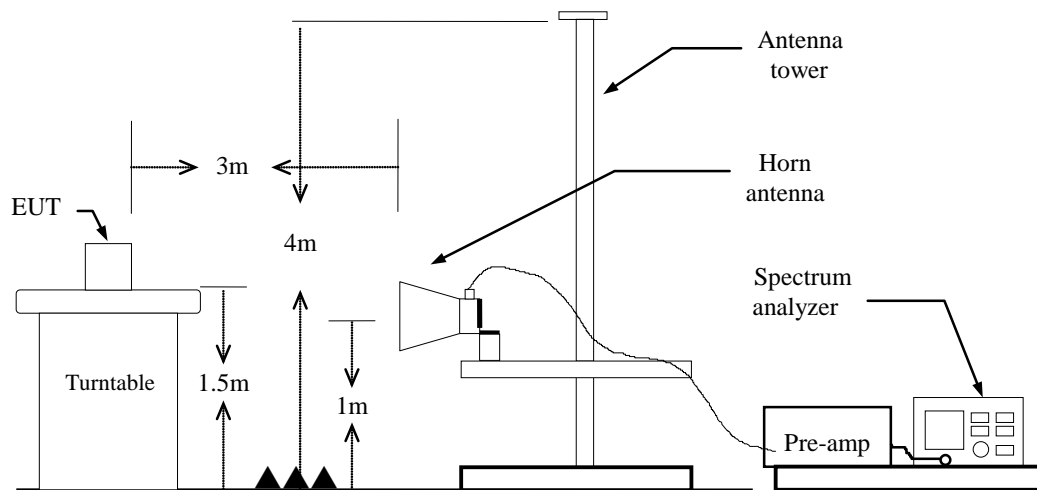

### 4.3.4 Test Result

#### Band Edge Test Data

Test Mode:	BLE Low CH	Temp/Hum	24(°C)/ 33%RH
Test Item	Band Edge	Test Date	March 13, 2018
Polarize	Horizontal	Test Engineer	Jerry Chuang
Detector	Peak	Test Voltage	120Vac / 60Hz

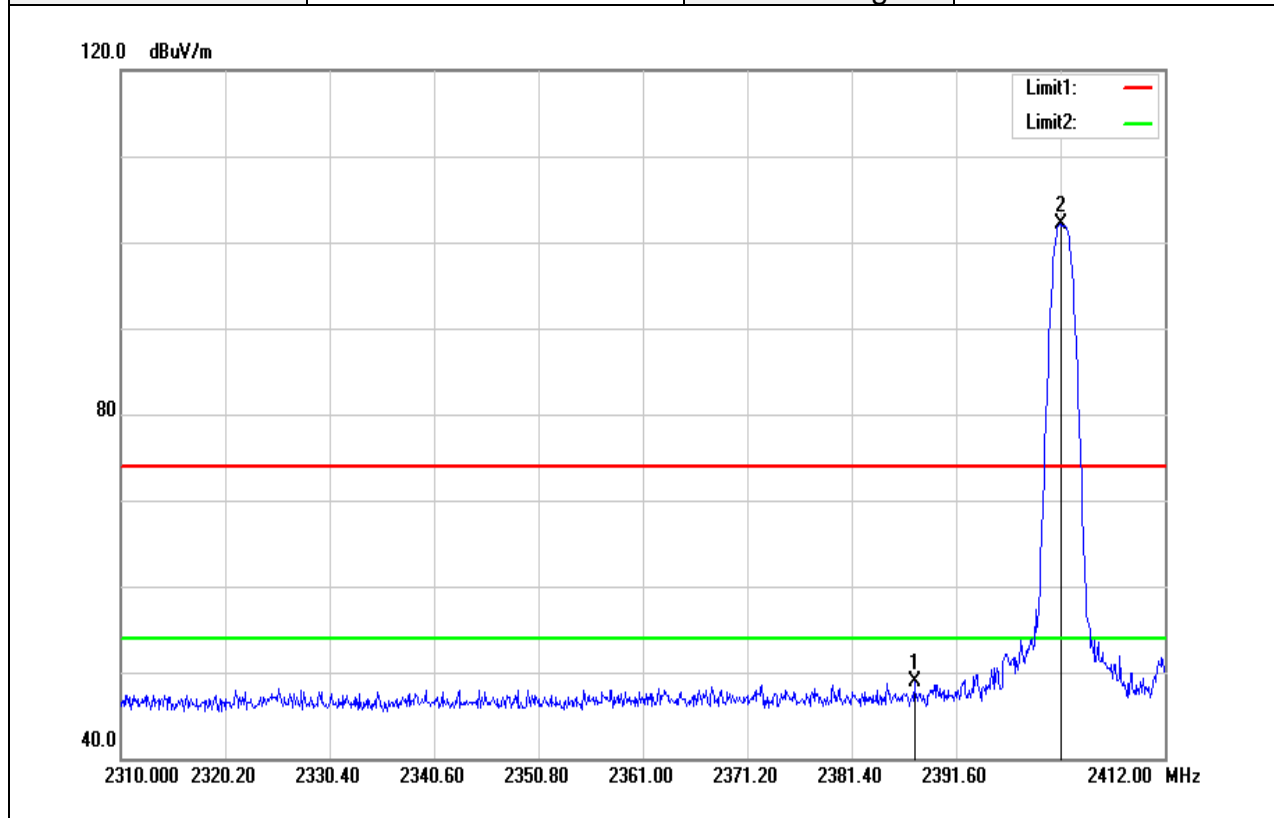

Frequency (MHz)	Reading (dBuV)	Correct Factor (dB/m)	Result (dBuV/m)	Limit (dBuV/m)	Margin (dB)	Remark
2387.520	51.81	-2.98	48.83	74.00	-25.17	peak
2401.800	104.98	-2.95	102.03	-	-	peak

Test Mode:	BLE Low CH	Temp/Hum	24(°C)/ 33%RH
Test Item	Band Edge	Test Date	March 13, 2018
Polarize	Horizontal	Test Engineer	Jerry Chuang
Detector	Average	Test Voltage	120Vac / 60Hz

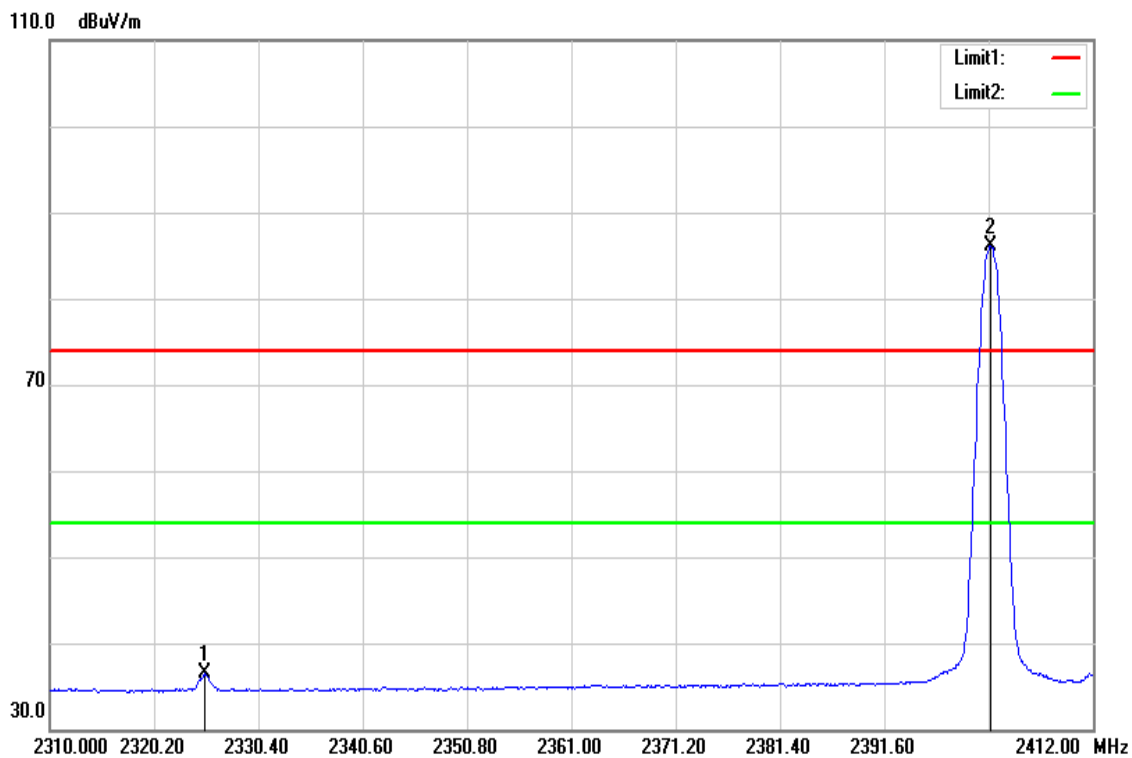

Frequency (MHz)	Reading (dBuV)	Correct Factor (dB/m)	Result (dBuV/m)	Limit (dBuV/m)	Margin (dB)	Remark
2325.096	39.66	-3.19	36.47	54.00	-17.53	AVG
2402.004	89.15	-2.95	86.20	-	-	AVG

Test Mode:	BLE High CH	Temp/Hum	24(°C)/ 33%RH
Test Item	Band Edge	Test Date	March 13, 2018
Polarize	Horizontal	Test Engineer	Jerry Chuang
Detector	Peak	Test Voltage	120Vac / 60Hz

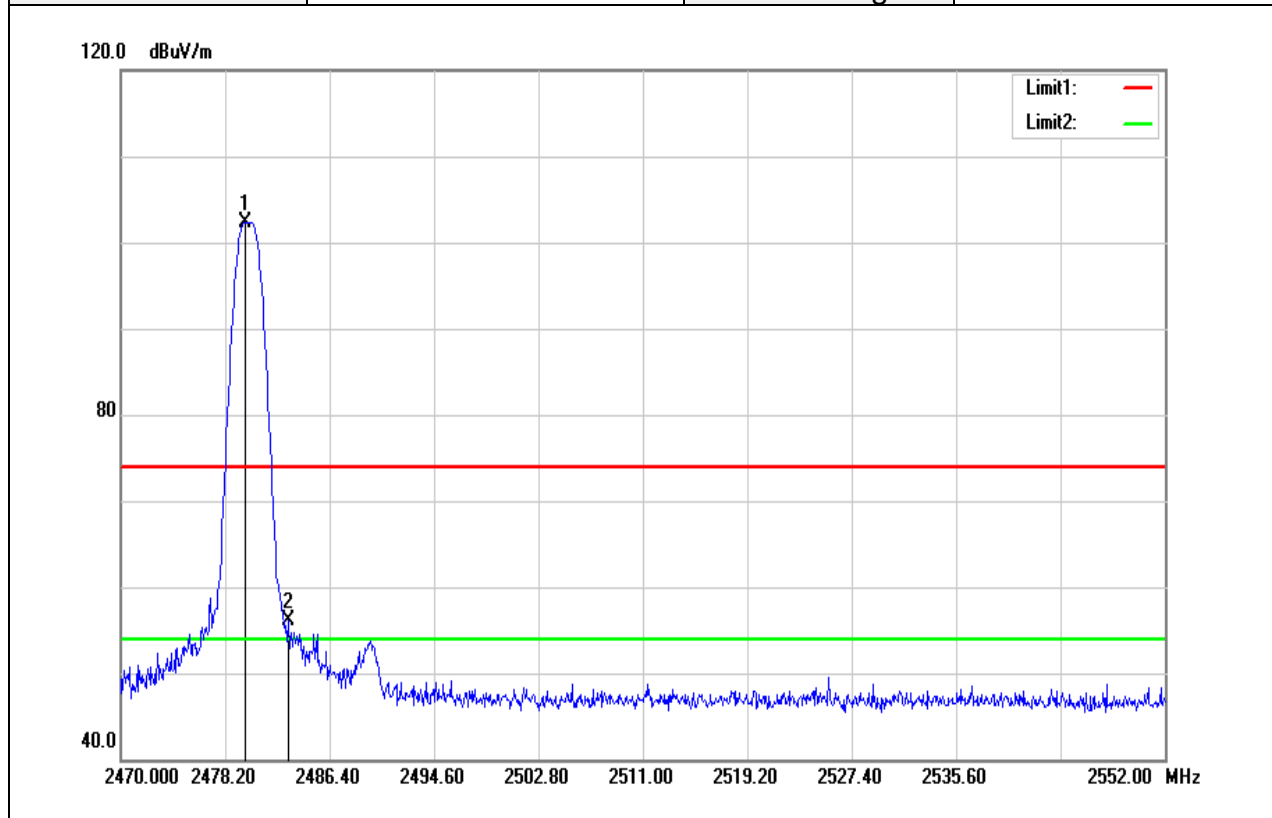

Frequency (MHz)	Reading (dBuV)	Correct Factor (dB/m)	Result (dBuV/m)	Limit (dBuV/m)	Margin (dB)	Remark
2479.758	105.02	-2.70	102.32	-	-	peak
2483.120	58.82	-2.69	56.13	74.00	-17.87	peak



Test Mode:	BLE High CH	Temp/Hum	24(°C)/ 33%RH
Test Item	Band Edge	Test Date	March 13, 2018
Polarize	Horizontal	Test Engineer	Jerry Chuang
Detector	Average	Test Voltage	120Vac / 60Hz

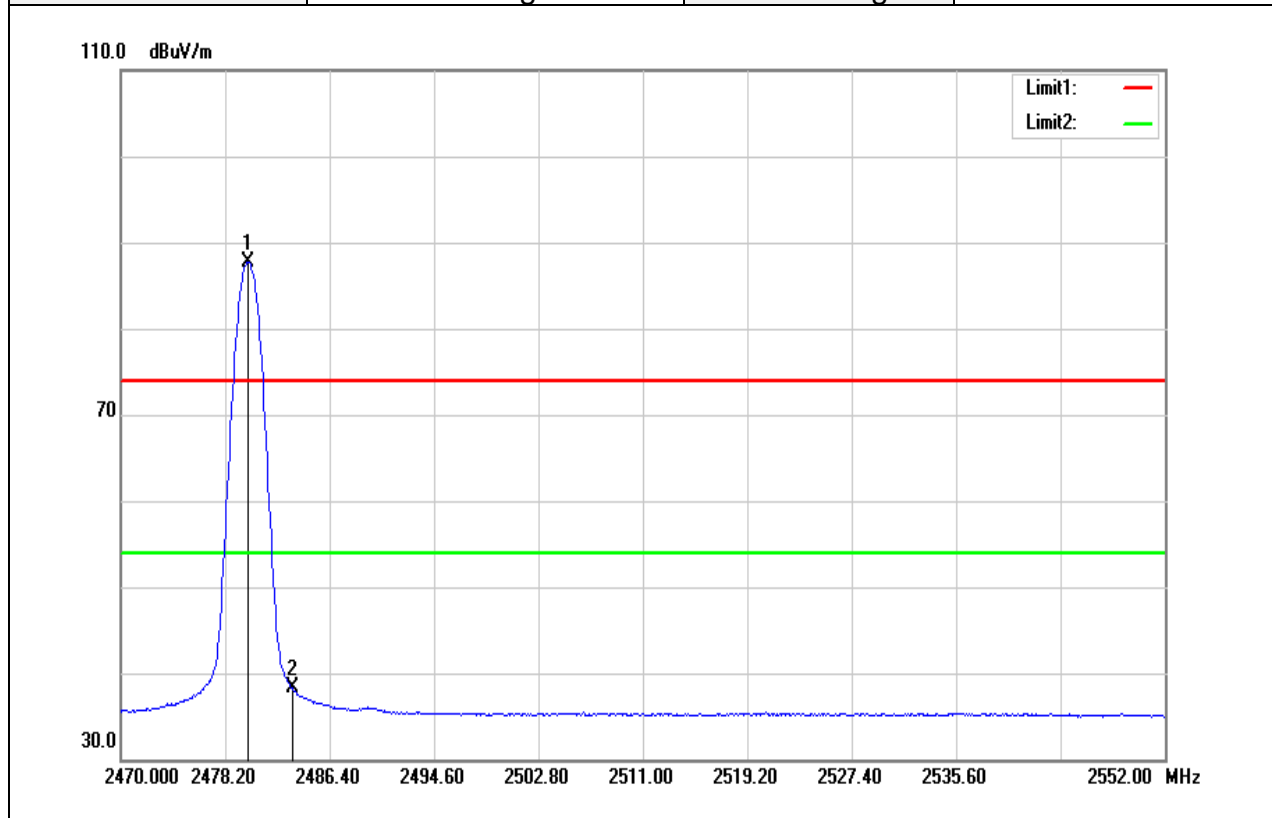

Frequency (MHz)	Reading (dBuV)	Correct Factor (dB/m)	Result (dBuV/m)	Limit (dBuV/m)	Margin (dB)	Remark
2480.004	90.44	-2.70	87.74	-	-	AVG
2483.500	40.98	-2.69	38.29	54.00	-15.71	AVG

**Below 1G Test Data**

Test Mode:	BT Mode	Temp/Hum	24(°C)/ 33%RH
Test Item	30MHz-1GHz	Test Date	March 13, 2018
Polarize	Vertical	Test Engineer	Jerry Chuang
Detector	Peak and Quasi-peak	Test Voltage:	120Vac / 60Hz

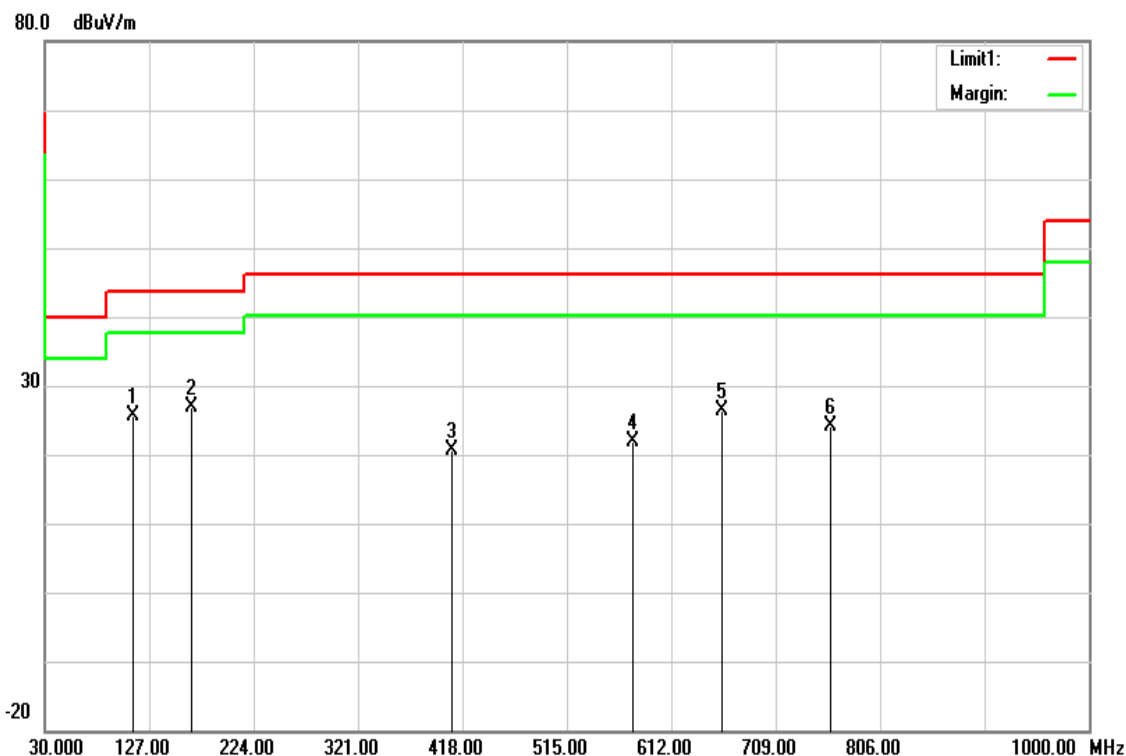

Frequency (MHz)	Reading (dBuV)	Correct Factor (dB/m)	Result (dBuV/m)	Limit (dBuV/m)	Margin (dB)	Remark
112.4500	42.05	-16.35	25.70	43.52	-17.82	peak
166.7700	43.20	-16.36	26.84	43.52	-16.68	peak
408.3000	31.70	-11.10	20.60	46.02	-25.42	peak
576.1100	29.10	-7.22	21.88	46.02	-24.14	peak
659.5300	31.68	-5.42	26.26	46.02	-19.76	peak
760.4100	28.36	-4.11	24.25	46.02	-21.77	peak

**Note:** No emission found between lowest internal used/generated frequency to 30MHz(9KHz~30MHz)

Test Mode:	BT Mode	Temp/Hum	24(°C)/ 33%RH
Test Item	30MHz-1GHz	Test Date	March 13, 2018
Polarize	Horizontal	Test Engineer	Jerry Chuang
Detector	Peak and Quasi-peak	Test Voltage:	120Vac / 60Hz

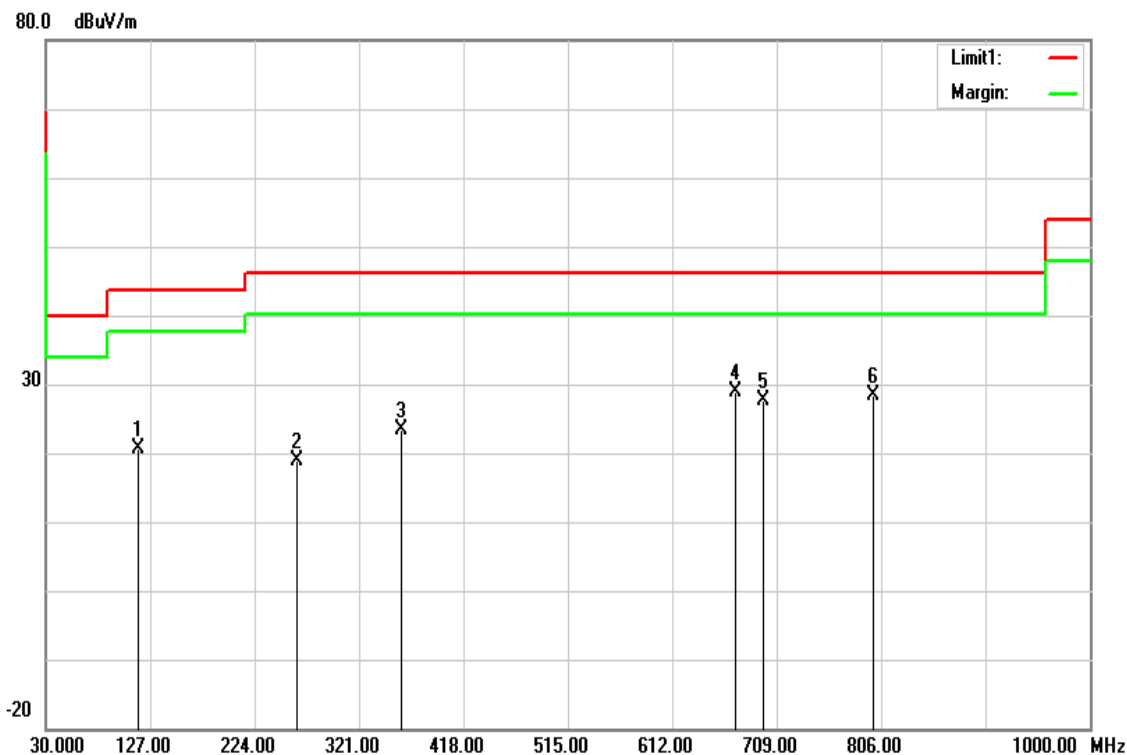

Frequency (MHz)	Reading (dBuV)	Correct Factor (dB/m)	Result (dBuV/m)	Limit (dBuV/m)	Margin (dB)	Remark
115.3600	36.38	-15.82	20.56	43.52	-22.96	peak
263.7700	34.06	-15.29	18.77	46.02	-27.25	peak
359.8000	35.96	-12.67	23.29	46.02	-22.73	peak
670.2000	34.11	-5.29	28.82	46.02	-17.20	peak
696.3900	32.64	-4.94	27.70	46.02	-18.32	peak
799.2100	31.82	-3.39	28.43	46.02	-17.59	peak

**Note:** No emission found between lowest internal used/generated frequency to 30MHz(9KHz~30MHz)

**Above 1G Test Data**

Test Mode:	BLE Low CH	Temp/Hum	24(°C)/ 33%RH
Test Item	Harmonic	Test Date	March 13, 2018
Polarize	Vertical	Test Engineer	Jerry Chuang
Detector	Peak and Average	Test Voltage	120Vac / 60Hz

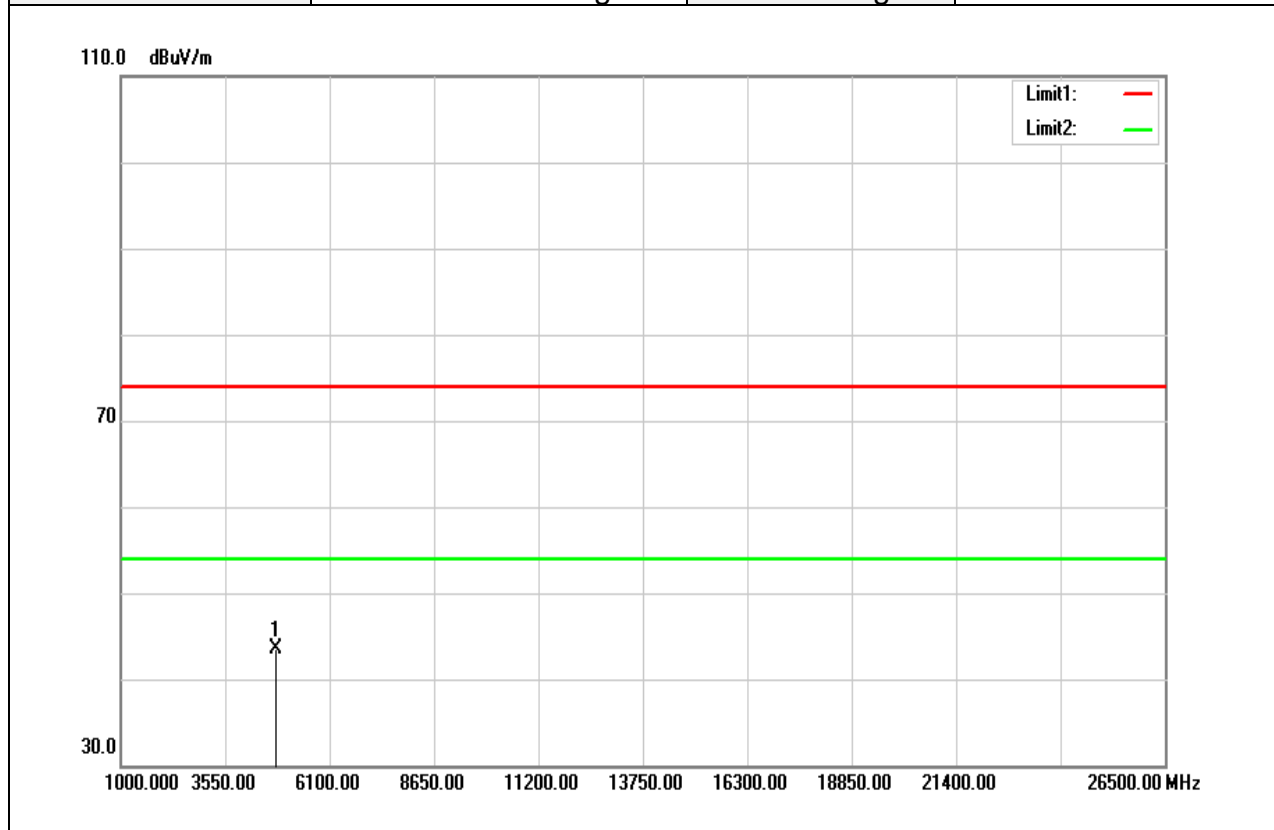

Frequency (MHz)	Reading (dBuV)	Correct Factor (dB/m)	Result (dBuV/m)	Limit (dBuV/m)	Margin (dB)	Remark
4804.000	39.21	4.34	43.55	74.00	-30.45	peak
N/A						

**Remark:**

1. Measuring frequencies from 1 GHz to the 10th harmonic of highest fundamental frequency.
2. For above 1GHz, the EUT peak value was under average limit, therefore the Average value compliance with the average limit

Test Mode:	BLE Low CH	Temp/Hum	24(°C)/ 33%RH
Test Item	Harmonic	Test Date	March 13, 2018
Polarize	Horizontal	Test Engineer	Jerry Chuang
Detector	Peak and Average	Test Voltage	120Vac / 60Hz

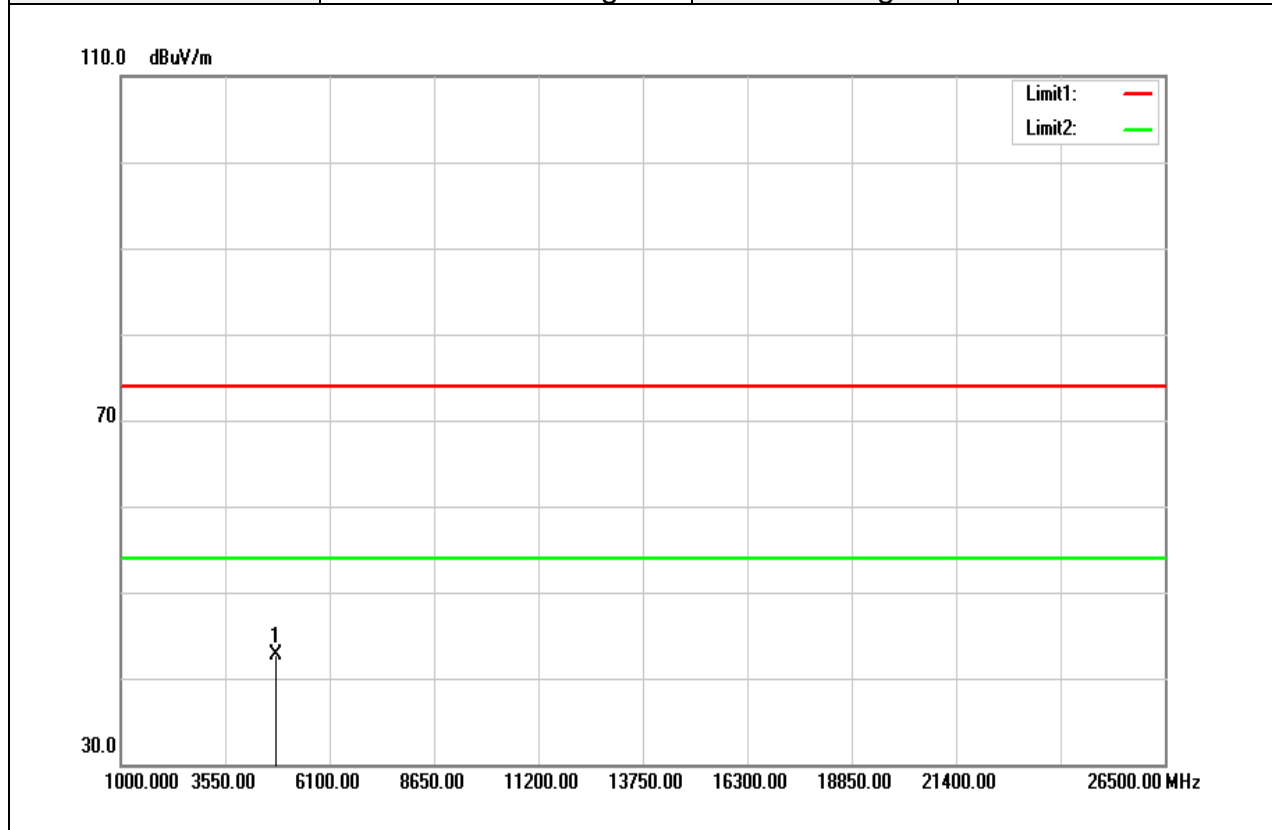

Frequency (MHz)	Reading (dBuV)	Correct Factor (dB/m)	Result (dBuV/m)	Limit (dBuV/m)	Margin (dB)	Remark
4804.000	38.44	4.34	42.78	74.00	-31.22	peak
N/A						

**Remark:**

1. Measuring frequencies from 1 GHz to the 10th harmonic of highest fundamental frequency.
2. For above 1GHz, the EUT peak value was under average limit, therefore the Average value compliance with the average limit

Test Mode:	BLE Mid CH	Temp/Hum	24(°C)/ 33%RH
Test Item	Harmonic	Test Date	March 13, 2018
Polarize	Vertical	Test Engineer	Jerry Chuang
Detector	Peak and Average	Test Voltage	120Vac / 60Hz

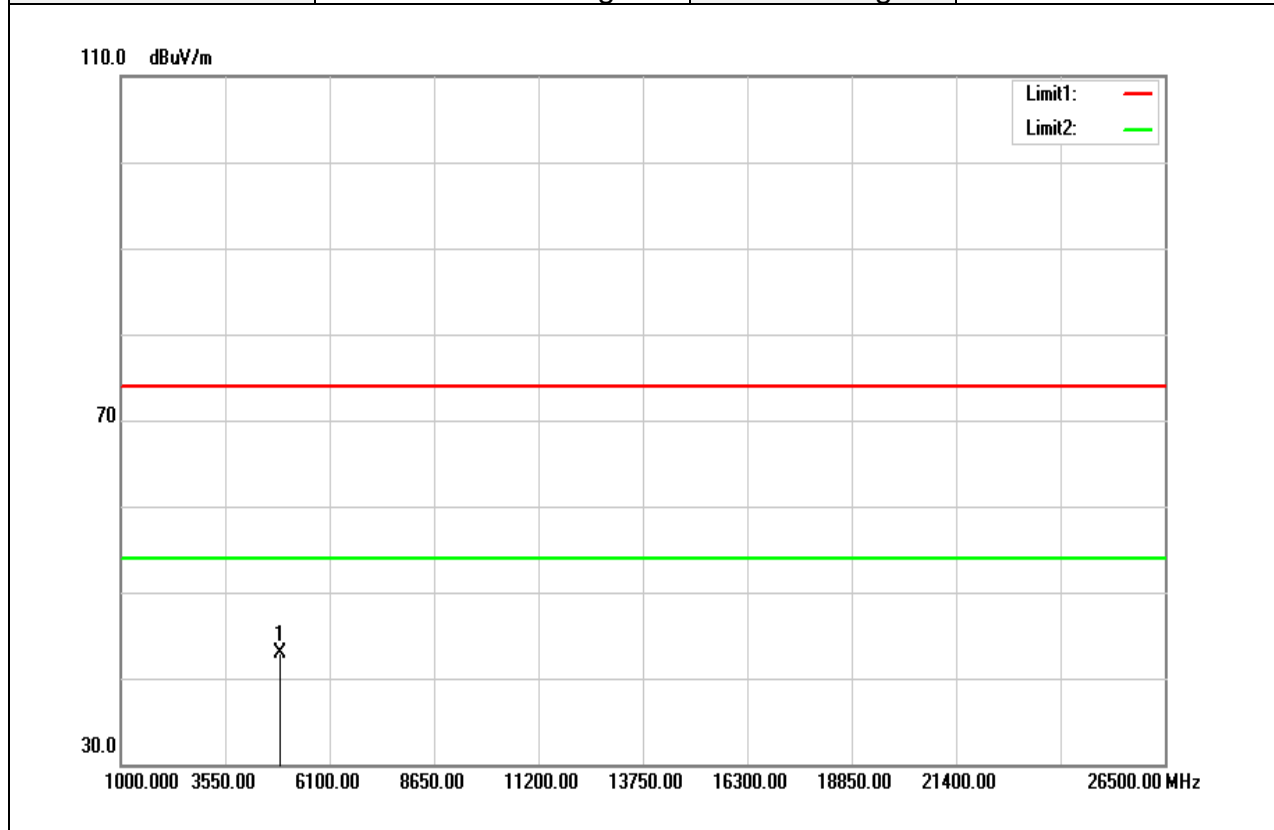

Frequency (MHz)	Reading (dBuV)	Correct Factor (dB/m)	Result (dBuV/m)	Limit (dBuV/m)	Margin (dB)	Remark
4880.000	38.33	4.48	42.81	74.00	-31.19	peak
N/A						

**Remark:**

1. Measuring frequencies from 1 GHz to the 10th harmonic of highest fundamental frequency.
2. For above 1GHz, the EUT peak value was under average limit, therefore the Average value compliance with the average limit

Test Mode:	BLE Mid CH	Temp/Hum	24(°C)/ 33%RH
Test Item	Harmonic	Test Date	March 13, 2018
Polarize	Horizontal	Test Engineer	Jerry Chuang
Detector	Peak and Average	Test Voltage	120Vac / 60Hz

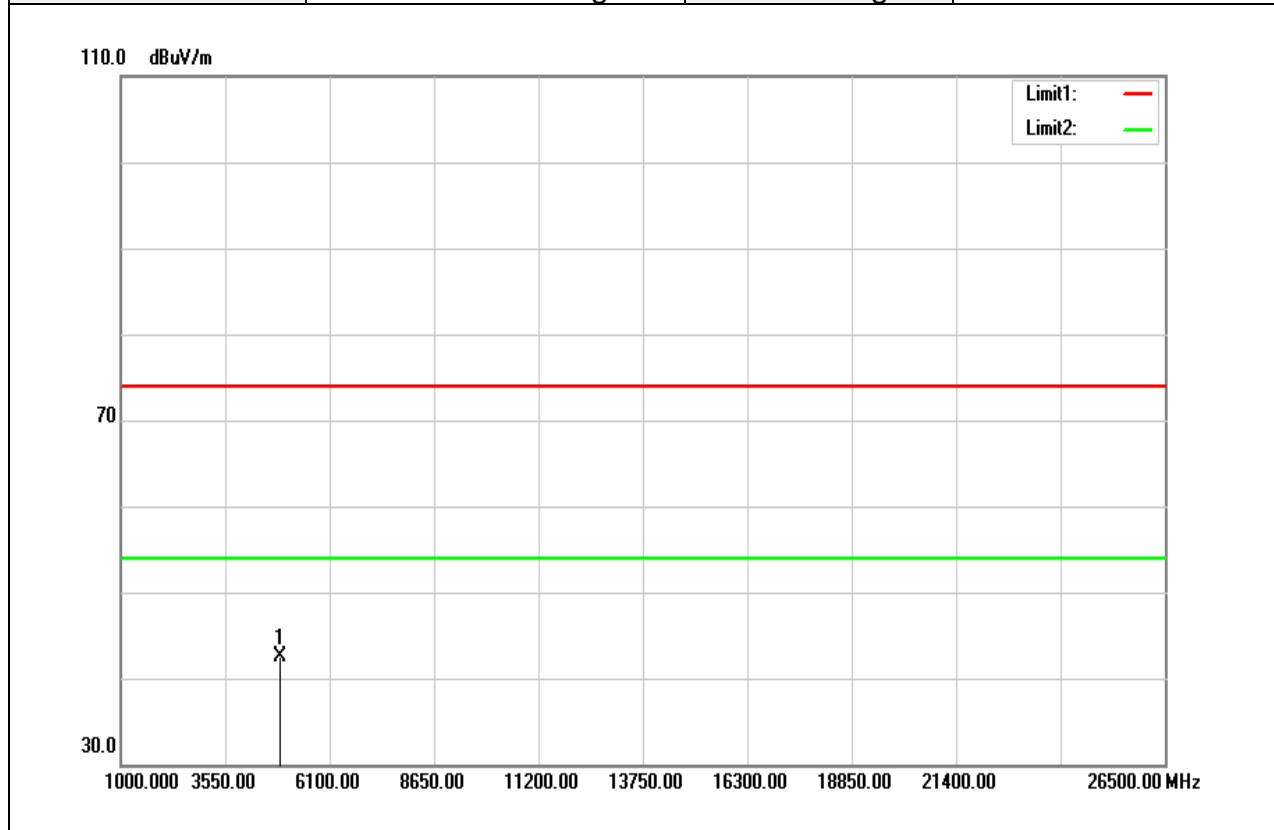

Frequency (MHz)	Reading (dBuV)	Correct Factor (dB/m)	Result (dBuV/m)	Limit (dBuV/m)	Margin (dB)	Remark
4880.000	37.93	4.48	42.41	74.00	-31.59	peak
N/A						

**Remark:**

1. Measuring frequencies from 1 GHz to the 10th harmonic of highest fundamental frequency.
2. For above 1GHz, the EUT peak value was under average limit, therefore the Average value compliance with the average limit

Test Mode:	BLE High CH	Temp/Hum	24(°C)/ 33%RH
Test Item	Harmonic	Test Date	March 13, 2018
Polarize	Vertical	Test Engineer	Jerry Chuang
Detector	Peak and Average	Test Voltage	120Vac / 60Hz

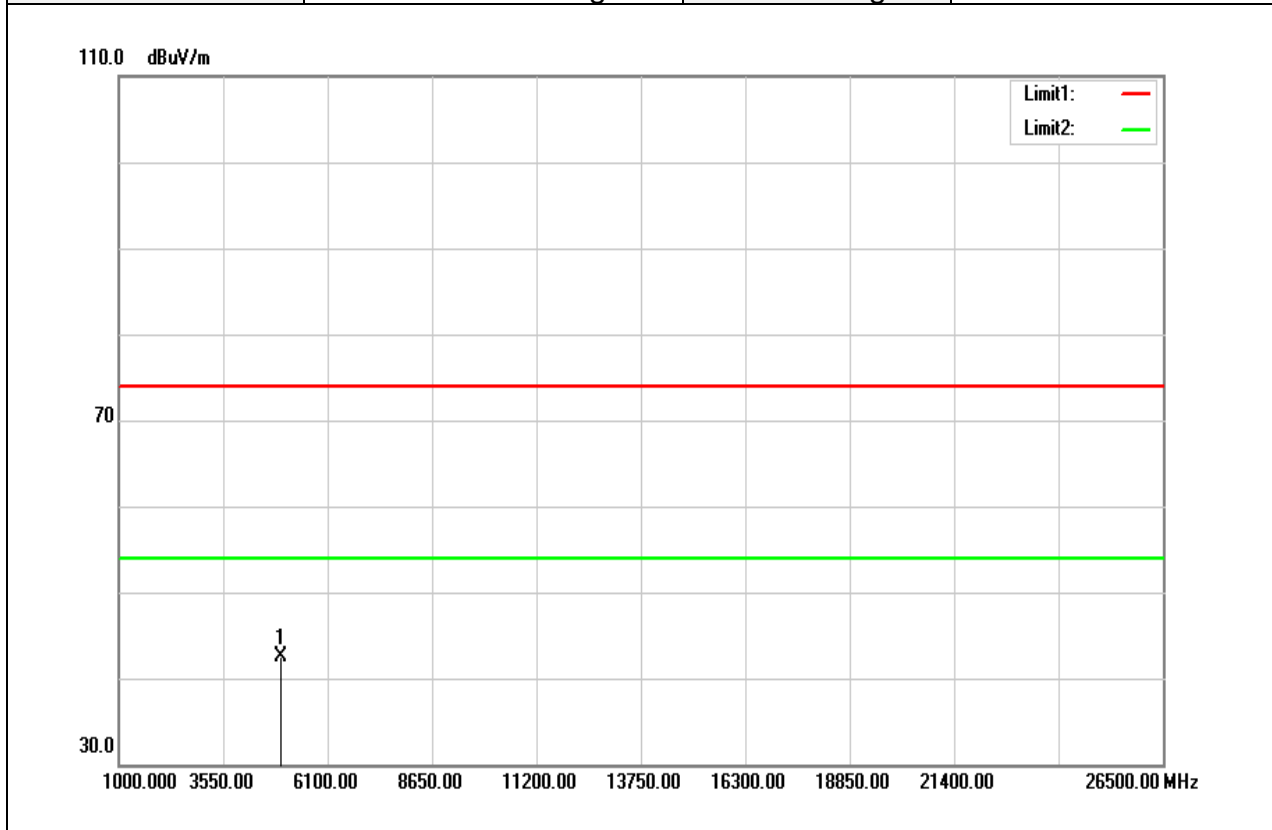

Frequency (MHz)	Reading (dBuV)	Correct Factor (dB/m)	Result (dBuV/m)	Limit (dBuV/m)	Margin (dB)	Remark
4960.000	37.96	4.61	42.57	74.00	-31.43	peak
N/A						

**Remark:**

1. Measuring frequencies from 1 GHz to the 10th harmonic of highest fundamental frequency.
2. For above 1GHz, the EUT peak value was under average limit, therefore the Average value compliance with the average limit



Test Mode:	BLE High CH	Temp/Hum	24(°C)/ 33%RH
Test Item	Harmonic	Test Date	March 13, 2018
Polarize	Horizontal	Test Engineer	Jerry Chuang
Detector	Peak and Average	Test Voltage	120Vac / 60Hz

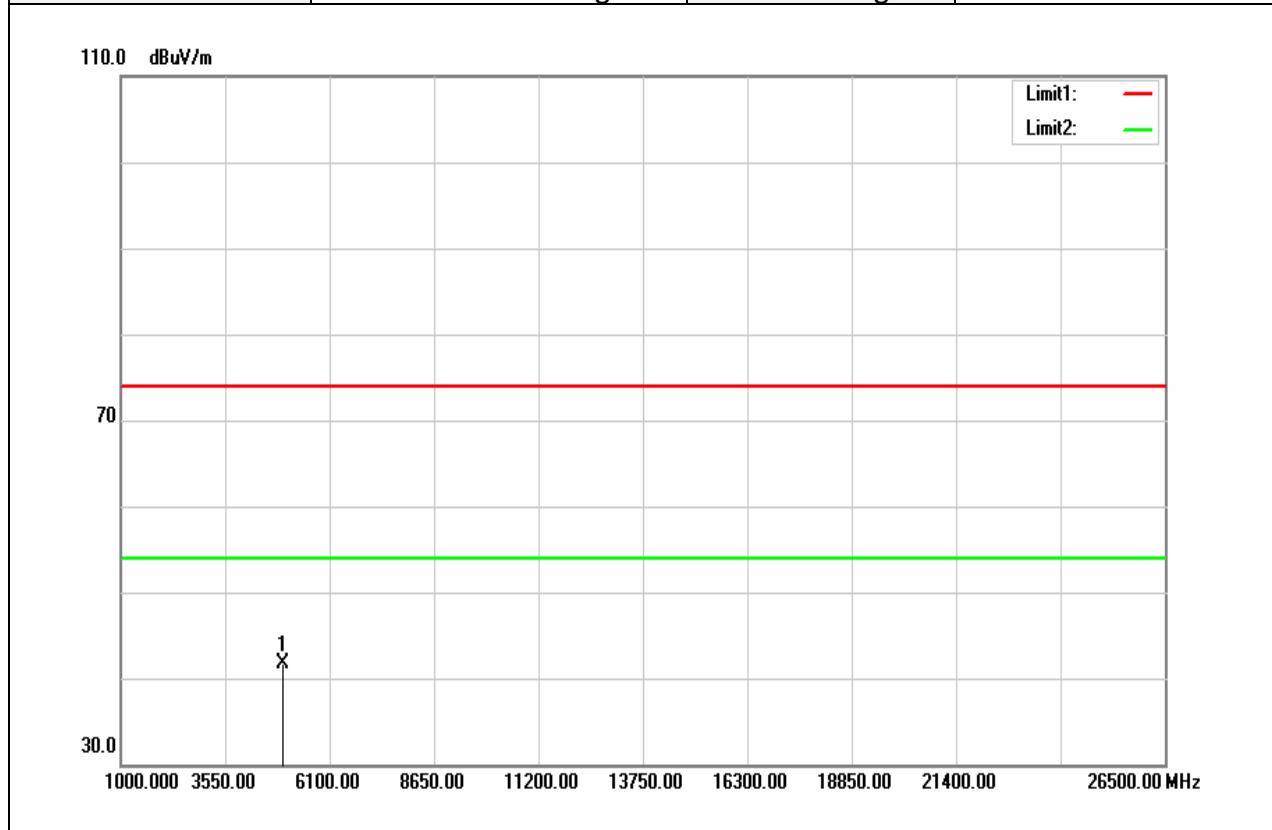

Frequency (MHz)	Reading (dBuV)	Correct Factor (dB/m)	Result (dBuV/m)	Limit (dBuV/m)	Margin (dB)	Remark
4960.000	37.17	4.61	41.78	74.00	-32.22	peak
N/A						

**Remark:**

1. Measuring frequencies from 1 GHz to the 10th harmonic of highest fundamental frequency.
2. For above 1GHz, the EUT peak value was under average limit, therefore the Average value compliance with the average limit