



FCC 47 CFR PART 15 SUBPART C

TEST REPORT

For

Tablet PC

**Trade Name / Model:
Twinhead / T8NXX (X=0~9, A~Z OR BLANK),
MobileDemand / xTablet T8600**

Issued to

**TWINHEAD INTERNATIONAL CORP.
10F, No. 550, Rueiguang Rd., Neihu,
Taipei, Taiwan 114, R.O.C.**

Issued by

**Compliance Certification Services Inc.
No. 81-1, Lane 210, Bade Rd. 2, Luchu Hsiang,
Taoyuan Hsien, (338) Taiwan, R.O.C.
<http://www.ccsemc.com.tw>
service@tw.ccsemc.com**



Note: This report shall not be reproduced except in full, without the written approval of Compliance Certification Services Inc. This document may be altered or revised by Compliance Certification Services Inc. personnel only, and shall be noted in the revision section of the document



TABLE OF CONTENTS

- 1. TEST RESULT CERIFICATION 3**
- 2. EUT DESCRIPTION..... 4**
- 3. TEST METHODOLOGY 5**
 - 3.1 EUT CONFIGURATION 5
 - 3.2 EUT EXERCISE 5
 - 3.3 GENERAL TEST PROCEDURES 5
 - 3.4 FCC PART 15.205 RESTRICTED BANDS OF OPERATIONS 6
 - 3.5 DESCRIPTION OF TEST MODES 7
- 4. INSTRUMENT CALIBRATION 8**
 - 4.1 MEASURING INSTRUMENT CALIBRATION 8
 - 4.2 MEASUREMENT EQUIPMENT USED 8
- 5. FACILITIES AND ACCREDITATIONS..... 9**
 - 5.1 FACILITIES 9
 - 5.2 EQUIPMENT 9
 - 5.3 TABLE OF ACCREDITATIONS AND LISTINGS 10
- 6. SETUP OF EQUIPMENT UNDER TEST 11**
 - 6.1 SETUP CONFIGURATION OF EUT 11
 - 6.2 SUPPORT EQUIPMENT 11
- 7. FCC PART 15.247 REQUIREMENTS 12**
 - CONDITION A: WLAN OPERATION 12
 - 7.1 6DB BANDWIDTH 12
 - 7.2 PEAK POWER 19
 - 7.3 AVERAGE POWER 26
 - 7.4 BAND EDGES MEASUREMENT 33
 - 7.5 PEAK POWER SPECTRAL DENSITY 42
 - 7.6 SPURIOUS EMISSIONS 49
 - CONDITION B: BLUETOOTH OPERATION 68
 - 7.7 PEAK POWER 68
 - 7.8 AVERAGE POWER 69
 - 7.9 BAND EDGES MEASUREMENT 70
 - 7.10 PEAK POWER SPECTRAL DENSITY 75
 - 7.11 FREQUENCY SEPARATION 78
 - 7.12 NUMBER OF HOPPING FREQUENCY 80
 - 7.13 TIME OF OCCUPANCY (DWELL TIME) 82
 - 7.14 SPURIOUS EMISSIONS 89
 - 7.15 POWER LINE CONDUCTED EMISSIONS 97
- APPENDIX I RADIO FREQUENCY EXPOSURE..... 100**
- APPENDIX II PTOTOGRAPHS OF TEST SETUP 103**



1. TEST RESULT CERIFICATION

Applicant: TWINHEAD INTERNATIONAL CORP.
10F, No. 550, Rueiguang Rd., Neihu,
Taipei, Taiwan 114, R.O.C.

Equipment Under Test: Tablet PC

Trade Name / Model Number: Twinhead / T8NXX (X=0~9, A~Z OR BLANK),
MobileDemand / xTablet T8600

Date of Test: July 8 ~ 12, 2006

Table with 2 columns: STANDARD, TEST RESULT. Row 1: FCC 47 CFR Part 15 Subpart C, No non-compliance noted.

We hereby certify that:

The above equipment was tested by Compliance Certification Services Inc. The test data, data evaluation, test procedures, and equipment configurations shown in this report were made in accordance with the procedures given in ANSI C63.4: 2003 and the energy emitted by the sample EUT tested as described in this report is in compliance with conducted and radiated emission limits of FCC Rules Part 15.207, 15.209 and 15.247.

The test results of this report relate only to the tested sample EUT identified in this report.

Approved by:

Reviewed by:

Handwritten signature of Gavin Lim

Handwritten signature of Amanda Wu

Gavin Lim
Section Manager
Compliance Certification Services Inc.

Amanda Wu
Section Manager
Compliance Certification Services Inc.



2. EUT DESCRIPTION

Product	Tablet PC
Trade Name / Model Number	Twinhead / T8NXX (X=0~9, A~Z OR BLANK), MobileDemand / xTablet T8600
Model Discrepancy	All the above models are identical except the model designation.
Power Supply	LI SHIN INTERNATIONAL ENTERPROSE CORP. / 0335A2065 I/P: AC 100-240V, 50-60Hz, 1.7A O/P: DC 20V, 3.25A Battery: Lithium – Ion / T8N-E 11.1V, 7000 mAh
Frequency Range	IEEE 802.11a: 5.725 ~ 5.850 GHz IEEE 802.11b/g: 2.412 ~ 2.462 GHz Bluetooth: 2.402 ~ 2.480 GHz
Transmit Power	IEEE 802.11a: 14.61 dBm IEEE 802.11b: 16.97 dBm IEEE 802.11g: 14.82 dBm Bluetooth: 2.40 dBm
Modulation Technique	IEEE 802.11a: OFDM (QPSK, BPSK, 16-QAM, 64-QAM) IEEE 802.11b: DSSS (CCK, DQPSK, DBPSK) IEEE 802.11g: DSSS (CCK, DQPSK, DBPSK) + OFDM (QPSK, BPSK, 16-QAM, 64-QAM) Bluetooth: FHSS (GFSK)
Number of Channels	IEEE 802.11a: 5 Channels IEEE 802.11b/g: 11 Channels Bluetooth: 79 Channels
Antenna Specification	IEEE 802.11a: -1.54 dBi IEEE 802.11b/g: -0.4dBi Bluetooth: -0.4 dBi
Antenna Designation	IEEE 802.11a/b/g: PIFA Antenna Bluetooth: PIFA Antenna

Remark:

1. The sample selected for test was engineering sample that approximated to production product and was provided by manufacturer.
2. This submittal(s) (test report) is intended for FCC ID: **FKGT8N** filing to comply with Section 15.407 of the FCC Part 15, Subpart E Rules.



3. TEST METHODOLOGY

The tests documented in this report were performed in accordance with ANSI C63.4. Radiated testing was performed at an antenna to EUT distance 3 meters.

3.1 EUT CONFIGURATION

The EUT configuration for testing is installed on RF field strength measurement to meet the Commissions requirement and operating in a manner that intends to maximize its emission characteristics in a continuous normal application.

3.2 EUT EXERCISE

The EUT was operated in the engineering mode to fix the Tx frequency that was for the purpose of the measurements.

According to its specifications, the EUT must comply with the requirements of the Section 15.207, 15.209 and 15.247 under the FCC Rules Part 15 Subpart C.

3.3 GENERAL TEST PROCEDURES

Conducted Emissions

The EUT is placed on the turntable, which is 0.8 m above ground plane. According to the requirements in Section 13.1.4.1 of ANSI C63.4. Conducted emissions from the EUT measured in the frequency range between 0.15 MHz and 30MHz using CISPR Quasi-peak and average detector modes.

Radiated Emissions

The EUT is placed on a turn table, which is 0.8 m above ground plane. The turntable shall rotate 360 degrees to determine the position of maximum emission level. EUT is set 3m away from the receiving antenna, which varied from 1m to 4m to find out the highest emission. And also, each emission was to be maximized by changing the polarization of receiving antenna both horizontal and vertical. In order to find out the maximum emissions, exploratory radiated emission measurements were made according to the requirements in Section 13.1.4.1 of ANSI C63.4.



3.4 FCC PART 15.205 RESTRICTED BANDS OF OPERATIONS

(a) Except as shown in paragraph (d) of this section, only spurious emissions are permitted in any of the frequency bands listed below:

MHz	MHz	MHz	GHz
0.090 - 0.110	16.42 - 16.423	399.9 - 410	4.5 - 5.15
¹ 0.495 - 0.505	16.69475 - 16.69525	608 - 614	5.35 - 5.46
2.1735 - 2.1905	16.80425 - 16.80475	960 - 1240	7.25 - 7.75
4.125 - 4.128	25.5 - 25.67	1300 - 1427	8.025 - 8.5
4.17725 - 4.17775	37.5 - 38.25	1435 - 1626.5	9.0 - 9.2
4.20725 - 4.20775	73 - 74.6	1645.5 - 1646.5	9.3 - 9.5
6.215 - 6.218	74.8 - 75.2	1660 - 1710	10.6 - 12.7
6.26775 - 6.26825	108 - 121.94	1718.8 - 1722.2	13.25 - 13.4
6.31175 - 6.31225	123 - 138	2200 - 2300	14.47 - 14.5
8.291 - 8.294	149.9 - 150.05	2310 - 2390	15.35 - 16.2
8.362 - 8.366	156.52475 - 156.52525	2483.5 - 2500	17.7 - 21.4
8.37625 - 8.38675	156.7 - 156.9	2655 - 2900	22.01 - 23.12
8.41425 - 8.41475	162.0125 - 167.17	3260 - 3267	23.6 - 24.0
12.29 - 12.293	167.72 - 173.2	3332 - 3339	31.2 - 31.8
12.51975 - 12.52025	240 - 285	3345.8 - 3358	36.43 - 36.5
12.57675 - 12.57725	322 - 335.4	3600 - 4400	(²)
13.36 - 13.41			

¹ Until February 1, 1999, this restricted band shall be 0.490-0.510 MHz.

² Above 38.6

(b) Except as provided in paragraphs (d) and (e), the field strength of emissions appearing within these frequency bands shall not exceed the limits shown in Section 15.209. At frequencies equal to or less than 1000 MHz, compliance with the limits in Section 15.209 shall be demonstrated using measurement instrumentation employing a CISPR quasi-peak detector. Above 1000 MHz, compliance with the emission limits in Section 15.209 shall be demonstrated based on the average value of the measured emissions. The provisions in Section 15.35 apply to these measurements.



3.5 DESCRIPTION OF TEST MODES

The EUT (model: T8NXX (X=0~9, A~Z OR BLANK)) had been tested under operating condition.

Software used to control the EUT for staying in continuous transmitting mode was programmed. After verification, all tests carried out are with the worst-case test modes as shown below except radiated spurious emissions below 1GHz's worst case was in normal link mode.

IEEE802.11a:

Channel Low (5745MHz), Channel Mid (5785MHz) and Channel High (5825MHz) with 6Mbps data rate were chosen for full testing.

IEEE802.11b:

Channel Low (2412MHz), Channel Mid (2437MHz) and Channel High (2462MHz) with 1Mbps data rate were chosen for full testing.

IEEE802.11g:

Channel Low (2412MHz), Channel Mid (2437MHz) and Channel High (2462MHz) with 6Mbps data rate were chosen for full testing.

Bluetooth:

Channel Low (2402MHz), Channel Mid (2441MHz) and Channel High (2480MHz) with 1Mbps data rate were chosen for radiated testing.

The field strength of spurious emission was measured in the following position: EUT stand-up position (Z axis), lie-down position (X, Y axis). The worst emission was found in lie-down position (Y axis) and the worst case was recorded.



4. INSTRUMENT CALIBRATION

4.1 MEASURING INSTRUMENT CALIBRATION

The measuring equipment, which was utilized in performing the tests documented herein, has been calibrated in accordance with the manufacturer's recommendations for utilizing calibration equipment, which is traceable to recognized national standards.

4.2 MEASUREMENT EQUIPMENT USED

Equipment Used for Emissions Measurement

Remark: Each piece of equipment is scheduled for calibration once a year.

Conducted Emissions Test Site				
Name of Equipment	Manufacturer	Model	Serial Number	Calibration Due
Spectrum Analyzer	Agilent	E4446A	MY43360131	01/18/2007

3M Semi Anechoic Chamber				
Name of Equipment	Manufacturer	Model	Serial Number	Calibration Due
Spectrum Analyzer	Agilent	E4446A	US42510252	07/25/2006
Test Receiver	Rohde&Schwarz	ESCI	100064	06/28/2007
Switch Controller	TRC	Switch Controller	SC94050010	05/05/2007
4 Port Switch	TRC	4 Port Switch	SC94050020	05/05/2007
Horn-Antenna	TRC	HA-0502	06	06/02/2007
Horn-Antenna	TRC	HA-0801	04	05/05/2007
Horn-Antenna	TRC	HA-1201A	01	07/04/2007
Horn-Antenna	TRC	HA-1301A	01	07/04/2007
Bilog- Antenna	Sunol Sciences	JB3	A030205	03/09/2007
Turn Table	Max-Full	MFT-120S	T120S940302	N.C.R.
Antenna Tower	Max-Full	MFA-430	A440940302	N.C.R.
Controller	Max-Full	MF-CM886	CC-C-1F-13	N.C.R.
Site NSA	CCS	N/A	FCC: 965860 IC: IC 6106	09/26/2008
Test S/W	LABVIEW (V 6.1)			

Remark: The measurement uncertainty is less than +/-2.0065dB (30MHz ~ 1GHz), +/-3.0958dB (Above 1GHz) which is evaluated as per the NAMAS NIS 81 and CISPR/A/291/CDV.

Powerline Conducted Emissions Test Site				
Name of Equipment	Manufacturer	Model	Serial Number	Calibration Due
EMI TEST RECEIVER 9kHz-30MHz	ROHDE & SCHWARZ	ESHS30	828144/003	09/27/2006
TWO-LINE V-NETWORK 9kHz-30MHz	SCHAFFNER	NNB41	03/10013	06/12/2007
LISN 10kHz-100MHz	EMCO	3825/2	9106-1809	03/20/2007
Test S/W	LABVIEW (V 6.1)			

Remark: The measurement uncertainty is less than +/- 2.81dB, which is evaluated as per the NAMAS NIS 81 and CISPR/A/291/CDV.



5. FACILITIES AND ACCREDITATIONS

5.1 FACILITIES

All measurement facilities used to collect the measurement data are located at

No.199, Chunghsen Road, Hsintien City, Taipei Hsien, Taiwan, R.O.C.

Tel: 886-2-2217-0894 / Fax: 886-2-2217-1029

No.11, Wugong 6th Rd., Wugu Industrial Park, Taipei Hsien 248, Taiwan

Tel: 886-2-2299-9720 / Fax: 886-2-2298-4045

No.81-1, Lane 210, Bade 2nd Rd., Luchu Hsiang, Taoyuan Hsien 338, Taiwan

Tel: 886-3-324-0332 / Fax: 886-3-324-5235

5.2 EQUIPMENT







Radiated emissions are measured with one or more of the following types of linearly polarized antennas: tuned dipole, biconical, log periodic, bi-log, and/or ridged waveguide, horn. Spectrum analyzers with pre-selectors and quasi-peak detectors are used to perform radiated measurements.

Conducted emissions are measured with Line Impedance Stabilization Networks and EMI Test Receivers.

Calibrated wideband preamplifiers, coaxial cables, and coaxial attenuators are also used for making measurements.

All receiving equipment conforms to CISPR Publication 16-1, "Radio Interference Measuring Apparatus and Measurement Methods."

5.3 TABLE OF ACCREDITATIONS AND LISTINGS

Country	Agency	Scope of Accreditation	Logo
USA	A2LA	EN 55011, EN 55014-1/2, CISPR 11, CISPR 14-1/2, EN 55022, EN 55015, CISPR 22, CISPR 15, AS/NZS 3548, VCCI V3 (2001), CFR 47, FCC Part 15/18, CNS 13783-1, CNS 13439, CNS 13438, CNS 13803, CNS 14115, EN 55024, IEC 801-2, IEC 801-3, IEC 801-4, IEC/EN 61000-3-2, EIC/EN 61000-3-3, IEC/EN 61000-4-2/3/4/5/6/8/11, EN 50081-1/ EN 61000-6-3, EN 50081-2/EN 61000-6-4, EN 50081-2/EN 61000-6-1: 2001	 0824-01
USA	FCC	3/10 meter Open Area Test Sites (93105, 90471) / 3M Semi Anechoic Chamber (965860) to perform FCC Part 15/18 measurements	 93105, 90471 965860
Japan	VCCI	3/10 meter Open Area Test Sites to perform conducted/radiated measurements	 R-393/1066/725/879 C-402/747/912
Norway	NEMKO	EN 50081-1/2, EN 50082-1/2, IEC 61000-6-1/2, EN 50091-2, EN 50130-4, EN 55011, EN 55013, EN 55014-1/2, EN 55015, EN 55022, EN 55024, EN 61000-3-2/3, EN 61326-1, IEC 61000-4-2/3/4/5/6/8/11, EN 60601-1-2, EN 300 328, EN 300 422-2, EN 301 419-1, EN 301 489-01/03/07/08/09/17, EN 301 419-2/3, EN 300 454-2, EN 301 357-2	 ELA 124a ELA 124b ELA 124c
Taiwan	TAF	EN 300 328, EN 300 220-1, EN 300 220-2, EN 300 220-3, 47 CFR FCC Part 15 Subpart C, EN 61000-3-2, EN 61000-3-3, CNS 13439, CNS 13783-1, CNS 14115, CNS 13438, AS/NZS CISPR 22, CNS 13022-1, IEC 61000-4-2/3/4/5/6/8/11, CNS 13022-2/3	
Taiwan	BSMI	CNS 13438, CNS 13783-1, CNS 13439, CNS 14115	 SL2-IS-E-0014 SL2-IN-E-0014 SL2-A1-E-0014 SL2-R1-E-0014 SL2-R2-E-0014 SL2-L1-E-0014
Canada	Industry Canada	3/10 meter Open Area Test Sites (IC 3991-3, IC 3991-4) / 3M Semi Anechoic Chamber (IC 6106) to perform RSS 212 Issue 1	 IC 3991-3 IC 3991-4 IC 6106

* No part of this report may be used to claim or imply product endorsement by A2LA or any agency of the US Government.



6. SETUP OF EQUIPMENT UNDER TEST

6.1 SETUP CONFIGURATION OF EUT

See test photographs attached in Appendix II for the actual connections between EUT and support equipment.

6.2 SUPPORT EQUIPMENT

No.	Device Type	Brand	Model	Series No.	FCC ID	Data Cable	Power Cord
1.	USB Multimedia Keyboard	Chang yang	KB-MED-U	N/A	FCC DoC	Unshielded, 1.8m	N/A
2.	Mouse	DELL	MO56UC	FOA0094M	FCC DoC	Unshielded, 1.8m	N/A

Remark:

1. *All the equipment/cables were placed in the worst-case configuration to maximize the emission during the test.*
2. *Grounding was established in accordance with the manufacturer's requirements and conditions for the intended use.*



7. FCC PART 15.247 REQUIREMENTS

CONDITION A: WLAN OPERATION

7.1 6DB BANDWIDTH

LIMIT

According to §15.247(a)(2), systems using digital modulation techniques may operate in the 902 - 928 MHz, 2400 - 2483.5 MHz, and 5725 - 5850 MHz bands. The minimum 6 dB bandwidth shall be at least 500 kHz.

Test Configuration

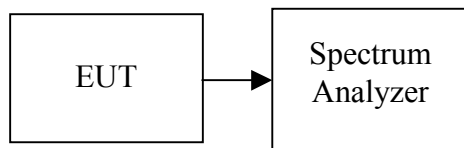

TEST PROCEDURE

1. Place the EUT on the table and set it in the transmitting mode.
2. Remove the antenna from the EUT and then connect a low loss RF cable from the antenna port to the spectrum analyzer.
3. Set the spectrum analyzer as RBW = 100kHz, VBW = RBW, Span = 50MHz, Sweep = auto.
4. Mark the peak frequency and -6dB (upper and lower) frequency.
5. Repeat until all the rest channels are investigated.

TEST RESULTS

No non-compliance noted



Test Data

IEEE 802.11a

Channel	Frequency (MHz)	Bandwidth (kHz)	Limit (kHz)	Test Result
Low	5745	16420	>500	PASS
Mid	5785	16420		PASS
High	5825	15000		PASS

IEEE 802.11b

Channel	Frequency (MHz)	Bandwidth (kHz)	Limit (kHz)	Test Result
Low	2412	8000	>500	PASS
Mid	2437	8580		PASS
High	2462	9500		PASS

IEEE 802.11g

Channel	Frequency (MHz)	Bandwidth (kHz)	Limit (kHz)	Test Result
Low	2412	15830	>500	PASS
Mid	2437	14830		PASS
High	2462	15170		PASS



Test Plot

6dB Bandwidth (IEEE 802.11a / CH Low)

Agilent 11:45:16 Jul 10, 2006

R L

6dB BW, a Mode Low Ch.

Δ Mkr1 16.42 MHz

Ref 20 dBm

Atten 20 dB

0.75 dB

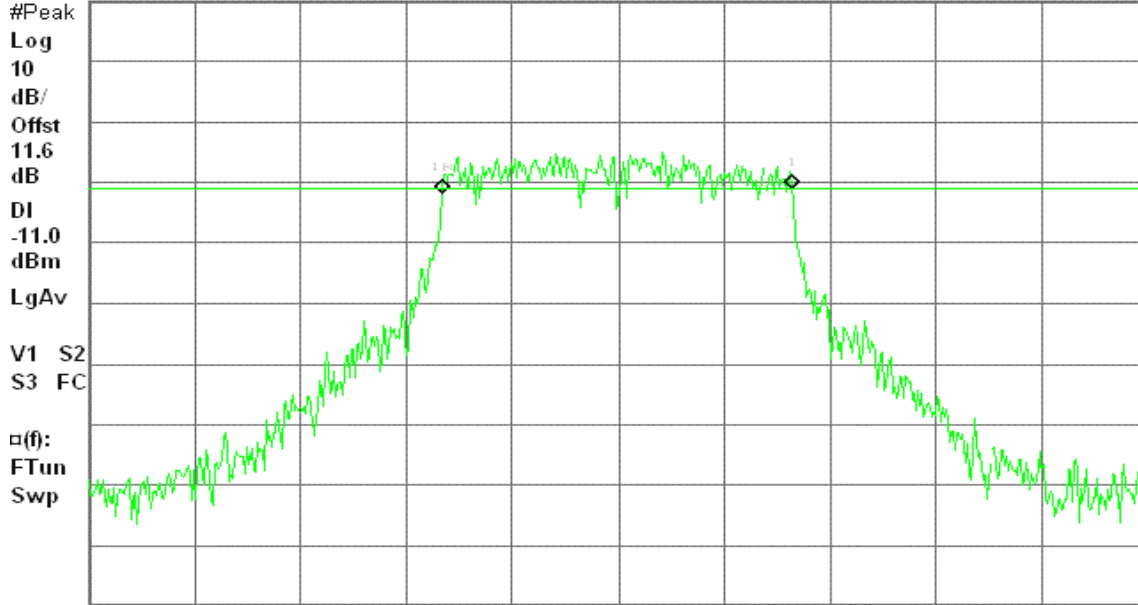

Center 5.745 00 GHz

Span 50 MHz

#Res BW 100 kHz

#VBW 100 kHz

Sweep 6.04 ms (601 pts)

6dB Bandwidth (IEEE 802.11a / CH Mid)

Agilent 20:11:59 Jul 10, 2006

R L

6dB BW, a Mode Mid Ch.

Δ Mkr1 16.42 MHz

Ref 20 dBm

Atten 20 dB

-0.43 dB

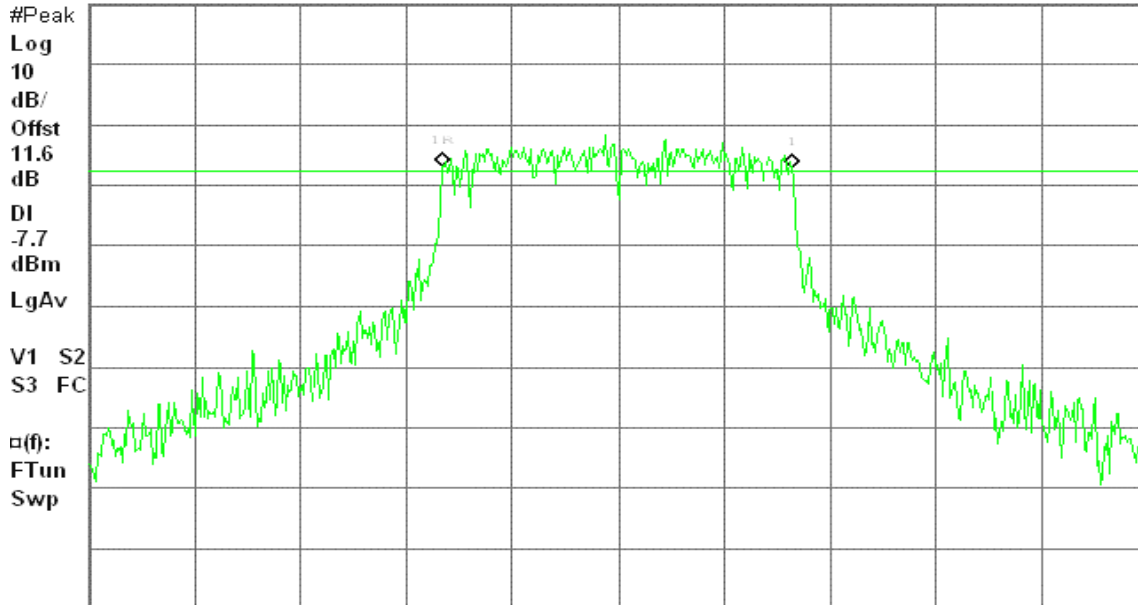

Center 5.785 00 GHz

Span 50 MHz

#Res BW 100 kHz

#VBW 100 kHz

Sweep 6.04 ms (601 pts)



6dB Bandwidth (IEEE 802.11a / CH High)

Agilent 20:22:26 Jul 10, 2006

R L

6dB BW, a Mode High Ch.

Δ Mkr1 15.00 MHz

Ref 20 dBm

Atten 20 dB

0.58 dB

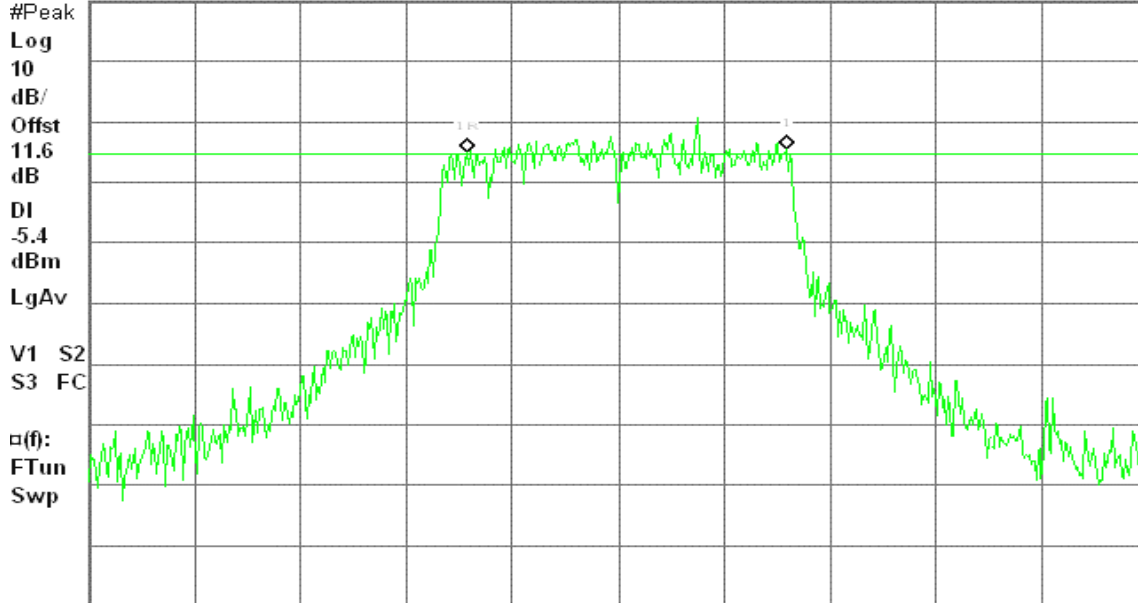

Center 5.825 00 GHz

Span 50 MHz

#Res BW 100 kHz

#VBW 100 kHz

Sweep 6.04 ms (601 pts)

6dB Bandwidth (IEEE 802.11b / CH Low)

Agilent 18:29:47 Jul 10, 2006

R L

6dB BW, b Mode Low Ch.

Δ Mkr1 8.00 MHz

Ref 30 dBm

Atten 30 dB

0.53 dB

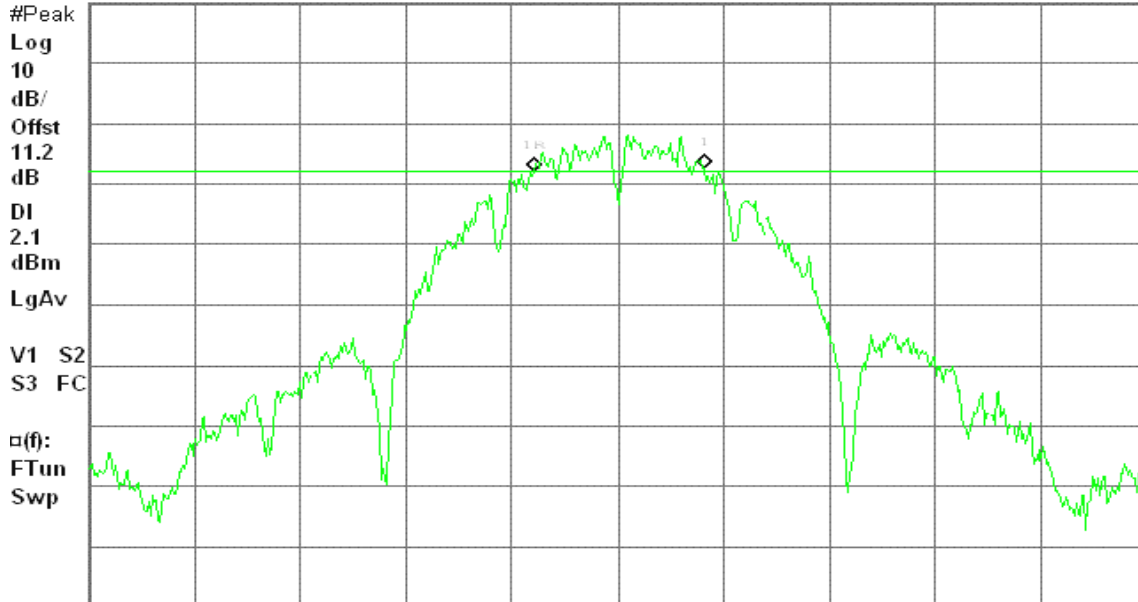

Center 2.412 00 GHz

Span 50 MHz

#Res BW 100 kHz

#VBW 100 kHz

Sweep 6.04 ms (601 pts)



6dB Bandwidth (IEEE 802.11b / CH Mid)

Agilent 18:35:17 Jul 10, 2006

R L

6dB BW, b Mode Mid Ch.

Δ Mkr1 8.58 MHz

Ref 30 dBm

Atten 30 dB

-2.36 dB

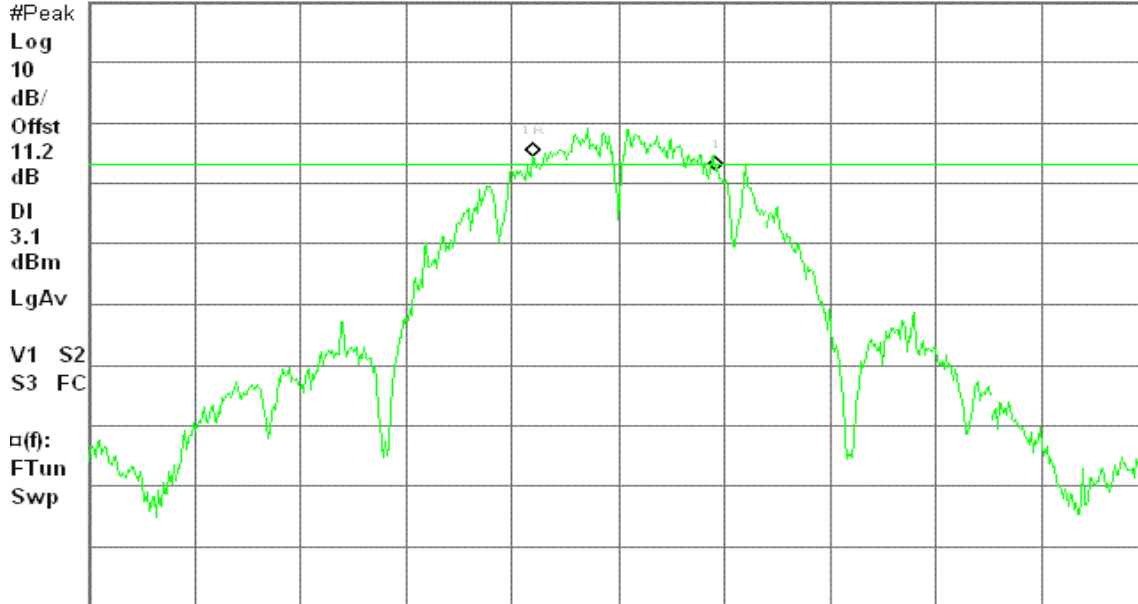

Center 2.437 00 GHz

Span 50 MHz

#Res BW 100 kHz

#VBW 100 kHz

Sweep 6.04 ms (601 pts)

6dB Bandwidth (IEE 802.11b / CH High)

Agilent 18:43:10 Jul 10, 2006

R L

6dB BW, b Mode High Ch.

Δ Mkr1 9.50 MHz

Ref 30 dBm

Atten 30 dB

0.94 dB

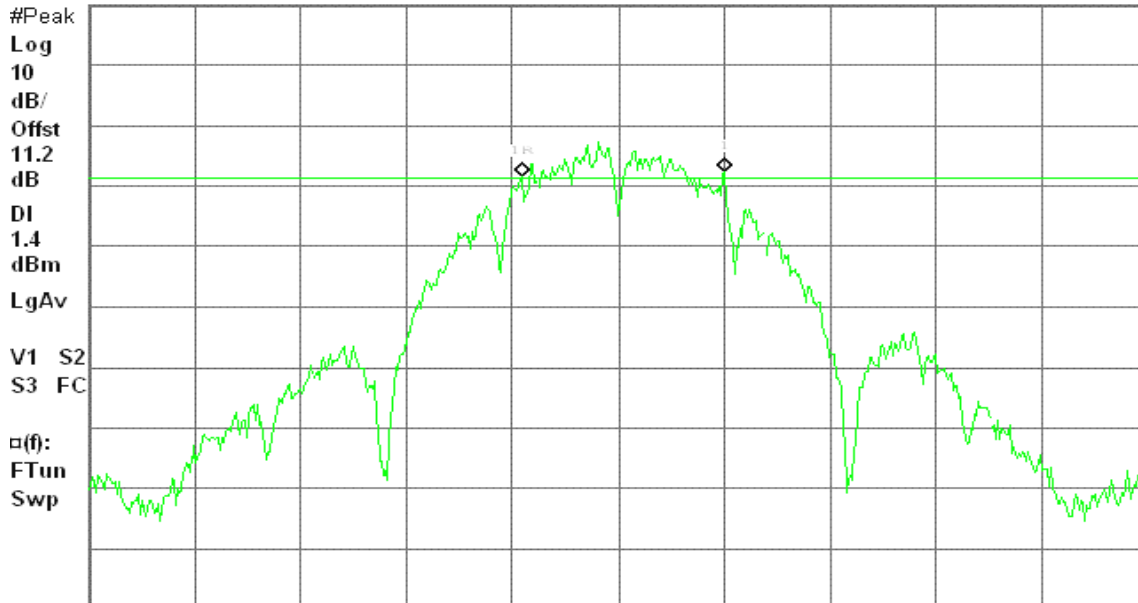

Center 2.462 00 GHz

Span 50 MHz

#Res BW 100 kHz

#VBW 100 kHz

Sweep 6.04 ms (601 pts)



6dB Bandwidth (IEEE 802.11g / CH Low)

Agilent 19:04:20 Jul 10, 2006

R L

6dB BW, g Mode Low Ch.

Δ Mkr1 15.83 MHz

Ref 30 dBm

Atten 30 dB

-0.44 dB

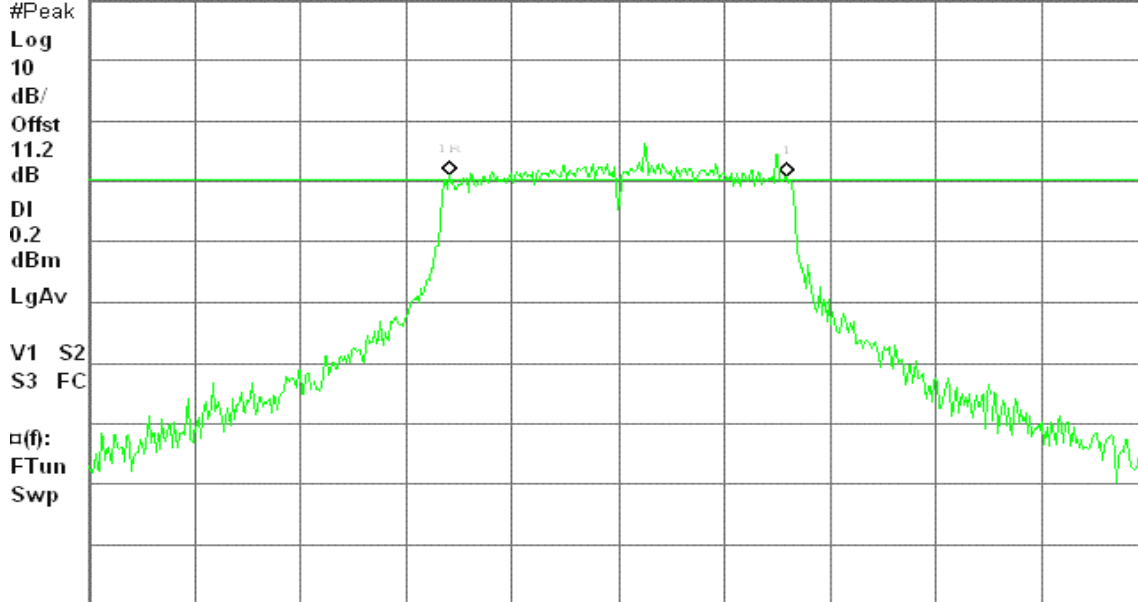

Center 2.412 00 GHz

Span 50 MHz

#Res BW 100 kHz

#VBW 100 kHz

Sweep 6.04 ms (601 pts)

6dB Bandwidth (IEEE 802.11g / CH Mid)

Agilent 19:15:53 Jul 10, 2006

R L

6dB BW, g Mode Mid Ch.

Δ Mkr1 14.83 MHz

Ref 30 dBm

Atten 30 dB

0.30 dB

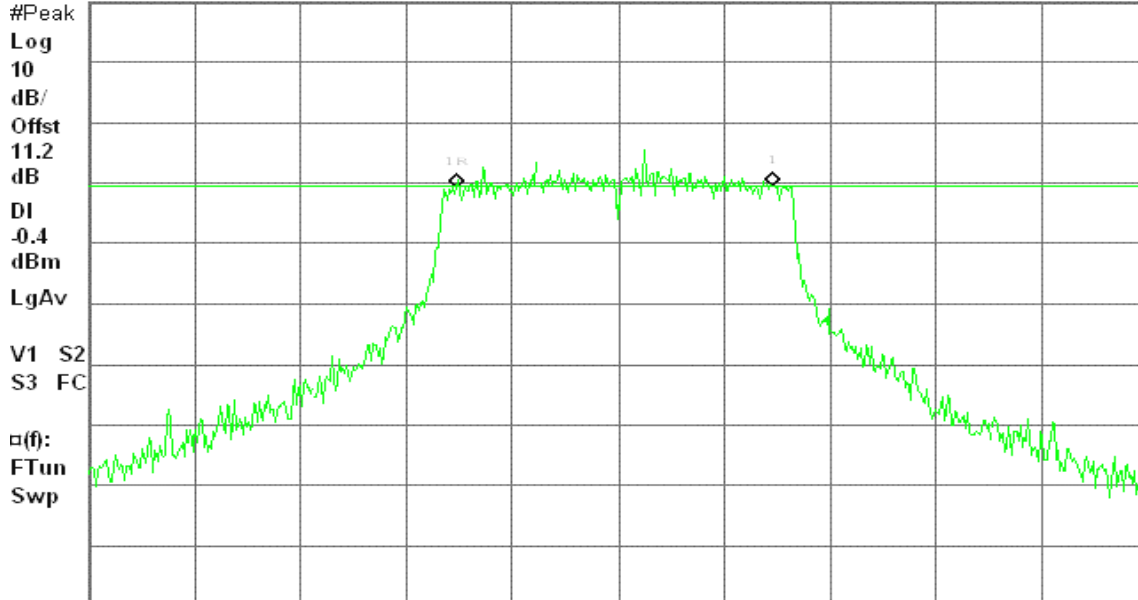

Center 2.437 00 GHz

Span 50 MHz

#Res BW 100 kHz

#VBW 100 kHz

Sweep 6.04 ms (601 pts)



6dB Bandwidth (IEEE 802.11g / CH High)

Agilent 19:26:21 Jul 10, 2006

R L

6dB BW, g Mode High Ch.

Δ Mkr1 15.17 MHz

Ref 30 dBm

Atten 30 dB

0.76 dB

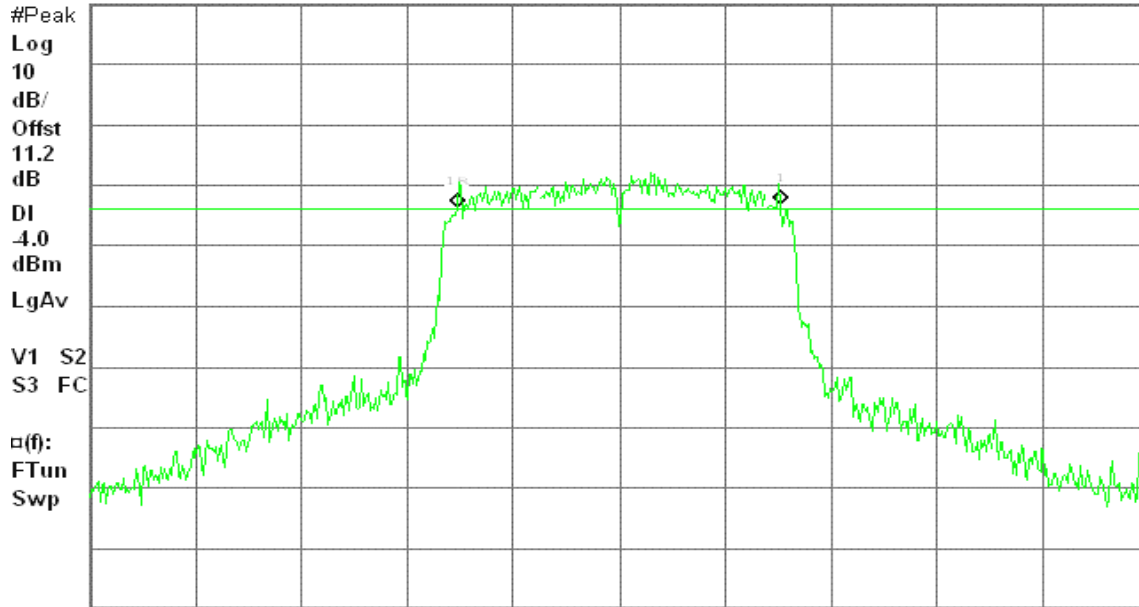

Center 2.462 00 GHz

Span 50 MHz

#Res BW 100 kHz

#VBW 100 kHz

Sweep 6.04 ms (601 pts)

7.2 PEAK POWER

LIMIT

The maximum peak output power of the intentional radiator shall not exceed the following:

1. According to §15.247(b)(3), for systems using digital modulation in the bands of 902-928 MHz, 2400-2483.5 MHz, and 5725-5850 MHz: 1 Watt.
2. According to §15.247(b)(4), the conducted output power limit specified in paragraph (b) of this section is based on the use of antennas with directional gains that do not exceed 6 dBi. Except as shown in paragraph (c) of this section, if transmitting antennas of directional gain greater than 6 dBi are used, the conducted output power from the intentional radiator shall be reduced below the stated values in paragraphs (b)(1), (b)(2), and (b)(3) of this section, as appropriate, by the amount in dB that the directional gain of the antenna exceeds 6 dBi.

Test Configuration

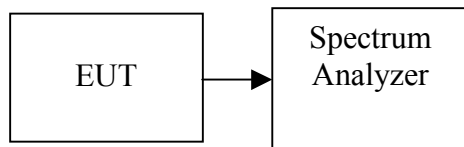

TEST PROCEDURE

The transmitter output is connected to the Spectrum analyzer. The Spectrum analyzer is set to the peak power detection.

TEST RESULTS

No non-compliance noted



Test Data

IEEE 802.11a

Channel	Frequency (MHz)	Output Power (dBm)	Output Power (W)	Limit (W)	Test Result
Low	5745	13.70	0.0234	1	PASS
Mid	5785	14.56	0.0286		PASS
High	5825	14.61	0.0289		PASS

IEEE 802.11b

Channel	Frequency (MHz)	Output Power (dBm)	Output Power (W)	Limit (W)	Test Result
Low	2412	16.44	0.0441	1	PASS
Mid	2437	16.97	0.0498		PASS
High	2462	16.86	0.0485		PASS

IEEE 802.11g

Channel	Frequency (MHz)	Output Power (dBm)	Output Power (W)	Limit (W)	Test Result
Low	2412	14.82	0.0303	1	PASS
Mid	2437	13.74	0.0237		PASS
High	2462	13.72	0.0236		PASS



Test Plot

Peak Power (IEEE 802.11a / CH Low)

Agilent 11:46:32 Jul 10, 2006

R L

Peak Output Power , a Mode Low Ch.

Ref 20 dBm

Atten 20 dB

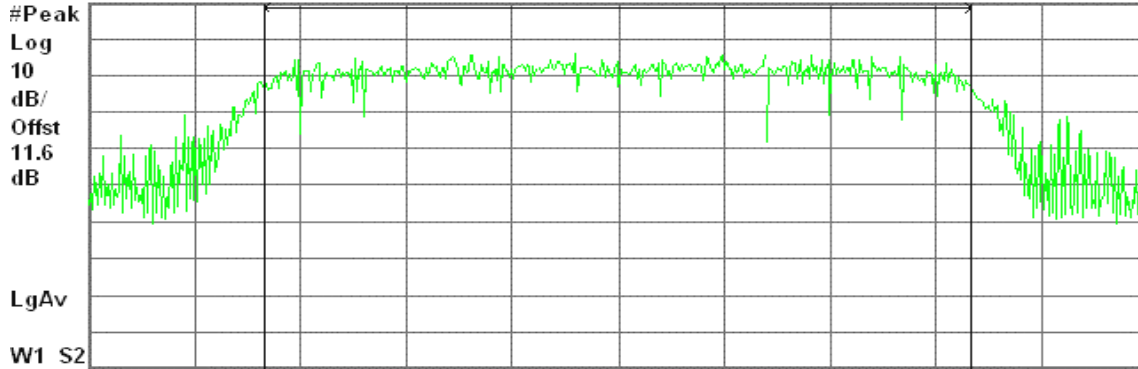

Center 5.745 00 GHz

Span 24.83 MHz

#Res BW 1 MHz

#VBW 3 MHz

Sweep 1 ms (601 pts)

Channel Power

Power Spectral Density

13.70 dBm / 16.5540 MHz

-58.49 dBm/Hz

Peak Power (IEEE 802.11a / CH Mid)

Agilent 13:06:39 Jul 10, 2006

R L

Peak Output Power , a Mode Mid Ch.

Ref 20 dBm

Atten 20 dB

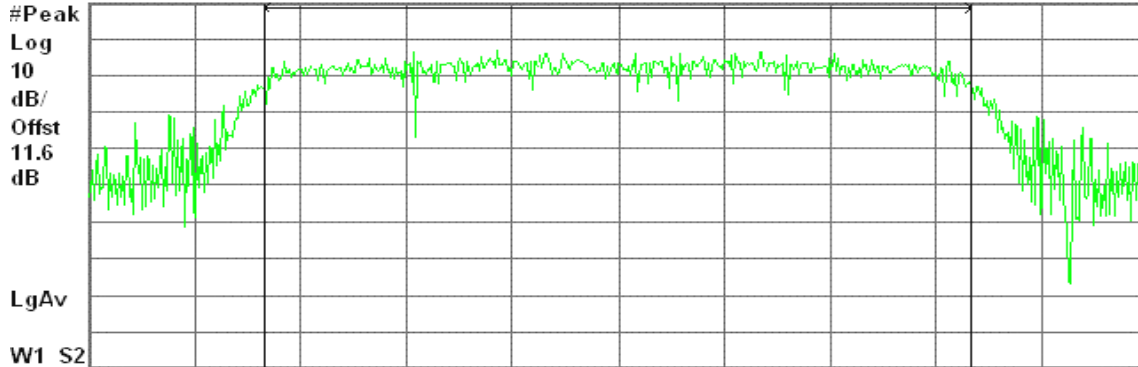

Center 5.785 00 GHz

Span 24.93 MHz

#Res BW 1 MHz

#VBW 3 MHz

Sweep 1 ms (601 pts)

Channel Power

Power Spectral Density

14.56 dBm / 16.6200 MHz

-57.64 dBm/Hz



Peak Power (IEEE 802.11a / CH High)

Agilent 13:09:03 Jul 10, 2006

R L

Peak Output Power , a Mode High Ch.

Ref 20 dBm

Atten 20 dB

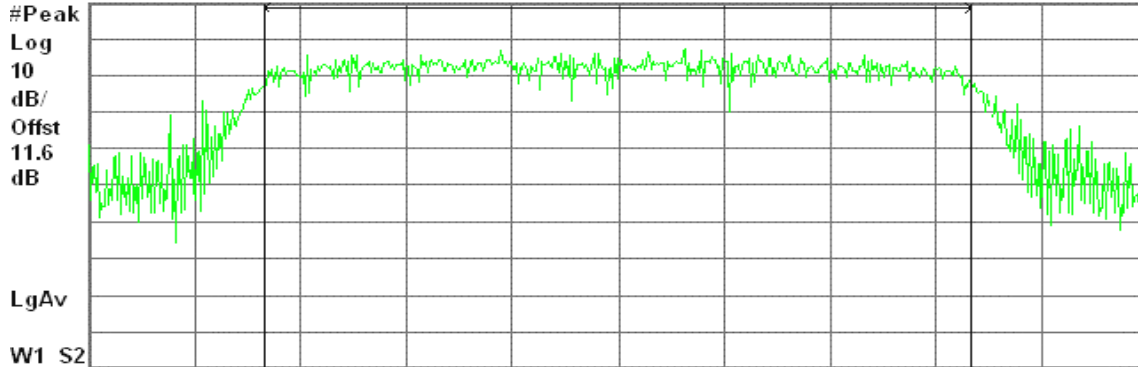

Center 5.825 00 GHz

Span 24.82 MHz

#Res BW 1 MHz

#VBW 3 MHz

Sweep 1 ms (601 pts)

Channel Power

Power Spectral Density

14.61 dBm / 16.5500 MHz

-57.58 dBm/Hz

Peak Power (IEEE 802.11b / CH Low)

Agilent 10:58:13 Jul 10, 2006

R L

Peak Output Power , b Mode Low Ch.

Ref 20 dBm

Atten 20 dB

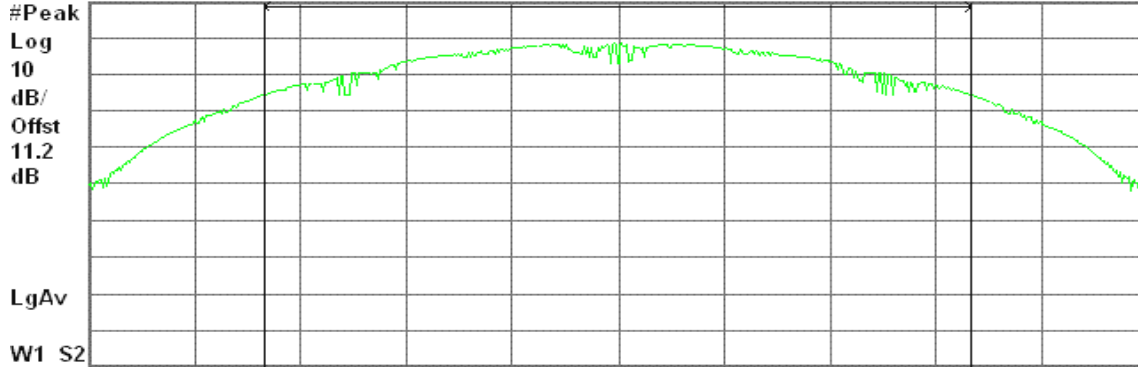

Center 2.412 00 GHz

Span 22.24 MHz

#Res BW 1 MHz

#VBW 3 MHz

Sweep 1 ms (601 pts)

Channel Power

Power Spectral Density

16.44 dBm / 14.8280 MHz

-55.27 dBm/Hz



Peak Power (IEEE 802.11b / CH Mid)

Agilent 10:59:55 Jul 10, 2006

R L

Peak Output Power , b Mode Mid Ch.

Ref 20 dBm

Atten 20 dB

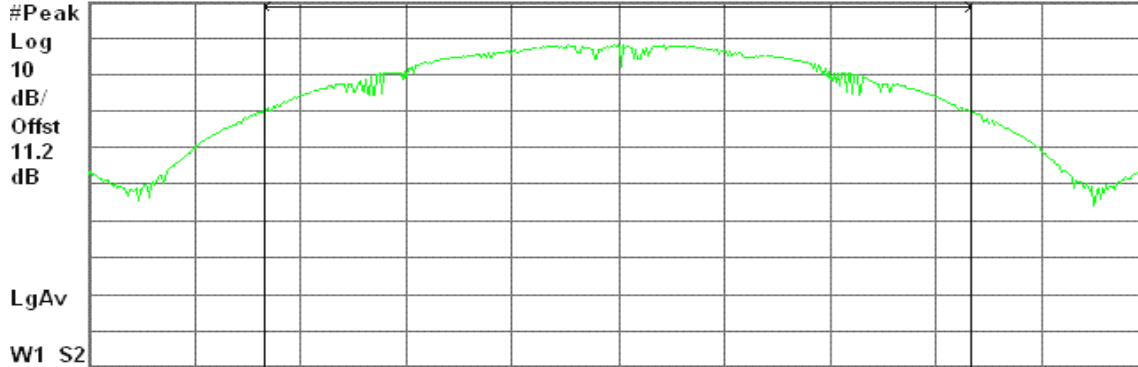

Center 2.437 00 GHz

Span 24.91 MHz

#Res BW 1 MHz

#VBW 3 MHz

Sweep 1 ms (601 pts)

Channel Power

Power Spectral Density

16.97 dBm / 16.6100 MHz

-55.23 dBm/Hz

Peak Power (IEEE 802.11b / CH High)

Agilent 11:02:54 Jul 10, 2006

R L

Peak Output Power , b Mode High Ch.

Ref 20 dBm

Atten 20 dB

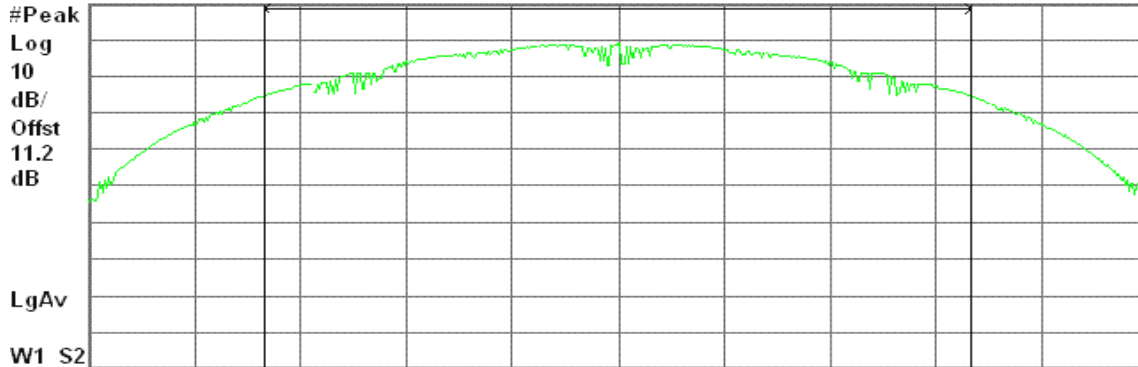

Center 2.462 00 GHz

Span 22.33 MHz

#Res BW 1 MHz

#VBW 3 MHz

Sweep 1 ms (601 pts)

Channel Power

Power Spectral Density

16.86 dBm / 14.8890 MHz

-54.87 dBm/Hz



Peak Power (IEEE 802.11g / CH Low)

Agilent 11:12:19 Jul 10, 2006

R L

Peak Output Power , g Mode Low Ch.

Ref 20 dBm

Atten 20 dB

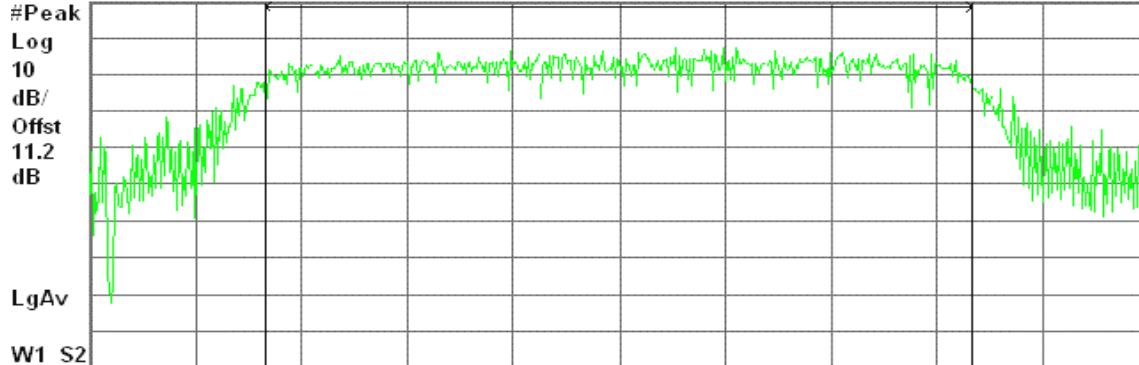

Center 2.412 00 GHz

Span 24.89 MHz

#Res BW 1 MHz

#VBW 3 MHz

Sweep 1 ms (601 pts)

Channel Power

Power Spectral Density

14.82 dBm / 16.5960 MHz

-57.38 dBm/Hz

Peak Power (IEEE 802.11g / CH Mid)

Agilent 11:15:08 Jul 10, 2006

R L

Peak Output Power , g Mode Mid Ch.

Ref 20 dBm

Atten 20 dB

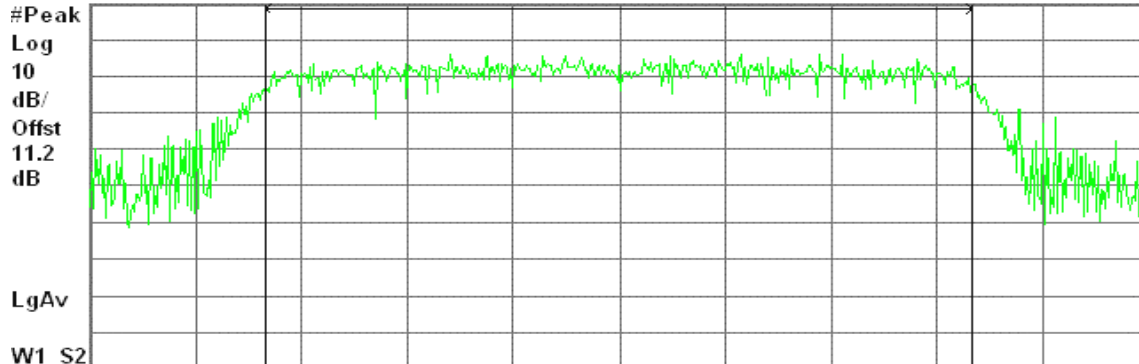

Center 2.437 00 GHz

Span 24.92 MHz

#Res BW 1 MHz

#VBW 3 MHz

Sweep 1 ms (601 pts)

Channel Power

Power Spectral Density

13.74 dBm / 16.6101 MHz

-58.47 dBm/Hz



Peak Power (IEEE 802.11g / CH High)

Agilent 11:33:15 Jul 10, 2006

R L

Peak Output Power , g Mode High Ch.

Ref 20 dBm

Atten 20 dB

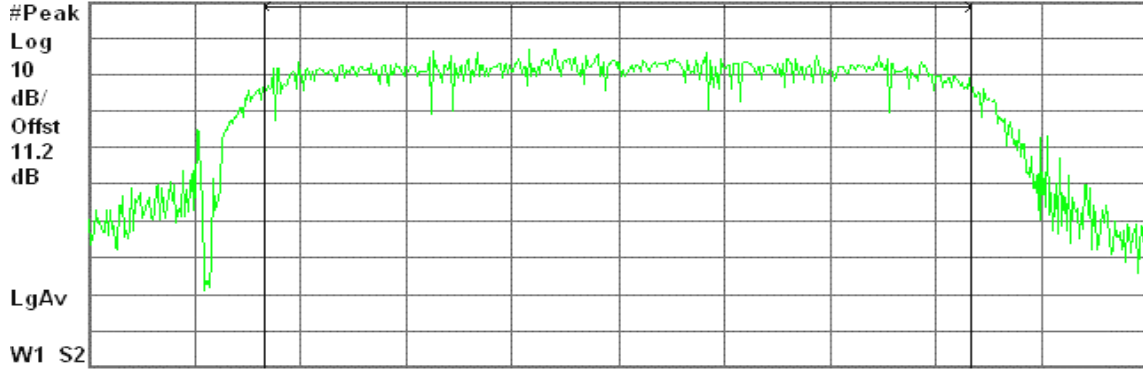

Center 2.462 00 GHz

Span 23.99 MHz

#Res BW 1 MHz

#VBW 3 MHz

Sweep 1 ms (601 pts)

Channel Power

Power Spectral Density

13.72 dBm / 15.9940 MHz

-58.32 dBm/Hz



7.3 AVERAGE POWER

LIMIT

None; for reporting purposes only.

Test Configuration

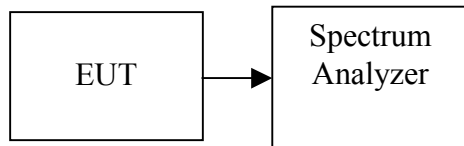

TEST PROCEDURE

The transmitter output is connected to the Spectrum analyzer. The Spectrum analyzer is set to the peak power detection.



TEST RESULTS

No non-compliance noted

Test Data

IEEE 802.11a

Channel	Frequency (MHz)	Output Power (dBm)	Output Power (W)
Low	5745	10.34	0.0108
Mid	5785	10.72	0.0118
High	5825	10.93	0.0124

IEEE 802.11b

Channel	Frequency (MHz)	Output Power (dBm)	Output Power (W)
Low	2412	13.81	0.0240
Mid	2437	14.80	0.0302
High	2462	14.45	0.0279

IEEE 802.11g

Channel	Frequency (MHz)	Output Power (dBm)	Output Power (W)
Low	2412	11.36	0.0137
Mid	2437	10.39	0.0109
High	2462	10.30	0.0107



Test Plot

Average Power (IEEE 802.11a / CH Low)

Agilent 11:47:15 Jul 10, 2006

R L

AVG Output Power , a Mode Low Ch.

Ref 30 dBm

Atten 30 dB

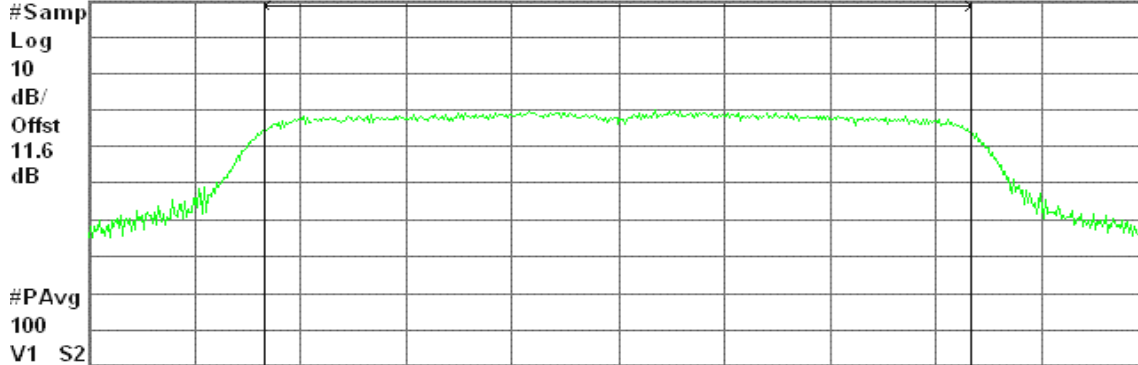

Center 5.745 00 GHz

Span 24.83 MHz

#Res BW 1 MHz

#VBW 3 MHz

Sweep 1 ms (601 pts)

Channel Power

Power Spectral Density

10.34 dBm / 16.5540 MHz

-61.85 dBm/Hz

Average Power (IEEE 802.11a / CH Mid)

Agilent 13:08:00 Jul 10, 2006

R L

AVG Output Power , a Mode Mid Ch.

Ref 30 dBm

Atten 30 dB

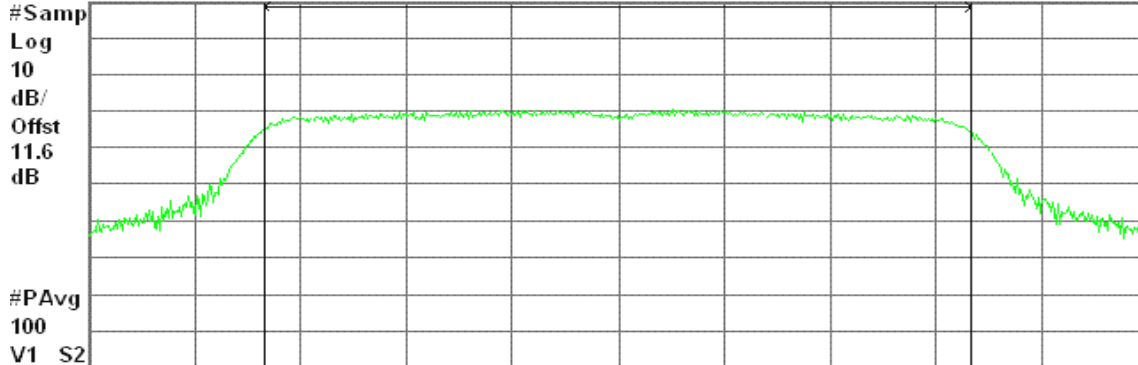

Center 5.785 00 GHz

Span 24.93 MHz

#Res BW 1 MHz

#VBW 3 MHz

Sweep 1 ms (601 pts)

Channel Power

Power Spectral Density

10.72 dBm / 16.6200 MHz

-61.49 dBm/Hz



Average Power (IEEE 802.11a / CH High)

Agilent 13:09:37 Jul 10, 2006

R L

AVG Output Power , a Mode High Ch.

Ref 30 dBm

Atten 30 dB

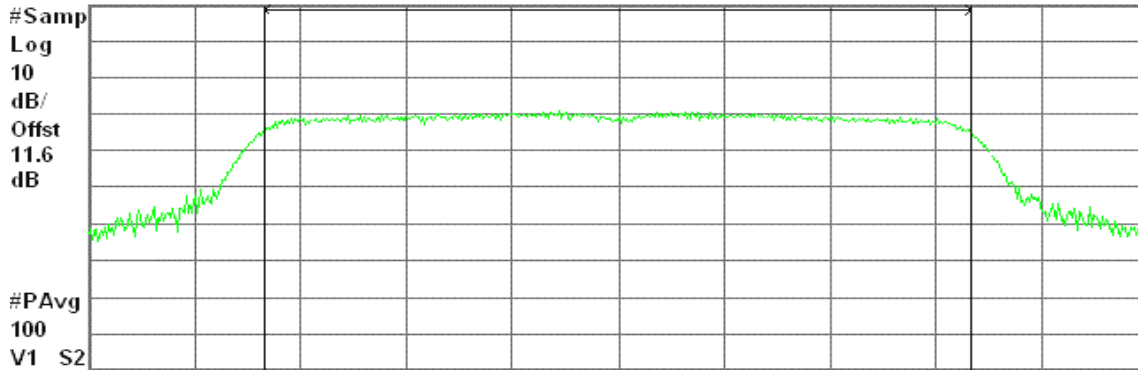

Center 5.825 00 GHz

Span 24.82 MHz

#Res BW 1 MHz

#VBW 3 MHz

Sweep 1 ms (601 pts)

Channel Power

Power Spectral Density

10.93 dBm / 16.5500 MHz

-61.26 dBm/Hz

Average Power (IEEE 802.11b / CH Low)

Agilent 10:59:00 Jul 10, 2006

R L

AVG Output Power , b Mode Low Ch.

Ref 30 dBm

Atten 30 dB

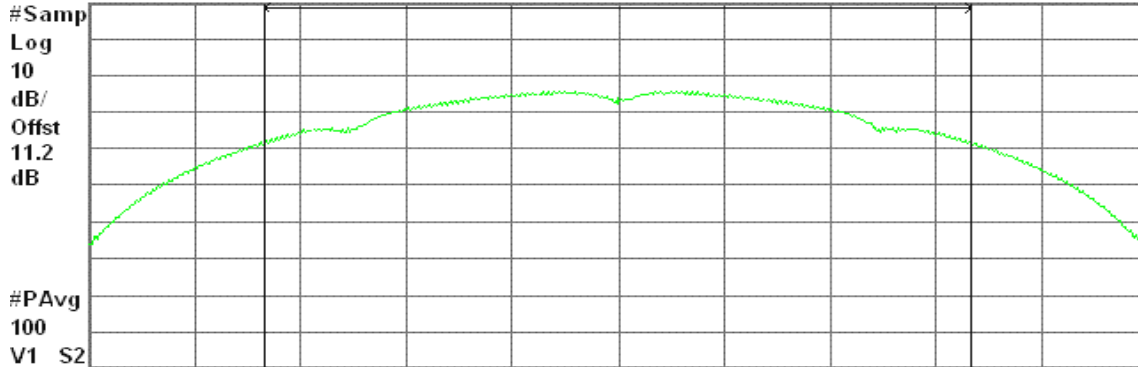

Center 2.412 00 GHz

Span 22.24 MHz

#Res BW 1 MHz

#VBW 3 MHz

Sweep 1 ms (601 pts)

Channel Power

Power Spectral Density

13.81 dBm / 14.8280 MHz

-57.90 dBm/Hz



Average Power (IEEE 802.11b / CH Mid)

Agilent 11:00:50 Jul 10, 2006

R L

AVG Output Power , b Mode Mid Ch.

Ref 30 dBm

Atten 30 dB

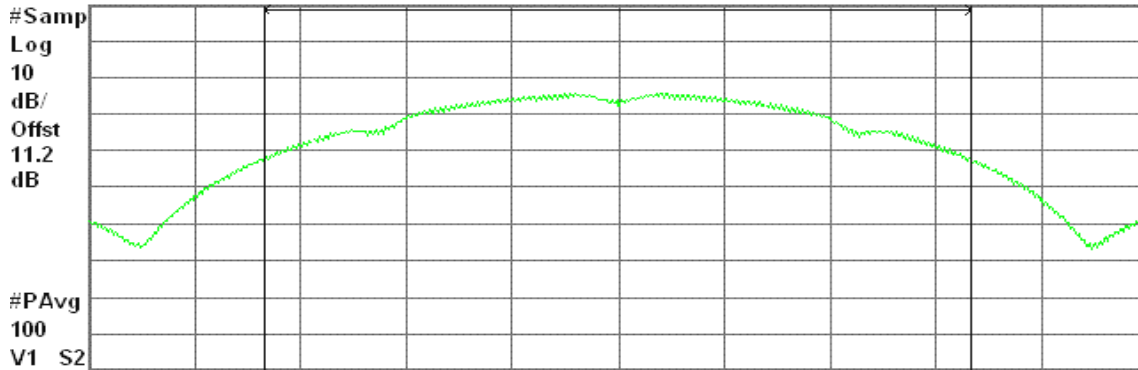

Center 2.437 00 GHz

Span 24.91 MHz

#Res BW 1 MHz

#VBW 3 MHz

Sweep 1 ms (601 pts)

Channel Power

Power Spectral Density

14.80 dBm / 16.6100 MHz

-57.40 dBm/Hz

Average Power (IEEE 802.11b / CH High)

Agilent 11:03:26 Jul 10, 2006

R L

AVG Output Power , b Mode High Ch.

Ref 30 dBm

Atten 30 dB

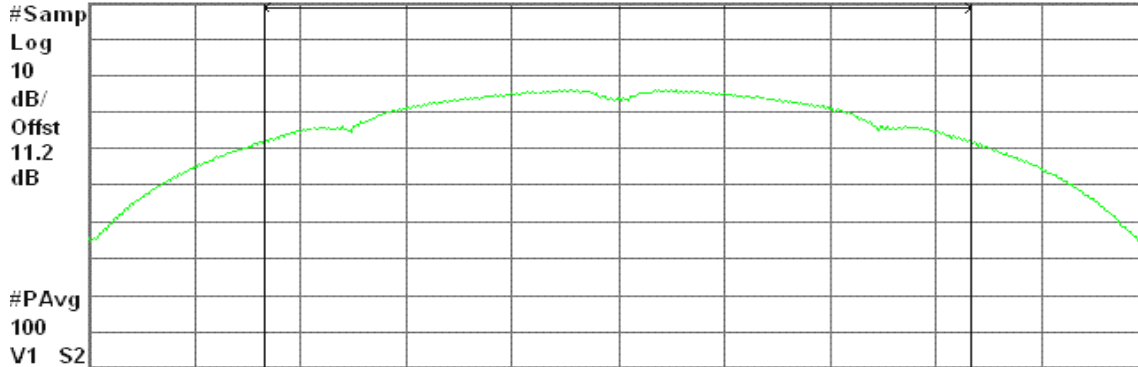

Center 2.462 00 GHz

Span 22.33 MHz

#Res BW 1 MHz

#VBW 3 MHz

Sweep 1 ms (601 pts)

Channel Power

Power Spectral Density

14.45 dBm / 14.8890 MHz

-57.27 dBm/Hz



Average Power (IEEE 802.11g / CH Low)

Agilent 11:13:05 Jul 10, 2006

R L

AVG Output Power , g Mode Low Ch.

Ref 30 dBm

Atten 30 dB

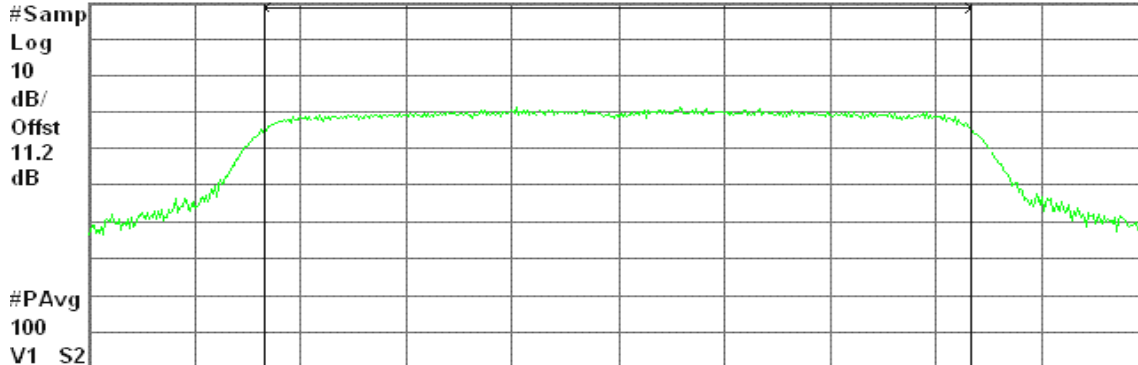

Channel Power

11.36 dBm / 16.5960 MHz

Power Spectral Density

-60.84 dBm/Hz

Average Power (IEEE 802.11g / CH Mid)

Agilent 11:15:52 Jul 10, 2006

R L

AVG Output Power , g Mode Mid Ch.

Ref 30 dBm

Atten 30 dB

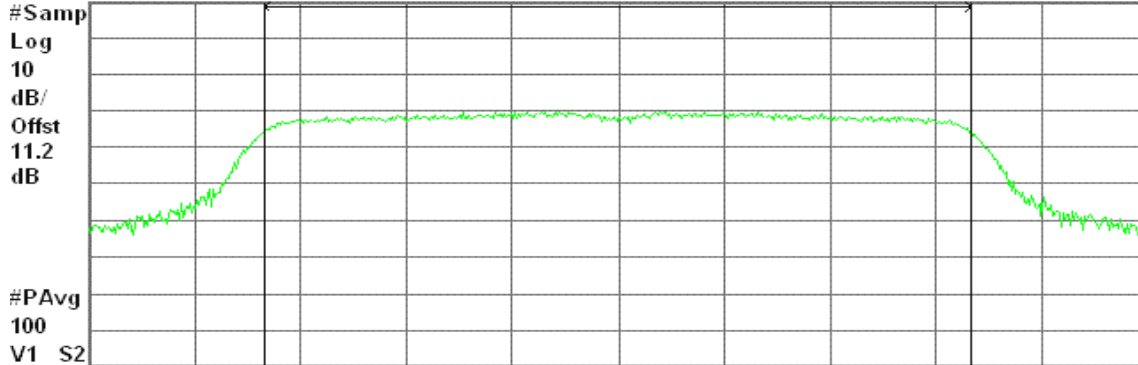

Channel Power

10.39 dBm / 16.6101 MHz

Power Spectral Density

-61.81 dBm/Hz



Average Power (IEEE 802.11g / CH High)

Agilent 11:33:58 Jul 10, 2006

R L

AVG Output Power , g Mode High Ch.

Ref 30 dBm

Atten 30 dB

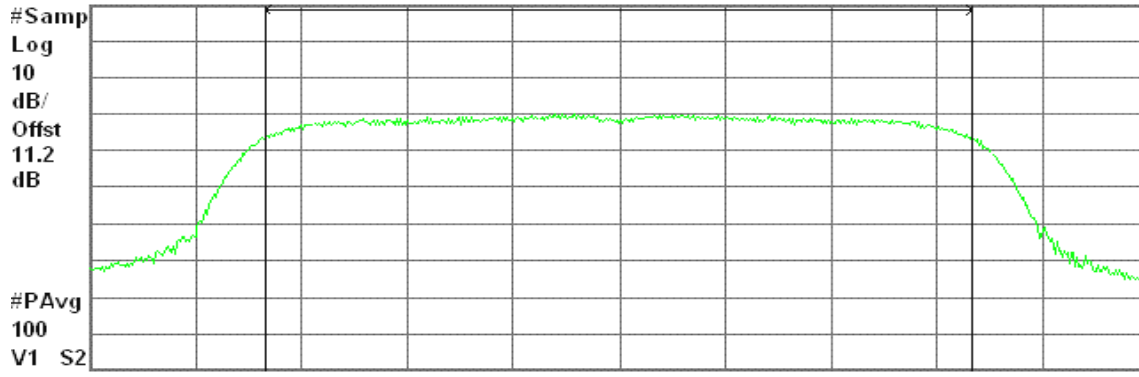

Center 2.462 00 GHz

Span 23.99 MHz

#Res BW 1 MHz

#VBW 3 MHz

Sweep 1 ms (601 pts)

Channel Power

Power Spectral Density

10.30 dBm / 15.9940 MHz

-61.74 dBm/Hz

7.4 BAND EDGES MEASUREMENT

LIMIT

According to §15.247(d), in any 100 kHz bandwidth outside the frequency bands in which the spread spectrum intentional radiator is operating, the radio frequency power that is produced by the intentional radiator shall be at least 20 dB below that in the 100 kHz bandwidth within the band that contains the highest level of the desired power, based on either an RF conducted or a radiated measurement, provided the transmitter demonstrates compliance with the peak conducted power limits. In addition, radiated emissions which fall in the restricted bands, as defined in §15.205(a), must also comply with the radiated emission limits specified in 15.209(a) (see Section 15.205(c)).

Test Configuration

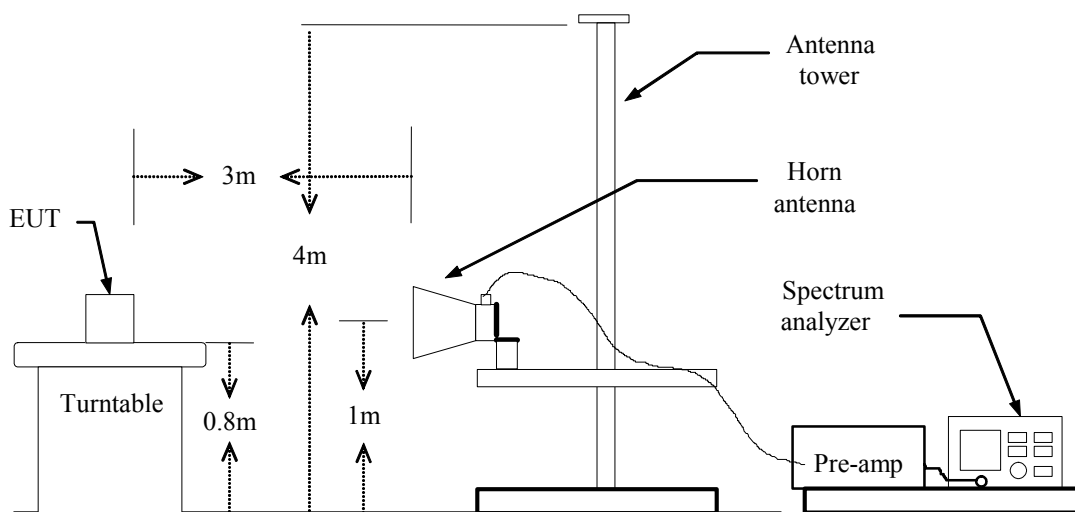

TEST PROCEDURE

1. The EUT is placed on a turntable, which is 0.8m above the ground plane.
2. The turntable shall be rotated for 360 degrees to determine the position of maximum emission level.
3. EUT is set 3m away from the receiving antenna, which is varied from 1m to 4m to find out the highest emission.
4. Set the spectrum analyzer in the following setting in order to capture the lower and upper band-edges of the emission:
 - (a) PEAK: RBW=VBW=1MHz / Sweep=AUTO
 - (b) AVERAGE: RBW=1MHz / VBW=10Hz / Sweep=AUTO
5. Repeat the procedures until all the PEAK and AVERAGE versus POLARIZATION are measured.

TEST RESULTS

Refer to attach spectrum analyzer data chart.



Band Edges (IEEE 802.11b / CH Low)

Detector mode: Peak

Polarity: Vertical

Agilent 11:59:50 Jul 8, 2006

R T

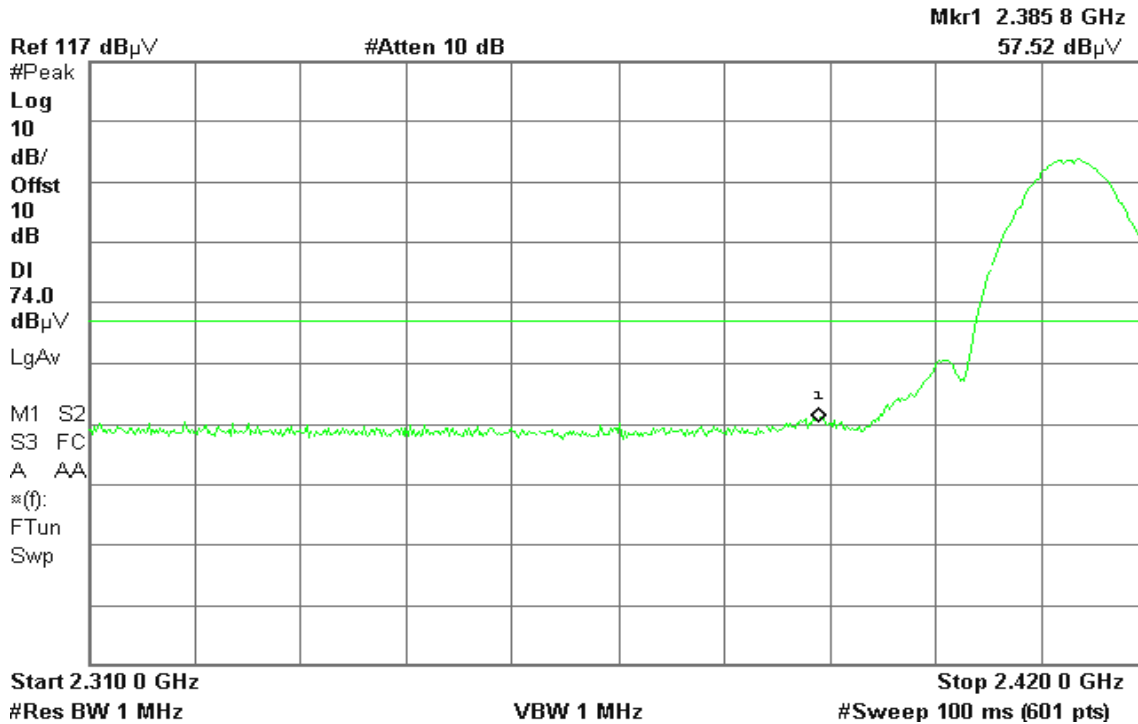

Detector mode: Average

Polarity: Vertical

Agilent 11:59:14 Jul 8, 2006

R T





Detector mode: Peak

Polarity: Horizontal

Agilent 11:53:11 Jul 8, 2006

R T

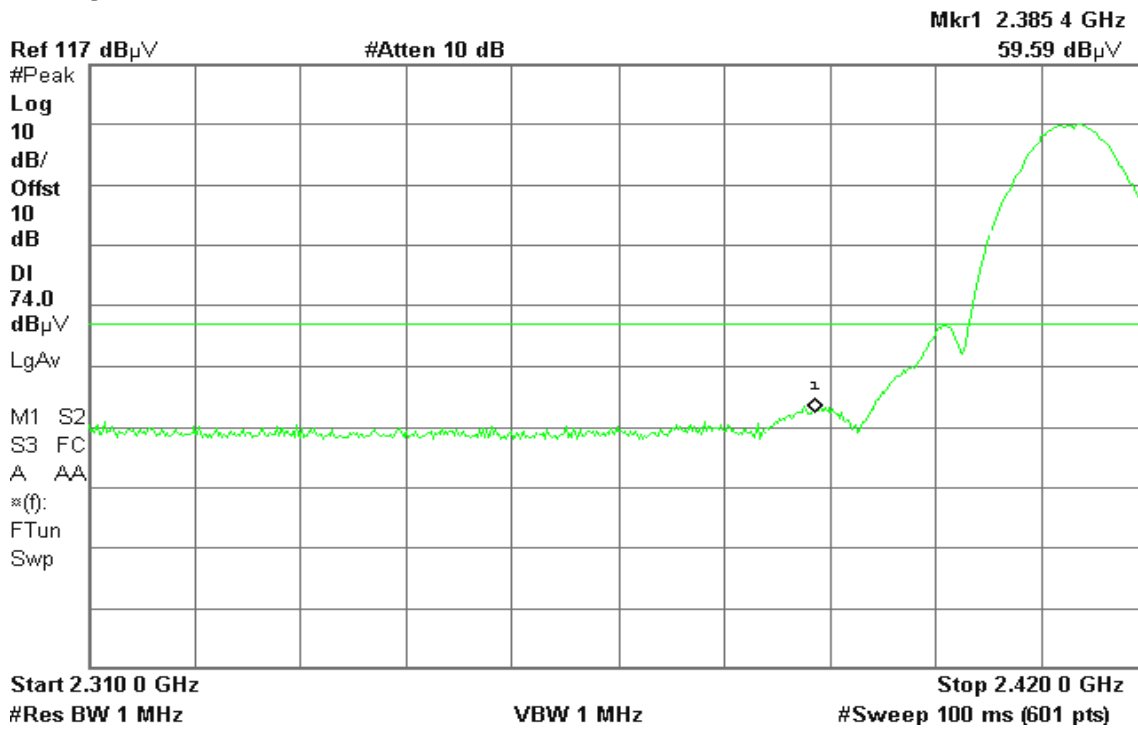

Detector mode: Average

Polarity: Horizontal

Agilent 11:52:47 Jul 8, 2006

R T





Band Edges (IEEE 802.11b / CH High)

Detector mode: Peak

Polarity: Vertical

Agilent 12:13:11 Jul 8, 2006

R T

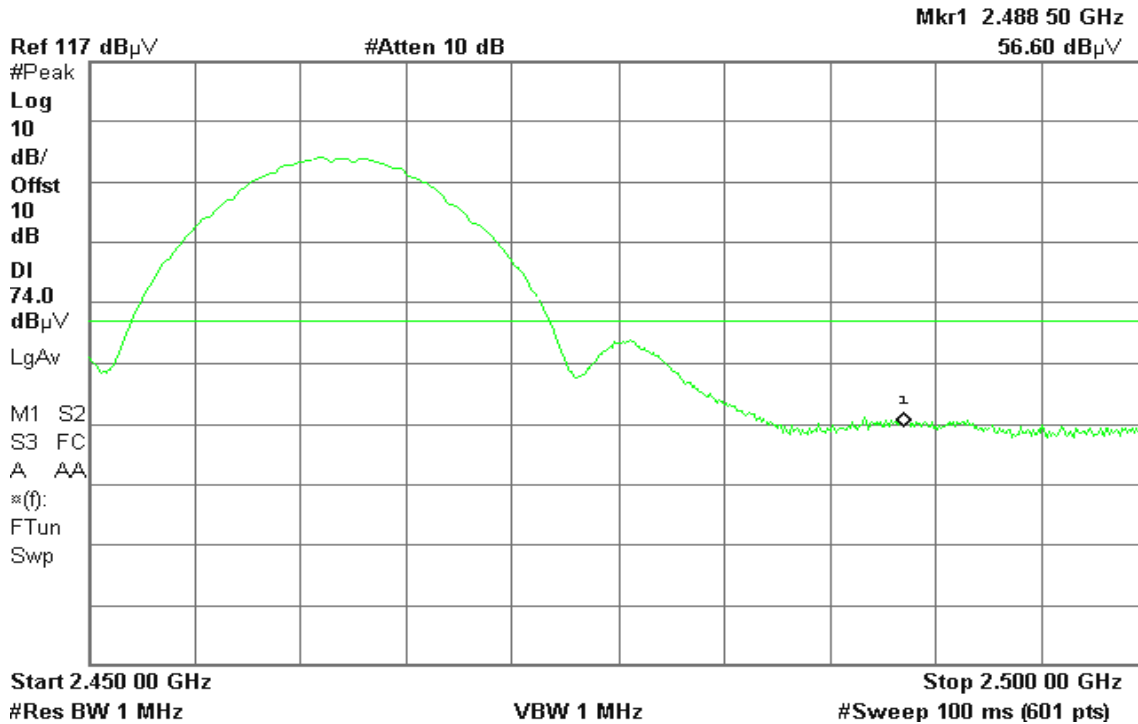

Detector mode: Average

Polarity: Vertical

Agilent 12:12:53 Jul 8, 2006

R T

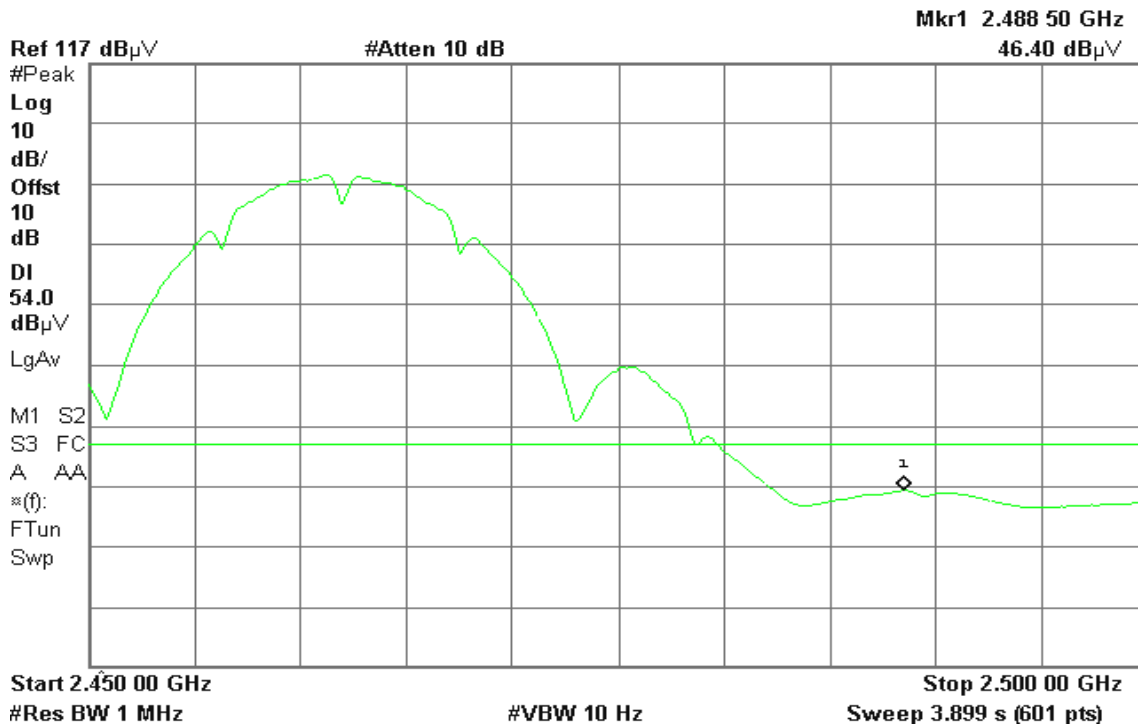



Detector mode: Peak

Polarity: Horizontal

Agilent 12:08:06 Jul 8, 2006

R T

Mkr1 2.488 75 GHz
59.54 dB μ V

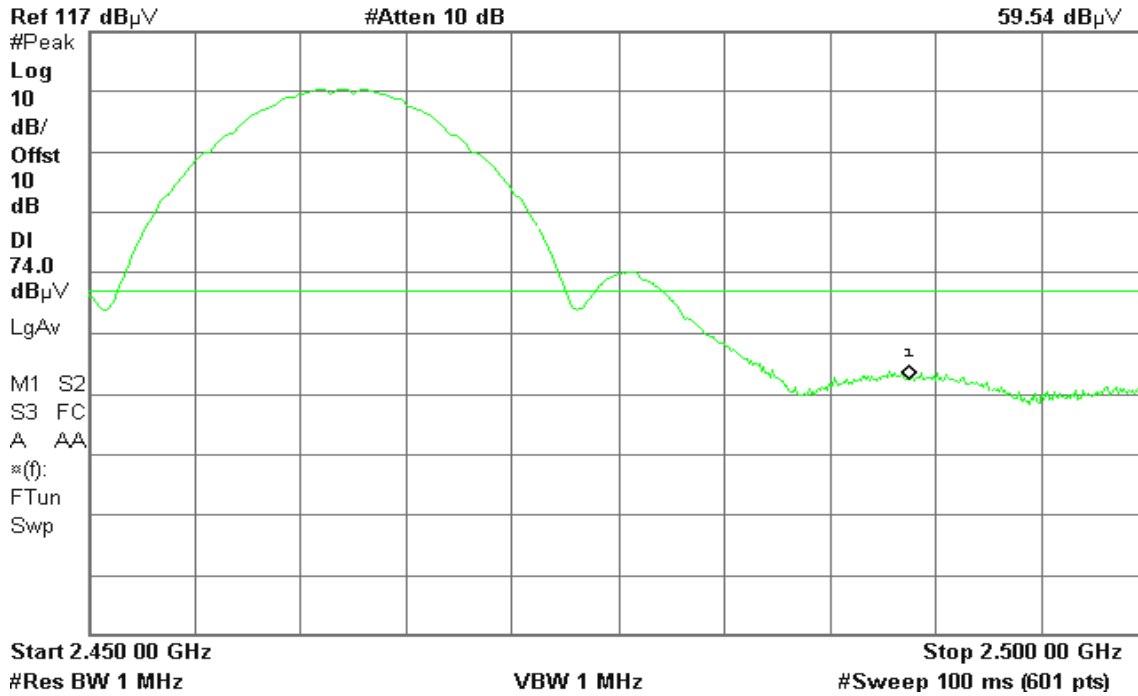

Detector mode: Average

Polarity: Horizontal

Agilent 12:07:44 Jul 8, 2006

R T

Mkr1 2.488 75 GHz
51.81 dB μ V

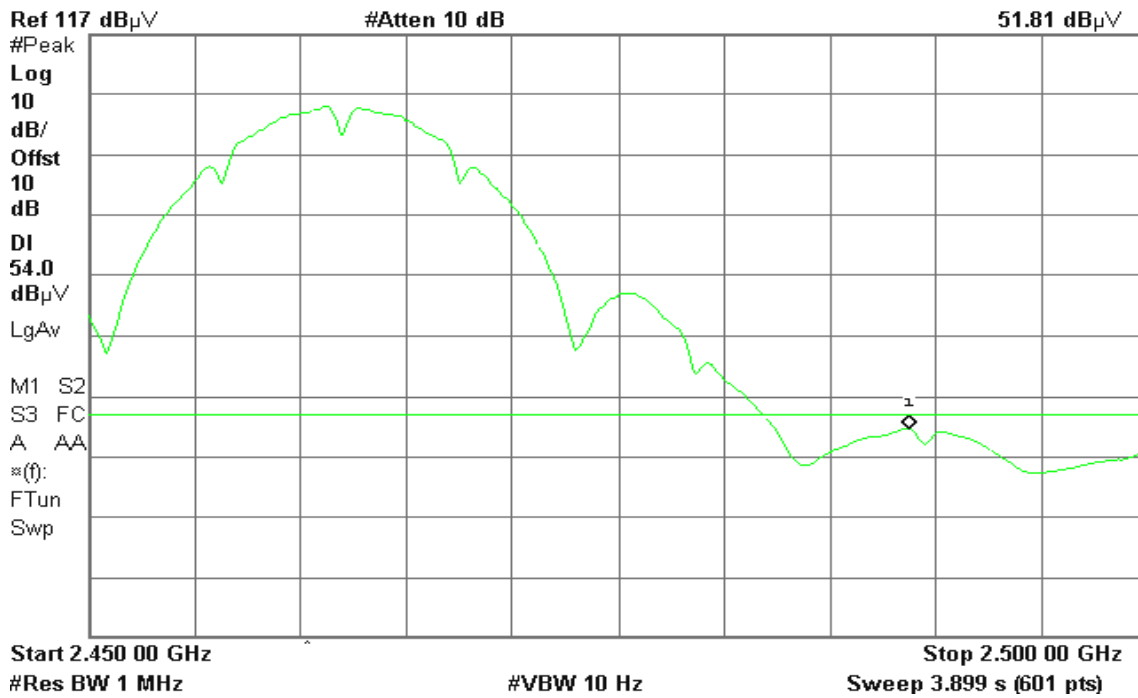



Band Edges (IEEE 802.11g / CH Low)

Detector mode: Peak

Polarity: Vertical

Agilent 12:38:14 Jul 8, 2006

R T

Mkr1 2.390 0 GHz
61.69 dB μ V

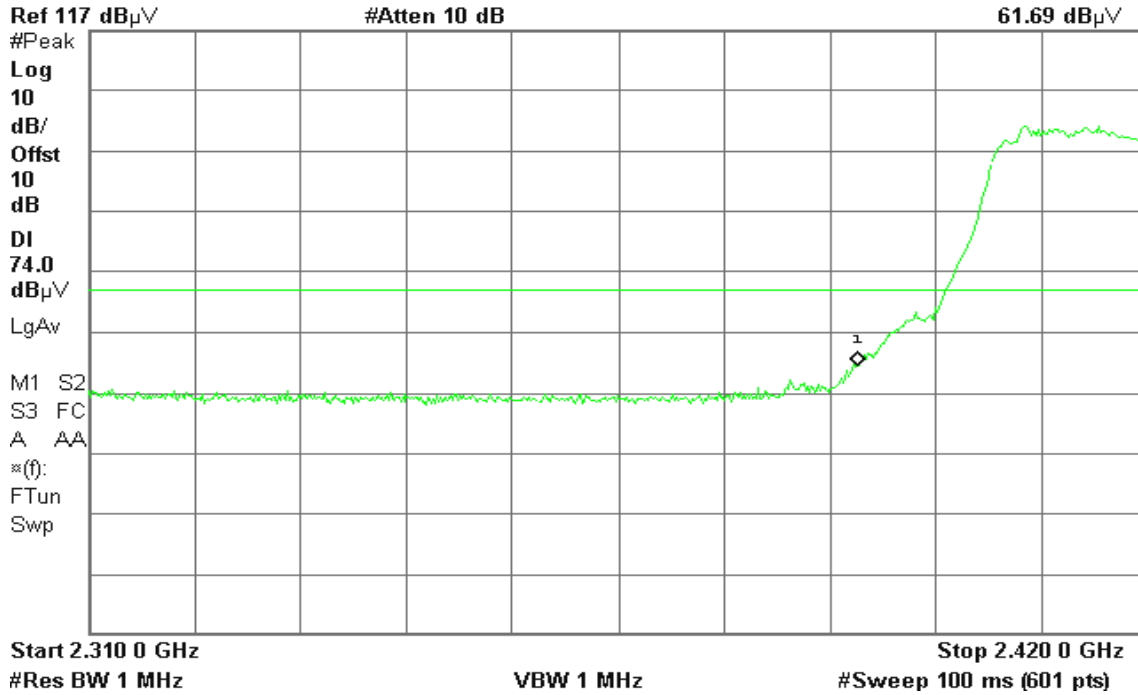

Detector mode: Average

Polarity: Vertical

Agilent 12:37:21 Jul 8, 2006

R T

Mkr1 2.390 0 GHz
45.73 dB μ V

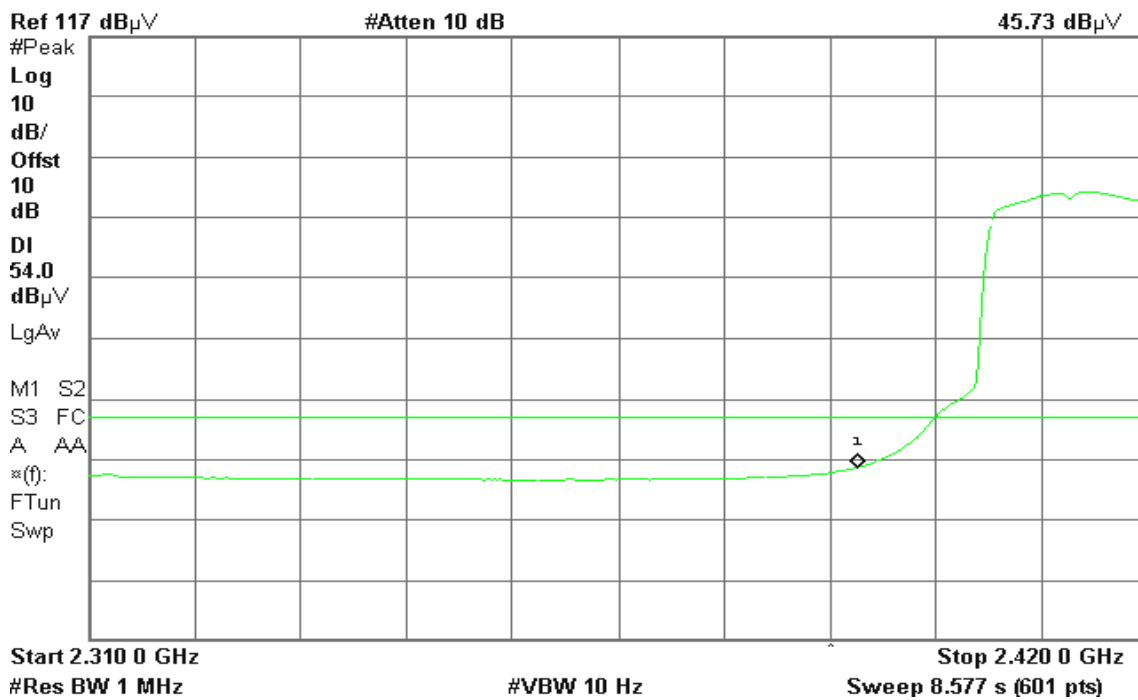



Detector mode: Peak

Polarity: Horizontal

Agilent 12:31:06 Jul 8, 2006

R T

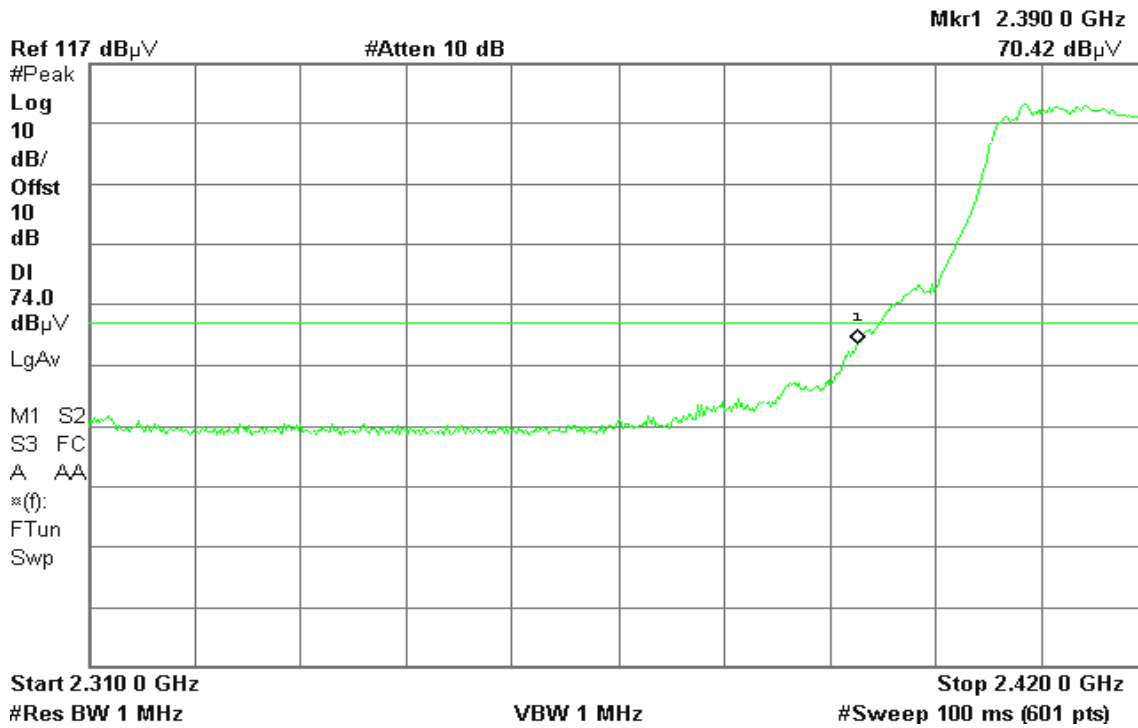

Detector mode: Average

Polarity: Horizontal

Agilent 12:30:17 Jul 8, 2006

R T

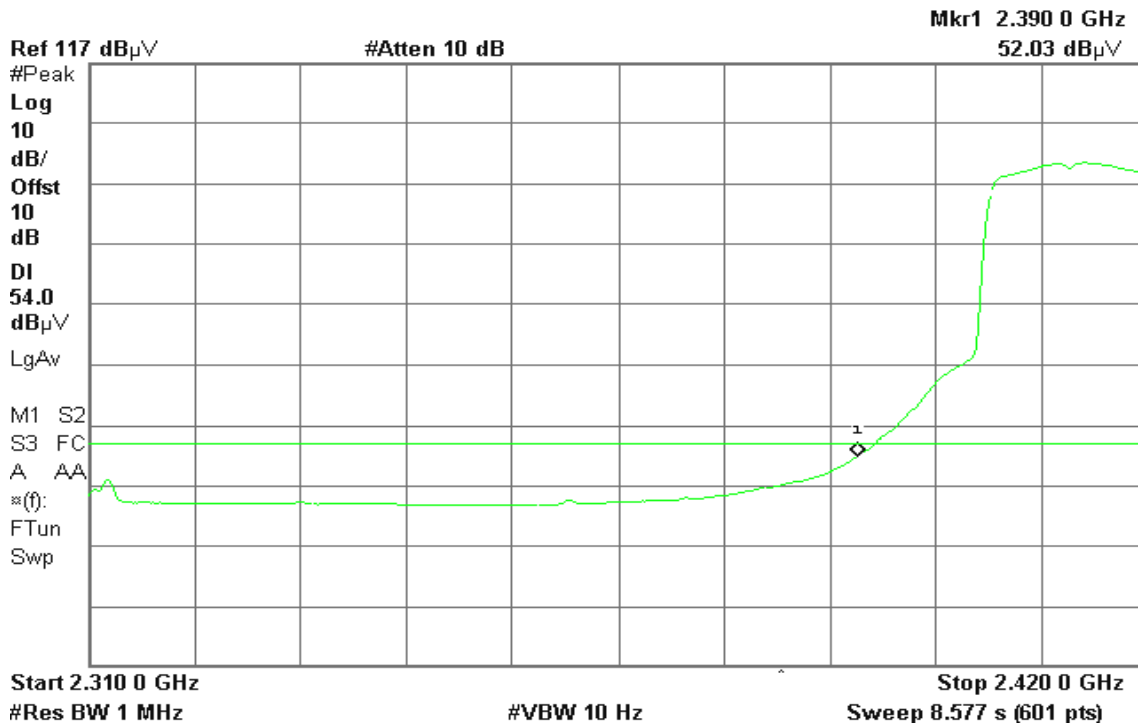



Band Edges (IEEE 802.11g mode / CH High)

Detector mode: Peak

Polarity: Vertical

Agilent 12:57:45 Jul 8, 2006

R T

Mkr1 2.483 50 GHz
61.37 dB μ V

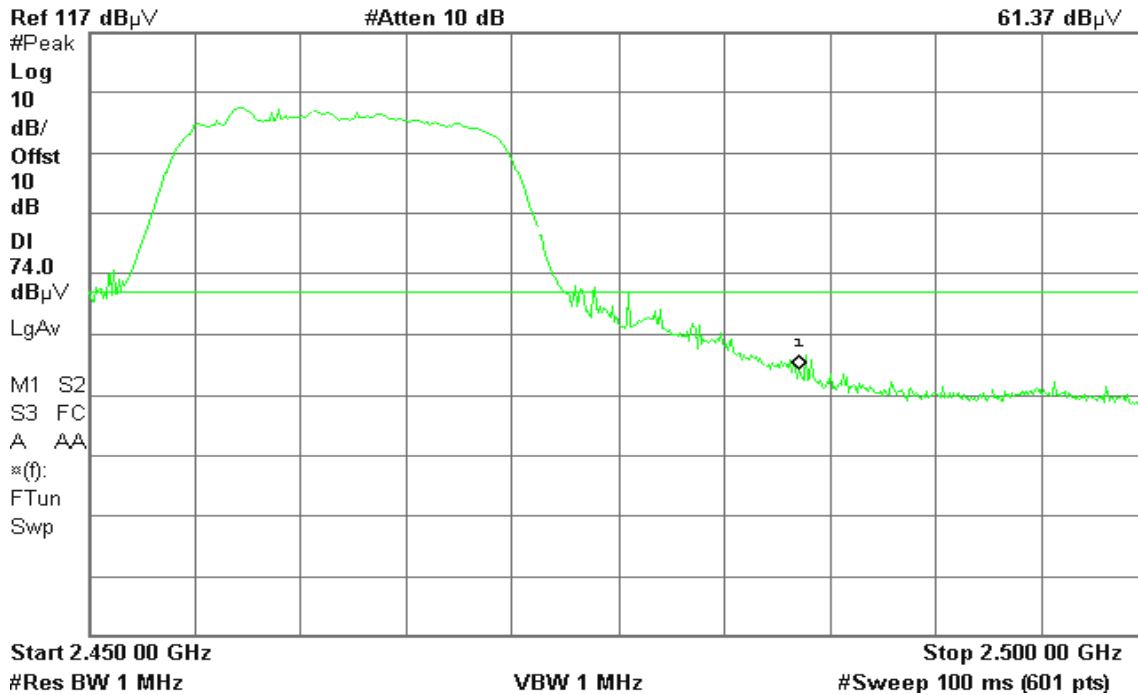

Detector mode: Average

Polarity: Vertical

Agilent 12:57:21 Jul 8, 2006

R T

Mkr1 2.483 50 GHz
46.27 dB μ V

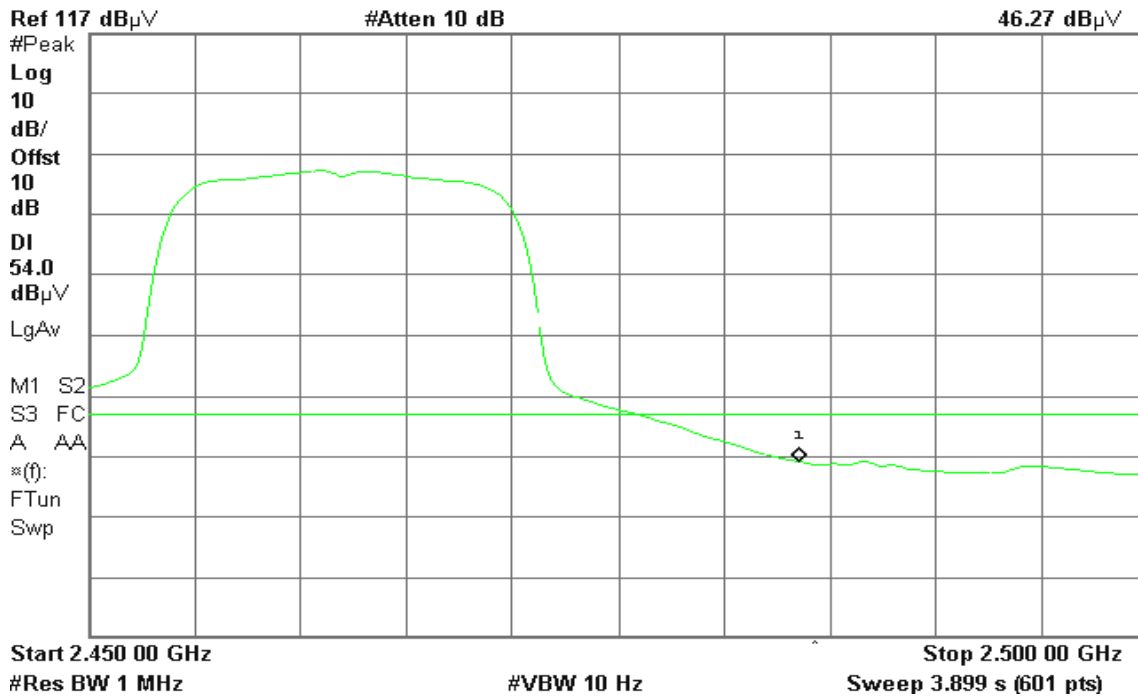



Detector mode: Peak

Polarity: Horizontal

Agilent 12:50:01 Jul 8, 2006

R T

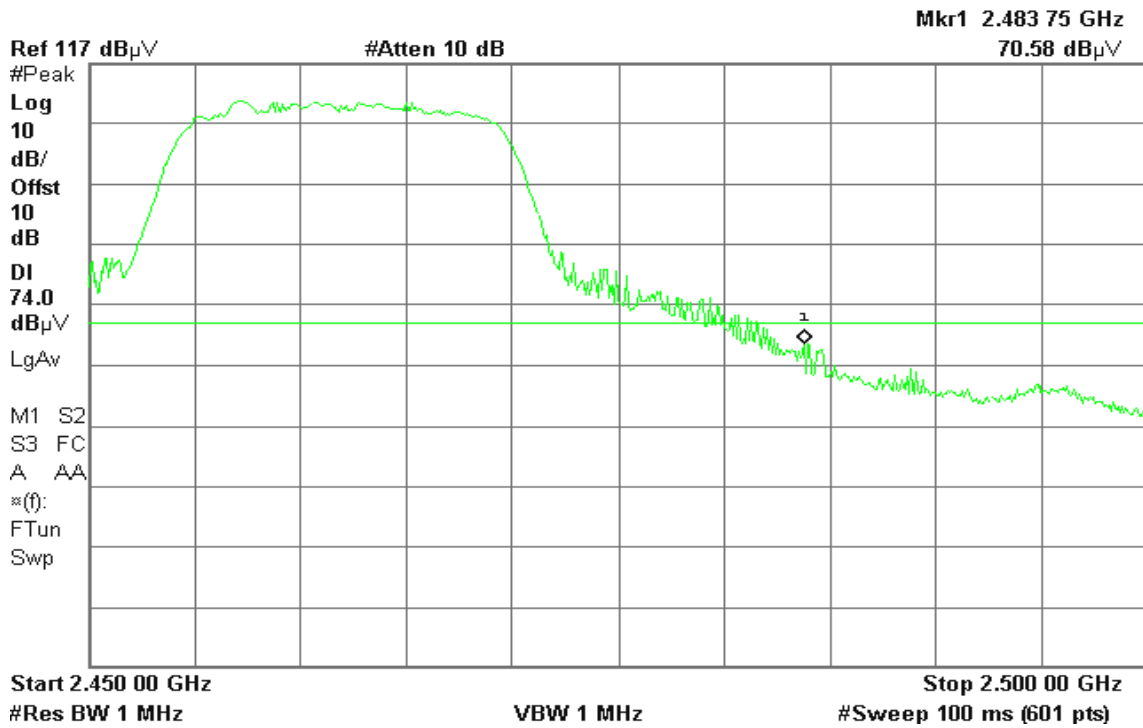

Detector mode: Average

Polarity: Horizontal

Agilent 12:49:05 Jul 8, 2006

R T



7.5 PEAK POWER SPECTRAL DENSITY

LIMIT

1. According to §15.247(e), for digitally modulated systems, the power spectral density conducted from the intentional radiator to the antenna shall not be greater than 8 dBm in any 3 kHz band during any time interval of continuous transmission.
2. According to §15.247(f), the digital modulation operation of the hybrid system, with the frequency hopping turned off, shall comply with the power density requirements of paragraph (d) of this section.

Test Configuration

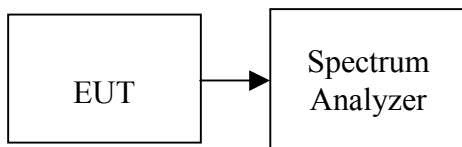

TEST PROCEDURE

1. Place the EUT on the table and set it in transmitting mode.
Remove the antenna from the EUT and then connect a low loss RF cable from the antenna port to the spectrum analyzer.
2. Set the spectrum analyzer as RBW = 3kHz, VBW = 10kHz, Span = 300kHz, Sweep=100s
3. Record the max. reading.
4. Repeat the above procedure until the measurements for all frequencies are completed.

TEST RESULTS

No non-compliance noted



Test Data

IEEE 802.11a

Channel	Frequency (MHz)	PPSD (dBm)	Limit (dBm)	Test Result
Low	5745	-14.77	8.00	PASS
Mid	5785	-11.38		PASS
High	5825	-13.76		PASS

IEEE 802.11b

Channel	Frequency (MHz)	PPSD (dBm)	Limit (dBm)	Test Result
Low	2412	-4.03	8.00	PASS
Mid	2437	-2.98		PASS
High	2462	-5.72		PASS

IEEE 802.11g

Channel	Frequency (MHz)	PPSD (dBm)	Limit (dBm)	Test Result
Low	2412	-5.98	8.00	PASS
Mid	2437	-7.89		PASS
High	2462	-10.27		PASS



Test Plot

PPSD (IEEE 802.11a / CH Low)

Agilent 11:49:41 Jul 10, 2006

R L

Peak Power Spectral Density, a Mode Low Ch.

Mkr1 5.743 691 5 GHz

Ref 20 dBm

Atten 20 dB

-14.77 dBm

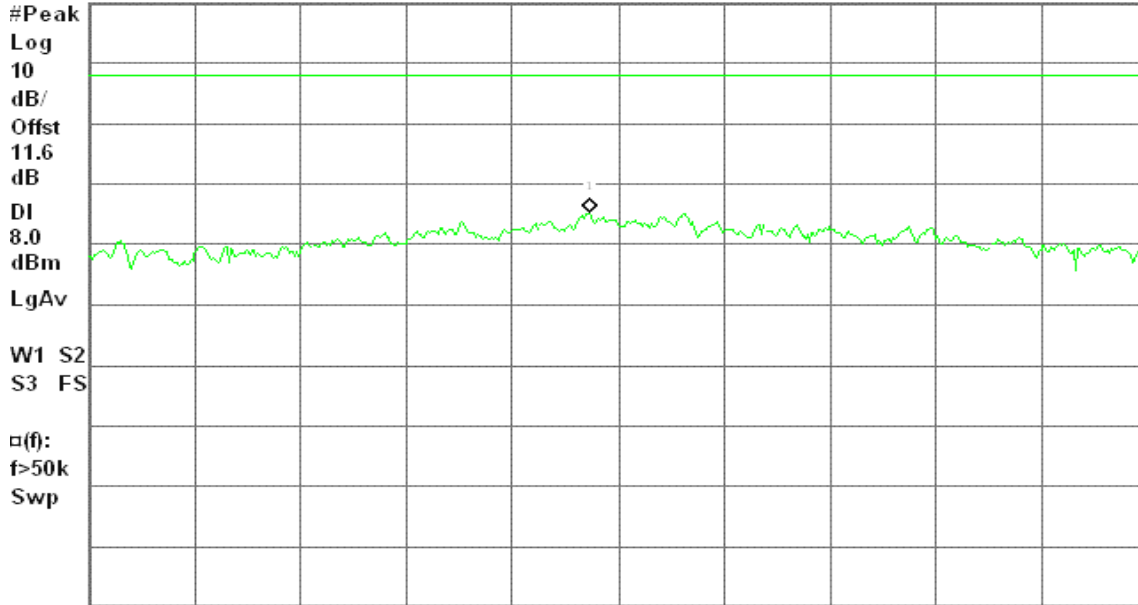

Center 5.743 700 0 GHz

Span 300 kHz

#Res BW 3 kHz

#VBW 10 kHz

#Sweep 100 s (601 pts)

PPSD (IEEE 802.11a / CH Mid)

Agilent 20:16:11 Jul 10, 2006

R L

Peak Power Spectral Density, a Mode Mid Ch.

Mkr1 5.781 256 1 GHz

Ref 20 dBm

Atten 20 dB

-11.38 dBm

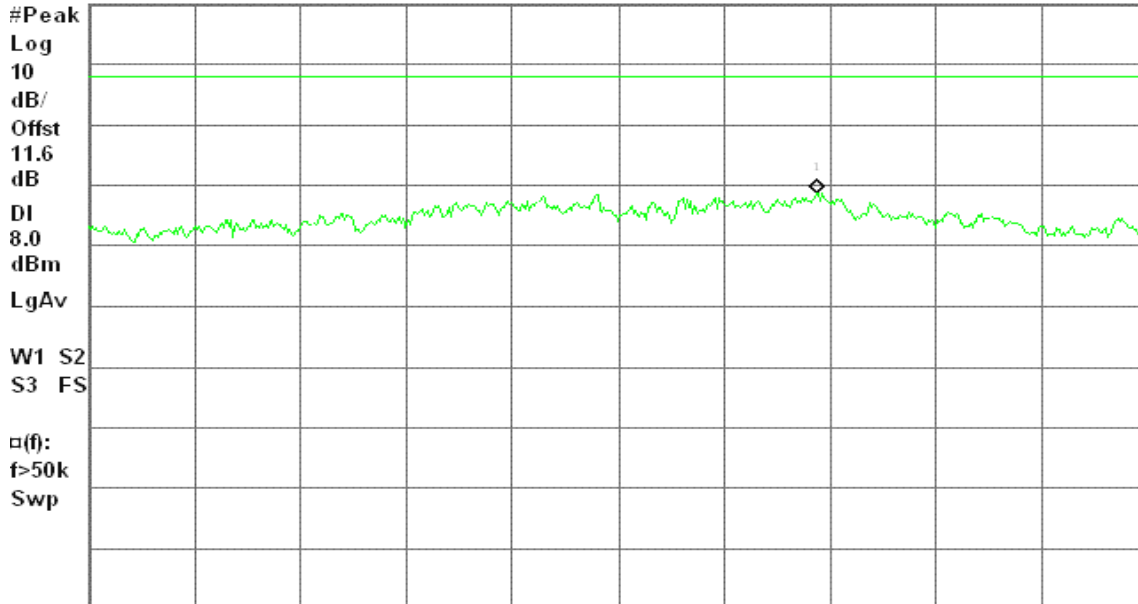

Center 5.781 200 0 GHz

Span 300 kHz

#Res BW 3 kHz

#VBW 10 kHz

#Sweep 100 s (601 pts)



PPSD (IEEE 802.11a / CH High)

Agilent 20:26:50 Jul 10, 2006

R L

Peak Power Spectral Density, a Mode High Ch.

Mkr1 5.823 418 6 GHz

Ref 20 dBm

Atten 20 dB

-13.76 dBm

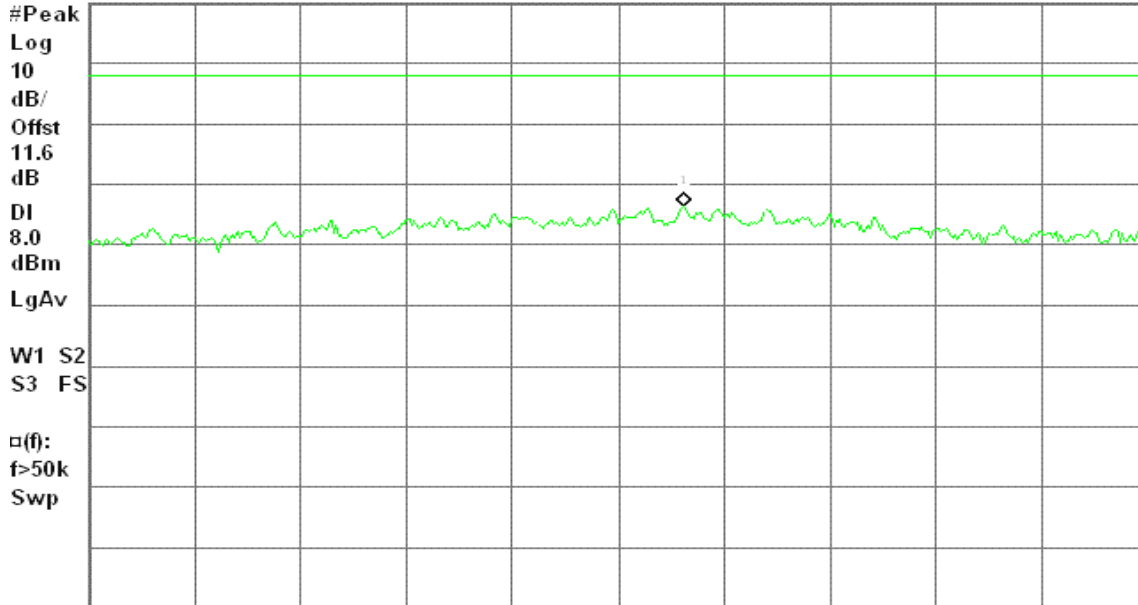

Center 5.823 400 0 GHz

Span 300 kHz

#Res BW 3 kHz

#VBW 10 kHz

#Sweep 100 s (601 pts)

PPSD (IEEE 802.11b / CH Low)

Agilent 18:33:30 Jul 10, 2006

R L

Peak Power Spectral Density, b Mode Low Ch.

Mkr1 2.412 663 1 GHz

Ref 30 dBm

Atten 30 dB

-4.03 dBm

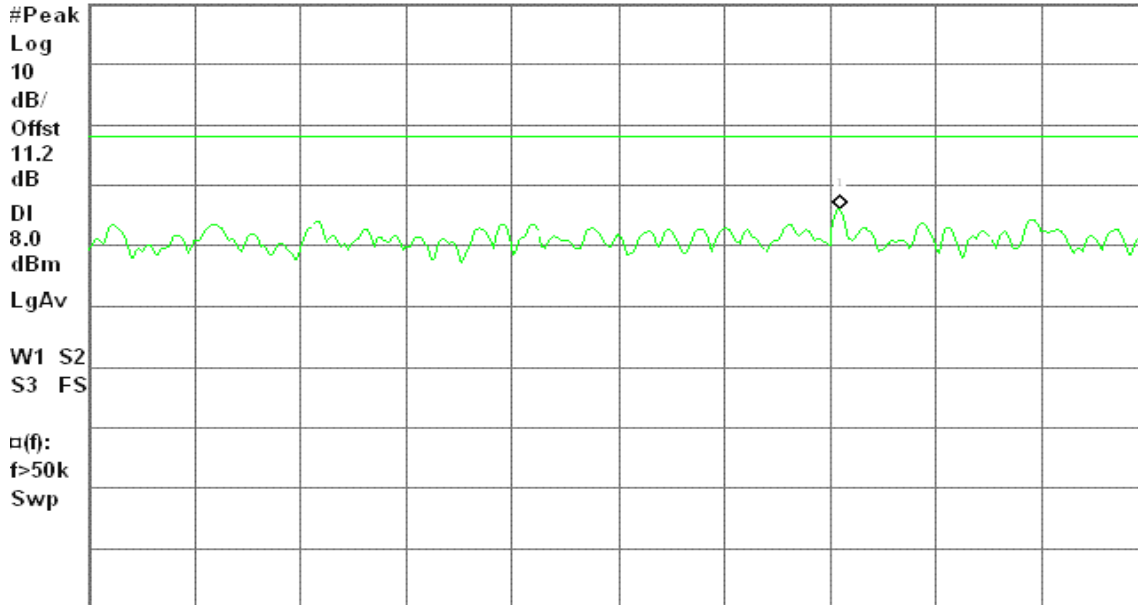

Center 2.412 600 0 GHz

Span 300 kHz

#Res BW 3 kHz

#VBW 10 kHz

#Sweep 100 s (601 pts)



PPSD (IEEE 802.11b / CH Mid)

Agilent 18:41:05 Jul 10, 2006

Peak Power Spectral Density, b Mode Mid Ch.

L

Mkr1 2.437 663 1 GHz

Ref 30 dBm

Atten 30 dB

-2.98 dBm

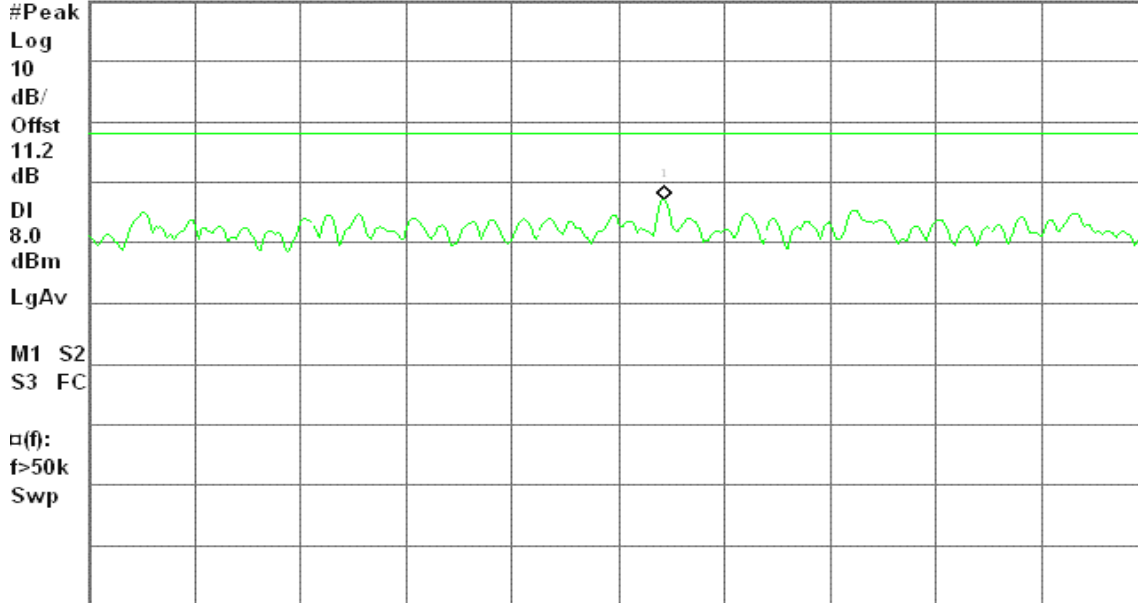

Center 2.437 650 0 GHz

Span 300 kHz

#Res BW 3 kHz

#VBW 10 kHz

#Sweep 100 s (601 pts)

PPSD (IEEE 802.11b / CH High)

Agilent 18:46:53 Jul 10, 2006

Peak Power Spectral Density, b Mode High Ch.

R L

Mkr1 2.461 306 8 GHz

Ref 30 dBm

Atten 30 dB

-5.72 dBm

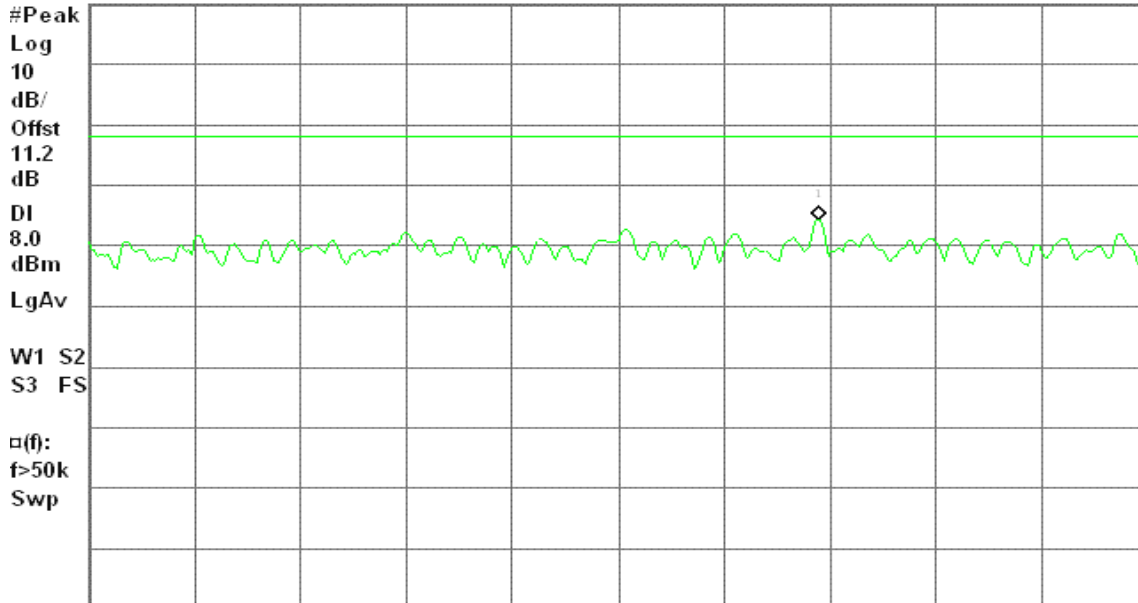

Center 2.461 250 0 GHz

Span 300 kHz

#Res BW 3 kHz

#VBW 10 kHz

#Sweep 100 s (601 pts)



PPSD (IEEE 802.11g / CH Low)

Agilent 19:06:00 Jul 10, 2006

R T

Mkr1 2.410 710 5 GHz
-5.98 dBm

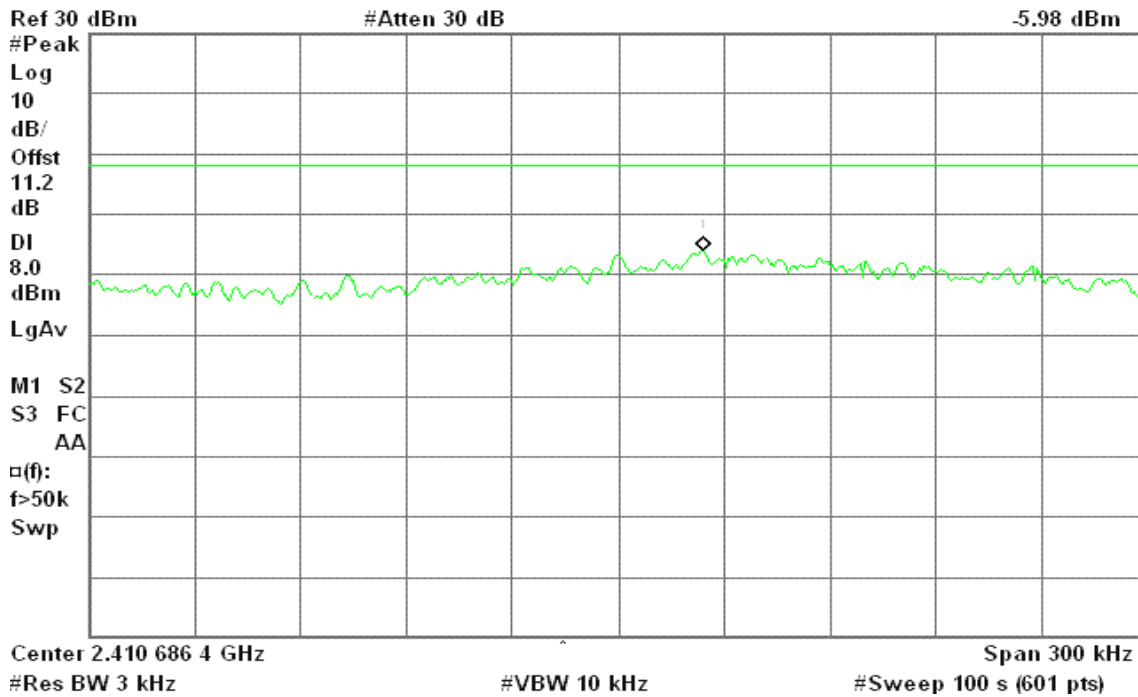

PPSD (IEEE 802.11g / CH Mid)

Agilent 19:20:02 Jul 10, 2006

R L

Peak Power Spectral Density, g Mode Mid Ch.

Mkr1 2.435 712 3 GHz
-7.89 dBm

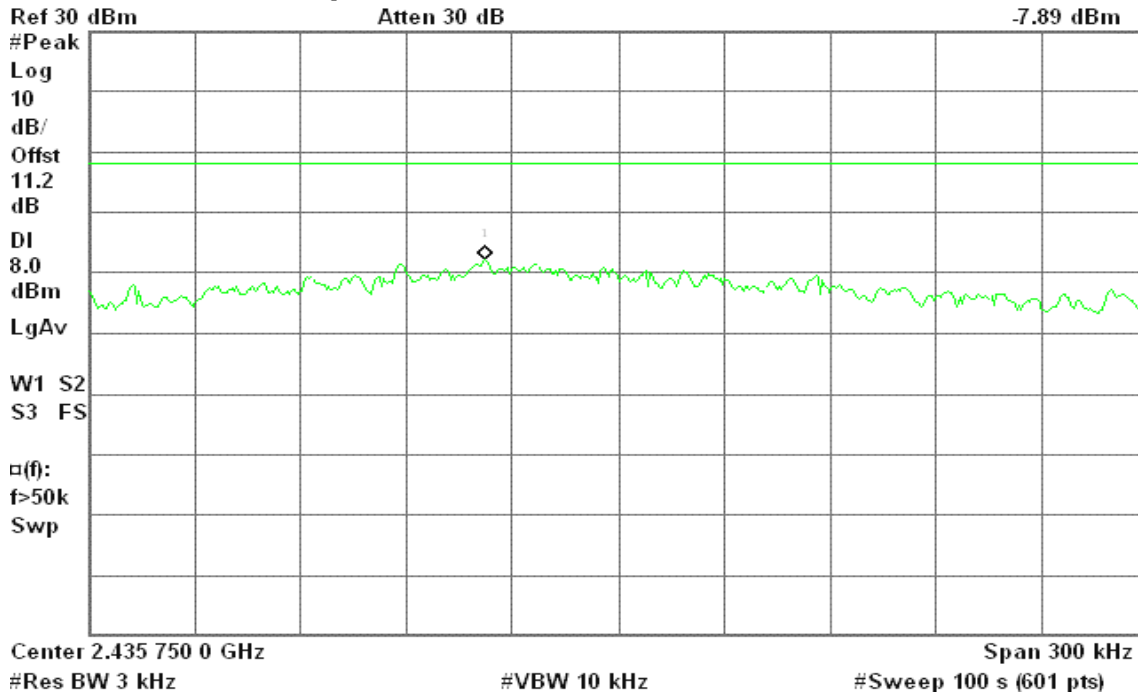



PPSD (IEEE 802.11g / CH High)

Agilent 19:29:56 Jul 10, 2006

R L

Peak Power Spectral Density, g Mode High Ch.

Mkr1 2.456 936 4 GHz

Ref 30 dBm

Atten 30 dB

-10.27 dBm

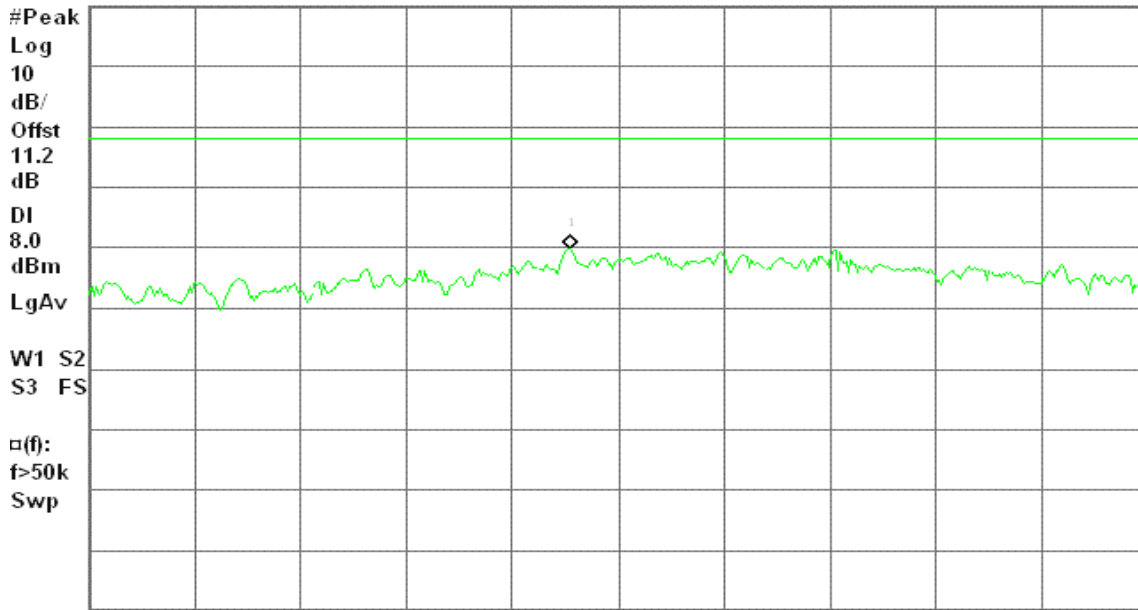

Center 2.456 950 0 GHz

Span 300 kHz

#Res BW 3 kHz

#VBW 10 kHz

#Sweep 100 s (601 pts)

7.6 SPURIOUS EMISSIONS

7.6.1 Conducted Measurement

LIMIT

According to §15.247(d), in any 100 kHz bandwidth outside the frequency bands in which the spread spectrum intentional radiator is operating, the radio frequency power that is produced by the intentional radiator shall be at least 20 dB below that in the 100 kHz bandwidth within the band that contains the highest level of the desired power, based on either an RF conducted or a radiated measurement, provided the transmitter demonstrates compliance with the peak conducted power limits. In addition, radiated emissions which fall in the restricted bands, as defined in §15.205(a), must also comply with the radiated emission limits specified in 15.209(a) (see Section 15.205(c)).

Test Configuration

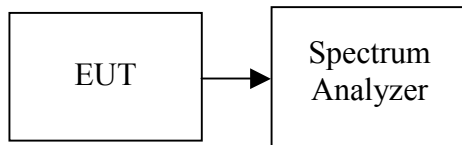

TEST PROCEDURE

Conducted RF measurements of the transmitter output were made to confirm that the EUT antenna port conducted emissions meet the specified limit and to identify any spurious signals that require further investigation or measurements on the radiated emissions site.

The transmitter output is connected to the spectrum analyzer. The resolution bandwidth is set to 100 kHz. The video bandwidth is set to 100 kHz.

Measurements are made over the 30MHz to 26GHz range for IEEE802.11b/g, 30MHz to 40GHz range for IEEE802.11a with the transmitter set to the lowest, middle, and highest channels.

TEST RESULTS

No non-compliance noted.



Test Plot

IEEE 802.11a / CH Low

30MHz ~ 40GHz

Agilent 11:51:15 Jul 10, 2006

L

Spurious, a Mode Low Ch.

Mkr1 5.75 GHz

Ref 11.6 dBm

#Atten 10 dB

-4.82 dBm

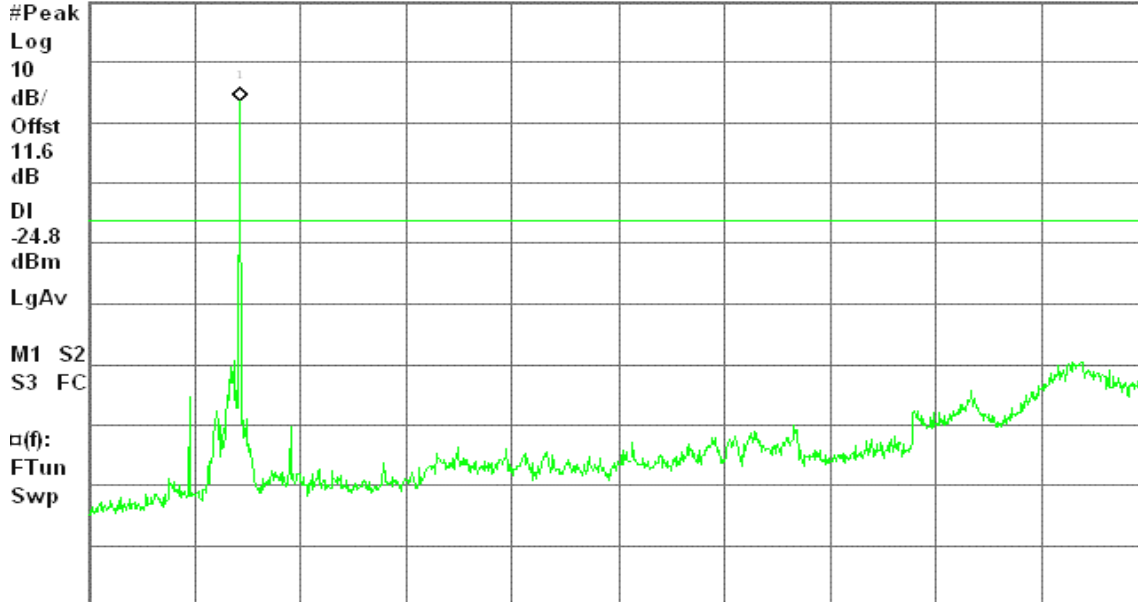

Center 20.02 GHz

Span 39.97 GHz

#Res BW 100 kHz

#VBW 100 kHz

Sweep 4.819 s (1001 pts)

IEEE 802.11a / CH Mid

30MHz ~ 40GHz

Agilent 20:17:30 Jul 10, 2006

R L

Spurious, a Mode Mid Ch.

Mkr1 5.79 GHz

Ref 11.6 dBm

#Atten 10 dB

-0.39 dBm

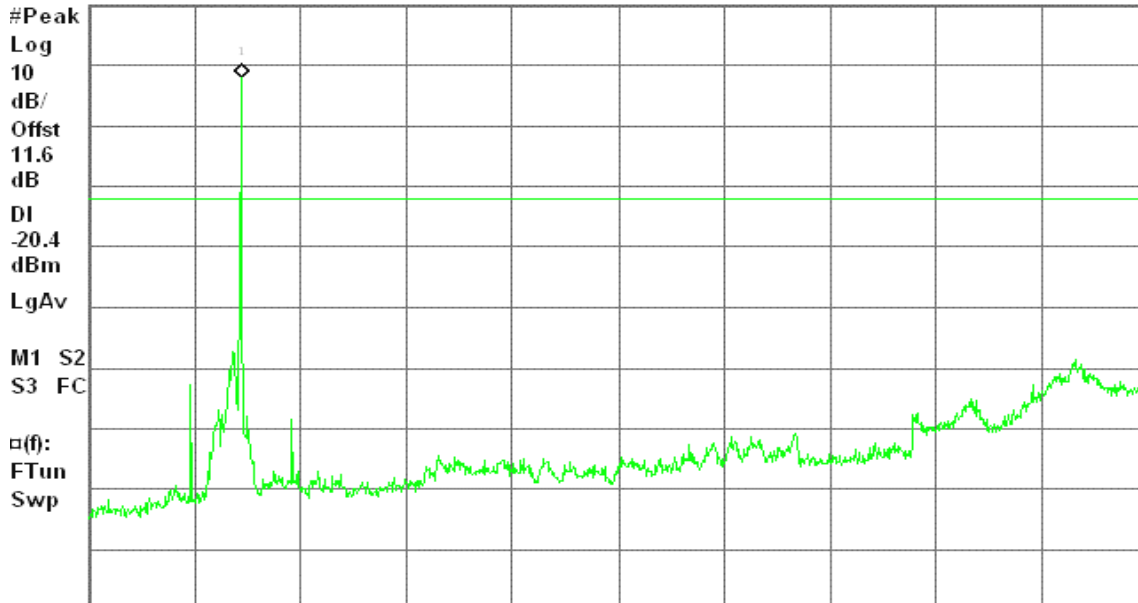

Center 20.02 GHz

Span 39.97 GHz

#Res BW 100 kHz

#VBW 100 kHz

Sweep 4.819 s (1001 pts)



IEEE 802.11a / CH High

30MHz ~ 40GHz

Agilent 20:28:00 Jul 10, 2006

R L

Spurious, a Mode High Ch.

Mkr1 5.83 GHz

Ref 11.6 dBm

#Atten 10 dB

-3.24 dBm

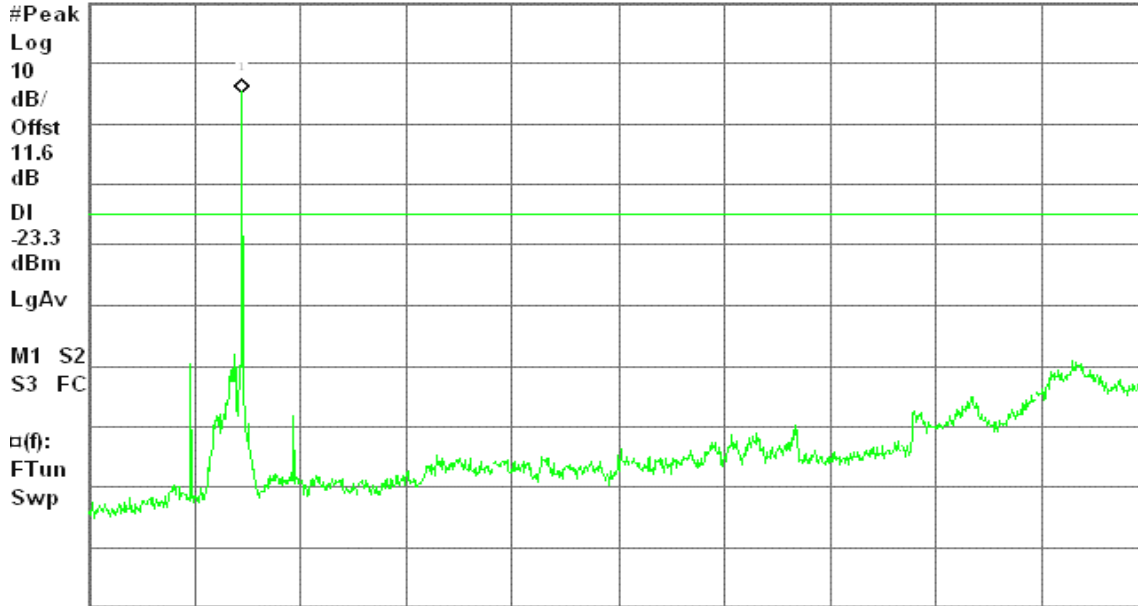

Center 20.02 GHz

Span 39.97 GHz

#Res BW 100 kHz

#VBW 100 kHz

Sweep 4.819 s (1001 pts)

IEEE 802.11b / CH Low

30MHz ~ 26GHz

Agilent 18:34:22 Jul 10, 2006

L

Spurious, b Mode Low Ch.

Mkr1 2.42 GHz

Ref 30 dBm

Atten 30 dB

7.43 dBm

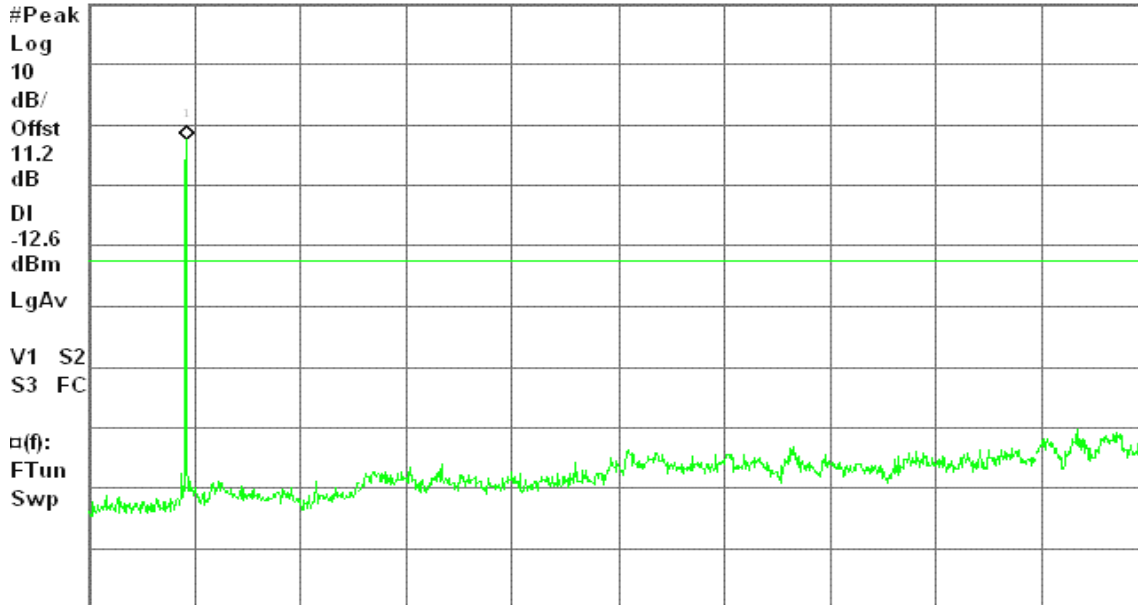

Center 13.02 GHz

Span 25.97 GHz

#Res BW 100 kHz

#VBW 100 kHz

Sweep 3.131 s (1001 pts)



IEEE 802.11b / CH Mid

30MHz ~ 26GHz

Agilent 18:41:50 Jul 10, 2006

L

Spurious, b Mode Mid Ch.

Mkr1 2.45 GHz

Ref 30 dBm

Atten 30 dB

10.11 dBm

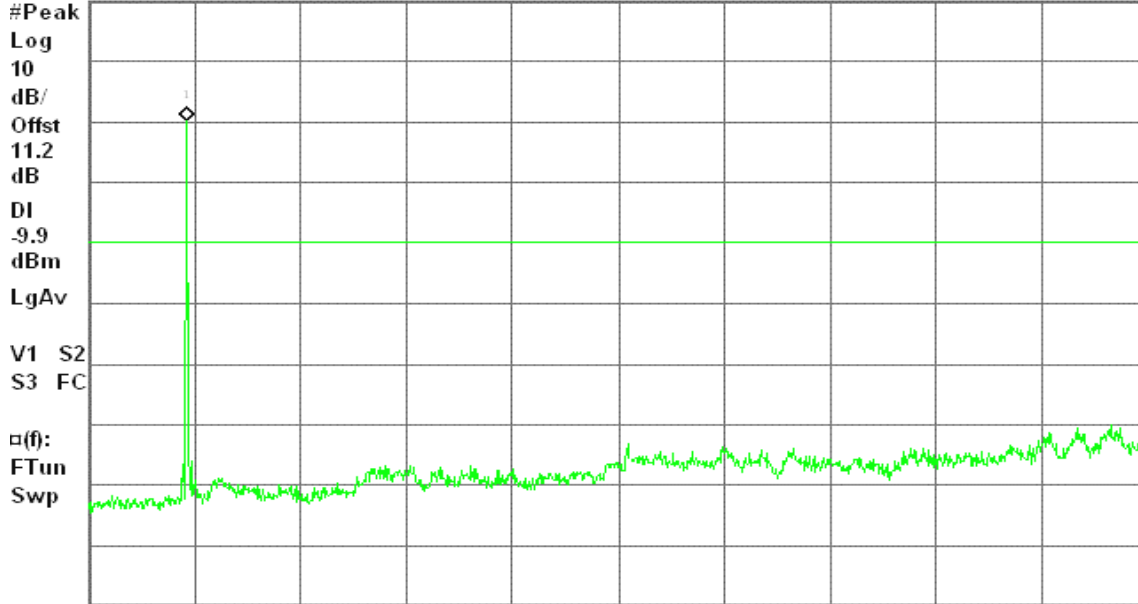

Center 13.02 GHz

Span 25.97 GHz

#Res BW 100 kHz

#VBW 100 kHz

Sweep 3.131 s (1001 pts)

IEEE 802.11b / CH High

30MHz ~ 26GHz

Agilent 18:47:41 Jul 10, 2006

L

Spurious, b Mode High Ch.

Mkr1 2.47 GHz

Ref 30 dBm

Atten 30 dB

6.53 dBm

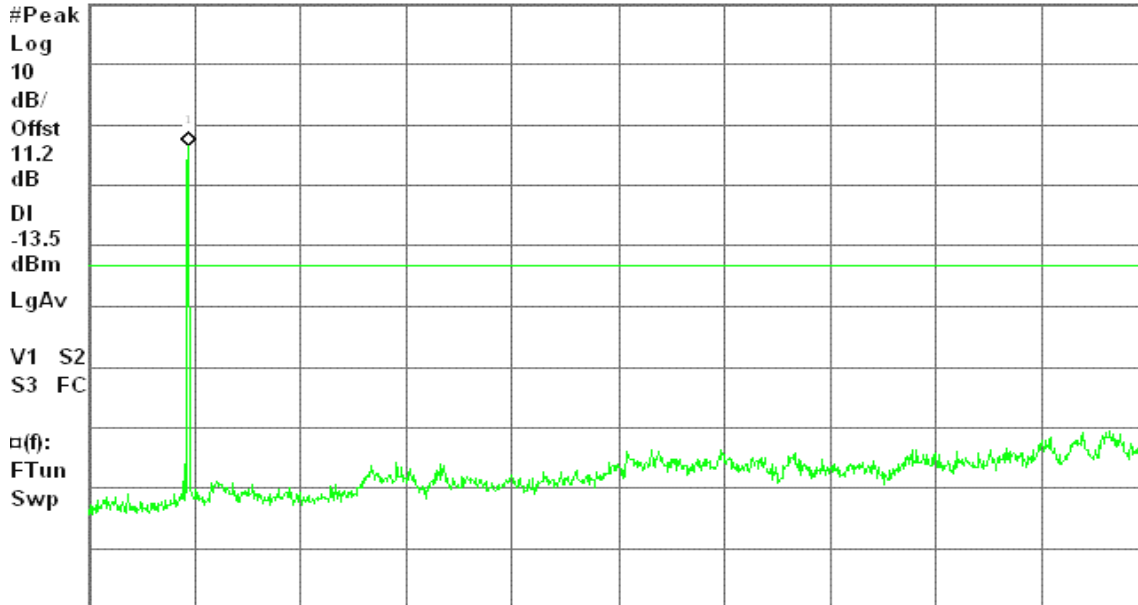

Center 13.02 GHz

Span 25.97 GHz

#Res BW 100 kHz

#VBW 100 kHz

Sweep 3.131 s (1001 pts)



IEEE 802.11g / CH Low

30MHz ~ 26GHz

Agilent 19:14:55 Jul 10, 2006

L

Spurious, g Mode Low Ch.

Mkr1 2.42 GHz

Ref 30 dBm

Atten 30 dB

3.08 dBm

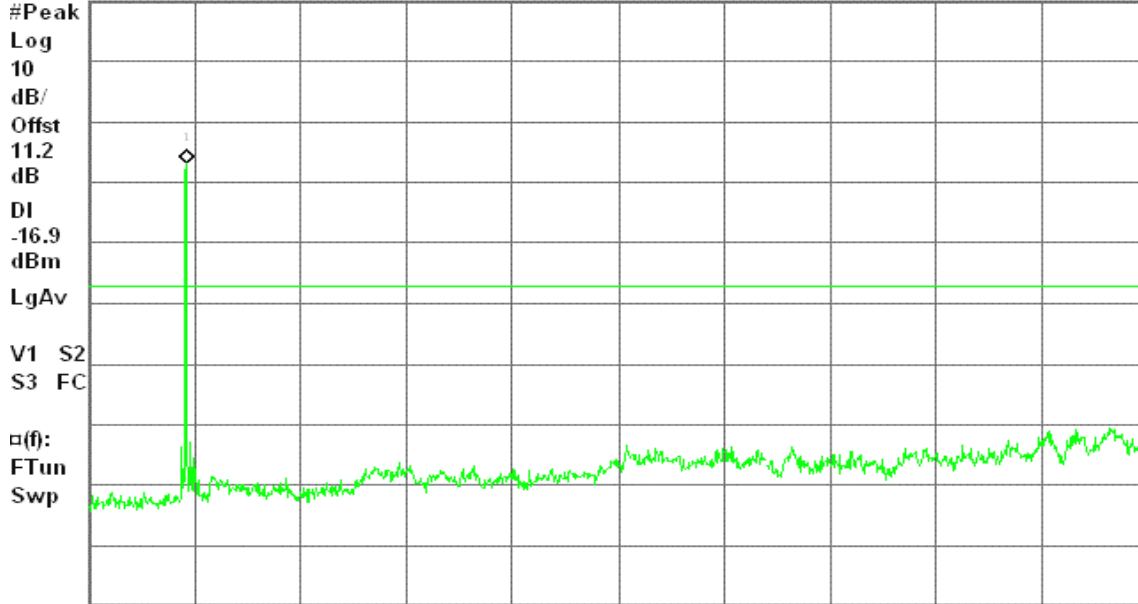

Center 13.02 GHz

Span 25.97 GHz

#Res BW 100 kHz

#VBW 100 kHz

Sweep 3.131 s (1001 pts)

IEEE 802.11g / CH Mid

30MHz ~ 26GHz

Agilent 19:20:54 Jul 10, 2006

L

Spurious, g Mode Mid Ch.

Mkr1 2.45 GHz

Ref 30 dBm

Atten 30 dB

1.72 dBm

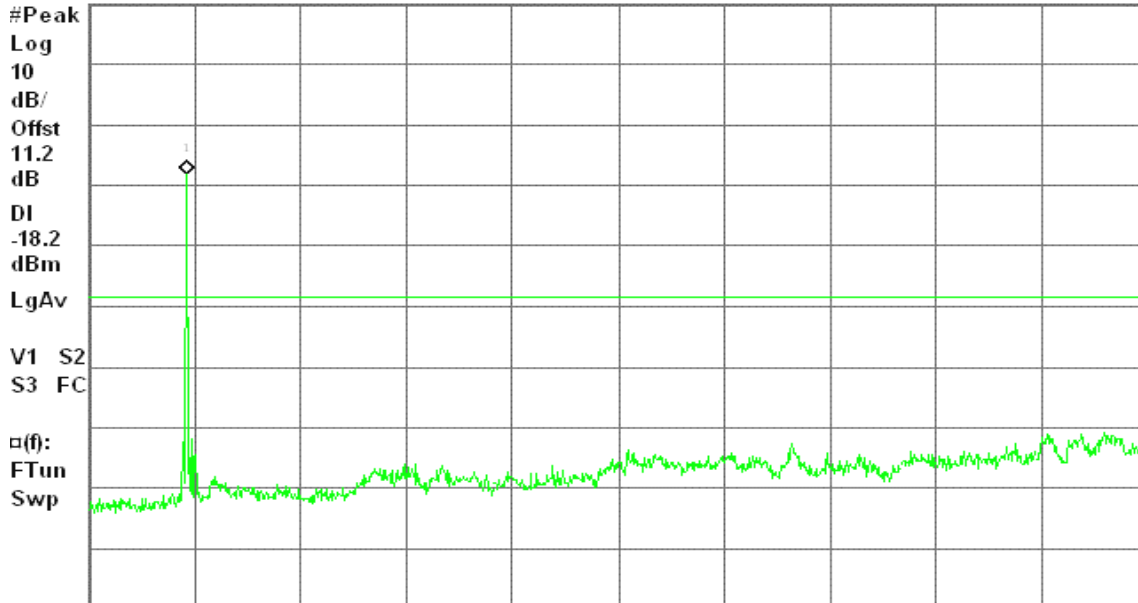

Center 13.02 GHz

Span 25.97 GHz

#Res BW 100 kHz

#VBW 100 kHz

Sweep 3.131 s (1001 pts)



IEEE 802.11g / CH High

30MHz ~ 26GHz

Agilent 19:30:45 Jul 10, 2006

L

Spurious, g Mode High Ch.

Mkr1 2.47 GHz

Ref 30 dBm

Atten 30 dB

2.18 dBm

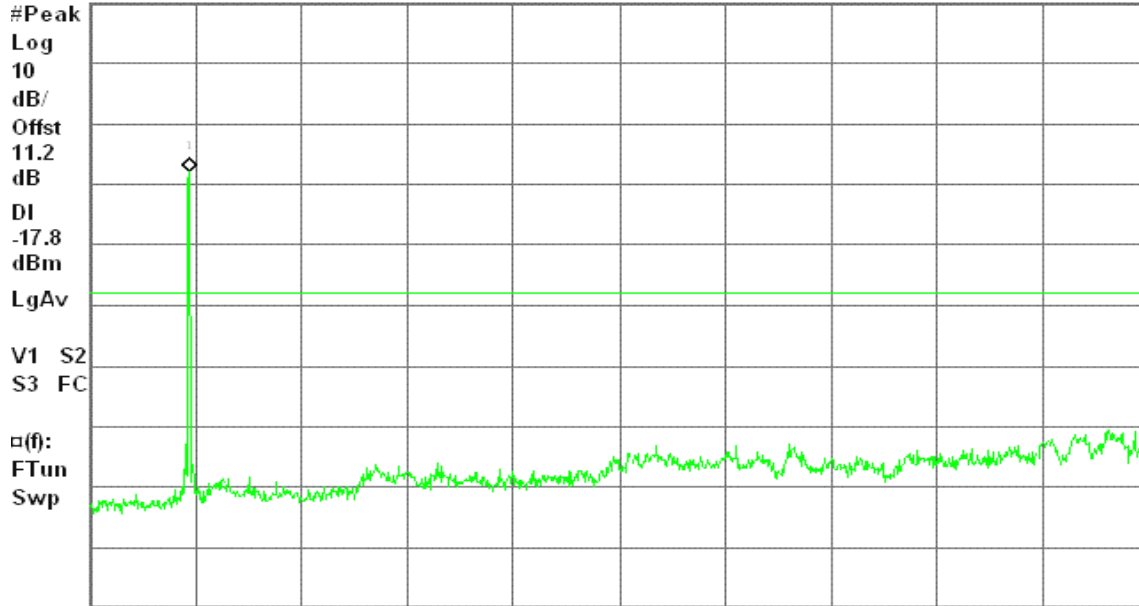

Center 13.02 GHz

Span 25.97 GHz

#Res BW 100 kHz

#VBW 100 kHz

Sweep 3.131 s (1001 pts)



7.6.2 Radiated Emissions

LIMIT

1. According to §15.209(a), except as provided elsewhere in this Subpart, the emissions from an intentional radiator shall not exceed the field strength levels specified in the following table:

Frequency (MHz)	Field Strength ($\mu\text{V/m}$)	Measurement Distance (m)
30-88	100*	3
88-216	150*	3
216-960	200*	3
Above 960	500	3

Remark: Except as provided in paragraph (g), fundamental emissions from intentional radiators operating under this Section shall not be located in the frequency bands 54-72 MHz, 76-88 MHz, 174-216 MHz or 470-806 MHz. However, operation within these frequency bands is permitted under other sections of this Part, e.g., Sections 15.231 and 15.241.

2. In the emission table above, the tighter limit applies at the band edges.

Frequency (MHz)	Field Strength ($\mu\text{V/m}$ at 3-meter)	Field Strength (dB $\mu\text{V/m}$ at 3-meter)
30-88	100	40
88-216	150	43.5
216-960	200	46
Above 960	500	54

Test Configuration

Below 1 GHz

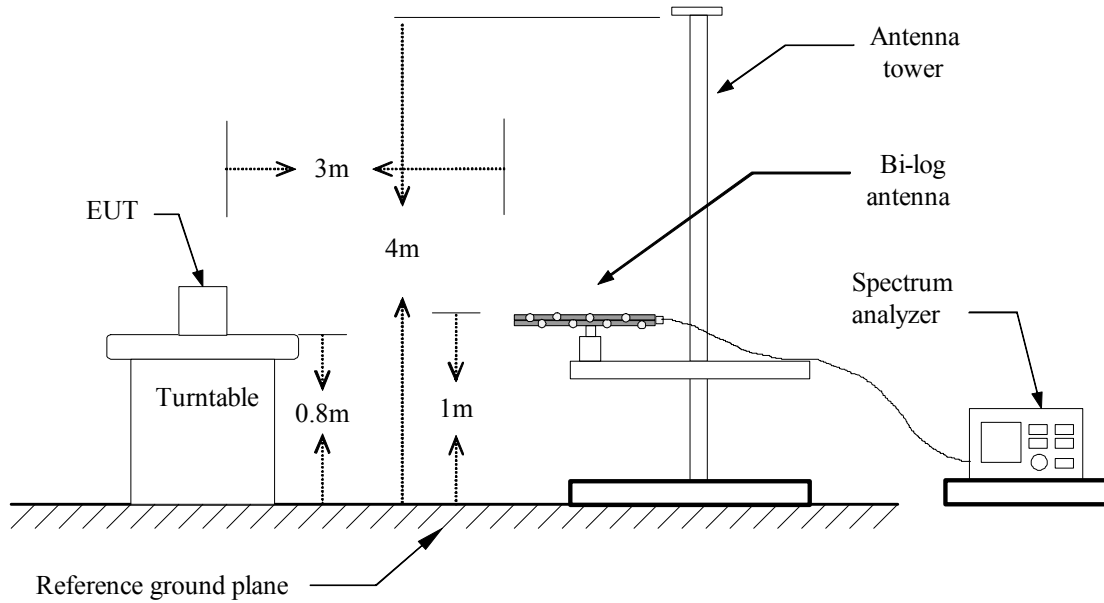

Above 1 GHz

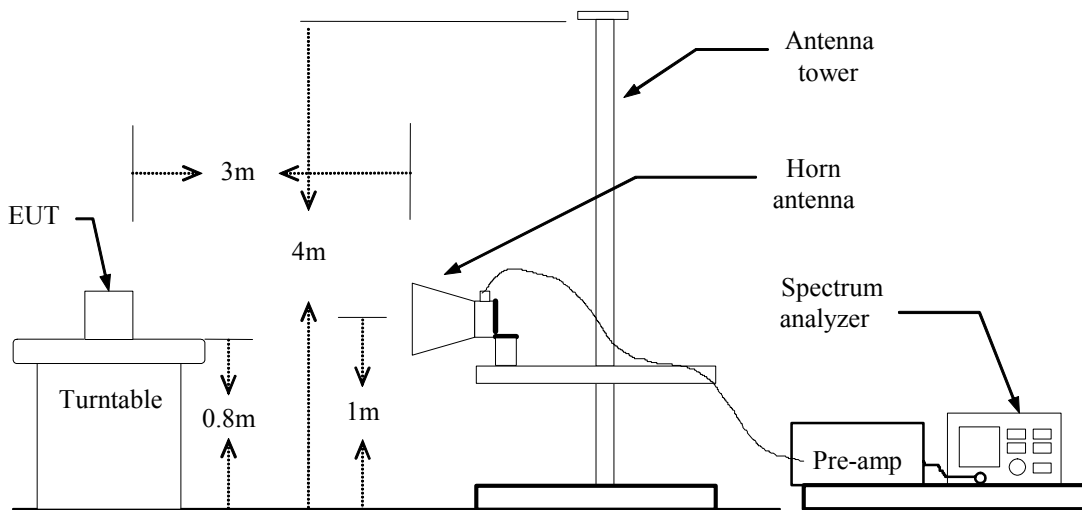



TEST PROCEDURE

1. The EUT is placed on a turntable, which is 0.8m above ground plane.
2. The turntable shall be rotated for 360 degrees to determine the position of maximum emission level.
3. EUT is set 3m away from the receiving antenna, which is varied from 1m to 4m to find out the highest emissions.
4. Maximum procedure was performed on the six highest emissions to ensure EUT compliance.
5. And also, each emission was to be maximized by changing the polarization of receiving antenna both horizontal and vertical.
6. Set the spectrum analyzer in the following setting as:
Below 1GHz:
 RBW=100kHz / VBW=300kHz / Sweep=AUTO
Above 1GHz:
 (a) PEAK: RBW=VBW=1MHz / Sweep=AUTO
 (b) AVERAGE: RBW=1MHz / VBW=10Hz / Sweep=AUTO
7. Repeat above procedures until the measurements for all frequencies are complete.

**TEST RESULTS****WLAN OPERATION****Below 1 GHz****Operation Mode:** Normal Link**Test Date:** July 10, 2006**Temperature:** 23°C**Tested by:** Skyman Tsai**Humidity:** 46 % RH**Polarity:** Ver. / Hor.

Frequency (MHz)	Ant.Pol. (H/V)	Reading (dBuV)	Correction Factor (dB/m)	Result (dBuV/m)	Limit (dBuV/m)	Margin (dB)	Remark
34.85	V	35.30	-8.38	26.91	40.00	-13.09	Peak
59.10	V	39.21	-19.13	20.08	40.00	-19.92	Peak
275.73	V	32.28	-11.89	20.39	46.00	-25.61	Peak
324.23	V	34.58	-11.03	23.55	46.00	-22.45	Peak
354.95	V	32.44	-10.27	22.17	46.00	-23.83	Peak
398.60	V	31.12	-9.27	21.85	46.00	-24.15	Peak
172.27	H	31.64	-14.46	17.18	43.50	-26.32	Peak
296.75	H	38.77	-11.72	27.04	46.00	-18.96	Peak
443.87	H	32.54	-8.51	24.03	46.00	-21.97	Peak
532.78	H	30.11	-6.34	23.77	46.00	-22.23	Peak
599.07	H	32.16	-5.41	26.74	46.00	-19.26	Peak
799.53	H	29.77	-2.23	27.54	46.00	-18.46	Peak

Remark:

1. Measuring frequencies from 30 MHz to the 1GHz.
2. Radiated emissions measured in frequency range from 30 MHz to 1000MHz were made with an instrument using peak/quasi-peak detector mode.
3. Quasi-peak test would be performed if the peak result were greater than the quasi-peak limit or as required by the applicant.
4. Measurements above show only up to 6 maximum emissions noted, or would be lesser, with " N/A " remark, if no specific emissions from the EUT are recorded (ie: margin>20dB from the applicable limit) and considered that's already beyond the background noise floor.
5. Margin (dB) = Remark result (dBuV/m) – Quasi-peak limit (dBuV/m).



Above 1 GHz

Operation Mode: TX / IEEE 802.11a / CH Low

Test Date: July 12, 2006

Temperature: 23°C

Tested by: Skyman Tsai

Humidity: 52% RH

Polarity: Ver. / Hor.

Frequency (MHz)	Ant. Pol. (H/V)	Reading (Peak) (dBuV)	Reading (Average) (dBuV)	Correction Factor (dB/m)	Result (Peak) (dBuV/m)	Result (Average) (dBuV/m)	Limit (Peak) (dBuV/m)	Limit (Average) (dBuV/m)	Margin (dB)	Remark
5421.67	V	56.93	46.26	4.48	61.41	50.74	74.00	54.00	-3.26	Average
N/A										
5351.67	H	49.46	36.34	4.29	53.75	40.63	74.00	54.00	-0.25	Average
N/A										

Remark:

1. Measuring frequencies from 1 GHz to the 10th harmonic of highest fundamental frequency.
2. Radiated emissions measured in frequency above 1000MHz were made with an instrument using peak/average detector mode.
3. Average test would be performed if the peak result were greater than the average limit or as required by the applicant.
4. Data of measurement within this frequency range shown " --- " in the table above means the reading of emissions are attenuated more than 20dB below the permissible limits or the field strength is too small to be measured.
5. Measurements above show only up to 6 maximum emissions noted, or would be lesser; with " N/A " remark, if no specific emissions from the EUT are recorded (ie: margin > 20dB from the applicable limit) and considered that's already beyond the background noise floor.
6. Margin (dB) = Remark result (dBuV/m) – Average limit (dBuV/m).



Operation Mode: TX / IEEE 802.11a / CH Mid

Test Date: July 10, 2006

Temperature: 23°C

Tested by: Skyman Tsai

Humidity: 46% RH

Polarity: Ver. / Hor.

Frequency (MHz)	Ant. Pol. (H/V)	Reading (Peak) (dBuV)	Reading (Average) (dBuV)	Correction Factor (dB/m)	Result (Peak) (dBuV/m)	Result (Average) (dBuV/m)	Limit (Peak) (dBuV/m)	Limit (Average) (dBuV/m)	Margin (dB)	Remark
5421.67	V	55.12	42.97	9.84	64.96	52.81	74.00	54.00	-1.19	Average
N/A										
4628.33	H	48.32	36.41	7.73	56.05	44.14	74.00	54.00	-9.86	Average
N/A										

Remark:

1. Measuring frequencies from 1 GHz to the 10th harmonic of highest fundamental frequency.
2. Radiated emissions measured in frequency above 1000MHz were made with an instrument using peak/average detector mode.
3. Average test would be performed if the peak result were greater than the average limit or as required by the applicant.
4. Data of measurement within this frequency range shown " --- " in the table above means the reading of emissions are attenuated more than 20dB below the permissible limits or the field strength is too small to be measured.
5. Measurements above show only up to 6 maximum emissions noted, or would be lesser, with " N/A " remark, if no specific emissions from the EUT are recorded (ie: margin > 20dB from the applicable limit) and considered that's already beyond the background noise floor.
6. Margin (dB) = Remark result (dBuV/m) – Average limit (dBuV/m).



Operation Mode: TX / IEEE 802.11a / CH High

Test Date: July 8, 2006

Temperature: 25°C

Tested by: Skyman Tsai

Humidity: 55% RH

Polarity: Ver. / Hor.

Frequency (MHz)	Ant. Pol. (H/V)	Reading (Peak) (dBuV)	Reading (Average) (dBuV)	Correction Factor (dB/m)	Result (Peak) (dBuV/m)	Result (Average) (dBuV/m)	Limit (Peak) (dBuV/m)	Limit (Average) (dBuV/m)	Margin (dB)	Remark
5421.67	V	52.20	43.36	9.84	62.04	53.20	74.00	54.00	-0.80	Average
N/A										
5398.33	H	48.61	36.38	9.75	58.36	46.13	74.00	54.00	-7.87	Average
N/A										

Remark:

1. Measuring frequencies from 1 GHz to the 10th harmonic of highest fundamental frequency.
2. Radiated emissions measured in frequency above 1000MHz were made with an instrument using peak/average detector mode.
3. Average test would be performed if the peak result were greater than the average limit or as required by the applicant.
4. Data of measurement within this frequency range shown “ --- ” in the table above means the reading of emissions are attenuated more than 20dB below the permissible limits or the field strength is too small to be measured.
5. Measurements above show only up to 6 maximum emissions noted, or would be lesser, with “ N/A ” remark, if no specific emissions from the EUT are recorded (ie: margin > 20dB from the applicable limit) and considered that's already beyond the background noise floor.
6. Margin (dB) = Remark result (dBuV/m) – Average limit (dBuV/m).



Operation Mode: TX / IEEE 802.11b / CH Low

Test Date: July 8, 2006

Temperature: 23°C

Tested by: Skyman Tsai

Humidity: 51 % RH

Polarity: Ver. / Hor.

Frequency (MHz)	Ant. Pol. (H/V)	Reading (Peak) (dBuV)	Reading (Average) (dBuV)	Correction Factor (dB/m)	Result (Peak) (dBuV/m)	Result (Average) (dBuV/m)	Limit (Peak) (dBuV/m)	Limit (Average) (dBuV/m)	Margin (dB)	Remark
1740.00	V	49.58	31.05	10.65	60.23	41.70	74.00	54.00	-12.30	Average
4825.00	V	45.19	38.38	7.94	53.13	46.32	74.00	54.00	-0.87	Average
N/A										
1740.00	H	42.36	29.58	10.65	53.01	40.23	74.00	54.00	-0.99	Average
N/A										

Remark:

1. Measuring frequencies from 1 GHz to the 10th harmonic of highest fundamental frequency.
2. Radiated emissions measured in frequency above 1000MHz were made with an instrument using peak/average detector mode.
3. Average test would be performed if the peak result were greater than the average limit or as required by the applicant.
4. Data of measurement within this frequency range shown “ --- ” in the table above means the reading of emissions are attenuated more than 20dB below the permissible limits or the field strength is too small to be measured.
5. Measurements above show only up to 6 maximum emissions noted, or would be lesser, with “ N/A ” remark, if no specific emissions from the EUT are recorded (ie: margin>20dB from the applicable limit) and considered that's already beyond the background noise floor.
6. Margin (dB) = Remark result (dBuV/m) – Average limit (dBuV/m).



Operation Mode: TX / IEEE 802.11b / CH Mid

Test Date: July 8, 2006

Temperature: 25°C

Tested by: Skyman Tsai

Humidity: 55 % RH

Polarity: Ver. / Hor.

Frequency (MHz)	Ant. Pol. (H/V)	Reading (Peak) (dBuV)	Reading (Average) (dBuV)	Correction Factor (dB/m)	Result (Peak) (dBuV/m)	Result (Average) (dBuV/m)	Limit (Peak) (dBuV/m)	Limit (Average) (dBuV/m)	Margin (dB)	Remark
1926.67	V	44.02	30.87	10.50	54.52	41.37	74.00	54.00	-12.63	Average
4875.00	V	44.78	---	7.99	52.77	---	74.00	54.00	-1.23	Peak
N/A										
2070.00	H	44.06	30.65	10.10	54.16	40.75	74.00	54.00	-13.25	Average
N/A										

Remark:

1. Measuring frequencies from 1 GHz to the 10th harmonic of highest fundamental frequency.
2. Radiated emissions measured in frequency above 1000MHz were made with an instrument using peak/average detector mode.
3. Average test would be performed if the peak result were greater than the average limit or as required by the applicant.
4. Data of measurement within this frequency range shown “ --- ” in the table above means the reading of emissions are attenuated more than 20dB below the permissible limits or the field strength is too small to be measured.
5. Measurements above show only up to 6 maximum emissions noted, or would be lesser, with “ N/A ” remark, if no specific emissions from the EUT are recorded (ie: margin>20dB from the applicable limit) and considered that's already beyond the background noise floor.
6. Margin (dB) = Remark result (dBuV/m) – Average limit (dBuV/m).



Operation Mode: TX / IEEE 802.11b / CH High

Test Date: July 8, 2006

Temperature: 25°C

Tested by: Skyman Tsai

Humidity: 55 % RH

Polarity: Ver. / Hor.

Frequency (MHz)	Ant. Pol. (H/V)	Reading (Peak) (dBuV)	Reading (Average) (dBuV)	Correction Factor (dB/m)	Result (Peak) (dBuV/m)	Result (Average) (dBuV/m)	Limit (Peak) (dBuV/m)	Limit (Average) (dBuV/m)	Margin (dB)	Remark
1890.00	V	43.02	29.87	10.53	53.55	40.40	74.00	54.00	-0.45	Average
4925.00	V	42.42	---	8.05	50.47	---	74.00	54.00	-3.53	Peak
N/A										
1933.33	H	44.02	30.12	10.49	54.51	40.61	74.00	54.00	-13.39	Average
N/A										

Remark:

1. Measuring frequencies from 1 GHz to the 10th harmonic of highest fundamental frequency.
2. Radiated emissions measured in frequency above 1000MHz were made with an instrument using peak/average detector mode.
3. Average test would be performed if the peak result were greater than the average limit or as required by the applicant.
4. Data of measurement within this frequency range shown “ --- ” in the table above means the reading of emissions are attenuated more than 20dB below the permissible limits or the field strength is too small to be measured.
5. Measurements above show only up to 6 maximum emissions noted, or would be lesser, with “ N/A ” remark, if no specific emissions from the EUT are recorded (ie: margin>20dB from the applicable limit) and considered that's already beyond the background noise floor.
6. Margin (dB) = Remark result (dBuV/m) – Average limit (dBuV/m).



Operation Mode: TX / IEEE 802.11g / CH Low

Test Date: July 8, 2006

Temperature: 25°C

Tested by: Skyman Tsai

Humidity: 55 % RH

Polarity: Ver. / Hor.

Frequency (MHz)	Ant. Pol. (H/V)	Reading (Peak) (dBuV)	Reading (Average) (dBuV)	Correction Factor (dB/m)	Result (Peak) (dBuV/m)	Result (Average) (dBuV/m)	Limit (Peak) (dBuV/m)	Limit (Average) (dBuV/m)	Margin (dB)	Remark
1913.33	V	43.68	30.22	10.51	54.19	40.73	74.00	54.00	-13.27	Average
N/A										
1886.67	H	43.72	30.06	10.53	54.25	40.59	74.00	54.00	-13.41	Average
2513.33	H	52.21	45.36	7.98	60.19	53.34	74.00	54.00	-0.66	Average
N/A										

Remark:

1. Measuring frequencies from 1 GHz to the 10th harmonic of highest fundamental frequency.
2. Radiated emissions measured in frequency above 1000MHz were made with an instrument using peak/average detector mode.
3. Average test would be performed if the peak result were greater than the average limit or as required by the applicant.
4. Data of measurement within this frequency range shown " --- " in the table above means the reading of emissions are attenuated more than 20dB below the permissible limits or the field strength is too small to be measured.
5. Measurements above show only up to 6 maximum emissions noted, or would be lesser, with " N/A " remark, if no specific emissions from the EUT are recorded (ie: margin > 20dB from the applicable limit) and considered that's already beyond the background noise floor.
6. Margin (dB) = Remark result (dBuV/m) – Average limit (dBuV/m).



Operation Mode: TX / IEEE 802.11g / CH Mid

Test Date: July 8, 2006

Temperature: 25°C

Tested by: Skyman Tsai

Humidity: 55 % RH

Polarity: Ver. / Hor.

Frequency (MHz)	Ant. Pol. (H/V)	Reading (Peak) (dBuV)	Reading (Average) (dBuV)	Correction Factor (dB/m)	Result (Peak) (dBuV/m)	Result (Average) (dBuV/m)	Limit (Peak) (dBuV/m)	Limit (Average) (dBuV/m)	Margin (dB)	Remark
2073.33	V	45.13	30.89	10.08	55.21	40.97	74.00	54.00	-13.03	Average
N/A										
2163.33	H	44.12	30.32	9.65	53.77	39.97	74.00	54.00	-0.23	Average
2540.00	H	50.12	42.65	7.90	58.02	50.55	74.00	54.00	-3.45	Average
N/A										

Remark:

1. Measuring frequencies from 1 GHz to the 10th harmonic of highest fundamental frequency.
2. Radiated emissions measured in frequency above 1000MHz were made with an instrument using peak/average detector mode.
3. Average test would be performed if the peak result were greater than the average limit or as required by the applicant.
4. Data of measurement within this frequency range shown " --- " in the table above means the reading of emissions are attenuated more than 20dB below the permissible limits or the field strength is too small to be measured.
5. Measurements above show only up to 6 maximum emissions noted, or would be lesser, with " N/A " remark, if no specific emissions from the EUT are recorded (ie: margin > 20dB from the applicable limit) and considered that's already beyond the background noise floor.
6. Margin (dB) = Remark result (dBuV/m) – Average limit (dBuV/m).



Operation Mode: TX / IEEE 802.11g / CH High

Test Date: July 8, 2006

Temperature: 25°C

Tested by: Skyman Tsai

Humidity: 55 % RH

Polarity: Ver. / Hor.

Frequency (MHz)	Ant.Pol. (H/V)	Reading (Peak) (dBuV)	Reading (Average) (dBuV)	Correction Factor (dB/m)	Result (Peak) (dBuV/m)	Result (Average) (dBuV/m)	Limit (Peak) (dBuV/m)	Limit (Average) (dBuV/m)	Margin (dB)	Remark
2000.00	V	43.32	40.12	10.44	53.76	50.56	74.00	54.00	-0.24	Average
N/A										
2013.33	H	43.52	40.89	10.37	53.89	51.26	74.00	54.00	-0.11	Average
N/A										

Remark:

1. Measuring frequencies from 1 GHz to the 10th harmonic of highest fundamental frequency.
2. Radiated emissions measured in frequency above 1000MHz were made with an instrument using peak/average detector mode.
3. Average test would be performed if the peak result were greater than the average limit or as required by the applicant.
4. Data of measurement within this frequency range shown “ --- ” in the table above means the reading of emissions are attenuated more than 20dB below the permissible limits or the field strength is too small to be measured.
5. Measurements above show only up to 6 maximum emissions noted, or would be lesser; with “ N/A ” remark, if no specific emissions from the EUT are recorded (ie: margin>20dB from the applicable limit) and considered that's already beyond the background noise floor.
6. Margin (dB) = Remark result (dBuV/m) – Average limit (dBuV/m).



CONDITION B: BLUETOOTH OPERATION

7.7 PEAK POWER

LIMIT

The maximum peak output power of the intentional radiator shall not exceed the following:

1. According to §15.247(b)(3), for systems using digital modulation in the bands of 902-928 MHz, 2400-2483.5 MHz, and 5725-5850 MHz: 1 Watt.
2. According to §15.247(b)(4), the conducted output power limit specified in paragraph (b) of this section is based on the use of antennas with directional gains that do not exceed 6 dBi. Except as shown in paragraph (c) of this section, if transmitting antennas of directional gain greater than 6 dBi are used, the conducted output power from the intentional radiator shall be reduced below the stated values in paragraphs (b)(1), (b)(2), and (b)(3) of this section, as appropriate, by the amount in dB that the directional gain of the antenna exceeds 6 dBi.

Test Configuration

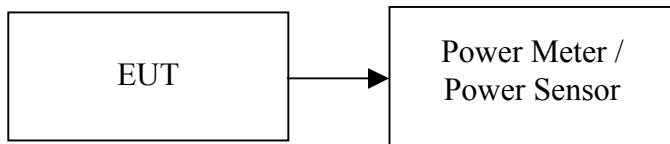

TEST PROCEDURE

The transmitter output is connected to the Spectrum analyzer. The Spectrum analyzer is set to the peak power detection.

TEST RESULTS

No non-compliance noted

Test Data

Channel	Frequency (MHz)	Output Power (dBm)	Output Power (W)	Limit (W)	Result
Low	2402	2.40	0.0017	1	PASS
Mid	2441	2.13	0.0016		PASS
High	2480	1.70	0.0015		PASS



7.8 AVERAGE POWER

LIMIT

None; for reporting purposes only.

Test Configuration

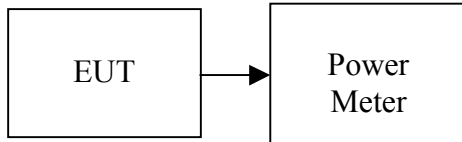

TEST PROCEDURE

The transmitter output is connected to the Spectrum analyzer. The Spectrum analyzer is set to the average power detection.

TEST RESULTS

No non-compliance noted.

Test Data

Channel	Frequency (MHz)	Output Power (dBm)	Output Power (W)
Low	2402	-1.48	0.0007
Mid	2441	-1.62	0.0007
High	2480	-2.26	0.0006

7.9 BAND EDGES MEASUREMENT

LIMIT

According to §15.247(d), in any 100 kHz bandwidth outside the frequency bands in which the spread spectrum intentional radiator is operating, the radio frequency power that is produced by the intentional radiator shall be at least 20 dB below that in the 100 kHz bandwidth within the band that contains the highest level of the desired power, based on either an RF conducted or a radiated measurement, provided the transmitter demonstrates compliance with the peak conducted power limits. In addition, radiated emissions which fall in the restricted bands, as defined in §15.205(a), must also comply with the radiated emission limits specified in 15.209(a) (see Section 15.205(c)).

Test Configuration

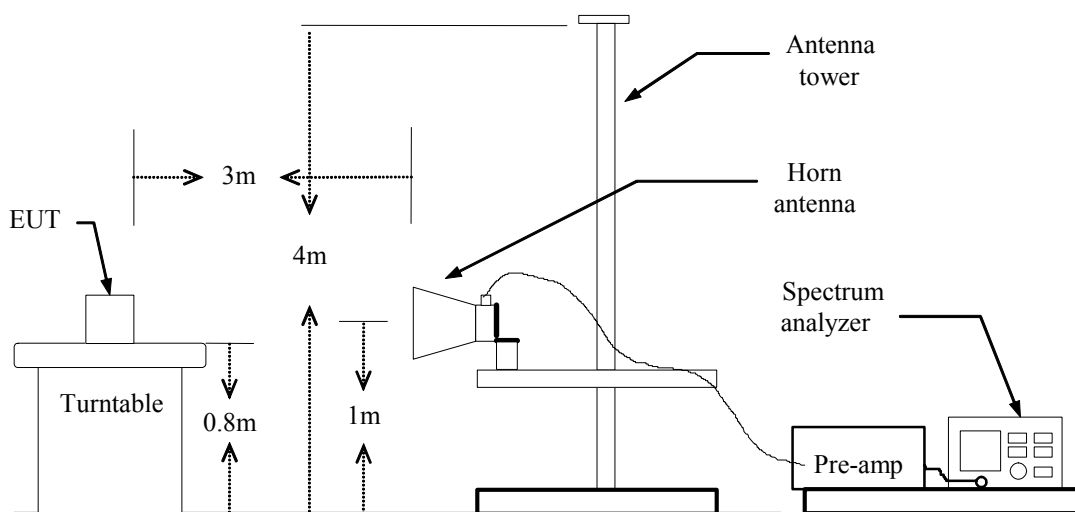

TEST PROCEDURE

1. The EUT is placed on a turntable, which is 0.8m above the ground plane.
2. The turntable shall be rotated for 360 degrees to determine the position of maximum emission level.
3. EUT is set 3m away from the receiving antenna, which is varied from 1m to 4m to find out the highest emission.
4. Set the spectrum analyzer in the following setting in order to capture the lower and upper band-edges of the emission:
 - (a) PEAK: RBW=VBW=1MHz / Sweep=AUTO
 - (b) AVERAGE: RBW=1MHz / VBW=10Hz / Sweep=AUTO
5. Repeat the procedures until all the PEAK and AVERAGE versus POLARIZATION are measured.

TEST RESULTS

Refer to attach spectrum analyzer data chart.



Band Edges (Bluetooth / CH Low)

Detector mode: Peak

Polarity: Vertical

Agilent 10:42:31 Jul 8, 2006

R T

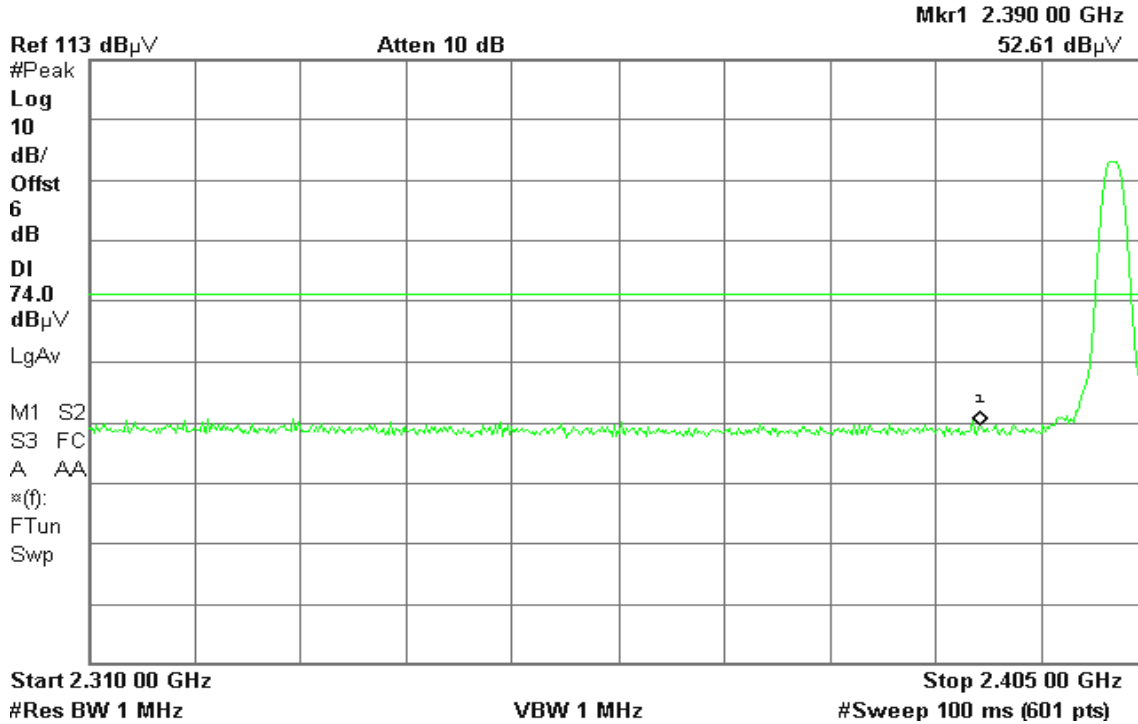

Detector mode: Average

Polarity: Vertical

Agilent 10:42:07 Jul 8, 2006

R T

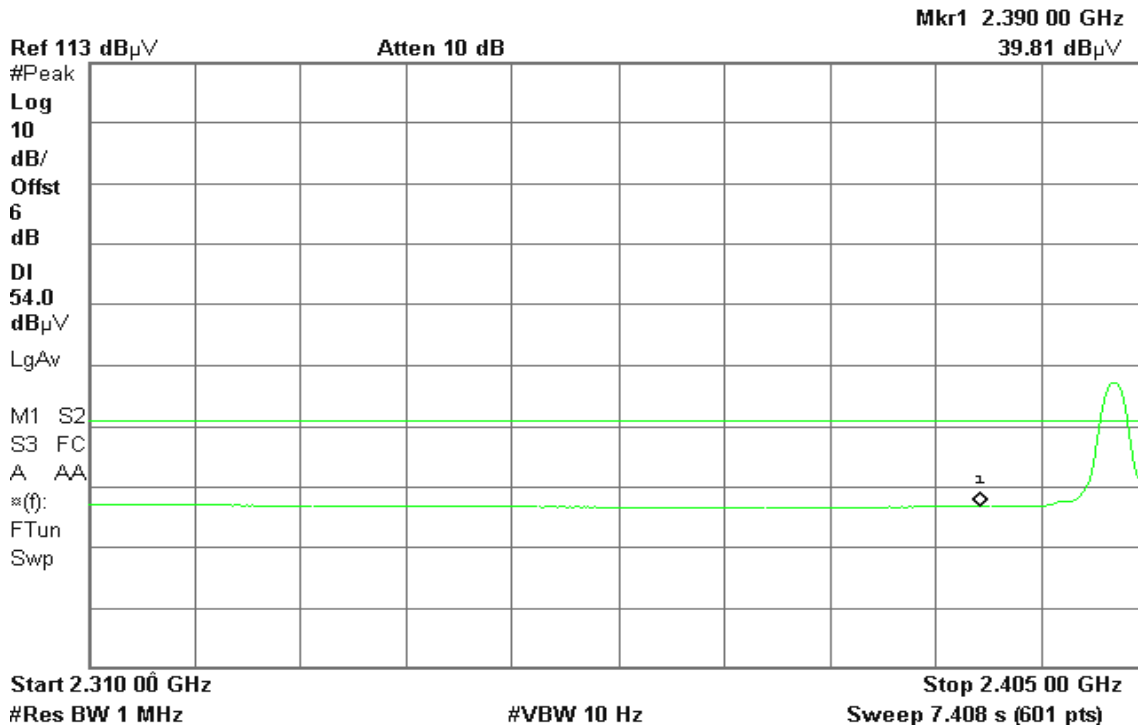



Detector mode: Peak

Polarity: Horizontal

Agilent 10:51:00 Jul 8, 2006

T

Mkr1 2.385 88 GHz
52.69 dB μ V

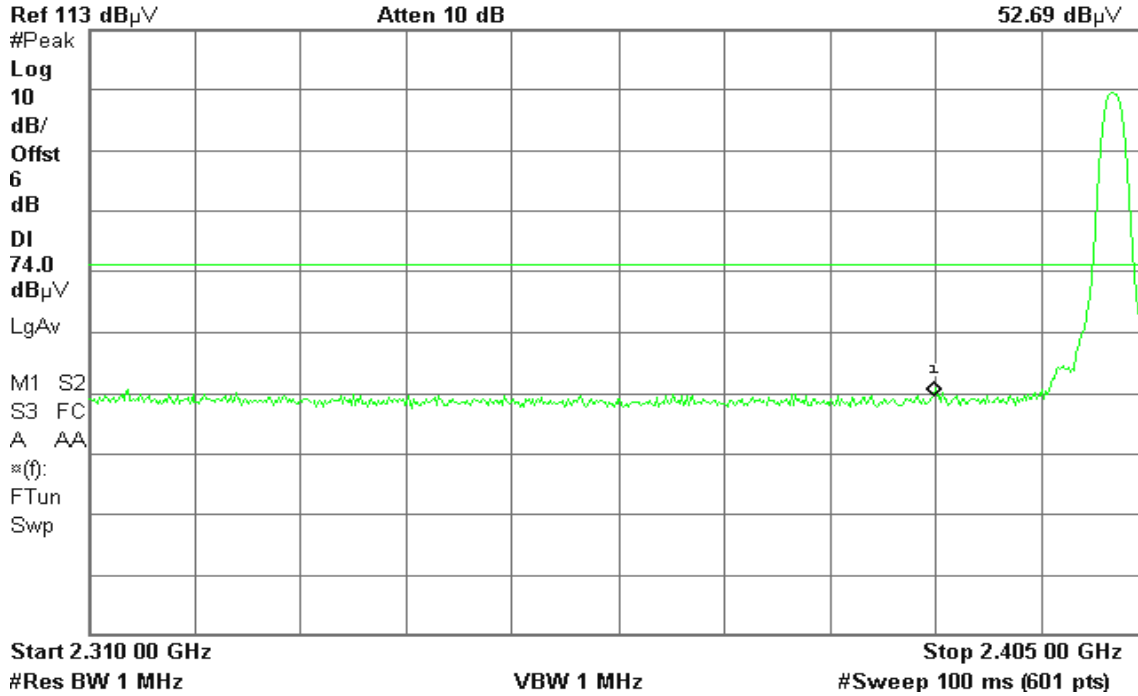

Detector mode: Average

Polarity: Horizontal

Agilent 10:50:40 Jul 8, 2006

R T

Mkr1 2.385 88 GHz
40.37 dB μ V

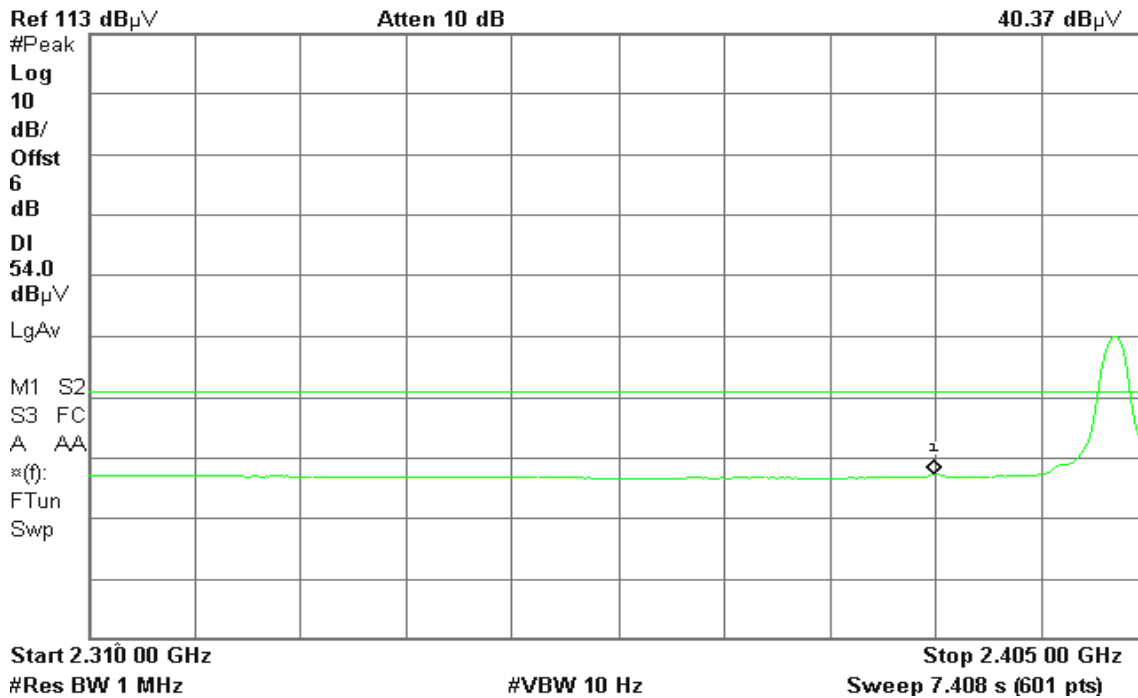



Band Edges (Bluetooth / CH High)

Detector mode: Peak

Polarity: Vertical

Agilent 11:01:13 Jul 8, 2006

R T

Mkr1 2.484 04 GHz
53.25 dB μ V

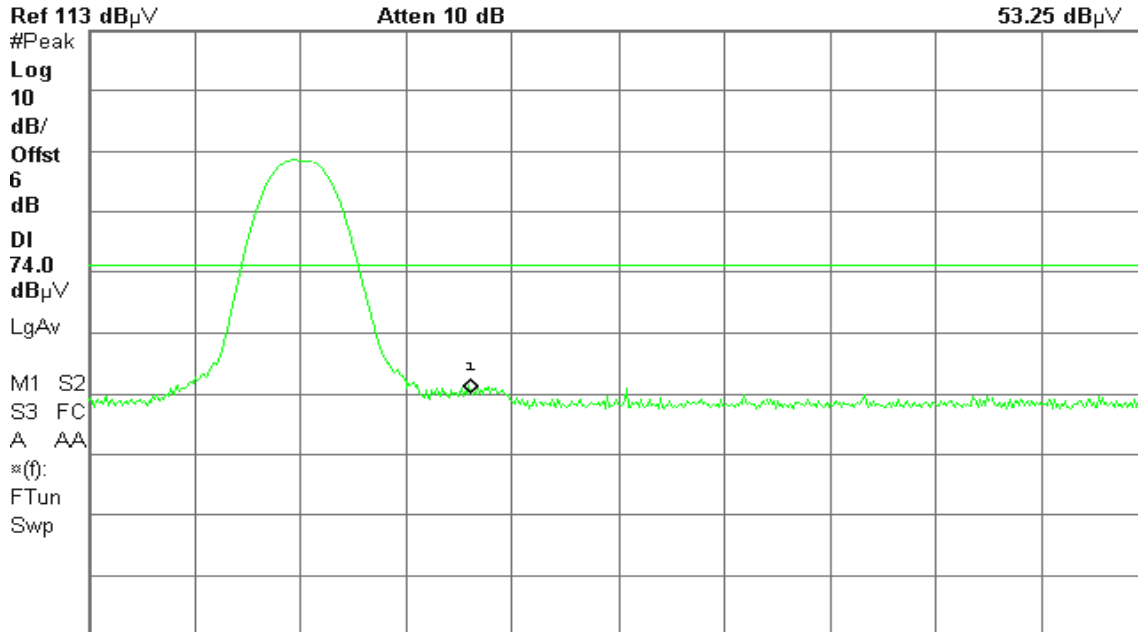

Start 2.475 00 GHz

Stop 2.500 00 GHz

#Res BW 1 MHz

VBW 1 MHz

#Sweep 100 ms (601 pts)

Detector mode: Average

Polarity: Vertical

Agilent 11:00:50 Jul 8, 2006

R T

Mkr1 2.484 04 GHz
40.63 dB μ V

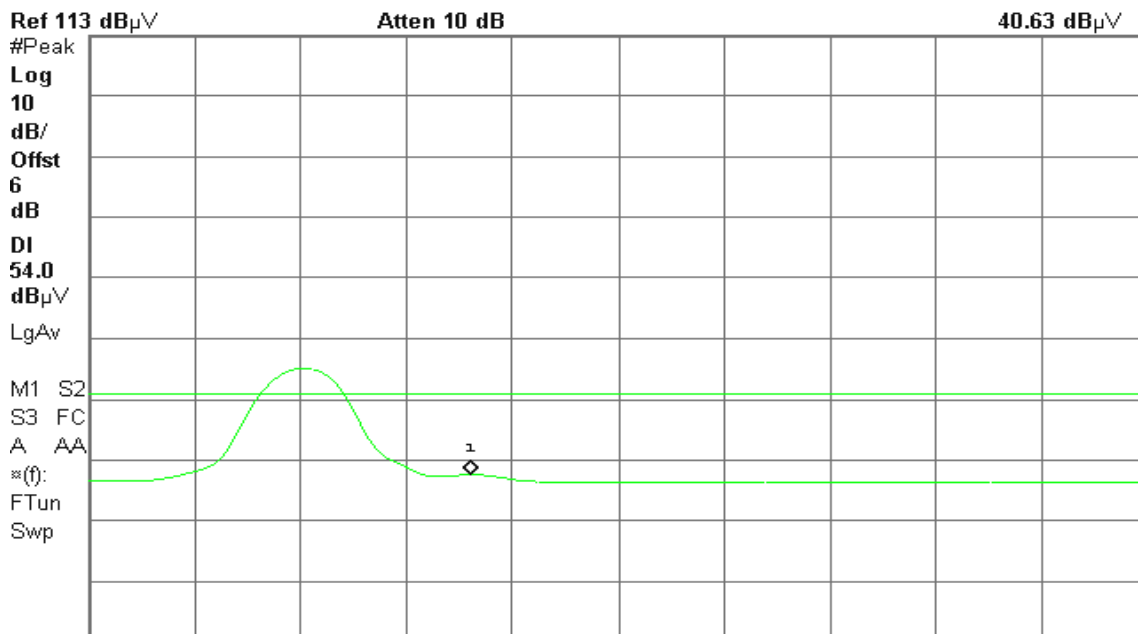

Start 2.475 00 GHz

Stop 2.500 00 GHz

#Res BW 1 MHz

#VBW 10 Hz

Sweep 1.949 s (601 pts)



Detector mode: Peak

Polarity: Horizontal

Agilent 10:57:03 Jul 8, 2006

R T

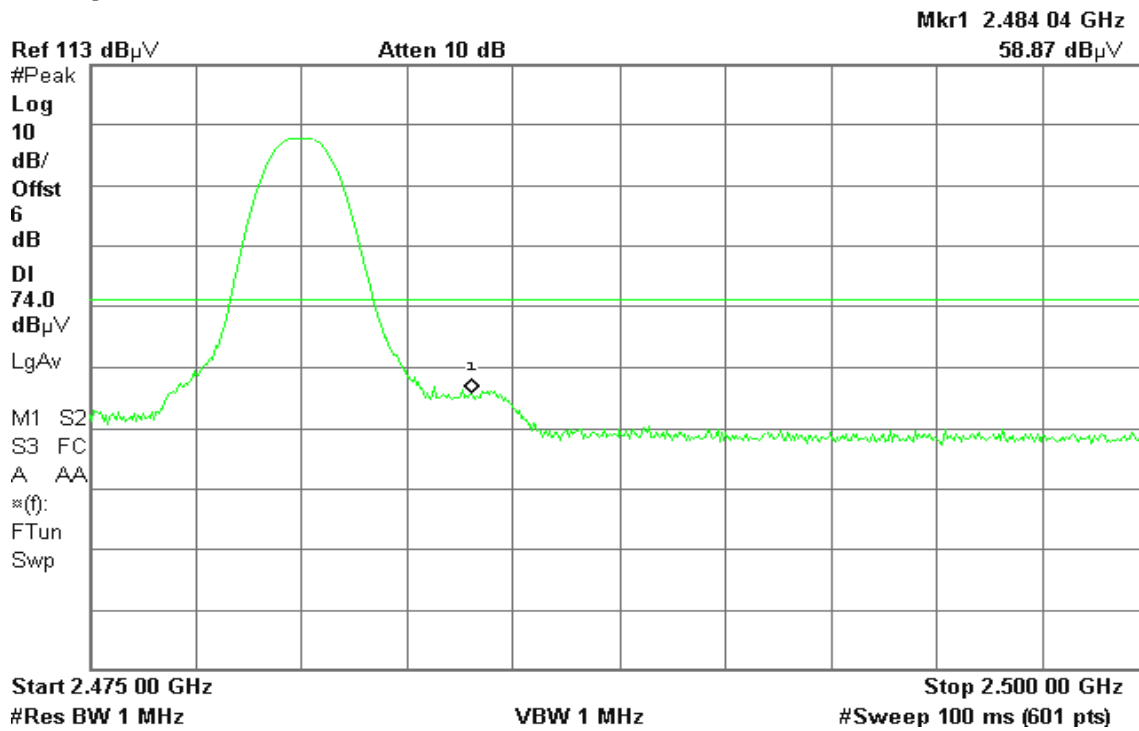

Detector mode: Average

Polarity: Horizontal

Agilent 10:56:42 Jul 8, 2006

R T

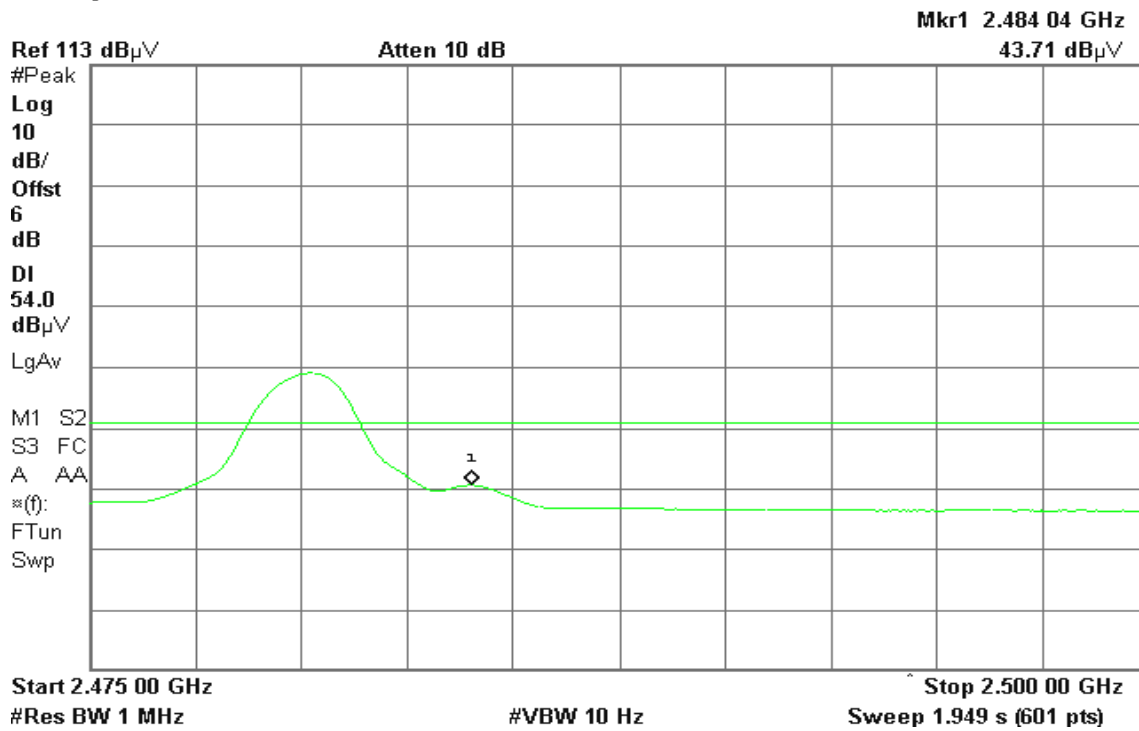

7.10 PEAK POWER SPECTRAL DENSITY

LIMIT

1. According to §15.247(e), for digitally modulated systems, the power spectral density conducted from the intentional radiator to the antenna shall not be greater than 8 dBm in any 3 kHz band during any time interval of continuous transmission.
2. According to §15.247(f), the digital modulation operation of the hybrid system, with the frequency hopping turned off, shall comply with the power density requirements of paragraph (d) of this section.

Test Configuration

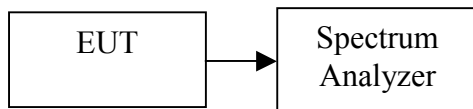

TEST PROCEDURE

1. Place the EUT on the table and set it in transmitting mode.
2. Remove the antenna from the EUT and then connect a low loss RF cable from the antenna port to the spectrum analyzer.
3. Set the spectrum analyzer as RBW = 3kHz, VBW = 10kHz, Span = 300kHz, Sweep=100s
4. Record the max. reading.
5. Repeat the above procedure until the measurements for all frequencies are completed.

TEST RESULTS

No non-compliance noted

Test Data

Channel	Frequency	PPSD (dBm)	Limit (dBm)	Result
Low	2402	-5.09	8.00	PASS
Mid	2441	-5.42		PASS
High	2480	-6.34		PASS



Test Plot

PPSD (Bluetooth / CH Low)

Agilent 20:50:40 Jul 10, 2006

T
Mkr1 2.401 989 3 GHz
-5.09 dBm

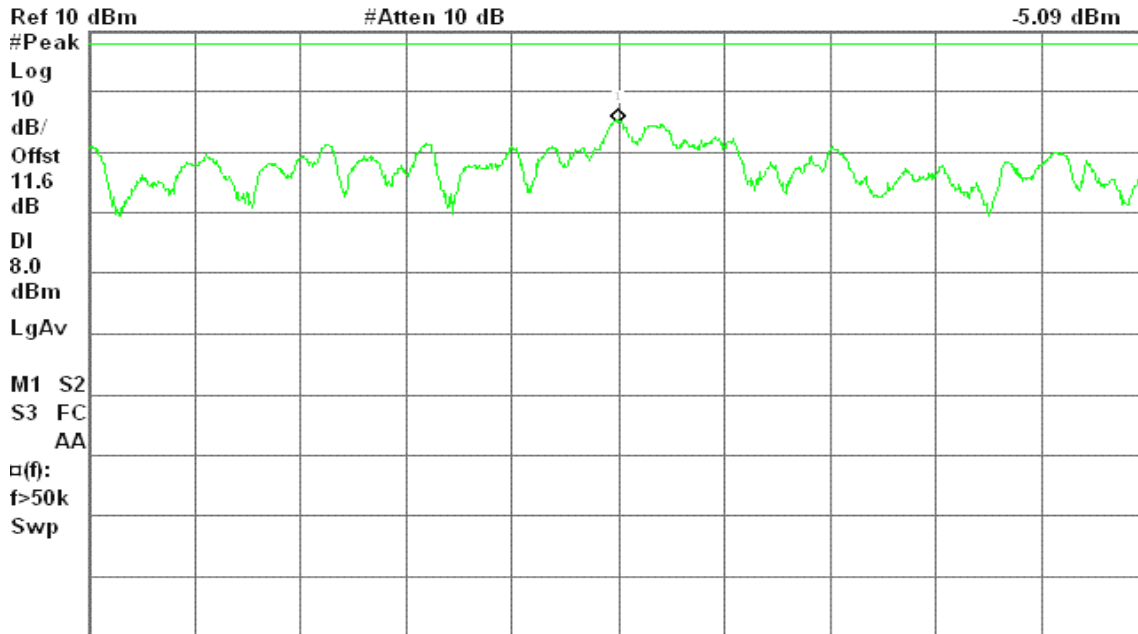

Center 2.401 989 3 GHz #Res BW 3 kHz #VBW 10 kHz Span 300 kHz #Sweep 100 s (1001 pts)

PPSD (Bluetooth / CH Mid)

Agilent 20:59:34 Jul 10, 2006

T
Mkr1 2.440 988 2 GHz
-5.42 dBm

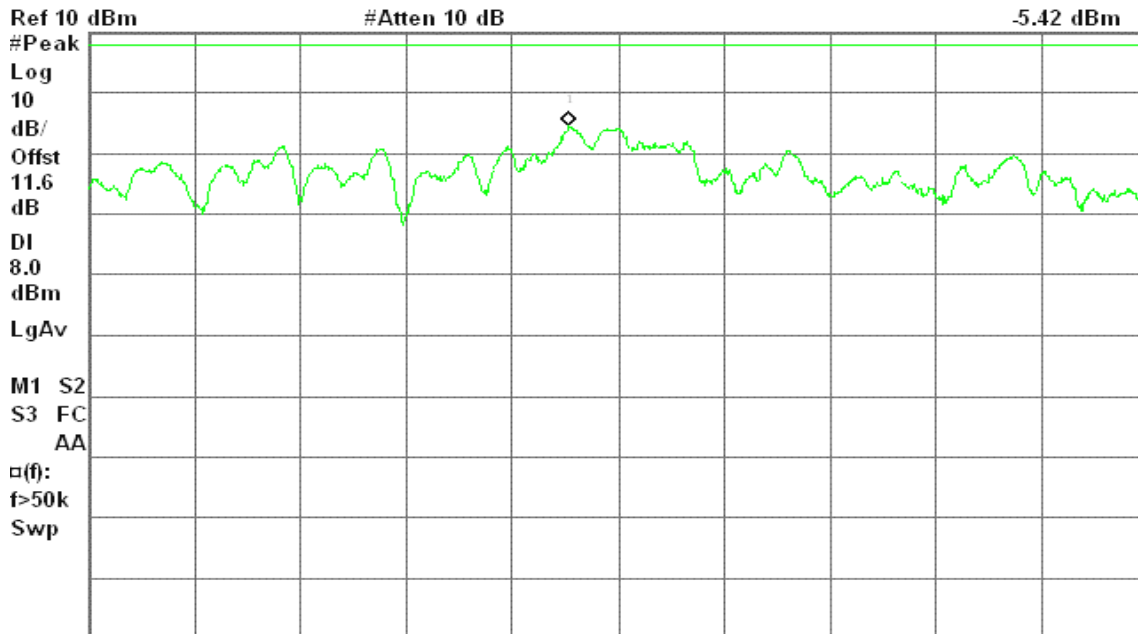

Center 2.441 002 0 GHz #Res BW 3 kHz #VBW 10 kHz Span 300 kHz #Sweep 100 s (1001 pts)



PPSD (Bluetooth / CH High)

Agilent 21:02:29 Jul 10, 2006

T
Mkr1 2.479 988 6 GHz
-6.34 dBm

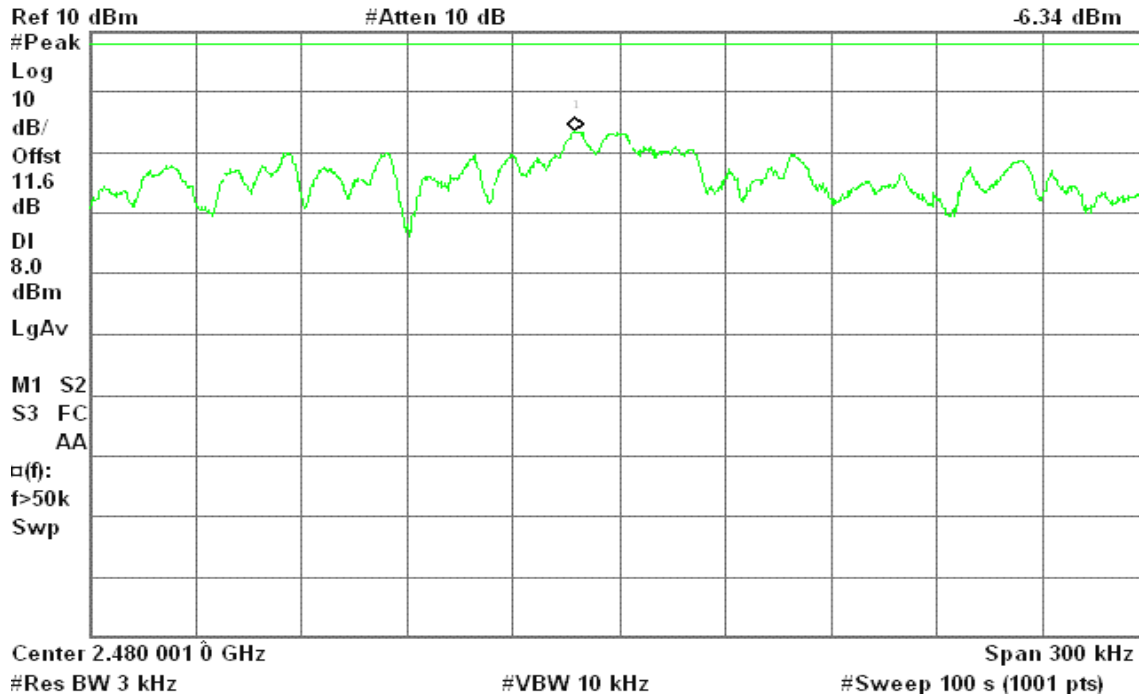

7.11 FREQUENCY SEPARATION

LIMIT

According to §15.247(a)(1), Frequency hopping systems shall have hopping channel carrier frequencies separated by minimum of 25kHz or the 20dB bandwidth of the hopping channel, whichever is greater.

Alternatively, frequency hopping systems operating in the 2400-2483.5 MHz band may have hopping channel carrier frequencies that are separated by 25 kHz or two-thirds of the 20 dB bandwidth of the hopping channel, whichever is greater, provided the systems operate with an output power no greater than 125 mW.

Test Configuration

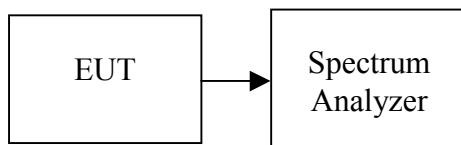

TEST PROCEDURE

1. Place the EUT on the table and set it in transmitting mode.
2. Remove the antenna from the EUT and then connect a low loss RF cable from the antenna port to the spectrum analyzer.
3. Set center frequency of spectrum analyzer = middle of hopping channel.
4. Set the spectrum analyzer as RBW = 30kHz, VBW = 100kHz, Span = 3MHz, Sweep = auto.
5. Max hold. Mark 3 Peaks of hopping channel and record the 3 peaks frequency.

TEST RESULTS

No non-compliance noted

Test Data

Channel Separation (MHz)	20dB Bandwidth (kHz)	Channel Separation Limit	Result
1.00	834	> 20dB Bandwidth or two-thirds of the 20 dB bandwidth	Pass



Test Plot

Measurement of Channel Separation

Agilent 21:10:45 Jul 10, 2006

T

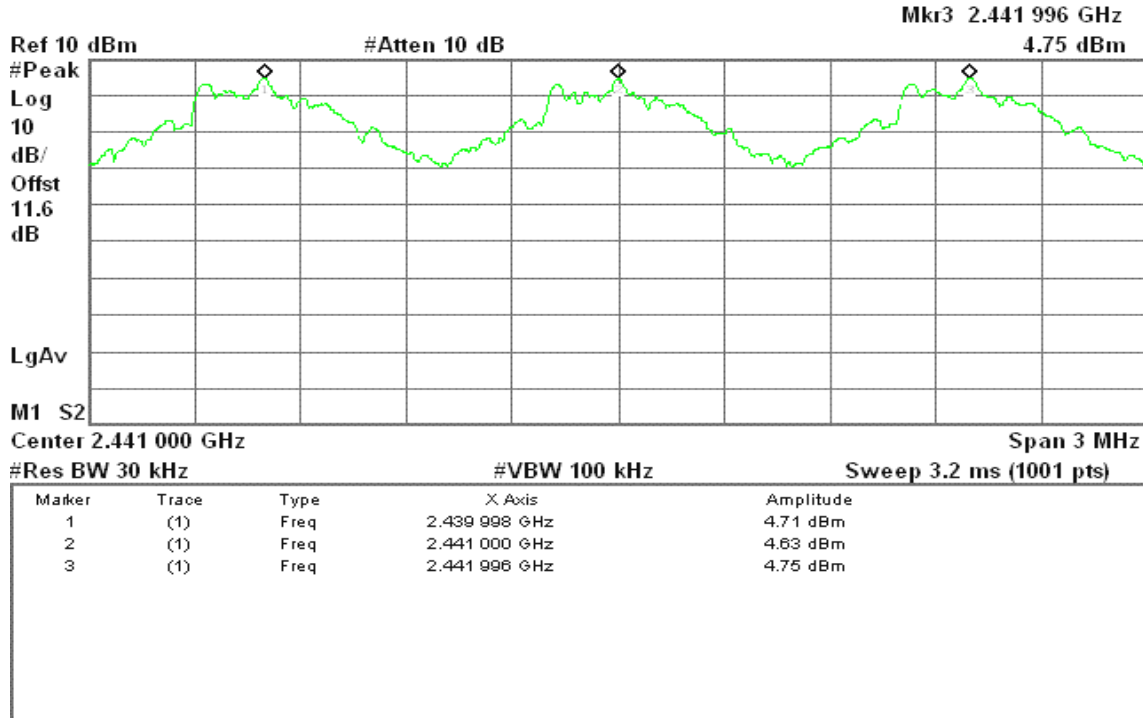

Measurement of 20dB Bandwidth

Agilent 20:43:38 Jul 10, 2006

T

Spurious, a Mode High Ch.

Δ Mkr2 834 kHz 2.46 dB

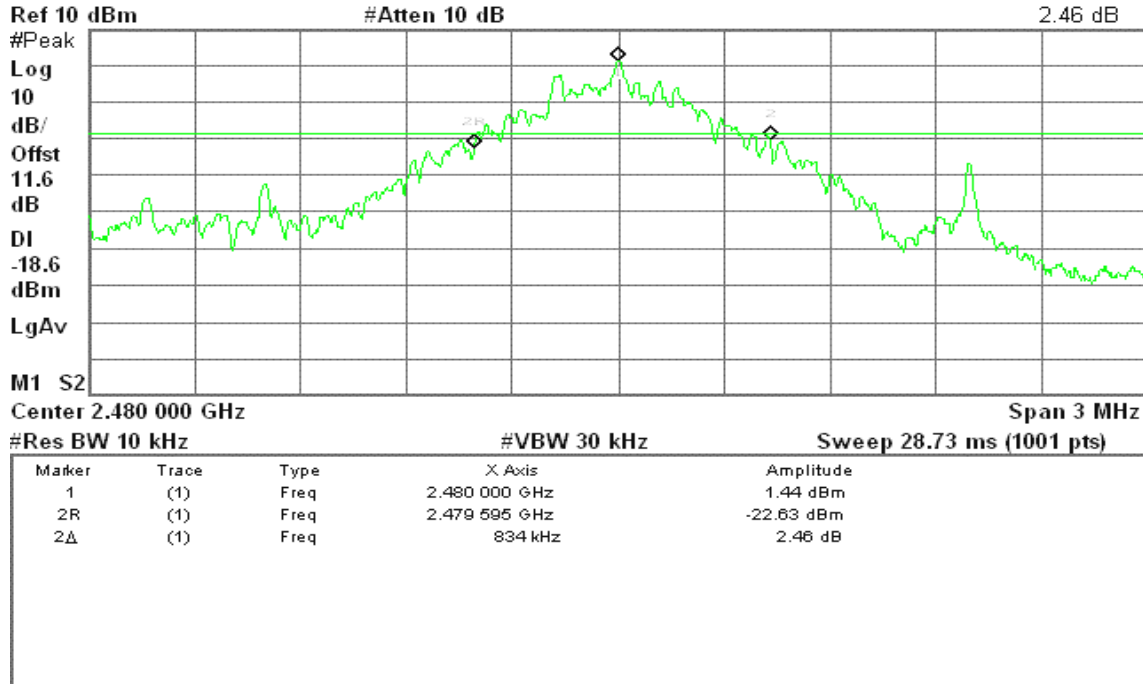

7.12 NUMBER OF HOPPING FREQUENCY

LIMIT

According to §15.247(a)(1)(ii), Frequency hopping systems operating in the 2400MHz-2483.5 MHz bands shall use at least 75 hopping frequencies.

Test Configuration

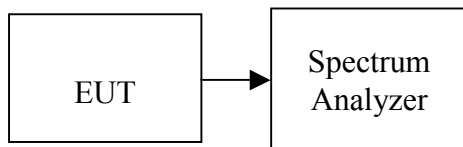

TEST PROCEDURE

1. Place the EUT on the table and set it in transmitting mode.
2. Remove the antenna from the EUT and then connect a low loss RF cable from the antenna port to the spectrum analyzer.
3. Set spectrum analyzer Start=2400MHz, Stop = 2441.5MHz, Sweep = auto and Start=2441.5MHz, Stop = 2483.5MHz, Sweep = auto.
4. Set the spectrum analyzer as RBW, VBW=510kHz.
5. Max hold, view and count how many channel in the band.

TEST RESULTS

No non-compliance noted

Test Data

Result (No. of CH)	Limit (No. of CH)	Result
79	>75	PASS



Test Plot

Channel Number

2.4 GHz – 2.4415 GHz

Agilent 21:14:52 Jul 10, 2006

T

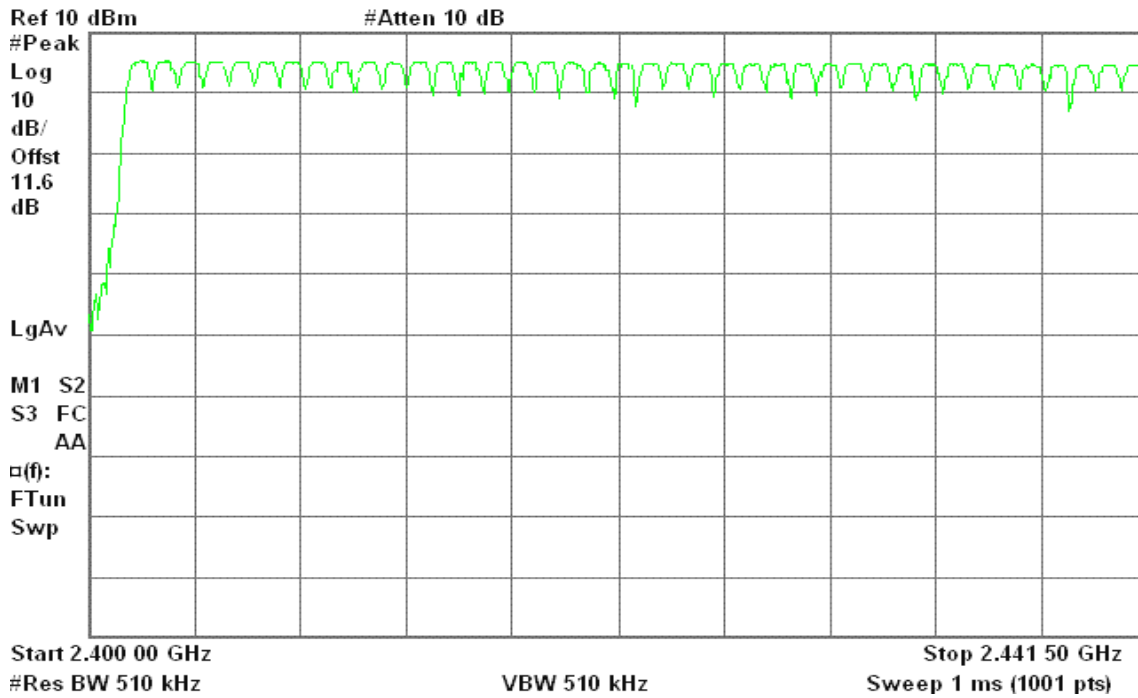

2.4415 GHz – 2.4835 GHz

Agilent 21:15:52 Jul 10, 2006

T

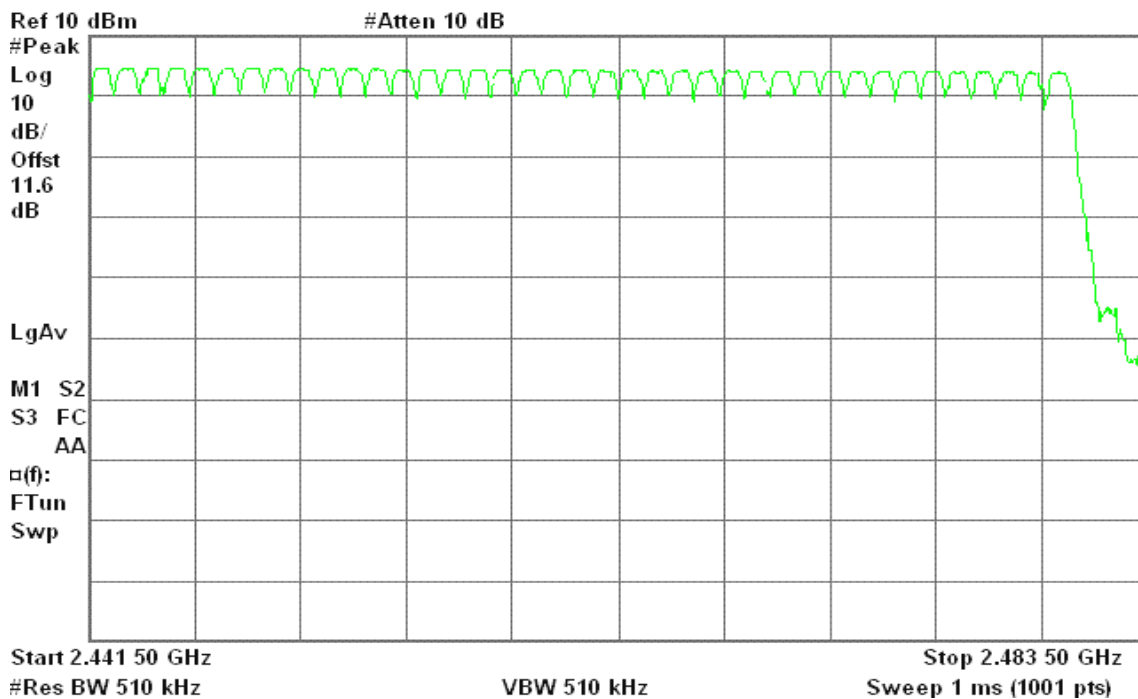

7.13 TIME OF OCCUPANCY (DWELL TIME)

LIMIT

According to §15.247(a)(1)(iii), Frequency hopping systems operating in the 2400MHz-2483.5 MHz bands. The average time of occupancy on any channels shall not greater than 0.4 s within a period 0.4 s multiplied by the number of hopping channels employed.

Test Configuration

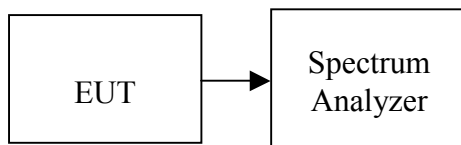

TEST PROCEDURE

1. Place the EUT on the table and set it in transmitting mode.
2. Remove the antenna from the EUT and then connect a low loss RF cable from the antenna port to the spectrum analyzer.
3. Set center frequency of spectrum analyzer = operating frequency.
4. Set the spectrum analyzer as RBW, VBW=1MHz, Span = 0Hz, Sweep = auto.
5. Repeat above procedures until all frequency measured were complete.

TEST RESULTS

No non-compliance noted



Test Data

DH 1

CH Low: $0.450 * (1600/2)/79 * 31.60 = 144.00$ (ms)

CH Mid: $0.440 * (1600/2)/79 * 31.60 = 140.80$ (ms)

CH High: $0.450 * (1600/2)/79 * 31.60 = 144.00$ (ms)

CH	Pulse Time (ms)	Total of Dwell (ms)	Period Time (s)	Limit (ms)	Result
Low	0.450	144.00	31.60	400.00	PASS
Mid	0.440	140.80	31.60		PASS
High	0.450	144.00	31.60		PASS

DH 3

CH Low: $1.710 * (1600/4)/79 * 31.60 = 273.60$ (ms)

CH Mid: $1.710 * (1600/4)/79 * 31.60 = 273.60$ (ms)

CH High: $1.710 * (1600/4)/79 * 31.60 = 273.60$ (ms)

CH	Pulse Time (ms)	Total of Dwell (ms)	Period Time (s)	Limit (ms)	Result
Low	1.710	273.60	31.60	400.00	PASS
Mid	1.710	273.60	31.60		PASS
High	1.710	273.60	31.60		PASS

DH 5

CH Low: $2.950 * (1600/6)/79 * 31.60 = 314.67$ (ms)

CH Mid: $2.950 * (1600/6)/79 * 31.60 = 314.67$ (ms)

CH High: $2.960 * (1600/6)/79 * 31.60 = 315.73$ (ms)

CH	Pulse Time (ms)	Total of Dwell (ms)	Period Time (s)	Limit (ms)	Result
Low	2.950	314.67	31.60	400.00	PASS
Mid	2.950	314.67	31.60		PASS
High	2.960	315.73	31.60		PASS



Test Plot

DH 1

(Bluetooth / CH Low)

Agilent 21:19:29 Jul 10, 2006

T

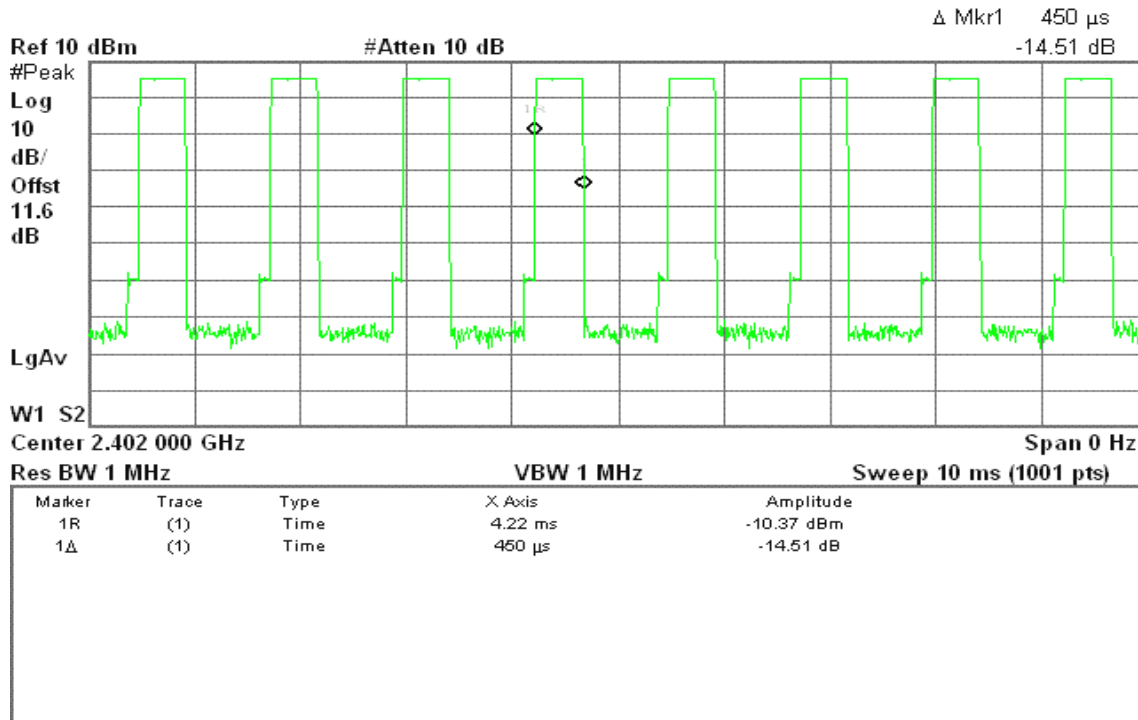

(Bluetooth / CH Mid)

Agilent 21:20:07 Jul 10, 2006

T

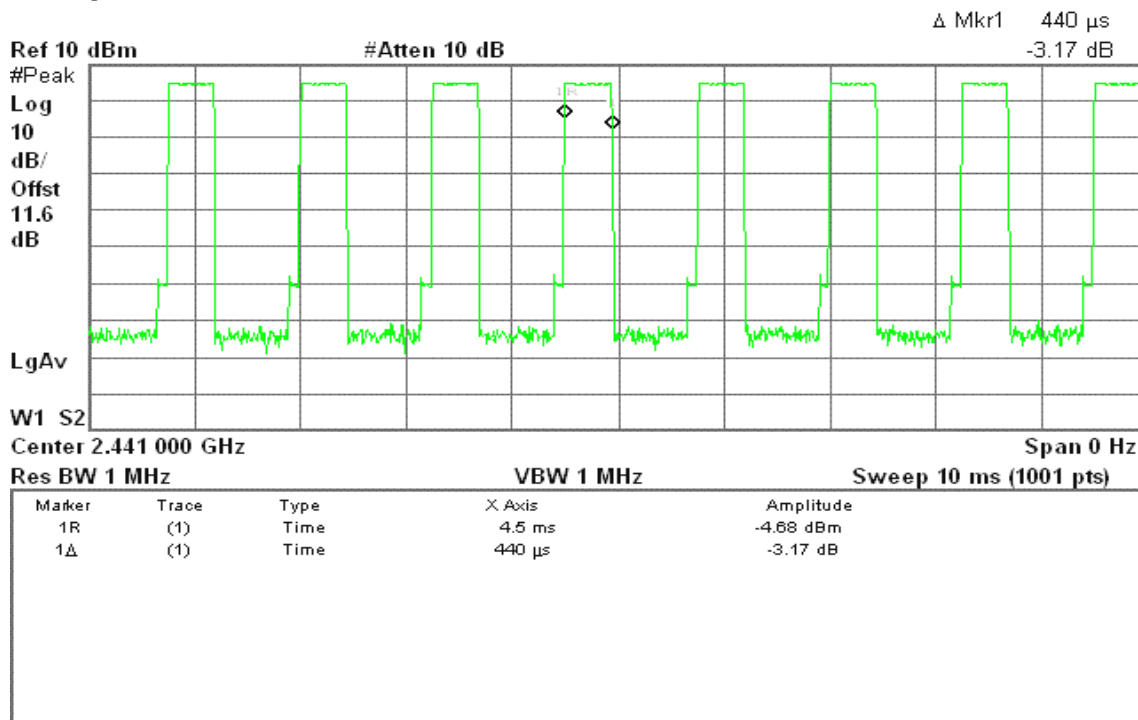



(Bluetooth / CH High)

Agilent 21:24:15 Jul 10, 2006

T

Δ Mkr1 450 μs
7.69 dB

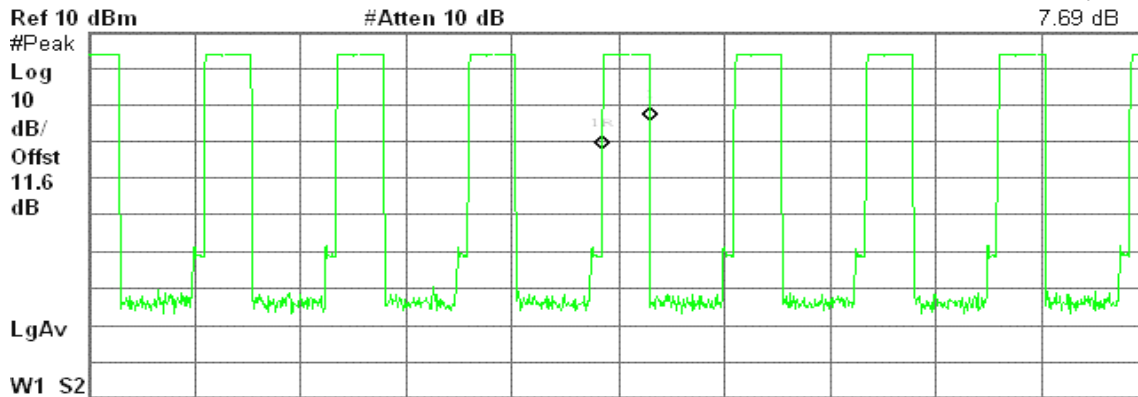

Center 2.480 000 GHz Span 0 Hz
Res BW 1 MHz VBW 1 MHz Sweep 10 ms (1001 pts)

Marker	Trace	Type	X Axis	Amplitude
1R	(1)	Time	4.84 ms	-22.06 dBm
1Δ	(1)	Time	450 μs	7.69 dB

DH 3

(Bluetooth / CH Low)

Agilent 21:18:10 Jul 10, 2006

T

Δ Mkr1 1.71 ms
5.13 dB

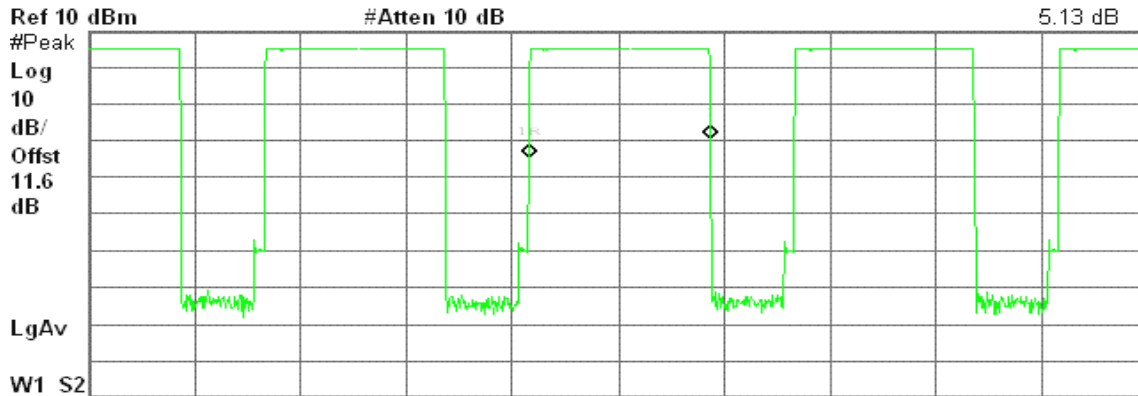

Center 2.402 000 GHz Span 0 Hz
Res BW 1 MHz VBW 1 MHz Sweep 10 ms (1001 pts)

Marker	Trace	Type	X Axis	Amplitude
1R	(1)	Time	4.16 ms	-24.63 dBm
1Δ	(1)	Time	1.71 ms	5.13 dB



(Bluetooth / CH Mid)

Agilent 21:20:47 Jul 10, 2006

T

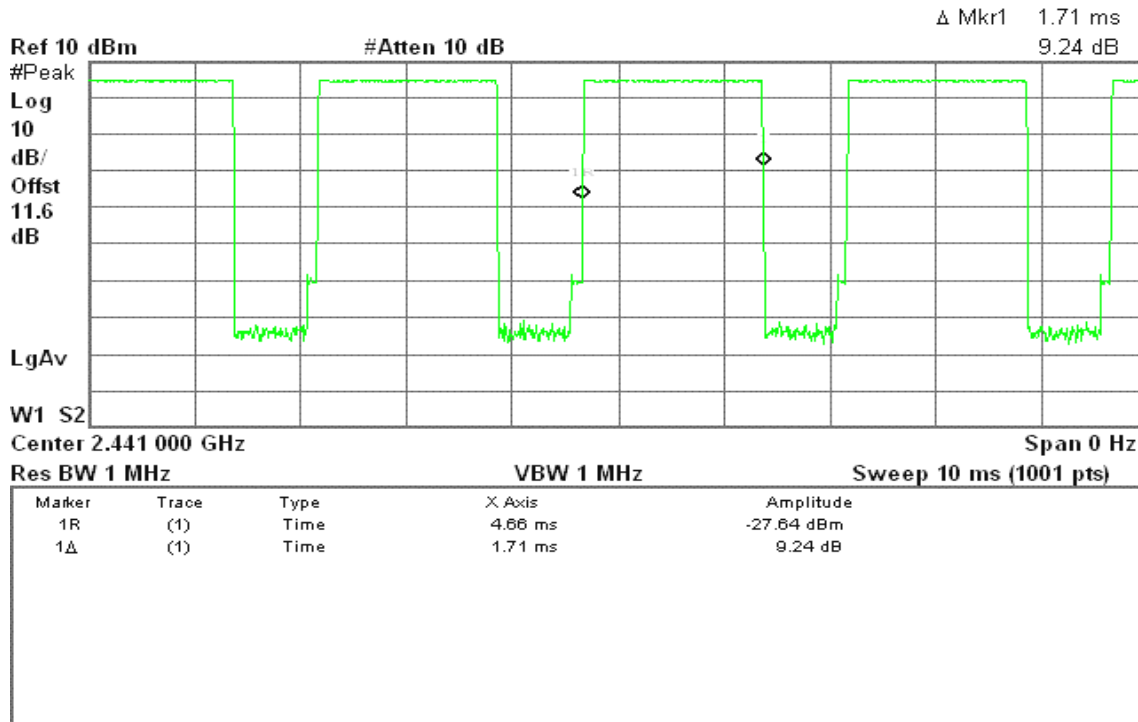

(Bluetooth / CH High)

Agilent 21:23:31 Jul 10, 2006

T

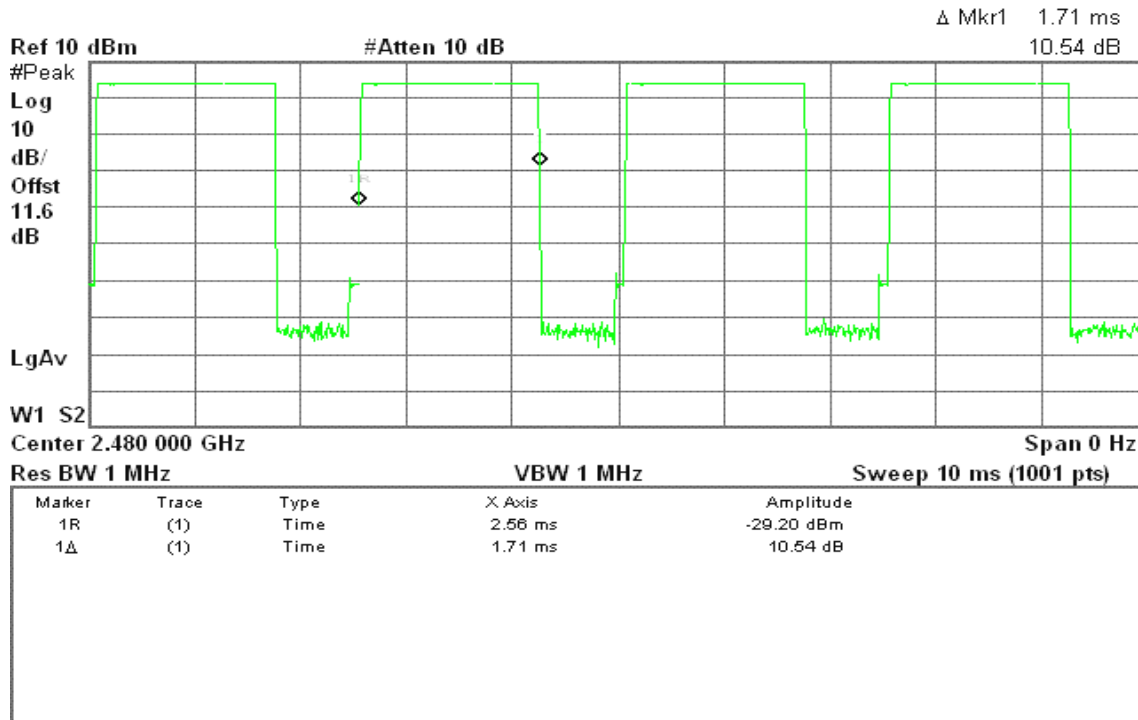



DH 5

(Bluetooth / CH Low)

Agilent 21:18:57 Jul 10, 2006

T

Δ Mkr1 2.95 ms
-11.11 dB

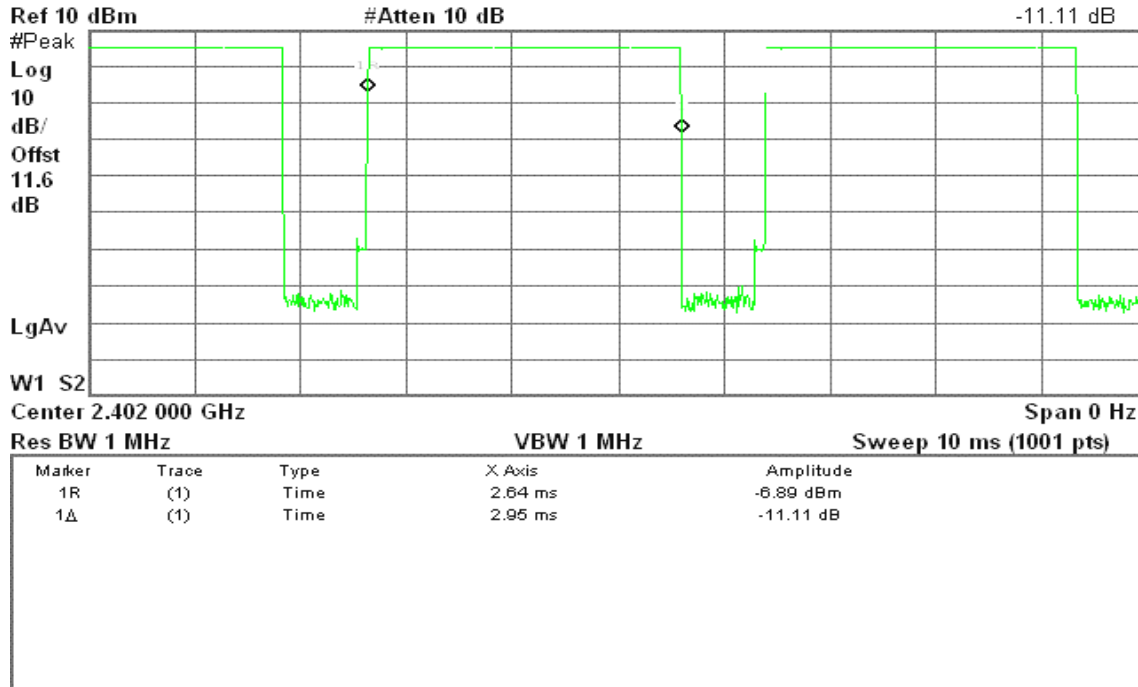

(Bluetooth / CH Mid)

Agilent 21:21:22 Jul 10, 2006

T

Δ Mkr1 2.95 ms
3.90 dB

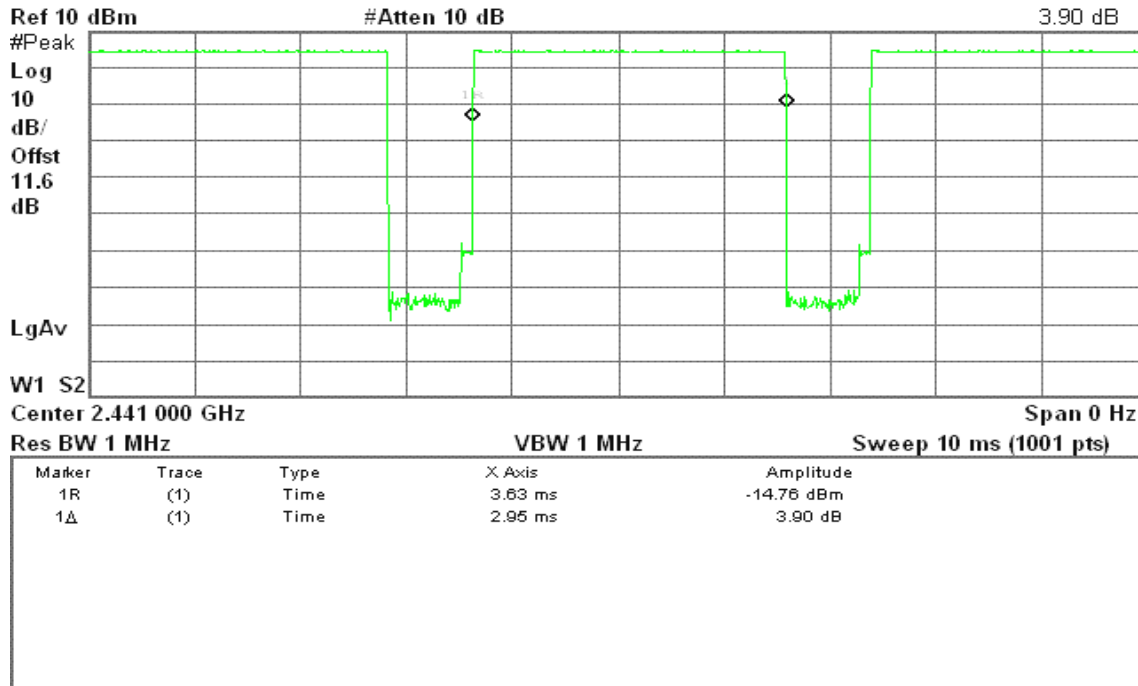



(Bluetooth / CH High)

Agilent 21:22:36 Jul 10, 2006

T

Δ Mkr1 2.96 ms
2.79 dB

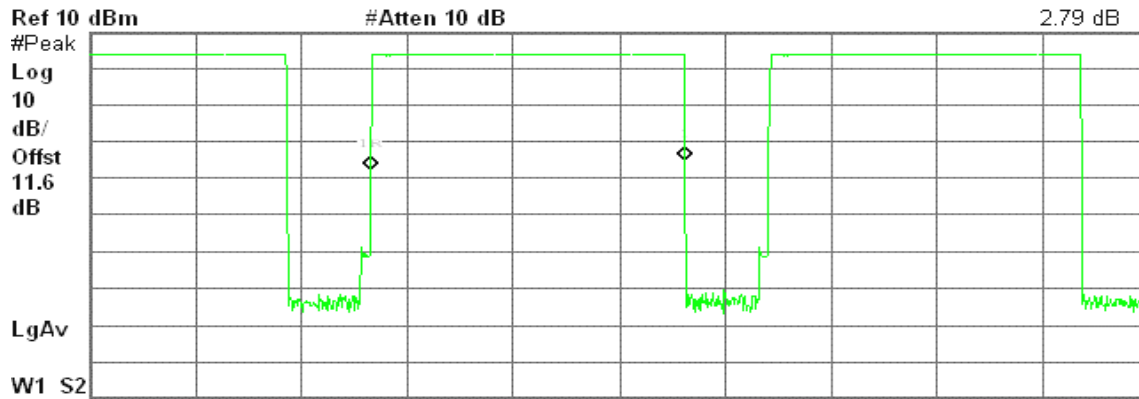

Center 2.480 000 GHz Span 0 Hz
Res BW 1 MHz VBW 1 MHz Sweep 10 ms (1001 pts)

Marker	Trace	Type	X Axis	Amplitude
1R	(1)	Time	2.66 ms	-27.86 dBm
1Δ	(1)	Time	2.96 ms	2.79 dB



7.14 SPURIOUS EMISSIONS

7.14.1 CONDUCTED MEASUREMENT

LIMIT

(Same as Section 7.6.1 in this test report)

TEST PROCEDURE

(Same as Section 7.6.1 in this test report)

TEST RESULTS

No non-compliance noted.



Test Plot

(Bluetooth / CH Low)

Agilent 21:05:41 Jul 10, 2006

T

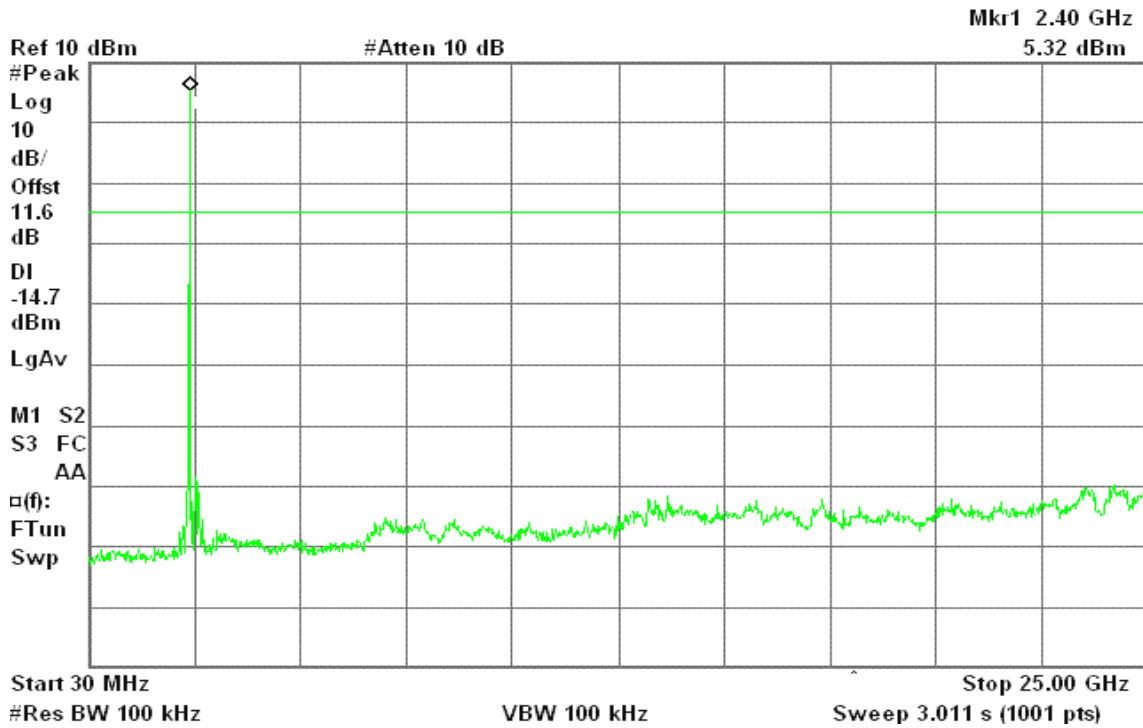

(Bluetooth / CH Mid)

Agilent 21:04:25 Jul 10, 2006

T

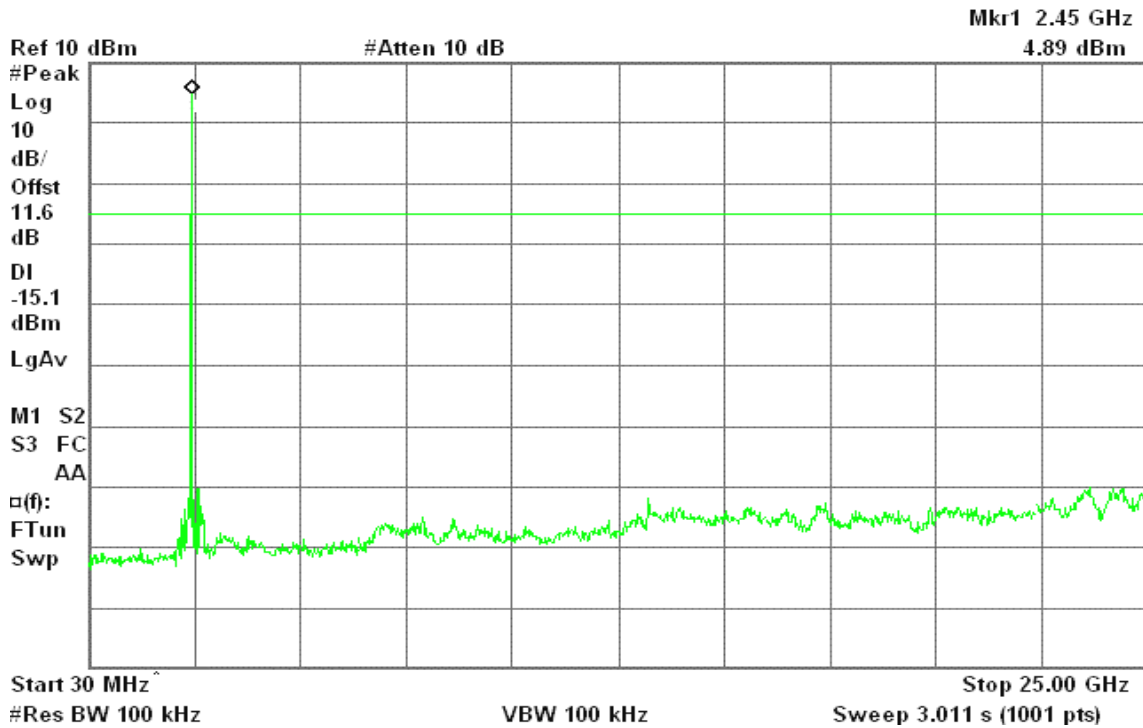



(Bluetooth / CH High)

Agilent 21:03:40 Jul 10, 2006

T

Mkr1 2.48 GHz
2.16 dBm

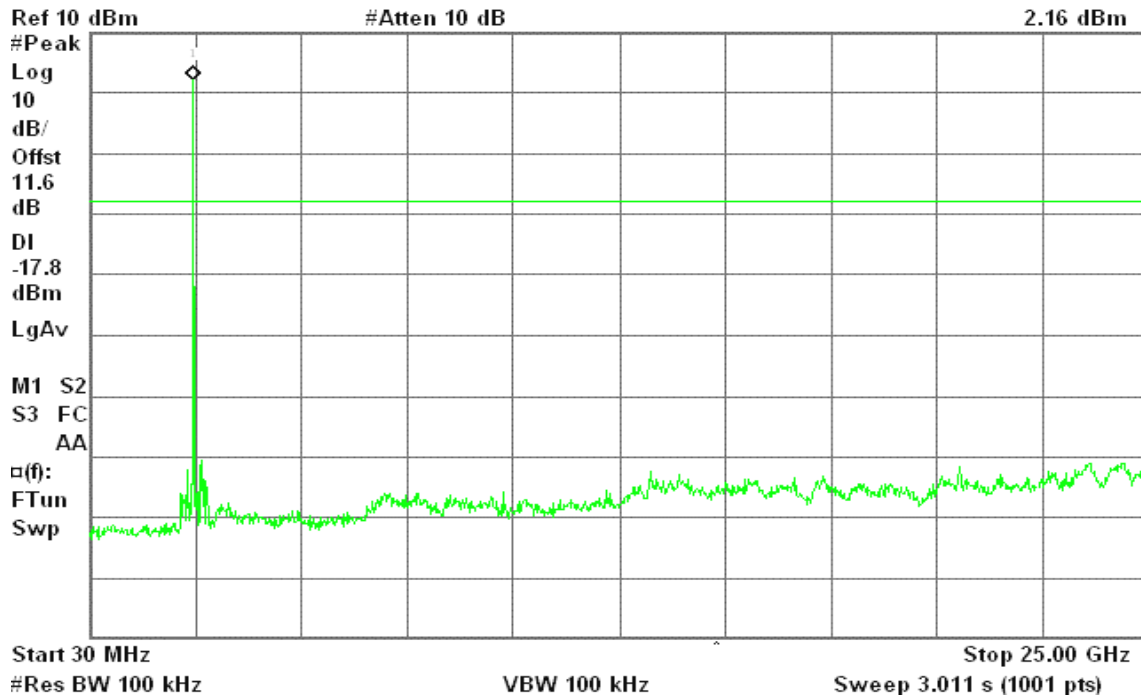



7.14.2 RADIATED EMISSIONS

LIMIT

(Same as Section 7.6.2 in this test report)

TEST PROCEDURE

(Same as Section 7.6.2 in this test report)



TEST RESULTS

BLUETOOTH OPERATION

Below 1 GHz

Operation Mode: Normal Link

Test Date: July 10, 2006

Temperature: 23°C

Tested by: Skyman Tsai

Humidity: 46 % RH

Polarity: Ver. / Hor.

Frequency (MHz)	Ant.Pol. (H/V)	Reading (dBuV)	Correction Factor (dB/m)	Result (dBuV/m)	Limit (dBuV/m)	Margin (dB)	Remark
34.85	V	35.30	-8.38	26.91	40.00	-13.09	Peak
59.10	V	39.21	-19.13	20.08	40.00	-19.92	Peak
275.73	V	32.28	-11.89	20.39	46.00	-25.61	Peak
324.23	V	34.58	-11.03	23.55	46.00	-22.45	Peak
354.95	V	32.44	-10.27	22.17	46.00	-23.83	Peak
398.60	V	31.12	-9.27	21.85	46.00	-24.15	Peak
172.27	H	31.64	-14.46	17.18	43.50	-26.32	Peak
296.75	H	38.77	-11.72	27.04	46.00	-18.96	Peak
443.87	H	32.54	-8.51	24.03	46.00	-21.97	Peak
532.78	H	30.11	-6.34	23.77	46.00	-22.23	Peak
599.07	H	32.16	-5.41	26.74	46.00	-19.26	Peak
799.53	H	29.77	-2.23	27.54	46.00	-18.46	Peak

Remark:

1. *Measuring frequencies from 30 MHz to the 1GHz.*
2. *Radiated emissions measured in frequency range from 30 MHz to 1000MHz were made with an instrument using peak/quasi-peak detector mode.*
3. *Quasi-peak test would be performed if the peak result were greater than the quasi-peak limit or as required by the applicant.*
4. *Measurements above show only up to 6 maximum emissions noted, or would be lesser; with " N/A " remark, if no specific emissions from the EUT are recorded (ie: margin>20dB from the applicable limit) and considered that's already beyond the background noise floor.*
5. *Margin (dB) = Remark result (dBuV/m) – Quasi-peak limit (dBuV/m).*



Above 1 GHz

Operation Mode: Bluetooth / TX / CH Low

Test Date: July 8, 2006

Temperature: 23°C

Tested by: Skyman Tsai

Humidity: 51 % RH

Polarity: Ver. / Hor.

Frequency (MHz)	Ant. Pol. (H/V)	Reading (Peak) (dBuV)	Reading (Average) (dBuV)	Correction Factor (dB/m)	Result (Peak) (dBuV/m)	Result (Average) (dBuV/m)	Limit (Peak) (dBuV/m)	Limit (Average) (dBuV/m)	Margin (dB)	Remark
1863.33	V	40.12	---	10.55	50.67	---	74.00	54.00	-3.33	Peak
N/A										
1730.00	H	39.53	---	10.66	50.19	---	74.00	54.00	-3.81	Peak
N/A										

Remark:

1. Measuring frequencies from 1 GHz to the 10th harmonic of highest fundamental frequency.
2. Radiated emissions measured in frequency above 1000MHz were made with an instrument using peak/average detector mode.
3. Average test would be performed if the peak result were greater than the average limit or as required by the applicant.
4. Data of measurement within this frequency range shown " --- " in the table above means the reading of emissions are attenuated more than 20dB below the permissible limits or the field strength is too small to be measured.
5. Measurements above show only up to 6 maximum emissions noted, or would be lesser, with " N/A " remark, if no specific emissions from the EUT are recorded (ie: margin>20dB from the applicable limit) and considered that's already beyond the background noise floor.
6. Margin (dB) = Remark result (dBuV/m) – Average limit (dBuV/m).



Operation Mode: Bluetooth / TX / CH Mid

Test Date: July 8, 2006

Temperature: 25°C

Tested by: Skyman Tsai

Humidity: 55 % RH

Polarity: Ver. / Hor.

Frequency (MHz)	Ant. Pol. (H/V)	Reading (Peak) (dBuV)	Reading (Average) (dBuV)	Correction Factor (dB/m)	Result (Peak) (dBuV/m)	Result (Average) (dBuV/m)	Limit (Peak) (dBuV/m)	Limit (Average) (dBuV/m)	Margin (dB)	Remark
1716.67	V	40.78	---	10.67	51.45	---	74.00	54.00	-2.55	Peak
N/A										
1823.33	H	39.03	---	10.58	49.61	---	74.00	54.00	-4.39	Peak
N/A										

Remark:

1. Measuring frequencies from 1 GHz to the 10th harmonic of highest fundamental frequency.
2. Radiated emissions measured in frequency above 1000MHz were made with an instrument using peak/average detector mode.
3. Average test would be performed if the peak result were greater than the average limit or as required by the applicant.
4. Data of measurement within this frequency range shown " --- " in the table above means the reading of emissions are attenuated more than 20dB below the permissible limits or the field strength is too small to be measured.
5. Measurements above show only up to 6 maximum emissions noted, or would be lesser; with " N/A " remark, if no specific emissions from the EUT are recorded (ie: margin > 20dB from the applicable limit) and considered that's already beyond the background noise floor.
6. Margin (dB) = Remark result (dBuV/m) – Average limit (dBuV/m).



Operation Mode: Bluetooth / TX / CH High

Test Date: July 8, 2006

Temperature: 25°C

Tested by: Skyman Tsai

Humidity: 55 % RH

Polarity: Ver. / Hor.

Frequency (MHz)	Ant. Pol. (H/V)	Reading (Peak) (dBuV)	Reading (Average) (dBuV)	Correction Factor (dB/m)	Result (Peak) (dBuV/m)	Result (Average) (dBuV/m)	Limit (Peak) (dBuV/m)	Limit (Average) (dBuV/m)	Margin (dB)	Remark
2213.33	V	40.98	---	9.40	50.38	---	74.00	54.00	-3.62	Peak
N/A										
1953.33	H	40.03	---	10.48	50.51	---	74.00	54.00	-3.49	Peak
N/A										

Remark:

1. Measuring frequencies from 1 GHz to the 10th harmonic of highest fundamental frequency.
2. Radiated emissions measured in frequency above 1000MHz were made with an instrument using peak/average detector mode.
3. Average test would be performed if the peak result were greater than the average limit or as required by the applicant.
4. Data of measurement within this frequency range shown " --- " in the table above means the reading of emissions are attenuated more than 20dB below the permissible limits or the field strength is too small to be measured.
5. Measurements above show only up to 6 maximum emissions noted, or would be lesser; with " N/A " remark, if no specific emissions from the EUT are recorded (ie: margin > 20dB from the applicable limit) and considered that's already beyond the background noise floor.
6. Margin (dB) = Remark result (dBuV/m) – Average limit (dBuV/m)



7.15 POWER LINE CONDUCTED EMISSIONS

LIMIT

According to §15.207(a), except as shown in paragraphs (b) and (c) of this section, for an intentional radiator that is designed to be connected to the public utility (AC) power line, the radio frequency voltage that is conducted back onto the AC power line on any frequency or frequencies within the band 150 kHz to 30 MHz shall not exceed the limits in the following table, as measured using a 50 μH/50 ohms line impedance stabilization network (LISN). Compliance with the provisions of this paragraph shall be based on the measurement of the radio frequency voltage between each power line and ground at the power terminal. The lower limit applies at the boundary between the frequency ranges.

Frequency Range (MHz)	Limits (dBμV)	
	Quasi-peak	Average
0.15 to 0.50	66 to 56*	56 to 46*
0.50 to 5	56	46
5 to 30	60	50

* Decreases with the logarithm of the frequency.

Test Configuration

See test photographs attached in Appendix II for the actual connections between EUT and support equipment.

TEST PROCEDURE

1. The EUT was placed on a table, which is 0.8m above ground plane.
2. Maximum procedure was performed on the six highest emissions to ensure EUT compliance.
3. Repeat above procedures until all frequency measured were complete.



TEST RESULTS

The initial step in collecting conducted data is a spectrum analyzer peak scan of the measurement range. Significant peaks are then marked as shown on the following data page, and these signals are then quasi-peaked.

Operation Mode: Normal Link **Test Date:** July 12, 2006
Temperature: 25°C **Tested by:** Rex Lai
Humidity: 55% RH

Freq. (MHz)	QP Reading (dBuV)	AV Reading (dBuV)	Corr. factor (dB)	QP Result (dBuV)	AV Result (dBuV)	QP Limit (dBuV)	AV Limit (dBuV)	QP Margin (dB)	AV Margin (dB)	Note
0.177	34.580	26.000	0.146	34.726	26.146	64.625	54.625	-29.899	-28.479	L1
0.201	45.980	33.100	0.100	46.080	33.200	63.569	53.569	-17.489	-20.369	L1
0.266	35.570	23.800	0.100	35.670	23.900	61.242	51.242	-25.572	-27.342	L1
0.400	26.050	18.740	0.100	26.150	18.840	57.853	47.853	-31.703	-29.013	L1
12.277	33.780	29.160	0.746	34.526	29.906	60.000	50.000	-25.474	-20.094	L1
24.555	40.840	40.150	1.200	42.040	41.350	60.000	50.000	-17.960	-8.650	L1
0.177	34.940	25.370	0.146	35.086	25.516	64.625	54.625	-29.539	-29.109	L2
0.200	45.520	29.660	0.100	45.620	29.760	63.611	53.611	-17.991	-23.851	L2
0.262	35.220	21.730	0.100	35.320	21.830	61.368	51.368	-26.048	-29.538	L2
4.764	21.650	12.700	0.176	21.826	12.876	56.000	46.000	-34.174	-33.124	L2
12.279	32.570	28.850	0.746	33.316	29.596	60.000	50.000	-26.684	-20.404	L2
24.555	40.900	40.260	1.200	42.100	41.460	60.000	50.000	-17.900	-8.540	L2

Remark:

1. The measuring frequencies range between 0.15 MHz and 30 MHz.
2. The emissions measured in the frequency range between 0.15 MHz and 30MHz were made with an instrument using Quasi-peak detector and Average detector.
3. The IF bandwidth of SPA between 0.15MHz and 30MHz was 10kHz. The IF bandwidth of Test Receiver between 0.15MHz and 30MHz was 9kHz.
4. L1 = Line One (Live Line) / L2 = Line Two (Neutral Line)



Test Data Plots

Conducted emissions (Line 1)

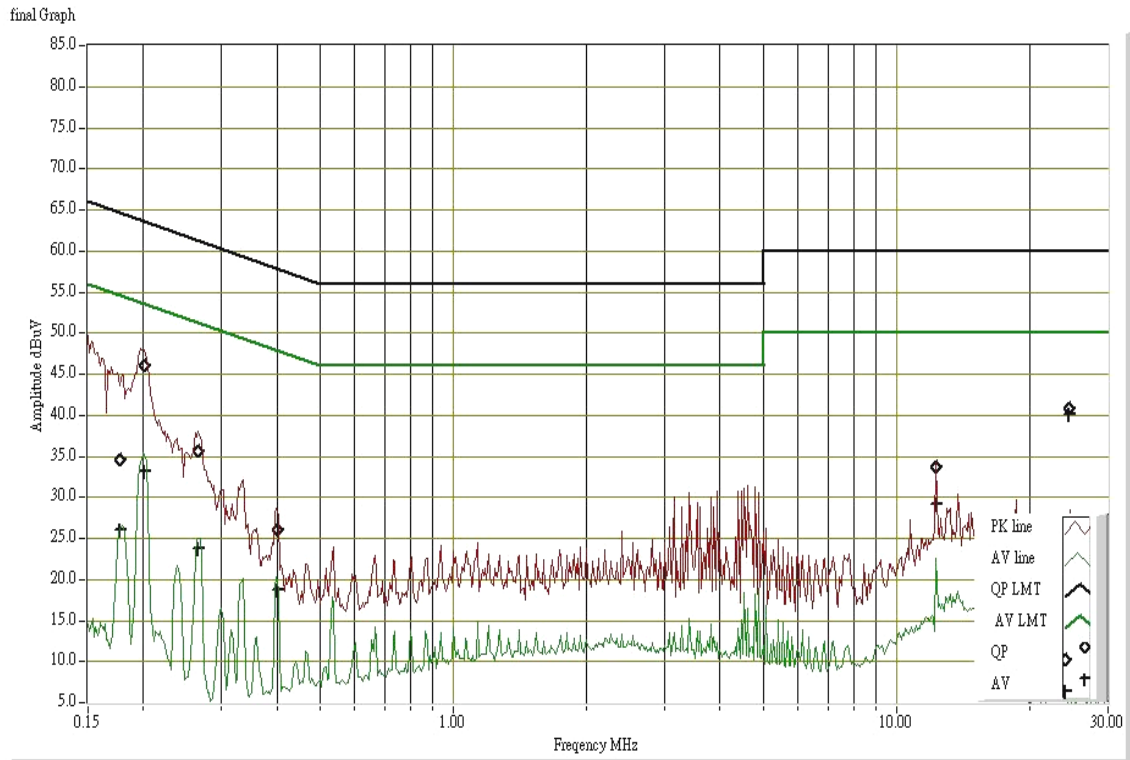

Conducted emissions (Line 2)

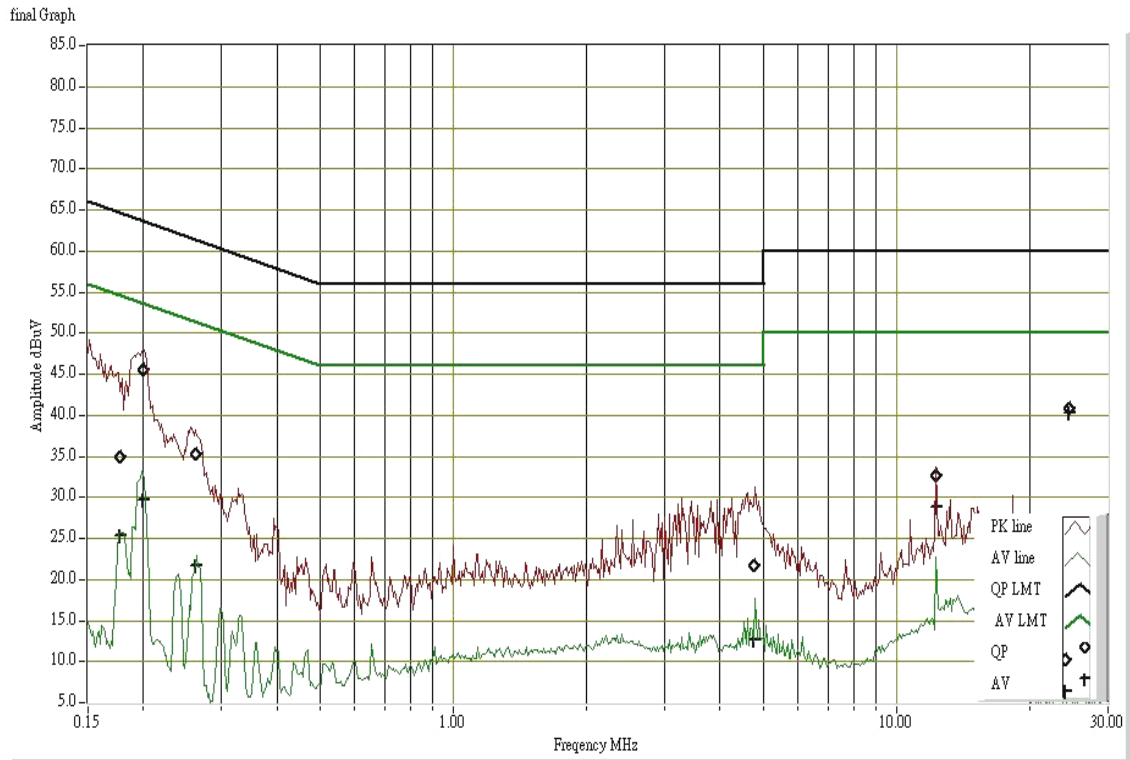



APPENDIX I

RADIO FREQUENCY EXPOSURE

LIMIT

According to §15.247(i), systems operating under the provisions of this section shall be operated in a manner that ensures that the public is not exposed to radio frequency energy levels in excess of the Commission's guidelines. See § 1.1307(b)(1) of this chapter

EUT Specification

EUT	Tablet PC
Frequency band (Operating)	<input type="checkbox"/> WLAN: 2.412GHz ~ 2.462GHz <input type="checkbox"/> WLAN: 5.18GHz ~ 5.32GHz / 5.50GHz ~ 5.70GHz <input checked="" type="checkbox"/> WLAN: 5.745GHz ~ 5.825GHz
Device category	<input checked="" type="checkbox"/> Portable (<20cm separation) <input type="checkbox"/> Mobile (>20cm separation)
Exposure classification	<input type="checkbox"/> Occupational/Controlled exposure (S = 5mW/cm2) <input checked="" type="checkbox"/> General Population/Uncontrolled exposure (S=1mW/cm2)
Antenna diversity	<input type="checkbox"/> Single antenna <input checked="" type="checkbox"/> Multiple antennas <input type="checkbox"/> Tx diversity <input type="checkbox"/> Rx diversity <input checked="" type="checkbox"/> Tx/Rx diversity
Max. output power	IEEE 802.11a: 14.61dBm (28.91mW)
Antenna gain (Max)	IEEE 802.11a: -1.54dBi (Numeric gain: 0.70)
Evaluation applied	<input type="checkbox"/> MPE Evaluation <input checked="" type="checkbox"/> SAR Evaluation* <input type="checkbox"/> N/A

Remark:

1. The maximum output power is 14.61dBm (28.91mW) at 5825MHz (with 0.70 numeric antenna gain.)
2. DTS device is not subject to routine RF evaluation; MPE estimate is used to justify the compliance.
3. For mobile or fixed location transmitters, no SAR consideration applied. The minimum separation generally be used is at least 20 cm, even if the calculations indicate that the MPE distance would be lesser.

TEST RESULTS

No non-compliance noted.

Remark: Please refer to the separated SAR report.

MPE EVALUATION

Not applicable.

**EUT Specification**

EUT	Tablet PC
Frequency band (Operating)	<input checked="" type="checkbox"/> WLAN: 2.412GHz ~ 2.462GHz <input type="checkbox"/> WLAN: 5.18GHz ~ 5.32GHz / 5.50GHz ~ 5.70GHz <input type="checkbox"/> WLAN: 5.745GHz ~ 5.825GHz
Device category	<input checked="" type="checkbox"/> Portable (<20cm separation) <input type="checkbox"/> Mobile (>20cm separation) <input type="checkbox"/> Others
Exposure classification	<input type="checkbox"/> Occupational/Controlled exposure (S = 5mW/cm2) <input checked="" type="checkbox"/> General Population/Uncontrolled exposure (S=1mW/cm2)
Antenna diversity	<input type="checkbox"/> Single antenna <input checked="" type="checkbox"/> Multiple antennas <input type="checkbox"/> Tx diversity <input type="checkbox"/> Rx diversity <input checked="" type="checkbox"/> Tx/Rx diversity
Max. output power	IEEE 802.11b: 16.97dBm (49.77mW) IEEE 802.11g: 14.82 dBm (30.34mW)
Antenna gain (Max)	IEEE 802.11b/g: -0.4 dBi (Numeric gain: 0.912)
Evaluation applied	<input type="checkbox"/> MPE Evaluation <input checked="" type="checkbox"/> SAR Evaluation* <input type="checkbox"/> N/A

Remark:

1. The maximum output power is 16.97dBm (49.77mW) at 2437MHz (with 0.912 numeric antenna gain.)
2. DTS device is not subject to routine RF evaluation; MPE estimate is used to justify the compliance.
3. For mobile or fixed location transmitters, no SAR consideration applied. The minimum separation generally be used is at least 20 cm, even if the calculations indicate that the MPE distance would be lesser.

TEST RESULTS

No non-compliance noted.

Remark: Please refer to the separated SAR report.

MPE EVALUATION

Not applicable.

**EUT Specification**

EUT	Tablet PC
Frequency band (Operating)	<input type="checkbox"/> WLAN: 2.412GHz ~ 2.462GHz <input type="checkbox"/> WLAN: 5.18GHz ~ 5.32GHz / 5.50GHz ~ 5.70GHz <input type="checkbox"/> WLAN: 5.745GHz ~ 5.825GHz <input checked="" type="checkbox"/> Others: <u>Bluetooth: 2.402GHz ~ 2.480GHz</u>
Device category	<input checked="" type="checkbox"/> Portable (<20cm separation) <input type="checkbox"/> Mobile (>20cm separation) <input type="checkbox"/> Others _____
Exposure classification	<input type="checkbox"/> Occupational/Controlled exposure ($S = 5mW/cm^2$) <input checked="" type="checkbox"/> General Population/Uncontrolled exposure ($S=1mW/cm^2$)
Antenna diversity	<input type="checkbox"/> Single antenna <input checked="" type="checkbox"/> Multiple antennas <input type="checkbox"/> Tx diversity <input type="checkbox"/> Rx diversity <input checked="" type="checkbox"/> Tx/Rx diversity
Max. output power	Bluetooth: 2.4dBm (1.74mW)
Antenna gain (Max)	Bluetooth: -0.4 dBi (Numeric gain: 0.912)
Evaluation applied	<input type="checkbox"/> MPE Evaluation <input type="checkbox"/> SAR Evaluation <input checked="" type="checkbox"/> N/A*
Remark:	
1. The maximum output power is <u>2.4 dBm (1.74mW) at 2402MHz</u> (with <u>0.912 numeric antenna gain.</u>) 2. DTS device is not subject to routine RF evaluation; MPE estimate is used to justify the compliance. 3. For mobile or fixed location transmitters, no SAR consideration applied. The maximum power density is $1.0 mW/cm^2$ even if the calculation indicates that the power density would be larger.	

TEST RESULTS

No non-compliance noted.

(SAR evaluation is not required for the PORTABLE device while its maximum output power is lower than the general population low threshold: $60/f_{(GHz)}=60/2.441=24.58mW$)

MPE EVALUATION

Not applicable