



TEST REPORT

EUT Description	WLAN and BT, 2x2 PCIe M.2 2230 adapter card
Brand Name	Intel® Wi-Fi 6E AX211
Model Name	AX211NGW
FCC/IC ID	FCCID: PD9AX211NG/ IC ID: 1000M-AX211NG
Date of Test Start/End	2020-12-01 /2020-12-21
Features	802.11ax, Dual Band, 2x2 Wi-Fi + Bluetooth® 5.2 (see section 5)

Applicant	Intel Mobile Communications
Address	100 Center Point Circle, Suite 200 Columbia, South Carolina 29210 USA
Contact Person	Steven Hackett
Telephone/Fax/ Email	steven.c.hackett@intel.com

Reference Standards	FCC CFR Title 47 Part 15 C RSS-247 issue 2, RSS-Gen issue 5 A1 (see section 1)
---------------------	--

Test Report identification	200611-01.TR04
Revision Control	Rev. 00 This test report revision replaces any previous test report revision (see section 8)

The test results relate only to the samples tested.
 This report shall not be reproduced, except in full, without the written approval of the laboratory.
 Reference to accreditation shall be used only by full reproduction of test report.

Issued by _____ Reviewed by _____

Zayd OUACHICHA
 (Test Engineer Lead)

Cheiel IN
 (Technical Manager)

Intel Corporation S.A.S – WRF Lab
425 rue de Goa – Le Cargo B6 - 06600, Antibes, France
Tel. +33493001400 / Fax +33493001401

Table of Contents

1. Standards, reference documents and applicable test methods	3
2. General conditions, competences and guarantees	3
3. Environmental Conditions	3
4. Test samples	4
5. EUT Features	5
6. Remarks and comments	5
7. Test Verdicts summary	6
7.1. 802.11 B/G/N/AX 2.4GHZ	6
7.2. BLE	6
8. Document Revision History	6
Annex A. Test & System Description	7
A.1 MEASUREMENT SYSTEM.....	7
A.2 TEST EQUIPMENT LIST	10
A.3 MEASUREMENT UNCERTAINTY EVALUATION	12
Annex B. Test Results DTS	13
B.1 TEST CONDITIONS.....	13
B.2 TEST RESULTS TABLES	14
B.2.1 6dB & 99% Bandwidth.....	14
B.2.2 Maximum Output Power and antenna gain.....	17
B.2.3 Power Spectral Density	21
B.2.4 Out-of-band emission (conducted)	25
B.2.5 Radiated spurious emission.....	26
B.2.6 Test Results Screenshot.....	38
B.2.7 Out of band emissions - band-edge Low ans High (conducted)	38
Annex C. Test Results BLE	66
C.1.1 6dB & 99% Bandwidth.....	66
C.1.2 Maximum Output Power and antenna gain.....	70
C.1.3 Power Spectral Density	75
C.1.4 Out-of-band emission (Conducted).....	76
C.1.5 Radiated spurious emission.....	79
Annex D. Photographs	82
D.1 TEST SETUP	82
D.2 TEST SAMPLE	84

1. Standards, reference documents and applicable test methods

FCC	<ol style="list-style-type: none"> 1. FCC Title 47 CFR part 15 - Subpart C – §15.247 Operation within the bands 902-928 MHz, 2400-2483.5 MHz, and 5725-5850 MHz. 2019-10-01 Edition 2. FCC Title 47 CFR part 15 - Subpart C – §15.209 Radiated emission limits; general requirements. 2019-10-01 Edition 3. FCC OET KDB 558074 D01 v05r02 - Guidance for compliance measurements on digital transmission system, frequency hopping spread spectrum system, and hybrid system devices operating under section 15.247 of the FCC rules. 4. FCC OET KDB 662911 D01 v02r01 - Emissions Testing of Transmitters with Multiple Outputs in the Same Band. 5. ANSI C63.10-2013 - American National Standard of Procedures for Compliance Testing of Unlicensed Wireless Devices
ISED	<ol style="list-style-type: none"> 1. RSS-247 Issue 2 - Digital Transmission Systems (DTSs), Frequency Hopping Systems (FHSs) and License-Exempt Local Area Network (LE-LAN) Devices. 2. RSS-Gen Issue 5 A1- General Requirements for Compliance of Radio Apparatus. 3. FCC OET KDB 558074 D01 v05r02 - Guidance for compliance measurements on digital transmission system, frequency hopping spread spectrum system, and hybrid system devices operating under section 15.247 of the FCC rules. 4. FCC OET KDB 662911 D01 v02r01 - Emissions Testing of Transmitters with Multiple Outputs in the Same Band. 5. ANSI C63.10-2013 - American National Standard of Procedures for Compliance Testing of Unlicensed Wireless Devices

2. General conditions, competences and guarantees

- ✓ Tests performed under FCC standards identified in section 1 are covered by A2LA accreditation.
- ✓ Tests performed under ISED standards identified in section 1 are covered by Cofrac accreditation.
- ✓ Intel Corporation SAS Wireless RF Lab (Intel WRF Lab) is an ISO/IEC 17025:2017 laboratory accredited by the American Association for Laboratory Accreditation (A2LA) with the certificate number 3478.01.
- ✓ Intel Corporation SAS Wireless RF Lab (Intel WRF Lab) is an Accredited Test Firm recognized by the FCC, with Designation Number FR0011.
- ✓ Intel Corporation SAS Wireless RF Lab (Intel WRF Lab) is an ISO/IEC 17025:2017 testing laboratory accredited by the French Committee for Accreditation (Cofrac) with the certificate number 1-6736.
- ✓ Intel Corporation SAS Wireless RF Lab (Intel WRF Lab) is a Registered Test Site listed by ISED, with ISED #1000Y.
- ✓ Intel WRF Lab declines any responsibility with respect to the identified information provided by the customer and that may affect the validity of results.
- ✓ Intel WRF Lab only provides testing services and is committed to providing reliable, unbiased test results and interpretations.
- ✓ Intel WRF Lab is liable to the client for the maintenance of the confidentiality of all information related to the item under test and the results of the test.
- ✓ Intel WRF Lab has developed calibration and proficiency programs for its measurement equipment to ensure correlated and reliable results to its customers.
- ✓ This report is only referred to the item that has undergone the test.
- ✓ This report does not imply an approval of the product by the Certification Bodies or competent Authorities.
- ✓ Complete or partial reproduction of the report cannot be made without written permission of Intel WRF Lab.

3. Environmental Conditions

- ✓ At the site where the measurements were performed the following limits were not exceeded during the tests:

Temperature	21°C ± 3.1°C
Humidity	44.7% ± 8.7%

4. Test samples

Sample	Control #	Description	Model	Serial #	Date of receipt	Note
#1	200611-01.S01	WiFi 6E Module	AX211NGW	WFM: D8F889597A5E	2020-11-23	RF Conducted
	170000-01.S13	Laptop	Latitude E5470	FT6LMC2	2017-05-30	
	200611-01.S11	Extender	PCB00651_01	-	2020-11-30	
#2	200611-01.S17	WiFi 6E Module	AX211NGW	WFM:D8F883596CD0	2020-12-01	Used for 18GHz-26.5GHz Radiated Spurious Emissions tests
	200102-01.S03	Extender	ADEXELEC	-	2020-01-02	
	200611-01.S06	Adaptor	PowerBy SNJ A4	-	2020-11-30	
	200602-03.S06	Absorber	MCS0	-	2020-07-03	
	170801-01.S10	Laptop	Latitude E7470	7KNOXF2	2017-09-08	
	200611-03.S28	Main Antenna	SkyCross	-	2020-07-01	
	200611-03.S29	Aux Antenna	SkyCross	-	2020-07-01	
#3	200611-01.S04	WiFi 6E Module	AX211NGW	WFM:D8F8835981DE	2020-11-23	Used for 30MHz-18GHz Radiated Spurious Emissions tests
	200611-03.S26	Extender	ADEXELEC	-	2020-07-01	
	200611-01.S07	Adaptor	PowerBy SNJ A4	-	2020-11-30	
	200602-03.S06	Absorber	MCS0	-	2020-07-03	
	170000-01.S01	Laptop	Latitude E5470	DBPLMC2	2017-03-28	
	200928-03.S08	Main Antenna	SkyCross	-	2020-09-01	
	200928-03.S09	Aux Antenna	SkyCross	-	2020-09-01	

5. EUT Features

The herein information is provided by the customer

Brand Name	Intel® Wi-Fi 6E AX211		
Model Name	AX211NGW		
Software Version	DRTU Version: 11195_99_2100_51G		
Driver Version	99.0.58.3		
Prototype / Production	Production		
Supported Radios	802.11b/g/n/ax	2.4GHz (2400.0 – 2483.5 MHz)	
	802.11a/n/ac/ax	5.2GHz (5150.0 – 5350.0 MHz) 5.6GHz (5470.0 – 5725.0 MHz) 5.8GHz (5725.0 – 5850.0 MHz)	
Antenna Information	Bluetooth 5.2	2.4GHz (2400.0 – 2483.5 MHz)	
	Transmitter	Main (chain A)	Aux (chain B)
	Manufacturer	SkyCross	Skycross
	Antenna type	PIFA antenna	PIFA antenna
	Part number	N/A	N/A
Declared antenna gain (dBi)	+3.24	+3.24	
Document	Filename	Date of receipt	
	Intel_Ref_Antenna data_HMC-M2 Ant_Spec_Universe_SkyCross Antenna	2013-01-28	

6. Remarks and comments

1. No deviations were made from the test methods listed in section 1 of this report

7. Test Verdicts summary

The statement of conformity to applicable standards in the table below are based on the measured values, without taking into account the measurement uncertainties.

7.1. 802.11 b/g/n/ax 2.4GHz

FCC part	RSS part	Test name	Verdict
15.247 (a) (2)	RSS-247 Clause 5.2 (a)	6dB Bandwidth	P
15.247 (b) (3)	RSS-247 Clause 5.4 (d)	Maximum output power and E.I.R.P	P
15.247 (e)	RSS-247 Clause 5.2 (b)	Power spectral density	P
15.247 (d) 15.209	RSS-247 Clause 5.5 RSS-Gen A1 Clause 8.9	Out-of-band Emissions (conducted)	P
15.247 (d) 15.209	RSS-247 Clause 5.5 RSS-Gen A1 Clause 8.9	Spurious Emissions (radiated)	P

7.2. BLE

FCC part	RSS part	Test name	Verdict
15.247 (a) (2)	RSS-247 Clause 5.2 (a)	6dB Bandwidth	P
15.247 (b) (3)	RSS-247 Clause 5.4 (d)	Maximum output power and E.I.R.P.	P
15.247 (e)	RSS-247 Clause 5.2 (b)	Power spectral density	P
15.247 (d) 15.209	RSS-247 Clause 5.5 RSS-Gen A1 Clause 8.9	Out-of-band Emissions (conducted)	P
15.247 (d) 15.209	RSS-247 Clause 5.5 RSS-Gen A1 Clause 8.9	Spurious Emissions (radiated)	P

P: Pass
F: Fail
NM: Not Measured
NA: Not Applicable

8. Document Revision History

Revision #	Modified by	Revision Details
Rev. 00	C.Requin	First Issue

Annex A. Test & System Description

A.1 Measurement System

Measurements were performed using the following setups, made in accordance to the general provisions of FCC OET KDB 558074 D01 DTS Meas Guidance.

The DUT was installed in a test fixture and this test fixture is connected to a laptop computer and AC/DC power adapter. The laptop computer was used to configure the EUT to continuously transmit at a specified output power using all different modes and modulation schemes, using the Intel proprietary tool DRTU.

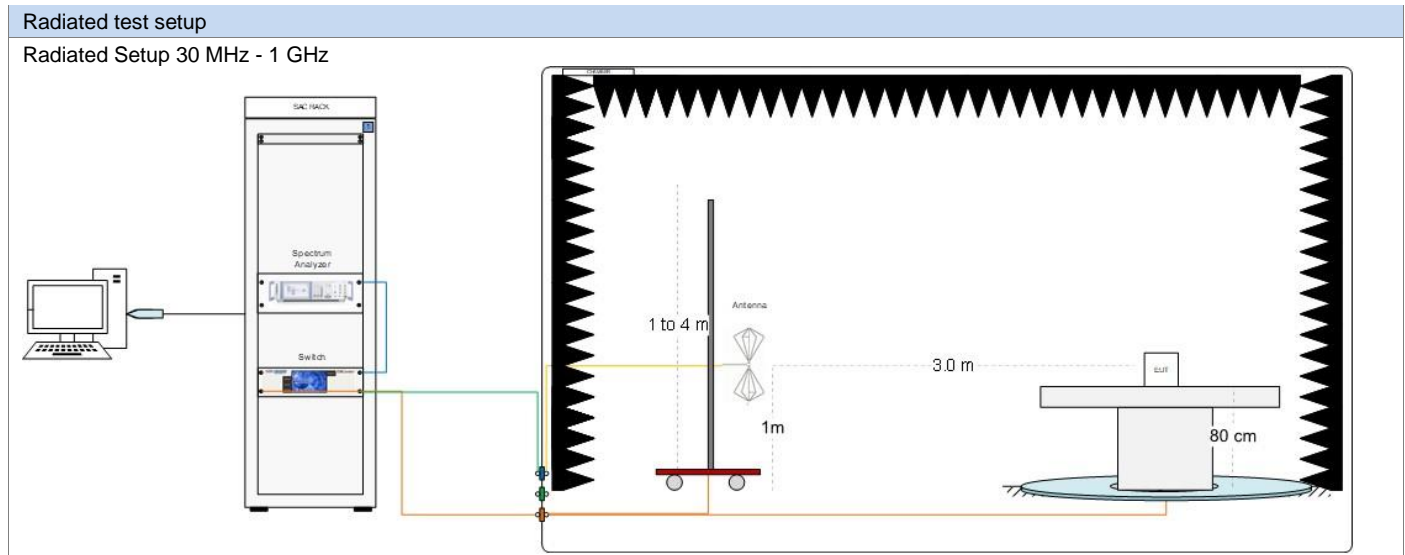
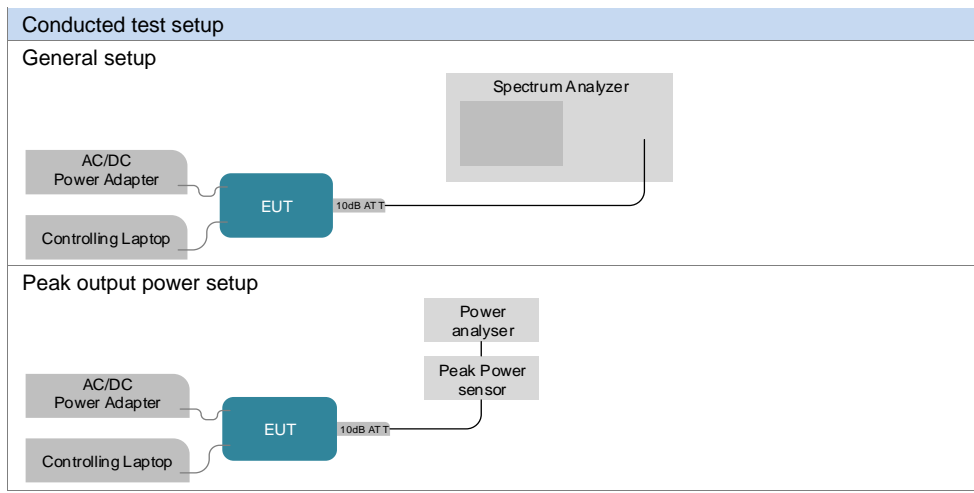

Radiated Setup 1 GHz – 6.4 GHz

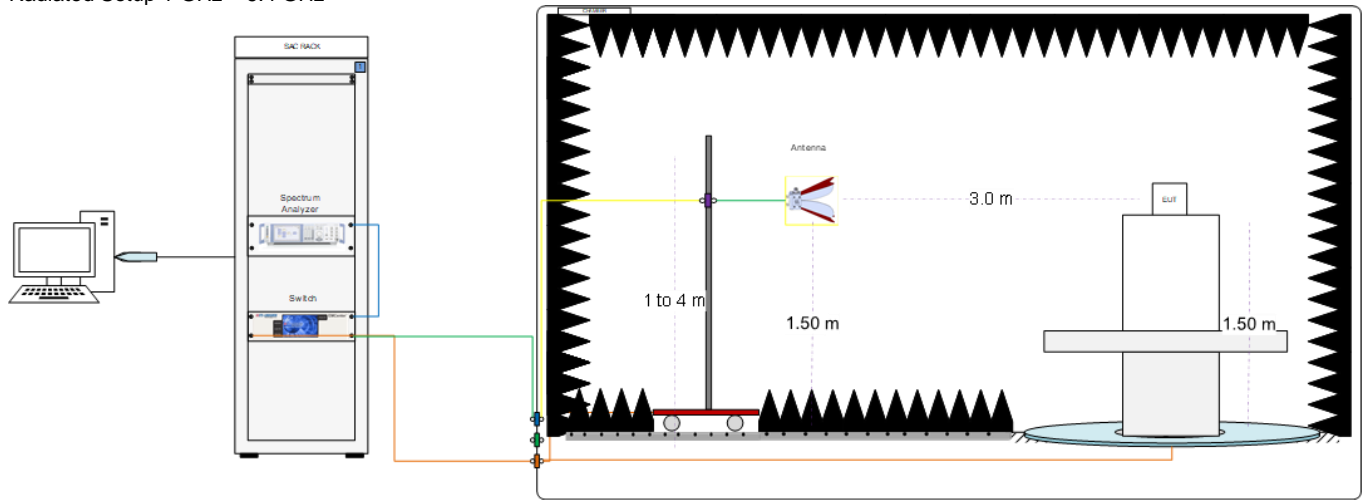

Radiated Setup 6.4 GHz - 18 GHz

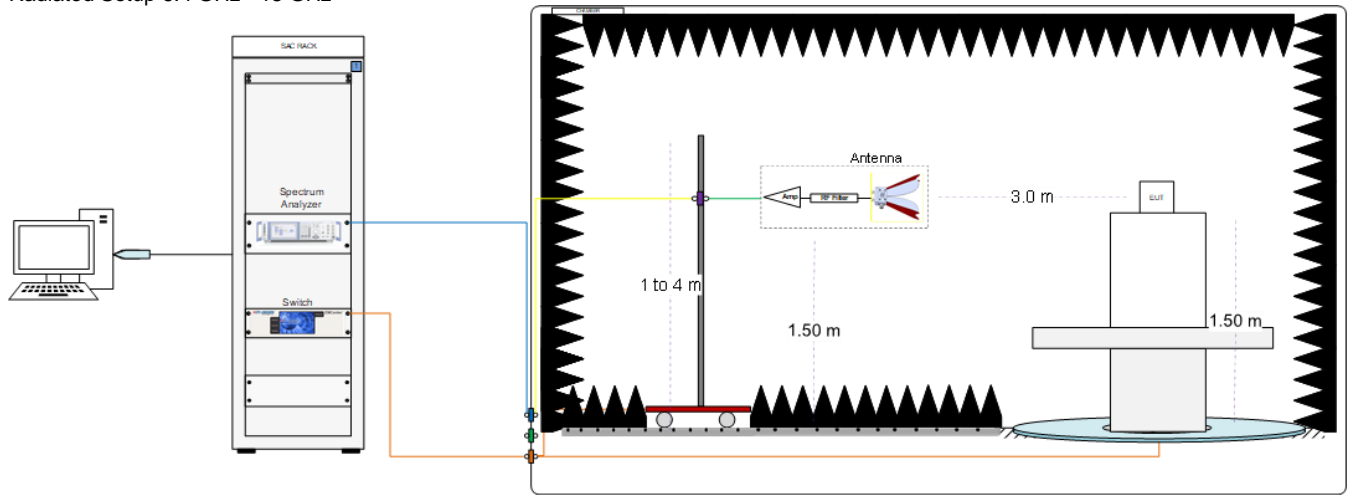

Radiated Setup 18 GHz – 26.5 GHz

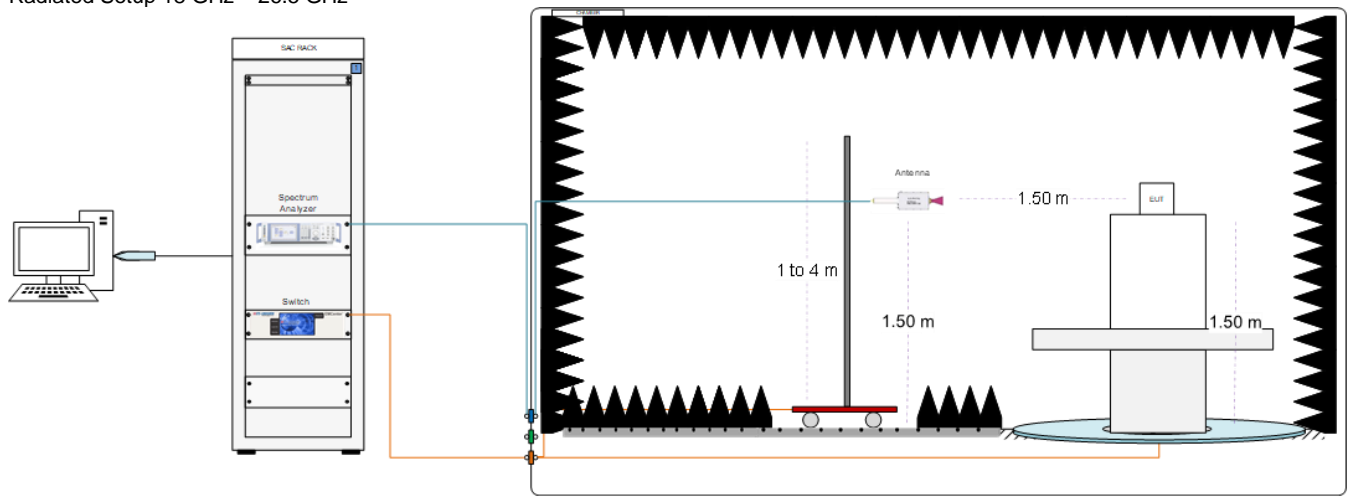

Sample Calculation

The spurious received voltage $V(\text{dB}\mu\text{V})$ in the spectrum Analyzer is converted to Electric field strength using the transducer factor F corresponding to the Rx path Loss:

$$\mathbf{F \text{ (dB/m)} = Rx \text{ Antenna Factor (dB/m) + Cable losses (dB) - Amplifiers Gain (dBi)}$$
$$\mathbf{E \text{ (dB}\mu\text{V)} = V(\text{dB}\mu\text{V}) + F \text{ (dB/m)}$$

For field strength measurements made at other than the distance at which the applicable limit is specified, the field strength of the emission at the distance specified by the limit is deduced as follows:

$$\mathbf{E_{SpecLimit} = E_{Meas} + 20 \cdot \log(D_{Meas}/D_{SpecLimit})}$$

where

$E_{SpecLimit}$ is the field strength of the emission at the distance specified by the limit, in $\text{dB}\mu\text{V}/\text{m}$

E_{Meas} is the field strength of the emission at the measurement distance, in $\text{dB}\mu\text{V}/\text{m}$

D_{Meas} is the measurement distance, in m

$D_{SpecLimit}$ is the distance specified by the limit, in m

A.2 Test Equipment List

Conducted setup

ID#	Device	Type/Model	Serial #	Manufacturer	Cal. Date	Cal. Due Date
0315	Spectrum Analyzer	FSV30	103307	Rohde & Schwarz	2020-04-06	2022-04-06
0884	Peak Power Meter	MA24406A	11138	ANRITSU	2019-11-12	2021-11-12
0378	RF Cable	Cable Utilflex 40GHz	MFR64639 23720-001	MICRO-COAX	2020-08-26	2021-02-26
1118	10dB Attenuator + MH4	N/A	N/A	N/A	N/A	N/A
0583	Temp & Humidity Logger	RA12E-TH1-RAS	RA12-B9D6E	AVITECH	2019-09-06	2021-09-06
1002	Measurement SW v1.5.4.2	Octopi	N/A	Step AT	N/A	N/A

Radiated Setup #1

ID#	Device	Type/Model	Serial #	Manufacturer	Cal. Date	Cal. Due Date
0135	Anechoic Chamber	FACT3	5720	ETS-Lindgren	2020-07-06	2022-01-07
0136	Turn Table	ETS	-	ETS-Lindgren	N/A	N/A
0147	Switch & Positioning systems	EMC Center	00159757	ETS-Lindgren	N/A	N/A
0530	Measurement SW	EMC32, v10.40.10	100623	Rohde & Schwarz	N/A	N/A
1033	Boresight antenna mast	BAM 4.0-P	P/278/2890.01	Maturo	N/A	N/A
1076	Spectrum Analyzer	FSW43	101847	Rohde & Schwarz	2020-11-02	2022-11-02
0993	Biconical antenna 30 MHz – 1 GHz	UBAA9115 BBVU9135 DGA9552N	+ + 0286 + CH 9044	Schwarzbeck	2019-11-22	2021-11-22
0325	Horn antenna	3117	00157734	ETS-Lindgren	2019-08-12	2021-08-12
0141	Horn Antenna + Amplifier + HPF6.4	3117	00157736	ETS-Lindgren	2020-04-02	2022-04-02
0334	Double-Ridged Waveguide Horn with Pre-Amplifier 18 GHz to 40 GHz	3116C+PA	00169308bis + 00196308	ETS-Lindgren	2019-07-24	2021-07-24
0859	Cable 2.5m - 30MHz to 18GHz	0500990992500KE	19.23.395	Radiall	2020-11-27	2021-05-27
0206	Cable 1.2m – 18 to 40 GHz	UFA147A-0-0480- 200200	MFR 64639223720-003	Micro-coax	2020-08-25	2021-02-25
0263	Cable 1m - 1GHz to 18GHz	UFA147A	-	Utilflex	2020-08-25	2021-02-25
0369	Cable 2m - 26.5GHz to 40GHz	794-9191-2000A	E00327	Atem	2020-08-25	2021-02-25
0371	Cable 1m – 30 MHz - 18GHz	UFB311A-0-0590- 50U50U	MFR 64639 223230-001	Micro-coax	2020-08-25	2021-02-25
1099	Cable 7m DC-18 GHz	0501051057000GX	19.35.850	Radiall	2020-11-27	2021-05-27
0809	Cable 7m - 18GHz to 40GHz	R286304009	-	Radiall	2020-08-25	2021-02-25
1098	Cable 1.5m - DC-18GHz	CBL-1.5M-SMSM+	202879	Mini-Circuits	2020-11-27	2021-05-27
0797	Temp & Humidity Logger	RA12E-TH1-RAS	RA12-D0EB1A	Avtech	2019-07-04	2021-07-04

N/A: Not Applicable

Radiated Setup #2

ID#	Device	Type/Model	Serial #	Manufacturer	Cal. Date	Cal. Due Date
0337	Anechoic chamber	RFD-FA-100	5996	ETS Lindgren	2020-07-06	2022-07-06
0238	Switch & Positioner	EMCenter	00151232	ETS Lindgren	N/A	N/A
0382	Antenna Tower	2171B-3.0M	00150123	ETS Lindgren	N/A	N/A
0383	Turntable	-	-	ETS Lindgren	N/A	N/A
0329	Measurement SW	EMC32, v10.50.10	100401	Rohde & Schwarz	N/A	N/A
0133	Spectrum Analyzer	FSV40	101358	Rohde & Schwarz	2020-02-25	2022-02-25
0138	Double Ridge Horn (1- 18GHz)	3117	00152266	ETS Lindgren	2020-03-08	2022-03-08
0141	Horn Antenna + Amplifier + HPF6.4	3117	00157736	ETS-Lindgren	2020-04-02	2022-04-02
0334	Double Horn Ridged antenna	3116C-PA	00169308bis + 00196308	ETS-Lindgren	2019-07-24	2021-07-24
0871	RF Cable 1-18GHz, 1.5 m	0501050991200GX	19.21.710	Radiall	2020-08-20	2021-02-20
0860	RF Cable 1-18GHz, 1.2 m	2301761761200PJ	12.22.1104	Radiall	2020-08-20	2021-02-20
0275	RF Cable 1-18GHz - 6.5m	140-8500-11-51	001	Spectrum	2020-08-20	2021-02-20
0684	RF Cable 1GHz-18GHz 1.5m	-	-	Spirent	2020-08-20	2021-02-20
0679	RF Cable 18-40 GHz 6m	R286304009	1747364	Radiall	2020-08-20	2021-02-20
0028	RF Cable 1.2m 40MHz-40GHz	794-9191-1200A	DA585	Atem	2020-08-20	2021-02-20
0725	RF Cable 1-9.5GHz 1.2m	0500990991200KE	-	Radiall	2020-08-20	2021-02-20
0796	Temp & Humidity Logger	RA12E-TH1-RAS	RA12-D4F316	Avtech	2019-07-05	2021-07-05

N/A: Not Applicable

Shared Radiated Equipment

ID#	Device	Type/Model	Serial #	Manufacturer	Cal. Date	Cal. Due Date
0616	Power Sensor	NRP-Z81	104385	Rohde & Schwarz	2020-04-08	2022-04-08
0617	Power Sensor	NRP-Z81	104386	Rohde & Schwarz	2020-04-08	2022-04-08
0618	Power Sensor	NRP-Z81	104382	Rohde & Schwarz	2020-04-08	2022-04-08

A.3 Measurement Uncertainty Evaluation

The system uncertainty evaluation is shown in the table below with a coverage factor of $k = 2$ to indicate a 95% level of confidence:

Measurement type	Uncertainty	Unit
Timing	± 0.12	%
Power Spectral density	± 1.47	dB
Occupied bandwidth	± 2.07	%
Conducted Power	± 1.03	dB
Conducted Spurious Emission <26.5 GHz	± 2.93	dB
Radiated tests <1GHz	± 5.26	dB
Radiated tests 1GHz – 26.5 GHz	± 4.50	dB

Annex B. Test Results DTS

The herein test results were performed by:

Test case measurement	Test Engineer
6dB Bandwidth	G.Roustan
Maximum output power and E.I.R.P	G.Roustan
Power spectral density	G.Roustan
Out-of-band Emissions (conducted)	G.Roustan
Spurious Emissions (radiated)	A.Lounes, N.Nachabe, N.Bui

B.1 Test Conditions

For 802.11b/g modes the EUT can transmit at both CHAIN A and CHAIN B RF outputs individually, but not simultaneously.

For 802.11n20 & 802.11ax20 (20 MHz channel bandwidth), 802.11n40 & 802.11ax40 (40MHz channel bandwidth) modes the EUT can transmit at both CHAIN A and CHAIN B RF outputs individually, and also simultaneously.

For Bluetooth Low Energy mode the EUT can transmit only at CHAIN A RF output.

The following data rates were selected based on preliminary testing that identified those rates as the worst cases for output power and spurious levels at the band edges:

Transmission	Mode	Bandwidth (MHz)	Worst Case Data Rate
SISO	802.11b	20	1Mbps
	802.11g	20	6Mbps
	802.11n	20	HT0
		40	HT0
	802.11ax	20	HE0
		40	HE0
MIMO	802.11n	20/40	HT8
	802.11ax	20/40	HE0

B.2 Test Results Tables

B.2.1 6dB & 99% Bandwidth

Test limits

FCC part	RSS part	Limits
15.247 (a) (2)	RSS-247 Clause 5.2 (a)	Systems using digital modulation techniques may operate in the 902-928 MHz, 2400-2483.5 MHz, and 5725-5850 MHz bands. The minimum 6 dB bandwidth shall be at least 500 kHz.

Test procedure

The conducted setup shown in section *Test & System Description* was used to measure the 6dB & 99% Bandwidth. The antenna terminal of the EUT is connected to the spectrum through an attenuator, and the spectrum analyzer reading is compensated to include the RF path loss.

Results tables

Mode	Rate	Antenna	Channel	Freq [MHz]	6dB BW [MHz]	99% BW [MHz]
802.11b	1Mbps	SISO A	1	2412	8.08	13.79
			7	2442	9.02	13.96
			11	2462	9.05	13.86
			12	2467	9.02	13.73
			13	2472	9.00	13.44
		SISO B	1	2412	8.56	13.78
			7	2442	9.53	13.83
			11	2462	9.06	13.90
			12	2467	9.01	13.65
			13	2472	8.99	13.45
802.11g	6Mbps	SISO A	1	2412	15.04	16.71
			7	2442	15.31	18.06
			11	2462	15.07	16.69
			12	2467	15.13	16.69
			13	2472	16.34	16.43
		SISO B	1	2412	15.08	16.73
			7	2442	15.08	17.23
			11	2462	15.09	16.69
			12	2467	15.05	16.67
			13	2472	16.31	16.43
802.11n20	HT0	SISO A	1	2412	15.05	17.79
			7	2442	14.99	18.51
			11	2462	15.10	17.75
			12	2467	15.02	17.75
			13	2472	17.56	17.59
		SISO B	1	2412	15.01	17.77
			7	2442	15.64	18.52
			11	2462	14.91	17.75
			12	2467	15.41	17.74
			13	2472	17.56	17.59
	HT8	MIMO A	1	2412	15.06	17.76
			7	2442	15.08	18.44
			11	2462	15.39	17.73
			12	2467	15.02	17.74
			13	2472	17.56	17.59
MIMO B	1	2412	15.04	17.71		
	7	2442	16.32	18.59		
	11	2462	15.10	17.73		
	12	2467	16.28	17.72		
	13	2472	17.57	17.59		
802.11n40	HT0	SISO A	3	2422	33.84	36.02
			7	2442	33.75	36.00
			9	2452	34.99	36.02
			10	2457	35.02	36.00
			11	2462	36.32	36.21
		SISO B	3	2422	32.63	36.02
			7	2442	33.79	36.02
			9	2452	33.86	36.00
			10	2457	30.67	36.01
			11	2462	36.30	36.21
	HT8	MIMO A	3	2422	31.33	36.02
			7	2442	35.08	36.01
			9	2452	33.78	36.02
			10	2457	32.58	36.03
		MIMO B	11	2462	36.33	36.21
			3	2422	35.06	35.93
			7	2442	35.07	35.90
			9	2452	34.43	35.93
			10	2457	33.73	35.93
			11	2462	36.34	36.16

Max Value

Mode	Rate	Antenna	Channel	Freq [MHz]	RU config.	6dB BW [MHz]	99% BW [MHz]		
802.11ax20	HE0	SISO A	1	2412	Full	16.10	18.87		
					26/0	2.00	18.19		
					52/37	16.99	18.18		
					106/53	17.09	18.09		
			7	2442	Full	15.91	19.14		
					11	2462	Full	16.03	18.88
					12	2467	Full	16.51	18.89
					13	2472	Full	18.14	18.72
			13	2472	26/8	1.97	17.69		
					52/40	15.63	17.37		
					106/54	15.79	17.67		
					Full	15.91	18.89		
		SISO B	1	2412	26/0	2.00	18.28		
					52/37	16.97	18.01		
					106/53	17.12	17.80		
					Full	15.91	18.89		
			7	2442	Full	16.85	19.00		
					11	2462	Full	16.94	18.89
					12	2467	Full	16.01	18.89
					13	2472	Full	17.81	18.72
			13	2472	26/8	1.93	17.71		
					52/40	16.92	17.71		
					106/54	16.95	17.89		
					Full	15.75	18.89		
		MIMO A	1	2412	26/0	2.04	18.47		
					52/37	16.97	18.15		
					106/53	17.15	17.61		
					Full	15.93	19.11		
			7	2442	Full	16.36	18.87		
					11	2462	Full	16.53	18.89
					12	2467	Full	17.87	18.72
					13	2472	26/8	1.91	17.65
			13	2472	52/40	16.91	17.40		
					106/54	17.03	17.75		
					Full	15.24	18.89		
					26/0	3.26	18.22		
		MIMO B	1	2412	52/37	16.96	17.91		
					106/53	18.33	17.95		
					Full	15.01	19.10		
					11	2462	Full	14.96	18.87
			12	2467	Full	13.76	18.90		
					13	2472	Full	18.07	18.71
					26/8	1.95	17.78		
					52/40	15.66	17.79		
			13	2472	106/54	16.94	17.61		
					Full	32.88	37.45		
					242/61	16.54	18.84		
					7	2442	Full	35.42	37.47
802.11ax40	HE0	SISO A	3	2422	Full	35.05	37.47		
					9	2452	Full	35.02	37.46
					10	2457	Full	37.63	37.55
					11	2462	242/62	18.32	18.63
					3	2422	Full	35.09	37.47
		SISO B	3	2422	242/61	13.66	18.83		
					7	2442	Full	33.01	37.49
					9	2452	Full	35.03	37.47
					10	2457	Full	35.99	37.45
					11	2462	Full	37.55	37.53
		MIMO A	3	2422	242/62	18.55	18.62		
					7	2442	Full	33.80	37.46
9	2452				242/61	16.03	18.84		
10	2457				Full	36.19	37.46		
11	2462				Full	35.95	37.45		
MIMO B	3	2422	Full	35.35	37.43				
			7	2442	Full	35.35	37.43		
			9	2452	Full	36.99	37.52		
			10	2457	242/62	18.44	18.61		
			11	2462	Full	36.99	37.52		
MIMO B	3	2422	242/61	16.57	18.85				
			7	2442	Full	33.80	37.44		
			9	2452	Full	35.10	37.45		
			10	2457	Full	35.73	37.49		
			11	2462	Full	35.10	37.46		
					Full	37.04	37.52		
					242/62	18.45	18.62		

Max Value

B.2.2 Maximum Output Power and antenna gain

Test limits

	Limits
FCC Part 15.247 (b) (3)	<p>(b) The maximum peak conducted output power of the intentional radiator shall not exceed the following:</p> <p>(3) For systems using digital modulation in the 902-928 MHz, 2400-2483.5 MHz, and 5725-5850 MHz bands: 1 Watt. As an alternative to a peak power measurement, compliance with the one Watt limit can be based on a measurement of the maximum conducted output power. Maximum Conducted Output Power is defined as the total transmit power delivered to all antennas and antenna elements averaged across all symbols in the signaling alphabet when the transmitter is operating at its maximum power control level. Power must be summed across all antennas and antenna elements. The average must not include any time intervals during which the transmitter is off or is transmitting at a reduced power level.</p> <p>(4) The conducted output power limit specified in paragraph (b) of this section is based on the use of antennas with directional gains that do not exceed 6 dBi.</p>
RSS-247 Clause 5.4 (d)	<p>For DTSs employing digital modulation techniques operating in the bands 902-928 MHz and 2400-2483.5 MHz, the maximum peak conducted output power shall not exceed 1W. The e.i.r.p. shall not exceed 4 W, except as provided in section 5.4(e).</p> <p>As an alternative to a peak power measurement, compliance can be based on a measurement of the maximum conducted output power. The maximum conducted output power is the total transmit power delivered to all antennas and antenna elements, averaged across all symbols in the signalling alphabet when the transmitter is operating at its maximum power control level. Power must be summed across all antennas and antenna elements. The average must not include any time intervals during which the transmitter is off or transmitting at a reduced power level. If multiple modes of operation are implemented, the maximum conducted output power is the highest total transmit power occurring in any mode.</p>

Test procedure

The Maximum Peak Conducted Output Power was measured using a broadband peak power meter methods for 20MHz and 40MHz channel bandwidth as authorized in chapter 2.0 "*Power limits, definitions and device configuration*" of FCC OET KDB 558074 D01

For MIMO mode, according to the measure-and-sum approach defined in FCC OET KDB 662911 D01 - Guidance for Emission Testing of Transmitters with Multiple Outputs in the Same Band, the conducted emission level (e.g., transmit power or power in specified bandwidth) is measured at each antenna port. The measured results at the various antenna ports are then summed mathematically in linear power units to determine the total emission level from the device.

The EIRP power (dBm) is calculated by adding the declared maximum antenna gain to the measured conducted power.

The conducted setup shown in section *Test & System Description* was used to measure the maximum conducted output power. The antenna terminal of the EUT is connected to the spectrum through an attenuator, and the spectrum analyzer reading is compensated to include the RF path loss.

Results tables:

Maximum peak power are shown in table below with **min** and **max** values highlighted. Maximum average output power are shown for indicative purpose only

Mode	Rate	# Ch	Freq [MHz]	Ant	Meas Peak Cond.Power [dBm]	EIRP [dBm]	EIRP [mW]	Peak Cond.Power [mW]	Meas. Avg Cond.Power [dBm]	Max. Avg Cond.Power* [dBm]	EIRP [mW]	Avg Cond.Power [mW]
802.11b	1Mbps	1	2412	SISO A	23.80	27.04	505.82	239.88	20.61	20.61	242.66	115.08
				SISO B	23.77	27.01	502.34	238.23	20.61	20.61	242.66	115.08
		7	2442	SISO A	24.27	27.51	563.64	267.30	21.22	21.22	279.25	132.43
				SISO B	23.94	27.18	522.40	247.74	20.76	20.76	251.19	119.12
		11	2462	SISO A	23.92	27.16	520.00	246.60	20.70	20.70	247.74	117.49
				SISO B	24.28	27.52	564.94	267.92	21.04	21.04	267.92	127.06
12	2467	SISO A	21.98	25.22	332.66	157.76	18.72	18.72	157.04	74.47		
		SISO B	22.07	25.31	339.63	161.06	18.83	18.83	161.06	76.38		
13	2472	SISO A	18.80	22.04	159.96	75.86	15.60	15.60	76.56	36.31		
		SISO B	18.65	21.89	154.53	73.28	15.38	15.38	72.78	34.51		
802.11g	6Mbps	1	2412	SISO A	27.29	30.53	1129.80	535.80	19.04	19.13	172.71	81.90
				SISO B	27.44	30.68	1169.50	554.63	19.23	19.32	180.43	85.57
		7	2442	SISO A	29.41	32.65	1840.77	872.97	21.03	21.12	273.09	129.51
				SISO B	29.04	32.28	1690.44	801.68	20.67	20.76	251.37	119.21
		11	2462	SISO A	26.78	30.02	1004.62	476.43	18.54	18.63	153.92	73.00
				SISO B	27.01	30.25	1059.25	502.34	18.67	18.76	158.60	75.22
12	2467	SISO A	23.71	26.95	495.45	234.96	15.36	15.45	74.01	35.10		
		SISO B	23.80	27.04	505.82	239.88	15.43	15.52	75.22	35.67		
13	2472	SISO A	20.03	23.27	212.32	100.69	11.76	11.85	32.31	15.32		
		SISO B	20.28	23.52	224.91	106.66	11.93	12.02	33.60	15.93		
802.11n20	HTO	1	2412	SISO A	26.66	29.90	977.24	463.45	18.47	18.47	148.25	70.31
				SISO B	26.88	30.12	1028.02	487.53	18.64	18.64	154.17	73.11
		7	2442	SISO A	29.32	32.56	1803.02	855.07	20.98	20.98	264.24	125.31
				SISO B	29.55	32.79	1901.08	901.57	21.25	21.25	281.19	133.35
		11	2462	SISO A	26.33	29.57	905.73	429.54	18.04	18.04	134.28	63.68
				SISO B	26.45	29.69	931.11	441.57	18.24	18.24	140.60	66.68
	12	2467	SISO A	23.56	26.80	478.63	226.99	15.31	15.31	71.61	33.96	
			SISO B	23.70	26.94	494.31	234.42	15.38	15.38	72.78	34.51	
	13	2472	SISO A	19.97	23.21	209.41	99.31	11.69	11.69	31.12	14.76	
			SISO B	20.23	23.47	222.33	105.44	11.84	11.84	32.21	15.28	
	HT8	1	2412	MIMO A	24.36	27.60	575.44	272.90	16.19	16.19	87.70	41.59
				MIMO B	24.73	27.97	626.61	297.17	16.19	16.19	87.70	41.59
				Combined A+B	27.56	30.80	1202.05	570.06	19.20	19.20	175.40	83.18
				MIMO A	26.80	30.04	1009.25	478.63	20.76	20.76	251.19	119.12
				MIMO B	27.01	30.25	1059.25	502.34	20.95	20.95	262.42	124.45
				Combined A+B	29.91	33.15	2065.38	979.49	23.87	23.87	513.61	243.58
		11	2462	MIMO A	25.29	28.53	712.85	338.06	16.96	16.96	104.71	49.66
				MIMO B	25.61	28.85	767.36	363.92	16.99	16.99	105.44	50.00
Combined A+B				28.46	31.70	1480.21	701.98	19.99	19.99	210.15	99.66	
MIMO A				20.32	23.56	226.99	107.65	12.01	12.01	33.50	15.89	
MIMO B				20.52	23.76	237.68	112.72	11.84	11.84	32.21	15.28	
Combined A+B				23.43	26.67	464.67	220.37	14.94	14.94	65.71	31.16	
13	2472	MIMO A	17.83	21.07	127.94	60.67	9.43	9.43	18.49	8.77		
		MIMO B	18.57	21.81	151.71	71.94	9.83	9.83	20.28	9.62		
		Combined A+B	21.23	24.47	279.64	132.62	12.64	12.64	38.77	18.39		
		SISO A	24.51	27.75	595.66	282.49	16.23	16.32	90.43	42.89		
		SISO B	24.50	27.74	594.29	281.84	16.20	16.29	89.81	42.59		
		SISO A	25.57	28.81	760.33	360.58	17.27	17.36	114.90	54.49		
7	2442	SISO B	25.67	28.91	778.04	368.98	17.37	17.46	117.57	55.76		
		SISO A	24.14	27.38	547.02	259.42	15.85	15.94	82.85	39.29		
		SISO B	24.15	27.39	548.28	260.02	15.84	15.93	82.66	39.20		
		SISO A	19.10	22.34	171.40	81.28	10.81	10.90	25.96	12.31		
		SISO B	19.07	22.31	170.22	80.72	10.78	10.87	25.78	12.23		
		SISO A	19.10	22.34	171.40	81.28	10.73	10.82	25.49	12.09		
11	2462	SISO B	19.24	22.48	177.01	83.95	10.93	11.02	26.69	12.66		
		MIMO A	23.84	27.08	510.50	242.10	15.55	15.64	77.32	36.67		
		MIMO B	23.75	26.99	500.03	237.14	15.13	15.22	70.19	33.29		
		Combined A+B	26.81	30.05	1010.54	479.24	18.45	18.54	150.71	71.47		
		MIMO A	23.91	27.15	518.80	246.04	15.60	15.69	78.22	37.09		
		MIMO B	24.48	27.72	591.56	280.54	15.79	15.88	81.72	38.75		
9	2452	Combined A+B	27.21	30.45	1110.36	526.58	18.80	18.89	163.40	77.49		
		MIMO A	22.93	26.17	414.00	196.34	14.61	14.70	62.27	29.53		
		MIMO B	22.98	26.22	418.79	198.61	14.37	14.46	58.93	27.95		
		Combined A+B	25.97	29.21	832.79	394.95	17.60	17.69	123.82	58.72		
		MIMO A	16.56	19.80	95.50	45.29	8.28	8.37	14.50	6.88		
		MIMO B	16.97	20.21	104.95	49.77	8.31	8.40	14.60	6.92		
10	2457	Combined A+B	19.78	23.02	200.45	95.06	11.40	11.49	29.73	14.10		
		MIMO A	17.64	20.88	122.46	58.08	9.34	9.43	18.51	8.78		
		MIMO B	18.15	21.39	137.72	65.31	9.46	9.55	19.02	9.02		
		Combined A+B	20.91	24.15	260.18	123.39	12.50	12.60	38.34	18.18		
		MIMO A	16.56	19.80	95.50	45.29	8.28	8.37	14.50	6.88		
		MIMO B	16.97	20.21	104.95	49.77	8.31	8.40	14.60	6.92		
11	2462	Combined A+B	19.78	23.02	200.45	95.06	11.40	11.49	29.73	14.10		
		MIMO A	17.64	20.88	122.46	58.08	9.34	9.43	18.51	8.78		
		MIMO B	18.15	21.39	137.72	65.31	9.46	9.55	19.02	9.02		
		Combined A+B	20.91	24.15	260.18	123.39	12.50	12.60	38.34	18.18		
		MIMO A	16.56	19.80	95.50	45.29	8.28	8.37	14.50	6.88		
		MIMO B	16.97	20.21	104.95	49.77	8.31	8.40	14.60	6.92		

* Duty cycle compensated

Mode	Rate	# Ch	Freq [MHz]	Antenna	RU config	Meas Peak Cond.Po wer [dBm]	EIRP [dBm]	EIRP [mW]	Peak Cond.Power [mW]	Meas. Avg Cond.Power [dBm]	Max. Avg Cond.Power* [dBm]	EIRP [mW]	Avg Cond.Power [mW]
802.11ax20	HEO	1	2412	SISO A	Full	26.86	30.10	1023.29	485.29	17.90	17.90	130.02	61.66
					26/0	27.72	30.96	1247.38	591.56	19.52	19.52	188.80	89.54
					52/37	28.52	31.76	1499.68	711.21	19.62	19.62	193.20	91.62
				SISO B	106/53	28.91	32.15	1640.59	778.04	19.67	19.67	195.43	92.68
					Full	26.98	30.22	1051.96	498.88	17.98	17.98	132.43	62.81
					26/0	27.42	30.66	1164.13	552.08	19.31	19.31	179.89	85.31
				MIMO A	52/37	28.57	31.81	1517.05	719.45	19.63	19.63	193.64	91.83
					106/53	28.96	32.20	1659.59	787.05	19.59	19.59	191.87	90.99
					Full	25.01	28.25	668.34	316.96	16.01	16.01	84.14	39.90
				MIMO B	26/0	26.80	30.04	1009.25	478.63	18.82	18.82	160.69	76.21
					52/37	26.89	30.13	1030.39	488.65	18.94	18.94	165.20	78.34
					106/53	26.77	30.01	1002.31	475.34	19.00	19.00	167.49	79.43
		Combined A+B	Full	25.28	28.52	711.21	337.29	16.22	16.22	88.31	41.88		
			26/0	26.85	30.09	1020.94	484.17	18.77	18.77	158.85	75.34		
			52/37	26.86	30.10	1023.29	485.29	19.09	19.09	171.00	81.10		
		MIMO A	106/53	28.44	31.68	1472.31	698.23	19.07	19.07	170.22	80.72		
			Full	28.16	31.40	1379.56	654.24	19.13	19.13	172.45	81.78		
			26/0	29.83	33.07	2027.68	961.61	21.81	21.81	319.55	151.54		
		MIMO B	52/37	29.88	33.12	2051.16	972.74	22.03	22.03	336.20	159.44		
			106/53	27.02	30.26	1061.7	503.501	22.05	22.05	337.71	160.16		
			Full	29.88	33.12	2051.16	972.75	20.88	20.88	258.23	122.46		
		7	2442	SISO A	Full	29.88	33.12	2051.16	972.75	20.88	20.88	258.23	122.46
				SISO B	Full	29.71	32.95	1972.42	935.41	20.72	20.72	248.89	118.03
				MIMO A	Full	29.55	32.79	1901.08	901.57	20.57	20.57	240.44	114.02
				MIMO B	Full	29.83	33.07	2027.68	961.61	20.71	20.71	248.31	117.76
				Combined A+B	Full	29.91	33.15	2065.38	979.49	23.65	23.65	488.75	231.79
		11	2462	SISO A	Full	26.68	29.92	981.75	465.59	17.59	17.59	121.06	57.41
				SISO B	Full	26.93	30.17	1039.92	493.17	17.83	17.83	127.94	60.67
				MIMO A	Full	25.09	28.33	680.77	322.85	16.16	16.16	87.10	41.30
				MIMO B	Full	25.51	28.75	749.89	355.63	16.29	16.29	89.74	42.56
				Combined A+B	Full	28.32	31.56	1430.66	678.48	19.24	19.24	176.84	83.86
		12	2467	SISO A	Full	24.26	27.50	562.34	266.69	15.20	15.20	69.82	33.11
				SISO B	Full	24.34	27.58	572.80	271.64	15.28	15.28	71.12	33.73
				MIMO A	Full	21.84	25.08	322.11	152.76	12.78	12.78	39.99	18.97
				MIMO B	Full	21.84	25.08	322.11	152.76	12.68	12.68	39.08	18.54
				Combined A+B	Full	24.85	28.09	644.21	305.51	15.74	15.74	79.08	37.50
		13	2472	SISO A	Full	21.16	24.40	275.42	130.62	11.91	11.91	32.73	15.52
					26/8	19.53	22.77	189.23	89.74	9.23	9.23	17.66	8.38
					52/40	19.26	22.50	177.83	84.33	9.08	9.08	17.06	8.09
					106/54	18.99	22.23	167.11	79.25	9.01	9.01	16.79	7.96
				SISO B	Full	21.04	24.28	267.92	127.06	11.81	11.81	31.99	15.17
					26/8	19.62	22.86	193.20	91.62	9.29	9.29	17.91	8.49
					52/40	19.50	22.74	187.93	89.13	9.19	9.19	17.50	8.30
					106/54	19.04	22.28	169.04	80.17	9.06	9.06	16.98	8.05
				MIMO A	Full	19.44	22.68	185.35	87.90	10.21	10.21	22.13	10.50
					26/8	17.73	20.97	125.03	59.29	7.37	7.37	11.51	5.46
					52/40	18.11	21.35	136.46	64.71	7.80	7.80	12.71	6.03
					106/54	18.09	21.33	135.83	64.42	7.87	7.87	12.91	6.12
MIMO B	Full			19.39	22.63	183.23	86.90	10.03	10.03	21.23	10.07		
	26/8			18.15	21.39	137.72	65.31	7.83	7.83	12.79	6.07		
	52/40			18.52	21.76	149.97	71.12	8.17	8.17	13.84	6.56		
	106/54			18.29	21.53	142.23	67.45	8.08	8.08	13.55	6.43		
Combined A+B	Full	22.43	25.67	368.58	174.80	13.13	13.13	43.36	20.56				
	26/8	20.96	24.20	262.75	124.61	10.62	10.62	24.30	11.52				
	52/40	21.33	24.57	286.43	135.84	11.00	11.00	26.54	12.59				
	106/54	21.20	24.44	278.06	131.87	10.99	10.99	26.46	12.55				

* Duty cycle compensated

Mode	Rate	# Ch	Freq [MHz]	Antenna	RU config	Meas Peak Cond.P ower [dBm]	EIRP [dBm]	EIRP [mW]	Peak Cond.Power [mW]	Meas. Avg Cond.Po wer [dBm]	Max. Avg Cond.Po wer* [dBm]	EIRP [mW]	Avg Cond.Power [mW]
802.11ax40	HEO	3	2422	SISO A	Full	25.30	28.54	714.50	338.84	15.97	15.97	83.37	39.54
					242/61	27.26	30.50	1122.02	532.11	18.16	18.16	138.04	65.46
				SISO B	Full	25.56	28.80	758.58	359.75	16.23	16.23	88.51	41.98
					242/61	27.30	30.54	1132.40	537.03	18.18	18.18	138.68	65.77
				MIMO A	Full	24.70	27.94	622.30	295.12	15.37	15.37	72.61	34.43
					242/61	26.15	29.39	868.96	412.10	17.09	17.09	107.89	51.17
		MIMO B	Full	24.54	27.78	599.79	284.45	15.08	15.08	67.92	32.21		
			242/61	26.27	29.51	893.31	423.64	17.14	17.14	109.14	51.76		
		Combined A+B	Full	27.63	30.87	1222.09	579.57	18.24	18.24	140.53	66.65		
			242/61	29.22	32.46	1762.27	835.74	20.13	20.13	217.04	102.93		
		7	2442	SISO A	Full	26.05	29.29	849.18	402.72	16.74	16.74	99.54	47.21
					Full	26.10	29.34	859.01	407.38	16.79	16.79	100.69	47.75
				MIMO A	Full	24.76	28.00	630.96	299.23	15.39	15.39	72.95	34.59
					Full	25.06	28.30	676.08	320.63	15.62	15.62	76.91	36.48
				Combined A+B	Full	27.92	31.16	1307.04	619.85	18.52	18.52	149.86	71.07
		9	2452	SISO A	Full	25.07	28.31	677.64	321.37	15.73	15.73	78.89	37.41
					Full	25.18	28.42	695.02	329.61	15.87	15.87	81.47	38.64
				MIMO A	Full	24.79	28.03	635.33	301.30	15.33	15.33	71.94	34.12
					Full	24.10	27.34	542.00	257.04	14.58	14.58	60.53	28.71
		MIMO B	Full	27.47	30.71	1177.33	558.34	17.98	17.98	132.48	62.83		
			Full	20.24	23.48	222.84	105.68	10.92	10.92	26.06	12.36		
		10	2457	SISO A	Full	20.20	23.44	220.80	104.71	10.89	10.89	25.88	12.27
					Full	19.08	22.32	170.61	80.91	9.70	9.70	19.68	9.33
				MIMO A	Full	19.12	22.36	172.19	81.66	9.62	9.62	19.32	9.16
					Full	22.11	25.35	342.80	162.57	12.67	12.67	39.00	18.49
				Combined A+B	Full	20.31	23.55	226.46	107.40	10.93	10.93	26.12	12.39
		11	2462	SISO A	Full	20.31	23.55	226.46	107.40	10.93	10.93	26.12	12.39
					242/62	18.27	21.51	141.58	67.14	8.84	8.84	16.14	7.66
				SISO B	Full	20.16	23.40	218.78	103.75	10.85	10.85	25.64	12.16
					242/62	18.56	21.80	151.36	71.78	9.12	9.12	17.22	8.17
				MIMO A	Full	19.15	22.39	173.38	82.22	9.73	9.73	19.82	9.40
					242/62	17.15	20.39	109.40	51.88	7.78	7.78	12.65	6.00
				MIMO B	Full	19.43	22.67	184.93	87.70	9.85	9.85	20.37	9.66
					242/62	17.78	21.02	126.47	59.98	8.25	8.25	14.09	6.68
				Combined A+B	Full	22.30	25.54	358.31	169.92	12.80	12.80	40.19	19.06
					242/62	20.49	23.73	235.87	111.86	11.03	11.03	26.74	12.68

* Duty cycle compensated

B.2.3 Power Spectral Density

Test limits

FCC part	RSS part	Limits
15.247 (e)	RSS-247 Clause 5.2 (b)	For digitally modulated systems, the power spectral density conducted from the intentional radiator to the antenna shall not be greater than 8 dBm in any 3 kHz band during any time interval of continuous transmission. This power spectral density shall be determined in accordance with the provisions of paragraph (b) of this section. The same method of determining the conducted output power shall be used to determine the power spectral density.

Test procedure

The peak power spectral density level in the fundamental emission was measured using the *Method PKPSD (peak PSD)* according to section 11.10.2 of ANSI C63.10-2013.

For MIMO mode, the *Measure and add $10 \log(N_{ANT})$ dB*, (where N_{ANT} is the number of outputs) technique was used according to the *Guidance for Emission Testing of Transmitters with Multiple Outputs in the Same Band FCC OET KDB 662911 D01 Multiple Transmitter Output*.

With this technique, spectrum measurements are performed at each output of the device, and the quantity $10 \log(N_{ANT})$ dB is added to each spectrum value before comparing to the emission limit. Number of outputs = 2.

The conducted setup shown in section *Test & System Description* was used to measure the power spectral density. The antenna terminal of the EUT is connected to the spectrum through an attenuator, and the spectrum analyzer reading is compensated to include the RF path loss.

Results tables

Mode	Rate	Channel	Freq [MHz]	Antenna	PSD Peak [dBm/3kHz]	MIMO Combined +10·log(N _{ant}) [dBm/3kHz]
802.11b	1Mbps	1	2412	SISO A	-1.62	n/a
				SISO B	-1.61	n/a
		7	2442	SISO A	-1.12	n/a
				SISO B	-1.54	n/a
		11	2462	SISO A	-1.61	n/a
				SISO B	-1.27	n/a
		12	2467	SISO A	-3.54	n/a
				SISO B	-3.44	n/a
		13	2472	SISO A	-6.63	n/a
				SISO B	-6.83	n/a
802.11g	6Mbps	1	2412	SISO A	-4.61	n/a
				SISO B	-3.02	n/a
		7	2442	SISO A	-2.35	n/a
				SISO B	-2.47	n/a
		11	2462	SISO A	-4.56	n/a
				SISO B	-4.78	n/a
		12	2467	SISO A	-7.78	n/a
				SISO B	-7.76	n/a
		13	2472	SISO A	-12.72	n/a
				SISO B	-12.11	n/a
802.11n20	HT0	1	2412	SISO A	-4.47	n/a
				SISO B	-4.98	n/a
		7	2442	SISO A	-2.14	n/a
				SISO B	-2.25	n/a
		11	2462	SISO A	-5.93	n/a
				SISO B	-4.58	n/a
		12	2467	SISO A	-8.17	n/a
				SISO B	-7.78	n/a
		13	2472	SISO A	-11.83	n/a
				SISO B	-11.61	n/a
	HT8	1	2412	MIMO A	-6.76	-3.75
				MIMO B	-6.44	-3.43
		7	2442	MIMO A	-2.22	0.79
				MIMO B	-1.98	1.03
		11	2462	MIMO A	-6.81	-3.80
				MIMO B	-6.49	-3.48
		12	2467	MIMO A	-11.66	-8.65
				MIMO B	-10.71	-7.70
13	2472	MIMO A	-14.90	-11.89		
		MIMO B	-14.68	-11.67		
802.11n40	HT0	3	2422	SISO A	-10.56	n/a
				SISO B	-9.35	n/a
		7	2442	SISO A	-9.45	n/a
				SISO B	-9.45	n/a
		9	2452	SISO A	-10.98	n/a
				SISO B	-10.41	n/a
		10	2457	SISO A	-15.89	n/a
				SISO B	-14.51	n/a
		11	2462	SISO A	-16.57	n/a
				SISO B	-16.62	n/a
	HT8	3	2422	MIMO A	-10.43	-7.42
				MIMO B	-11.01	-8.00
		7	2442	MIMO A	-10.60	-7.59
				MIMO B	-10.51	-7.50
		9	2452	MIMO A	-12.52	-9.51
				MIMO B	-12.82	-9.81
		10	2457	MIMO A	-18.20	-15.19
				MIMO B	-17.59	-14.58
11	2462	MIMO A	-17.59	-14.58		
		MIMO B	-17.66	-14.65		

Mode	Rate	#Ch	Freq[MHz]	Antenna	RU config.	PSD Peak [dBm/3kHz]	MIMO Combined +10·log(N _{ant}) [dBm/3kHz]
802.11ax20	HE0	1	2412	SISO A	Full	-6.58	n/a
					26/0	3.69	n/a
					52/37	1.13	n/a
				SISO B	106/53	-2.43	n/a
					Full	-6.80	n/a
					26/0	3.59	n/a
				MIMO A	52/37	0.44	n/a
					106/53	-2.00	n/a
					Full	-8.03	-5.02
				MIMO B	26/0	2.55	5.56
					52/37	-0.07	2.94
					106/53	-2.41	0.60
		7	2442	SISO A	Full	-7.42	-4.41
					26/0	2.09	5.10
					52/37	0.66	3.67
					106/53	-2.20	0.81
		11	2462	SISO A	Full	-3.13	n/a
					Full	-3.12	n/a
				MIMO A	Full	-3.94	-0.93
					Full	-2.99	0.02
		12	2467	SISO A	Full	-6.08	n/a
					Full	-6.08	n/a
				MIMO A	Full	-8.19	-5.18
					Full	-7.80	-4.79
		13	2472	SISO A	Full	-8.34	n/a
					Full	-9.40	n/a
				MIMO A	Full	-11.72	-8.71
					Full	-11.53	-8.52
		SISO A	26/8	Full	-12.95	n/a	
				26/8	-6.23	n/a	
				52/40	-8.80	n/a	
			SISO B	106/54	-12.39	n/a	
				Full	-13.16	n/a	
				26/8	-6.59	n/a	
			MIMO A	52/40	-9.44	n/a	
				106/54	-12.84	n/a	
				Full	-14.91	-11.90	
			MIMO B	26/8	-8.80	-5.79	
				52/40	-10.93	-7.92	
				106/54	-13.74	-10.73	
		106/54	Full	-14.72	-11.71		
			26/8	-7.65	-4.64		
			52/40	-10.31	-7.30		
		106/54	-13.43	-10.42			

Mode	Rate	#Ch	Freq[MHz]	Antenna	RU config.	PSD Peak [dBm/3kHz]	MIMO Combined +10·log(N _{ant}) [dBm/3kHz]
802.11ax40	HE0	3	2422	SISO A	Full	-11.04	n/a
					242/61	-6.24	n/a
				SISO B	Full	-11.25	n/a
					242/61	-5.81	n/a
		MIMO A	Full	-11.01	-8.00		
			242/61	-6.49	-3.48		
		MIMO B	Full	-12.33	-9.32		
			242/61	-6.80	-3.79		
		7	2442	SISO A	Full	-11.15	n/a
					Full	-10.76	n/a
				MIMO A	Full	-12.01	-9.00
					Full	-11.65	-8.64
		9	2452	SISO A	Full	-11.61	n/a
					Full	-11.32	n/a
				MIMO A	Full	-12.20	-9.19
					Full	-12.39	-9.38
		10	2457	SISO A	Full	-15.78	n/a
					Full	-16.71	n/a
				MIMO A	Full	-16.98	-13.97
					Full	-18.05	-15.04
11	2462	SISO A	Full	-16.80	n/a		
			242/62	-16.67	n/a		
		SISO B	Full	-17.45	n/a		
			242/62	-16.25	n/a		
		MIMO A	Full	-18.04	-15.03		
			242/62	-17.25	-14.24		
MIMO B	Full	-18.09	-15.08				
				MIMO B	242/62	-16.51	-13.50

B.2.4 Out-of-band emission (conducted)

Test Limits

FCC part	RSS part	Limits																				
15.247 (d)	RSS-247 Clause 5.5	In any 100 kHz bandwidth outside the frequency band in which the spread spectrum or digitally modulated intentional radiator is operating, the radio frequency power that is produced by the intentional radiator shall be at least 20 dB below that in the 100 kHz bandwidth within the band that contains the highest level of the desired power, based on either an RF conducted or a radiated measurement, provided the transmitter demonstrates compliance with the peak conducted power limits.																				
15.209	RSS-Gen A1 Clause 8.9	<p>Radiated emissions which fall in the restricted bands, as defined in §15.205(a), must also comply with the radiated emission limits specified in §15.209(a):</p> <table border="1"> <thead> <tr> <th>Freq Range (MHz)</th> <th>Field Strength (μV/m)</th> <th>Field Strength (dBμV/m)</th> <th>Meas. Distance (m)</th> </tr> </thead> <tbody> <tr> <td>30-88</td> <td>100</td> <td>40</td> <td>3</td> </tr> <tr> <td>88-216</td> <td>150</td> <td>43.5</td> <td>3</td> </tr> <tr> <td>216-960</td> <td>200</td> <td>46</td> <td>3</td> </tr> <tr> <td>Above 960</td> <td>500</td> <td>54</td> <td>3</td> </tr> </tbody> </table> <p>The emission limits shown in the above table are based on measurements employing CISPR quasi-peak detector except for the frequency bands 9-90 kHz, 110-490 kHz and above 1000 MHz. Radiated emission limits in these three bands are based on measurements employing an average detector. For average radiated emission measurements above 1000 MHz, there is also a limit specified when measuring with peak detector function, corresponding to 20 dB above the indicated values in the table.</p>	Freq Range (MHz)	Field Strength (μV/m)	Field Strength (dBμV/m)	Meas. Distance (m)	30-88	100	40	3	88-216	150	43.5	3	216-960	200	46	3	Above 960	500	54	3
Freq Range (MHz)	Field Strength (μV/m)	Field Strength (dBμV/m)	Meas. Distance (m)																			
30-88	100	40	3																			
88-216	150	43.5	3																			
216-960	200	46	3																			
Above 960	500	54	3																			

Test procedure

The upper band edge was measured using the method according to section 11.13.3 (Integration Method) of ANSI C63.10-2013 and FCC OET KDB 558074 D01

In case of band edge measurements falling in restricted bands, the declared antenna gain is also compensated in the graph.

For band edge measurements falling in restricted bands, the following limits in dBm were applied for the average detector after the conversion from the limits detailed above in dBμV/m, according to FCC 47 CFR part 15 - Subpart C – §15.209(a). The limits in dBm for peak detector are 20dB above the indicated values in the table.

§15.209(a)			Converted values	
Freq Range (MHz)	Distance (m)	Field strength (microvolts/meter)	Field strength (dB microvolts/meter)	Power (dBm)
Above 960	3	500	54.0	-41.2

The conducted setup shown in section *Test & System Description* was used to measure the out-of-band emissions. The antenna terminal of the EUT is connected to the spectrum through an attenuator, and the spectrum analyzer reading is compensated to include the RF path loss.

See Section B.2.7 for the screenshot results.

B.2.5 Radiated spurious emission

Standard references

FCC part	RSS part	Limits																					
<p>15.247 (d) 15.209</p>	<p>RSS-247 Clause 5.5 RSS-Gen A1 Clause 8.9</p>	<p>Radiated emissions which fall in the restricted bands, as defined in §15.205(a), must also comply with the radiated emission limits specified in §15.209(a):</p>																					
		<table border="1"> <thead> <tr> <th>Freq Range (MHz)</th> <th>Field Strength (μV/m)</th> <th>Field Strength (dBμV/m)</th> <th>Meas. Distance (m)</th> </tr> </thead> <tbody> <tr> <td>30-88</td> <td>100</td> <td>40</td> <td>3</td> </tr> <tr> <td>88-216</td> <td>150</td> <td>43.5</td> <td>3</td> </tr> <tr> <td>216-960</td> <td>200</td> <td>46</td> <td>3</td> </tr> <tr> <td>Above 960</td> <td>500</td> <td>54</td> <td>3</td> </tr> </tbody> </table>	Freq Range (MHz)	Field Strength (μV/m)	Field Strength (dBμV/m)	Meas. Distance (m)	30-88	100	40	3	88-216	150	43.5	3	216-960	200	46	3	Above 960	500	54	3	
Freq Range (MHz)	Field Strength (μV/m)	Field Strength (dBμV/m)	Meas. Distance (m)																				
30-88	100	40	3																				
88-216	150	43.5	3																				
216-960	200	46	3																				
Above 960	500	54	3																				
<p>The emission limits shown in the above table are based on measurements employing CISPR quasi-peak detector except for the frequency bands 9-90 kHz, 110-490 kHz and above 1000 MHz. Radiated emission limits in these three bands are based on measurements employing an average detector. For average radiated emission measurements above 1000 MHz, there is also a limit specified when measuring with peak detector function corresponding to 20 dB above the indicated values in the table.</p>																							

Test procedure

The radiated setups shown in section *Test & System Description* were used to measure the radiated spurious emissions. Depending of the frequency range and bands being tested, different antennas and filters were used. The final measurement is done by varying the antenna height from 1 to 4 meters, the EUT azimuth over 360° and for both Vertical and Horizontal polarizations.

The radiated spurious emissions were measured on the worst case configuration selected from the chapter B.1 and using the lowest, middle and highest channels.

For 802.11ax20 and 802.11ax40 modes, the worst case spurious emission result among the low, mid and high channels tested separately on Chain A and B is used to perform the test on MIMO mode (Chain A+B).

For 802.11n20 and 802.11n40 modes the worst channel found among all 802.11ax modes mentioned above is chosen to perform the test in Chain A, B, and MIMO (Chain A+B).

Test Results

Radiated spurious - 30 MHz – 1 GHz

Radiated Spurious – All modes

Frequency	Quasi-Peak	Limit	Margin	Polar
MHz	dBµV/m	dBµV/m	dB	---
37.5	29.9	40.0	10.1	V
127.1	36.7	43.5	6.8	V

Note 1: The spurious signals detected do not depend on either the operating channel or the modulation mode.

1 GHz – 26.5 GHz, 802.11b, 1Mbps, Chain A

Radiated Spurious – CH1

Frequency	MaxPeak	Average	Limit	Margin	Polar
MHz	dBµV/m	dBµV/m	dBµV/m	dB	---
4823.9	52.5	---	74.0	21.5	V
4823.9	---	43.9	54.0	10.1	V
7236.6	47.3	---	74.0	26.7	H
7236.6	---	38.2	54.0	15.8	V
9648.0	48.2	---	74.0	25.8	H
9648.0	---	38.8	54.0	15.2	H
24902.0	---	37.4	54.0	16.6	H
24902.0	49.4	---	74.0	24.6	H

Radiated Spurious – CH7

Frequency	MaxPeak	Average	Limit	Margin	Polar
MHz	dBµV/m	dBµV/m	dBµV/m	dB	---
4883.8	51.6	---	74.0	22.4	V
4884.1	---	42.8	54.0	11.2	V
7324.1	45.4	---	74.0	28.6	H
7324.1	---	36.3	54.0	17.7	H
25923.9	---	38.3	54.0	15.7	V
25923.9	50.7	---	74.0	23.3	V

Radiated Spurious – CH11

Frequency	MaxPeak	Average	Limit	Margin	Polar
MHz	dB μ V/m	dB μ V/m	dB μ V/m	dB	---
4923.9	52.4	---	74.0	21.6	V
4924.2	---	43.3	54.0	10.7	V
7384.6	45.8	---	74.0	28.2	H
7384.6	---	36.9	54.0	17.1	H
24958.7	49.7	---	74.0	24.3	H
24961.5	---	37.8	54.0	16.2	V

1 GHz – 26.5 GHz, 802.11b, 1Mbps, Chain B

Radiated Spurious – CH1

Frequency	MaxPeak	Average	Limit	Margin	Polar
MHz	dB μ V/m	dB μ V/m	dB μ V/m	dB	---
4823.9	51	---	74.0	23.0	H
4823.9	---	41.8	54.0	12.2	V
7234.7	---	35.9	54.0	18.1	H
7235.2	46.7	---	74.0	27.3	V
25830.9	---	37.8	54.0	16.2	H
25830.9	50.4	---	74.0	23.6	V

Radiated Spurious – CH7

Frequency	MaxPeak	Average	Limit	Margin	Polar
MHz	dB μ V/m	dB μ V/m	dB μ V/m	dB	---
4883.8	51.2	---	74.0	22.8	H
4883.8	---	42.2	54.0	11.8	H
17920.2	55.2	---	74.0	18.8	H
17920.2	---	42.9	54.0	11.1	H
25941.4	---	38.7	54.0	15.3	H
25946.6	50.7	---	74.0	23.3	H

Radiated Spurious – CH11

Frequency	MaxPeak	Average	Limit	Margin	Polar
MHz	dB μ V/m	dB μ V/m	dB μ V/m	dB	---
4924.2	---	43.3	54.0	10.7	V
4924.6	52.8	---	74.0	21.2	H
17804.2	54.7	---	74.0	19.3	V
17804.2	---	41.8	54.0	12.2	V
25943.2	50.5	---	74.0	23.5	V
25945.6	---	38.2	54.0	15.8	V

1 GHz – 26.5 GHz, 802.11g, 6Mbps, Chain A

Radiated Spurious – CH1

Frequency	MaxPeak	Average	Limit	Margin	Polar
MHz	dB μ V/m	dB μ V/m	dB μ V/m	dB	---
2995.5	---	46.7	54.0	7.3	H
2995.5	59.4	---	74.0	14.6	V
17820.2	---	42.3	54.0	11.7	H
17820.2	54.4	---	74.0	19.6	V
25590.0	50.7	---	74.0	23.3	H
25590.5	---	37.3	54.0	16.7	V

Radiated Spurious – CH7

Frequency	MaxPeak	Average	Limit	Margin	Polar
MHz	dB μ V/m	dB μ V/m	dB μ V/m	dB	---
2947.5	---	46.8	54.0	7.2	V
2947.5	60.2	---	74.0	13.8	H
17421.9	54.1	---	74.0	19.9	H
17430.6	---	42.1	54.0	11.9	H
25236.3	---	38	54.0	16.0	V
25239.6	49.4	---	74.0	24.6	H

Radiated Spurious – CH11

Frequency	MaxPeak	Average	Limit	Margin	Polar
MHz	dB μ V/m	dB μ V/m	dB μ V/m	dB	---
2936.0	---	47.0	54.0	7.0	V
2936.0	60	---	74.0	14.0	H
17392.5	54.4	---	74.0	19.6	V
17367.8	---	42.0	54.0	12.0	V
25858.2	50	---	74.0	24.0	V
25869.1	---	38.4	54.0	15.6	H

1 GHz – 26.5 GHz, 802.11g, 6Mbps, Chain B

Radiated Spurious – CH1

Frequency	MaxPeak	Average	Limit	Margin	Polar
MHz	dB μ V/m	dB μ V/m	dB μ V/m	dB	---
2982.0	---	46.6	54.0	7.4	V
2982.0	59.5	---	74.0	14.5	H
17844.8	---	42.6	54.0	11.4	H
17844.8	55.6	---	74.0	18.4	V
25915.4	50.4	---	74.0	23.6	V
25915.9	---	38.5	54.0	15.5	V

Radiated Spurious – CH7

Frequency	MaxPeak	Average	Limit	Margin	Polar
MHz	dB μ V/m	dB μ V/m	dB μ V/m	dB	---
2996.5	---	46.8	54.0	7.2	V
2996.5	59.8	---	74.0	14.2	H
17993.7	---	43.2	54.0	10.8	H
17993.7	55	---	74.0	19.0	H
26006.1	50.3	---	74.0	23.7	V
26008.4	---	38	54.0	16.0	V

Radiated Spurious – CH11

Frequency	MaxPeak	Average	Limit	Margin	Polar
MHz	dB μ V/m	dB μ V/m	dB μ V/m	dB	---
2978.0	---	46.8	54.0	7.2	H
2978.0	59.7	---	74.0	14.3	V
17798.9	51.9	---	74.0	22.1	V
17798.9	---	42.9	54.0	11.1	H
24920.4	---	37.1	54.0	16.9	V
24920.9	49.6	---	74.0	24.4	H

1 GHz – 26.5 GHz, 802.11n20, HT0, Chain A

Radiated Spurious – CH1

Frequency	MaxPeak	Average	Limit	Margin	Polar
MHz	dB μ V/m	dB μ V/m	dB μ V/m	dB	---
2969.0	---	46.8	54.0	7.2	V
2969.0	59.6	---	74.0	14.4	H
17470.3	54.3	---	74.0	19.7	H
17473.2	---	42.3	54.0	11.7	H
25852.6	50.5	---	74.0	23.5	V
25854.0	---	37.9	54.0	16.1	H

1 GHz – 26.5 GHz, 802.11n20, HT0, Chain B

Radiated Spurious – CH1

Frequency	MaxPeak	Average	Limit	Margin	Polar
MHz	dB μ V/m	dB μ V/m	dB μ V/m	dB	---
2997.5	---	46.7	54.0	7.3	V
2997.5	59.8	---	74.0	14.2	V
17781.0	54.9	---	74.0	19.1	H
17781.0	---	41.9	54.0	12.1	V
25245.8	49.8	---	74.0	24.2	V
25255.7	---	38.1	54.0	15.9	V

1 GHz – 26.5 GHz, 802.11n20, HT0, Chain A+B

Radiated Spurious – CH1

Frequency	MaxPeak	Average	Limit	Margin	Polar
MHz	dB μ V/m	dB μ V/m	dB μ V/m	dB	---
3104.4	49.7	---	74.0	24.3	H
3105.6	---	40.3	54.0	13.7	H
4823.4	---	42	54.0	12.0	V
4825.6	52.7	---	74.0	21.3	H
17917.8	55.9	---	74.0	18.1	H
17917.8	---	43.3	54.0	10.7	H
25960.7	---	38.3	54.0	15.7	V
26000.4	49.6	---	74.0	24.4	V

1 GHz – 26.5 GHz, 802.11ax20, HE0, Chain A

Radiated Spurious – CH1

Frequency	MaxPeak	Average	Limit	Margin	Polar
MHz	dB μ V/m	dB μ V/m	dB μ V/m	dB	---
2956.0	---	47.1	54.0	6.9	V
2956.0	59.8	---	74.0	14.2	V
7210.6	46.2	---	74.0	27.8	H
7210.6	---	38	54.0	16.0	V
25948.0	50.2	---	74.0	23.8	V
25949.4	---	38.2	54.0	15.8	V

Radiated Spurious – CH7

Frequency	MaxPeak	Average	Limit	Margin	Polar
MHz	dB μ V/m	dB μ V/m	dB μ V/m	dB	---
4866.6	---	42.3	54.0	11.7	V
4866.6	51.5	---	74.0	22.5	V
7300.9	46.8	---	74.0	27.2	H
7300.9	---	37.9	54.0	16.1	H
25929.6	---	38.4	54.0	15.6	V
25935.7	50.3	---	74.0	23.7	V

Radiated Spurious – CH11

Frequency	MaxPeak	Average	Limit	Margin	Polar
MHz	dB μ V/m	dB μ V/m	dB μ V/m	dB	---
4907.6	52	---	74.0	22.0	H
4907.6	---	42	54.0	12.0	V
7360.4	45.9	---	74.0	28.1	V
7360.4	---	36.6	54.0	17.4	H
25900.3	50	---	74.0	24.0	H
25902.6	---	38	54.0	16.0	V

1 GHz – 26.5 GHz, 802.11ax20, HE0, Chain B

Radiated Spurious – CH1

Frequency	MaxPeak	Average	Limit	Margin	Polar
MHz	dB μ V/m	dB μ V/m	dB μ V/m	dB	---
2940.0	---	47.1	54.0	6.9	H
2940.5	59.5	---	74.0	14.5	H
7210.6	47.2	---	74.0	26.8	V
7211.0	---	36.1	54.0	17.9	H
25941.4	---	38	54.0	16.0	H
25941.4	49.6	---	74.0	24.4	V

Radiated Spurious – CH7

Frequency	MaxPeak	Average	Limit	Margin	Polar
MHz	dB μ V/m	dB μ V/m	dB μ V/m	dB	---
2983.0	---	47.1	54.0	6.9	H
2983.0	60.1	---	74.0	13.9	H
7300.4	47.7	---	74.0	26.3	V
7300.4	---	37.3	54.0	16.7	H
25956.9	50	---	74.0	24.0	V
25958.8	---	37.9	54.0	16.1	V

Radiated Spurious – CH11

Frequency	MaxPeak	Average	Limit	Margin	Polar
MHz	dB μ V/m	dB μ V/m	dB μ V/m	dB	---
2983.5	---	46.9	54.0	7.1	H
2983.5	59.9	---	74.0	14.1	H
17985.5	---	44.5	54.0	9.5	V
17985.5	56.4	---	74.0	17.6	H
26248.8	50	---	74.0	24.0	V
26250.7	---	37.3	54.0	16.7	V

1 GHz – 26.5 GHz, 802.11ax20, HE0, Chain A+B

Radiated Spurious – CH1

Frequency	MaxPeak	Average	Limit	Margin	Polar
MHz	dB μ V/m	dB μ V/m	dB μ V/m	dB	---
2993.0	---	46.8	54.0	7.2	V
2993.0	59.5	---	74.0	14.5	H
7209.6	49.1	---	74.0	24.9	V
7210.1	---	38.3	54.0	15.7	H
25907.4	50.1	---	74.0	23.9	V
25908.8	---	38.4	54.0	15.6	H

1 GHz – 26.5 GHz, 802.11n40, HT0, Chain A

Radiated Spurious – CH9F

Frequency	MaxPeak	Average	Limit	Margin	Polar
MHz	dB μ V/m	dB μ V/m	dB μ V/m	dB	---
2970.0	59.4	---	74.0	14.6	V
2972.5	---	46.8	54.0	7.2	H
17804.2	---	43	54.0	11.0	V
17804.2	54.9	---	74.0	19.1	H
25944.2	49.9	---	74.0	24.1	H
25950.8	---	38.4	54.0	15.6	H

1 GHz – 26.5 GHz, 802.11n40, HT0, Chain B

Radiated Spurious – CH9F

Frequency	MaxPeak	Average	Limit	Margin	Polar
MHz	dBµV/m	dBµV/m	dBµV/m	dB	---
3154.7	50.1	---	74.0	23.9	H
3156.6	---	39.8	54.0	14.2	H
17904.8	---	42.1	54.0	11.9	V
17904.8	54.9	---	74.0	19.1	V
24236.2	49.5	---	74.0	24.5	V
24243.2	---	38.1	54.0	15.9	H

1 GHz – 26.5 GHz, 802.11n40, HT0, Chain A+B

Radiated Spurious – CH9F

Frequency	MaxPeak	Average	Limit	Margin	Polar
MHz	dBµV/m	dBµV/m	dBµV/m	dB	---
2948.0	59.9	---	74.0	14.1	V
2957.5	---	47.1	54.0	6.9	H
17909.6	---	43.2	54.0	10.8	H
17909.6	55.9	---	74.0	18.1	V
25918.7	49.8	---	74.0	24.2	V
25931.9	---	38.3	54.0	15.7	H

1 GHz – 26.5 GHz, 802.11ax40, HE0, Chain A

Radiated Spurious – CH3F

Frequency	MaxPeak	Average	Limit	Margin	Polar
MHz	dBµV/m	dBµV/m	dBµV/m	dB	---
2980.0	59.5	---	74.0	14.5	V
2983.5	---	47	54.0	7.0	H
7211.0	48.5	---	74.0	25.5	H
7212.0	---	38.3	54.0	15.7	H
25852.6	49.7	---	74.0	24.3	V
25863.9	---	38.3	54.0	15.7	H

Radiated Spurious – CH6F

Frequency	MaxPeak	Average	Limit	Margin	Polar
MHz	dB μ V/m	dB μ V/m	dB μ V/m	dB	---
4837.7	---	42.2	54.0	11.8	V
4837.7	52.5	---	74.0	21.5	V
7256.5	---	38.9	54.0	15.1	H
7256.5	48.5	---	74.0	25.5	V
25927.7	49.9	---	74.0	24.1	H
25928.1	---	37.9	54.0	16.1	V

Radiated Spurious – CH9F

Frequency	MaxPeak	Average	Limit	Margin	Polar
MHz	dB μ V/m	dB μ V/m	dB μ V/m	dB	---
4868.1	51.7	---	74.0	22.3	V
4868.1	---	42	54.0	12.0	V
7301.9	48.5	---	74.0	25.5	H
7301.9	---	38.2	54.0	15.8	H
25962.6	50.1	---	74.0	23.9	H
25965.9	---	38.2	54.0	15.8	V

1 GHz – 26.5 GHz, 802.11ax40, HE0, Chain B

Radiated Spurious – CH3F

Frequency	MaxPeak	Average	Limit	Margin	Polar
MHz	dB μ V/m	dB μ V/m	dB μ V/m	dB	---
2984.0	58.9	---	74.0	15.1	V
2985.5	---	46.7	54.0	7.3	V
7211.5	47	---	74.0	27.0	H
7212.0	---	37	54.0	17.0	H
24886.4	49	---	74.0	25.0	V
24898.2	---	37.8	54.0	16.2	H

Radiated Spurious – CH6F

Frequency	MaxPeak	Average	Limit	Margin	Polar
MHz	dB μ V/m	dB μ V/m	dB μ V/m	dB	---
4715.1	---	41.3	54.0	12.7	V
4715.3	51.1	---	74.0	22.9	H
7256.9	46.5	---	74.0	27.5	V
7256.9	---	37.2	54.0	16.8	H
25835.1	50.1	---	74.0	23.9	H
25837.0	---	37.8	54.0	16.2	H

Radiated Spurious – CH9F

Frequency	MaxPeak	Average	Limit	Margin	Polar
MHz	dB μ V/m	dB μ V/m	dB μ V/m	dB	---
2971.0	60.1	---	74.0	13.9	H
2972.5	---	47.1	54.0	6.9	V
7302.4	45.8	---	74.0	28.2	H
7302.4	---	37.4	54.0	16.6	H
25906.9	49.9	---	74.0	24.1	H
25908.3	---	38.3	54.0	15.7	V

1 GHz – 26.5 GHz, 802.11ax40, HE0, Chain A+B

Radiated Spurious – CH9F

Frequency	MaxPeak	Average	Limit	Margin	Polar
MHz	dB μ V/m	dB μ V/m	dB μ V/m	dB	---
4867.6	---	42.2	54.0	11.8	V
4867.6	52.1	---	74.0	21.9	V
7302.4	48.1	---	74.0	25.9	H
7302.4	---	38.6	54.0	15.4	H
25892.7	49.5	---	74.0	24.5	V
25895.1	---	37.9	54.0	16.1	H

B.2.6 Test Results Screenshot

B.2.7 Out of band emissions - band-edge Low ans High (conducted)

SISO-A

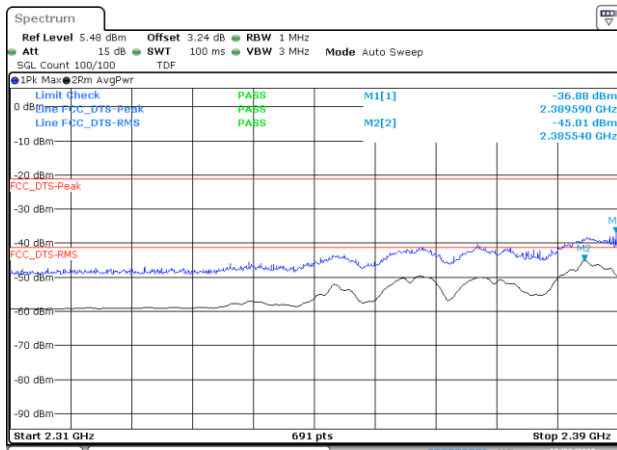

Date: 3 DEC 2020 15:47:09

BE-R-LOW, SISO-A, 802.11b-1Mbps, Ch1

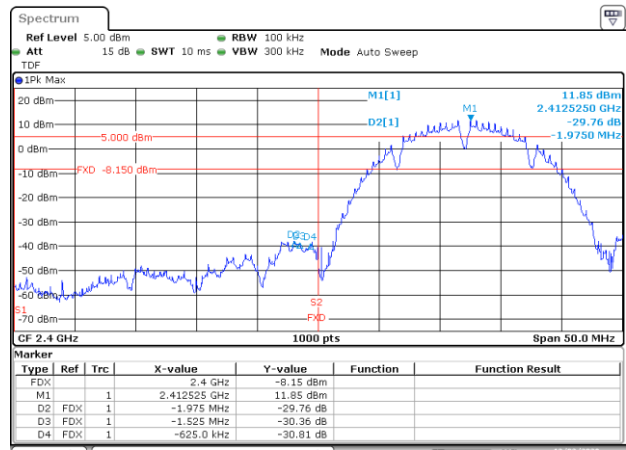

Date: 3 DEC 2020 15:47:15

BE-NR, SISO-A, 802.11b-1Mbps, Ch1



Date: 3 DEC 2020 15:49:20

BE-R-HIGH, SISO-A, 802.11b-1Mbps, Ch11

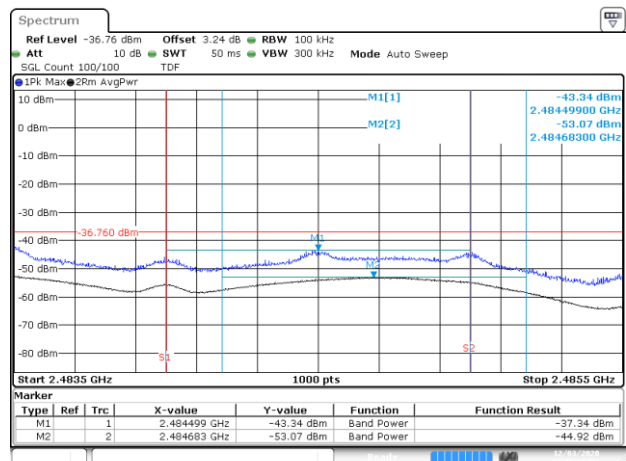

Date: 3 DEC 2020 15:49:26

BE-R-HIGH-2MHz, SISO-A, 802.11b-1Mbps, Ch11

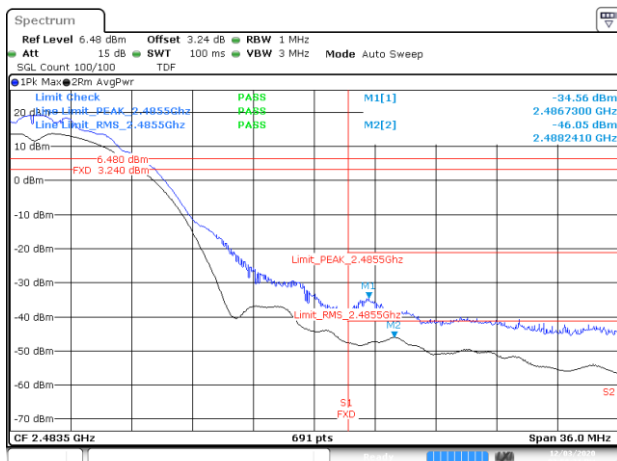

Date: 3 DEC 2020 15:50:32

BE-R-HIGH, SISO-A, 802.11b-1Mbps, Ch12

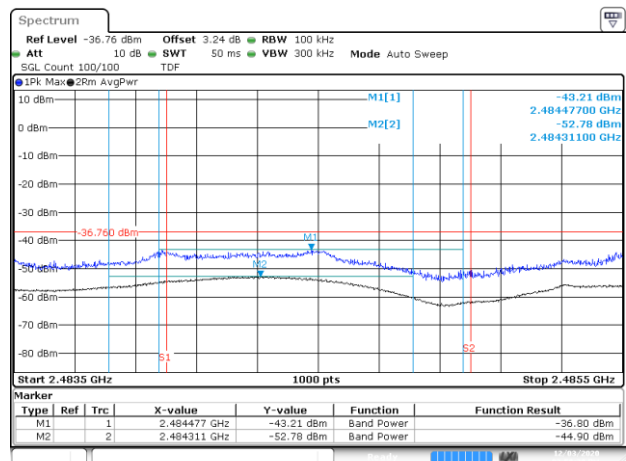

Date: 3 DEC 2020 15:50:38

BE-R-HIGH-2MHz, SISO-A, 802.11b-1Mbps, Ch12



Date: 3 DEC 2020 16:32:13

BE-R-HIGH, SISO-A, 802.11b-1Mbps, Ch13

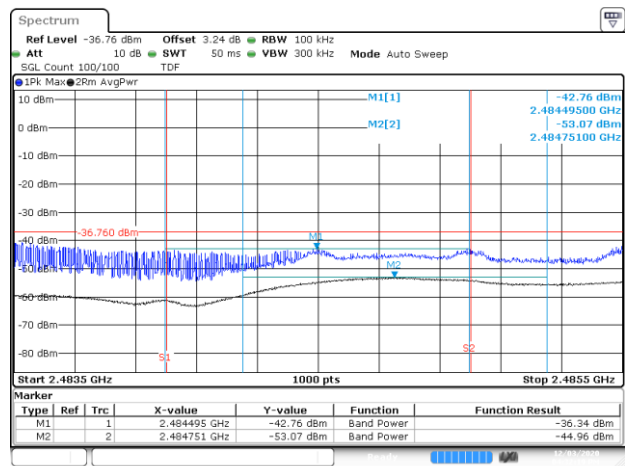

Date: 3 DEC 2020 16:32:19

BE-R-HIGH-2MHz, SISO-A, 802.11b-1Mbps, Ch13

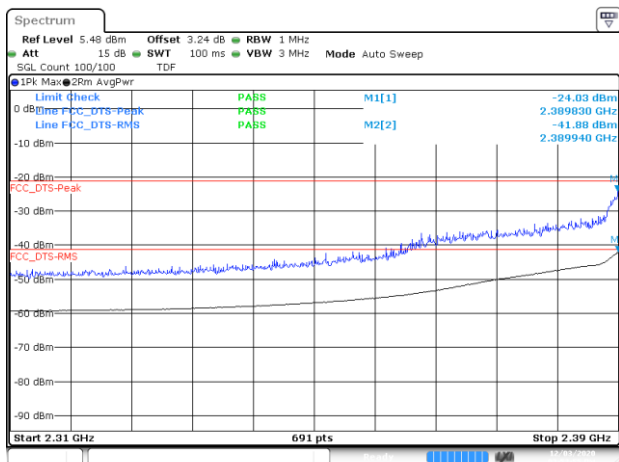

Date: 3 DEC 2020 15:52:55

BE-R-LOW, SISO-A, 802.11g-6Mbps, Ch1

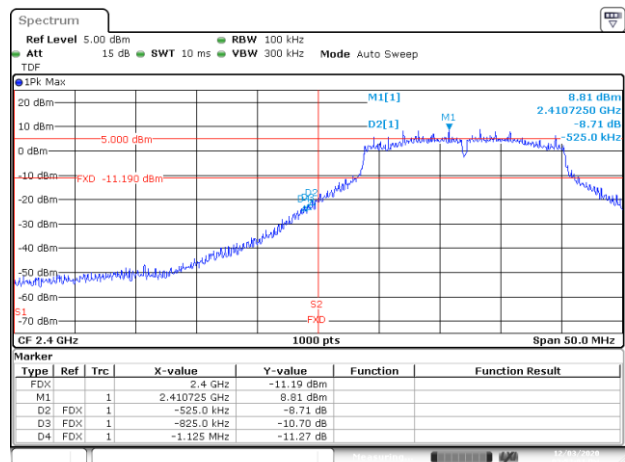

Date: 3 DEC 2020 15:53:01

BE-NR, SISO-A, 802.11g-6Mbps, Ch1

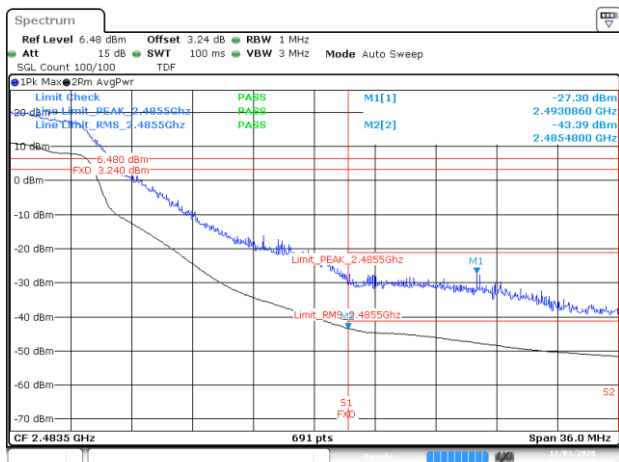

Date: 3 DEC 2020 15:55:07

BE-R-HIGH, SISO-A, 802.11g-6Mbps, Ch11

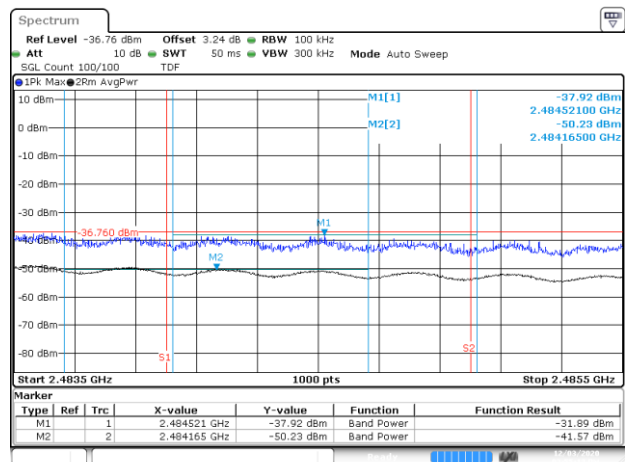

Date: 3 DEC 2020 15:55:13

BE-R-HIGH-2MHz, SISO-A, 802.11g-6Mbps, Ch11

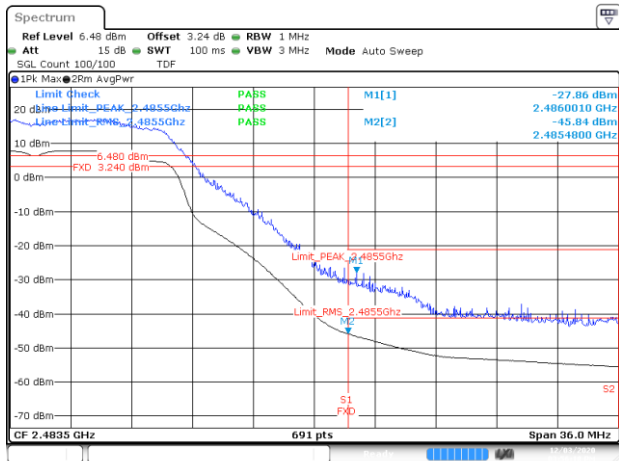

Date: 3 DEC 2020 15:59:19

BE-R-HIGH, SISO-A, 802.11g-6Mbps, Ch12

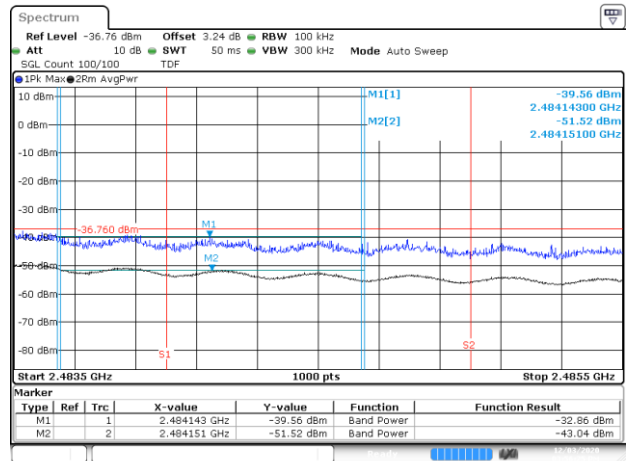

Date: 3 DEC 2020 15:59:25

BE-R-HIGH-2MHz, SISO-A, 802.11g-6Mbps, Ch12

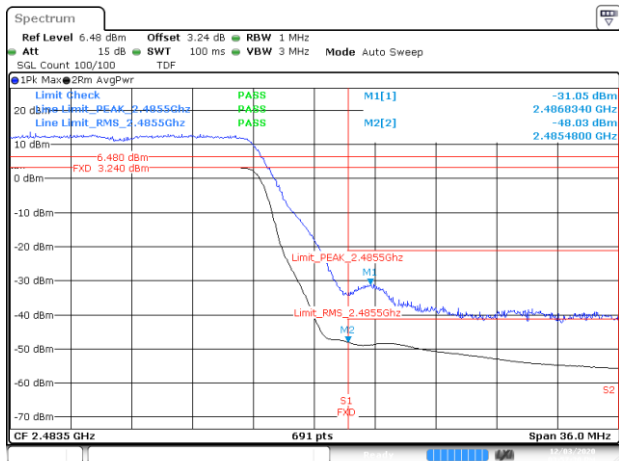

Date: 3 DEC 2020 15:57:30

BE-R-HIGH, SISO-A, 802.11g-6Mbps, Ch13

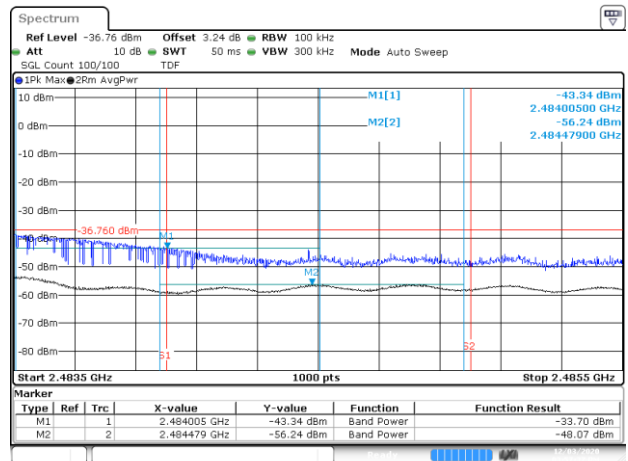

Date: 3 DEC 2020 15:57:37

BE-R-HIGH-2MHz, SISO-A, 802.11g-6Mbps, Ch13

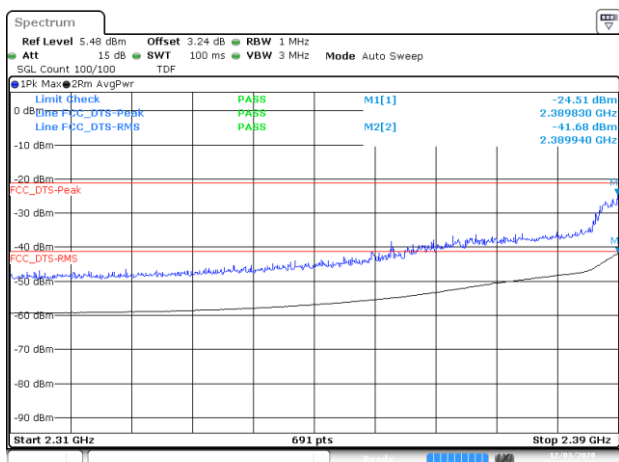

Date: 3 DEC 2020 15:59:43

BE-R-LOW, SISO-A, 802.11n20-HT0, Ch1

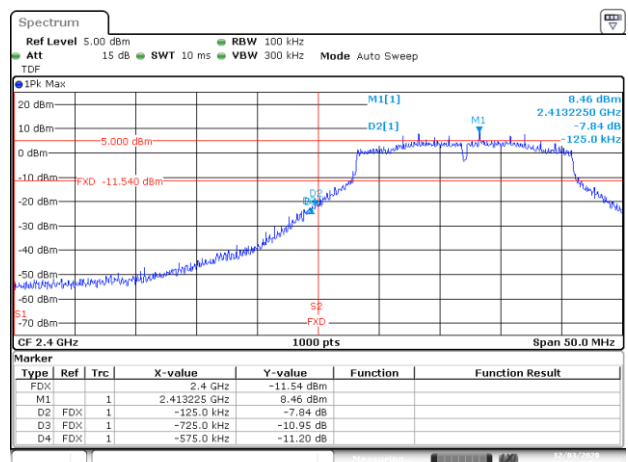

Date: 3 DEC 2020 15:59:49

BE-NR, SISO-A, 802.11n20-HT0, Ch1

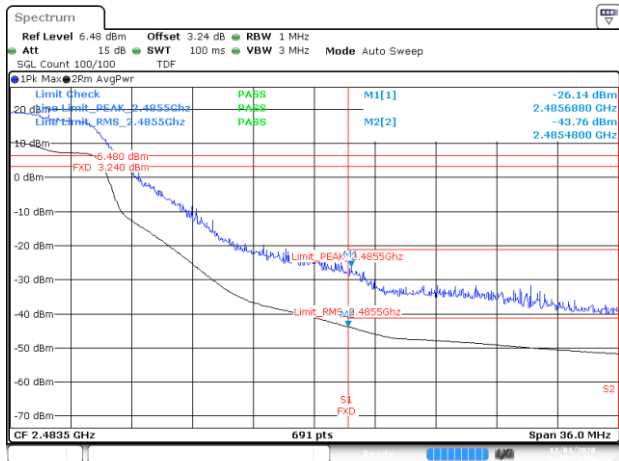

Date: 3 DEC 2020 16:00:54

BE-R-HIGH, SISO-A, 802.11n20-HT0, Ch11

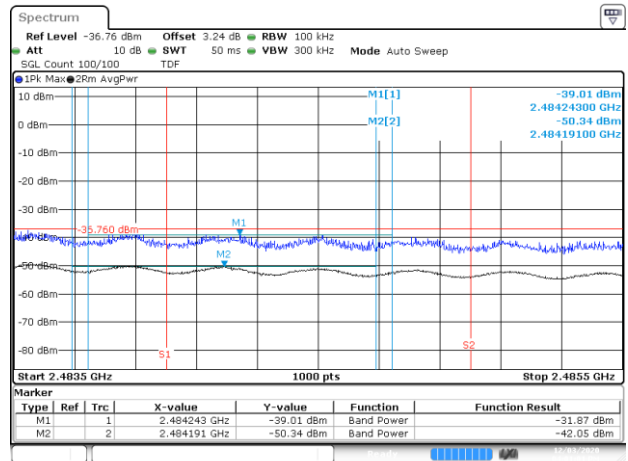

Date: 3 DEC 2020 16:01:01

BE-R-HIGH-2MHz, SISO-A, 802.11n20-HT0, Ch11

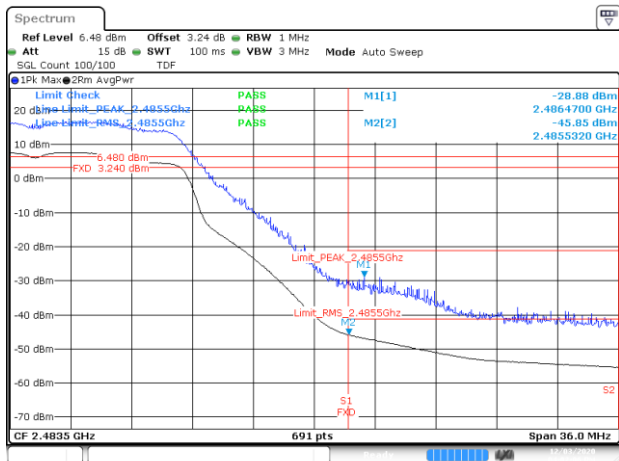

Date: 3 DEC 2020 16:02:05

BE-R-HIGH, SISO-A, 802.11n20-HT0, Ch12

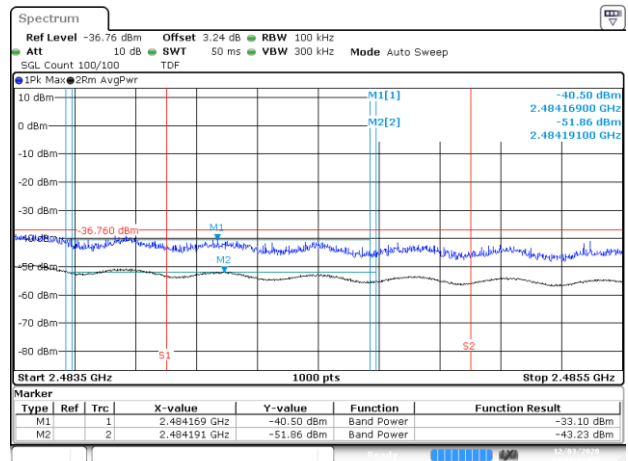

Date: 3 DEC 2020 16:02:12

BE-R-HIGH-2MHz, SISO-A, 802.11n20-HT0, Ch12

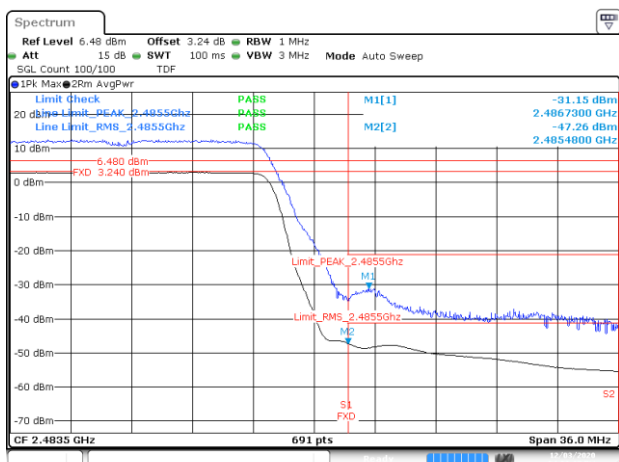

Date: 3 DEC 2020 16:03:17

BE-R-HIGH, SISO-A, 802.11n20-HT0, Ch13

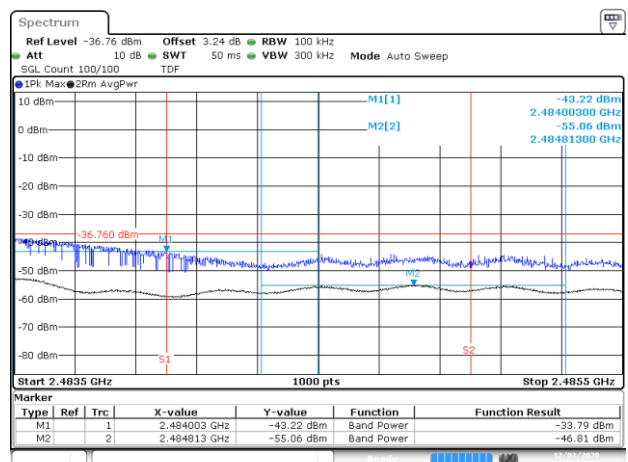

Date: 3 DEC 2020 16:03:24

BE-R-HIGH-2MHz, SISO-A, 802.11n20-HT0, Ch13

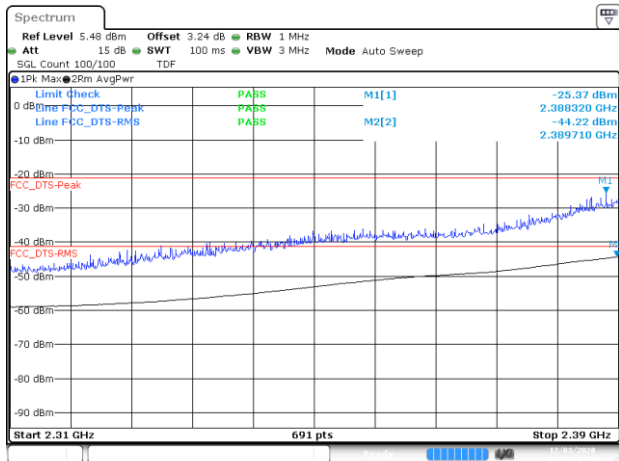

Date: 3 DEC 2020 16:04:28

BE-R-LOW, SISO-A, 802.11n40-HT0, Ch3

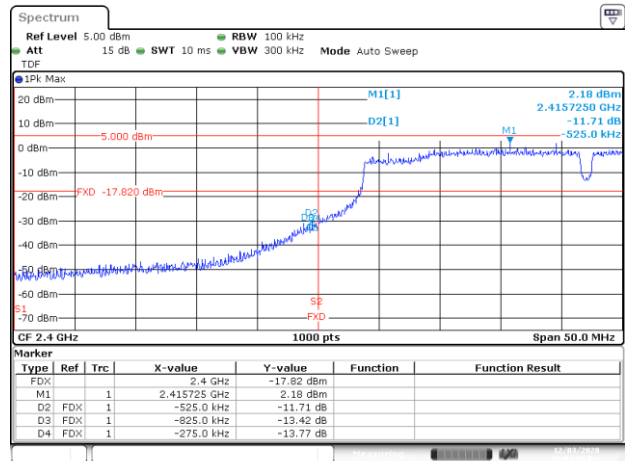

Date: 3 DEC 2020 16:04:35

BE-NR, SISO-A, 802.11n40-HT0, Ch3

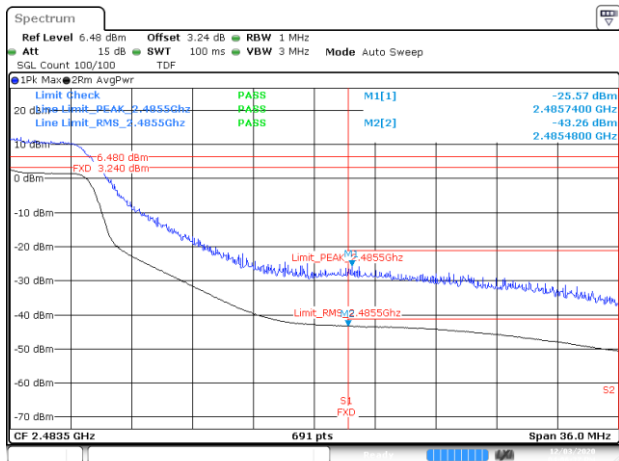

Date: 3 DEC 2020 16:03:38

BE-R-HIGH, SISO-A, 802.11n40-HT0, Ch9

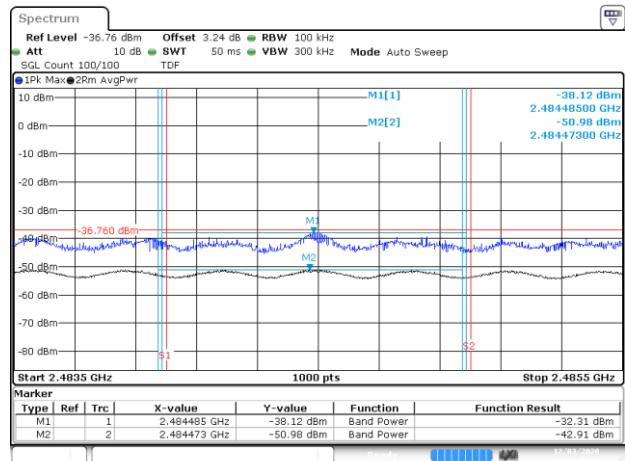

Date: 3 DEC 2020 16:03:44

BE-R-HIGH-2MHz, SISO-A, 802.11n40-HT0, Ch9

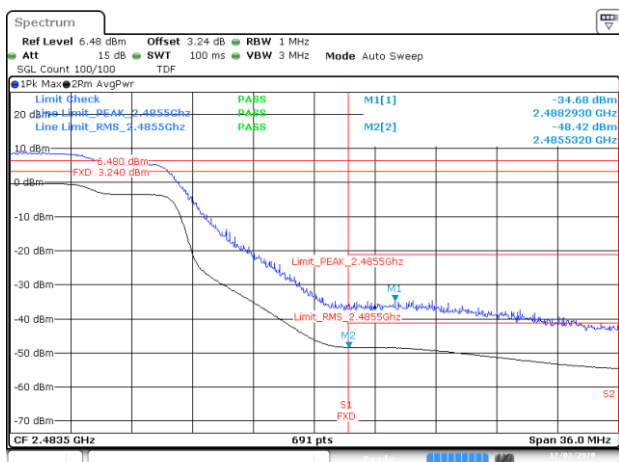

Date: 3 DEC 2020 16:07:48

BE-R-HIGH, SISO-A, 802.11n40-HT0, Ch10

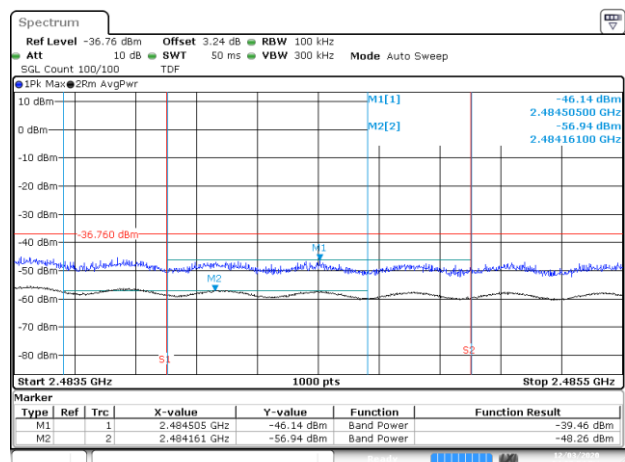

Date: 3 DEC 2020 16:07:55

BE-R-HIGH-2MHz, SISO-A, 802.11n40-HT0, Ch10

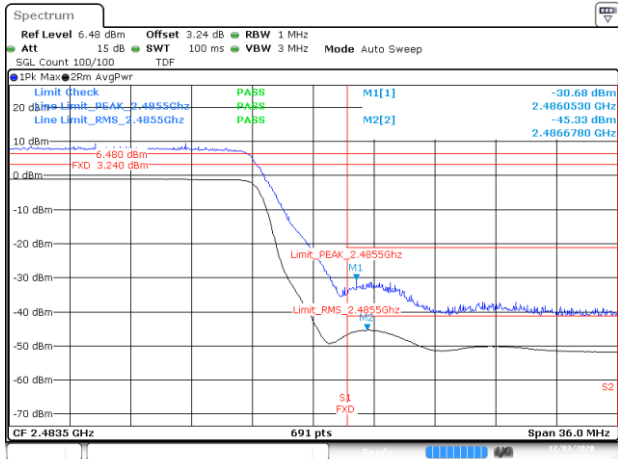

Date: 3 DEC 2010 16:09:59

BE-R-HIGH, SISO-A, 802.11n40-HT0, Ch11

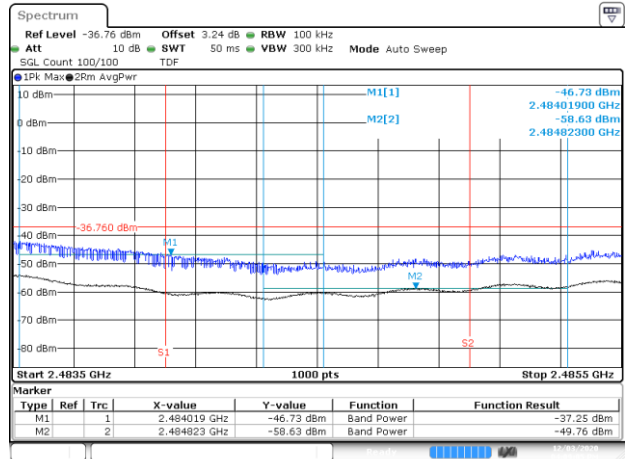

Date: 3 DEC 2010 16:09:05

BE-R-HIGH-2MHz, SISO-A, 802.11n40-HT0, Ch11

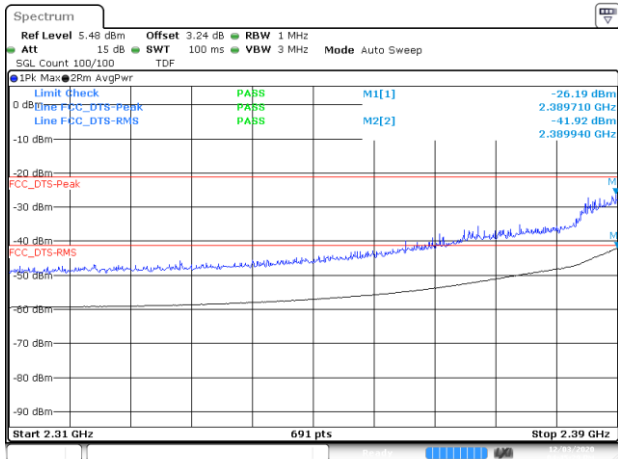

Date: 3 DEC 2010 16:45:29

BE-R-LOW, SISO-A, 802.11ax20-HE0, Ch1

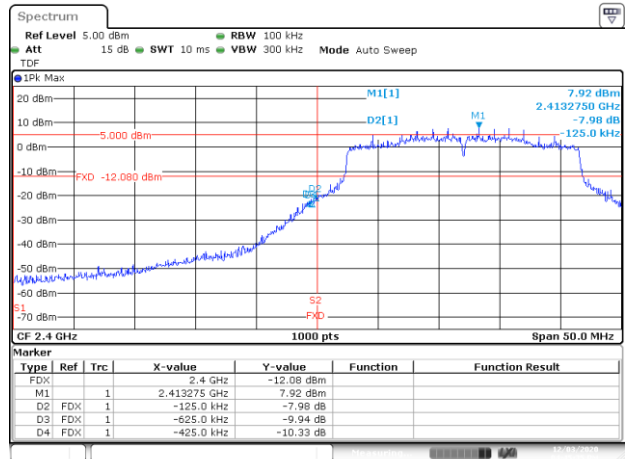

Date: 3 DEC 2010 16:45:36

BE-NR, SISO-A, 802.11ax20-HE0, Ch1

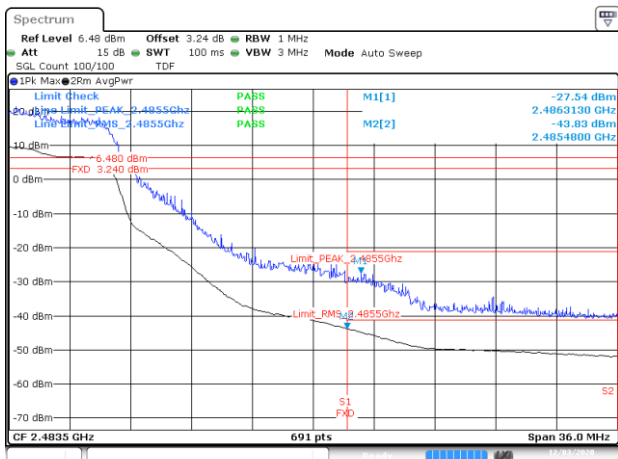

Date: 3 DEC 2010 16:15:25

BE-R-HIGH, SISO-A, 802.11ax20-HE0, Ch11

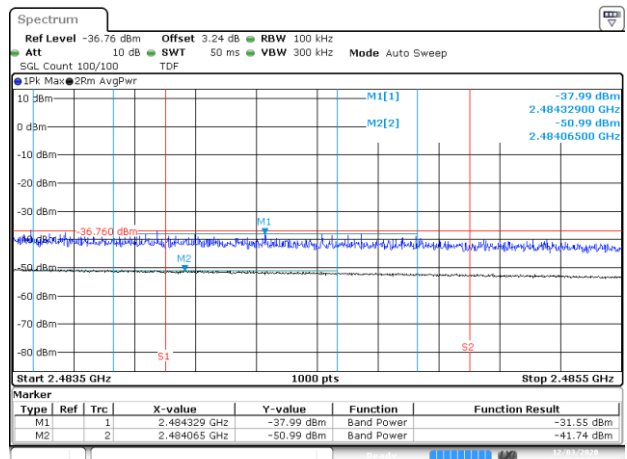

Date: 3 DEC 2010 16:15:32

BE-R-HIGH-2MHz, SISO-A, 802.11ax20-HE0, Ch11

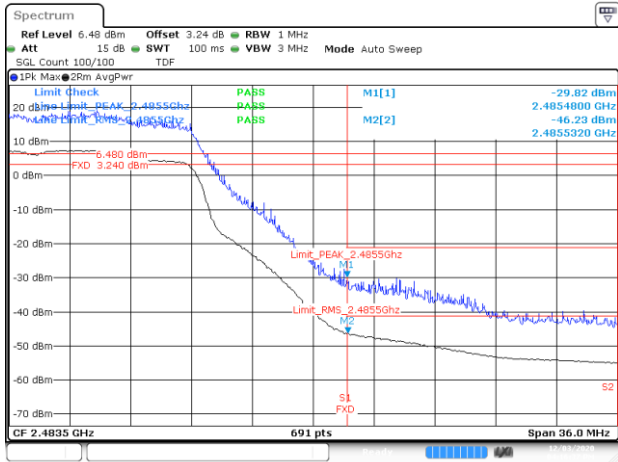

Date: 3 DEC 2020 16:16:37
 BE-R-HIGH, SISO-A, 802.11ax20-HE0, Ch12

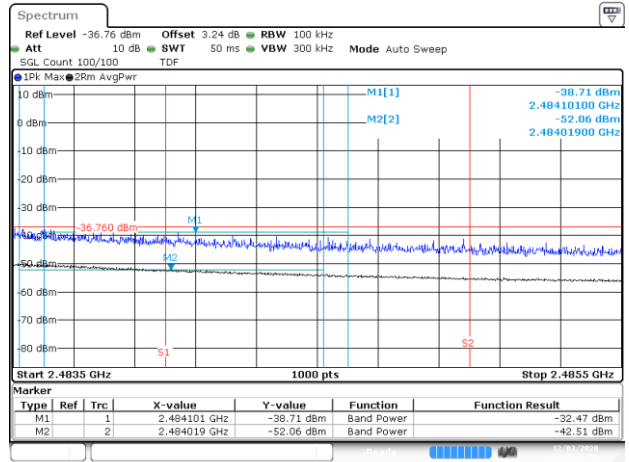

Date: 3 DEC 2020 16:16:43
 BE-R-HIGH-2MHz, SISO-A, 802.11ax20-HE0, Ch12

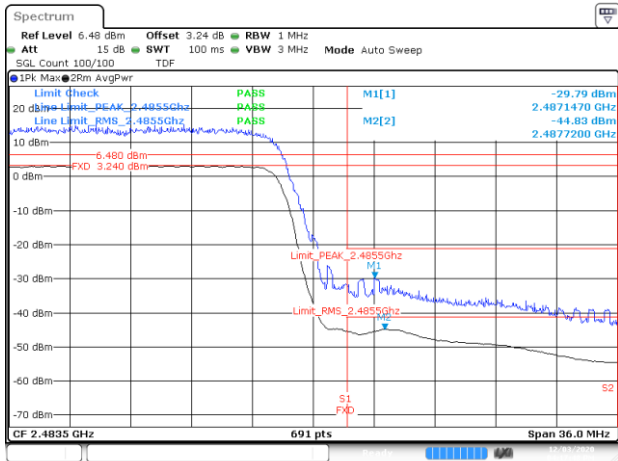

Date: 3 DEC 2020 16:17:46
 BE-R-HIGH, SISO-A, 802.11ax20-HE0, Ch13

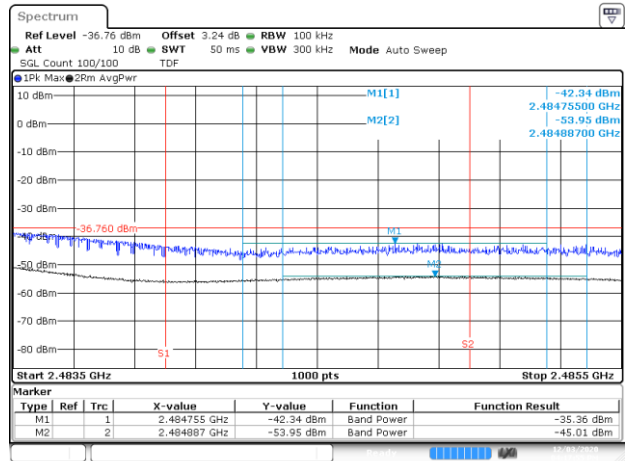

Date: 3 DEC 2020 16:17:55
 BE-R-HIGH-2MHz, SISO-A, 802.11ax20-HE0, Ch13

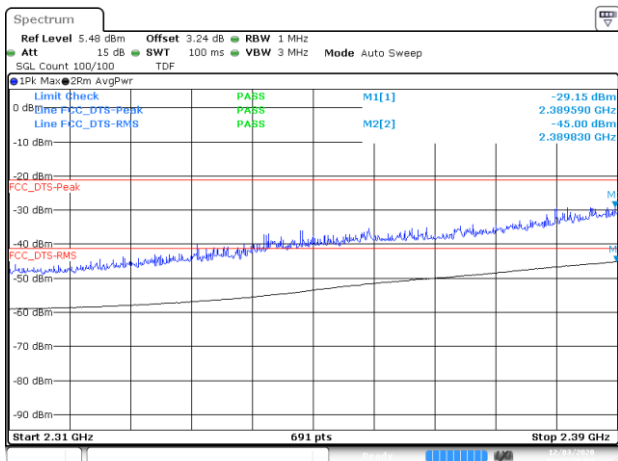

Date: 3 DEC 2020 16:22:33
 BE-R-LOW, SISO-A, 802.11ax40-HE0, Ch3

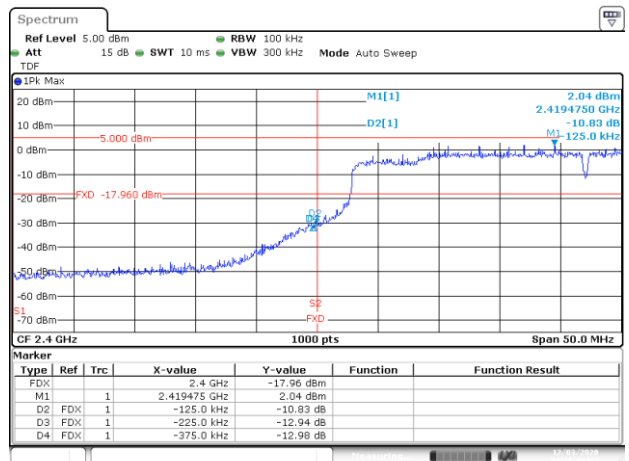

Date: 3 DEC 2020 16:22:42
 BE-NR, SISO-A, 802.11ax40-HE0, Ch3

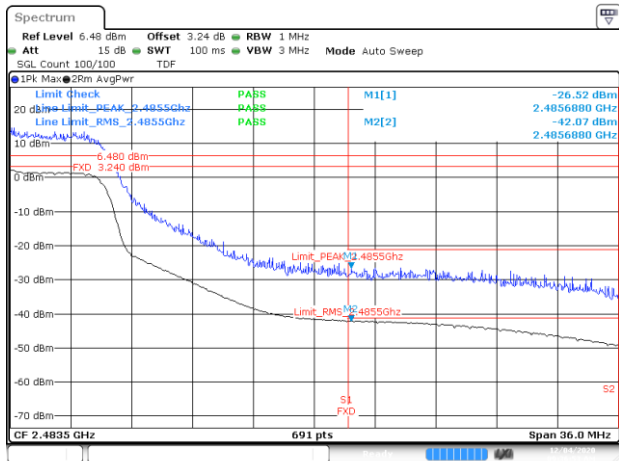

Date: 4 DEC 2020 09:39:53

BE-R-HIGH, SISO-A, 802.11ax40-HE0, Ch9

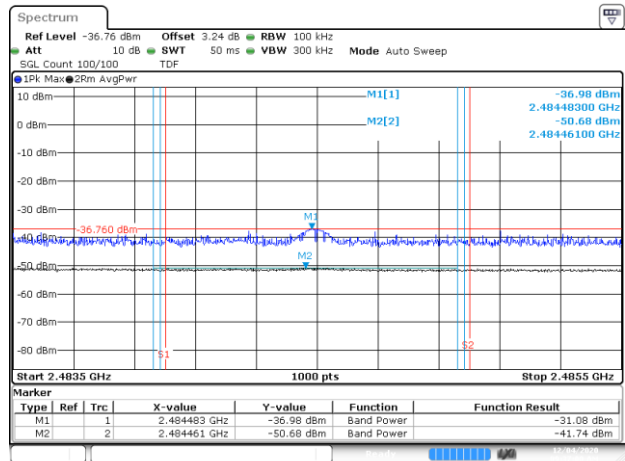

Date: 4 DEC 2020 09:37:00

BE-R-HIGH-2MHz, SISO-A, 802.11ax40-HE0, Ch9

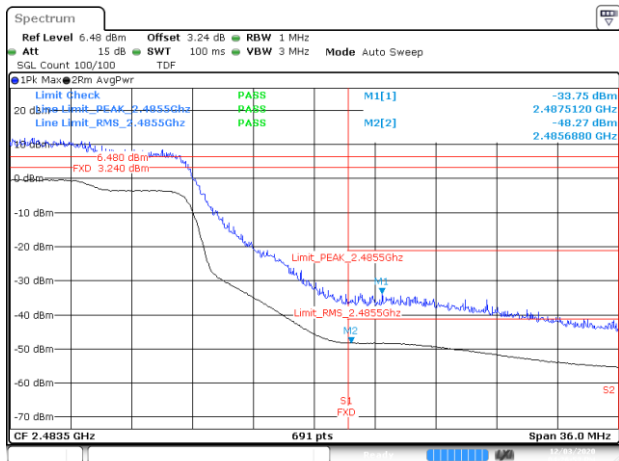

Date: 3 DEC 2020 18:29:54

BE-R-HIGH, SISO-A, 802.11ax40-HE0, Ch10

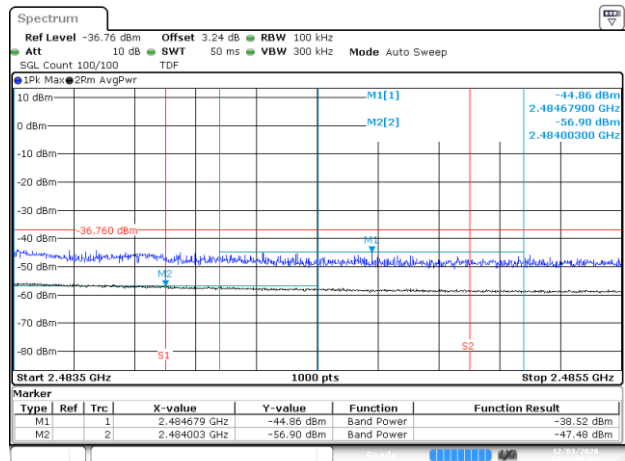

Date: 3 DEC 2020 18:27:00

BE-R-HIGH-2MHz, SISO-A, 802.11ax40-HE0, Ch10



Date: 3 DEC 2020 18:28:04

BE-R-HIGH, SISO-A, 802.11ax40-HE0, Ch11

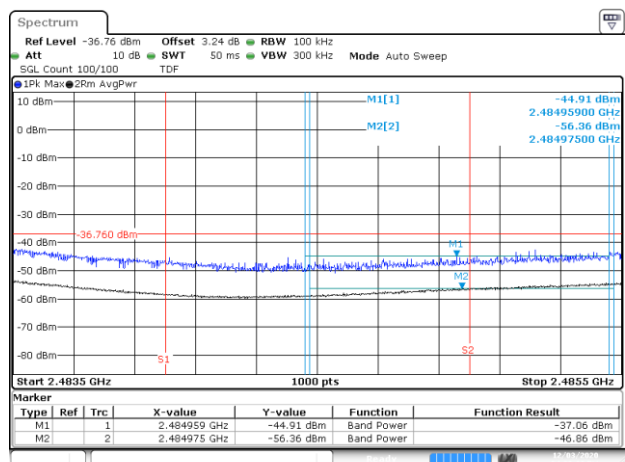

Date: 3 DEC 2020 18:28:11

BE-R-HIGH-2MHz, SISO-A, 802.11ax40-HE0, Ch11