



**Well Green Technology Co., Ltd**

**No. 20, Alley51 ,Lane 118,ShuangLian Sec.2,Mintzu Rd.,  
PingJen City, TaoYuan Hsien, Taiwan, R.O.C  
TEL: (03)420-6428 FAX: (03) 420-6418**

# **TWINHEAD E14A**

## **Antenna Test Report**

<b>RD Manager</b>	<b>Supervisor</b>	<b>RD engineer</b>	<b>Sales engineer</b>
<b>David</b>	<b>Johnson</b>	<b>Tim</b>	<b>Jerry</b>



Antenna Testing Conditions:

1. Testing set up:

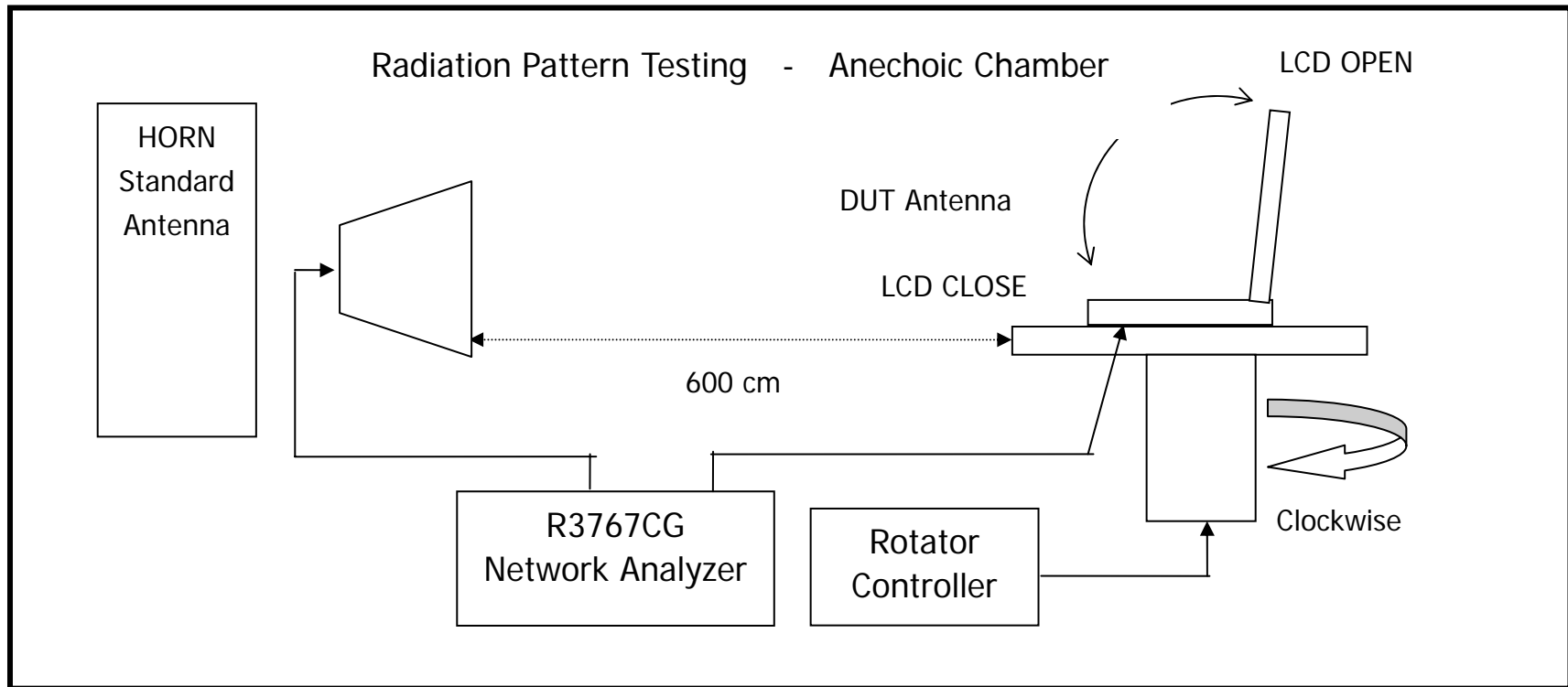



2. Mechanical dimensions

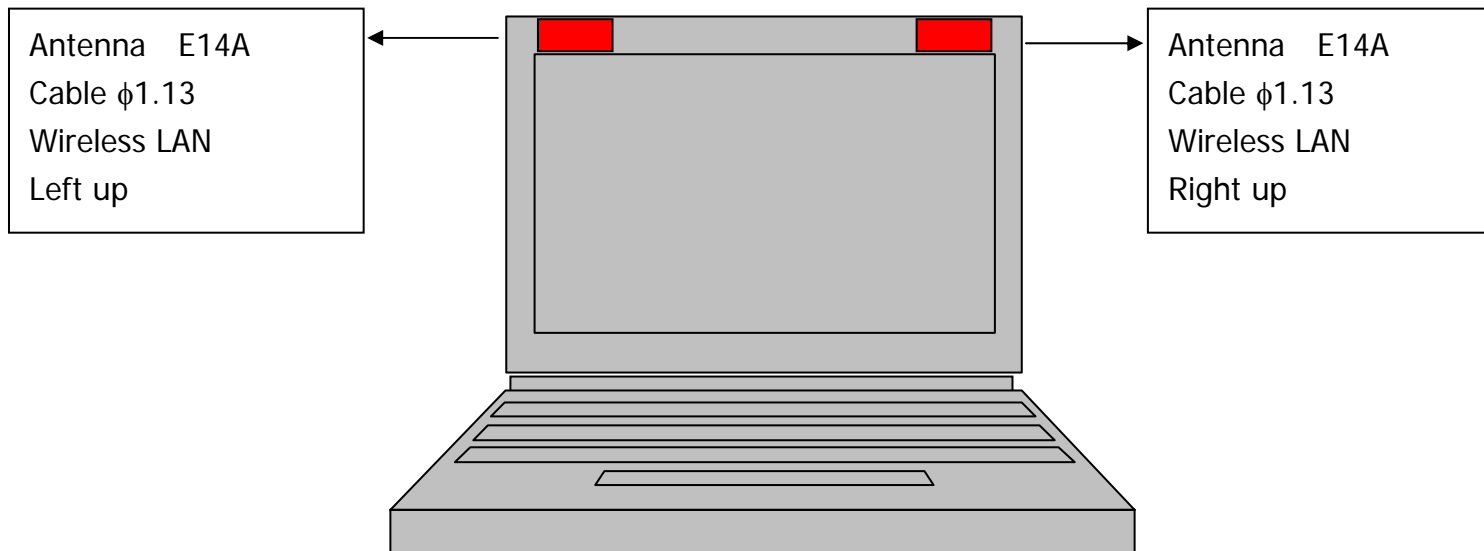



Test results-Left

Antenna	Application	Cable dia. Φ mm
E14A	Wireless	1.13

1.VSWR

Antenna	Center freg. @MHz	BW @MHz	VSWR		
			2.4GHz	2.45GHz	2.5GHz
E14A	2450		1.23	1.13	1.17





## 2. Return Loss

Antenna	Center freg. @MHz	BW @MHz	Return Loss		
			2.4GHz	2.45GHz	2.5GHz
E14A	2450		-19.62	-23.89	-22.81

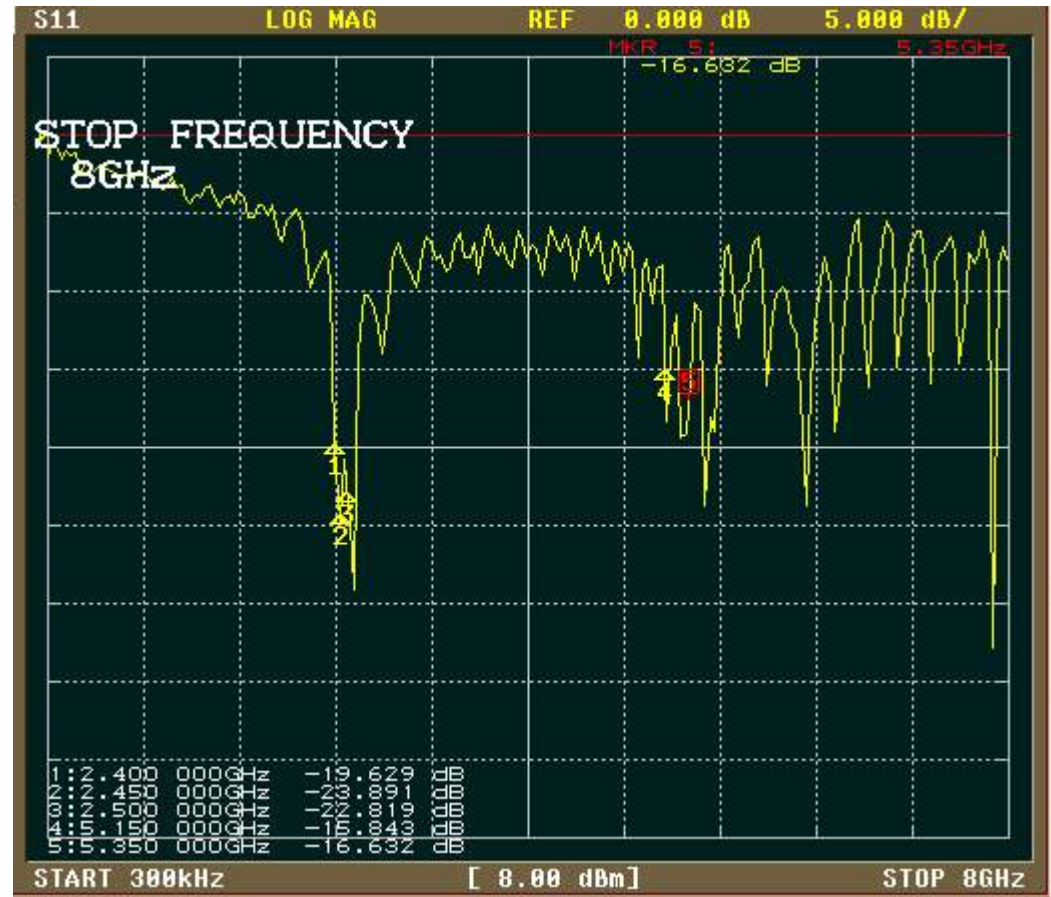



3. Smith Chart





4. Radiation Pattern of XY Plane (Azimuth)-2.414GHz

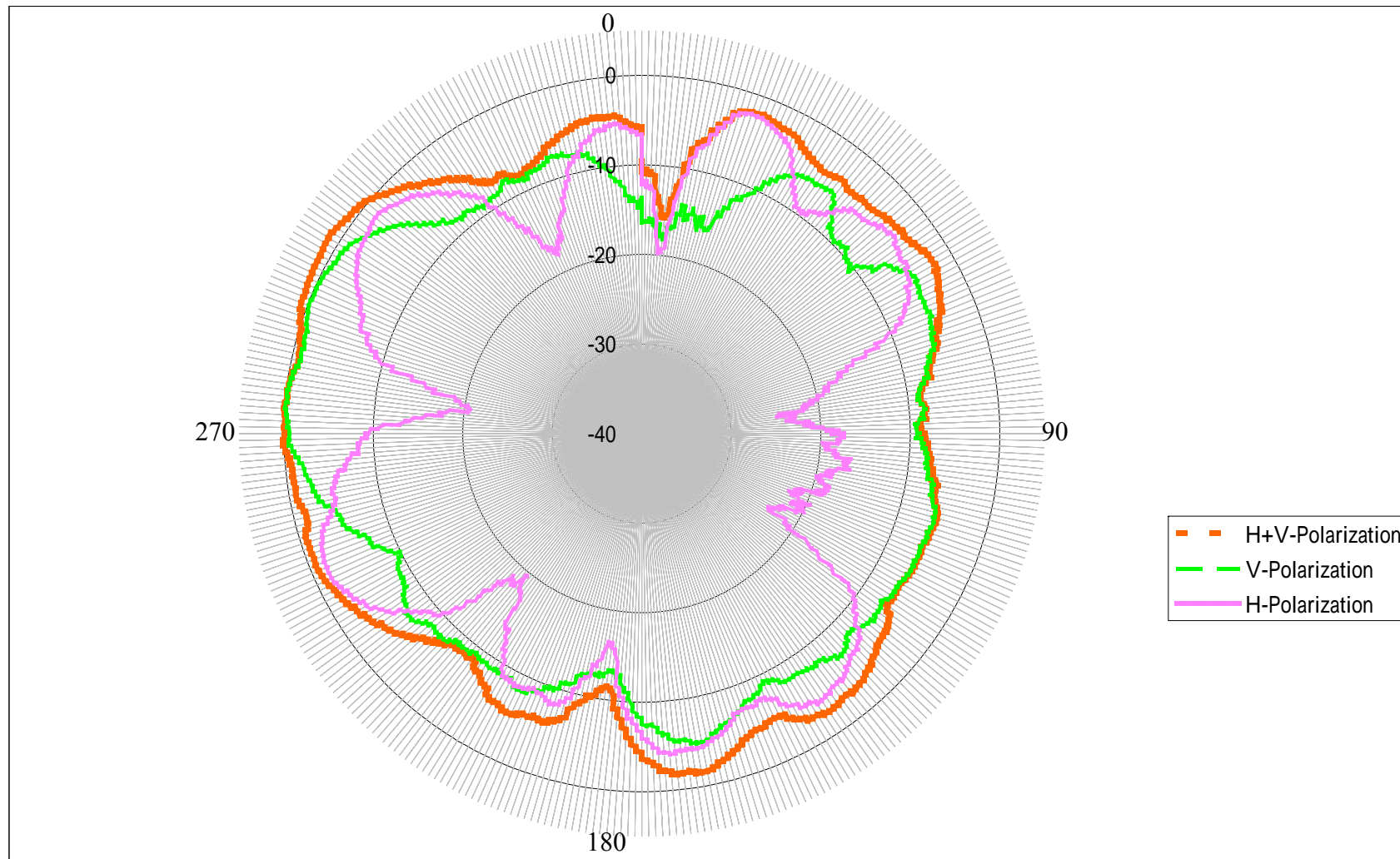



5. Radiation Pattern of XY Plane (Azimuth)-2.442GHz

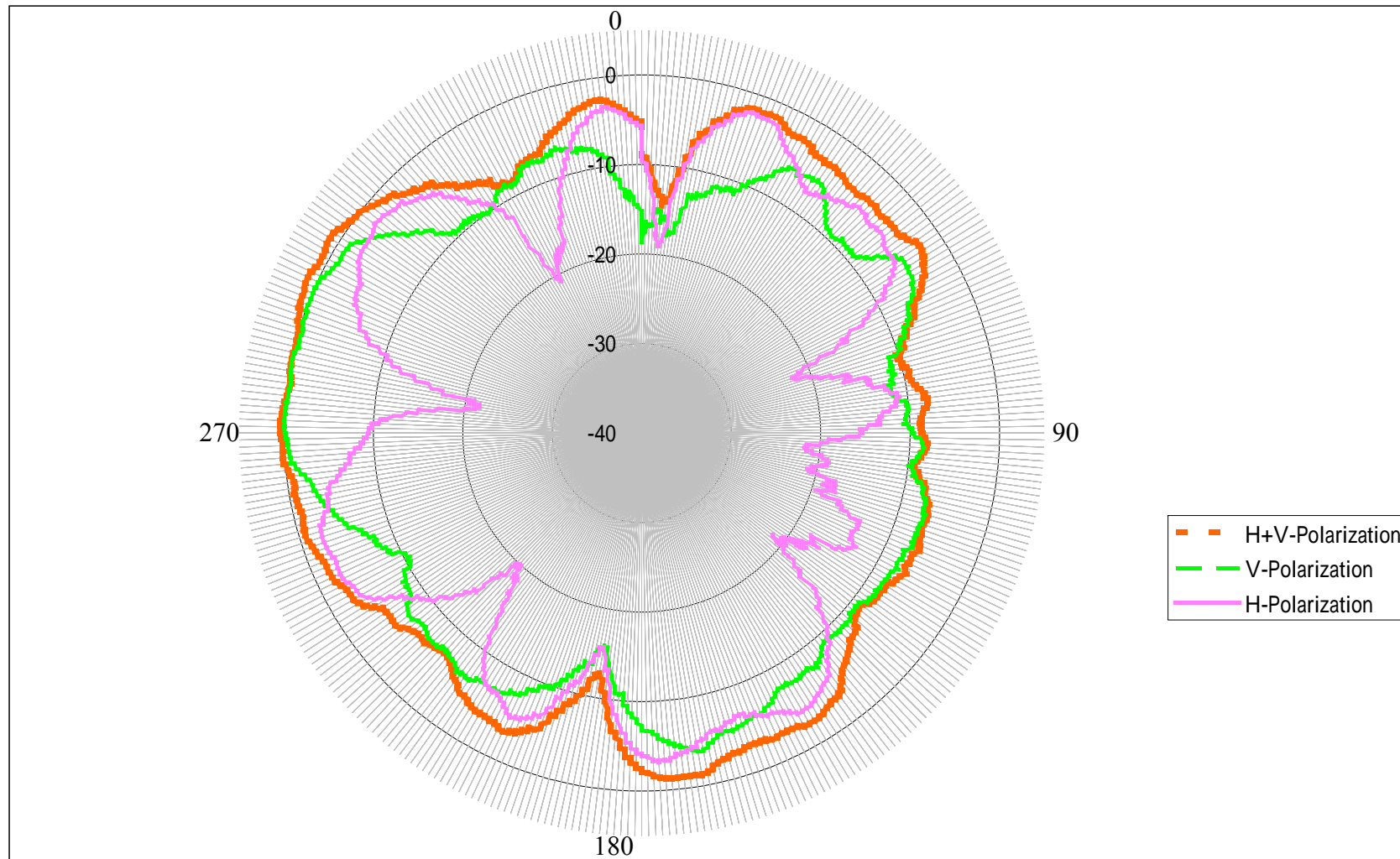





6. Radiation Pattern of XY Plane (Azimuth)-2.484GHz

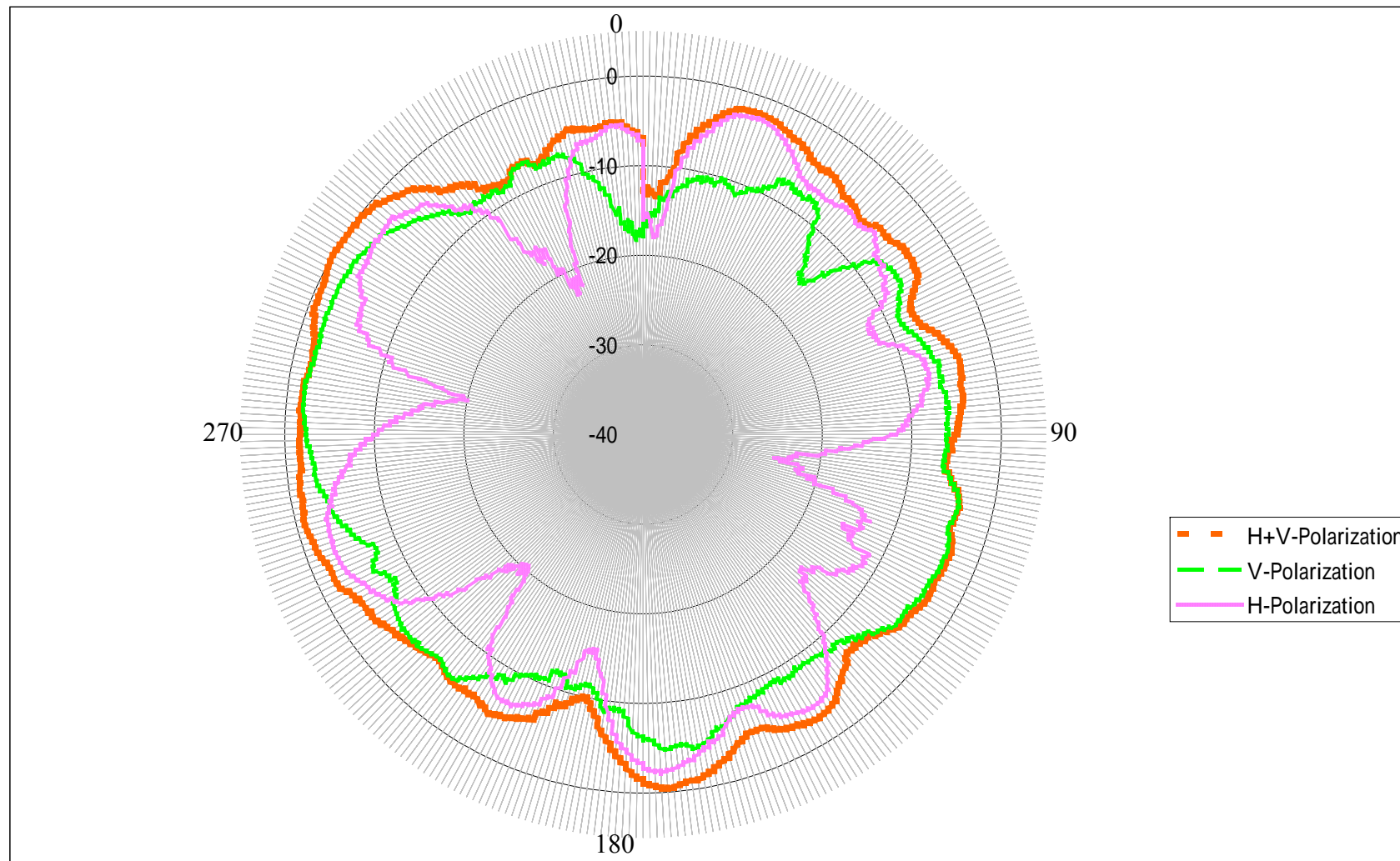



7. Peak Gain and Average Gain

Antenna	Gain Of XY Plane (Azimuth)		
	Polarization		2.414GHz-L
E14A	V	Peak	-0.01
		Average	-5.92
	H	Peak	-1.66
		Average	-6.83
	H+V	Peak	1.31
		Average	-3.34

Antenna	Gain Of XY Plane (Azimuth)		
	Polarization		2.442GHz-L
E14A	V	Peak	0.02
		Average	-5.92
	H	Peak	-2.02
		Average	-6.82
	H+V	Peak	1.20
		Average	-3.44

Antenna	Gain Of XY Plane (Azimuth)		
	Polarization		2.484GHz-L
E14A	V	Peak	-1.80
		Average	-6.11
	H	Peak	-2.15
		Average	-7.05
	H+V	Peak	0.03
		Average	-3.54



Test results-Right

Antenna	Application	Cable dia. Φ mm
E14A	Wireless	1.13

1.VSWR

Antenna	Center freg. @MHz	BW @MHz	VSWR		
			2.4GHz	2.45GHz	2.5GHz
E14A	2450		1.42	1.45	1.57





## 2. Return Loss

Antenna	Center freg. @MHz	BW @MHz	Return Loss		
			2.4GHz	2.45GHz	2.5GHz
E14A	2450		-15.06	-14.64	-12.95

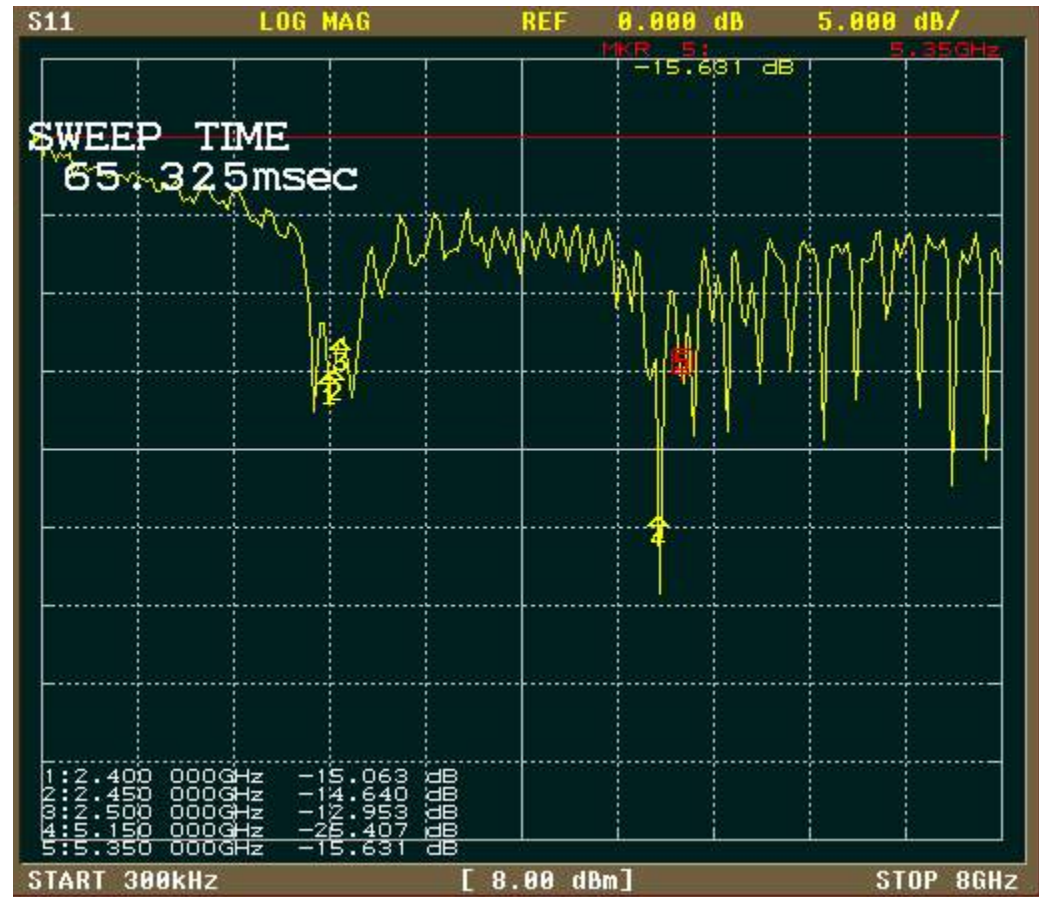



3. Smith Chart





#### 4. Radiation Pattern of XY Plane (Azimuth)-2.414GHz

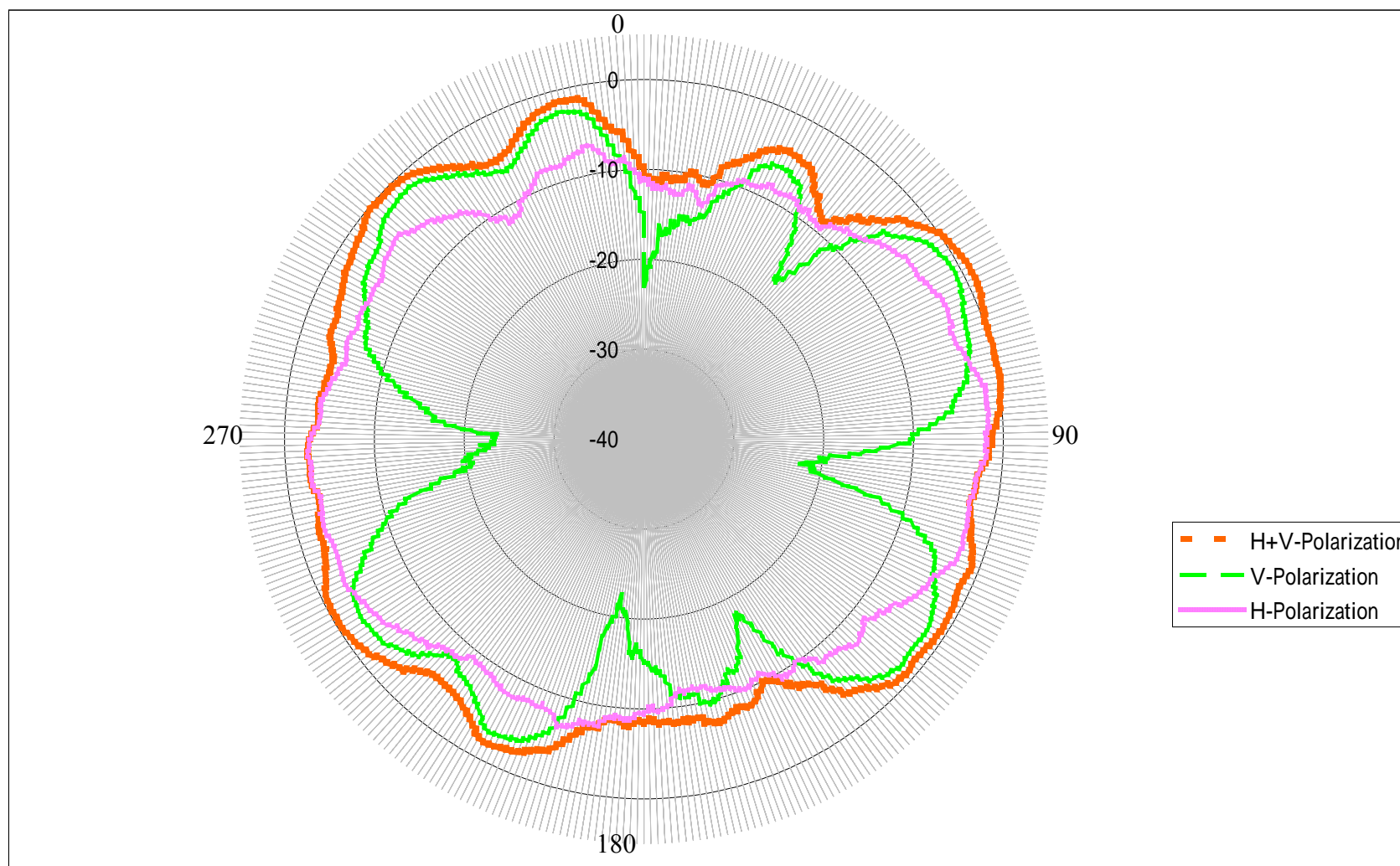



5. Radiation Pattern of XY Plane (Azimuth)-2.442GHz

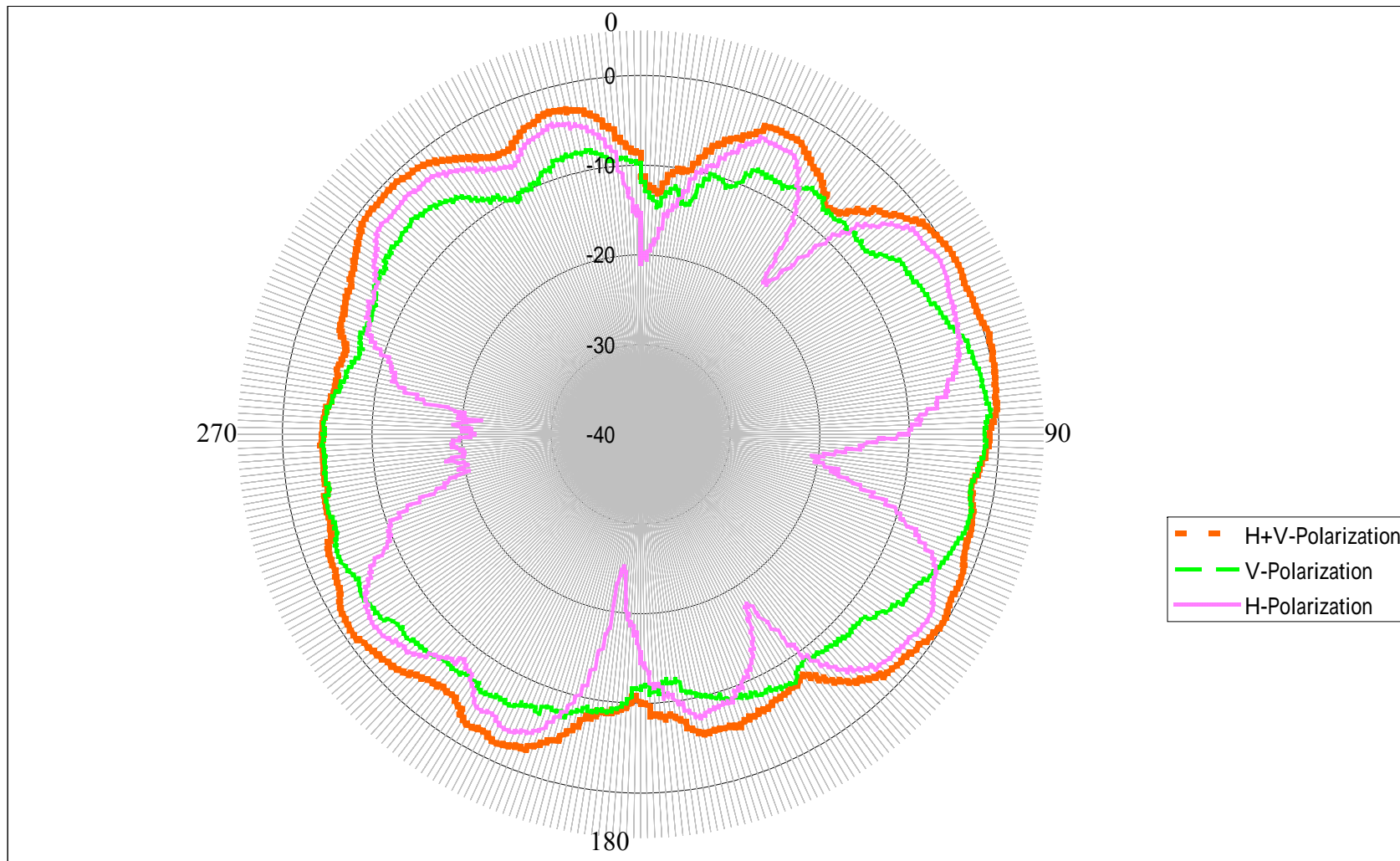



6. Radiation Pattern of XY Plane (Azimuth)-2.484GHz

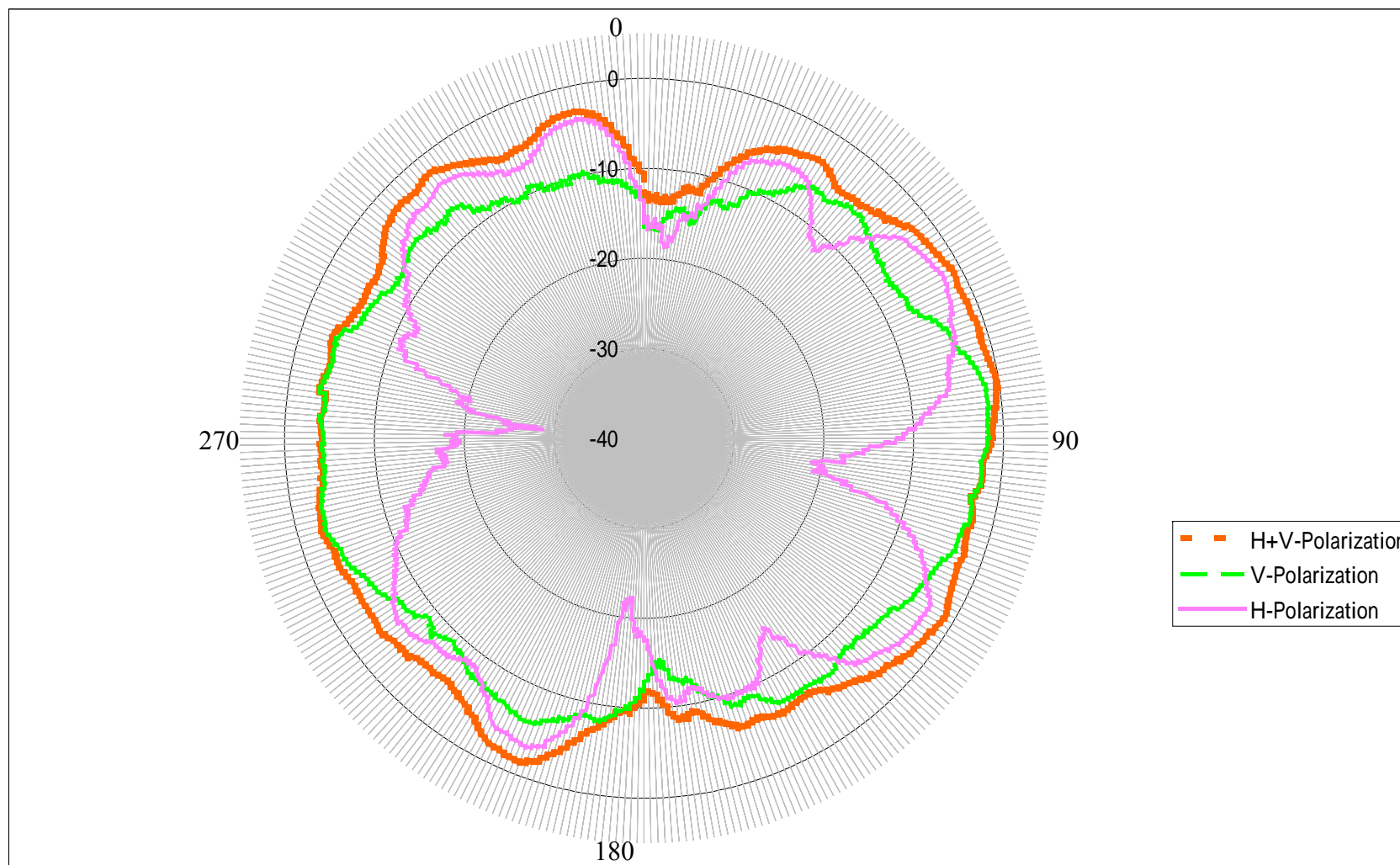





7. Peak Gain and Average Gain

Antenna	Gain Of XY Plane (Azimuth)		
	Polarization		2.414GHz-R
E14A	V	Peak	-0.67
		Average	-5.78
	H	Peak	-1.46
		Average	-5.81
	H+V	Peak	1.05
		Average	-2.78

Antenna	Gain Of XY Plane (Azimuth)		
	Polarization		2.442GHz-R
E14A	V	Peak	-0.74
		Average	-5.84
	H	Peak	-1.27
		Average	-6.13
	H+V	Peak	0.55
		Average	-2.97

Antenna	Gain Of XY Plane (Azimuth)		
	Polarization		2.484GHz-R
E14A	V	Peak	-1.45
		Average	-6.18
	H	Peak	-2.07
		Average	-7.21
	H+V	Peak	-0.18
		Average	-3.65