



1100 E Chalk Creek Road
 Coalville, UT 84017
 (435) 336-4433
 FAX (435) 336-4436

Spurious Emissions (Conducted)

DNB Job Number:	76136	Date:	11 Aug 2017	Conformance Standard FCC Part 90 RSS-137
Customer:	Transcore			
Model Number:	MPRXV1			
Description:	Multiprotocol Reader Extreme			Clause 90.210 (k) RSS-137 cl 6.5.3

LEGEND TO PLOTS BELOW

SeGo - High Band - Middle Channel - 30 to 1000 MHz	SeGo - High Band - Middle Channel - 1 to 3 GHz
SeGo - High Band - Middle Channel - 3 to 6 GHz	SeGo - High Band - Middle Channel - 6 to 10 GHz

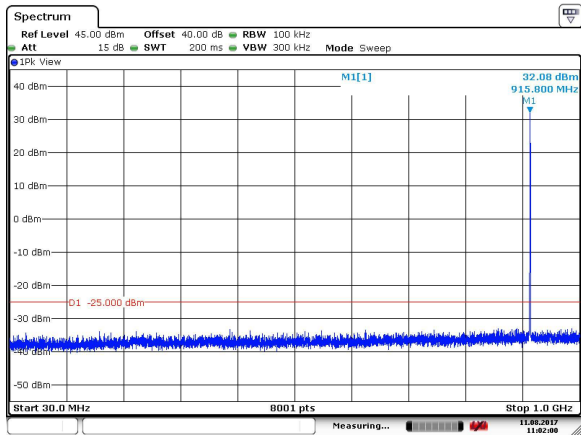

Date: 11.AUG.2017 11:01:59

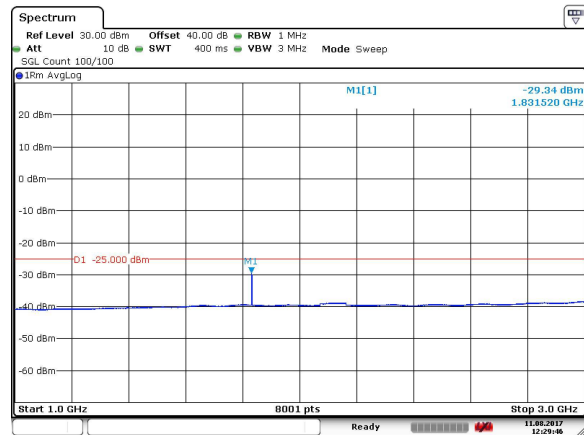

Date: 11.AUG.2017 12:29:46

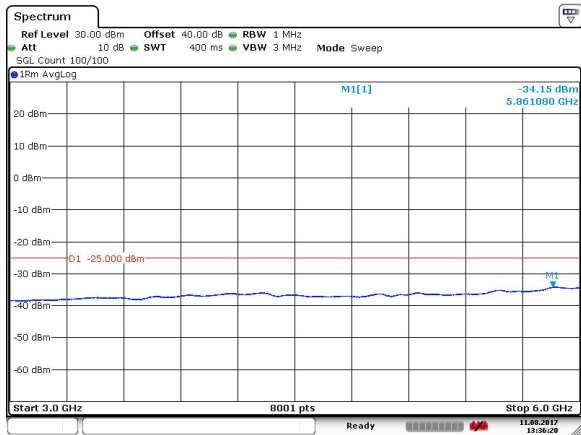

Date: 11.AUG.2017 13:36:20

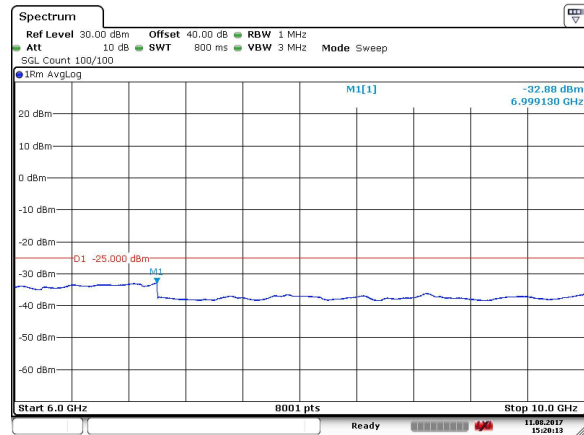

Date: 11.AUG.2017 15:20:13



1100 E Chalk Creek Road
 Coalville, UT 84017
 (435) 336-4433
 FAX (435) 336-4436

Spurious Emissions (Conducted)

DNB Job Number:	76136	Date:	11 Aug 2017	Conformance Standard FCC Part 90 RSS-137
Customer:	Transcore			
Model Number:	MPRXV1			
Description:	Multiprotocol Reader Extreme			Clause 90.210 (k) RSS-137 cl 6.5.3

LEGEND TO PLOTS BELOW

SeGo - High Band - High Channel - 30 to 1000 MHz	SeGo - High Band - High Channel - 1 to 3 GHz
SeGo - High Band - High Channel - 3 to 6 GHz	SeGo - High Band - High Channel - 6 to 10 GHz

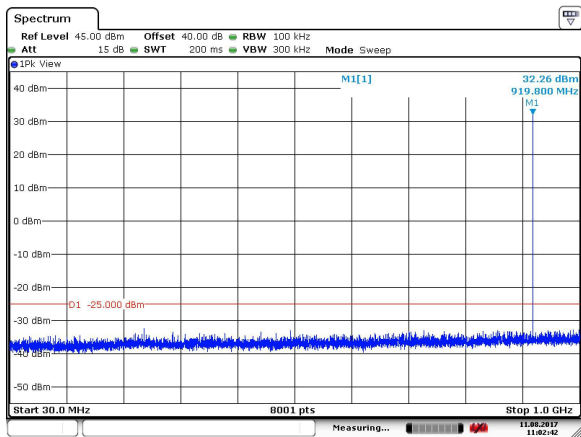

Date: 11.AUG.2017 11:02:42

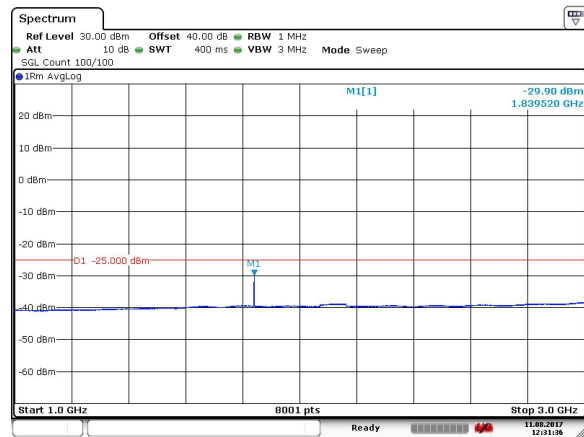

Date: 11.AUG.2017 12:31:36

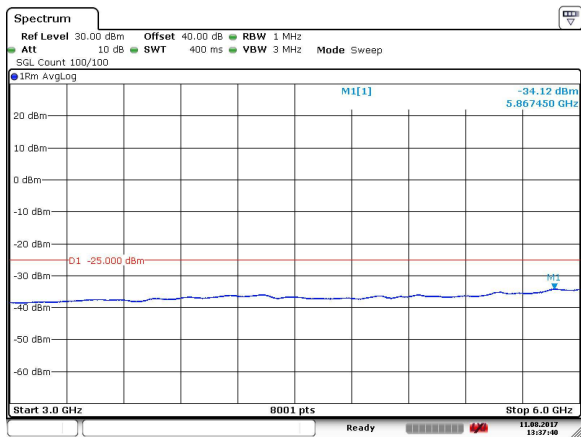

Date: 11.AUG.2017 13:37:40

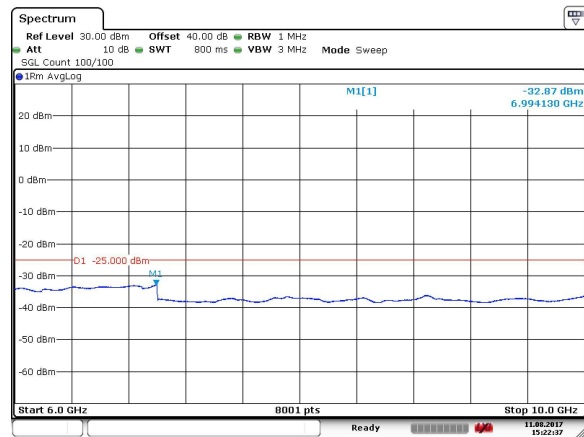

Date: 11.AUG.2017 15:22:37

	1100 E Chalk Creek Road Coalville, UT 84017 (435) 336-4433 FAX (435) 336-4436		Spurious Radiation	
	DNB Job Number: 76136	Date: 2-6 Jun 2017	Specification	
Customer: Transcore			<input checked="" type="checkbox"/> 90.210(k)	
Model Number: MPRXV1			<input checked="" type="checkbox"/> 2.1053	
Description:	Multiprotocol Reader Extreme		<input checked="" type="checkbox"/> EIA/TIA-603-D	
	Test Procedure		<input checked="" type="checkbox"/> RSS-137 cl. 6.5	

- D) For each spurious measurement the test antenna should be adjusted to the correct length for the frequency involved. This length may be determined from a calibration ruler supplied with the equipment. Measurements shall be made from the lowest radio frequency generated in the equipment to the tenth harmonic of the carrier, except for the region close to the carrier equal to \pm the test bandwidth (see Section 1.3.4.4).
- E) For each spurious frequency, raise and lower the test antenna from 1 m to 4 m to obtain a maximum reading on the spectrum analyzer with the test antenna at horizontal polarity. Repeat this procedure to obtain the highest possible reading. Record this maximum reading.
- F) Repeat Step E) for each spurious frequency with the test antenna polarized vertically.
- G) Reconnect the equipment as illustrated.
- H) Keep the spectrum analyzer adjusted as in Step B).
- I) Remove the transmitter and replace it with a substitution antenna (the antenna should be half wavelength for each frequency involved). The center of the substitution antenna should be approximately at the same location as the center of the transmitter. At lower frequencies, where the substitution antenna is very long, this will be impossible to achieve when the antenna is polarized vertically. In such case the lower end of the antenna should be 0.3 m above the ground.
- J) Feed the substitution antenna at the transmitter end with a signal generator connected to the antenna by means of a non-radiating cable. With the antennas at both ends horizontally polarized and with the signal generator tuned to a particular spurious frequency, raise and lower the test antenna to obtain a maximum reading at the spectrum analyzer. Adjust the level of the signal generator output until the previously recorded maximum reading for this set of conditions is obtained. This should be done carefully repeating the adjustment of the test antenna and generator output.

	1100 E Chalk Creek Road Coalville, UT 84017 (435) 336-4433 FAX (435) 336-4436
	Spurious Radiation

DNB Job Number:	76136	Date:	2-6 Jun 2017	Specification
Customer:	Transcore			[X] 90.210(k)
Model Number:	MPRXV1			[X] 2.1053
Description:	Multiprotocol Reader Extreme			[X] EIA/TIA-603-D
	Test Procedure			[X] RSS-137 cl. 6.5

- K) Repeat Step J) with both antennas vertically polarized for each spurious frequency.
- L) Calculate power in dBm into a reference ideal half-wave dipole antenna by reducing the readings obtained in Steps J) and K) by the power loss in the cable between the generator and the antenna and further corrected for the gain of the substitution antenna used relative to an ideal half-wave dipole antenna.
- M) The levels recorded in Step L) are absolute levels of radiated spurious emissions in dBm. The radiated spurious emissions in dB can be calculated by the following:

Limit: Spurious emissions must be attenuated below the peak output power by at least:
 $55 + 10 \log(P)$ dB

where (P) is the highest emission (watts) of the transmitter inside the licensee's sub-band.

Peak Output Power = 1.74 W

Attenuation = $55 + 10 \log(P)$ dB
 = $55 + 10 \log(1.74)$ dB
 = 57.41 dBc



1100 E Chalk Creek Road
Coalville, UT 84017
(435) 336-4433
FAX (435) 336-4436

Spurious Radiation

DNB Job Number:	76136	Date:	2-6 Jun 2017	Specification [X] 90.210(k) [X] 2.1053 [X] EIA/TIA-603-D [X] RSS-137 cl. 6.5
Customer:	Transcore			
Model Number:	MPRXV1			
Description:	Multiprotocol Reader Extreme Test Set-Up			

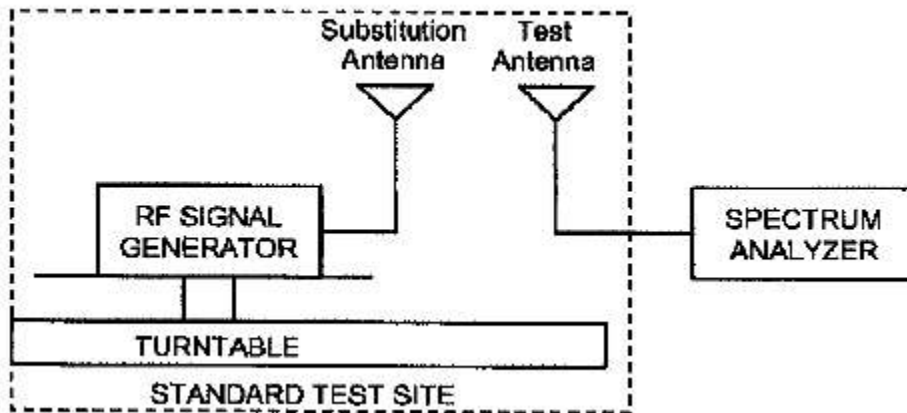
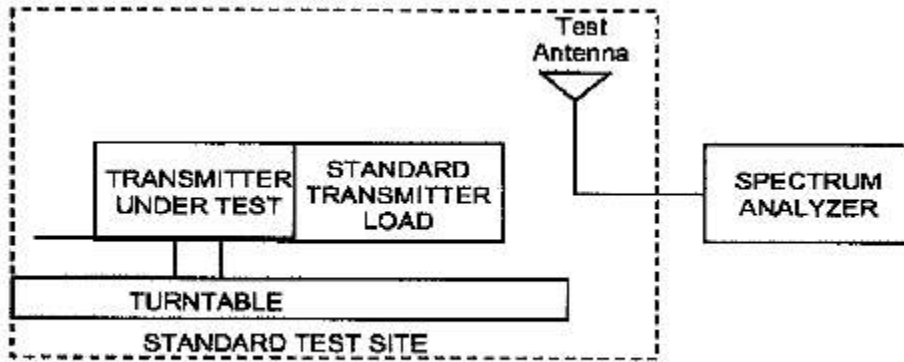



1100 E Chalk Creek Road
 Coalville, UT 84017
 (435) 336-4433
 FAX (435) 336-4436

Spurious Radiation

DNB Job Number:	76136	Date:	2-6 Jun 2017	Specification <input checked="" type="checkbox"/> 90.210(k) <input checked="" type="checkbox"/> 2.1053 <input checked="" type="checkbox"/> EIA/TIA-603-D <input checked="" type="checkbox"/> RSS-137 cl. 6.5
Customer:	Transcore			
Model Number:	MPRXV1			
Description:	Multiprotocol Reader Extreme Low Band / Low Channel / Modulation = ATA (CW)			

Fundamental Frequency (MHz)	Polarity	Maximum Level (dBm)
902.250	Vertical	32.22
902.250	Horizontal	27.05

Measurements										
Freq in MHz	Polarity	Measured Level (dBuV/m)	Substitution				dBc	Limit	Margin	Result
			Signal Generator (dBm)	Cable Loss (dB)	Antenna Gain (dBd)	Corrected Level (dBm)				
1804.500	Hor	26.52	-75.47	0.81	8.99	-65.67	-92.72	-57.41	-35.31	PASS
2706.750	Hor	22.61	-75.27	1.03	9.25	-64.99	-92.04	-57.41	-34.63	PASS
3609.000	Hor	27.81	-70.60	1.26	10.86	-58.48	-85.53	-57.41	-28.12	PASS
4511.250	Hor	21.65	-73.73	1.39	11.27	-61.07	-88.12	-57.41	-30.71	PASS
5413.500	Hor	21.50	-69.92	1.59	9.94	-58.39	-85.44	-57.41	-28.03	PASS
6315.750	Hor	18.36	-69.19	1.63	10.90	-56.66	-83.71	-57.41	-26.30	PASS
7218.000	Hor	20.86	-67.86	2.21	9.80	-55.85	-82.90	-57.41	-25.49	PASS
8120.250	Hor	19.16	-71.76	2.31	11.16	-58.29	-85.34	-57.41	-27.93	PASS
9022.500	Hor	19.13	-73.65	2.62	11.74	-59.29	-86.34	-57.41	-28.93	PASS
1804.500	Vert	33.69	-69.30	0.81	8.99	-59.50	-91.72	-57.41	-34.31	PASS
2706.750	Vert	30.97	-70.11	1.03	9.25	-59.83	-92.05	-57.41	-34.64	PASS
3609.000	Vert	39.48	-60.33	1.26	10.86	-48.21	-80.43	-57.41	-23.02	PASS
4511.250	Vert	24.09	-71.49	1.39	11.27	-58.83	-91.05	-57.41	-33.64	PASS
5413.500	Vert	24.46	-68.16	1.59	9.94	-56.63	-88.85	-57.41	-31.44	PASS
6315.750	Vert	19.15	-70.43	1.63	10.90	-57.90	-90.12	-57.41	-32.71	PASS
7218.000	Vert	21.14	-66.78	2.21	9.80	-54.77	-86.99	-57.41	-29.58	PASS
8120.250	Vert	19.24	-70.88	2.31	11.16	-57.41	-89.63	-57.41	-32.22	PASS
9022.500	Vert	18.01	-73.57	2.62	11.74	-59.21	-91.43	-57.41	-34.02	PASS



1100 E Chalk Creek Road
 Coalville, UT 84017
 (435) 336-4433
 FAX (435) 336-4436

Spurious Radiation

DNB Job Number:	76136	Date:	2-6 Jun 2017	Specification <input checked="" type="checkbox"/> 90.210(k) <input checked="" type="checkbox"/> 2.1053 <input checked="" type="checkbox"/> EIA/TIA-603-D <input checked="" type="checkbox"/> RSS-137 cl. 6.5
Customer:	Transcore			
Model Number:	MPRXV1			
Description:	Multiprotocol Reader Extreme Low Band / Mid Channel / Modulation = ATA (CW)			

Fundamental Frequency (MHz)	Polarity	Maximum Level (dBm)
903.000	Vertical	32.13
903.000	Horizontal	30.11

Measurements										
Freq in MHz	Polarity	Measured Level (dBuV/m)	Substitution				dBc	Limit	Margin	Result
			Signal Generator (dBm)	Cable Loss (dB)	Antenna Gain (dBd)	Corrected Level (dBm)				
1806.000	Hor	32.33	-70.86	0.81	8.99	-61.06	-91.17	-57.41	-33.76	PASS
2709.000	Hor	23.82	-76.26	1.03	9.27	-65.96	-96.07	-57.41	-38.66	PASS
3612.000	Hor	28.16	-72.23	1.26	10.86	-60.11	-90.22	-57.41	-32.81	PASS
4515.000	Hor	21.70	-75.25	1.39	11.28	-62.58	-92.69	-57.41	-35.28	PASS
5418.000	Hor	21.03	-70.38	1.59	9.94	-58.85	-88.96	-57.41	-31.55	PASS
6321.000	Hor	19.78	-70.63	1.63	10.89	-58.11	-88.22	-57.41	-30.81	PASS
7224.000	Hor	19.00	-67.71	2.20	9.79	-55.72	-85.83	-57.41	-28.42	PASS
8127.000	Hor	17.56	-71.75	2.30	11.19	-58.26	-88.37	-57.41	-30.96	PASS
9030.000	Hor	18.52	-74.47	2.64	11.73	-60.10	-90.21	-57.41	-32.80	PASS
1806.000	Vert	29.45	-72.74	0.81	8.99	-62.94	-95.07	-57.41	-37.66	PASS
2709.000	Vert	28.28	-71.20	1.03	9.27	-60.90	-93.03	-57.41	-35.62	PASS
3612.000	Vert	35.71	-64.88	1.26	10.86	-52.76	-84.89	-57.41	-27.48	PASS
4515.000	Vert	20.78	-74.57	1.39	11.28	-61.90	-94.03	-57.41	-36.62	PASS
5418.000	Vert	24.13	-65.48	1.59	9.94	-53.95	-86.08	-57.41	-28.67	PASS
6321.000	Vert	19.33	-69.72	1.63	10.89	-57.20	-89.33	-57.41	-31.92	PASS
7224.000	Vert	22.65	-66.26	2.20	9.79	-54.27	-86.40	-57.41	-28.99	PASS
8127.000	Vert	20.07	-71.84	2.30	11.19	-58.35	-90.48	-57.41	-33.07	PASS
9030.000	Vert	19.46	-72.93	2.64	11.73	-58.56	-90.69	-57.41	-33.28	PASS



1100 E Chalk Creek Road
 Coalville, UT 84017
 (435) 336-4433
 FAX (435) 336-4436

Spurious Radiation

DNB Job Number:	76136	Date:	2-6 Jun 2017	Specification <input checked="" type="checkbox"/> 90.210(k) <input checked="" type="checkbox"/> 2.1053 <input checked="" type="checkbox"/> EIA/TIA-603-D <input checked="" type="checkbox"/> RSS-137 cl. 6.5
Customer:	Transcore			
Model Number:	MPRXV1			
Description:	Multiprotocol Reader Extreme Low Band / High Channel / Modulation = ATA (CW)			

Fundamental Frequency (MHz)	Polarity	Maximum Level (dBm)
903.750	Vertical	32.10
903.750	Horizontal	31.77

Measurements

Freq in MHz	Polarity	Measured Level (dBuV/m)	Substitution				dBc	Limit	Margin	Result
			Signal Generator (dBm)	Cable Loss (dB)	Antenna Gain (dBd)	Corrected Level (dBm)				
1807.500	Hor	28.96	-73.02	0.81	8.99	-63.22	-94.99	-57.41	-37.58	PASS
2711.250	Hor	24.13	-75.15	1.03	9.28	-64.84	-96.61	-57.41	-39.20	PASS
3615.000	Hor	30.33	-68.84	1.27	10.86	-56.71	-88.48	-57.41	-31.07	PASS
4518.750	Hor	23.32	-73.01	1.39	11.28	-60.34	-92.11	-57.41	-34.70	PASS
5422.500	Hor	21.00	-69.80	1.59	9.94	-58.27	-90.04	-57.41	-32.63	PASS
6326.250	Hor	19.24	-68.88	1.63	10.89	-56.36	-88.13	-57.41	-30.72	PASS
7230.000	Hor	20.88	-67.83	2.20	9.78	-55.85	-87.62	-57.41	-30.21	PASS
8133.750	Hor	19.02	-70.70	2.29	11.21	-57.20	-88.97	-57.41	-31.56	PASS
9037.500	Hor	18.15	-72.65	2.66	11.72	-58.27	-90.04	-57.41	-32.63	PASS
1807.500	Vert	28.63	-74.75	0.81	8.99	-64.95	-97.05	-57.41	-39.64	PASS
2711.250	Vert	25.83	-73.25	1.03	9.28	-62.94	2.01	-57.41	59.42	PASS
3615.000	Vert	34.34	-65.63	1.27	10.86	-53.50	9.44	-57.41	66.85	PASS
4518.750	Vert	22.53	-71.80	1.39	11.28	-59.13	-5.64	-57.41	51.77	PASS
5422.500	Vert	25.27	-67.33	1.59	9.94	-55.80	3.34	-57.41	60.75	PASS
6326.250	Vert	22.68	-67.29	1.63	10.89	-54.77	1.03	-57.41	58.44	PASS
7230.000	Vert	24.12	-63.19	2.20	9.78	-51.21	3.56	-57.41	60.97	PASS
8133.750	Vert	20.42	-69.70	2.29	11.21	-56.20	-4.99	-57.41	52.42	PASS
9037.500	Vert	20.30	-72.10	2.66	11.72	-57.72	-1.52	-57.41	55.89	PASS



1100 E Chalk Creek Road
 Coalville, UT 84017
 (435) 336-4433
 FAX (435) 336-4436

Spurious Radiation

DNB Job Number:	76136	Date:	2-6 Jun 2017	Specification <input checked="" type="checkbox"/> 90.210(k) <input checked="" type="checkbox"/> 2.1053 <input checked="" type="checkbox"/> EIA/TIA-603-D <input checked="" type="checkbox"/> RSS-137 cl. 6.5
Customer:	Transcore			
Model Number:	MPRXV1			
Description:	Multiprotocol Reader Extreme High Band / Low Channel / Modulation = ATA (CW)			

Fundamental Frequency (MHz)	Polarity	Maximum Level (dBm)
910.000	Vertical	32.39
910.000	Horizontal	26.90

Measurements

Freq in MHz	Polarity	Measured Level (dBuV/m)	Substitution				dBc	Limit	Margin	Result
			Signal Generator (dBm)	Cable Loss (dB)	Antenna Gain (dBd)	Corrected Level (dBm)				
1820.000	Hor	29.47	-72.44	0.82	8.98	-62.64	-89.54	-57.41	-32.13	PASS
2730.000	Hor	24.90	-74.97	1.04	9.42	-64.51	-91.41	-57.41	-34.00	PASS
3640.000	Hor	25.68	-73.53	1.28	10.85	-61.40	-88.30	-57.41	-30.89	PASS
4550.000	Hor	20.46	-73.91	1.39	11.33	-61.19	-88.09	-57.41	-30.68	PASS
5460.000	Hor	21.17	-69.70	1.61	9.97	-58.12	-85.02	-57.41	-27.61	PASS
6370.000	Hor	20.35	-69.27	1.67	10.82	-56.78	-83.68	-57.41	-26.27	PASS
7280.000	Hor	21.72	-66.58	2.16	9.79	-54.63	-81.53	-57.41	-24.12	PASS
8190.000	Hor	19.49	-71.63	2.22	11.38	-58.03	-84.93	-57.41	-27.52	PASS
9100.000	Hor	18.96	-73.34	2.82	11.66	-58.86	-85.76	-57.41	-28.35	PASS
1820.000	Vert	34.56	-66.95	0.82	8.98	-57.15	-89.54	-57.41	-32.13	PASS
2730.000	Vert	33.82	-66.45	1.04	9.42	-55.99	-88.38	-57.41	-30.97	PASS
3640.000	Vert	34.08	-67.53	1.28	10.85	-55.40	-87.79	-57.41	-30.38	PASS
4550.000	Vert	22.02	-72.75	1.39	11.33	-60.03	-92.42	-57.41	-35.01	PASS
5460.000	Vert	22.92	-68.15	1.61	9.97	-56.57	-88.96	-57.41	-31.55	PASS
6370.000	Vert	20.92	-69.24	1.67	10.82	-56.75	-89.14	-57.41	-31.73	PASS
7280.000	Vert	21.16	-66.74	2.16	9.79	-54.79	-87.18	-57.41	-29.77	PASS
8190.000	Vert	23.43	-67.09	2.22	11.38	-53.49	-85.88	-57.41	-28.47	PASS
9100.000	Vert	20.24	-70.86	2.82	11.66	-56.38	-88.77	-57.41	-31.36	PASS



1100 E Chalk Creek Road
 Coalville, UT 84017
 (435) 336-4433
 FAX (435) 336-4436

Spurious Radiation

DNB Job Number:	76136	Date:	2-6 Jun 2017	Specification <input checked="" type="checkbox"/> 90.210(k) <input checked="" type="checkbox"/> 2.1053 <input checked="" type="checkbox"/> EIA/TIA-603-D <input checked="" type="checkbox"/> RSS-137 cl. 6.5
Customer:	Transcore			
Model Number:	MPRXV1			
Description:	Multiprotocol Reader Extreme High Band / Mid Channel / Modulation = ATA (CW)			

Fundamental Frequency (MHz)	Polarity	Maximum Level (dBm)
915.750	Vertical	31.93
915.750	Horizontal	30.11

Measurements

Freq in MHz	Polarity	Measured Level (dBuV/m)	Substitution				dBc	Limit	Margin	Result
			Signal Generator (dBm)	Cable Loss (dB)	Antenna Gain (dBd)	Corrected Level (dBm)				
1831.500	Hor	31.60	-72.05	0.82	8.96	-62.27	-92.38	-57.41	-34.97	PASS
2747.250	Hor	27.20	-71.87	1.04	9.54	-61.29	-91.40	-57.41	-33.99	PASS
3663.000	Hor	29.37	-70.90	1.29	10.79	-58.82	-88.93	-57.41	-31.52	PASS
4578.750	Hor	21.82	-74.00	1.39	11.66	-60.95	-91.06	-57.41	-33.65	PASS
5494.500	Hor	21.98	-70.59	1.62	10.05	-58.92	-89.03	-57.41	-31.62	PASS
6410.250	Hor	21.45	-68.03	1.72	10.70	-55.61	-85.72	-57.41	-28.31	PASS
7326.000	Hor	24.15	-63.62	2.15	9.92	-51.55	-81.66	-57.41	-24.25	PASS
8241.750	Hor	22.81	-68.73	2.15	11.46	-55.12	-85.23	-57.41	-27.82	PASS
9157.500	Hor	23.54	-69.98	2.98	11.61	-55.39	-85.50	-57.41	-28.09	PASS
1831.500	Vert	33.62	-68.23	0.82	8.96	-58.45	-90.38	-57.41	-32.97	PASS
2747.250	Vert	28.60	-72.47	1.04	9.54	-61.89	-93.82	-57.41	-36.41	PASS
3663.000	Vert	32.68	-67.99	1.29	10.79	-55.91	-87.84	-57.41	-30.43	PASS
4578.750	Vert	22.75	-73.47	1.39	11.66	-60.42	-92.35	-57.41	-34.94	PASS
5494.500	Vert	22.17	-67.80	1.62	10.05	-56.13	-88.06	-57.41	-30.65	PASS
6410.250	Vert	23.47	-66.23	1.72	10.70	-53.81	-85.74	-57.41	-28.33	PASS
7326.000	Vert	22.67	-64.70	2.15	9.92	-52.63	-84.56	-57.41	-27.15	PASS
8241.750	Vert	20.80	-68.94	2.15	11.46	-55.33	-87.26	-57.41	-29.85	PASS
9157.500	Vert	20.82	-70.90	2.98	11.61	-56.31	-88.24	-57.41	-30.83	PASS



1100 E Chalk Creek Road
 Coalville, UT 84017
 (435) 336-4433
 FAX (435) 336-4436

Spurious Radiation

DNB Job Number:	76136	Date:	2-6 Jun 2017	Specification <input checked="" type="checkbox"/> 90.210(k) <input checked="" type="checkbox"/> 2.1053 <input checked="" type="checkbox"/> EIA/TIA-603-D <input checked="" type="checkbox"/> RSS-137 cl. 6.5
Customer:	Transcore			
Model Number:	MPRXV1			
Description:	Multiprotocol Reader Extreme High Band / High Channel / Modulation = ATA (CW)			

Fundamental Frequency (MHz)	Polarity	Maximum Level (dBm)
921.500	Vertical	32.26
921.500	Horizontal	31.11

Measurements

Freq in MHz	Polarity	Measured Level (dBuV/m)	Substitution				dBc	Limit	Margin	Result
			Signal Generator (dBm)	Cable Loss (dB)	Antenna Gain (dBd)	Corrected Level (dBm)				
1843.000	Hor	30.54	-71.26	0.82	8.95	-61.49	-92.60	-57.41	-35.19	PASS
2764.500	Hor	26.53	-72.74	1.05	9.64	-62.05	-93.16	-57.41	-35.75	PASS
3686.000	Hor	28.50	-69.83	1.30	10.70	-57.83	-88.94	-57.41	-31.53	PASS
4607.500	Hor	21.76	-72.70	1.39	11.17	-60.14	-91.25	-57.41	-33.84	PASS
5529.000	Hor	21.39	-69.95	1.64	10.17	-58.14	-89.25	-57.41	-31.84	PASS
6450.500	Hor	21.50	-68.71	1.78	10.53	-56.40	-87.51	-57.41	-30.10	PASS
7372.000	Hor	21.42	-65.27	2.19	10.10	-52.98	-84.09	-57.41	-26.68	PASS
8293.500	Hor	21.03	-70.16	2.19	11.54	-56.43	-87.54	-57.41	-30.13	PASS
9215.000	Hor	19.16	-72.60	3.12	11.58	-57.90	-89.01	-57.41	-31.60	PASS
1843.000	Vert	33.05	-68.95	0.82	8.95	-59.18	-91.44	-57.41	-34.03	PASS
2764.500	Vert	26.65	-73.62	1.05	9.64	-62.93	-95.19	-57.41	-37.78	PASS
3686.000	Vert	32.21	-68.52	1.30	10.70	-56.52	-88.78	-57.41	-31.37	PASS
4607.500	Vert	22.12	-72.94	1.39	11.17	-60.38	-92.64	-57.41	-35.23	PASS
5529.000	Vert	22.29	-68.25	1.64	10.17	-56.44	-88.70	-57.41	-31.29	PASS
6450.500	Vert	21.72	-67.99	1.78	10.53	-55.68	-87.94	-57.41	-30.53	PASS
7372.000	Vert	25.35	-63.54	2.19	10.10	-51.25	-83.51	-57.41	-26.10	PASS
8293.500	Vert	22.24	-67.75	2.19	11.54	-54.02	-86.28	-57.41	-28.87	PASS
9215.000	Vert	20.56	-72.00	3.12	11.58	-57.30	-89.56	-57.41	-32.15	PASS

The carrier frequency shall not depart from the reference frequency in excess of ± 2.5 ppm for any type of equipment unless indicated otherwise.

Fixed N-LMS transmitters with an emission bandwidth located more than 40 kHz from the band edge, intermittently operated hand-held readers and mobile transponders are exempt from meeting the frequency stability limit.

EXEMPT: These devices meet the criteria stated above N-LMS transmitters with an emission bandwidth located more than 40kHz from the band edge.

Test Procedure: ANSI C63.10-2013

Frequency stability with respect to ambient temperature - EXEMPT - Not Applicable

- a) Supply the EUT with a nominal ac voltage or install a new or fully charged battery in the EUT. If possible, a dummy load shall be connected to the EUT because an antenna near the metallic walls of an environmental test chamber could affect the output frequency of the EUT. If the EUT is equipped with a permanently attached, adjustable-length antenna, then the EUT shall be placed in the center of the chamber with the antenna adjusted to the shortest length possible. Turn ON the EUT and tune it to one of the number of frequencies shown in ANSI 63.10-2013 clause 5.6.
- b) Couple the unlicensed wireless device output to the measuring instrument by connecting an antenna to the measuring instrument with a suitable length of coaxial cable and placing the measuring antenna near the EUT (e.g., 15 cm away), or by connecting a dummy load to the measuring instrument, through an attenuator if necessary.
- c) Adjust the location of the measurement antenna and the controls on the measurement instrument to obtain a suitable signal level (i.e., a level that will not overload the measurement instrument but is strong enough to allow measurement of the operating or fundamental frequency of the EUT).
- d) Turn the EUT OFF and place it inside the environmental temperature chamber. For devices that have oscillator heaters, energize only the heater circuit.
- e) Set the temperature control on the chamber to the highest specified in the regulatory requirements for the type of device and allow the oscillator heater and the chamber temperature to stabilize.
- f) While maintaining a constant temperature inside the environmental chamber, turn the EUT ON and record the operating frequency at startup, and at 2 minutes, 5 minutes, and 10 minutes after the EUT is energized. Four measurements in total are made.

- g) Measure the frequency at each of frequencies specified in ANSI 63.10-2013 clause 5.6.
- h) Switch OFF the EUT but do not switch OFF the oscillator heater.
- i) Lower the chamber temperature by not more than 10 °C, and allow the temperature inside the chamber to stabilize.
- j) Repeat step f) through step i) down to the lowest specified temperature.



1100 E Chalk Creek Road
Coalville, UT 84017
(435) 336-4433
FAX (435) 336-4436

Temperature Stability

DNB Job Number:	76136	Date:	28 Jun 2017	Specification [X] 90.213 [X] 2.1055 [X] RSS-137 cl. 6.3
Customer:	Transcore			
Model Number:	MPRXV1			
Description:	Multiprotocol Reader Extreme			

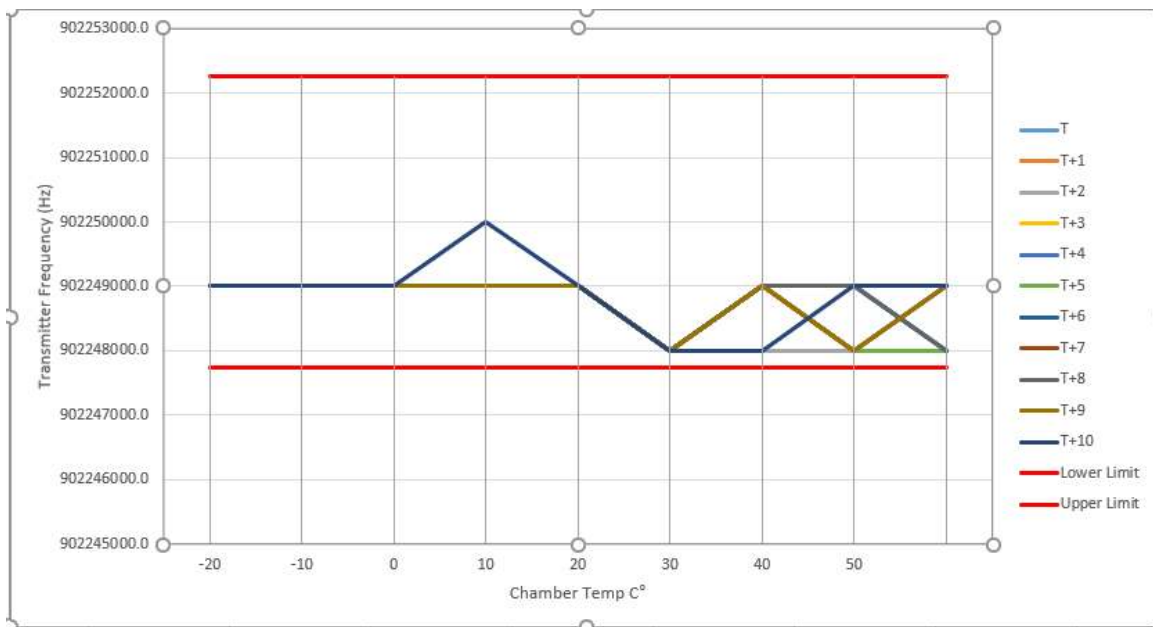

Frequency stability when varying supply voltage - EXEMPT - Not Applicable

Unless otherwise specified, these tests shall be made at ambient room temperature (+15 °C to +25 °C). An antenna shall be connected to the antenna output terminals of the EUT if possible. If the EUT is equipped with or uses an adjustable-length antenna, then it shall be fully extended.

- a) Supply the EUT with nominal voltage or install a new or fully charged battery in the EUT. Turn ON the EUT and couple its output to a frequency counter or other frequency-measuring instrument.
- b) Tune the EUT to one of the number of frequencies required in ANSI 63.10-2013 clause 5.6. Adjust the location of the measurement antenna and the controls on the measurement instrument to obtain a suitable signal level (i.e., a level that will not overload the measurement instrument but is strong enough to allow measurement of the operating or fundamental frequency of the EUT).
- c) Measure the frequency at each of the frequencies specified in ANSI 63.10-2013 clause 5.6.
- d) Repeat the above procedure at 85% and 115% of the nominal supply voltage as described in ANSI 63.10-2013 clause 5.13.

End of Report UT76136A-002