

ROGERS LABS, INC.

4405 West 259th Terrace
Louisburg, KS 66053
Phone / Fax (913) 837-3214

Engineering Test Report for Grant of Certification of Application 47CFR Part 90 and Industry Canada RSS-137 Location and Monitoring Service Transmitter

HVIN: E4SPT90V45

902.25-903.75 and 910.00-921.50 MHz

FCC ID: FIHE4SPT90V45

IC: 1584A-E4SPT90V45

Transcore

Amtech Technology Center
8600 Jefferson Street, NE
Albuquerque, NM 87113

FCC Designation: US5305

ISED Registration: 3041A-1

Test Report Number: 210813

Test Date: August 13, 2021

Authorized Signatory: *Scot D Rogers*
Scot D. Rogers

This report shall not be reproduced except in full, without the written approval of the laboratory. This report must not be used by the client to claim product certification, approval, or endorsement by NVLAP, NIST, or any agency of the U.S. Government.

Rogers Labs, Inc.
4405 West 259th Terrace
Louisburg, KS 66053
Phone/Fax: (913) 837-3214
Revision 1

Transcore
HVIN: E4SPT90V45
Test: 210813
Test to: 47CFR Parts 2, 90 and RSS-137
File: Transcore E4SPT90V45 TstRpt 210813

SN: 111383 / 111388
FCC ID: FIHE4SPT90V45
IC: 1584A-E4SPT90V45
Date: August 29, 2021
Page 1 of 54

Table of Contents

TABLE OF CONTENTS..... 2

REVISION HISTORY 4

EXECUTIVE SUMMARY 5

SUMMARY..... 5

ATTESTATIONS..... 5

APPLICABLE STANDARDS AND TEST PROCEDURES 6

OPINION / INTERPRETATION OF RESULTS 6

EQUIPMENT UNDER TEST 7

 Equipment Function7

 Equipment Configuration8

APPLICATION FOR CERTIFICATION..... 9

UNITS OF MEASUREMENTS 12

TEST SITE LOCATIONS 12

ENVIRONMENTAL CONDITIONS..... 12

TEST #1 TRANSMITTER POWER OUTPUT 13

 Measurements Required13

 Test Arrangement Output Power13

Table 1 Transmitter Power Results.....14

 Figure 1 Transmitter Output Across Frequency Band CW (ATA) Highest Power Level 15

 Figure 2 Transmitter Output Across Frequency Band CW (ATA) Lowest Power Level..... 17

 Figure 3 Transmitter Output Across Frequency Band SeGo..... 18

 Figure 4 Transmitter Output Across Frequency Band IAG 19

 Figure 5 Transmitter Output Across Frequency Band EPC20

 Figure 6 Transmitter Output Across Frequency Band eGo21

TEST #2 MODULATION CHARACTERISTICS 22

Measurements Required22

Test Arrangement22

TEST #3 OCCUPIED BANDWIDTH 23

Measurements Required23

Test Arrangement23

Table 2 Occupied Bandwidth Results24

 Figure 7 Occupied Bandwidth CW (ATA)25

 Figure 8 Occupied Bandwidth SeGo26

 Figure 9 Occupied Bandwidth IAG27

 Figure 10 Occupied Bandwidth EPC28

 Figure 11 Occupied Bandwidth eGo29

TEST #4 SPURIOUS EMISSIONS 30

Measurements Required30

Test Arrangement30

Table 3 Spurious Emissions Results CW (ATA) (Maximum Power)31

Table 4 Spurious Emissions Results CW (ATA) (Minimum Power)32

Table 5 Spurious Emissions Results SeGo33

Table 6 Spurious Emissions Results IAG34

Table 7 Spurious Emissions Results EPC35

Table 8 Spurious Emissions Results eGo36

TEST #5 EMISSION MASK 37

Measurements Required37

Test Arrangement37

 Figure 12 Emissions Mask ATA38

 Figure 13 Emissions Mask ATA39

 Figure 14 Emissions Mask SeGo40

Figure 15 Emissions Mask IAG 41

Figure 16 Emissions Mask EPC 42

Figure 17 Emissions Mask eGo 43

TEST #6 FIELD STRENGTH OF SPURIOUS RADIATION..... 44

Measurements Required 44

Test Arrangement 44

Table 9 General Radiated Emission Results (worst-case) 46

TEST #7 FREQUENCY STABILITY 47

Measurements Required 47

Test Arrangement 47

Table 10 Frequency Stability vs. Temperature Results 48

Table 11 Frequency Stability vs. Input Power Supply Voltage Results 48

ANNEX..... 49

Annex A Measurement Uncertainty Calculations 50

Annex B Test Equipment List 51

Annex C Rogers Qualifications 53

Annex D Laboratory Certificate of Accreditation 54

Revision History

Revision 1 Issued August 29, 2021

Executive Summary

The following information is submitted for consideration in obtaining Equipment Grant of Certification for Licensed Intelligent Transportation Systems Radio Service, Location and Monitoring Services (LMS) governed under 47CFR Paragraph 90 (M) and Innovation, Science and Economic Development (ISED) RSS-137 issue 2.

Summary

- The device fulfills the general approval requirements of the referenced standards identified in this test report and requested by the customer.
- The device does not fulfill the general approval requirements of the referenced standards identified in this test report.

Name of Applicant: Transcore
Amtech Technology Center 8600 Jefferson Street, NE
Albuquerque, NM 87113
Phone: (505) 856-8000

HVIN: E4SPT90V45

FCC ID: FIHE4SPT90V45 IC: 1584A-E4SPT90V45

Frequency of Operation: 902.25-903.75, 910.00-921.50 MHz

Transmit Power: 2.0 Watts max 0.052 Watts minimum, occupied bandwidth CW minimum and maximum 489 kHz

Attestations

This equipment has been tested in accordance with the standards identified in this report and determined in compliance with the referenced requirements and regulations. To the best of my knowledge all testing was performed using the measurement procedures identified in this report. All instrumentation used during compliance testing are calibrated and remain in a calibrated state in accordance with ISO 17025:2017 requirements. Further, I attest that all necessary measurements were completed at Rogers Labs, Inc.

Rogers Labs, Inc.
4405 West 259th Terrace
Louisburg, KS 66053

Scot D Rogers

Scot D. Rogers
Date: August 13, 2021

Rogers Labs, Inc.
4405 West 259th Terrace
Louisburg, KS 66053
Phone/Fax: (913) 837-3214
Revision 1

Transcore
HVIN: E4SPT90V45
Test: 210813
Test to: 47CFR Parts 2, 90 and RSS-137
File: Transcore E4SPT90V45 TstRpt 210813

SN: 111383 / 111388
FCC ID: FIHE4SPT90V45
IC: 1584A-E4SPT90V45
Date: August 29, 2021
Page 5 of 54

Applicable Standards and Test Procedures

In accordance with the Federal Communications Code of Federal Regulations, 47CFR dated August 13, 2021, Part 2 Subpart J, Paragraphs 2.907, 2.911, 2.913, 2.925, 2.926, 2.1031 through 2.1057; 90.201 through 90.217, 90.350 through 90.363 and RSS-137 Issue 2 the following information is submitted. Test procedures used were the established Methods of Measurement of Radio-Noise Emissions as described in ANSI C63.26-2015 and ANSI 63.4-2014.

Opinion / Interpretation of Results

Test Number	Measurement	FCC Rule	Pass/Fail
#1	Power Measurement	47CFR paragraphs 2.1046 90.205, RSS-137, Issue 2	Pass
#2	Modulation Characteristics	47CFR paragraphs 2.1049, 2.1051, 90.207, 90.209, RSS-137	Pass
#3	Occupied Bandwidth, Conducted Emissions Mask and Spurious Emissions	47CFR paragraphs 2.1049, 2.1051, 90.207, 90.209, RSS-137	Pass
#4	Spurious Emissions	47CFR 2.1051, 2.1053, 47CFR paragraphs 90.209 and RSS-137	Pass
#5	Emission Mask	47CFR 2.1051, 90.210, RSS-137	Pass
#6	Spurious Emissions	47CFR 2.1051, 2.1053, 47CFR paragraphs 90.209 and RSS-137	Pass
#7	Frequency Stability	47CFR 2.1055, 90.213, RSS-137	Pass

Equipment Under Test

<u>Equipment</u>	<u>HVIN</u>	<u>Serial Number</u>
EUT1	E4SPT90V45	111383
EUT2	E4SPT90V45	111388
DC Communications interface	Manufacturer provided	N/A
Computer	Dell PP02X	16KM171

Test results in this report relate only to the items tested

Software Version: 1.10

Antenna options include 2x2 internal patch (12 dBi) or 2x3 external patch (13.8 dBi)

The software provides ability to adjust power from 33 dBm to 18 dBm in 1 dB steps. The power level of the design is 2.0 watts (33 dBm) for authorized LMS operation in the 902-928 MHz band operating specifically in the 902.25-903.75 and 910.00-921.50 MHz frequency band.

Equipment Function

The EUT is a fixed Non-Multilateral transmitter operating under the Intelligent Transportation Systems Radio Service as Location and Monitoring Services (LMS). Operation of the design utilizes industry standardized modulation schemes offering the ability to interface and respond with Industry Radio Frequency Identification Device (RFID) interrogation systems. The system operates over input power range of 18-28 V_{dc}, 2.5 amps. The power and communications interface box provided serial interface for communications with digital equipment. The manufacturer provided software which allowed testing personnel operational control of the transmitter for testing purposes. Two test samples were provided for testing, 1) with integral antenna and 2) with RF connection port. The test samples were loaded with manufacturer software Version 1.10. The EUT was arranged as described by the manufacturer emulating typical use configurations for testing purposes. The EUT offers no other interface connections than those documented in the configuration options presented. The EUT functions as an Interrogator of Radio Frequency Identification Devices (RFID) operating in the 902.25-903.75 and 910.00-921.50 MHz LMS frequency band. During testing all interface connections were appropriately terminated. As requested by the manufacturer and required by regulations, the equipment was tested for

emissions compliance using the available configurations with the worst-case data presented.
 Test results in this report relate only to the products described in this report.

Equipment Configuration

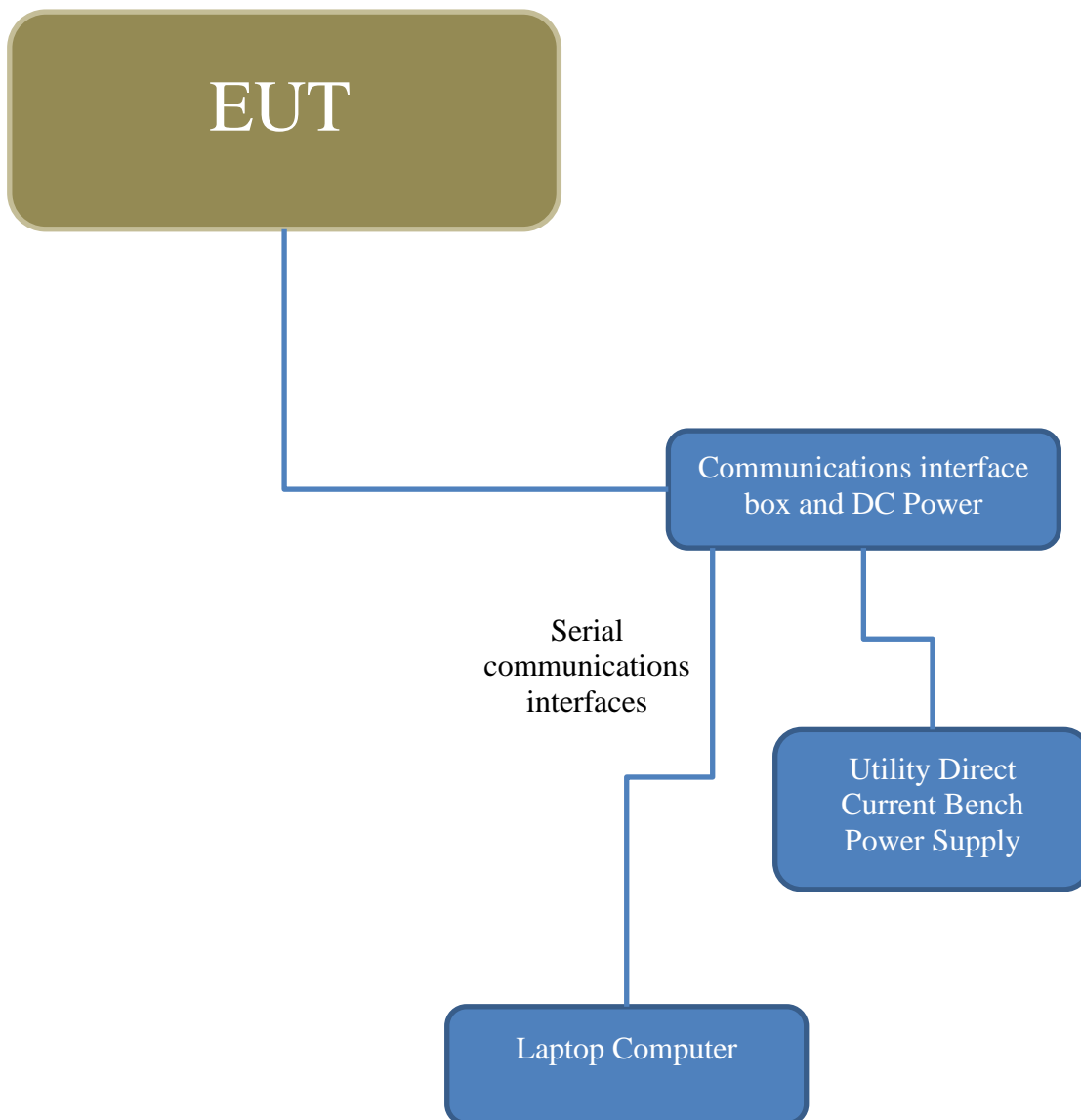

Application for Certification

1. Manufacturer: Transcore
Amtech Technology Center
8600 Jefferson Street, NE
Albuquerque, NM 87113
2. Identification: **HVIN: E4SPT90V45 FCC ID: FIHE4SPT90V45 IC: 1584A-E4SPT90V45**
3. A copy of the installation and operating instructions furnished to the end user. Refer to the instruction manual furnished with this application for details.

4. Emission Types: Modulated in width/duration/data –

Frequency (MHz)	Operational Mode	Emission Designator
902.25-903.75	CW (ATA)	110KN0N
910.00-921.50	CW (ATA)	110KN0N
911.75-919.75	eGo	318KL1D
911.75-919.75	SeGo	489KL1D
911.75-919.75	IAG	344KL1D
911.75-919.75	EPC	425KL1D

5. Frequency Range: 902.25-903.75, 910.00-921.50 MHz
6. Range of operating power values or specific operating power levels, and description of any means provided for variation of operating power. 2.0-0.051 watts, installation selectable in 1 dB steps.
7. Maximum power rating as defined in the applicable part(s) of the rules. As stated in 47CFR, 90.205(k) the maximum permissible output power allowed is 30 watts.
8. The dc voltages applied to and dc currents into the several elements of the final radio frequency amplifying device for normal operation over the power range. The maximum operating mode runs at 11.45 volts consuming 0.75 amps.
9. Provide the tune-up procedure over the power range, or at specific operating power levels. Refer to the tune-up procedure furnished with this application for details.

10. A schematic diagram and a description of all circuitry and devices provided for determining and stabilizing frequency, for suppression of spurious radiation, for limiting modulation, and for limiting power. Refer to the schematics and technical exhibits furnished with this application for details.
11. A photograph or drawing of the equipment identification plate, or label showing the information to be placed thereon shall be provided. Refer to the identification label exhibit and information furnished with this application for details.
12. Photographs (8" x 10") of the equipment of sufficient clarity to reveal equipment construction and layout, including meters, if any, and labels for controls and meters and sufficient views of the internal construction to define component placement and chassis assembly. Insofar as these requirements are met by photographs or drawings contained in instruction manuals supplied with the certification request, additional photographs are necessary only to complete the required showing. Refer to the exhibits of this report and or additional information furnished with the application for details.
13. For equipment employing digital modulation techniques, a detailed description of the modulation system to be used, including the response characteristics (frequency, phase, and amplitude) of any filters provided, and a description of the modulating wave train, shall be submitted for the maximum rated conditions under which the equipment will be operated. Information about modulation is contained in Operational description exhibit.
14. The data required by Sections 2.1046 through 2.1057, inclusive, measured in accordance with the procedures set out in Section 2.1041.
15. The application for certification of an external radio frequency power amplifier under Part 97 of this chapter need not be accompanied by the data required by Paragraph (b)(14) of this section. In lieu thereof, measurements shall be submitted to show compliance with the technical specifications in Subpart C of Part 97 of this chapter and such information as required by Section 2.1060 of this part. This paragraph does not apply to this equipment.
16. An application for certification of an AM broadcast stereophonic exciter generator intended for interfacing with existing certified, or formerly type accepted or notified transmitters must include measurements made on a complete stereophonic transmitter. The instruction book must include complete specifications and circuit requirements for interconnecting with existing transmitters. The instruction book must also provide a full description of the equipment and measurement procedures to monitor modulation and to verify that the combination of stereo exciter generator and transmitter meets the emission limitations of section 73.44. This paragraph does not apply to this equipment.
17. A single application may be filed for a composite system that incorporates devices subject to certification under multiple rule parts; however, the appropriate fee must be included for each device. Separate applications must be filed if different FCC Identifiers will be used for each device.

18. The device is not a software-defined radio and requirements of 2.944 do not apply to this application.
19. Applications for certification of equipment operating under part 27 of this chapter, that a manufacturer is seeking to certify for operation in the:
 - (i) 1755-1780 MHz, 2155-2180 MHz, or both bands shall include a statement indicating compliance with the pairing of 1710-1780 and 2110-2180 MHz specified in §§27.5(h) and 27.75 of this chapter.
 - (ii) 1695-1710 MHz, 1755-1780 MHz, or both bands shall include a statement indicating compliance with §27.77 of this chapter.
 - (iii) 600 MHz band shall include a statement indicating compliance with §27.75 of this chapter.
20. Applications for certification of equipment operating under part 90 of this chapter and capable of operating on the 700 MHz interoperability channels (See §90.531(b)(1) of this chapter) shall include a Compliance Assessment Program Supplier's Declaration of Conformity and Summary Test Report or, alternatively, shall include a document detailing how the applicant determined that its equipment complies with §90.548 of this chapter and that the equipment is interoperable across vendors.
21. Contain at least one drawing or photograph showing the test set-up for each of the required types of tests applicable to the device for which certification is requested. These drawings or photographs must show enough detail to confirm other information contained in the test report. Any photographs used must be focused originals without glare or dark spots and must clearly show the test configuration used.

Units of Measurements

Conducted EMI Data presented in dB μ V; dB referenced to one microvolt

Antenna port Conducted Data is in dBm; dB referenced to one milliwatt

Radiated EMI Data presented in dB μ V/m; dB referenced to one microvolt per meter

Note: Radiated limit may be expressed for measurement in dB μ V/m when the measurement is taken at a distance of 3 or 10 meters. Data taken for this report was taken at distance of 3 meters.

Sample calculation demonstrates corrected field strength reading for Open Area Test Site using the measurement reading and correcting for receive antenna factor, cable losses, and amplifier gains.

Sample Calculation:

RFS = Radiated Field Strength, FSM = Field Strength Measured

A.F. = Receive antenna factor, Losses = attenuators/cable losses, Gain = amplification gains

$RFS (dB\mu V/m @ 3m) = FSM (dB\mu V) + A.F. (dB/m) + Losses (dB) - Gain (dB)$

Test Site Locations

Conducted EMI AC line conducted emissions testing performed in a shielded screen room located at Rogers Labs, Inc., 4405 West 259th Terrace, Louisburg, KS

Radiated EMI The radiated emissions tests were performed at the 3 meters, Open Area Test Site (OATS) located at Rogers Labs, Inc., 4405 West 259th Terrace, Louisburg, KS

Registered Site information: FCC Site: US5305, ISED: 3041A, CAB Identifier: US0096

NVLAP Accreditation Lab code 200087-0

Environmental Conditions

Ambient Temperature 23.8° C

Relative Humidity 43%

Atmospheric Pressure 1014.4 mb

Rogers Labs, Inc.	Transcore	SN: 111383 / 111388
4405 West 259 th Terrace	HVIN: E4SPT90V45	FCC ID: FIHE4SPT90V45
Louisburg, KS 66053	Test: 210813	IC: 1584A-E4SPT90V45
Phone/Fax: (913) 837-3214	Test to: 47CFR Parts 2, 90 and RSS-137	Date: August 29, 2021
Revision 1	File: Transcore E4SPT90V45 TstRpt 210813	Page 12 of 54

TEST #1 Transmitter Power Output

Measurements Required

Measurements shall be made to establish the radio frequency power delivered by the transmitter into the standard output termination. The power output shall be monitored and recorded, and no adjustment shall be made to the transmitter after the test has begun, except as noted below:

If the power output is adjustable, measurements shall be made for the highest and lowest power levels.

Test Arrangement Output Power

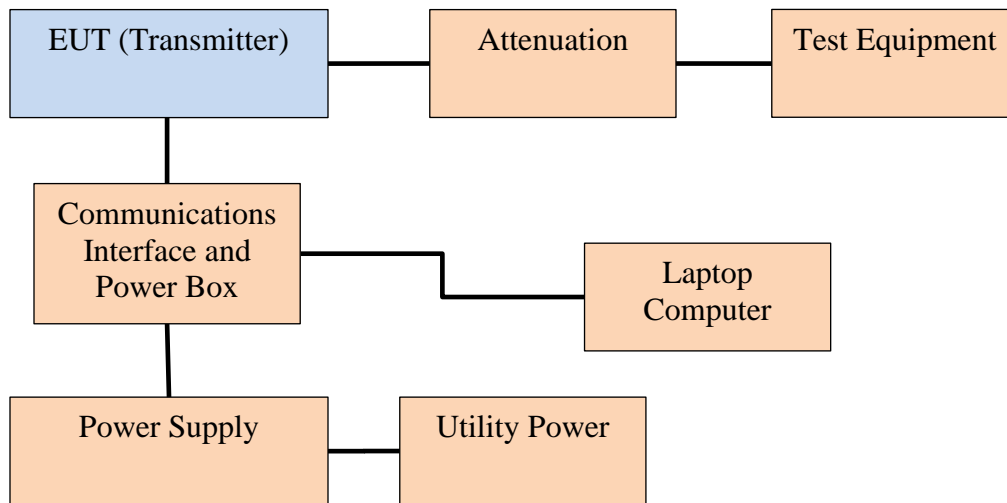

The radio frequency power output was measured at the antenna terminal by placing appropriate attenuation on the antenna port connector and observing the spectral emissions with the spectrum analyzer. The spectrum analyzer and attenuation offered an impedance of 50Ω to match the impedance of the standard antenna. A Rohde & Schwarz ESU40 Spectrum Analyzer and/or an Agilent Power Meter were used to measure the radio frequency power at the antenna port. Data was taken in dBm and converted to watts as shown in the following table. Refer to Figures 1 through 7 showing plots of output power of the transmitter across the frequency band. The testing procedures used conform to the procedures stated in the ANSI C63.26-2015 document. Data was taken per 47CFR Paragraph 2.1046(a) and applicable paragraphs of Part 90 and RSS-137.

P_{dBm} = power in dB above 1 milliwatt
 Milliwatts = $10^{(P_{dBm}/10)}$
 Watts = (Milliwatts)(0.001)(W/mW)
 Milliwatts = $10^{(33.02/10)}$
 = 2,002.2 mW
 = 2.00 Watts power

Table 1 Transmitter Power Results

Frequency (MHz)	P_{dBm}	P_{mw}	P_w
ATA (Maximum)	33.02	2,002.2	2.00
ATA (Minimum)	17.17	52.12	0.052
eGo (Maximum)	32.28	1,690.4	1.69
SeGo (Maximum)	32.54	1,794.7	1.79
IAG (Maximum)	32.46	1,762.0	1.76
EPC (Maximum)	32.46	1,762.0	1.76

RSS-137 6.4 requires the e.r.p. shall not exceed 30 watts for the band 902-927.25 MHz and 300 watts for the band 927.25-928 MHz. The power is adjusted at installation to comply with requirements and site license. The EUT demonstrated compliance with specifications of 47CFR Paragraph 2.1046(a) and applicable Parts of 2 and 90.205 and RSS-137. There are no deviations to the specifications.

Figure 1 Transmitter Output Across Frequency Band CW (ATA) High Power Level
 902-904 MHz band

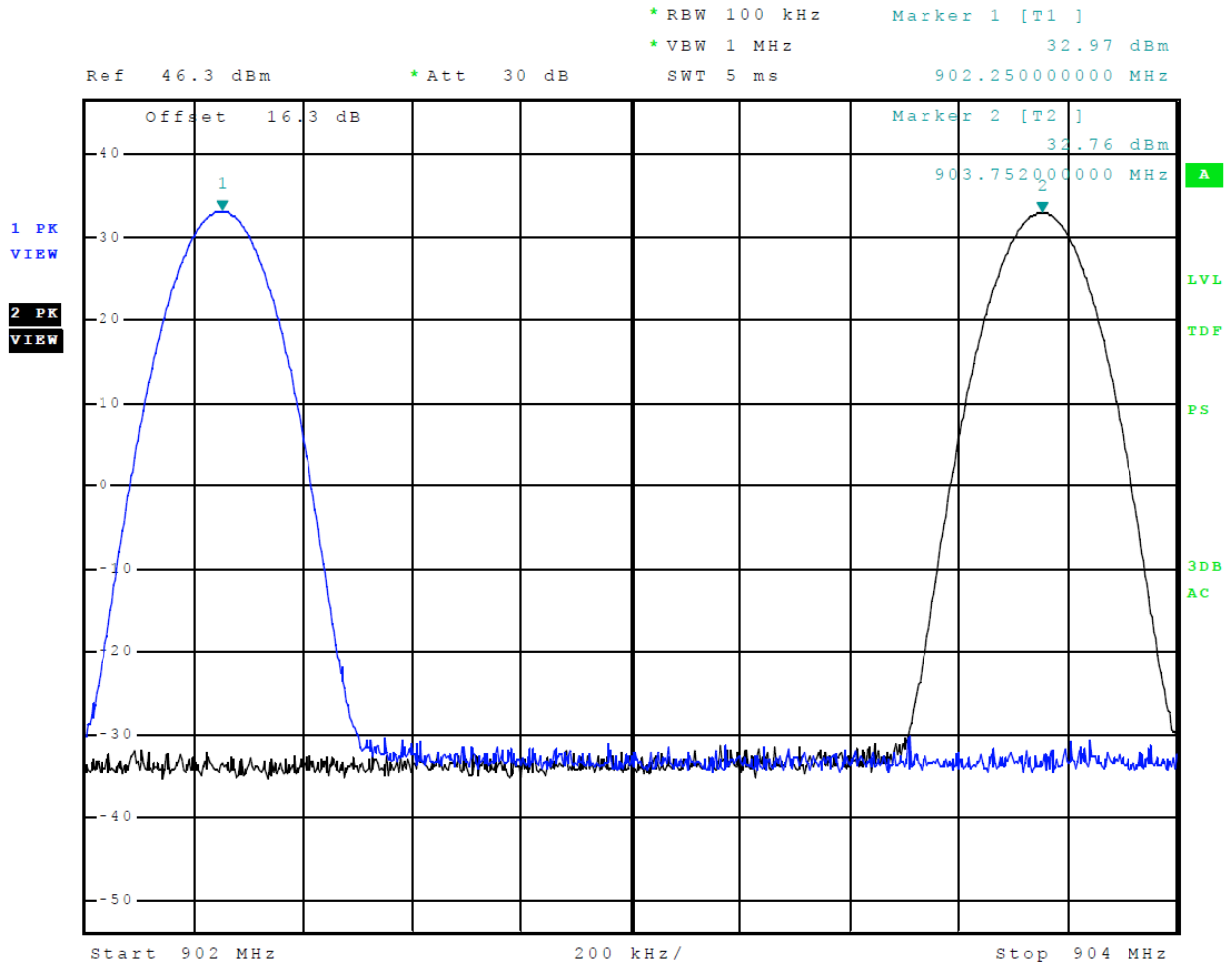

910-921.75 MHz band

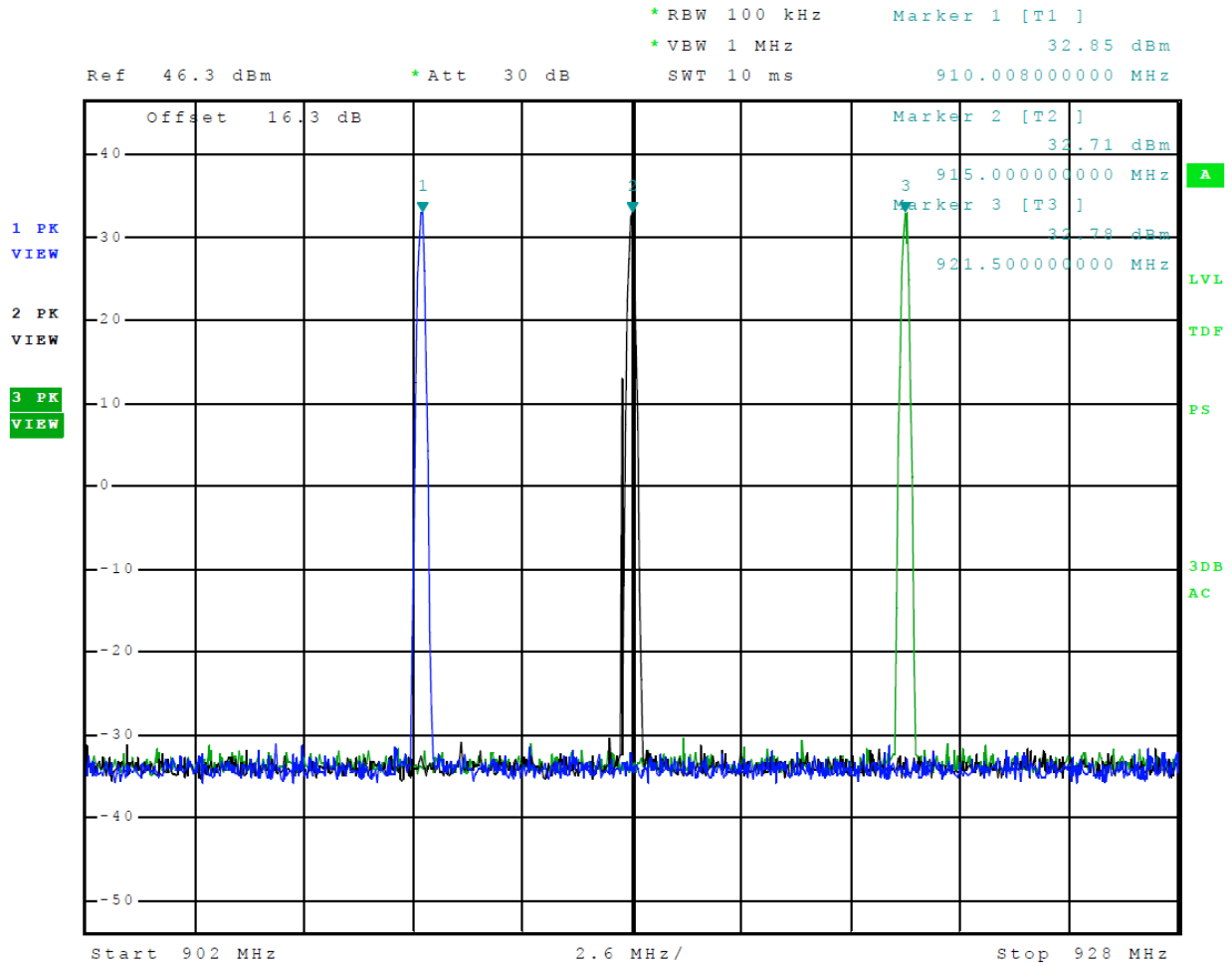

Figure 2 Transmitter Output Across Frequency Band CW (ATA) Lowest Power Level

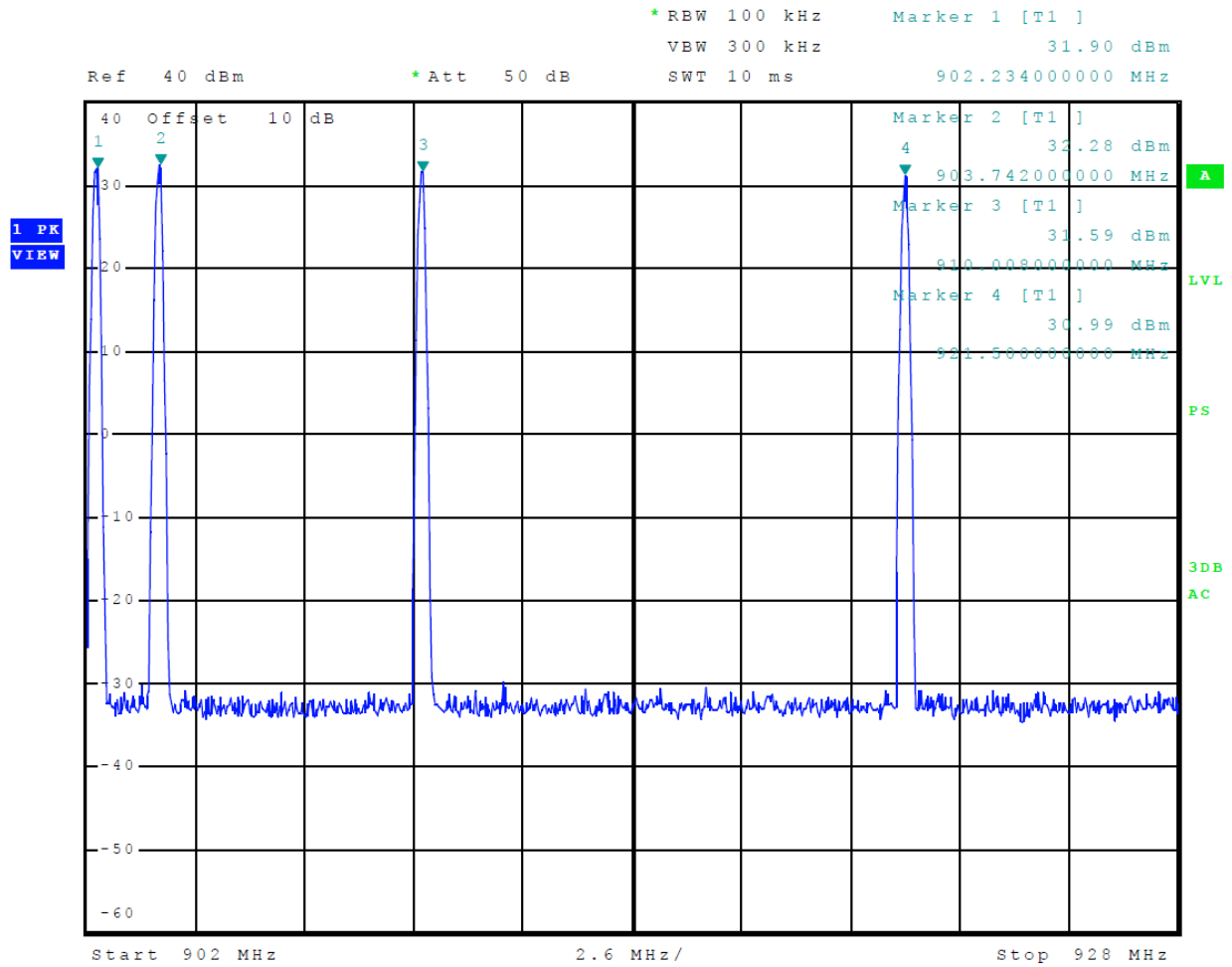

Figure 3 Transmitter Output Across Frequency Band eGo

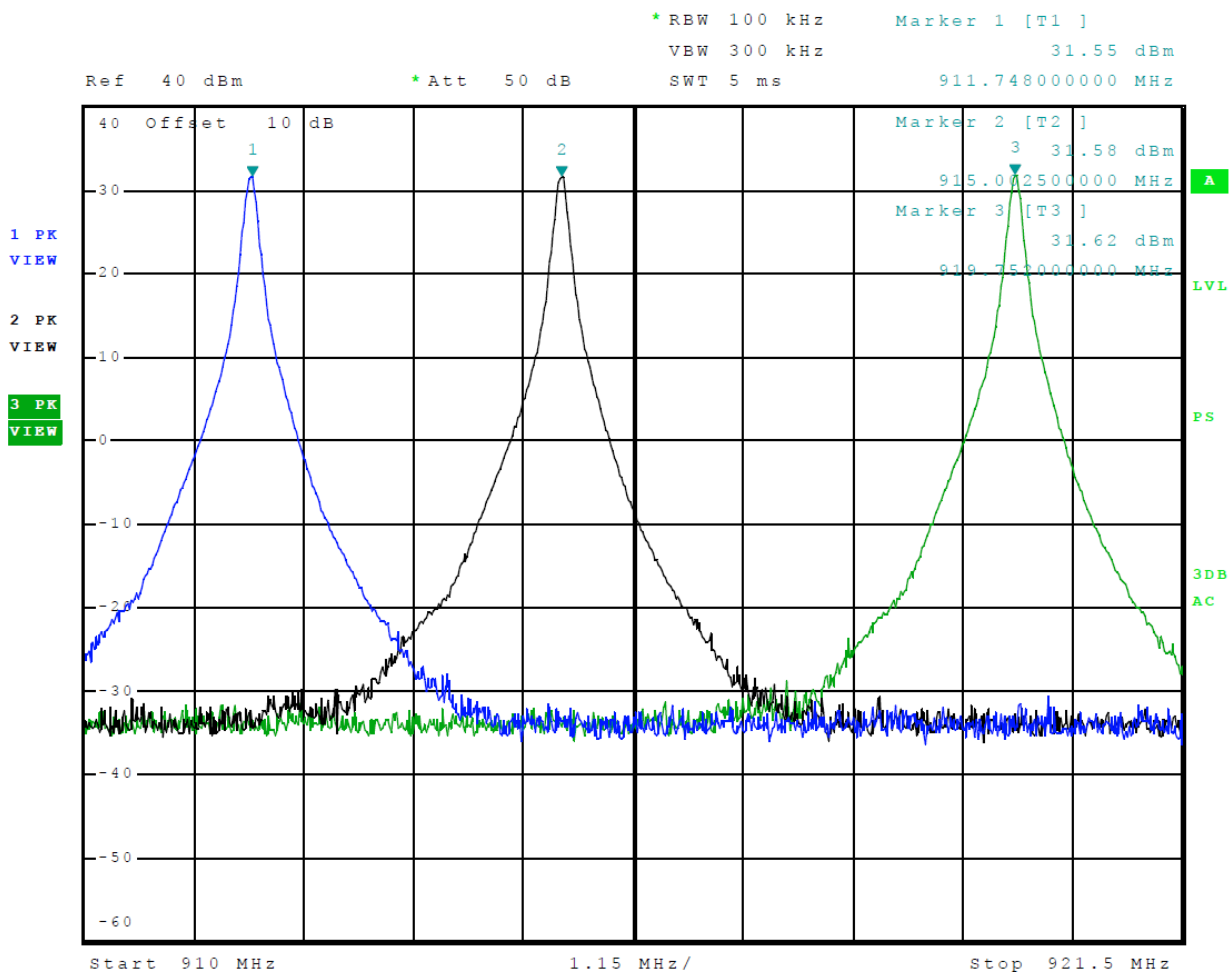

Figure 4 Transmitter Output Across Frequency Band SeGo

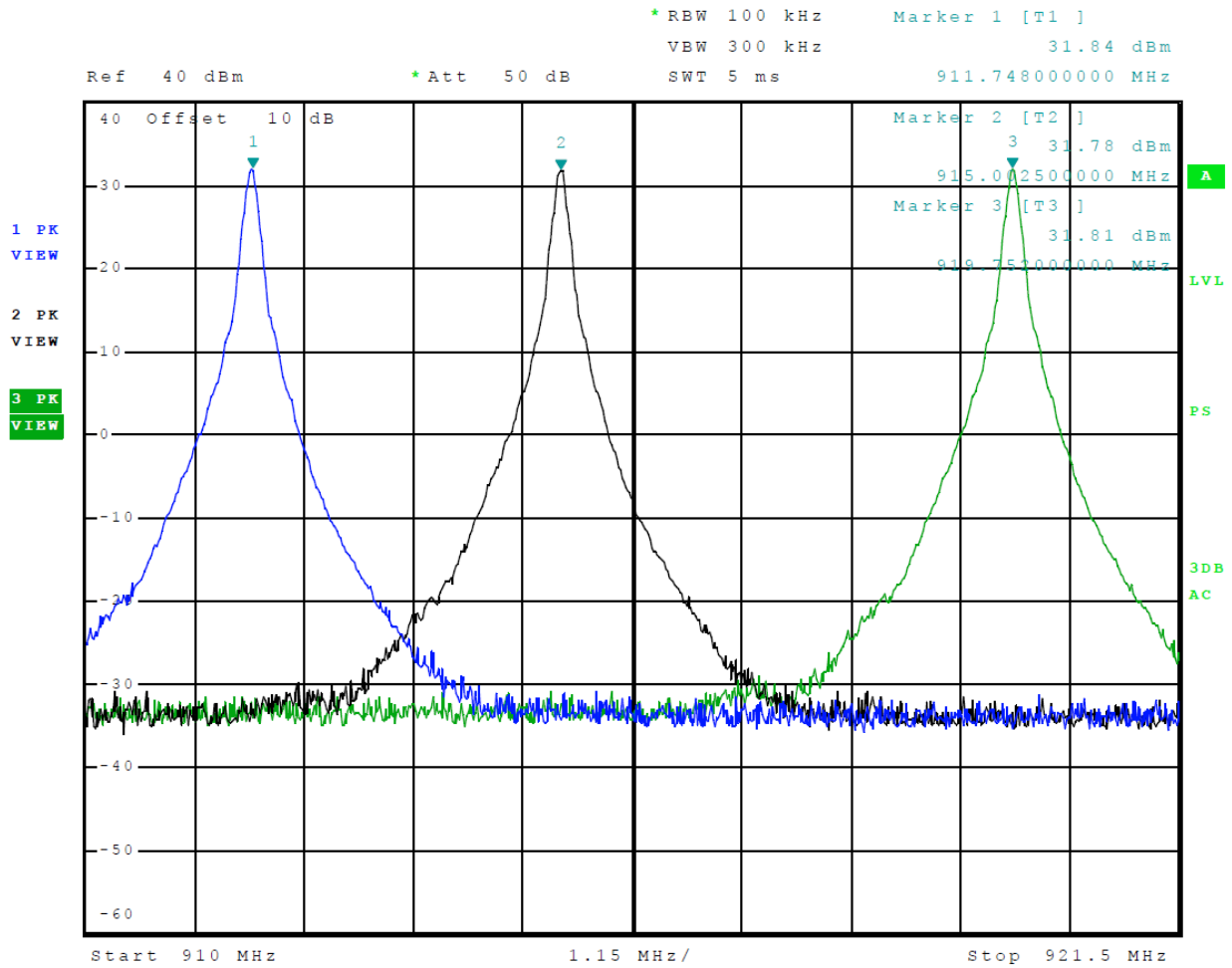

Figure 5 Transmitter Output Across Frequency Band IAG

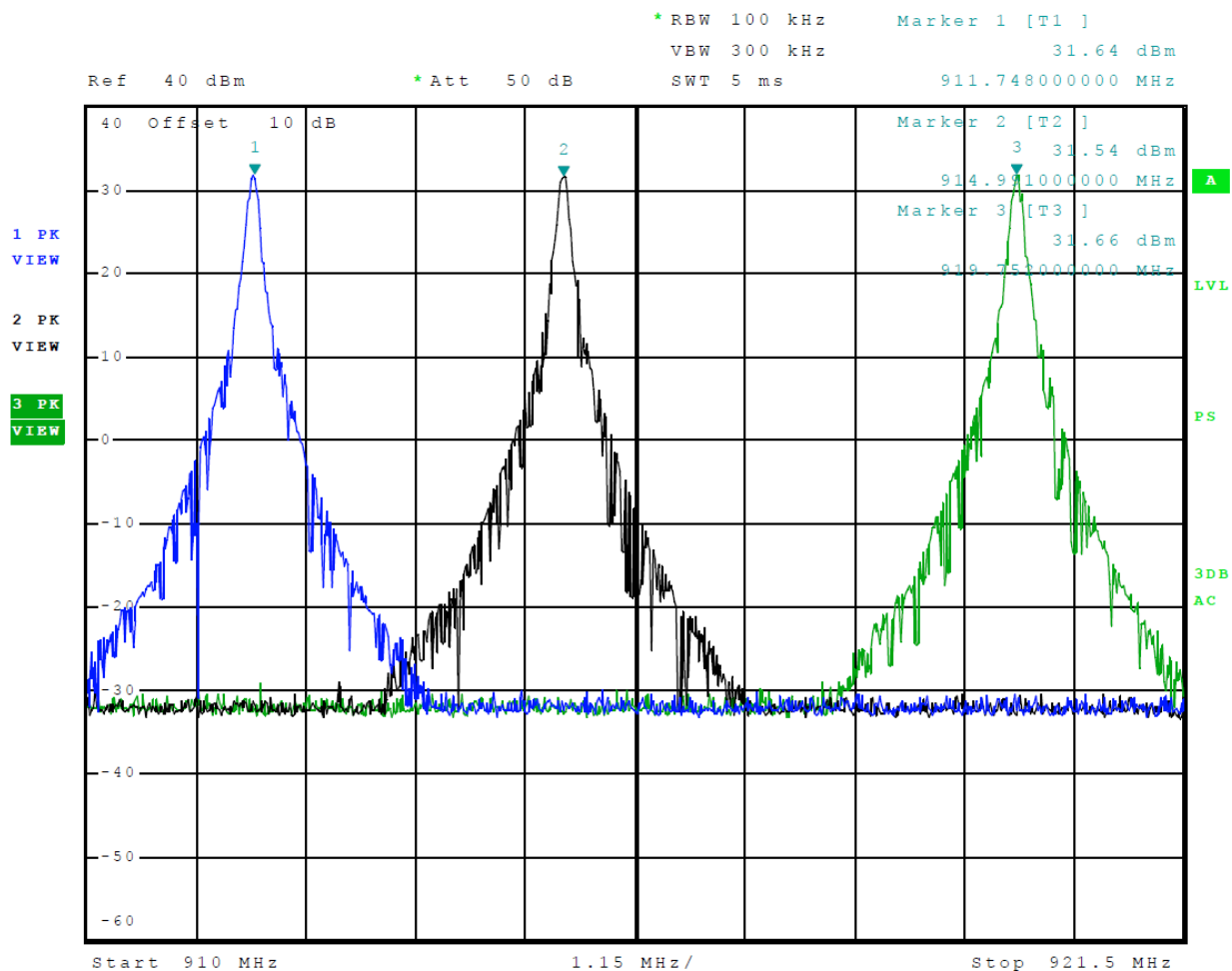
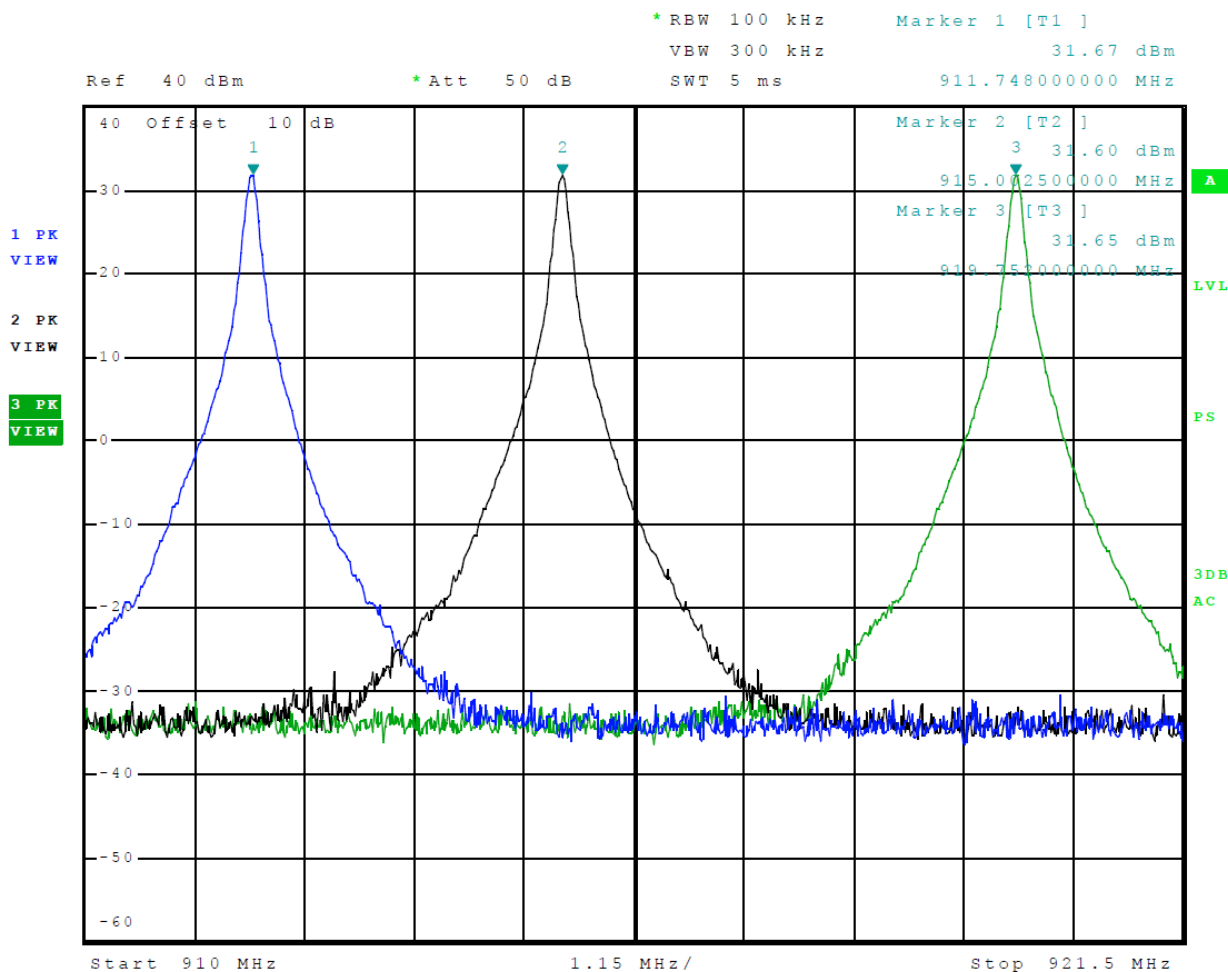

Figure 6 Transmitter Output Across Frequency Band EPC



TEST #2 Modulation Characteristics

Measurements Required

A curve or equivalent data that shows that the equipment will meet the modulation requirements of the rules under which the equipment is to be licensed shall be submitted.

Test Arrangement

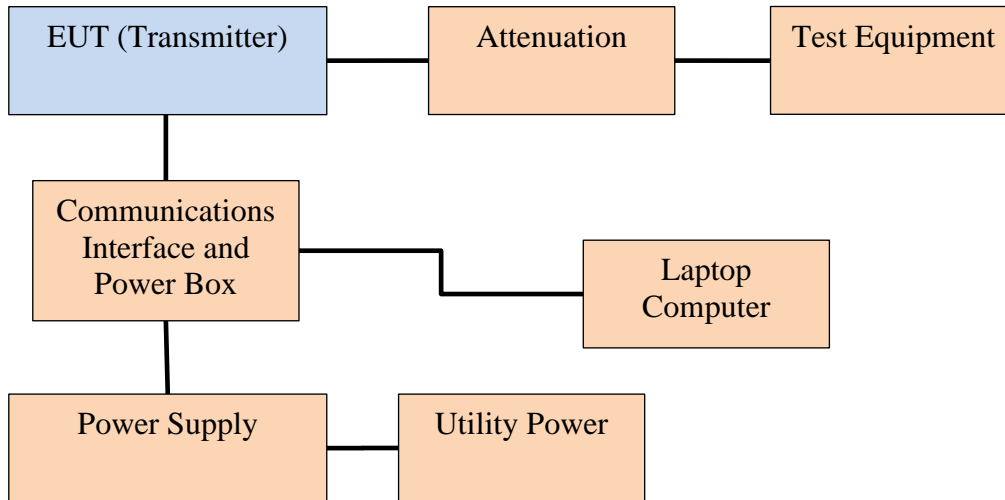

The radio frequency output was coupled to a Rohde &Schwarz ESU40 Spectrum Analyzer. The spectrum analyzer was used to observe the radio frequency spectrum with the transmitter operating in its normal mode.

The transmitter operates as licensed LMS equipment providing operation in two modes, Continuous Wave (CW) and digital data transmitted signals modulated in amplitude/width/duration. The EUT demonstrated compliance with the specifications of Paragraphs 2.1046(a), 90.205 and RSS-137. There are no deviations to the specifications.

TEST #3 Occupied Bandwidth

Measurements Required

The occupied bandwidth, that is the frequency bandwidth such that below its lower and above its upper frequency limits, the mean powers radiated are equal to 0.5 percent of the total mean power radiated by a given emission. Refer to figures 8 through 12 displaying plots of the occupied bandwidth measurement.

Test Arrangement

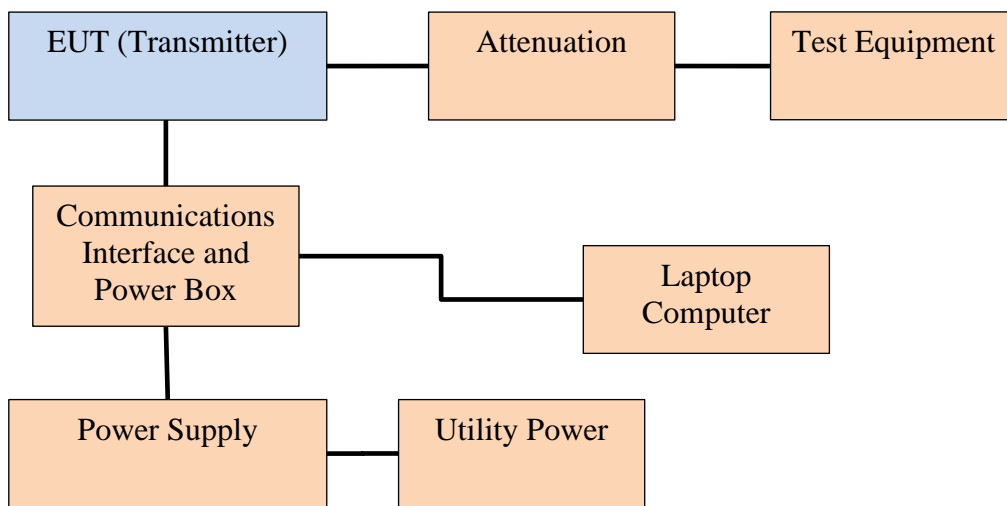

Table 2 Occupied Bandwidth Results

Operational mode	Operational Frequency Band (MHz)	Occupied Bandwidth (kHz)
ATA	902.25-903.75	110.0
ATA	910.00-921.50	110.0
eGo	911.75-919.75	318.0
SeGo	911.75-919.75	489.0
IAG	911.75-919.75	344.0
EPC	911.75-919.75	424.5

The EUT demonstrated compliance with the requirements of Paragraphs 2.1046(a) 90.209 and RSS-137 paragraph 6.1.2. There are no deviations to the specifications.

Figure 7 Occupied Bandwidth CW (ATA)

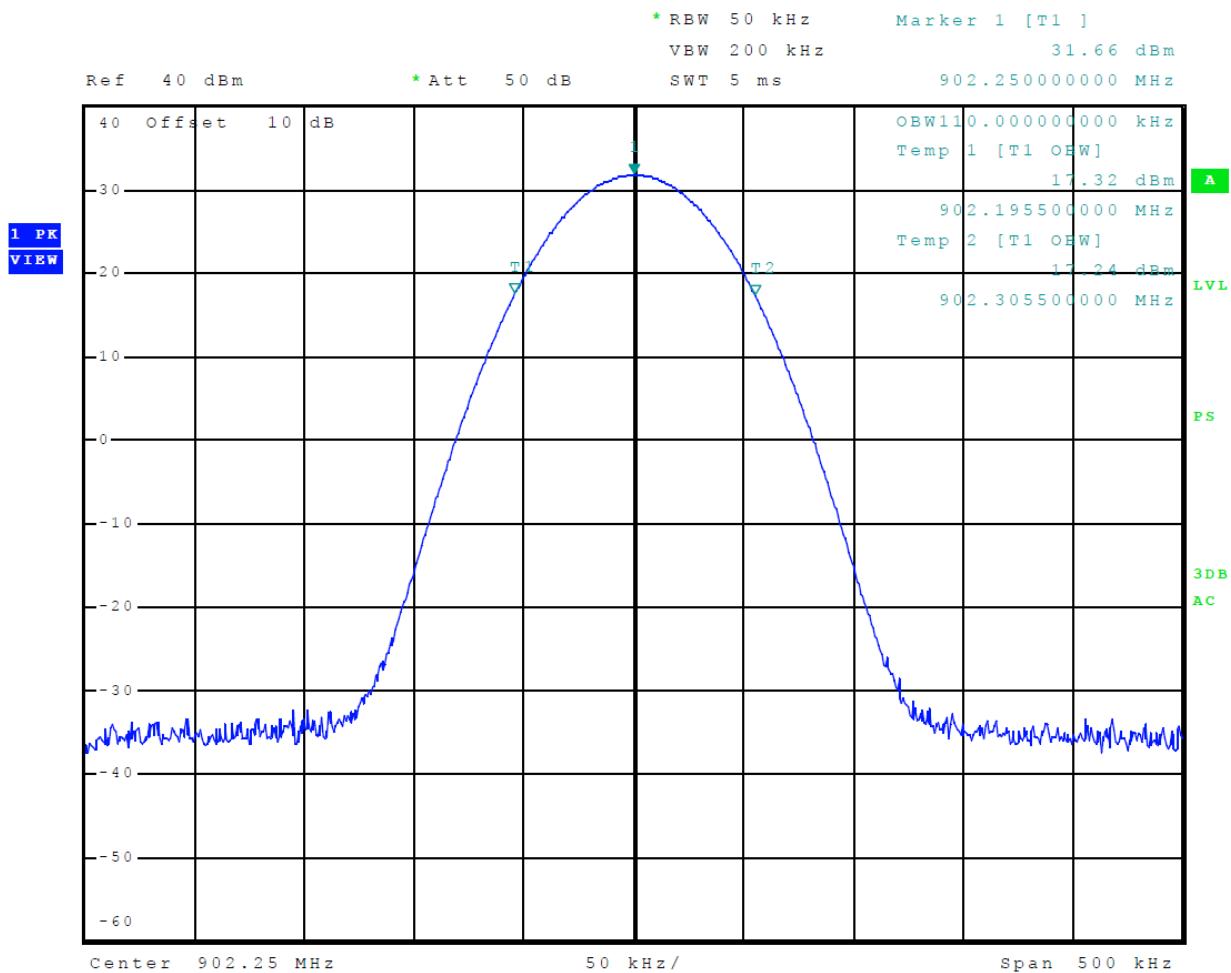

Figure 8 Occupied Bandwidth eGo

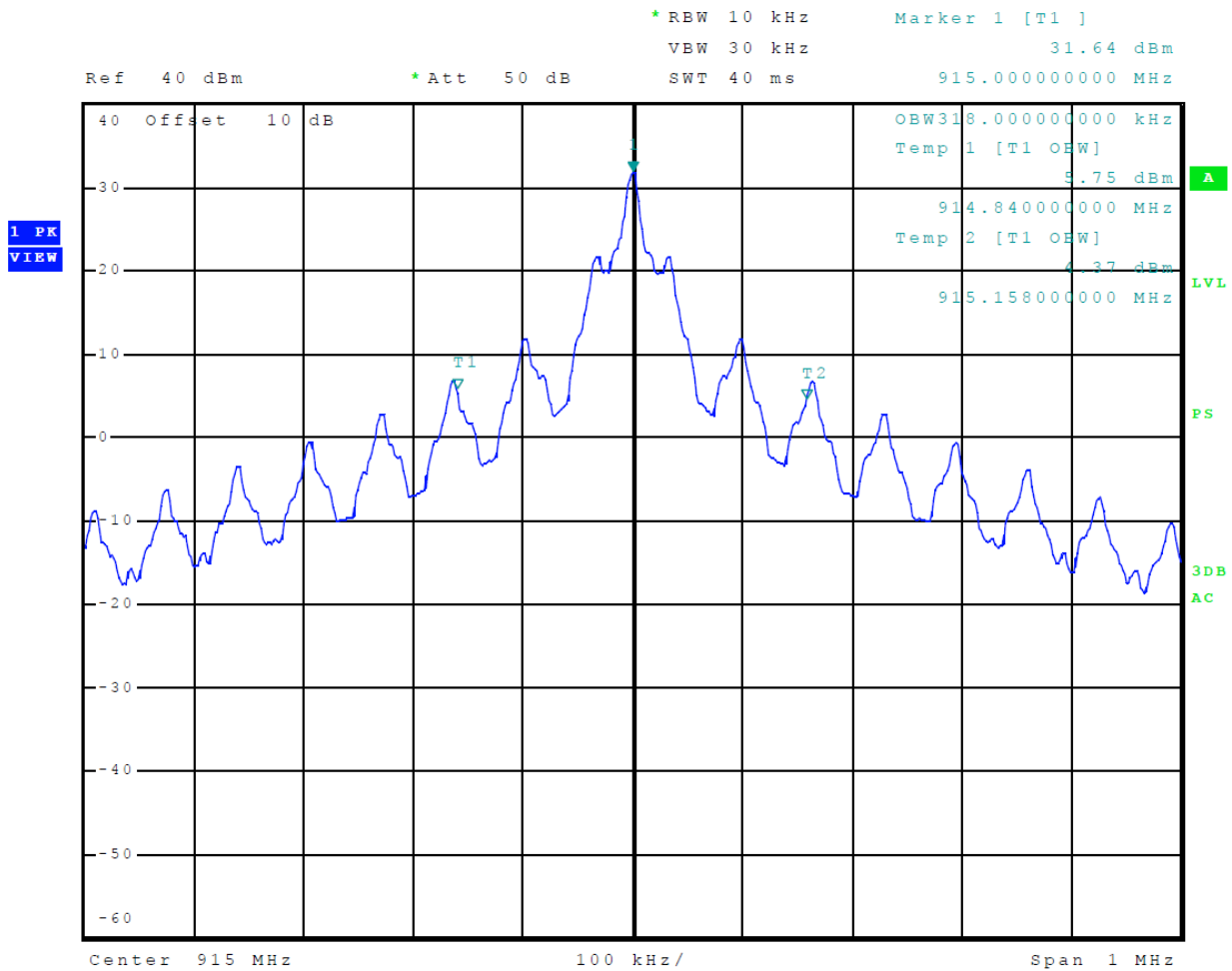

Figure 9 Occupied Bandwidth SeGo

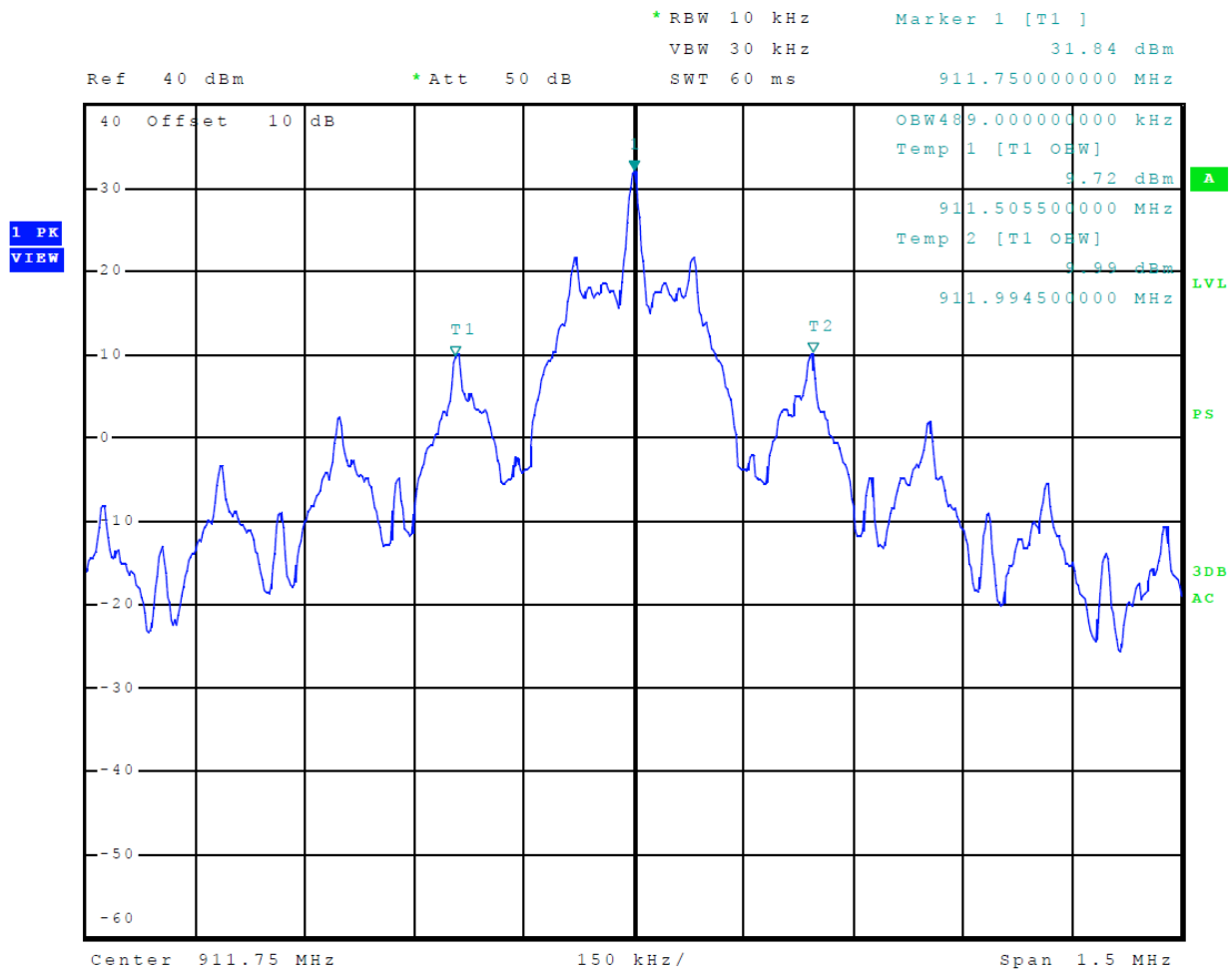

Figure 10 Occupied Bandwidth IAG

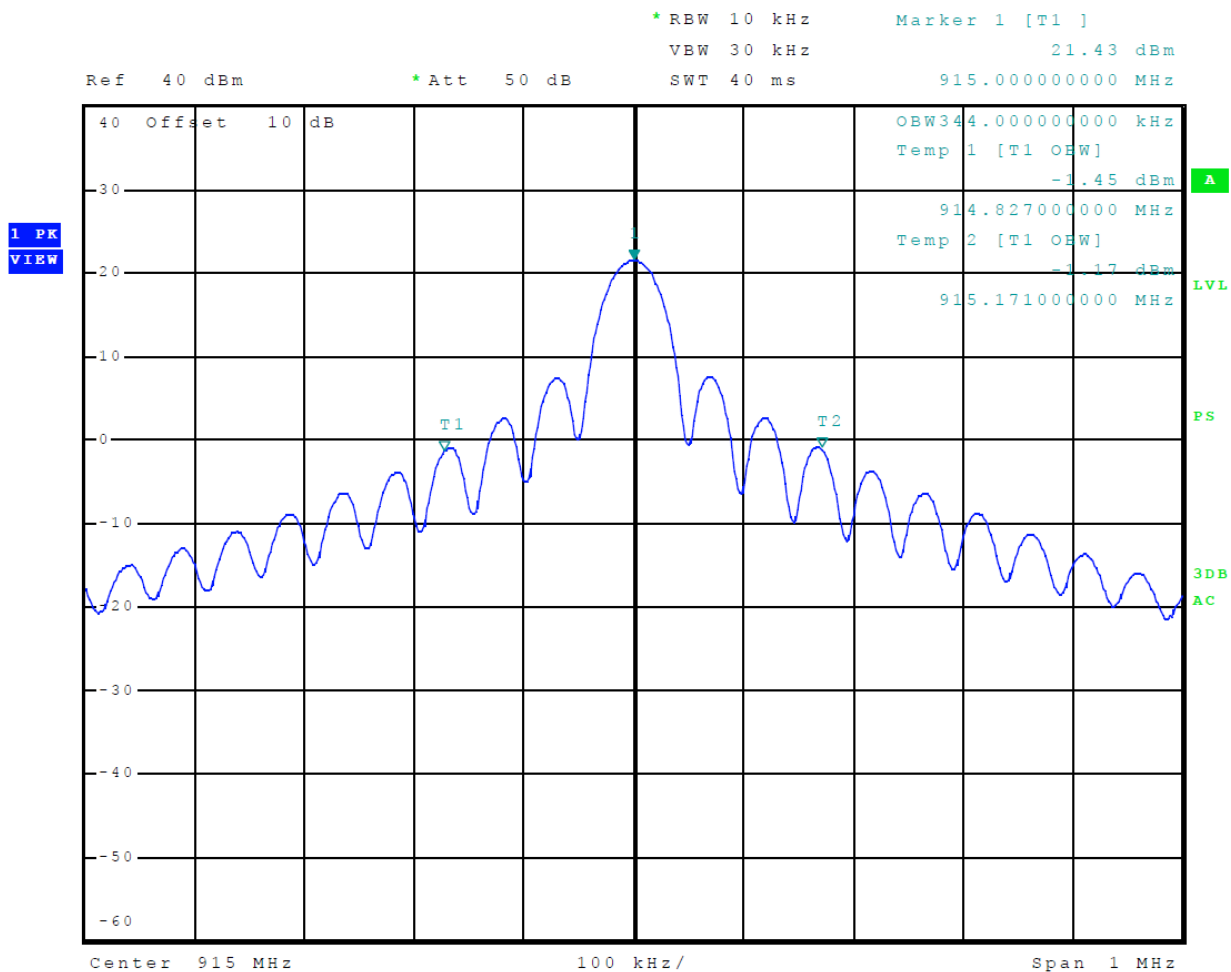
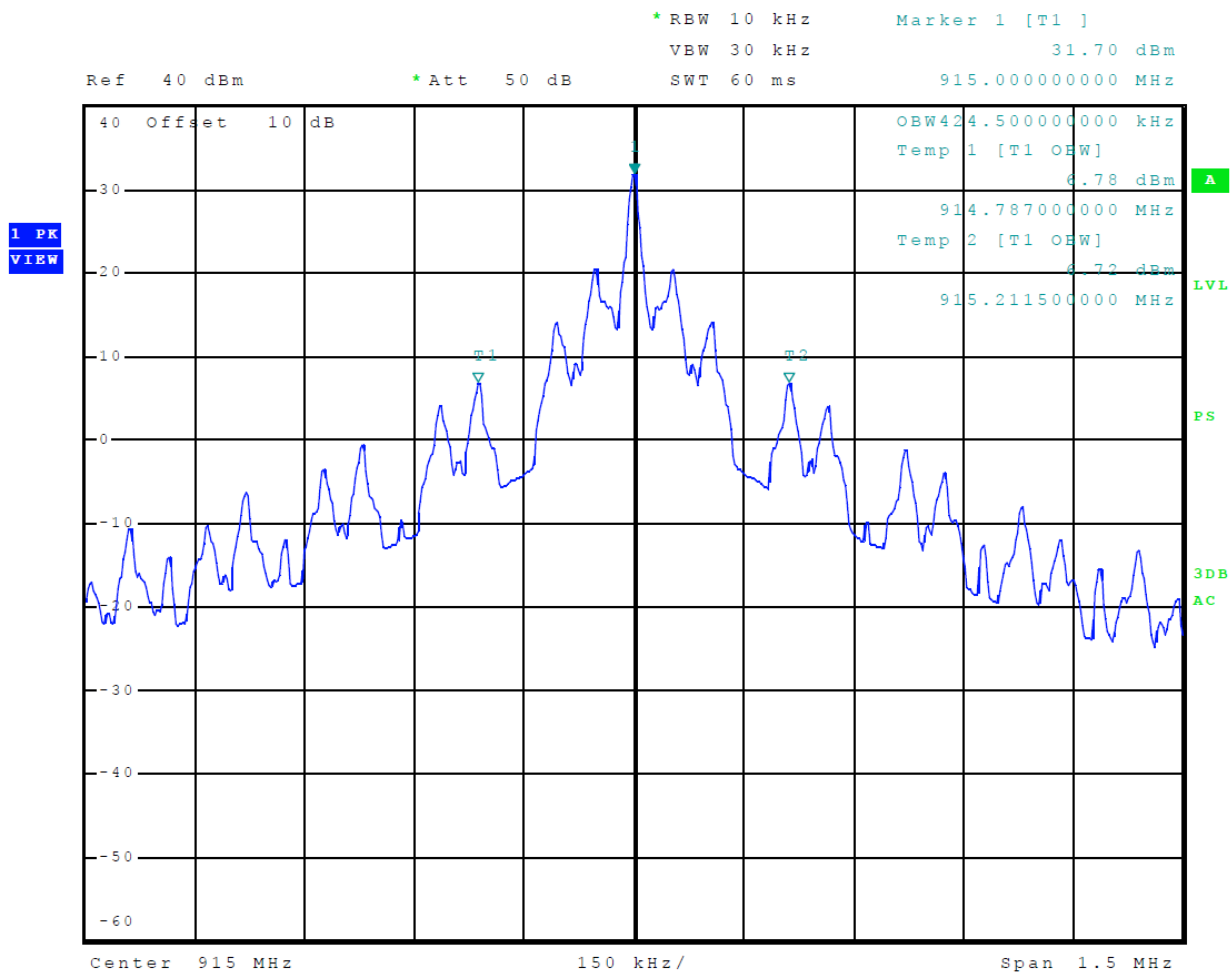

Figure 11 Occupied Bandwidth EPC



TEST #4 Spurious Emissions

Measurements Required

The radio frequency voltage or power generated within the equipment and appearing on a spurious frequency shall be checked at the equipment output terminals when properly loaded with a suitable artificial antenna. To gain dynamic range in the test equipment, a high pass filter attenuated the fundamental frequency of operation was used to observe the harmonic emissions.

Test Arrangement

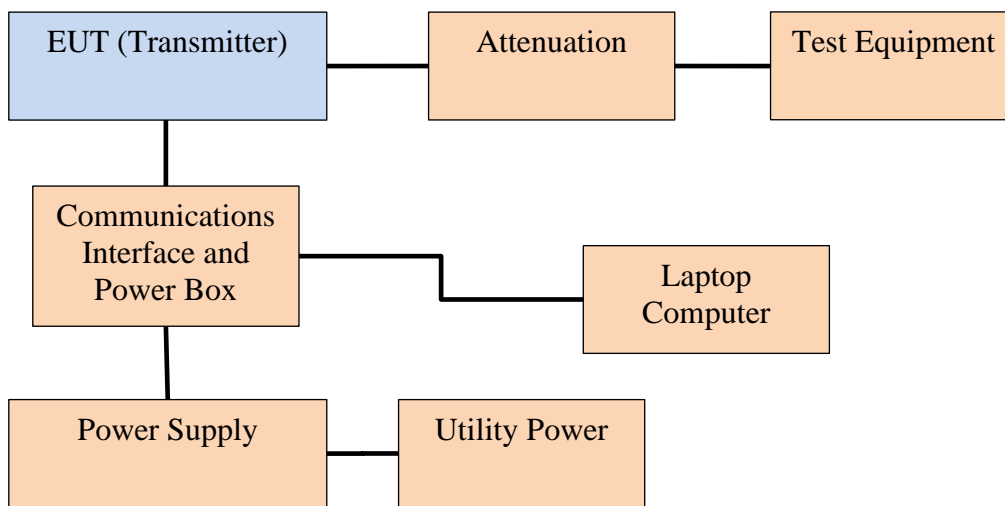

The radio frequency output was coupled to a Rohde & Schwarz ESU40 Spectrum Analyzer. The spectrum analyzer was used to observe the radio frequency spectrum with the transmitter operating in its normal modes. The frequency spectrum from 9 kHz to 10 GHz was observed. Data was taken per 47CFR 2.1051 and applicable paragraphs of Part 90 and RSS-137.

Limit: Spurious emissions must be attenuated below the peak output power by the at least $55 + 10 \text{ Log}(P_o)$ dB.

2.0 -watt transmitter limit requires the out of band emissions must be suppressed by at least 58.0 dBc

$$\begin{aligned} \text{Attenuation} &= 55 + 10 \text{ Log}_{10}(P_w) \\ &= 55 + 10 \text{ Log}_{10}(2) \\ &= 58.0 \text{ dBc} \end{aligned}$$

Table 3 Spurious Emissions Results CW (ATA) (Maximum Power)

Channel MHz	Spurious Freq. (MHz)	Measured Level (dBm)	Level Below Carrier (dBc)
902.25	1804.5	-38.50	71.5
	2706.8	-72.80	105.8
	3609.0	-82.40	115.4
	4511.3	-88.50	121.5
	5413.5	-77.70	110.7
910.00	6315.8	-90.20	123.2
	1820.0	-34.90	67.8
	2730.0	-71.20	104.1
	3640.0	-90.40	123.3
	4550.0	-88.80	121.7
921.50	5460.0	-80.90	113.8
	6370.0	-90.20	123.1
	1843.0	-39.90	72.7
	2764.5	-68.70	101.5
	3686.0	-86.60	119.4
	4607.5	-89.20	122.0
	5529.0	-75.70	108.5
	6450.5	-86.80	119.6

Data was taken per 2.1051 and applicable parts of 47CFR 90.210 and RSS-137. The EUT demonstrated compliance with the specifications of Paragraphs 47CFR 2.1051, 2.1057 and 90.210(k) and RSS-137 paragraph 6.5. There are no deviations to the specifications.

Table 4 Spurious Emissions Results CW (ATA) (Minimum Power)

Channel MHz	Spurious Freq. (MHz)	Measured Level (dBm)	Level Below Carrier (dBc)
902.25	1804.5	-68.60	86.8
	2706.8	-84.80	103.0
	3609.0	-86.40	104.6
	4511.3	-88.60	106.8
	5413.5	-78.30	96.5
910.00	6315.8	-89.40	107.6
	1820.0	-63.30	80.5
	2730.0	-82.70	99.9
	3640.0	-89.80	107.0
	4550.0	-88.60	105.8
921.50	5460.0	-79.20	96.4
	6370.0	-91.31	108.5
	1843.0	-70.00	87.2
	2764.5	-84.50	101.7
	3686.0	-89.10	106.3
	4607.5	-88.60	105.8
	5529.0	-81.00	98.2
	6450.5	-89.30	106.5

Data was taken per 2.1051 and applicable parts of 47CFR 90.210 and RSS-137. The EUT demonstrated compliance with the specifications of Paragraphs 47CFR 2.1051, 2.1057 and 90.210(k) and RSS-137 paragraph 6.5. There are no deviations to the specifications.

Table 5 Spurious Emissions Results eGo

Channel MHz	Spurious Freq. (MHz)	Measured Level (dBm)	Level Below Carrier (dBc)
911.75	1823.5	-34.30	66.6
	2735.3	-72.90	105.2
	3647.0	-90.10	122.4
	4558.8	-88.70	121.0
	5470.5	-77.30	109.6
	6382.3	-90.70	123.0
915.0	1830.0	-35.40	67.7
	2745.0	-82.50	114.8
	3660.0	-87.40	119.7
	4575.0	-89.60	121.9
	5490.0	-76.30	108.6
	6405.0	-90.20	122.5
919.75	1839.5	-38.90	71.2
	2759.3	-70.40	102.7
	3679.0	-86.10	118.4
	4598.8	-89.40	121.7
	5518.5	-77.80	110.1
	6438.3	-87.30	119.6

Data was taken per 2.1051 and applicable parts of 47CFR 90.210 and RSS-137. The EUT demonstrated compliance with the specifications of Paragraphs 47CFR 2.1051, 2.1057 and 90.210(k) and RSS-137 paragraph 6.5. There are no deviations to the specifications.

Table 6 Spurious Emissions Results SeGo

Channel MHz	Spurious Freq. (MHz)	Measured Level (dBm)	Level Below Carrier (dBc)
911.75	1823.5	-34.40	66.9
	2735.3	-73.00	105.5
	3647.0	-89.90	122.4
	4558.8	-89.30	121.8
	5470.5	-77.50	110.0
	6382.3	-90.50	123.0
915.0	1830.0	-35.00	67.5
	2745.0	-83.60	116.1
	3660.0	87.50	-55.0
	4575.0	-89.32	121.8
	5490.0	-76.50	109.0
	6405.0	-35.00	67.5
919.75	1839.5	-38.60	71.1
	2759.3	-71.00	103.5
	3679.0	-84.70	117.2
	4598.8	-88.90	121.4
	5518.5	-77.50	110.0
	6438.3	-86.50	119.0

Data was taken per 2.1051 and applicable parts of 47CFR 90.210 and RSS-137. The EUT demonstrated compliance with the specifications of Paragraphs 47CFR 2.1051, 2.1057 and 90.210(k) and RSS-137 paragraph 6.5. There are no deviations to the specifications.

Table 7 Spurious Emissions Results IAG

Channel MHz	Spurious Freq. (MHz)	Measured Level (dBm)	Level Below Carrier (dBc)
911.75	1823.5	-41.60	74.1
	2735.3	-77.60	110.1
	3647.0	-89.20	121.7
	4558.8	-88.90	121.4
	5470.5	-78.60	111.1
	6382.3	-90.60	123.1
915.0	1830.0	-42.70	75.1
	2745.0	-88.10	120.5
	3660.0	-89.70	122.1
	4575.0	-89.40	121.8
	5490.0	-78.40	110.8
	6405.0	-90.10	122.5
919.75	1839.5	-46.80	79.2
	2759.3	-75.30	107.7
	3679.0	-89.50	121.9
	4598.8	-88.90	121.3
	5518.5	-80.40	112.8
	6438.3	-90.90	123.3

Data was taken per 2.1051 and applicable parts of 47CFR 90.210 and RSS-137. The EUT demonstrated compliance with the specifications of Paragraphs 47CFR 2.1051, 2.1057 and 90.210(k) and RSS-137 paragraph 6.5. There are no deviations to the specifications.

Table 8 Spurious Emissions Results EPC

Channel MHz	Spurious Freq. (MHz)	Measured Level (dBm)	Level Below Carrier (dBc)
911.75	1823.5	-34.50	66.9
	2735.3	-72.70	105.1
	3647.0	-89.90	122.3
	4558.8	-89.20	121.6
	5470.5	-77.40	109.8
	6382.3	-90.70	123.1
915.0	1830.0	-34.60	67.1
	2745.0	-81.80	114.3
	3660.0	-87.90	120.4
	4575.0	-89.20	121.7
	5490.0	-76.30	108.8
	6405.0	-90.20	122.7
919.75	1839.5	-38.80	71.3
	2759.3	-70.60	103.1
	3679.0	-86.40	118.9
	4598.8	-87.90	120.4
	5518.5	-78.10	110.6
	6438.3	-87.90	120.4

Data was taken per 2.1051 and applicable parts of 47CFR 90.210 and RSS-137. The EUT demonstrated compliance with the specifications of Paragraphs 47CFR 2.1051, 2.1057 and 90.210(k) and RSS-137 paragraph 6.5. There are no deviations to the specifications.

TEST #5 Emission Mask

Measurements Required

Transmitters used in the radio services governed by this part must comply with the emissions masks outlined in this section. Paragraph 90.210(K)(3) specifies the out of band emission limitations for this equipment. The spurious emissions for the device were measured at the maximum output power condition.

90.210 (k)

(3) *Other transmitters.* For all other transmitters authorized under subpart M that operate in the 902-928 MHz band, the peak power of any emission shall be attenuated below the power of the highest emission contained within the licensee's sub-band in accordance with the following schedule:

(i) On any frequency within the authorized bandwidth: Zero dB.

(ii) On any frequency outside the licensee's sub-band edges: $55 + 10 \log(P)$ dB, where (P) is the highest emission (watts) of the transmitter inside the licensee's sub-band.

(4) In the 902-928 MHz band, the resolution bandwidth of the instrumentation used to measure the emission power shall be 100 kHz, except that, in regard to paragraph (2) of this section, a minimum spectrum analyzer resolution bandwidth of 300 Hz shall be used for measurement center frequencies with 1 MHz of the edge of the authorized subband.

RSS-137

6.5.3 Emission Mask C – Other Transmitters

Except as provided in sections 6.5.1, 6.5.2 and 6.5.4, the unwanted emission of all other transmitters operating in the band 902-928 MHz shall comply with the following:

The power of any emission outside the equipment operating sub-band edge shall be attenuated below the maximum permitted output power P_{max} by at least $55 + 10 \log_{10} P_{max}$ dB

Emission Mask Calculation for this equipment: $Limit = 55 + 10 \log_{10}(2)$ which equates to 58 dBc.
 33 dBm minus 58 = -25 dBm limit

Test Arrangement

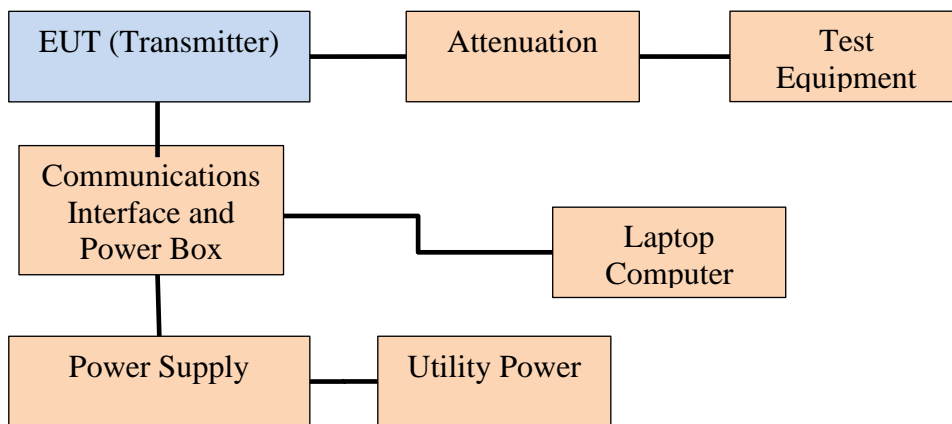

The radio frequency output was coupled to a Rohde & Schwarz ESU40 Spectrum Analyzer. The spectrum analyzer was used to observe the radio frequency spectrum with the transmitter operating through normal modes with maximum output power. The frequency spectrum at the band edges were observed and plots produced. Refer to figures 13 through 21 for plots presenting compliance with emission mask requirements at the band edges. Data was taken per 47CFR 2.1051 and applicable parts of Part 90.210 (k)(3) and RSS-137.

The EUT demonstrated compliance with the specifications of Paragraphs 47CFR 2.1051, 2.1057 and 90.210(k) and RSS-137 paragraph 6.5. There are no deviations to the specifications.

Figure 12 Emissions Mask ATA

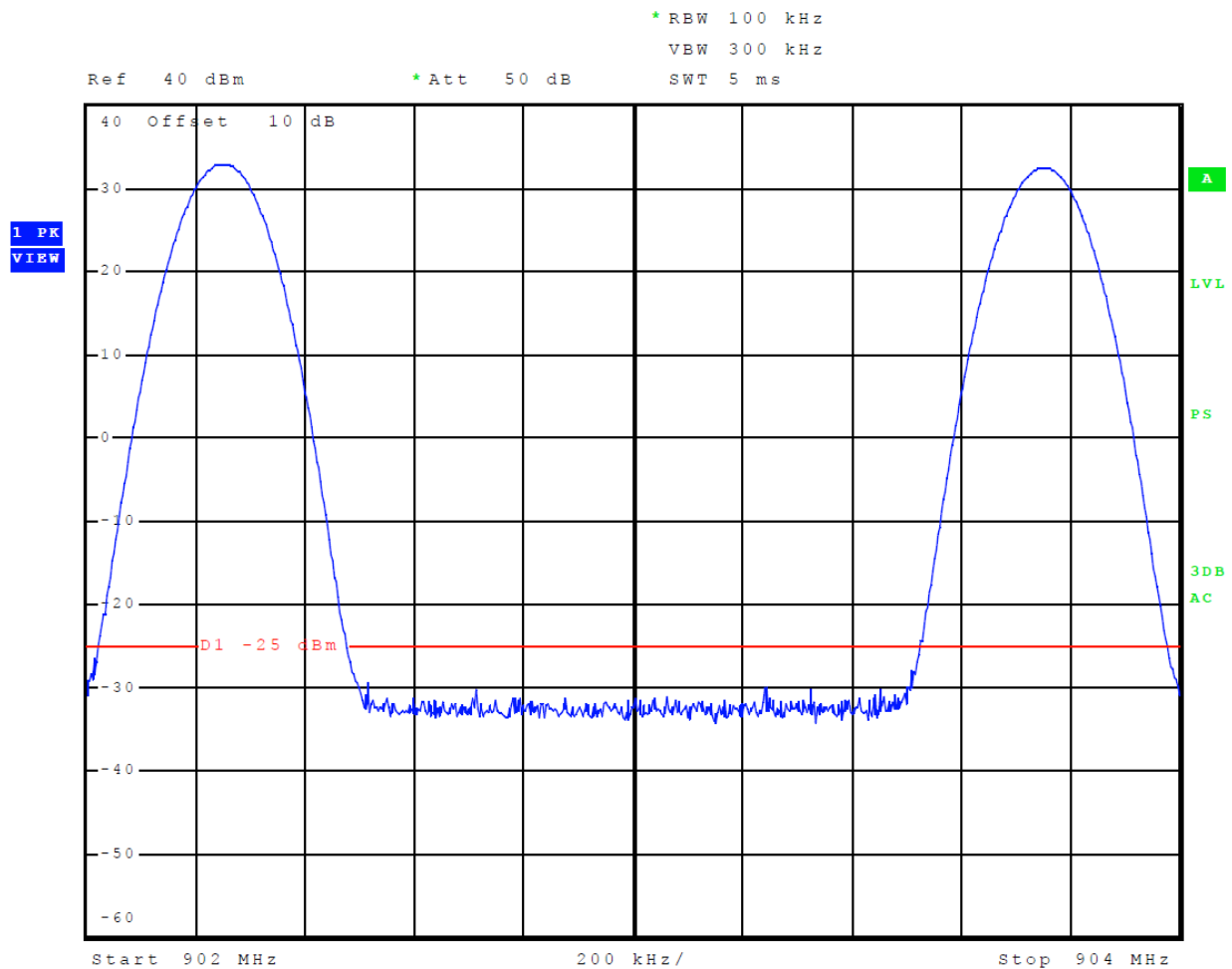

Figure 13 Emissions Mask ATA

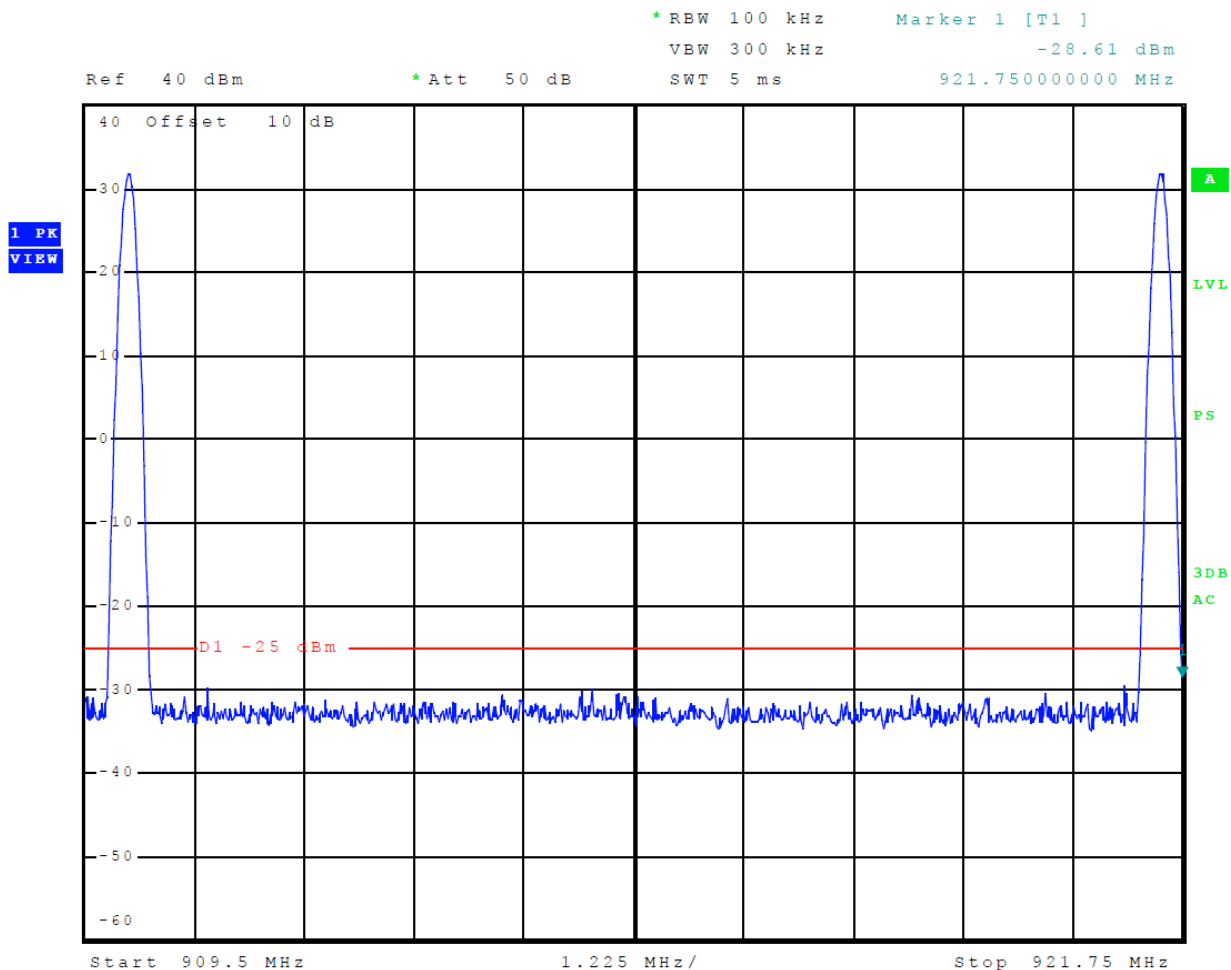

Figure 14 Emissions Mask eGo

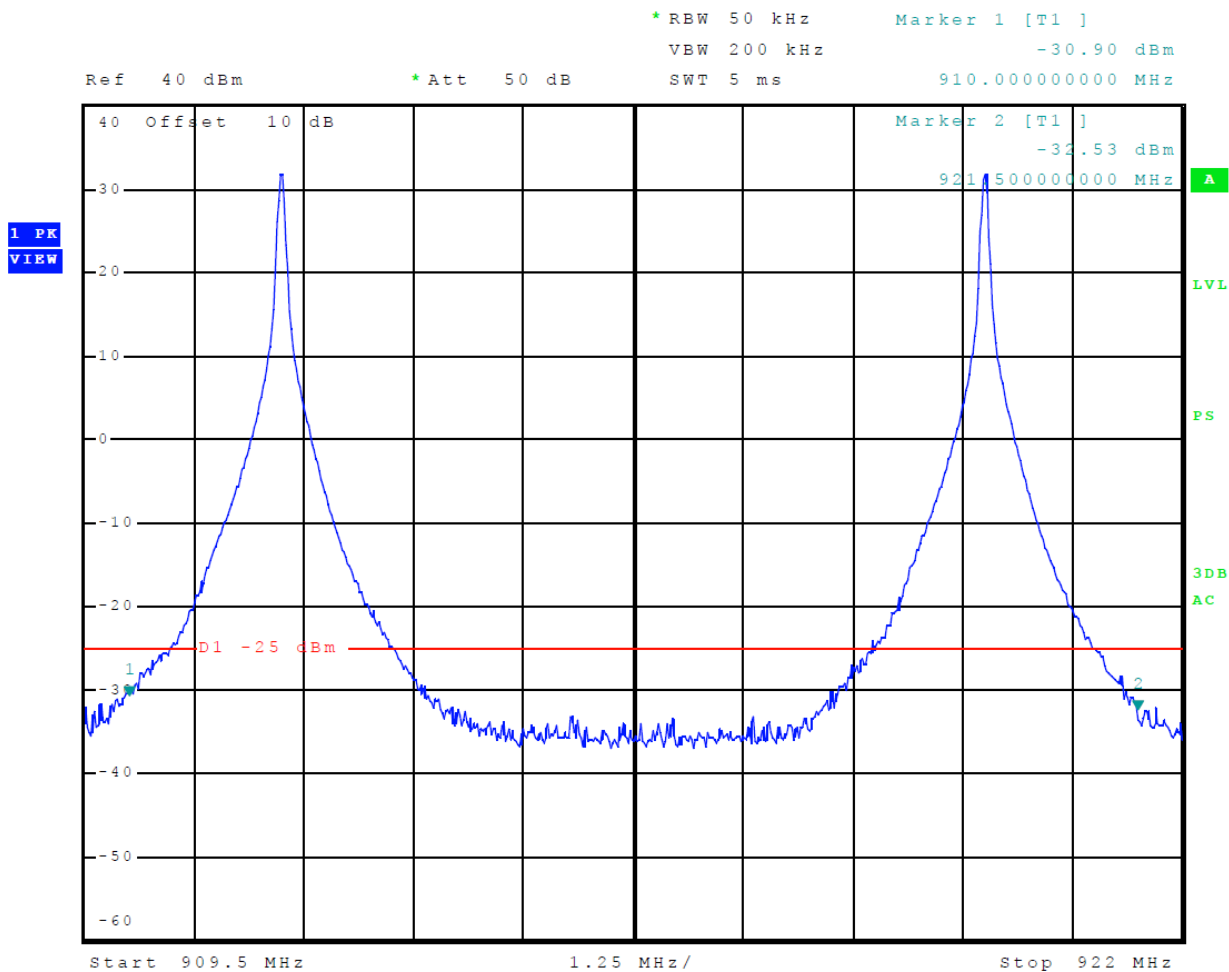

Figure 15 Emissions Mask SeGo

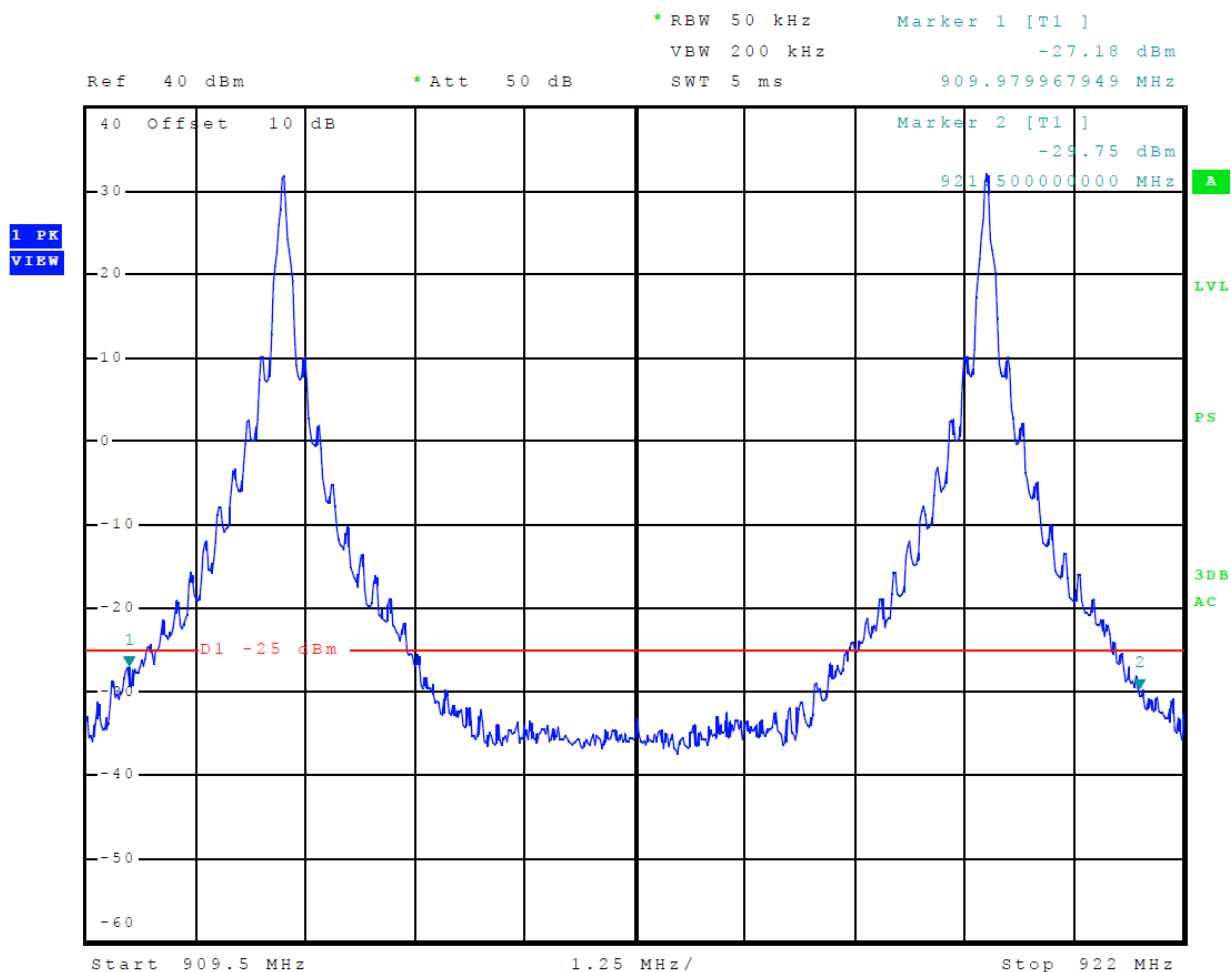

Figure 16 Emissions Mask IAG

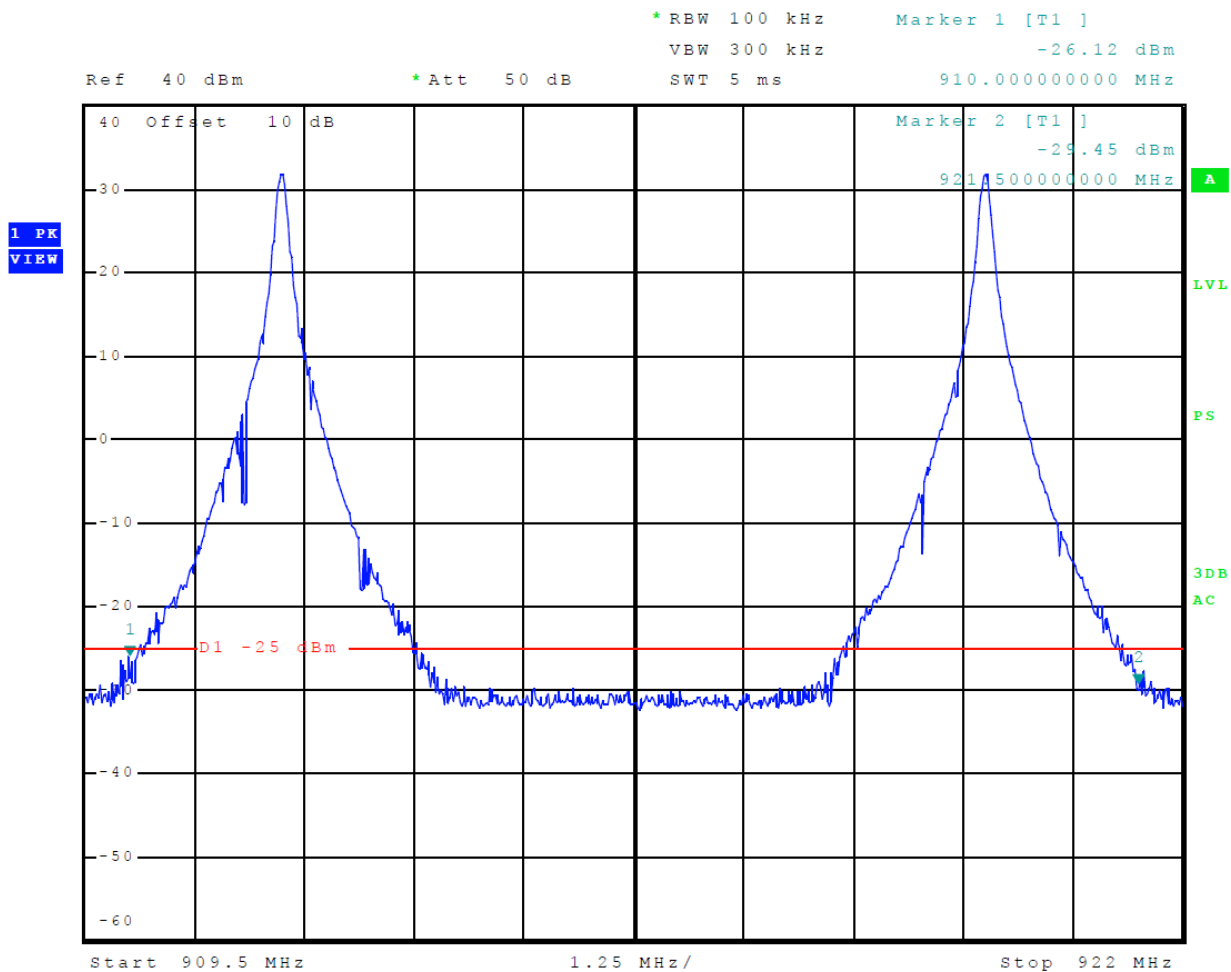
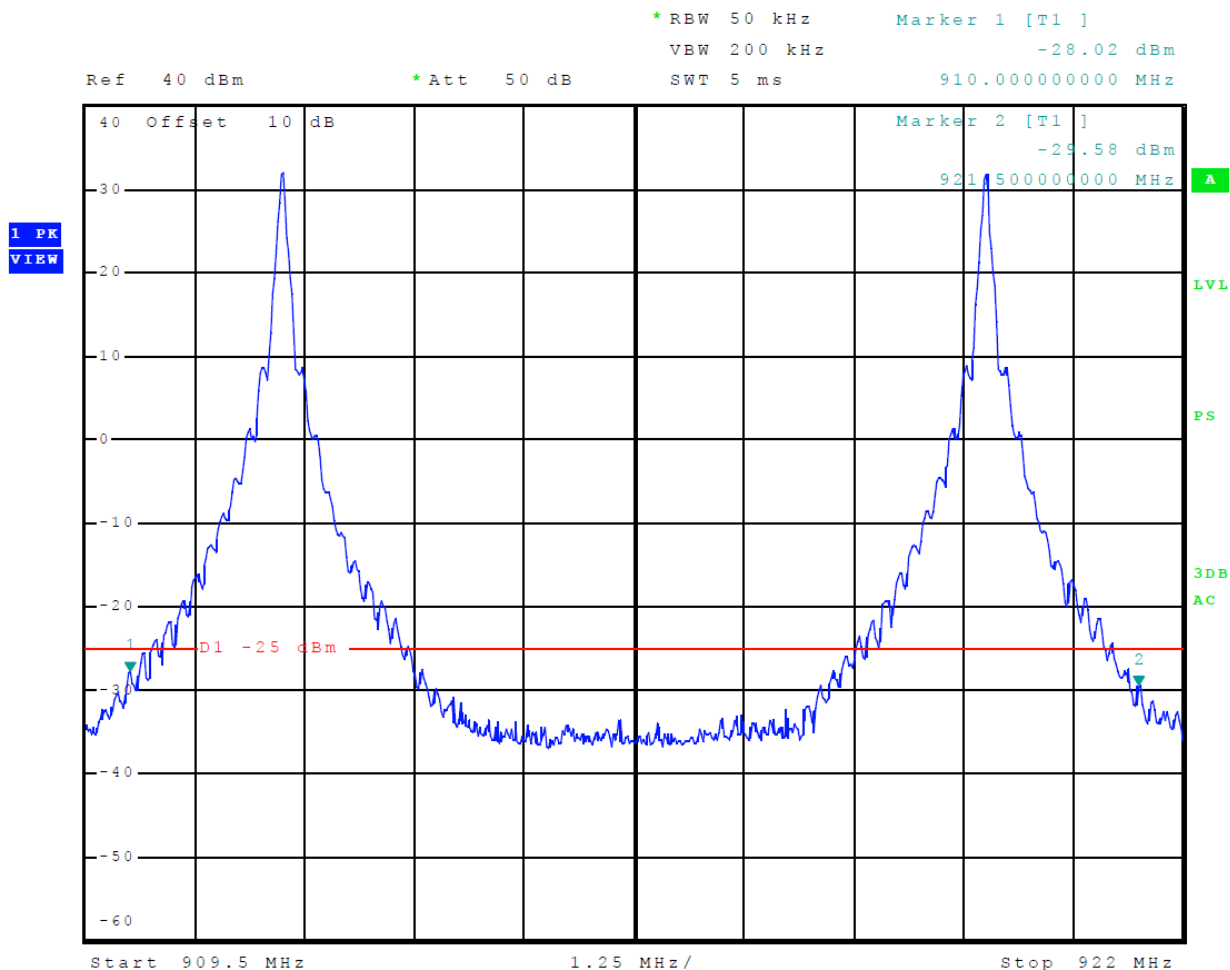

Figure 17 Emissions Mask EPC



TEST #6 Field Strength of Spurious Radiation

Measurements Required

Measurements shall be made to detect spurious emissions that may be radiated directly from the cabinet, control circuits, power leads, or intermediate circuit elements under normal conditions of installation and operation.

Test Arrangement

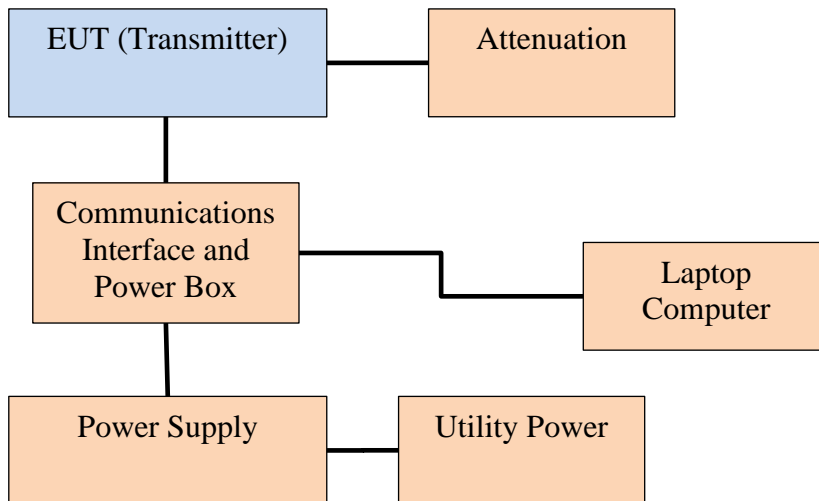

Preliminary radiated emissions investigation was made in a screen room to determine frequencies of emissions for investigation on the Open Area Test Site (OATS). The transmitter spurious emissions were measured on the OATS. The EUT was placed on a turntable elevated as required above the ground plane at a distance of 3 meters from the FSM antenna. The turntable was rotated through 360 degrees to locate the position registering the highest amplitude emission. The frequency spectrum was then searched for spurious emissions generated from the transmitter. Raising and lowering the FSM antenna and rotating the turntable to maximize the emission. Data was measured and recorded for the maximum amplitude of each spurious emission. A Loop antenna was used for measuring emissions from 0.009 to 30 MHz, Biconilog Antenna for 30 to 1000 MHz, Double-Ridge, and/or Pyramidal Horn Antennas above 1 GHz. Emissions were measured in dB μ V/m @ 3 meters. The substitution method was used to measure

harmonic emissions. Harmonic emission levels from the EUT were measured and amplitude levels were recorded. The EUT transmitter was then removed and replaced with a substitution antenna, which was powered from a signal generator. The output signal from the generator was then adjusted such that the amplitude received was the same as that previously recorded for each frequency. This step was repeated for both horizontal and vertical polarizations. The power in dBm required to produce the desired signal level was then recorded from the signal generator. The power in dBm was then calculated by reducing the previous readings by the gain in the substitution antenna.

The limits for the spurious radiated emissions are defined by the following equation.

Limit = Amplitude of the spurious emission must be attenuated by this amount below the level of the fundamental. On any frequency removed from the assigned frequency outside the assigned sub-band edges: at least $55 + 10 \text{ Log}(P_w)$ dB.

Emission requirement for 2.0-watt transmitter power requires spurious emissions be attenuated at least 58.0 dBc below the carrier.

$$\begin{aligned} \text{Attenuation} &= 55 + 10 \text{ Log}_{10}(P_w) \\ &= 55 + 10 \text{ Log}_{10}(2.0) \\ &= 58.0 \text{ dBc} \end{aligned}$$

Data was taken per 2.1051 and applicable parts of 47CFR 90. The EUT demonstrated compliance with the specifications of Paragraphs 47CFR 2.1051, 2.1057 and 90.210(k) and RSS-137 paragraph 6.5. There are no deviations to the specifications.

Table 9 General Radiated Emission Results (worst-case)

Frequency	Amplitude of Emission (dB μ V)		Signal Level to dipole required to Reproduce(dBm)		Emission level below carrier (dBc)		Limit (dBc)
	MHz	Horizontal	Vertical	Horizontal	Vertical	Horizontal	
63.5	33.1	34.5	-62.1	-60.7	95.1	93.7	58
96.0	31.2	35.5	-64.0	-59.7	97.0	92.7	58
108.2	28.9	28.7	-66.3	-66.5	99.3	99.5	58
120.2	33.4	32.2	-61.8	-63.0	94.8	96.0	58
132.2	33.7	34.2	-61.5	-61.0	94.5	94.0	58
180.3	34.0	28.8	-61.2	-66.4	94.2	99.4	58
233.2	30.3	22.4	-64.9	-72.8	97.9	105.8	58
336.5	39.7	34.0	-55.5	-61.2	88.5	94.2	58

Other emissions present had amplitudes at least 20 dB below the limit. Peak and Quasi-Peak amplitude emissions are recorded above for frequency range of 30-1000 MHz. Peak and Average amplitude emissions are recorded above for frequency range above 1000 MHz.

TEST #7 Frequency Stability

Measurements Required

The frequency stability shall be measured with variations of ambient temperature from -30° to +50° centigrade. Measurements shall be made at the extremes of the temperature range and at intervals of not more than 10° centigrade through the range. A period sufficient to stabilize all of the components of the oscillator circuit at each temperature level shall be allowed prior to frequency measurement. In addition to temperature stability, the frequency stability shall be measured with variation of primary supply voltage as follows:

- (1) Vary primary supply voltage from 85 to 115 percent of the nominal value.
- (2) The supply voltage shall be measured at the input to the cable normally provided with the equipment, or at the power supply terminals if cables are not normally provided.

Test Arrangement

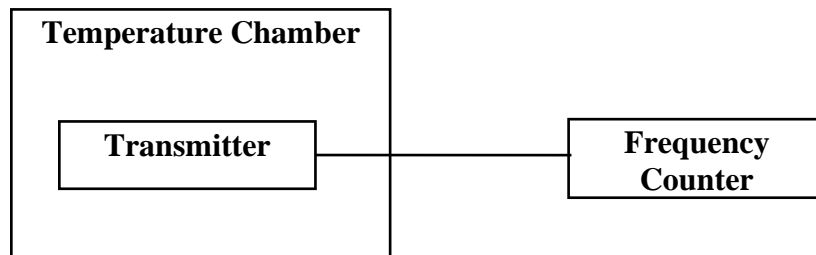

The measurement procedure outlined below shall be followed for frequency stability testing.

Step 1: The transmitter shall be installed in an environmental test chamber whose temperature is controllable. Provision shall be made to measure the frequency of the transmitter.

Step 2: With the transmitter inoperative (power switched “OFF”), the temperature of the test chamber shall be adjusted to +25°C. After a temperature stabilization period of one hour at +25°C, the transmitter shall be switched “ON” with standard test voltage applied.

Step 3: The carrier shall be keyed “ON”, and the transmitter shall be operated at full radio frequency power output at the duty cycle, for which it is rated, for duration of at least 5 minutes. The radio frequency carrier frequency shall be monitored, and measurements shall be recorded.

Step 4: The test procedures outlined in Steps 2 and 3, shall be repeated after stabilizing the transmitter at the environmental temperatures specified, -30°C to +50°C in 10-degree increments.

Table 10 Frequency Stability vs. Temperature Results

Frequency 915.002003 MHz)	Frequency Stability Vs. Temperature Ambient Frequency (915.002003)								
	Temperature °C	-30	-20	-10	0	+10	+20	+30	+40
Change (Hz)	-69	-74	-78	-72	-22	9	-56	-88	-119
PPM	-0.075	-0.081	-0.085	-0.079	-0.024	0.010	-0.061	-0.096	-0.130
%	0.000	0.000	0.000	0.000	0.000	0.000	0.000	0.000	0.000
Limit (PPM)	N/A	N/A	N/A	N/A	N/A	N/A	N/A	N/A	N/A

Table 11 Frequency Stability vs. Input Power Supply Voltage Results

Frequency (910.0000 MHz)	Frequency Stability Vs. Voltage Variation 18 volts nominal; Results in Hz change		
	Voltage V _{dc}	20.4	24.0
Change (Hz)	0	0	0
Limit (PPM)	N/A	N/A	N/A

Frequency stability is not required for this device per 47CFR 90.213(a) Note: 13 and RSS-137. Frequency stability testing was performed.

The EUT demonstrated compliance with specifications of 47CFR Paragraph 2.1046(a) and applicable Parts of 90.213 and RSS-137. There are no deviations or exceptions to the specifications.

Annex

- Annex A Measurement Uncertainty Calculations
- Annex B Test Equipment List
- Annex C Rogers Qualifications
- Annex D Rogers Labs Certificate of Accreditation

Annex A Measurement Uncertainty Calculations

The measurement uncertainty was calculated for all measurements listed in this test report according To CISPR 16-4. Result of measurement uncertainty calculations are recorded below. Component and process variability of production devices similar to those tested may result in additional deviations. The manufacturer has the sole responsibility of continued compliance.

Measurement	Expanded Measurement Uncertainty $U_{(lab)}$
3 Meter Horizontal 0.009-1000 MHz Measurements	4.16
3 Meter Vertical 0.009-1000 MHz Measurements	4.33
3 Meter Measurements 1-18 GHz	5.14
3 Meter Measurements 18-40 GHz	5.16
10 Meter Horizontal Measurements 0.009-1000 MHz	4.15
10 Meter Vertical Measurements 0.009-1000 MHz	4.32
AC Line Conducted	1.75
Antenna Port Conducted power	1.17
Frequency Stability	1.00E-11
Temperature	1.6°C
Humidity	3%

Annex B Test Equipment List

<u>Equipment</u>	<u>Manufacturer</u>	<u>Model (SN)</u>	<u>Band</u>	<u>Cal Date(m/d/y)</u>	<u>Due</u>
<input type="checkbox"/> LISN	FCC	FCC-LISN-50-25-10(1PA) (160611)	.15-30MHz	4/6/2021	4/6/2022
<input type="checkbox"/> LISN	Compliance Design	FCC-LISN-2.Mod.cd,(126)	.15-30MHz	10/14/2020	10/14/2021
<input checked="" type="checkbox"/> Cable	Huber & Suhner Inc.	Sucoflex102ea(L10M)(303073)	9kHz-40 GHz	10/14/2020	10/14/2021
<input type="checkbox"/> Cable	Huber & Suhner Inc.	Sucoflex102ea(1.5M)(303069)	9kHz-40 GHz	10/14/2020	10/14/2021
<input checked="" type="checkbox"/> Cable	Huber & Suhner Inc.	Sucoflex102ea(1.5M)(303070)	9kHz-40 GHz	10/14/2020	10/14/2021
<input type="checkbox"/> Cable	Belden	RG-58 (L1-CAT3-11509)	9kHz-30 MHz	10/14/2020	10/14/2021
<input type="checkbox"/> Cable	Belden	RG-58 (L2-CAT3-11509)	9kHz-30 MHz	10/14/2020	10/14/2021
<input checked="" type="checkbox"/> Antenna	Com Power	AL-130 (121055)	.001-30 MHz	10/14/2020	10/14/2021
<input type="checkbox"/> Antenna:	EMCO	6509	.001-30 MHz	10/14/2020	10/14/2022
<input type="checkbox"/> Antenna	ARA	BCD-235-B (169)	20-350MHz	10/14/2020	10/14/2021
<input type="checkbox"/> Antenna:	Schwarzbeck Model	VHBB 9124 (1468)		10/14/2020	10/14/2022
<input checked="" type="checkbox"/> Antenna	Sunol	JB-6 (A100709)	30-1000 MHz	10/14/2020	10/14/2021
<input type="checkbox"/> Antenna	ETS-Lindgren	3147 (40582)	200-1000MHz	10/14/2020	10/14/2022
<input type="checkbox"/> Antenna:	Schwarzbeck Model:	VULP 9118 A (VULP 9118 A-534)		10/14/2020	10/14/2022
<input checked="" type="checkbox"/> Antenna	ETS-Lindgren	3117 (200389)	1-18 GHz	4/21/2020	4/21/2022
<input type="checkbox"/> Antenna	Com Power	AH-118 (10110)	1-18 GHz	10/14/2020	10/14/2022
<input type="checkbox"/> Antenna	Com Power	AH-840 (101046)	18-40 GHz	4/6/2021	4/6/2023
<input checked="" type="checkbox"/> Analyzer	Rohde & Schwarz	ESU40 (100108)	20Hz-40GHz	5/20/2021	5/20/2022
<input checked="" type="checkbox"/> Analyzer	Rohde & Schwarz	ESW44 (101534)	20Hz-44GHz	1/12/2021	1/12/2022
<input type="checkbox"/> Analyzer	Rohde & Schwarz	FS-Z60, 90, 140, and 220	40GHz-220GHz	12/22/2017	12/22/2027
<input checked="" type="checkbox"/> Amplifier	Com-Power	PA-010 (171003)	100Hz-30MHz	10/14/2020	10/14/2021
<input checked="" type="checkbox"/> Amplifier	Com-Power	CPPA-102 (01254)	1-1000 MHz	10/14/2020	10/14/2021
<input checked="" type="checkbox"/> Amplifier	Com-Power	PAM-118A (551014)	0.5-18 GHz	10/14/2020	10/14/2021
<input type="checkbox"/> Amplifier	Com-Power	PAM-840A (461328)	18-40 GHz	10/14/2020	10/14/2021
<input type="checkbox"/> Power Meter	Agilent	N1911A with N1921A	0.05-40 GHz	4/6/2021	4/6/2022
<input type="checkbox"/> Generator	Rohde & Schwarz	SMB100A6 (100150)	20Hz-6 GHz	4/6/2021	4/6/2022
<input type="checkbox"/> Generator	Rohde & Schwarz	SMBV100A6 (260771)	20Hz-6 GHz	4/6/2021	4/6/2022
<input type="checkbox"/> RF Filter	Micro-Tronics	BRC50722 (009).9G notch	30-18000 MHz	4/6/2021	4/6/2022
<input type="checkbox"/> RF Filter	Micro-Tronics	HPM50114 (017)1.5G HPF	30-18000 MHz	4/6/2021	4/6/2022
<input type="checkbox"/> RF Filter	Micro-Tronics	HPM50117 (063) 3G HPF	30-18000 MHz	4/6/2021	4/6/2022
<input type="checkbox"/> RF Filter	Micro-Tronics	HPM50105 (059) 6G HPF	30-18000 MHz	4/6/2021	4/6/2022
<input type="checkbox"/> RF Filter	Micro-Tronics	BRM50702 (172) 2G notch	30-18000 MHz	4/6/2021	4/6/2022
<input type="checkbox"/> RF Filter	Micro-Tronics	BRC50703 (G102) 5G notch	30-18000 MHz	4/6/2021	4/6/2022
<input type="checkbox"/> RF Filter	Micro-Tronics	BRC50705 (024) 5G notch	30-18000 MHz	4/6/2021	4/6/2022
<input type="checkbox"/> Attenuator	Fairview	SA6NFN100W-40 (1625)	30-18000 MHz	4/6/2021	4/6/2022
<input type="checkbox"/> Attenuator	Mini-Circuits	VAT-3W2+ (1436)	30-6000 MHz	4/6/2021	4/6/2022
<input type="checkbox"/> Attenuator	Mini-Circuits	VAT-3W2+ (1445)	30-6000 MHz	4/6/2021	4/6/2022
<input type="checkbox"/> Attenuator	Mini-Circuits	VAT-3W2+ (1735)	30-6000 MHz	4/6/2021	4/6/2022
<input type="checkbox"/> Attenuator	Mini-Circuits	VAT-6W2+ (1438)	30-6000 MHz	4/6/2021	4/6/2022
<input type="checkbox"/> Attenuator	Mini-Circuits	VAT-6W2+ (1736)	30-6000 MHz	4/6/2021	4/6/2022
<input checked="" type="checkbox"/> Weather station	Davis	6312 (A81120N075)		11/4/2020	11/4/2021

Rogers Labs, Inc.
 4405 West 259th Terrace
 Louisburg, KS 66053
 Phone/Fax: (913) 837-3214
 Revision 1

Transcore
 HVIN: E4SPT90V45
 Test: 210813
 Test to: 47CFR Parts 2, 90 and RSS-137
 File: Transcore E4SPT90V45 TstRpt 210813

SN: 111383 / 111388
 FCC ID: FIHE4SPT90V45
 IC: 1584A-E4SPT90V45
 Date: August 29, 2021
 Page 51 of 54

List of Test Equipment	Calibration	Date (m/d/y)	Due
<input type="checkbox"/> Antenna: Schwarzbeck Model VHBB 9124 (9124-627)		4/21/2020	4/21/2022
<input type="checkbox"/> Antenna: Schwarzbeck Model: VULP 9118 A (VULP 9118 A-534)		4/21/2020	4/21/2022
<input type="checkbox"/> Frequency Counter: Leader LDC-825 (8060153)		4/6/2021	4/6/2022
<input type="checkbox"/> LISN: Com-Power Model LI-220A		10/14/2020	10/14/2021
<input type="checkbox"/> LISN: Com-Power Model LI-550C		10/14/2020	10/14/2021
<input type="checkbox"/> ISN: Com-Power Model ISN T-8		4/6/2021	4/6/2022
<input type="checkbox"/> LISN: Fischer Custom Communications Model: FCC-LISN-50-16-2-08		4/6/2021	4/6/2022
<input type="checkbox"/> Cable Huber & Suhner Inc. Sucoflex102ea(1.5M)(303072) 9kHz-40 GHz		10/14/2020	10/14/2021
<input type="checkbox"/> Cable Huber & Suhner Inc. Sucoflex102ea(L1M)(281183) 9kHz-40 GHz		10/14/2020	10/14/2021
<input type="checkbox"/> Cable Huber & Suhner Inc. Sucoflex102ea(L4M)(281184) 9kHz-40 GHz		10/14/2020	10/14/2021
<input type="checkbox"/> Cable Huber & Suhner Inc. Sucoflex102ea(L10M)(317546)9kHz-40 GHz		10/14/2020	10/14/2021
<input type="checkbox"/> Cable Time Microwave 4M-750HF290-750 (4M) 9kHz-24 GHz		10/14/2020	10/14/2021
<input type="checkbox"/> RF Filter Micro-Tronics BRC17663 (001) 9.3-9.5 notch 30-1800 MHz		4/6/2021	4/6/2022
<input type="checkbox"/> RF Filter Micro-Tronics BRC19565 (001) 9.2-9.6 notch 30-1800 MHz		10/16/2018	4/6/2022
<input type="checkbox"/> Analyzer HP 8562A (3051A05950) 9kHz-125GHz		4/6/2021	4/6/2022
<input type="checkbox"/> Analyzer HP External Mixers11571, 11970 25GHz-110GHz		4/18/2015	4/18/2025
<input type="checkbox"/> Analyzer HP 8591EM (3628A00871)		4/21/2020	4/21/2022
<input type="checkbox"/> Wave Form Generator Keysight 33512B (MY57400128)		4/21/2020	4/6/2022
<input type="checkbox"/> Antenna: Solar 9229-1 & 9230-1		2/22/2021	2/22/2022
<input type="checkbox"/> CDN: Com-Power Model CDN325E		10/14/2020	10/14/2021
<input type="checkbox"/> Injection Clamp Luthi Model EM101		10/14/2020	10/14/2021
<input type="checkbox"/> Oscilloscope Scope: Tektronix MDO 4104		2/22/2021	2/22/2022
<input type="checkbox"/> EMC Transient Generator HVT TR 3000		2/22/2021	2/22/2022
<input type="checkbox"/> AC Power Source (Ametech, California Instruments)		2/22/2021	2/22/2022
<input type="checkbox"/> Field Intensity Meter: EFM-018		2/22/2021	2/22/2022
<input type="checkbox"/> ESD Simulator: MZ-15		2/22/2021	2/22/2022
<input type="checkbox"/> R.F. Power Amp ACS 230-50W			not required
<input type="checkbox"/> R.F. Power Amp EIN Model: A301			not required
<input type="checkbox"/> R.F. Power Amp A.R. Model: 10W 1010M7			not required
<input type="checkbox"/> R.F. Power Amp A.R. Model: 50U1000			not required
<input checked="" type="checkbox"/> Tenney Temperature Chamber			not required
<input checked="" type="checkbox"/> Shielded Room			not required

Annex C Rogers Qualifications

Scot D. Rogers, Engineer

Rogers Labs, Inc.

Mr. Rogers has approximately 36 years' experience in the field of electronics. Work experience includes six years working in the automated controls industry and remaining years working with the design, development and testing of radio communications and electronic equipment.

Positions Held:

Systems Engineer: A/C Controls Mfg. Co., Inc. 6 Years

Electrical Engineer: Rogers Consulting Labs, Inc. 5 Years

Electrical Engineer: Rogers Labs, Inc. Current

Educational Background:

- 1) Bachelor of Science Degree in Electrical Engineering from Kansas State University
- 2) Bachelor of Science Degree in Business Administration Kansas State University
- 3) Several Specialized Training courses and seminars pertaining to Microprocessors and Software programming.

Annex D Laboratory Certificate of Accreditation

United States Department of Commerce
National Institute of Standards and Technology



Certificate of Accreditation to ISO/IEC 17025:2017

NVLAP LAB CODE: 200087-0

Rogers Labs, Inc.
Louisburg, KS

*is accredited by the National Voluntary Laboratory Accreditation Program for specific services,
listed on the Scope of Accreditation, for:*

Electromagnetic Compatibility & Telecommunications

*This laboratory is accredited in accordance with the recognized International Standard ISO/IEC 17025:2017.
This accreditation demonstrates technical competence for a defined scope and the operation of a laboratory quality
management system (refer to joint ISO-ILAC-IAF Communique dated January 2009).*

2021-02-19 through 2022-03-31
Effective Dates

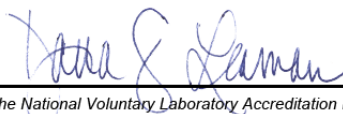

For the National Voluntary Laboratory Accreditation Program