

FCC TEST REPORT ICES-003 TEST REPORT

Project No. : TM-2109000307P
Applicant : MICHELIN NORTH AMERICA (US) INC.
 MICHELIN NORTH AMERICA (CANADA) INC.
Address : One Parkway South, Greenville, South Carolina 29615, United States
 2863 Granton Road New Glasgow NS B2H 5C6 Canada
Manufacturer : MFP MICHELIN
Address : 23 Place des Carmes-Deschaux - 63040 Clermont-Fd Cedex9 - France

Equipment Under Test (EUT) :
Product Name : MEMS EVOLUTION 4TRANSCEIVER
Brand Name : MICHELIN
Model No. : RV5-01
Added Model(s) : N/A

Standards : 47 CFR FCC Part 15 Subpart B (Class A)
 ICES-003 Issue 7 : October 2020 (Class A)

Date of Sample Receipt : Sep. 28, 2021
Date of Test : Nov. 18 ~ 19, 2021
Date of Issue : Dec. 24, 2021

Test Result :	PASS
----------------------	-------------

In the configuration tested, the EUT complied with the standards specified above.

Remarks :

This report details the results of the testing carried out on one sample, the results contained in this test report do not relate to other samples of the same product. The manufacturer should ensure that all products in series production are in conformity with the product sample detailed in this report.

This report may only be reproduced and distributed in full. If the product in this report is used in any configuration other than that detailed in the report, the manufacturer must ensure the new system complies with all relevant standards. Any mention of SGS Taiwan Electromagnetic Compatibility Laboratory or testing done by SGS Taiwan Electromagnetic Compatibility Laboratory in connection with distribution or use of the product described in this report must be approved by SGS Taiwan Electromagnetic Compatibility Laboratory in writing.

Approved By Eddy Cheng
Eddy Cheng (Asst. Supervisor)

Date Dec. 24, 2021



Unless otherwise stated the results shown in this test report refer only to the sample(s) tested and such sample(s) are retained for 90 days only.
 除非另有說明，此報告結果僅對測試之樣品負責，同時此樣品僅保留90天。本報告未經本公司書面許可，不可部份複製。

This document is issued by the Company subject to its General Conditions of Service printed overleaf, available on request or accessible at <http://www.sgs.com.tw/Terms-and-Conditions> and for electronic format documents, subject to Terms and Conditions for Electronic Documents at <http://www.sgs.com.tw/Terms-and-Conditions>. Attention is drawn to the limitation of liability, indemnification and jurisdiction issues defined therein. Any holder of this document is advised that information contained hereon reflects the Company's findings at the time of its intervention only and within the limits of Client's instructions, if any. The Company's sole responsibility is to its Client and this document does not exonerate parties to a transaction from exercising all their rights and obligations under the transaction documents. This document cannot be reproduced except in full, without prior written approval of the Company. Any unauthorized alteration, forgery or falsification of the content or appearance of this document is unlawful and offenders may be prosecuted to the fullest extent of the law.



Revision History

Revision	Report Number	Description	Issue Date
00	TMHY2109000316YE	Original. See the following note Rev.(00)	Dec. 24, 2021

Note:

Rev.(00):

1. All test data based on MH/2021/30146, just modify the report number and mode number, because they are the mutual support unit, the same test method and test configuration.

Unless otherwise stated the results shown in this test report refer only to the sample(s) tested and such sample(s) are retained for 90 days only.

除非另有說明，此報告結果僅對測試之樣品負責，同時此樣品僅保留90天。本報告未經本公司書面許可，不可部份複製。

This document is issued by the Company subject to its General Conditions of Service printed overleaf, available on request or accessible at <http://www.sgs.com.tw/Terms-and-Conditions> and for electronic format documents, subject to Terms and Conditions for Electronic Documents at <http://www.sgs.com.tw/Terms-and-Conditions>. Attention is drawn to the limitation of liability, indemnification and jurisdiction issues defined therein. Any holder of this document is advised that information contained hereon reflects the Company's findings at the time of its intervention only and within the limits of Client's instructions, if any. The Company's sole responsibility is to its Client and this document does not exonerate parties to a transaction from exercising all their rights and obligations under the transaction documents. This document cannot be reproduced except in full, without prior written approval of the Company. Any unauthorized alteration, forgery or falsification of the content or appearance of this document is unlawful and offenders may be prosecuted to the fullest extent of the law.

SGS Taiwan Ltd.

No.2, Keji 1st Rd., Guishan District, Taoyuan City, Taiwan / 桃園市龜山區科技一路2號

台灣檢驗科技股份有限公司

t (886-2) 2299-3279

f (886-3) 327-7559

www.sgs.com.tw

Member of SGS Group

Contents

1. GENERAL INFORMATION	4
1.1 APPLICANT & MANUFACTURER INFORMATION	4
1.2 GENERAL DESCRIPTION OF EUT	4
1.3 DETAILS OF EUT	5
1.4 DESCRIPTION OF SUPPORT UNITS	5
1.5 OPERATION PROCEDURE	6
1.6 ACCESSORIES CABLE LIST	6
1.7 TEST SET-UP CONFIGURATION.....	6
1.8 MEASUREMENT PROCEDURE	7
1.9 STANDARDS APPLICABLE FOR TESTING.....	7
1.10 DECISION RULES OF RESULTS.....	7
1.11 SUMMARY OF RESULTS	7
1.12 REPORTING STATEMENTS OF CONFORMITY.....	7
1.13 TEST FACILITY	8
2. EMISSION	9
2.1 TEST RESULTS	9
2.2 FREQUENCY RANGE.....	9
2.3 LIMITS OF CONDUCTED AND RADIATED EMISSION	10
2.3.1 LIMITS OF CONDUCTED EMISSION	10
2.3.2 LIMITS OF RADIATED EMISSIONS.....	11
2.4 TEST OF CONDUCTED EMISSION.....	13
2.4.1 TEST EQUIPMENTS	13
2.4.2 MEASUREMENT LEVEL CALCULATION	13
2.4.3 MEASUREMENT DATA:.....	13
2.5 TEST OF RADIATED EMISSION.....	14
2.5.1 TEST EQUIPMENTS	14
2.5.2 MEASUREMENT LEVEL CALCULATION	15
2.5.3 MEASUREMENT DATA.....	16
APPENDIX	24
PHOTOGRAPH OF TESTING GENERAL SET-UP	24
PHOTOGRAPHS OF PRODUCT	26

Unless otherwise stated the results shown in this test report refer only to the sample(s) tested and such sample(s) are retained for 90 days only.
 除非另有說明，此報告結果僅對測試之樣品負責，同時此樣品僅保留90天。本報告未經本公司書面許可，不可部份複製。

This document is issued by the Company subject to its General Conditions of Service printed overleaf, available on request or accessible at <http://www.sgs.com.tw/Terms-and-Conditions> and for electronic format documents, subject to Terms and Conditions for Electronic Documents at <http://www.sgs.com.tw/Terms-and-Conditions>. Attention is drawn to the limitation of liability, indemnification and jurisdiction issues defined therein. Any holder of this document is advised that information contained hereon reflects the Company's findings at the time of its intervention only and within the limits of Client's instructions, if any. The Company's sole responsibility is to its Client and this document does not exonerate parties to a transaction from exercising all their rights and obligations under the transaction documents. This document cannot be reproduced except in full, without prior written approval of the Company. Any unauthorized alteration, forgery or falsification of the content or appearance of this document is unlawful and offenders may be prosecuted to the fullest extent of the law.



1. General Information

1.1 Applicant & Manufacturer Information

Applicant : MICHELIN NORTH AMERICA (US) INC.
MICHELIN NORTH AMERICA (CANADA) INC.
Address of Applicant : One Parkway South, Greenville, South Carolina 29615,
United States
2863 Granton Road New Glasgow NS B2H 5C6
Canada
Manufacturer : MFP MICHELIN
Address of Manufacturer : 23 Place des Carmes-Deschaux - 63040 Clermont-Fd
Cedex9 - France

1.2 General Description of EUT

Product Name : MEMS EVOLUTION 4TRANSCEIVER
Brand Name : MICHELIN
Model No. : RV5-01
Added Model(s) : N/A
Model Difference : N/A

Unless otherwise stated the results shown in this test report refer only to the sample(s) tested and such sample(s) are retained for 90 days only.
除非另有說明，此報告結果僅對測試之樣品負責，同時此樣品僅保留90天。本報告未經本公司書面許可，不可部份複製。

This document is issued by the Company subject to its General Conditions of Service printed overleaf, available on request or accessible at <http://www.sgs.com.tw/Terms-and-Conditions> and for electronic format documents, subject to Terms and Conditions for Electronic Documents at <http://www.sgs.com.tw/Terms-and-Conditions>. Attention is drawn to the limitation of liability, indemnification and jurisdiction issues defined therein. Any holder of this document is advised that information contained hereon reflects the Company's findings at the time of its intervention only and within the limits of Client's instructions, if any. The Company's sole responsibility is to its Client and this document does not exonerate parties to a transaction from exercising all their rights and obligations under the transaction documents. This document cannot be reproduced except in full, without prior written approval of the Company. Any unauthorized alteration, forgery or falsification of the content or appearance of this document is unlawful and offenders may be prosecuted to the fullest extent of the law.



1.3 Details of EUT

Power Supply	: DC 24V
Modes/Function	: Mode 1. EUT Full System + WiFi 5G Link + LAN + DC24V Mode 2. EUT Full System + WiFi 5G Idle + LAN + DC24V Mode 3. EUT Full System + WiFi 2.4G Link + LAN + DC24V Mode 4. EUT Full System + WiFi 2.4G Idle + LAN + DC24V
Worst case	: CE Worst case : N/A Below 1GHz RE Worst case : Mode 3 Above 1GHz RE Worst case : Mode 3
Highest internal frequency	: 5825MHz
Adapter	: N/A

1.4 Description of Support Units

PRODUCT	MANUFACTURER	MODEL NO.	SERIAL NO.
AP	ASUS	RT-AX88U	KAITHP000135
Notebook	DELL	P56F	59WSJ72
USB Flash	Kingston	DTSE9H/16GB	C4525-305A00LR

Support Equipment Used in Tested Cable

Cable Type	Core	Length	Shielding/Non-shielding
Can1 cable	N/A	0.2m	Non-shielding
Data cable	N/A	5m	Non-shielding
RS232 cable	N/A	1.4m	Non-shielding
DC power cable	Near EUT	1.5m	Non-shielding

Unless otherwise stated the results shown in this test report refer only to the sample(s) tested and such sample(s) are retained for 90 days only.
除非另有說明，此報告結果僅對測試之樣品負責，同時此樣品僅保留90天。本報告未經本公司書面許可，不可部份複製。

This document is issued by the Company subject to its General Conditions of Service printed overleaf, available on request or accessible at <http://www.sgs.com.tw/Terms-and-Conditions> and for electronic format documents, subject to Terms and Conditions for Electronic Documents at <http://www.sgs.com.tw/Terms-and-Conditions>. Attention is drawn to the limitation of liability, indemnification and jurisdiction issues defined therein. Any holder of this document is advised that information contained hereon reflects the Company's findings at the time of its intervention only and within the limits of Client's instructions, if any. The Company's sole responsibility is to its Client and this document does not exonerate parties to a transaction from exercising all their rights and obligations under the transaction documents. This document cannot be reproduced except in full, without prior written approval of the Company. Any unauthorized alteration, forgery or falsification of the content or appearance of this document is unlawful and offenders may be prosecuted to the fullest extent of the law.

SGS Taiwan Ltd.

No.2, Keji 1st Rd., Guishan District, Taoyuan City, Taiwan / 桃園市龜山區科技一路2號

台灣檢驗科技股份有限公司

t (886-2) 2299-3279

f (886-3) 327-7559

www.sgs.com.tw

Member of SGS Group



1.5 Operation Procedure

Mode 3

1. Connect the I/O of the host to the corresponding patch cord:
 CAN_1 connect to Terminal,
 CAN_2/3 connect to CAN LOAD BOX,
 RS232 adapter cable hanging wire,
 M12 to RJ45 Cable connect to AP ROUNTER,
 USB plug in USB Flash
 Power Cable connect to DC24V and turn it on.
2. NB WiFi link EUT (host), NB ping EUT IP (200.200.200.128).
3. NB opens the web page (200.200.200.128), the page is set to WiFi 2.4G, after the setting is complete, click SEND.
4. PC connects to AP ROUNTER, PC ping EUT IP (192.168.1.5).
5. Start the test.

1.6 Accessories Cable List

Cable Type	Core	Length	Category	Shielding/Non-shielding
Antenna cable	N/A	7m	N/A	Non-shielding

1.7 Test Set-Up Configuration

Mode 3

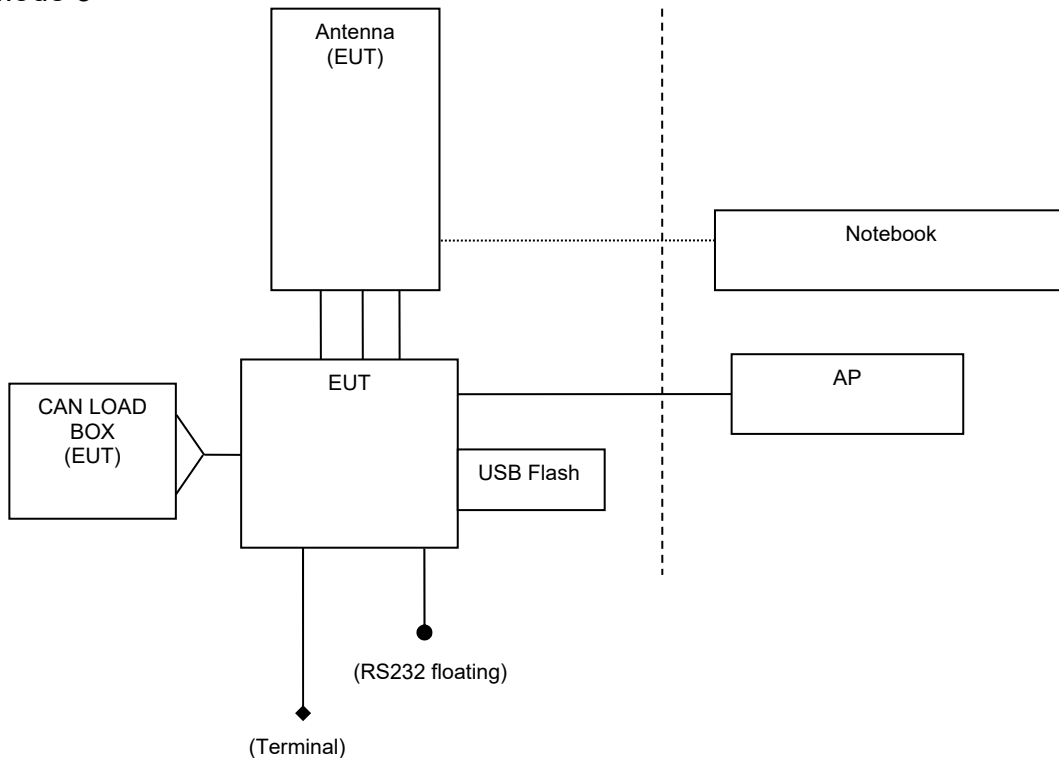

Unless otherwise stated the results shown in this test report refer only to the sample(s) tested and such sample(s) are retained for 90 days only.

除非另有說明，此報告結果僅對測試之樣品負責，同時此樣品僅保留90天。本報告未經本公司書面許可，不可部份複製。

This document is issued by the Company subject to its General Conditions of Service printed overleaf, available on request or accessible at <http://www.sgs.com.tw/Terms-and-Conditions> and for electronic format documents, subject to Terms and Conditions for Electronic Documents at <http://www.sgs.com.tw/Terms-and-Conditions>. Attention is drawn to the limitation of liability, indemnification and jurisdiction issues defined therein. Any holder of this document is advised that information contained hereon reflects the Company's findings at the time of its intervention only and within the limits of Client's instructions, if any. The Company's sole responsibility is to its Client and this document does not exonerate parties to a transaction from exercising all their rights and obligations under the transaction documents. This document cannot be reproduced except in full, without prior written approval of the Company. Any unauthorized alteration, forgery or falsification of the content or appearance of this document is unlawful and offenders may be prosecuted to the fullest extent of the law.

SGS Taiwan Ltd. No.2, Keji 1st Rd., Guishan District, Taoyuan City, Taiwan / 桃園市龜山區科技一路2號

台灣檢驗科技股份有限公司

t (886-2) 2299-3279

f (886-3) 327-7559

www.sgs.com.tw

Member of SGS Group



1.8 Measurement Procedure

Conducted Emission Testing was performed according to ANSI C63.4:2014 in a shielded room with peripherals placed on a table, 0.8m high over a metal floor. It was located more than required distance away from the shielded room wall.

Radiated Emission Testing was performed according to ANSI C63.4:2014 at the 3/10m semi-anechoic chamber. The EUT was placed on a 0.8m high table along with the peripherals. The turn table was placed 3/10m distance from the antenna. Cables were placed in a position to produce maximum emissions as determined by experimentation, and operation mode was selected for production of maximum emission.

The frequency and amplitude of the worse emissions were measured at varying azimuths, antenna heights and antenna polarities. Maximum emission levels are then reported.

1.9 Standards Applicable for Testing

Tests to be carried out under 47 CFR FCC Part 15 Subpart B/CISPR 22/ICES-003

Test Standards	Status
47 CFR FCC Part 15 Subpart B CISPR 22 ICES-003	Applicable
Deviation from Standard	No deviation

1.10 Decision Rules of Results

Reported measurement data comply with 47 CFR FCC Part 15 Subpart B and ICES-003.

Determining compliance shall be based on the results of the compliance measurement, not taking into account measurement instrumentation uncertainty.

1.11 Summary of Results

Standard	Test Type	Result
47 CFR FCC Part 15 Subpart B (Class A) ICES-003 Issue 7 : October 2020 (Class A)	Conducted Emission	N/A
	Radiated Emission	PASS

1.12 Reporting Statements of Conformity

The conformity statement in this report is based solely on the test results, measurement uncertainty is excluded.

Unless otherwise stated the results shown in this test report refer only to the sample(s) tested and such sample(s) are retained for 90 days only.
除非另有說明，此報告結果僅對測試之樣品負責，同時此樣品僅保留90天。本報告未經本公司書面許可，不可部份複製。

This document is issued by the Company subject to its General Conditions of Service printed overleaf, available on request or accessible at <http://www.sgs.com.tw/Terms-and-Conditions> and for electronic format documents, subject to Terms and Conditions for Electronic Documents at <http://www.sgs.com.tw/Terms-and-Conditions>. Attention is drawn to the limitation of liability, indemnification and jurisdiction issues defined therein. Any holder of this document is advised that information contained hereon reflects the Company's findings at the time of its intervention only and within the limits of Client's instructions, if any. The Company's sole responsibility is to its Client and this document does not exonerate parties to a transaction from exercising all their rights and obligations under the transaction documents. This document cannot be reproduced except in full, without prior written approval of the Company. Any unauthorized alteration, forgery or falsification of the content or appearance of this document is unlawful and offenders may be prosecuted to the fullest extent of the law.

SGS Taiwan Ltd.

No.2, Keji 1st Rd., Guishan District, Taoyuan City, Taiwan / 桃園市龜山區科技一路2號

台灣檢驗科技股份有限公司

t (886-2) 2299-3279

f (886-3) 327-7559

www.sgs.com.tw

Member of SGS Group



1.13 Test Facility

Laboratory	SGS Taiwan Ltd. Electromagnetic Compatibility Lab
Test Site	No.2, Keji 1st Rd., Guishan District, Taoyuan City, Taiwan
FCC Designation Number	TW1124

Unless otherwise stated the results shown in this test report refer only to the sample(s) tested and such sample(s) are retained for 90 days only.
除非另有說明，此報告結果僅對測試之樣品負責，同時此樣品僅保留90天。本報告未經本公司書面許可，不可部份複製。

This document is issued by the Company subject to its General Conditions of Service printed overleaf, available on request or accessible at <http://www.sgs.com.tw/Terms-and-Conditions> and for electronic format documents, subject to Terms and Conditions for Electronic Documents at <http://www.sgs.com.tw/Terms-and-Conditions>. Attention is drawn to the limitation of liability, indemnification and jurisdiction issues defined therein. Any holder of this document is advised that information contained hereon reflects the Company's findings at the time of its intervention only and within the limits of Client's instructions, if any. The Company's sole responsibility is to its Client and this document does not exonerate parties to a transaction from exercising all their rights and obligations under the transaction documents. This document cannot be reproduced except in full, without prior written approval of the Company. Any unauthorized alteration, forgery or falsification of the content or appearance of this document is unlawful and offenders may be prosecuted to the fullest extent of the law.

SGS Taiwan Ltd. No.2, Keji 1st Rd., Guishan District, Taoyuan City, Taiwan / 桃園市龜山區科技一路2號

台灣檢驗科技股份有限公司

t (886-2) 2299-3279

f (886-3) 327-7559

www.sgs.com.tw

Member of SGS Group



2. EMISSION

2.1 Test Results

Conducted Emission	N/A
Radiated Emission	Pass

2.2 Frequency Range

47 CFR FCC Part 15 Subpart B:

Conducted Emission : 150 kHz - 30 MHz

Radiated Emission : See below table

Highest frequency generated or used in the device or on which the device operates or tunes (MHz)	Upper frequency of measurement range (MHz)
Below 1.705	30
1.705 - 108	1000
108 - 500	2000
500 - 1000	5000
Above 1000	5th harmonic of the highest frequency or 40 GHz, whichever is lower.

ICES-003:

Conducted Emission : 150 kHz - 30 MHz

Radiated Emission : 30 MHz to 5thharmonic of the highest frequency or 40GHz, whichever is lower.

Highest internal frequency (F_x)	Highest measurement frequency
$F_x \leq 108$ MHz	1 GHz
108 MHz < $F_x \leq 500$ MHz	2 GHz
500 MHz < $F_x \leq 1$ GHz	5 GHz
$F_x > 1$ GHz	5 x F_x up to a maximum of 40 GHz

Note: F_x is the highest fundamental frequency generated and/or used in the ITE or digital apparatus under test.

Unless otherwise stated the results shown in this test report refer only to the sample(s) tested and such sample(s) are retained for 90 days only.
除非另有說明，此報告結果僅對測試之樣品負責，同時此樣品僅保留90天。本報告未經本公司書面許可，不可部份複製。

This document is issued by the Company subject to its General Conditions of Service printed overleaf, available on request or accessible at <http://www.sgs.com.tw/Terms-and-Conditions> and for electronic format documents, subject to Terms and Conditions for Electronic Documents at <http://www.sgs.com.tw/Terms-and-Conditions>. Attention is drawn to the limitation of liability, indemnification and jurisdiction issues defined therein. Any holder of this document is advised that information contained hereon reflects the Company's findings at the time of its intervention only and within the limits of Client's instructions, if any. The Company's sole responsibility is to its Client and this document does not exonerate parties to a transaction from exercising all their rights and obligations under the transaction documents. This document cannot be reproduced except in full, without prior written approval of the Company. Any unauthorized alteration, forgery or falsification of the content or appearance of this document is unlawful and offenders may be prosecuted to the fullest extent of the law.

2.3 Limits of Conducted and Radiated Emission

2.3.1 Limits of Conducted Emission

47 CFR FCC Part 15 Subpart B:

FREQUENCY (MHz)	Class A (dBuV)		Class B (dBuV)	
	Quasi-peak	Average	Quasi-peak	Average
0.15 - 0.5	79	66	66 - 56	56 - 46
0.5 - 5	73	60	56	46
5.0 - 30	73	60	60	50

Note : (1) The lower limit shall apply at the transition frequencies.

(2) The limit decreases linearly with the logarithm of the frequency in the range 0.15 to 0.50 MHz.

(3) All emanation from a class A/B digital device or system, including any network of conductors and apparatus connected there to, shall not exceed the level of field strengths specified above.

ICES-003:

FREQUENCY (MHz)	Class A (dBuV)		Class B (dBuV)	
	Quasi-peak	Average	Quasi-peak	Average
0.15 - 0.5	79	66	66 - 56*	56 - 46*
0.5 - 5	73	60	56	46
5.0 - 30	73	60	60	50

Note: The more stringent limit applies at transition frequencies.

*. The limit level in dB μ V decreases linearly with the logarithm of frequency.

Unless otherwise stated the results shown in this test report refer only to the sample(s) tested and such sample(s) are retained for 90 days only.
除非另有說明，此報告結果僅對測試之樣品負責，同時此樣品僅保留90天。本報告未經本公司書面許可，不可部份複製。

This document is issued by the Company subject to its General Conditions of Service printed overleaf, available on request or accessible at <http://www.sgs.com.tw/Terms-and-Conditions> and for electronic format documents, subject to Terms and Conditions for Electronic Documents at <http://www.sgs.com.tw/Terms-and-Conditions>. Attention is drawn to the limitation of liability, indemnification and jurisdiction issues defined therein. Any holder of this document is advised that information contained hereon reflects the Company's findings at the time of its intervention only and within the limits of Client's instructions, if any. The Company's sole responsibility is to its Client and this document does not exonerate parties to a transaction from exercising all their rights and obligations under the transaction documents. This document cannot be reproduced except in full, without prior written approval of the Company. Any unauthorized alteration, forgery or falsification of the content or appearance of this document is unlawful and offenders may be prosecuted to the fullest extent of the law.



2.3.2 Limits of Radiated Emissions

47 CFR FCC Part 15 Subpart B Limit:

- Detector Function : Quasi – Peak

FREQUENCY (MHz)	Class A (at 10 m)	Class B (at 3 m)
	dBuV/m	dBuV/m
30~88	39	40
88~216	43.5	43.5
216~960	46.4	46
960~1000	49.5	54

- Detector Function : Peak , Average

FREQUENCY (MHz)	Class A (dBuV/m) (at 3 m)		Class B (dBuV/m) (at 3 m)	
	Peak	Average	Peak	Average
Above 1000	80	60	74	54

CISPR 22 Limit:

- Detector Function : Quasi – Peak

FREQUENCY (MHz)	Class A (at 10 m)	Class B (at 10 m)
	dBuV/m	dBuV/m
30~230	40	30
230~1000	47	37

Note: 1. The lower limit shall apply at the transition frequency.
2. Additional provisions may be required for cases where interference occurs.

Unless otherwise stated the results shown in this test report refer only to the sample(s) tested and such sample(s) are retained for 90 days only.
除非另有說明，此報告結果僅對測試之樣品負責，同時此樣品僅保留90天。本報告未經本公司書面許可，不可部份複製。

This document is issued by the Company subject to its General Conditions of Service printed overleaf, available on request or accessible at <http://www.sgs.com.tw/Terms-and-Conditions> and for electronic format documents, subject to Terms and Conditions for Electronic Documents at <http://www.sgs.com.tw/Terms-and-Conditions>. Attention is drawn to the limitation of liability, indemnification and jurisdiction issues defined therein. Any holder of this document is advised that information contained hereon reflects the Company's findings at the time of its intervention only and within the limits of Client's instructions, if any. The Company's sole responsibility is to its Client and this document does not exonerate parties to a transaction from exercising all their rights and obligations under the transaction documents. This document cannot be reproduced except in full, without prior written approval of the Company. Any unauthorized alteration, forgery or falsification of the content or appearance of this document is unlawful and offenders may be prosecuted to the fullest extent of the law.

SGS Taiwan Ltd. No.2, Keji 1st Rd., Guishan District, Taoyuan City, Taiwan / 桃園市龜山區科技一路2號

台灣檢驗科技股份有限公司

t (886-2) 2299-3279

f (886-3) 327-7559

www.sgs.com.tw

Member of SGS Group

**ICES-003 Limit:**

- Detector Function : Quasi-peak

Frequency (MHz)	Class A (3 m) (dBuV/m)	Class A (10 m) (dBuV/m)	Class B (3 m) (dBuV/m)	Class B (10 m) (dBuV/m)
30 - 88	50	40	40	30
88 - 216	54	43.5	43.5	33.1
216 - 230	56.9	46.4	46	35.6
230 - 960	57	47	47	37
960 - 1000	60	49.5	54	43.5

Note: The more stringent limit applies at transition frequencies

- Detector Function : Peak, Average

Frequency (MHz)	Class A (3 m) (dBuV/m)		Class B (3 m) (dBuV/m)	
	Peak	Average	Peak	Average
Above 1000	80	60	74	54

Unless otherwise stated the results shown in this test report refer only to the sample(s) tested and such sample(s) are retained for 90 days only.
除非另有說明，此報告結果僅對測試之樣品負責，同時此樣品僅保留90天。本報告未經本公司書面許可，不可部份複製。

This document is issued by the Company subject to its General Conditions of Service printed overleaf, available on request or accessible at <http://www.sgs.com.tw/Terms-and-Conditions> and for electronic format documents, subject to Terms and Conditions for Electronic Documents at <http://www.sgs.com.tw/Terms-and-Conditions>. Attention is drawn to the limitation of liability, indemnification and jurisdiction issues defined therein. Any holder of this document is advised that information contained hereon reflects the Company's findings at the time of its intervention only and within the limits of Client's instructions, if any. The Company's sole responsibility is to its Client and this document does not exonerate parties to a transaction from exercising all their rights and obligations under the transaction documents. This document cannot be reproduced except in full, without prior written approval of the Company. Any unauthorized alteration, forgery or falsification of the content or appearance of this document is unlawful and offenders may be prosecuted to the fullest extent of the law.

SGS Taiwan Ltd. No.2, Keji 1st Rd., Guishan District, Taoyuan City, Taiwan / 桃園市龜山區科技一路2號

台灣檢驗科技股份有限公司

t (886-2) 2299-3279

f (886-3) 327-7559

www.sgs.com.tw

Member of SGS Group



2.4. Test of Conducted Emission

2.4.1 Test Equipments

SGS Conducted Emission HWAYA Conducted Room No.A EMC					
EQUIPMENT TYPE	Manufacturer	Model Number	Serial Number	Calibration Date	Calibration Due
EMI Test Receiver	R&S	ESCI	101311	2021/7/5	2022/7/4
Coaxial Cables	EMC Instruments Corp.	HY-CE-CABLE	HYCE-2000-01	2021/5/19	2022/5/18
LISN	Schwarzbeck	NSLK 8127	8127-648	2021/7/11	2022/7/10
LISN	Schwarzbeck	NSLK 8128	NSLK8128-300	2021/8/26	2022/8/25
Pulse Limiter	Narda S.T.S.	PMM PL01	1110X30602	2021/8/12	2022/8/11
Communication Tester	R&S	CMU200	114669	2021/3/10	2022/3/9
Communication Tester	R&S	CMW500	152303	2021/2/2	2022/2/1
Test Software	Farad	EZ-EMC	Ver. SGS-03A2-10	N.C.R.	N.C.R.

Testing Site : No.2, Keji 1st Rd., Guishan District, Taoyuan City, Taiwan
 Measurement Uncertainty of Conducted Emission
 Expanded uncertainty Ulab (k=2) of Conducted Emission is 2.28 dB.
 Expanded uncertainty CISPR 16-4-2:2011+A1:2014+A2:2018 (k=2) of Conducted Emission measurement is 3.44 dB.

2.4.2 Measurement Level Calculation

Factor = LISN insertion loss + Cable loss + Pulse Limiter insertion loss

Measurement Level = Reading Level + Factor

Over (Margin) = Measurement Level – Limit

2.4.3 Measurement Data:

N/A, the EUT power from DC mains, no necessary to perform the test.

Unless otherwise stated the results shown in this test report refer only to the sample(s) tested and such sample(s) are retained for 90 days only.
 除非另有說明，此報告結果僅對測試之樣品負責，同時此樣品僅保留90天。本報告未經本公司書面許可，不可部份複製。

This document is issued by the Company subject to its General Conditions of Service printed overleaf, available on request or accessible at <http://www.sgs.com.tw/Terms-and-Conditions> and for electronic format documents, subject to Terms and Conditions for Electronic Documents at <http://www.sgs.com.tw/Terms-and-Conditions>. Attention is drawn to the limitation of liability, indemnification and jurisdiction issues defined therein. Any holder of this document is advised that information contained hereon reflects the Company's findings at the time of its intervention only and within the limits of Client's instructions, if any. The Company's sole responsibility is to its Client and this document does not exonerate parties to a transaction from exercising all their rights and obligations under the transaction documents. This document cannot be reproduced except in full, without prior written approval of the Company. Any unauthorized alteration, forgery or falsification of the content or appearance of this document is unlawful and offenders may be prosecuted to the fullest extent of the law.

SGS Taiwan Ltd. No.2, Keji 1st Rd., Guishan District, Taoyuan City, Taiwan / 桃園市龜山區科技一路2號

台灣檢驗科技股份有限公司

t (886-2) 2299-3279

f (886-3) 327-7559

www.sgs.com.tw

Member of SGS Group



2.5 Test of Radiated Emission

2.5.1 Test Equipments

Below 1GHz

SGS Radiated_Below_1GHz HWAYA 10m_EMC					
EQUIPMENT TYPE	Manufacturer	Model Number	Serial Number	Calibration Date	Calibration Due
EMI Test Receiver	R&S	ESCI 7	100950	2020/11/30	2021/11/29
EMI Test Receiver	R&S	ESCI	101343	2021/2/2	2022/2/1
Broadband Antenna	SCHWAZBECK	VULB9168	9168-628	2021/8/31	2022/8/30
Broadband Antenna	SCHWAZBECK	VULB9168	9168-629	2021/9/7	2022/9/6
Pre Amplifier	EMC Instruments	EMC330	980178	2021/3/31	2022/3/30
Pre Amplifier	EMC Instruments	EMC330	980179	2021/3/31	2022/3/30
Coaxial Cable	EMC Instruments	EMCCFD400-NM-NM	150917	2021/9/18	2022/9/17
Coaxial Cable	EMC Instruments	EMCCFD400-NM-NM	150919	2021/9/18	2022/9/17
Coaxial Cable	EMC Instruments	EMCCFD400-NM-NM	150820	2021/9/18	2022/9/17
Coaxial Cable	EMC Instruments	EMCCFD400-NM-NM	150918	2021/9/18	2022/9/17
Coaxial Cable	EMC Instruments	EMCCFD400-NM-NM	150821	2021/9/18	2022/9/17
Coaxial Cable	EMC Instruments	EMCCFD400-NM-NM	150822	2021/9/18	2022/9/17
Communication Tester	R&S	CMU200	114669	2021/3/10	2022/3/9
Communication Tester	R&S	CMW500	152303	2021/2/2	2022/2/1
Site NSA	SGS	10m Chamber	10M SAC	2020/12/31	2021/12/30
Test S/W	Farad	EZ-EMC	Ver. SGS 10m-03A2-5	N.C.R.	N.C.R.
Testing Site : No.2, Keji 1st Rd., Guishan District, Taoyuan City, Taiwan					
Measurement Uncertainty of Radiated Emission					
Expanded uncertainty Ulab (k=2) of Radiated Emission is 4.41 dB.(30MHz-1000MHz)					
Expanded uncertainty CISPR 16-4-2:2011+A1:2014+A2:2018 (k=2) of Radiated Emission measurement is 5.22 dB.(30MHz-1000MHz)					

Unless otherwise stated the results shown in this test report refer only to the sample(s) tested and such sample(s) are retained for 90 days only.

除非另有說明，此報告結果僅對測試之樣品負責，同時此樣品僅保留90天。本報告未經本公司書面許可，不可部份複製。

This document is issued by the Company subject to its General Conditions of Service printed overleaf, available on request or accessible at <http://www.sgs.com.tw/Terms-and-Conditions> and for electronic format documents, subject to Terms and Conditions for Electronic Documents at <http://www.sgs.com.tw/Terms-and-Conditions>. Attention is drawn to the limitation of liability, indemnification and jurisdiction issues defined therein. Any holder of this document is advised that information contained hereon reflects the Company's findings at the time of its intervention only and within the limits of Client's instructions, if any. The Company's sole responsibility is to its Client and this document does not exonerate parties to a transaction from exercising all their rights and obligations under the transaction documents. This document cannot be reproduced except in full, without prior written approval of the Company. Any unauthorized alteration, forgery or falsification of the content or appearance of this document is unlawful and offenders may be prosecuted to the fullest extent of the law.

SGS Taiwan Ltd.

No.2, Keji 1st Rd., Guishan District, Taoyuan City, Taiwan / 桃園市龜山區科技一路2號

台灣檢驗科技股份有限公司

t (886-2) 2299-3279

f (886-3) 327-7559

www.sgs.com.tw

Member of SGS Group



Above 1GHz

SGS Radiated Above 1GHz HWAYA 966A EMC					
EQUIPMENT TYPE	Manufacturer	Model Number	Serial Number	Calibration Date	Calibration Due
Spectrum Analyzer	R&S	FSV 40	101419	2021/5/26	2022/5/25
EMI Test Receiver	R&S	ESR 7	101459	2021/2/24	2022/2/23
Horn Antenna	Schwarzbeck	BBHA9120D	BBHA9120D285	2021/5/4	2022/5/3
Horn Antenna	Schwarzbeck	BBHA9170	BBHA9170-184	2020/12/11	2021/12/10
Pre Amplifier	EMC Instruments	EMC012645B	980216	2021/4/25	2022/4/24
Pre Amplifier	EMC Instruments	EMC184045B	980135	2021/10/27	2022/10/26
Coaxial Cable	JUNFLOW	MWX221-NMSNMS	J0778929	2021/9/8	2022/9/7
Coaxial Cable	Huber+Suhner	SUCOFLEX 104PEA	30255/4PEA	2021/9/8	2022/9/7
Coaxial Cable	EMC Instruments	EMC104-SM-SM	140927	2021/9/8	2022/9/7
Coaxial Cable	Huber+Suhner	SUCOFLEX 102	520415/2	2021/6/5	2022/6/4
Coaxial Cable	Huber+Suhner	SUCOFLEX 102	MY 2153/2	2021/6/5	2022/6/4
Filter	Woken	WFIL-N2400-2483.5F-02	WR145WC2B1	2021/1/28	2022/1/27
Filter	MICRO-TRONICS	BRC50705-01	006	2021/5/21	2022/5/20
Communication Tester	R&S	CMU200	114669	2021/3/10	2022/3/9
Communication Tester	R&S	CMW500	152303	2021/2/2	2022/2/1
Site VSWR	SGS	966 Chamber A	SAC-A	2021/1/12	2022/1/11
Test Software	Farad	EZ-EMC	Ver. SGS-03A2-5	N.C.R.	N.C.R.

Testing Site : No.2, Keji 1st Rd., Guishan District, Taoyuan City, Taiwan

Measurement Uncertainty of Radiated Emission

Expanded uncertainty U_{lab} (k=2) of Radiated Emission measurement is 4.05 dB.(1-6GHz)

Expanded uncertainty U_{lab} (k=2) of Radiated Emission measurement is 4.04 dB.(6-18GHz)

Expanded uncertainty U_{lab} (k=2) of Radiated Emission measurement is 4.27 dB.(18-26GHz)

Expanded uncertainty U_{lab} (k=2) of Radiated Emission measurement is 4.19 dB.(26-40GHz)

Expanded uncertainty CISPR 16-4-2:2011+A1:2014+A2:2018 (k=2) of Radiated Emission measurement is 5.18 dB.(1-6GHz)

Expanded uncertainty CISPR 16-4-2:2011+A1:2014+A2:2018 (k=2) of Radiated Emission measurement is 5.48 dB.(6-18GHz)

Expanded uncertainty CISPR 16-4-2:2011+A1:2014+A2:2018 (k=2) of Radiated Emission measurement is --- dB.(18-26GHz)

Expanded uncertainty CISPR 16-4-2:2011+A1:2014+A2:2018 (k=2) of Radiated Emission measurement is --- dB.(26-40GHz)

2.5.2 Measurement Level Calculation

Correction Factor = Antenna Factor + Cable loss- Amplifier Gain

Measurement Level = Reading Level + Correction Factor

Over (Margin) = Measurement Level – Limit

Unless otherwise stated the results shown in this test report refer only to the sample(s) tested and such sample(s) are retained for 90 days only.

除非另有說明，此報告結果僅對測試之樣品負責，同時此樣品僅保留90天。本報告未經本公司書面許可，不可部份複製。

This document is issued by the Company subject to its General Conditions of Service printed overleaf, available on request or accessible at <http://www.sgs.com.tw/Terms-and-Conditions> and for electronic format documents, subject to Terms and Conditions for Electronic Documents at <http://www.sgs.com.tw/Terms-and-Conditions>. Attention is drawn to the limitation of liability, indemnification and jurisdiction issues defined therein. Any holder of this document is advised that information contained hereon reflects the Company's findings at the time of its intervention only and within the limits of Client's instructions, if any. The Company's sole responsibility is to its Client and this document does not exonerate parties to a transaction from exercising all their rights and obligations under the transaction documents. This document cannot be reproduced except in full, without prior written approval of the Company. Any unauthorized alteration, forgery or falsification of the content or appearance of this document is unlawful and offenders may be prosecuted to the fullest extent of the law.

SGS Taiwan Ltd.

No.2, Keji 1st Rd., Guishan District, Taoyuan City, Taiwan / 桃園市龜山區科技一路2號

台灣檢驗科技股份有限公司

t (886-2) 2299-3279

f (886-3) 327-7559

www.sgs.com.tw

Member of SGS Group



2.5.3 Measurement Data

Below 1GHz

Model No.:RV5-01

Mode_3_H

Site: SGS 10m Chamber	Date: 2021/11/18	Time: 上午 03:15:56
Limit: FCC Class A 10m Radiation	Polarization: Horizontal	Temperature: 19 °C
Mode: Mode 3	Power: DC24V	Humidity: 53 %RH
Report: File :TMHY2109000316YE	Distance: 10m	Air Pressure: 990 hpa
Tester: Jeffrey Chou		
Note:		

SGS Taiwan Ltd. Electromagnetic Compatibility Laboratory. Address: No.2, Keji 1st Rd., Guishan District, Taoyuan City, Taiwan 333

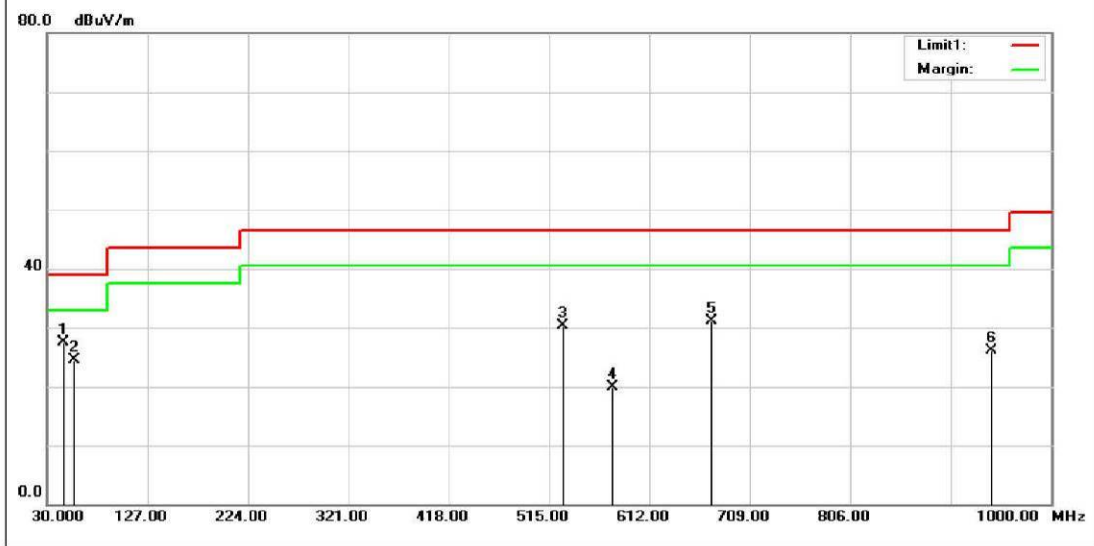

No.	Mk	Freq. (MHz)	Reading (dBuV)	Factor (dB/m)	Measurement (dBuV/m)	Limit (dBuV/m)	Over (dB)	Height (cm)	Degree (deg.)	Detector	Comment
1	*	44.9900	39.13	-11.55	27.58	39.00	-11.42	136	313	QP	
2		56.1000	36.42	-11.88	24.54	39.00	-14.46			QP	
3		528.0100	34.67	-4.33	30.34	46.44	-16.10			QP	
4		576.1100	23.35	-3.36	19.99	46.44	-26.45			QP	
5		672.0000	32.54	-1.52	31.02	46.44	-15.42			QP	
6		941.8000	23.14	2.90	26.04	46.44	-20.40			QP	

*:Maximum data x:Over limit !:over margin

Unless otherwise stated the results shown in this test report refer only to the sample(s) tested and such sample(s) are retained for 90 days only.

除非另有說明，此報告結果僅對測試之樣品負責，同時此樣品僅保留90天。本報告未經本公司書面許可，不可部份複製。

This document is issued by the Company subject to its General Conditions of Service printed overleaf, available on request or accessible at <http://www.sgs.com.tw/Terms-and-Conditions> and for electronic format documents, subject to Terms and Conditions for Electronic Documents at <http://www.sgs.com.tw/Terms-and-Conditions>. Attention is drawn to the limitation of liability, indemnification and jurisdiction issues defined therein. Any holder of this document is advised that information contained hereon reflects the Company's findings at the time of its intervention only and within the limits of Client's instructions, if any. The Company's sole responsibility is to its Client and this document does not exonerate parties to a transaction from exercising all their rights and obligations under the transaction documents. This document cannot be reproduced except in full, without prior written approval of the Company. Any unauthorized alteration, forgery or falsification of the content or appearance of this document is unlawful and offenders may be prosecuted to the fullest extent of the law.

SGS Taiwan Ltd. No.2, Keji 1st Rd., Guishan District, Taoyuan City, Taiwan / 桃園市龜山區科技一路2號

台灣檢驗科技股份有限公司

t (886-2) 2299-3279

f (886-3) 327-7559

www.sgs.com.tw

Member of SGS Group

Mode_3_V

Site: SGS 10m Chamber	Date: 2021/11/18	Time: 上午 03:15:55
Limit: FCC Class A 10m Radiation	Polarization: Vertical	Temperature: 19 °C
Mode: Mode 3	Power: DC24V	Humidity: 53 %RH
Report: File :TMHY2109000316YE	Distance: 10m	Air Pressure: 990 hpa
Tester: Jeffrey Chou		
Note:		

SGS Taiwan Ltd.-Electromagnetic Compatibility Laboratory Address: No.2, Keji 1st Rd., Guishan District, Taoyuan City, Taiwan 333

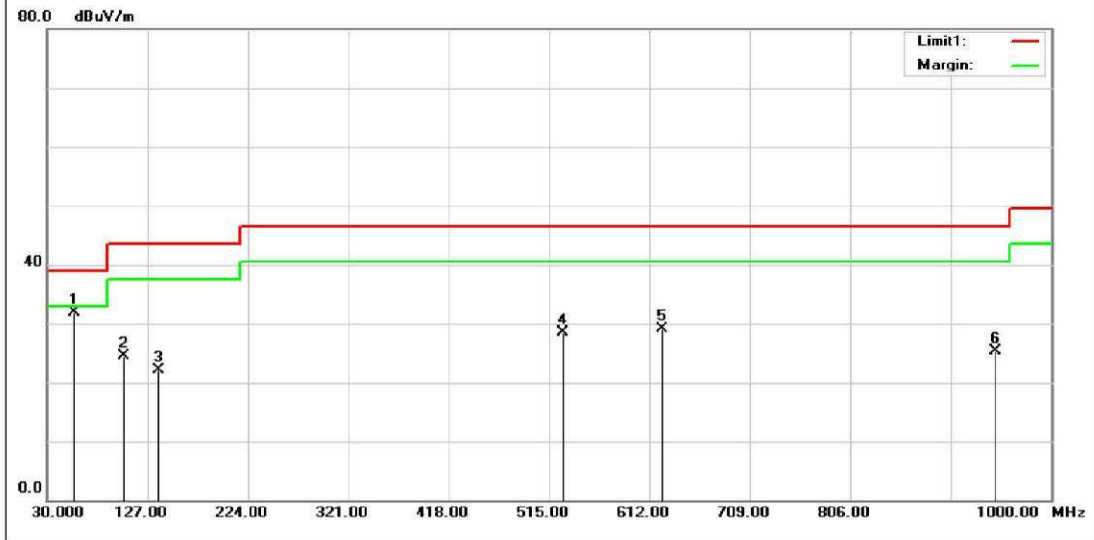

No.	Mk	Freq. (MHz)	Reading (dBuV)	Factor (dB/m)	Measurement (dBuV/m)	Limit (dBuV/m)	Over (dB)	Height (cm)	Degree (deg.)	Detector	Comment
1	*	55.9400	42.36	-10.44	31.92	39.00	-7.08	110	299	QP	
2		104.1700	39.71	-15.29	24.42	43.50	-19.08			QP	
3		137.3400	33.71	-11.70	22.01	43.50	-21.49			QP	
4		527.9900	32.56	-4.01	28.55	46.44	-17.89			QP	
5		623.9900	30.38	-1.31	29.07	46.44	-17.37			QP	
6		945.6800	22.17	3.11	25.28	46.44	-21.16			QP	

*:Maximum data x:Over limit !:over margin

Unless otherwise stated the results shown in this test report refer only to the sample(s) tested and such sample(s) are retained for 90 days only.

除非另有說明，此報告結果僅對測試之樣品負責，同時此樣品僅保留90天。本報告未經本公司書面許可，不可部份複製。
 This document is issued by the Company subject to its General Conditions of Service printed overleaf, available on request or accessible at <http://www.sgs.com.tw/Terms-and-Conditions> and for electronic format documents, subject to Terms and Conditions for Electronic Documents at <http://www.sgs.com.tw/Terms-and-Conditions>. Attention is drawn to the limitation of liability, indemnification and jurisdiction issues defined therein. Any holder of this document is advised that information contained hereon reflects the Company's findings at the time of its intervention only and within the limits of Client's instructions, if any. The Company's sole responsibility is to its Client and this document does not exonerate parties to a transaction from exercising all their rights and obligations under the transaction documents. This document cannot be reproduced except in full, without prior written approval of the Company. Any unauthorized alteration, forgery or falsification of the content or appearance of this document is unlawful and offenders may be prosecuted to the fullest extent of the law.

Mode_3_H

Site: SGS 10m Chamber	Date: 2021/11/18	Time: 上午 03:15:56
Limit: ICES-003 Issue 7 Class A 10m Radiation	Polarization: Horizontal	Temperature: 19 °C
Mode: Mode 3	Power: DC24V	Humidity: 53 %RH
Report: File : TMHY2109000316YE	Distance: 10m	Air Pressure: 990 hpa
Tester: Jeffrey Chou		
Note:		

SGS Taiwan Ltd.-Electromagnetic Compatibility Laboratory Address: No.2, Keji 1st Rd., Guishan District, Taoyuan City, Taiwan 333

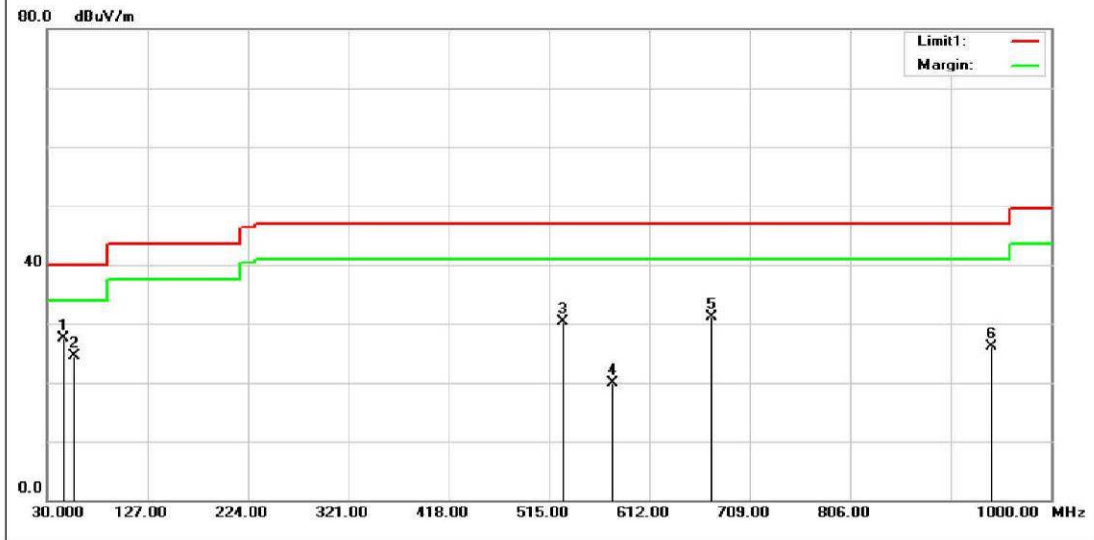

No.	Mk	Freq. (MHz)	Reading (dBuV)	Factor (dB/m)	Measurement (dBuV/m)	Limit (dBuV/m)	Over (dB)	Height (cm)	Degree (deg.)	Detector	Comment
1	*	44.9900	39.13	-11.55	27.58	40.00	-12.42	136	313	QP	
2		56.1000	36.42	-11.88	24.54	40.00	-15.46			QP	
3		528.0100	34.67	-4.33	30.34	47.00	-16.66			QP	
4		576.1100	23.35	-3.36	19.99	47.00	-27.01			QP	
5		672.0000	32.54	-1.52	31.02	47.00	-15.98			QP	
6		941.8000	23.14	2.90	26.04	47.00	-20.96			QP	

*:Maximum data x:Over limit !:over margin

Unless otherwise stated the results shown in this test report refer only to the sample(s) tested and such sample(s) are retained for 90 days only.

除非另有說明，此報告結果僅對測試之樣品負責，同時此樣品僅保留90天。本報告未經本公司書面許可，不可部份複製。

This document is issued by the Company subject to its General Conditions of Service printed overleaf, available on request or accessible at <http://www.sgs.com.tw/Terms-and-Conditions> and for electronic format documents, subject to Terms and Conditions for Electronic Documents at <http://www.sgs.com.tw/Terms-and-Conditions>. Attention is drawn to the limitation of liability, indemnification and jurisdiction issues defined therein. Any holder of this document is advised that information contained hereon reflects the Company's findings at the time of its intervention only and within the limits of Client's instructions, if any. The Company's sole responsibility is to its Client and this document does not exonerate parties to a transaction from exercising all their rights and obligations under the transaction documents. This document cannot be reproduced except in full, without prior written approval of the Company. Any unauthorized alteration, forgery or falsification of the content or appearance of this document is unlawful and offenders may be prosecuted to the fullest extent of the law.

SGS Taiwan Ltd. No.2, Keji 1st Rd., Guishan District, Taoyuan City, Taiwan / 桃園市龜山區科技一路2號

Mode_3_V

Site: SGS 10m Chamber	Date: 2021/11/18	Time: 上午 03:15:55
Limit: ICES-003 Issue 7 Class A 10m Radiation	Polarization: Vertical	Temperature: 19 °C
Mode: Mode 3	Power: DC24V	Humidity: 53 %RH
Report: File : TMHY2109000316YE	Distance: 10m	Air Pressure: 990 hpa
Tester: Jeffrey Chou		
Note:		

SGS Taiwan Ltd.-Electromagnetic Compatibility Laboratory Address: No.2, Keji 1st Rd., Guishan District, Taoyuan City, Taiwan 333

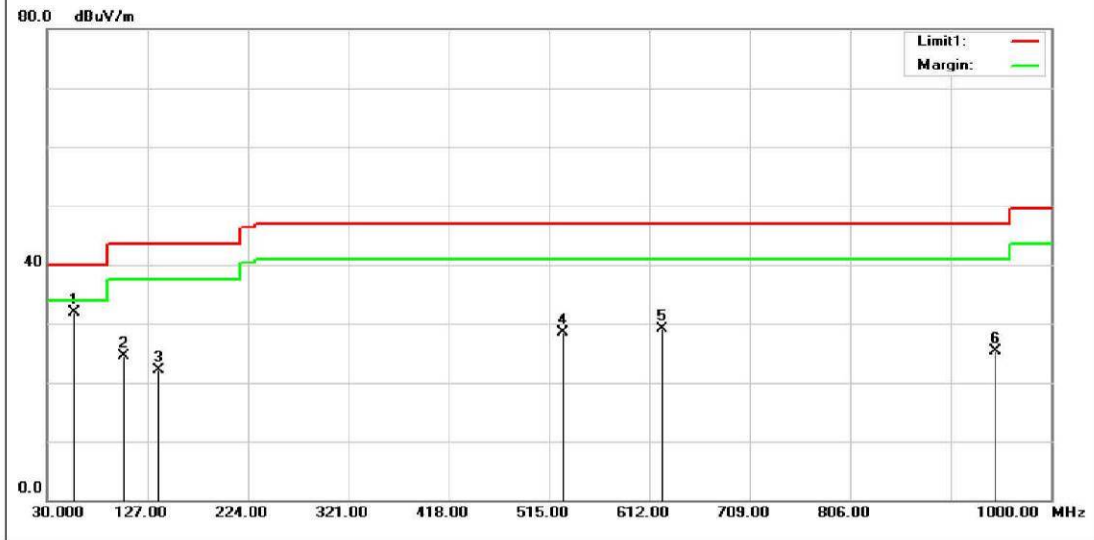

No.	Mk	Freq. (MHz)	Reading (dBuV)	Factor (dB/m)	Measurement (dBuV/m)	Limit (dBuV/m)	Over (dB)	Height (cm)	Degree (deg.)	Detector	Comment
1	*	55.9400	42.36	-10.44	31.92	40.00	-8.08	110	299	QP	
2		104.1700	39.71	-15.29	24.42	43.50	-19.08			QP	
3		137.3400	33.71	-11.70	22.01	43.50	-21.49			QP	
4		527.9900	32.56	-4.01	28.55	47.00	-18.45			QP	
5		623.9900	30.38	-1.31	29.07	47.00	-17.93			QP	
6		945.6800	22.17	3.11	25.28	47.00	-21.72			QP	

*:Maximum data x:Over limit !:over margin

Unless otherwise stated the results shown in this test report refer only to the sample(s) tested and such sample(s) are retained for 90 days only.

除非另有說明，此報告結果僅對測試之樣品負責，同時此樣品僅保留90天。本報告未經本公司書面許可，不可部份複製。

This document is issued by the Company subject to its General Conditions of Service printed overleaf, available on request or accessible at <http://www.sgs.com.tw/Terms-and-Conditions> and for electronic format documents, subject to Terms and Conditions for Electronic Documents at <http://www.sgs.com.tw/Terms-and-Conditions>. Attention is drawn to the limitation of liability, indemnification and jurisdiction issues defined therein. Any holder of this document is advised that information contained hereon reflects the Company's findings at the time of its intervention only and within the limits of Client's instructions, if any. The Company's sole responsibility is to its Client and this document does not exonerate parties to a transaction from exercising all their rights and obligations under the transaction documents. This document cannot be reproduced except in full, without prior written approval of the Company. Any unauthorized alteration, forgery or falsification of the content or appearance of this document is unlawful and offenders may be prosecuted to the fullest extent of the law.

SGS Taiwan Ltd. No.2, Keji 1st Rd., Guishan District, Taoyuan City, Taiwan / 桃園市龜山區科技一路2號

台灣檢驗科技股份有限公司

t (886-2) 2299-3279

f (886-3) 327-7559

www.sgs.com.tw

Member of SGS Group



Above 1GHz

Model No.:RV5-01

Mode_3_H

Site: SGS 966 Chamber A	Date: 2021/11/18	Time: 下午 07:59:40
Limit: FCC Class A 1G-18G(Peak)	Polarization: Horizontal	Temperature: 20 ℃
Mode: Mode 3	Power: DC 24V	Humidity: 66 %RH
Report: TMHY2109000316YE	Distance: 3m	Air Pressure: 990 hpa
Tester: Ken Chen		
Note:		

SGS Taiwan Ltd.-Electromagnetic Compatibility Laboratory Address: No.2, Keji 1st Rd., Guishan District, Taoyuan City, Taiwan 333

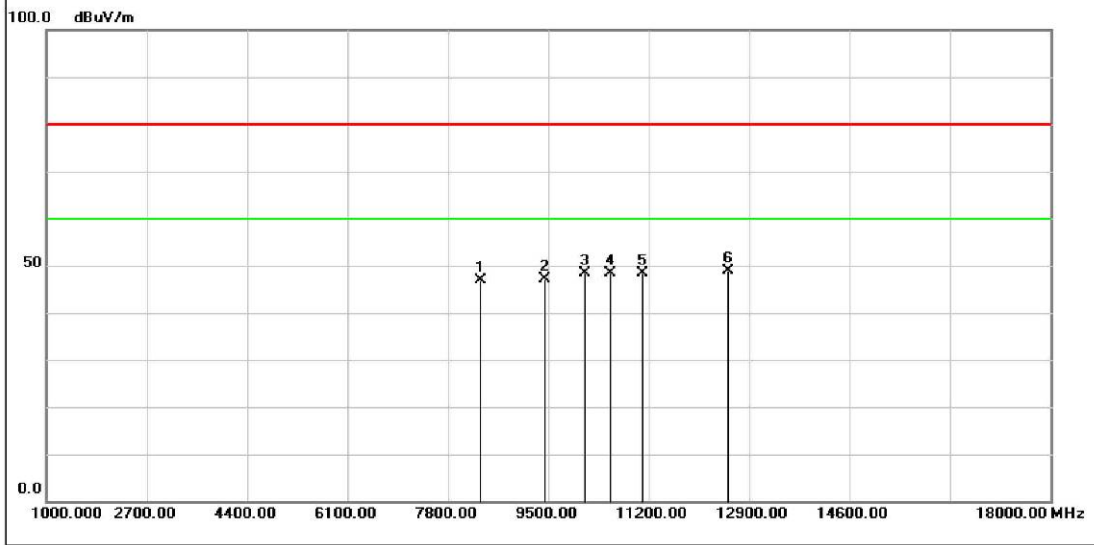

No.	Mk	Freq (MHz)	Reading (dBuV)	Factor (dB/m)	Measurement (dBuV/m)	Limit (dBuV/m)	Over (dB)	Height (cm)	Degree (deg.)	Detector	Comment
1		8344.000	51.55	-4.71	46.84	80.00	-33.16			peak	
2		9432.000	48.67	-1.45	47.22	80.00	-32.78			peak	
3		10129.000	49.83	-1.49	48.34	80.00	-31.66			peak	
4		10554.000	48.82	-0.42	48.40	80.00	-31.60			peak	
5		11098.000	48.81	-0.38	48.43	80.00	-31.57			peak	
6	*	12543.000	49.04	-0.28	48.76	80.00	-31.24	100	25	peak	

*:Maximum data x:Over limit !:over margin

Unless otherwise stated the results shown in this test report refer only to the sample(s) tested and such sample(s) are retained for 90 days only.

除非另有說明，此報告結果僅對測試之樣品負責，同時此樣品僅保留90天。本報告未經本公司書面許可，不可部份複製。

This document is issued by the Company subject to its General Conditions of Service printed overleaf, available on request or accessible at <http://www.sgs.com.tw/Terms-and-Conditions> and for electronic format documents, subject to Terms and Conditions for Electronic Documents at <http://www.sgs.com.tw/Terms-and-Conditions>. Attention is drawn to the limitation of liability, indemnification and jurisdiction issues defined therein. Any holder of this document is advised that information contained hereon reflects the Company's findings at the time of its intervention only and within the limits of Client's instructions, if any. The Company's sole responsibility is to its Client and this document does not exonerate parties to a transaction from exercising all their rights and obligations under the transaction documents. This document cannot be reproduced except in full, without prior written approval of the Company. Any unauthorized alteration, forgery or falsification of the content or appearance of this document is unlawful and offenders may be prosecuted to the fullest extent of the law.

SGS Taiwan Ltd. No.2, Keji 1st Rd., Guishan District, Taoyuan City, Taiwan / 桃園市龜山區科技一路2號

台灣檢驗科技股份有限公司

t (886-2) 2299-3279

f (886-3) 327-7559

www.sgs.com.tw

Member of SGS Group

Site: SGS 966 Chamber A	Date: 2021/11/19	Time: 上午 01:57:33
Limit: FCC Class A 18-40G(Peak)	Polarization: Horizontal	Temperature: 20 ℃
Mode: Mode 3	Power: DC 24V	Humidity: 66 %RH
Report: TMHY2109000316YE	Distance: 1m	Air Pressure: 990 hpa
Tester: Ken Chen		
Note:		

SGS Taiwan Ltd.-Electromagnetic Compatibility Laboratory Address: No.2, Keji 1st Rd., Guishan District, Taoyuan City, Taiwan 333

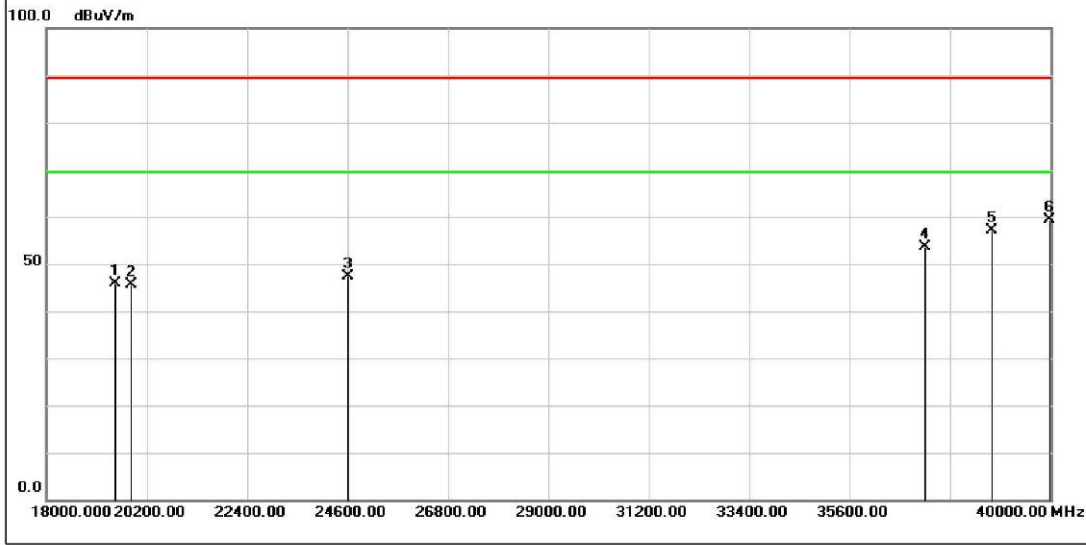

No.	Mk	Freq. (MHz)	Reading (dBuV)	Factor (dB/m)	Measurement (dBuV/m)	Limit (dBuV/m)	Over (dB)	Height (cm)	Degree (deg.)	Detector	Comment
1		19518.000	46.80	-0.96	45.84	89.50	-43.66			peak	
2		19870.000	45.78	-0.11	45.67	89.50	-43.83			peak	
3		24622.000	44.21	3.11	47.32	89.50	-42.18			peak	
4		37250.000	44.48	9.05	53.53	89.50	-35.97			peak	
5		38724.000	45.18	11.89	57.07	89.50	-32.43			peak	
6	*	39978.000	40.82	18.53	59.35	89.50	-30.15	100	318	peak	

*: Maximum data x: Over limit !: over margin

Unless otherwise stated the results shown in this test report refer only to the sample(s) tested and such sample(s) are retained for 90 days only.

除非另有說明，此報告結果僅對測試之樣品負責，同時此樣品僅保留90天。本報告未經本公司書面許可，不可部份複製。

This document is issued by the Company subject to its General Conditions of Service printed overleaf, available on request or accessible at <http://www.sgs.com.tw/Terms-and-Conditions> and for electronic format documents, subject to Terms and Conditions for Electronic Documents at <http://www.sgs.com.tw/Terms-and-Conditions>. Attention is drawn to the limitation of liability, indemnification and jurisdiction issues defined therein. Any holder of this document is advised that information contained hereon reflects the Company's findings at the time of its intervention only and within the limits of Client's instructions, if any. The Company's sole responsibility is to its Client and this document does not exonerate parties to a transaction from exercising all their rights and obligations under the transaction documents. This document cannot be reproduced except in full, without prior written approval of the Company. Any unauthorized alteration, forgery or falsification of the content or appearance of this document is unlawful and offenders may be prosecuted to the fullest extent of the law.

SGS Taiwan Ltd. No.2, Keji 1st Rd., Guishan District, Taoyuan City, Taiwan / 桃園市龜山區科技一路2號



Mode_3_V

Site: SGS 966 Chamber A	Date: 2021/11/18	Time: 下午 07:24:35
Limit: FCC Class A 1G-18G(Peak)	Polarization: Vertical	Temperature: 20 ℃
Mode: Mode 3	Power: DC 24V	Humidity: 66 %RH
Report: TMHY2109000316YE	Distance: 3m	Air Pressure: 990 hpa
Tester: Ken Chen		
Note:		

SGS Taiwan Ltd.-Electromagnetic Compatibility Laboratory Address: No.2, Keji 1st Rd., Guishan District, Taoyuan City, Taiwan 333

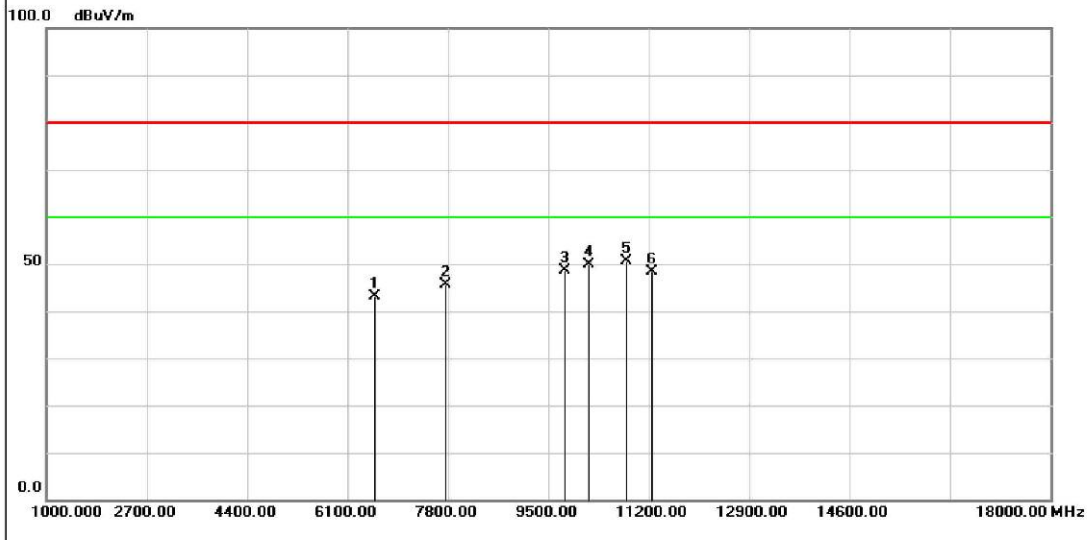

No.	Mk	Freq (MHz)	Reading (dBuV)	Factor (dB/m)	Measurement (dBuV/m)	Limit (dBuV/m)	Over (dB)	Height (cm)	Degree (deg.)	Detector	Comment
1		6559.000	51.79	-8.55	43.24	80.00	-36.76			peak	
2		7766.000	50.83	-5.16	45.67	80.00	-34.33			peak	
3		9789.000	50.00	-1.34	48.66	80.00	-31.34			peak	
4		10180.000	51.23	-1.36	49.87	80.00	-30.13			peak	
5	*	10826.000	50.83	-0.26	50.57	80.00	-29.43	100	52	peak	
6		11251.000	49.04	-0.65	48.39	80.00	-31.61			peak	

*: Maximum data x: Over limit !: over margin

Unless otherwise stated the results shown in this test report refer only to the sample(s) tested and such sample(s) are retained for 90 days only.

除非另有說明，此報告結果僅對測試之樣品負責，同時此樣品僅保留90天。本報告未經本公司書面許可，不可部份複製。

This document is issued by the Company subject to its General Conditions of Service printed overleaf, available on request or accessible at <http://www.sgs.com.tw/Terms-and-Conditions> and for electronic format documents, subject to Terms and Conditions for Electronic Documents at <http://www.sgs.com.tw/Terms-and-Conditions>. Attention is drawn to the limitation of liability, indemnification and jurisdiction issues defined therein. Any holder of this document is advised that information contained hereon reflects the Company's findings at the time of its intervention only and within the limits of Client's instructions, if any. The Company's sole responsibility is to its Client and this document does not exonerate parties to a transaction from exercising all their rights and obligations under the transaction documents. This document cannot be reproduced except in full, without prior written approval of the Company. Any unauthorized alteration, forgery or falsification of the content or appearance of this document is unlawful and offenders may be prosecuted to the fullest extent of the law.

SGS Taiwan Ltd. No.2, Keji 1st Rd., Guishan District, Taoyuan City, Taiwan / 桃園市龜山區科技一路2號

台灣檢驗科技股份有限公司

t (886-2) 2299-3279

f (886-3) 327-7559

www.sgs.com.tw

Member of SGS Group



Site: SGS 966 Chamber A	Date: 2021/11/19	Time: 上午 01:18:05
Limit: FCC Class A 18-40G(Peak)	Polarization: Vertical	Temperature: 20 ℃
Mode: Mode 3	Power: DC 24V	Humidity: 66 %RH
Report: TMHY2109000316YE	Distance: 1m	Air Pressure: 990 hpa
Tester: Ken Chen		
Note:		

SGS Taiwan Ltd.-Electromagnetic Compatibility Laboratory Address: No.2, Keji 1st Rd., Guishan District, Taoyuan City, Taiwan 333

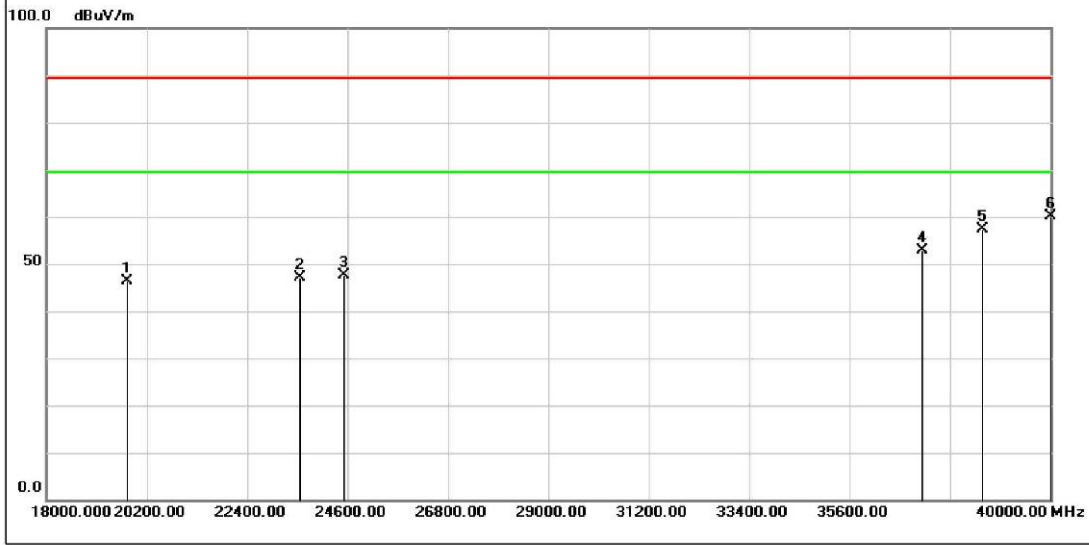

No.	Mk	Freq (MHz)	Reading (dBuV)	Factor (dB/m)	Measurement (dBuV/m)	Limit (dBuV/m)	Over (dB)	Height (cm)	Degree (deg.)	Detector	Comment
1		19760.000	46.76	-0.37	46.39	89.50	-43.11			peak	
2		23566.000	44.34	2.80	47.14	89.50	-42.36			peak	
3		24512.000	44.24	3.28	47.52	89.50	-41.98			peak	
4		37206.000	43.73	9.16	52.89	89.50	-36.61			peak	
5		38504.000	45.97	11.32	57.29	89.50	-32.21			peak	
6	*	40000.000	41.32	18.70	60.02	89.50	-29.48	100	208	peak	

*: Maximum data x: Over limit !: over margin

Unless otherwise stated the results shown in this test report refer only to the sample(s) tested and such sample(s) are retained for 90 days only.

除非另有說明，此報告結果僅對測試之樣品負責，同時此樣品僅保留90天。本報告未經本公司書面許可，不可部份複製。

This document is issued by the Company subject to its General Conditions of Service printed overleaf, available on request or accessible at <http://www.sgs.com.tw/Terms-and-Conditions> and for electronic format documents, subject to Terms and Conditions for Electronic Documents at <http://www.sgs.com.tw/Terms-and-Conditions>. Attention is drawn to the limitation of liability, indemnification and jurisdiction issues defined therein. Any holder of this document is advised that information contained hereon reflects the Company's findings at the time of its intervention only and within the limits of Client's instructions, if any. The Company's sole responsibility is to its Client and this document does not exonerate parties to a transaction from exercising all their rights and obligations under the transaction documents. This document cannot be reproduced except in full, without prior written approval of the Company. Any unauthorized alteration, forgery or falsification of the content or appearance of this document is unlawful and offenders may be prosecuted to the fullest extent of the law.

SGS Taiwan Ltd. No.2, Keji 1st Rd., Guishan District, Taoyuan City, Taiwan / 桃園市龜山區科技一路2號

台灣檢驗科技股份有限公司

t (886-2) 2299-3279

f (886-3) 327-7559

www.sgs.com.tw

Member of SGS Group