

IKEA of Sweden AB

TEST REPORT

SCOPE OF WORK

EMC TESTING-LED2117S1

REPORT NUMBER

210909044GZU-001

ISSUE DATE

08-December-2021

[REVISED DATE]

[-----]

PAGES

14

DOCUMENT CONTROL NUMBER

FCC Part 15:2019-e

© 2017 INTERTEK



TEST REPORT

Applicant Name & : IKEA of Sweden AB
Address : Box 702, 343 81 Älmhult, SWEDEN
Manufacturing Site 1 : Dongguan Kee Tat Lighting Limited
Kai Shek Cheng, DONGGUAN Guangdong Province P.R.China, 523000
Manufacturing Site 2 : Kee Tat innovative Technology Holdings LTD.
No.2 Mowujiweigongye Road, Qishi Town, Dongguan City,
Guangdong Province, P.R.China, 523502
Intertek Report No: 210909044GZU-001

Test standards

CFR 47, FCC Part 15, Subpart B:2019

Sample Description

Product : Self-ballasted LED lamp
Model No. : LED2117S1
Electrical Rating : 120V, 60Hz, 0.9W, 16mA, E12 base.
FCC ID : FHO-LED2117S1
Serial No. : Not Labeled
Date Received : 09 September 2021
Date Test : 09 September 2021-24 September 2021
Conducted

Prepared and Checked By

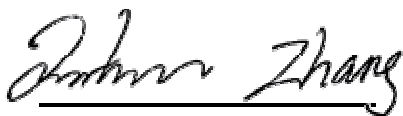

Jackson Zhang

Sr. Project Engineer

Approved By:



Sky Zhu

Team Leader

This report is for the exclusive use of Intertek's Client and is provided pursuant to the agreement between Intertek and its Client. Intertek's responsibility and liability are limited to the terms and conditions of the agreement. Intertek assumes no liability to any party, other than to the Client in accordance with the agreement, for any loss, expense or damage occasioned by the use of this report. Only the Client is authorized to permit copying or distribution of this report and then only in its entirety. Any use of the Intertek name or one of its marks for the sale or advertisement of the tested material, product or service must first be approved in writing by Intertek. The observations and test results in this report are relevant only to the sample tested. This report by itself does not imply that the material, product, or service is or has ever been under an Intertek certification program.

Intertek Testing Services Shenzhen Ltd. Guangzhou Branch
Room 02, & 101/E201/E301/E401/E501/E601/E701/E801 of Room 01 1-8/F., No. 7-2. Caipin Road, Science City, GETDD,
Guangzhou, Guangdong, China

TEST REPORT

CONTENT

TEST REPORT **1**

CONTENT **3**

1. TEST RESULTS SUMMARY **4**

2. EMC RESULTS CONCLUSION..... **5**

3. LABORATORY MEASUREMENTS..... **6**

4. EQUIPMENT USED DURING TEST **7**

5. EMI TEST..... **9**

 5.1 CONDUCTED DISTURBANCE VOLTAGE AT MAINS PORTS 9

 5.1.1 *Block Diagram of Test Setup*..... 9

 5.1.2 *Test Setup and Procedure* 9

 5.1.3 *Limit* 10

 5.1.4 *Test Data and curve* 10

 5.2 RADIATED EMISSION 30 MHz -1000 MHz 12

 5.2.1 *Block Diagram of Test Setup*..... 12

 5.2.2 *Test Setup and Procedure* 12

 5.2.3 *Limit* 13

 5.2.4 *Test Data and Curve* 13

 5.3 RADIATED EMISSION ABOVE 1 GHz 14

TEST REPORT

1. TEST RESULTS SUMMARY

Classification of EUT: Class B

Test Item	Standard	Result
Conducted disturbance voltage at mains ports	CFR 47, FCC Part 15, Subpart B	Pass
Radiated emission (30 MHz–1 GHz)	CFR 47, FCC Part 15, Subpart B	Pass
Radiated emission (Above 1 GHz)	CFR 47, FCC Part 15, Subpart B	N/A
Remark: Reference publication is used for methods of measurement: ANSI C63.4:2014		

Remark:

1. The symbol "N/A" in above table means Not Applicable.
2. When determining the test results, measurement uncertainty of tests has been considered.

TEST REPORT

2. EMC RESULTS CONCLUSION

RE: EMC Testing Pursuant to FCC part 15 performed on the Self-ballasted LED lamp
Model: LED2117S1.

We tested the Self-ballasted LED lamp Model: LED2117S1. to determine if it was in compliance with the relevant standards as marked on the Test Results Summary. We found that the unit met the requirement of FCC part 15 standard when tested as received. The worst case's test data was presented in this test report.

The production units are required to conform to the initial sample as received when the units are placed on the market.

TEST REPORT

3. LABORATORY MEASUREMENTS

Configuration Information

Support Equipment: N/A

Rated Voltage and frequency under test: 120 V~; 60 Hz
 Condition of Environment: Temperature: 22~28°C
 Relative Humidity:35~60%
 Atmosphere Pressure:86~106kPa

Notes:

1. The EMI measurements had been made in the operating mode produced the largest emission in the frequency band being investigated consistent with normal applications. An attempt had been made to maximize the emission by varying the configuration of the EUT.

2. Test Facility accreditation:
 A2LA Certificate Number 0078.10
 Intertek Testing Services Shenzhen Ltd. Guangzhou Branch is accredited by A2LA and Listed in FCC website. FCC accredited test labs may perform both Certification testing under Parts 15 and 18 and Declaration of Conformity testing.

3. Test Location:
 Intertek Testing Services Shenzhen Ltd. Guangzhou Branch
 All tests were performed at:
 Room 02, & 101/E201/E301/E401/E501/E601/E701/E801 of Room 01 1-8/F., No. 7-2. Caipin Road, Science City, GETDD, Guangzhou, Guangdong, China
 Except Radiated Emissions was performed at:
 Room 102/104, No 203, KeZhu Road, Science City, GETDD Guangzhou, China

4. Measurement Uncertainty

No.	Item	Measurement Uncertainty
1	Conducted Emission (9 kHz-150 kHz)	2.79 dB
2	Conducted Emission (150 kHz-30 MHz)	2.55 dB
3	Disturbance Power (30 MHz-300 MHz)	3.04 dB
4	Radiated Emission (30 MHz-1 GHz)	4.80 dB
5	Radiated Emission (1 GHz-6 GHz)	4.97 dB
6	Radiated Emission (6 GHz-18 GHz)	4.89 dB

The measurement uncertainty describes the overall uncertainty of the given measured value during the operation of the EUT.

Measurement uncertainty is calculated in accordance with CISPR16-4-2:2011+A1:2014 +A2:2018.

The measurement uncertainty is given with a confidence of 95%, k=2.

Determination of the test conclusion is based on IEC Guide 115 in consideration of measurement uncertainty.

TEST REPORT

4. EQUIPMENT USED DURING TEST

Conducted Disturbance-Mains Terminal (2)

Equipment No.	Equipment	Model	Manufacturer	Calibration Interval
EM080-04	EMI receiver	ESCS30	R&S	1Y
EM031-04	EMI receiver	ESR3	R&S	1Y
EM006-06	LISN	ENV216	R&S	1Y
SA047-111	Digital Temperature-Humidity Recorder	RS210	YIJIE	1Y
EM004-03	EMC shield Room	8m×4m×3m	Zhongyu	1Y
EM031-04-01	EMC32 software (CE)	V10.01.00	R&S	N/A

Radiated Disturbance (30 MHz-1 GHz)

Equipment No.	Equipment	Model	Manufacturer	Calibration Interval
EM030-04	3m Semi-Anechoic Chamber	9×6×6 m3	ETS-LINDGREN	1Y
EM031-02	EMI Test Receiver (9 kHz~7 GHz)	R&S ESR7	R&S	1Y
EM033-01	TRILOG Super Broadband test Antenna (30 MHz-3 GHz)	VULB 9163	SCHWARZBECK	1Y
EM031-02-01	Coaxial cable	/	R&S	1Y
EM036-01	Common-mode absorbing clamp	CMAD 20B	TESEQ	1Y
SA047-118	Digital Temperature-Humidity Recorder	RS210	YIJIE	1Y
EM045-01-01	EMC32 software (RE/RS)	V10.01.00	R&S	N/A

TEST REPORT

Detail of the equipment calibration due date:

Equipment No.	Cal. Due date (DD-MM-YYYY)
Conducted Disturbance-Mains Terminal (1)	
EM080-05	15/07/2022
EM006-05	06/06/2022
SA047-112	22/11/2022
EM004-04	06/01/2023
Conducted Disturbance-Mains Terminal (2)	
EM031-04	06/01/2023
EM006-06	03/09/2022
SA047-111	22/11/2022
EM004-03	06/01/2023
EM031-04-01	N/A
Conducted Disturbance-Load and Control Terminal (1)	
EM080-05	15/07/2022
EM080-05-01	02/09/2022
SA047-112	22/11/2022
EM004-04	06/01/2023
Conducted Disturbance-Load and Control Terminal (2)	
EM080-05	15/07/2022
EM005-06-01	02/09/2022
SA047-112	22/11/2022
EM004-04	06/01/2023
Conducted Disturbance-Telecom Terminal	
EM080-05	15/07/2022
EM011-05	05/04/2022
EM011-06	05/04/2022
EM006-06	03/09/2022
SA047-112	22/11/2022
EM004-04	6/01/2023
Conducted Disturbance-Antenna Terminal	
EM031-04	06/01/2023
EM084-02	19/07/2022
EM041-01	05/01/2022
EM041-02	05/01/2022
SA047-111	22/11/2022
EM004-03	06/01/2023
click (1)	

Equipment No.	Cal. Due date (DD-MM-YYYY)
Radiated Disturbance (CDN Method)	
EM080-05	15/07/2022
EM003-02	16/11/2022
EM003-03	16/11/2022
EM003-01-05	02/09/2022
EM032-02-01	15/07/2022
EM032-02-02	15/07/2022
SA047-112	22/11/2022
EM004-04	06/01/2023
Radiated electromagnetic disturbances (9 kHz-30 MHz)	
EM031-04	06/01/2023
EM061-04	07/03/2022
SA047-111	22/11/2022
EM004-03	06/01/2023
Radiated Disturbance (9 kHz-30 MHz)	
EM030-04	06/04/2022
EM031-02	16/11/2022
EM011-04	25/06/2022
EM031-02-01	05/04/2022
SA047-118	21/07/2022
EM045-01-01	N/A
Radiated Disturbance (30 MHz-1 GHz)	
EM030-04	06/04/2022
EM031-02	16/11/2022
EM033-01	18/10/2022
EM031-02-01	05/04/2022
EM036-01	18/07/2022
SA047-118	21/07/2022
EM045-01-01	N/A
Radiated Disturbance (1-18 GHz)	
EM030-04	06/04/2022
EM031-02	16/11/2022
EM031-03	23/12/2022
EM033-02	18/06/2022
EM033-02-02	05/04/2022
EM022-03	11/05/2022
SA047-118	21/07/2022
EM045-01-01	N/A

TEST REPORT

5. EMI TEST

5.1 Conducted Disturbance Voltage at mains ports

Test Result: Pass

5.1.1 Block Diagram of Test Setup

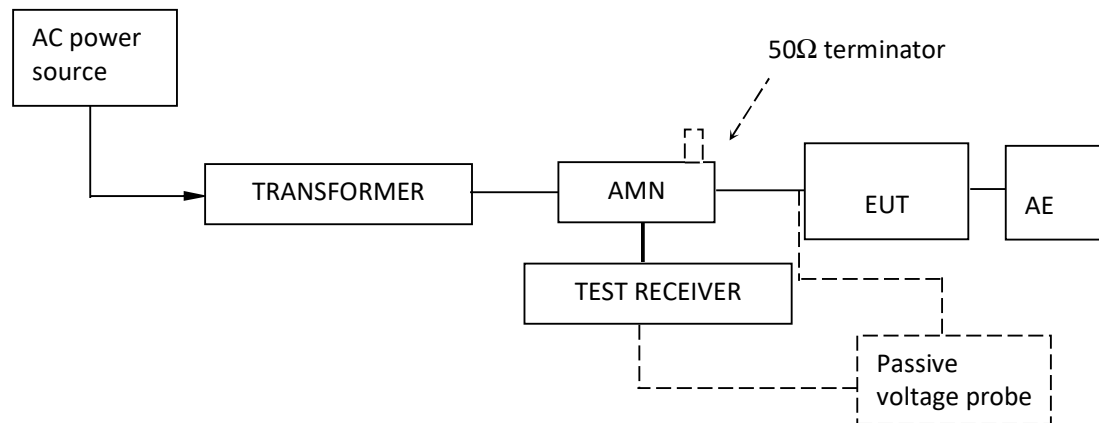

5.1.2 Test Setup and Procedure

The EUT was set to achieve the maximum emission level. The mains terminal disturbance voltage was measured with the EUT in a shielded room. The EUT was connected to AC power source through an Artificial Mains Network which provides a 50Ω linear impedance Artificial hand is used if appropriate (for handheld apparatus). The load/control terminal disturbance voltage was measured with passive voltage probe if appropriate.

The table-top EUT was placed on a 0.8m high non-metallic table above earthed ground plane (Ground Reference Plane). And for floor standing EUT, was placed on a 0.1m high non-metallic supported on GRP. The EUT keeps a distance of at least 0.8m from any other of the metallic surface. The Artificial Mains Network is situated at a distance of 0.8m from the EUT. During the test, mains lead of EUT excess 0.8m was folded back and forth parallel to the lead so as to form a horizontal bundle with a length between 0.3m and 0.4m.

The bandwidth of test receiver was set at 9 kHz. The frequency range from 150 kHz to 30MHz was checked.

TEST REPORT

5.1.3 Limit

Frequency range MHz	AC mains terminals dB (uV)	
	Quasi-peak	Average
0.15 to 0.5	66 to 56*	56 to 46*
0.5 to 5	56	46
5 to 30	60	50

Note 1: The limit decreases linearly with the logarithm of the frequency in the range 0.15 MHz to 0.5 MHz.
Note 2: The lower limit is applicable at the transition frequency.

5.1.4 Test Data and curve

**At mains terminal:
Tested Wire: Live**

Operation Mode: Lighting

Full Spectrum

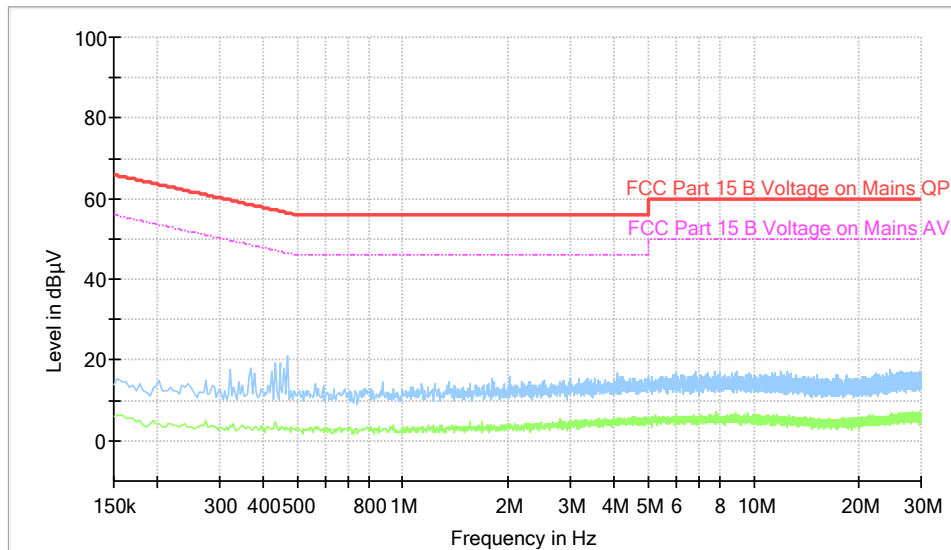

All emission levels are more than 6 dB below the limit.

TEST REPORT

Tested Wire: Neutral

Operation Mode: Lighting

Full Spectrum

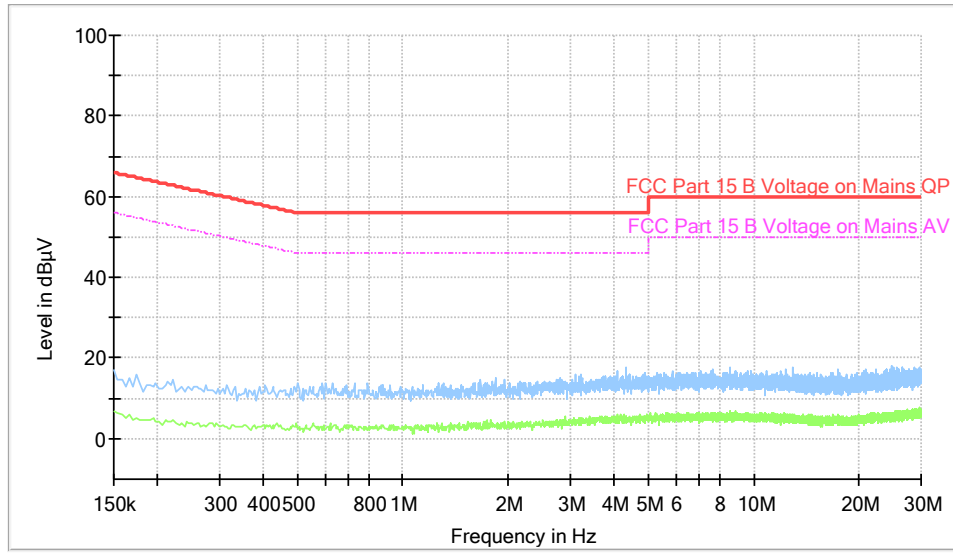

All emission levels are more than 6 dB below the limit.

TEST REPORT

5.2 Radiated Emission 30 MHz -1000 MHz

Test Result: Pass

5.2.1 Block Diagram of Test Setup

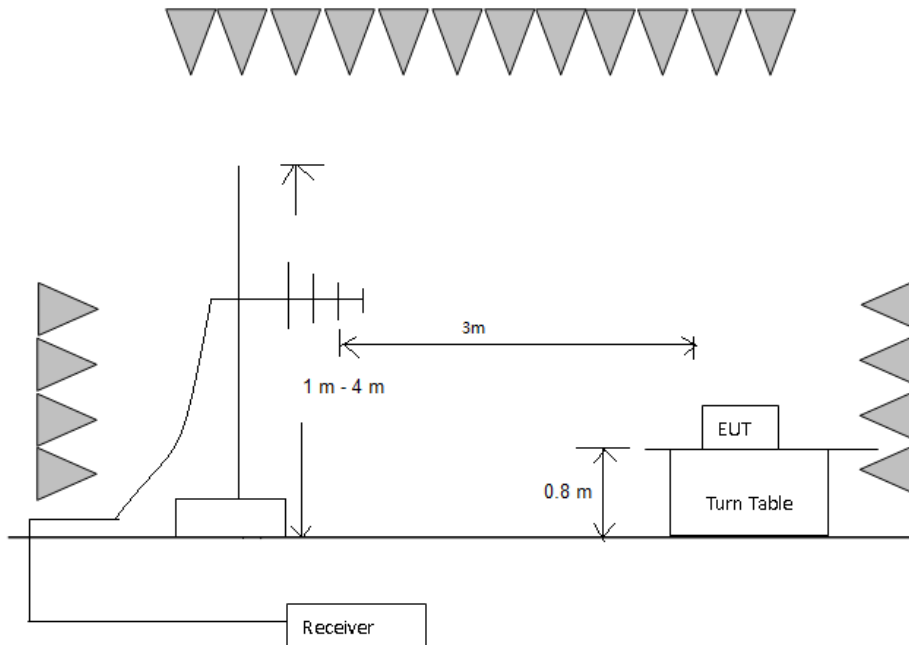

5.2.2 Test Setup and Procedure

The measurement was applied in a semi-anechoic chamber. The EUT and simulators were placed on a 0.8 m high foamed table above the horizontal metal ground plane. The turn table rotated 360 degrees to determine the position of the maximum emission level. The EUT was set 3 meters away from the receiving antenna which was mounted on an antenna mask. The antenna moved up and down between from 1 meter to 4 meters to find out the maximum emission level.

Broadband antenna was used as receiving antenna. Both horizontal and vertical polarization of the antenna was set on measurement. In order to find the maximum emission, all of the interface cables were manipulated according to ANSI C63.4 requirement during radiated test. The bandwidth setting on R&S Test Receiver was 120 kHz.

For an unintentional radiator, including a digital device, the spectrum shall be investigated from the lowest radio frequency signal generated or used in the device, without going below the lowest frequency for which a radiated emission limit is specified, up to the frequency shown in the following table:

TEST REPORT

Highest frequency generated or used in the device or on which the device operates or tunes (MHz)	Upper Frequency of Radiated Measurement
Below 1.705 MHz	30MHz
1.705 MHz – 108 MHz	1 GHz
108 MHz – 500 MHz	2 GHz
500 MHz – 1 GHz	5 GHz
Above 1 GHz	5th harmonic of the highest frequency or 40 GHz, whichever is lower.
At transitional frequencies the lower limit applies.	

Remark: Radiated Emission was performed from 30 MHz to 1 GHz.

5.2.3 Limit

Class B limit at 3m test distance:

Frequency range MHz	Quasi-peak limits dB (μV/m)
30 to 88	40
88 to 216	43.5
216 to 960	46
960 to 1000	54
At transitional frequencies the lower limit applies.	

5.2.4 Test Data and Curve

Operation Mode: Lighting
Horizontal

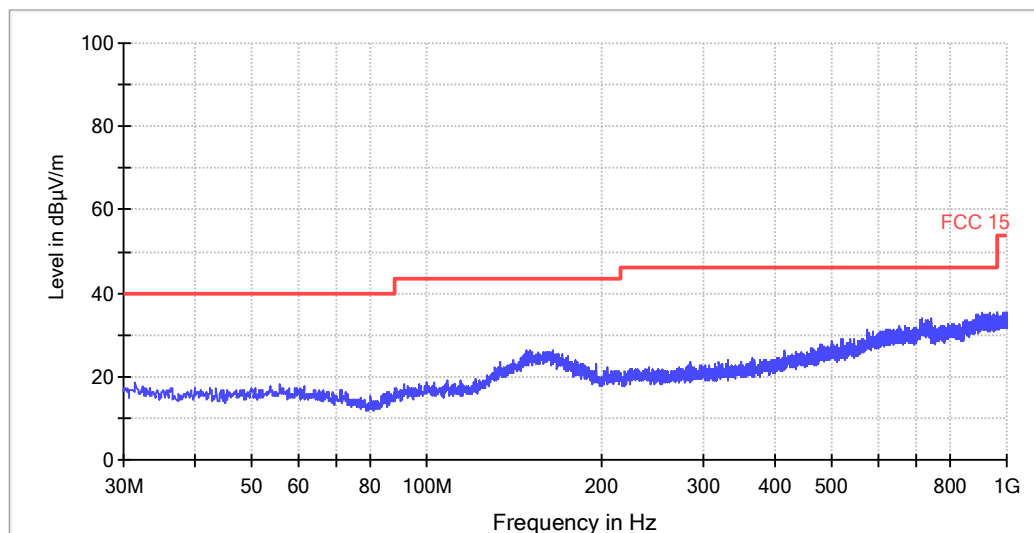

All emission levels are more than 6 dB below the limit.

TEST REPORT

Vertical

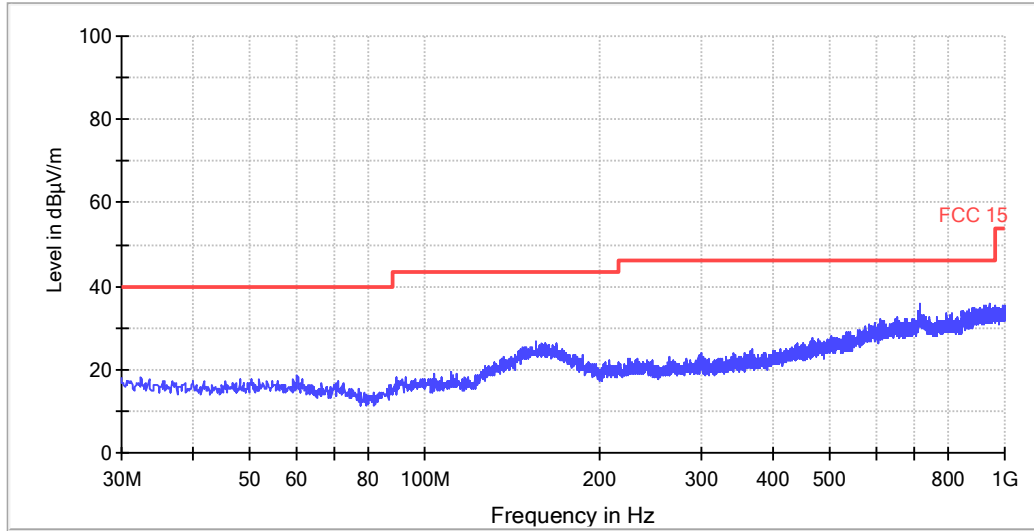

All emission levels are more than 6 dB below the limit.

5.3 Radiated Emission above 1 GHz

Test Result: Not Applicable

Remark:

The highest internal source of the EUT is not more than 108 MHz, so the measurement above 1000 MHz is not applicable.

*****End of Report*****