

IKEA of Sweden AB

TEST REPORT

SCOPE OF WORK

EMC TESTING– E2007 STARKVIND

REPORT NUMBER

201225187GZU-002

ISSUE DATE

14 April 2021

[REVISED DATE]

[-----]

PAGES

20

DOCUMENT CONTROL NUMBER

FCC Part 15:2019-e

© 2017 INTERTEK



TEST REPORT

Applicant Name & Address : IKEA of Sweden AB
Box 702, SE-343 81 Älmhult, Sweden
Manufacturing Site1 : Leedarson Lighting Co., Ltd.
Xingtai Industrial Park, Economic Development Zone, Changtai County,
Zhangzhou City, Fujian Province, P.R.China
Manufacturing Site2 : Haysonic IoT Technology CO., Ltd.
Xingtai Industrial Park, Economic Development Zone, Changtai
County, Zhangzhou City, Fujian Province, P.R.China
Intertek Report No: 201225187GZU-002

Test standards

CFR 47, FCC Part 15, Subpart B:2019

Sample Description

Product : Air Cleaner
Model No. : E2007 STARKVIND
Electrical Rating : For adapter: 100V-240V~, 50/60Hz, 1,2A Max, Class II,
For air cleaner: 24V===, MAX 48W
Serial No. : Not Labeled
Date Received : 25 December 2020
Date Test : 25 December 2020 to 14 April 2021
Conducted

Prepared and Checked By



Jed Guo

Engineer

Approved By:



Sky Zhu

Team Leader

This report is for the exclusive use of Intertek's Client and is provided pursuant to the agreement between Intertek and its Client. Intertek's responsibility and liability are limited to the terms and conditions of the agreement. Intertek assumes no liability to any party, other than to the Client in accordance with the agreement, for any loss, expense or damage occasioned by the use of this report. Only the Client is authorized to permit copying or distribution of this report and then only in its entirety. Any use of the Intertek name or one of its marks for the sale or advertisement of the tested material, product or service must first be approved in writing by Intertek. The observations and test results in this report are relevant only to the sample tested. This report by itself does not imply that the material, product, or service is or has ever been under an Intertek certification program.

Intertek Testing Services Shenzhen Ltd. Guangzhou Branch

Room 02, & 101/E201/E301/E401/E501/E601/E701/E801 of Room 01 1-8/F., No. 7-2. Caipin Road, Science City, GETDD,
Guangzhou, Guangdong, China

TEST REPORT

CONTENT

TEST REPORT 1

CONTENT 3

1. TEST RESULTS SUMMARY 4

2. EMC RESULTS CONCLUSION..... 5

3. LABORATORY MEASUREMENTS..... 6

4. EQUIPMENT USED DURING TEST 7

5. EMI TEST..... 9

5.1 CONDUCTED DISTURBANCE VOLTAGE AT MAINS PORTS 9

5.1.1 *Block Diagram of Test Setup*..... 9

5.1.2 *Test Setup and Procedure*..... 9

5.1.3 *Limit*..... 10

5.1.4 *Test Data and curve*..... 11

5.2 RADIATED EMISSION 30 MHz -1000 MHz..... 13

5.2.1 *Block Diagram of Test Setup*..... 13

5.2.2 *Test Setup and Procedure*..... 13

5.2.3 *Limit*..... 14

5.2.4 *Test Data and Curve* 15

5.3 RADIATED EMISSION ABOVE 1 GHz..... 17

6. PHOTO OF TEST SETUP AND EUT 20

TEST REPORT

1. TEST RESULTS SUMMARY

Classification of EUT: Class B

| Test Item | Standard | Result |
|--|--------------------------------|--------|
| Conducted disturbance voltage at mains ports | CFR 47, FCC Part 15, Subpart B | Pass |
| Radiated emission (30 MHz–1 GHz) | CFR 47, FCC Part 15, Subpart B | Pass |
| Radiated emission (Above 1 GHz) | CFR 47, FCC Part 15, Subpart B | Pass |
| Remark: Reference publication is used for methods of measurement: ANSI C63.4:2014 | | |

Remark:

1. The symbol "N/A" in above table means Not Applicable.
2. When determining the test results, measurement uncertainty of tests has been considered.

TEST REPORT

2. EMC RESULTS CONCLUSION

RE: EMC Testing Pursuant to FCC part 15 performed on the Air Cleaner, Model: E2007 STARKVIND

We tested the Air Cleaner, Model: E2007 STARKVIND to determine if it was in compliance with the relevant standards as marked on the Test Results Summary. We found that the unit met the requirement of FCC part 15 standard when tested as received. The worst case's test data was presented in this test report.

The production units are required to conform to the initial sample as received when the units are placed on the market.

TEST REPORT

3. LABORATORY MEASUREMENTS

Configuration Information

Support Equipment: N/A

Rated Voltage and frequency under test: 120V~; 60 Hz
 Condition of Environment: Temperature: 22~28°C
 Relative Humidity:35~60%
 Atmosphere Pressure:86~106kPa

Notes:

1. The EMI measurements had been made in the operating mode produced the largest emission in the frequency band being investigated consistent with normal applications. An attempt had been made to maximize the emission by varying the configuration of the EUT.

2. Test Facility accreditation:
 A2LA Certificate Number 0078.10
 Intertek Testing Services Shenzhen Ltd. Guangzhou Branch is accredited by A2LA and Listed in FCC website. FCC accredited test labs may perform both Certification testing under Parts 15 and 18 and Declaration of Conformity testing.

3. Test Location:
 Intertek Testing Services Shenzhen Ltd. Guangzhou Branch
 All tests were performed at:
 Room 02, & 101/E201/E301/E401/E501/E601/E701/E801 of Room 01 1-8/F., No. 7-2. Caipin Road, Science City, GETDD, Guangzhou, Guangdong, China
 Except Radiated Emissions was performed at:
 Room102/104, No 203, KeZhu Road, Science City, GETDD Guangzhou, China

4. Measurement Uncertainty

| No. | Item | Measurement Uncertainty |
|-----|-------------------------------------|-------------------------|
| 1 | Conducted Emission (9 kHz-150 kHz) | 2.79 dB |
| 2 | Conducted Emission (150 kHz-30 MHz) | 2.55 dB |
| 3 | Disturbance Power (30 MHz-300 MHz) | 3.04 dB |
| 4 | Radiated Emission (30 MHz-1 GHz) | 4.80 dB |
| 5 | Radiated Emission (1 GHz-6 GHz) | 4.97 dB |
| 6 | Radiated Emission (6 GHz-18 GHz) | 4.89 dB |

The measurement uncertainty describes the overall uncertainty of the given measured value during the operation of the EUT.

Measurement uncertainty is calculated in accordance with CISPR16-4-2:2011+A1:2014 +A2:2018.

The measurement uncertainty is given with a confidence of 95%, k=2.

Determination of the test conclusion is based on IEC Guide 115 in consideration of measurement uncertainty.

TEST REPORT

4. EQUIPMENT USED DURING TEST

Conducted Disturbance-Mains Terminal (1)

| Equipment No. | Equipment | Model | Manufacturer | Calibration Interval |
|---------------|---------------------------------------|----------|--------------|----------------------|
| EM080-05 | EMI receiver | ESCI | R&S | 1Y |
| EM006-05 | LISN | ENV216 | R&S | 1Y |
| SA047-112 | Digital Temperature-Humidity Recorder | RS210 | YIJIE | 1Y |
| EM004-04 | EMC shield Room | 8m×3m×3m | Zhongyu | 1Y |

Radiated Disturbance (30 MHz-1 GHz)

| Equipment No. | Equipment | Model | Manufacturer | Calibration Interval |
|---------------|--|-----------|--------------|----------------------|
| EM030-04 | 3m Semi-Anechoic Chamber | 9×6×6 m3 | ETS-LINDGREN | 1Y |
| EM031-02 | EMI Test Receiver (9 kHz~7 GHz) | R&S ESR7 | R&S | 1Y |
| EM033-01 | TRILOG Super Broadband test Antenna (30 MHz-3 GHz) | VULB 9163 | SCHWARZBECK | 1Y |
| EM031-02-01 | Coaxial cable | / | R&S | 1Y |
| EM036-01 | Common-mode absorbing clamp | CMAD 20B | TESEQ | 1Y |
| SA047-118 | Digital Temperature-Humidity Recorder | RS210 | YIJIE | 1Y |
| EM045-01-01 | EMC32 software (RE/RS) | V10.01.00 | R&S | N/A |

Radiated Disturbance (1-18 GHz)

| Equipment No. | Equipment | Model | Manufacturer | Calibration Interval |
|---------------|---|-----------|---------------|----------------------|
| EM030-04 | 3m Semi-Anechoic Chamber | 9×6×6 m3 | ETS—LINDGREN | 1Y |
| EM031-02 | EMI Test Receiver (9 kHz~7 GHz) | R&S ESR7 | R&S | 1Y |
| EM031-03 | Signal and Spectrum Analyzer (10 Hz~40 GHz) | R&S FSV40 | R&S | 1Y |
| EM033-02 | Bouble-Ridged Waveguide Horn Antenna (800 MHz-18 GHz) | R&S HF907 | R&S | 1Y |
| EM033-02-02 | Coaxial cable(1 GHz-18 GHz) | N/A | R&S | 1Y |
| EM022-03 | 2.45 GHz Filter | BRM 50702 | Micro-Tronics | 1Y |
| SA047-118 | Digital Temperature-Humidity Recorder | RS210 | YIJIE | 1Y |
| EM045-01-01 | EMC32 software (RE/RS) | V10.01.00 | R&S | N/A |

TEST REPORT

Detail of the equipment calibration due date:

| Equipment No. | Cal. Due date (DD-MM-YYYY) |
|---|-------------------------------|
| Conducted Disturbance-Mains Terminal (1) | |
| EM080-05 | 19/07/2021 |
| EM006-05 | 07/06/2021 |
| SA047-112 | 16/11/2021 |
| EM004-04 | 21/01/2022 |

| Equipment No. | Cal. Due date (DD-MM-YYYY) |
|--|-------------------------------|
| Radiated Disturbance (30 MHz-1 GHz) | |
| EM030-04 | 06/04/2022 |
| EM031-02 | 16/10/2021 |
| EM033-01 | 18/09/2021 |
| EM031-02-01 | 05/04/2022 |
| EM036-01 | 21/07/2021 |
| SA047-118 | 21/07/2021 |
| EM045-01-01 | N/A |
| Radiated Disturbance (1-18 GHz) | |
| EM030-04 | 06/04/2022 |
| EM031-02 | 16/10/2021 |
| EM031-03 | 06/09/2021 |
| EM033-02 | 18/06/2021 |
| EM033-02-02 | 05/04/2022 |
| EM022-03 | 10/05/2021 |
| SA047-118 | 21/07/2021 |
| EM045-01-01 | N/A |

TEST REPORT

5. EMI TEST

5.1 Conducted Disturbance Voltage at mains ports

Test Result: Pass

5.1.1 Block Diagram of Test Setup

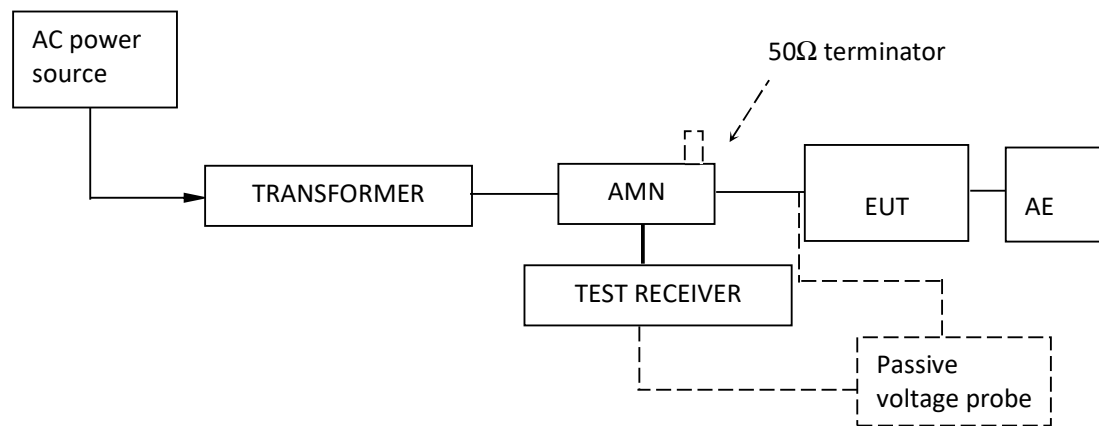

5.1.2 Test Setup and Procedure

The EUT was set to achieve the maximum emission level. The mains terminal disturbance voltage was measured with the EUT in a shielded room. The EUT was connected to AC power source through an Artificial Mains Network which provides a 50Ω linear impedance Artificial hand is used if appropriate (for handheld apparatus). The load/control terminal disturbance voltage was measured with passive voltage probe if appropriate.

The table-top EUT was placed on a 0.8m high non-metallic table above earthed ground plane(Ground Reference Plane).And for floor standing EUT, was placed on a 0.1m high non-metallic supported on GRP. The EUT keeps a distance of at least 0.8m from any other of the metallic surface. The Artificial Mains Network is situated at a distance of 0.8m from the EUT. During the test, mains lead of EUT excess 0.8m was folded back and forth parallel to the lead so as to form a horizontal bundle with a length between 0.3m and 0.4m.

The bandwidth of test receiver was set at 9 kHz. The frequency range from 150 kHz to 30MHz was checked.

TEST REPORT**5.1.3 Limit**

| Frequency range MHz | AC mains terminals dB (uV) | |
|------------------------|-------------------------------|-----------|
| | Quasi-peak | Average |
| 0.15 to 0.5 | 66 to 56* | 56 to 46* |
| 0.5 to 5 | 56 | 46 |
| 5 to 30 | 60 | 50 |

Note 1: The limit decreases linearly with the logarithm of the frequency in the range 0.15 MHz to 0.5 MHz.

Note 2: The lower limit is applicable at the transition frequency.

TEST REPORT

5.1.4 Test Data and curve

At mains terminal:
Tested Wire: Live

Operation Mode: max. speed

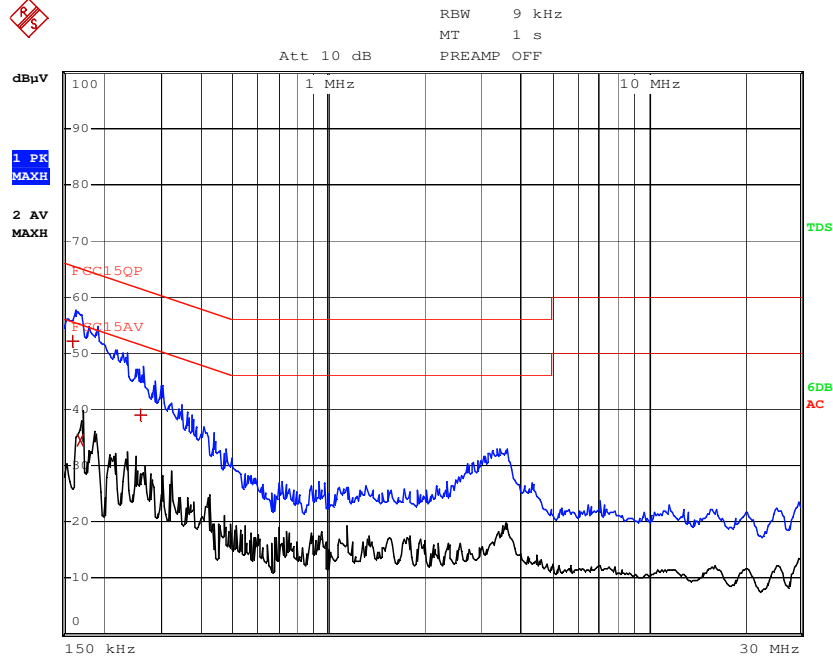

| EDIT PEAK LIST (Final Measurement Results) | | | | |
|--|-----------|------------|--------|----------|
| TRACE | FREQUENCY | LEVEL dBµV | DELTA | LIMIT dB |
| Trace1: | FCC15QP | | | |
| Trace2: | FCC15AV | | | |
| Trace3: | --- | | | |
| 1 Quasi Peak | 162 kHz | 52.21 L1 | -13.14 | |
| 2 Average | 170 kHz | 34.47 L1 | -20.48 | |
| 1 Quasi Peak | 262 kHz | 39.08 L1 | -22.28 | |

Remark:

1. Corr. (dB) = LISN Factor (dB) + Cable Loss (dB)
2. Level (dBµV) = Corr. (dB) + Read Level (dBµV)
3. Delta Limit (dB) = Level (dBµV)-Limit (dBµV)

TEST REPORT

Tested Wire: Neutral

Operation Mode: max. speed



RBW 9 kHz
MT 1 s
PREAMP OFF

Att 10 dB

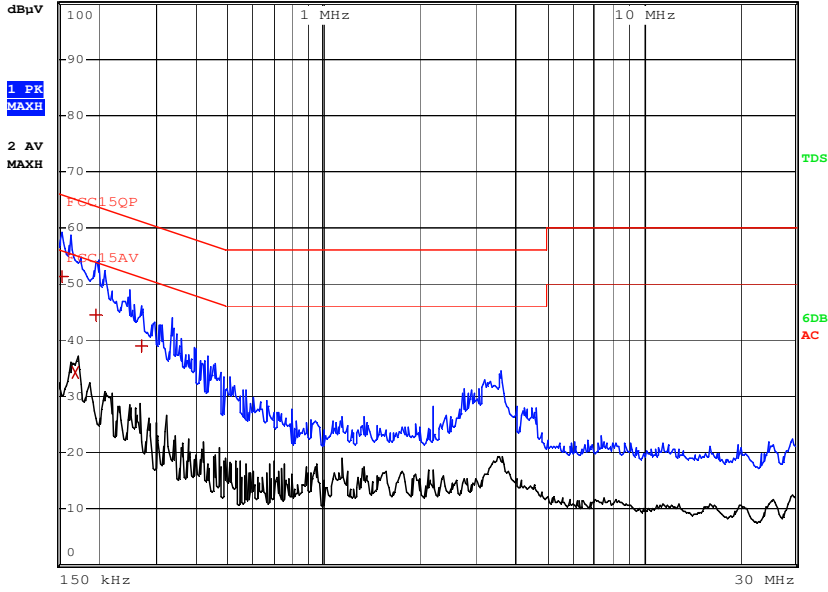

| EDIT PEAK LIST (Final Measurement Results) | | | | |
|--|------------|---------|-------|-------------|
| TRACE | FREQUENCY | LEVEL | dBµV | DELTA LIMIT |
| Trace1: | FCC15QP | | | |
| Trace2: | FCC15AV | | | |
| Trace3: | --- | | | |
| 1 | Quasi Peak | 154 kHz | 51.23 | L1 |
| 2 | Average | 170 kHz | 34.33 | L1 |
| 1 | Quasi Peak | 198 kHz | 44.42 | L1 |
| 1 | Quasi Peak | 270 kHz | 38.88 | L1 |

TEST REPORT

5.2 Radiated Emission 30 MHz -1000 MHz

Test Result: Pass

5.2.1 Block Diagram of Test Setup

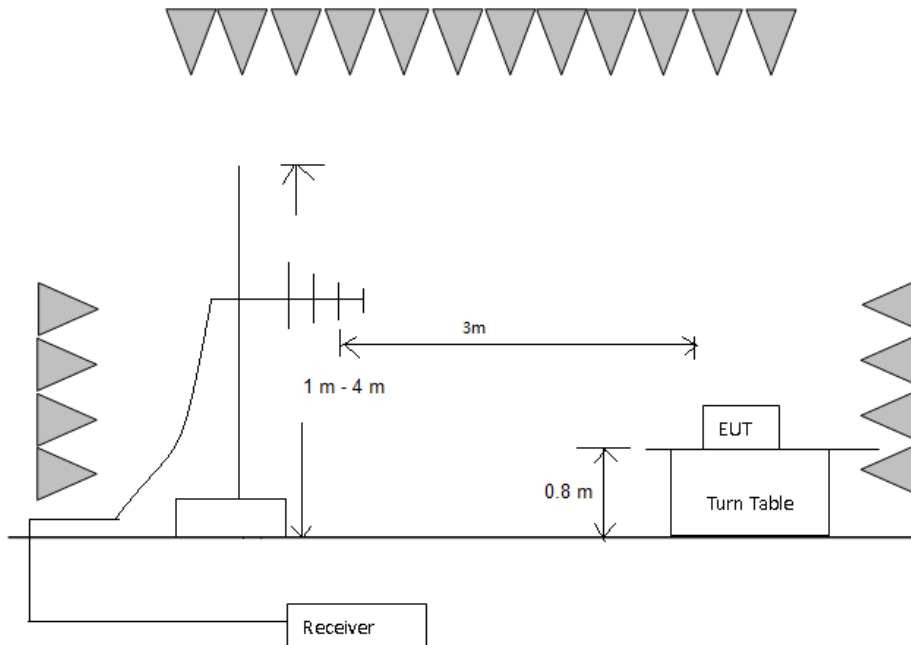

5.2.2 Test Setup and Procedure

The measurement was applied in a semi-anechoic chamber. The EUT and simulators were placed on a 0.8 m high wooden turntable above the horizontal metal ground plane. The turn table rotated 360 degrees to determine the position of the maximum emission level. The EUT was set 3 meters away from the receiving antenna which was mounted on an antenna mask. The antenna moved up and down between from 1 meter to 4 meters to find out the maximum emission level.

Broadband antenna was used as receiving antenna. Both horizontal and vertical polarization of the antenna was set on measurement. In order to find the maximum emission, all of the interface cables were manipulated according to ANSI C63.4 requirement during radiated test. The bandwidth setting on R&S Test Receiver was 120 kHz.

For an unintentional radiator, including a digital device, the spectrum shall be investigated from the lowest radio frequency signal generated or used in the device, without going below the lowest frequency for which a radiated emission limit is specified, up to the frequency shown in the following table:

TEST REPORT

| Highest frequency generated or used in the device or on which the device operates or tunes (MHz) | Upper Frequency of Radiated Measurement |
|--|--|
| Below 1.705 MHz | 30MHz |
| 1.705 MHz – 108 MHz | 1 GHz |
| 108 MHz – 500 MHz | 2 GHz |
| 500 MHz – 1 GHz | 5 GHz |
| Above 1 GHz | 5th harmonic of the highest frequency or 40 GHz, whichever is lower. |
| At transitional frequencies the lower limit applies. | |

Remark: Radiated Emission was performed from 30 MHz to 1 GHz.

5.2.3 Limit

Class B limit at 3m test distance:

| Frequency range MHz | Quasi-peak limits dB (µV/m) |
|--|--------------------------------|
| 30 to 88 | 40 |
| 88 to 216 | 43.5 |
| 216 to 960 | 46 |
| 960 to 1000 | 54 |
| At transitional frequencies the lower limit applies. | |

TEST REPORT

5.2.4 Test Data and Curve

Operation Mode: max. speed
Horizontal

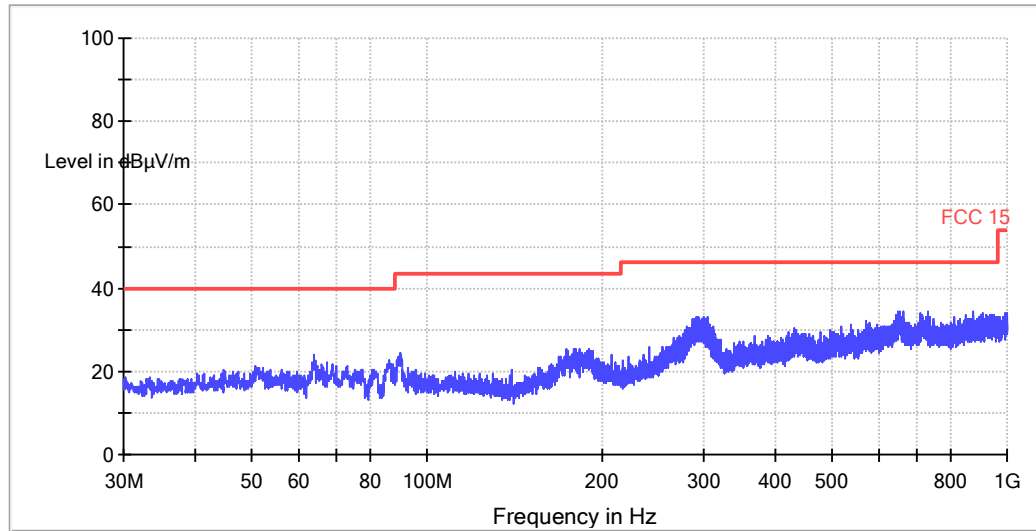

All emission levels are more than 6 dB below the limit.

TEST REPORT

Vertical

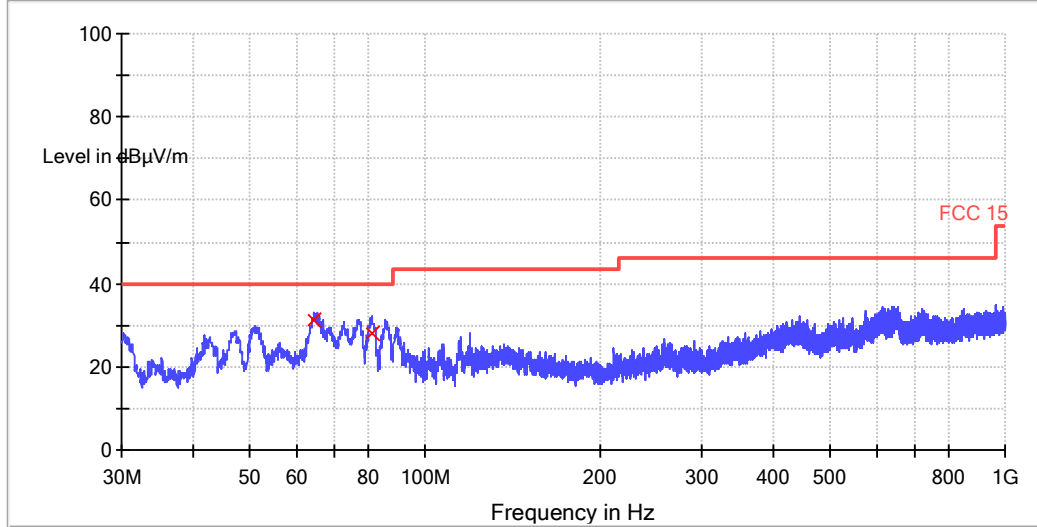

| Frequency (MHz) | Quasi Peak (dBµV/m) | Bandwidth (kHz) | Pol | Corr. (dB) | Margin - QPK (dB) | Limit - QPK (dBµV/m) |
|-----------------|---------------------|-----------------|-----|------------|-------------------|----------------------|
| 64.440000 | 31.3 | 120.000 | V | 12.1 | 8.7 | 40.0 |
| 81.040000 | 28.2 | 120.000 | V | 10.9 | 11.8 | 40.0 |

Remark:

1. Corr. (dB) = Antenna Factor (dB) + Cable Loss (dB)
2. Quasi Peak (dBµV/m) = Corr. (dB) + Read Level (dBµV)
3. Margin (dB) = Limit QPK (dBµV/m) – Quasi Peak (dBµV/m)

TEST REPORT

5.3 Radiated Emission above 1 GHz

Test Result: Pass

5.3.1 Block Diagram of Test Setup

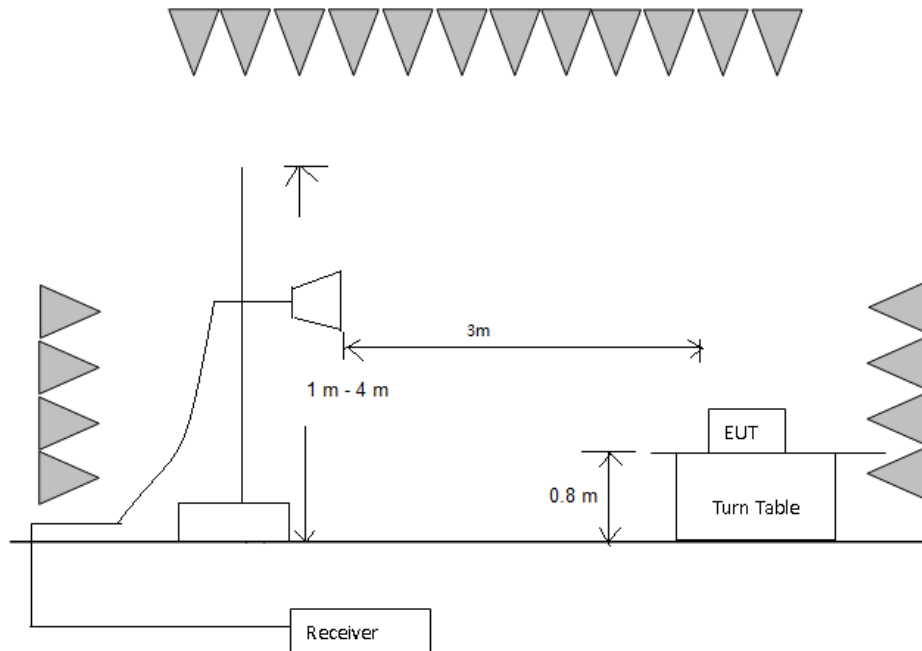

5.3.2 Test Setup and Procedure

The measurement was applied in a semi-anechoic chamber with absorbing material placed on the ground. The EUT were placed on a 0.8m high foamed table above the horizontal metal ground plane. The turntable varied every 30 degrees to determine the position of the maximum emission level. The EUT was set 3 meters away from the receiving antenna which was mounted on an antenna pole. The antenna moved up and down from 1 meter to 4 meters to find out the maximum emission level.

Horn antenna was used as receiving antenna. Both horizontal and vertical polarization of the antenna was set on measurement. In order to find the maximum emission, all of the interface cables were manipulated during radiated test.

For an unintentional radiator, including a digital device, the spectrum shall be investigated from the lowest radio frequency signal generated or used in the device, without going below the lowest frequency for which a radiated emission limit is specified, up to the frequency shown in the following table:

TEST REPORT

| Highest Frequency Generated or Used in Device | Upper Frequency of Radiated Measurement |
|--|--|
| Below 1.705 MHz | 30MHz |
| 1.705 MHz – 108 MHz | 1 GHz |
| 108 MHz – 500 MHz | 2 GHz |
| 500 MHz – 1 GHz | 5 GHz |
| Above 1 GHz | 5th harmonic of the highest frequency or 40 GHz, whichever is lower. |
| At transitional frequencies the lower limit applies. | |

Remark: Radiated Emission was performed from 1 GHz to 2 GHz since the highest frequency generated from the EUT was 2.4 GHz.

5.3.3 Limit

Class B limit at 3m test distance:

| Frequency range MHz | Linear Average Detector dB ($\mu\text{V}/\text{m}$) | Peak Detector dB ($\mu\text{V}/\text{m}$) |
|--|---|---|
| > 1000 | 54 | 74 |
| At transitional frequencies the lower limit applies. | | |

TEST REPORT

5.3.4 Test Data and Curve

Operation Mode: max speed and wireless connected
Horizontal

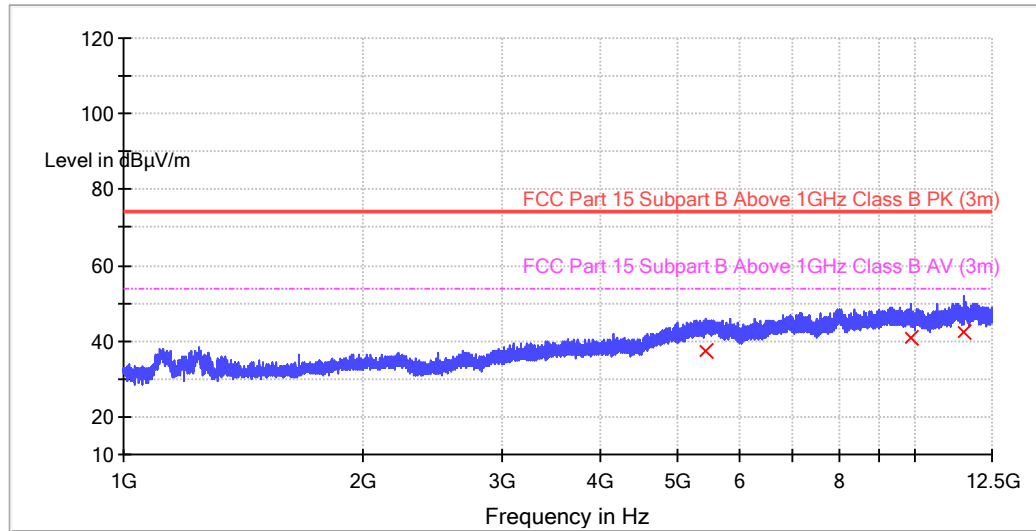

| Frequency (MHz) | Average (dBµV/m) | Bandwidth (kHz) | Pol | Corr. (dB) | Margin - QPK (dB) | Limit - QPK (dBµV/m) |
|-----------------|------------------|-----------------|-----|------------|-------------------|----------------------|
| 11532.800000 | 42.2 | 1000.00 | H | 10.0 | 11.8 | 54.0 |
| 9858.000000 | 40.9 | 1000.00 | H | 8.3 | 13.1 | 54.0 |
| 5447.200000 | 37.2 | 1000.00 | H | 3.4 | 16.8 | 54.0 |

Remark:

1. Corr. (dB) = Antenna Factor (dB) + Cable Loss (dB) –Pre-amplifier (dB)
2. Peak (dBµV/m) = Corr. (dB) + Read Level (dBµV)
3. Margin (dB) = Limit Peak (dBµV/m) –Peak (dBµV/m)

TEST REPORT

Vertical

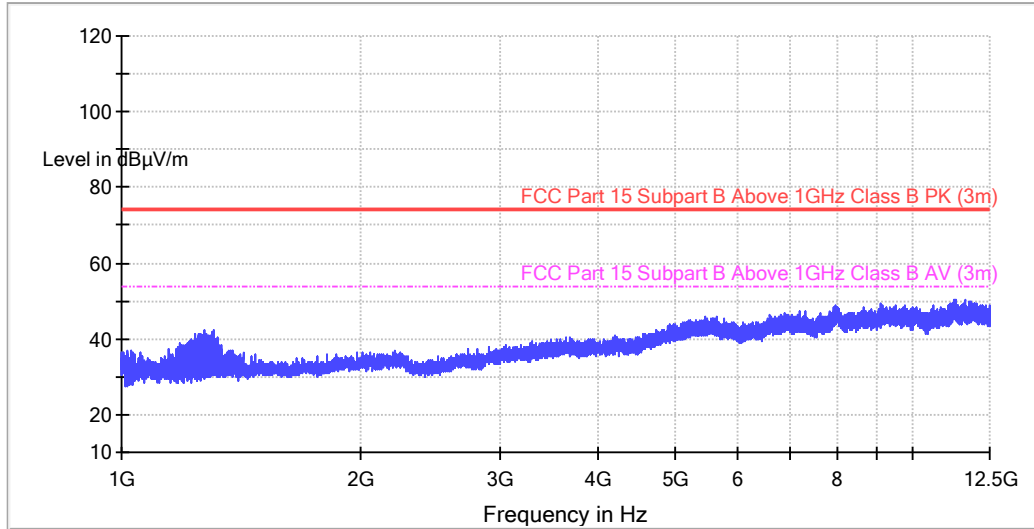

All emission levels are more than 6 dB below the limit.

6. PHOTO OF TEST SETUP AND EUT

Test set up and EUT photos are put in 201225187GZU-002 Annex 1 separately as part of this test report.

*****End of Report*****