

<b>Prüfbericht-Nr.:</b> <i>Test report no.:</i>	<b>60431073-004</b>	<b>Auftrags-Nr.:</b> <i>Order no.:</i>	23870469 030	Seite 1 von 36 <i>Page 1 of 36</i>
<b>Kunden-Referenz-Nr.:</b> <i>Client reference no.:</i>	1288983	<b>Auftragsdatum:</b> <i>Order date:</i>	2020.11.29	
<b>Auftraggeber:</b> <i>Client:</i>	IKEA of Sweden AB			
<b>Prüfgegenstand:</b> <i>Test item:</i>	Hub for smart products			
<b>Bezeichnung / Typ-Nr.:</b> <i>Identification / Type no.:</i>	DIRIGERA / E2003 / FCC ID: FHO-E2003			
<b>Auftrags-Inhalt:</b> <i>Order content:</i>	Accredited testing according to FCC Part 15C			
<b>Prüfgrundlage:</b> <i>Test specification:</i>	FCC 47 CFR Part 15.247 with parts 15.207 & 15.209 ANSI C63.10: 2013			
<b>Wareneingangsdatum:</b> <i>Date of sample receipt:</i>	2020.11.30			
<b>Prüfmuster-Nr.:</b> <i>Test sample no.:</i>	See section 2.3			
<b>Prüfzeitraum:</b> <i>Testing period:</i>	2020.12.01 – 2021.04.22			
<b>Ort der Prüfung:</b> <i>Place of testing:</i>				
<b>Prüflaboratorium:</b> <i>Testing laboratory:</i>	TÜV Rheinland Sweden			
<b>Prüfergebnis*:</b> <i>Test result*:</i>	Pass			
<b>überprüft von:</b> <i>reviewed by:</i>		<b>genehmigt von:</b> <i>authorized by:</i>		
<b>Datum: 2022.02.15</b> <i>Date:</i>	Signed by: Niall Forrester	<b>Datum: 2022.02.15</b> <i>Date:</i>	Signed by: Hakan Ahlberg	
<b>Stellung / Position:</b>	Senior Technical Expert	<b>Stellung / Position:</b>	Lab Manager	
<b>Sonstiges / Other:</b>	This report contains measurements for the Bluetooth Low Energy radio interface only			
<b>Zustand des Prüfgegenstandes bei Anlieferung:</b> <i>Condition of the test item at delivery:</i>	Prüfmuster vollständig und unbeschädigt <i>Test item complete and undamaged</i>			
* Legende:	1 = sehr gut P(ass) = entspricht o.g. Prüfgrundlage(n)	2 = gut F(ail) = entspricht nicht o.g. Prüfgrundlage(n)	3 = befriedigend N/A = nicht anwendbar	4 = ausreichend N/T = nicht getestet
* Legend:	1 = very good P(ass) = passed a.m. test specification(s)	2 = good F(ail) = failed a.m. test specification(s)	3 = satisfactory N/A = not applicable	4 = sufficient N/T = not tested
<p><b>Dieser Prüfbericht bezieht sich nur auf das o.g. Prüfmuster und darf ohne Genehmigung der Prüfstelle nicht auszugsweise vervielfältigt werden. Dieser Bericht berechtigt nicht zur Verwendung eines Prüfzeichens.</b> <i>This test report only relates to the a. m. test sample. Without permission of the test center this test report is not permitted to be duplicated in extracts.</i></p>				

## Revision History<sup>60431073-004</sup><sup>60431073-004</sup>

REVISION	DATE	REMARKS	AUTHOR
001	2021.04.27	First Release	Niall Forrester
002	2021.09.28	Corrected gain figures, updated module name.	Niall Forrester
003	2021.12.06	Replaced gain with module figure	Niall Forrester
004	2022.02.15	Corrected label - peak output power	Niall Forrester

Note: Latest revision report will replace all previous reports

This report based on FCC Part 15.247 Template version 1.2

## Summary of Test Results

FCC 47 CFR Rule Part	Test Description	Applicability	Report Section	RESULT	REMARKS
15.207	AC Power Line Conducted Emissions (Intentional Radiators)	YES	4.1	PASS	
15.209	Radiated Emissions (Intentional Radiators)	YES	4.2	PASS	
15.247 (d)	Antenna Conducted Emissions	NO	4.3	N/A.	Radiated testing performed
15.247 (d)	Band Edge Compliance (Authorized Band)	YES	4.4	N.P.	See Note 1
15.247 (d)	Band Edge Compliance (Restricted Band)	YES	4.5	PASS	
15.247 (a)(1)	20dB Bandwidth	NO	4.6	N/A	BLE is non-hopping
15.247 (a)(1)	Carrier (Hopping Channel) Separation	NO	4.7	N/A	BLE is non-hopping
15.247 (a)(1)	Number of Hopping Channels	NO	4.8	N/A	BLE is non-hopping
15.247 (a)(1)	Time of Occupancy (Dwell Time)	NO	4.9	N/A	BLE is non-hopping
15.247 (a)(2)	6dB Bandwidth	YES	4.10	N.P.	See Note 1
15.247 (b)	Peak Conducted Output Power	YES	4.11	N.P.	See Note 1
15.247 (e)	Power Spectral Density	YES	4.12	N.P.	See Note 1
-	Conducted Power Comparison	YES	4.13	Comparison Only	Comparing with certified module

Possible test case verdicts:

- Test case does not apply to the test object: N/A
- Test object complies with the requirement: PASS or COMPLIANT
- Test object does not meet the requirement: FAIL or NOT COMPLIANT
- Test case not performed on the test object: N.P.

**Note 1:** the device includes pre-certified modules as described in section 2.1 below

## Table of Contents

1. GENERAL INFORMATION .....	4
1.1 Test Site.....	4
1.2 Client Information .....	4
2. PRODUCT INFORMATION.....	5
2.1 General Description.....	5
2.2 Device Characteristics.....	5
2.3 Test Samples .....	5
2.4 Wireless Technologies and Bands Supported by the EUT.....	6
2.5 Antenna Information.....	6
2.6 Simultaneous Transmission Capabilities .....	6
2.7 Wireless Technology Details .....	7
2.8 Ancillary Equipment.....	7
2.9 EUT Diagrams.....	7
3. TEST METHODS .....	8
3.1 Test Standards.....	8
3.2 Additional references.....	8
3.3 Limits .....	9
3.4 Description of Test Methods and Equipment Setup .....	10
3.5 EUT Configuration During Test.....	14
3.6 EUT Operation Modes.....	14
3.7 Deviations from the Test Standard .....	14
3.8 Environmental Conditions.....	15
4. TEST RESULTS .....	16
4.1 Test Results – AC Power Line Conducted Emissions (Intentional Transmitter).....	16
4.2 Test Results – Radiated Emissions (Intentional Transmitter).....	19
4.3 Test Results – Antenna Conducted Emissions .....	30
4.4 Test Results – Band Edge Compliance (Authorized Band).....	30
4.5 Test Results – Band Edge Compliance (Restricted Band).....	30
4.6 Test Results – 20dB Bandwidth.....	33
4.7 Test Results – Carrier (Hopping Channel) Separation .....	33
4.8 Test Results – Number of Hopping Channels .....	33
4.9 Test Results – Time of Occupancy (Dwell Time) .....	33
4.10 Test Results – 6dB Bandwidth.....	33
4.11 Test Results – Peak Conducted Output Power .....	33
4.12 Test Results – Power Spectral Density.....	33
4.13 Test Results – Conducted Power Comparison .....	34
5. TEST EQUIPMENT STATUS.....	35
5.1 List of Hardware with Calibration Dates .....	35
5.2 Software / Firmware Versions.....	36
6. MEASUREMENT UNCERTAINTY .....	36
6.1 Measurement Uncertainty for Conducted Power Measurements .....	36
6.2 Measurement Uncertainty for Conducted Emissions .....	36
6.3 Measurement Uncertainty for SAC 5 (Radiated Emissions & Band Edge) .....	36
7. PHOTOGRAPHS.....	36

## 1. GENERAL INFORMATION

### 1.1 Test Site

Test Facility:	TÜV Rheinland Sweden AB
Address:	Mobilvägen 10
	223 62 Lund
	Sweden
Swedac Registration Number:	10325
FCC Test Firm Registration Number:	517458
ISED Test Site Registration Number:	24753

### 1.2 Client Information

Company Name:	IKEA
Address:	Tulpanvägen 8
	343 34 Älmhult
	Sweden
Contact Person:	Jeton Salihu
Contact e-Mail / Telephone	<a href="mailto:Jeton.salihu@inter.ikea.com">Jeton.salihu@inter.ikea.com</a> +46 701443175

## 2. PRODUCT INFORMATION

### 2.1 General Description

<b>Model name:</b>	DIRIGERA
<b>Manufacturer:</b>	IKEA of Sweden AB, SE-343 81 Älmhult
<b>Model number / Marketing name:</b>	E2003
<b>FCC ID:</b>	FHO-E2003
<b>Description:</b>	Electronic product acting as central hub for IKEA's Home Smart products.
<b>Ancillary Equipment:</b>	See section 2.8

The device incorporates three separate pre-certified modules:

- Murata LBEE5ZZ2AW (FCC ID: VPYLBEE5HY1MW) for WLAN 2.4 GHz 802.11 b/g/n, WLAN 5GHz 802.11 a/n/ac and Bluetooth Low Energy
- Silicon Labs MGM210L "No. 1" (FCC ID: QOQMGM210L) for ZigBee 802.15.4
- Silicon Labs MGM210L "No. 2" (FCC ID: QOQMGM210L) for Thread 802.15.4

Each module uses its own built-in antenna

### 2.2 Device Characteristics

<b>Type of Power Supply</b>	USB Power Supply (via AC/DC Adapter)
<b>Nominal Supply Voltage</b>	120V or 230V AC (Adapter) / 5V DC (USB)
<b>Supply Voltage Range</b>	100-240V AC
<b>Operating Temperature Range</b>	0°C - 40 °C
<b>Operating Air Humidity Range</b>	-
<b>Highest Internal Frequency Source</b>	5825 MHz

### 2.3 Test Samples

EUT #	EUT ID	Description	Used For:
1	A002959287-010	Standard Sample	Conducted Emissions Radiated Emissions
2	A002959287-013	Standard Sample	Radiated Emissions
3	A002959287-036	Modified with semi-rigid cable in place of each	Conducted Power Measurements

## 2.4 Wireless Technologies and Bands Supported by the EUT

Technology	Band	Frequency Range (Tx)	Evaluation Performed*
WiFi 802.11 b/g/n (LBEE5ZZ2AW)	2.4 GHz	2412 MHz - 2462 MHz	NO
WiFi 802.11 a/n/ac (LBEE5ZZ2AW)	5 GHz	5180 MHz - 5240 MHz 5260 MHz - 5320 MHz 5500 MHz - 5720 MHz 5745 MHz - 5825 MHz	NO
BlueTooth Low Energy (LBEE5ZZ2AW)	2.4 GHz	2402 MHz – 2480 MHz	YES
ZigBee 802.15.4 (MGM210L No.1)	2.4 GHz	2400 MHz – 2483.5 MHz	NO
Thread 802.15.4 (MGM210L No.2)	2.4 GHz	2400 MHz – 2483.5 MHz	NO

\*This statement refers only to this report. Other wireless technologies may be covered by other reports.

## 2.5 Antenna Information

Technology	Band	Number of Antennas	Antenna Type(s)	Gain
WiFi 802.11 a/b/g/n/ac BlueTooth Low Energy (LBEE5ZZ2AW)	2.4 GHz	1	Monopole	0.10
	5 GHz			-0.40
ZigBee 802.15.4 (MGM210L No.1)	2.4 GHz	1	Inverted F PCB Trace	0.50
Thread 802.15.4 (MGM210L No.2)	2.4 GHz	1	Inverted F PCB Trace	0.50

## 2.6 Simultaneous Transmission Capabilities

Active Technologies	Bands	Active Modules
WiFi 802.11 a/n/ac + ZigBee 802.15.4	5 GHz  2.4 GHz	(LBEE5ZZ2AW) + (MGM210L No.1)
WiFi 802.11 a/n/ac + Thread 802.15.4	5 GHz  2.4 GHz	(LBEE5ZZ2AW) + (MGM210L No.2)

Except for the two cases listed above, no other simultaneous transmission capabilities are supported by the device. It is not possible for the device to send on any two 2.4GHz technologies simultaneously, and there is no situation where all three modules are active simultaneously. The LBEE5ZZ2AW module cannot transmit for Bluetooth simultaneously with any WLAN configuration.

## 2.7 Wireless Technology Details

Technology	Band	Modulation Type(s)	No. of Channels	Channel Spacing	Adaptivity
WiFi 802.11 b/g/n (LBEE5ZZ2AW)	2.4 GHz	CCK / BPSK / QPSK / 16-QAM / 64-QAM	11	5 MHz	N/A
WiFi 802.11 a/n/ac (LBEE5ZZ2AW)	5 GHz	BPSK / QPSK / 16-QAM / 64-QAM	As per 802.11	5 MHz	N/A
BlueTooth Low Energy (LBEE5ZZ2AW)	2.4 GHz	GFSK	40	2 MHz	N/A
ZigBee 802.15.4 (MGM210L No.1)	2.4 GHz	O-QPSK	16	5 MHz	N/A
Thread 802.15.4 (MGM210L No.2)	2.4 GHz	O-QPSK	16	5 MHz	N/A

## 2.8 Ancillary Equipment

ID	Description	Manufacturer / Model	Hardware & Software Versions
A002959287-011	AC/DC Power Supply	IKEA ICPWS5	-
A002959287-012	USB Cable	-	-
A002959287-017	AC/DC Power Supply	IKEA ICPWS5	-
A002959287-018	USB Cable	-	-
A002959287-020	LAN Cable (UTP)	-	-
A002959287-025	LAN Cable (UTP)	-	-

## 2.9 EUT Diagrams

-

### 3. TEST METHODS

#### 3.1 Test Standards

Testing was performed according to the following standards / references

Standard	Version	Description
FCC 47 CFR 15.247	-	Operation within the bands 902-928 MHz, 2400-2483.5 MHz, and 5725-5850 MHz.
FCC 47 CFR 15.207	-	Conducted limits
FCC 47 CFR 15.209	-	Radiated emission limits; general requirements

#### 3.2 Additional references

The following standards / references were also considered for the testing

Standard	Version	Description
ANSI C63.10	2013	American National Standard of Procedures for Compliance Testing of Unlicensed Wireless Devices



### 3.3 Limits

FCC 47 CFR Rule Part	Test Description	Limit Reference (FCC 47 CFR Reference)
15.207	AC Power Line Conducted Emissions (Intentional Radiators)	15.207 (a)
15.209	Radiated Emissions (Intentional Radiators)	15.209 (a) *See Note 1
15.247 (d)	Out of Band Emissions	15.247 (d)
15.247 (d)	Band Edge Compliance (Authorized Band)	15.247 (d)
15.247 (d)	Band Edge Compliance (Restricted Band)	15.247 (d)
15.247 (a)(1)	20dB Bandwidth	15.247 (a)(1)
15.247 (a)(1)	Carrier (Hopping Channel) Separation	15.247 (a)(1)
15.247 (a)(1)	Number of Hopping Channels	15.247 (a)(1)
15.247 (a)(1)	Time of Occupancy (Dwell Time)	15.247 (a)(1)
15.247 (a)(2)	6dB Bandwidth	15.247 (a)(2)
15.247 (b)	Peak Conducted Output Power	15.247 (b)(1) [Hopping] 15.247 (b)(3) [Non-Hopping]
15.247 (e)	Power Spectral Density	15.247 (e)

Interpretation of the measurement results has been performed in accordance with ANSI C63.10 section 1.3

Compliance with the requirements has been based on the results of the measurements compared to the specified limits, not taking into account measurement instrumentation uncertainty.

Measurement Uncertainty figures are stated in section 6

#### Note 1

Radiated Emissions limits in the tables from 47 CFR sections 15.109 & 15.209 are presented in  $\mu\text{V}/\text{m}$ . Measurements on the test system are made in  $\text{dB}\mu\text{V}/\text{m}$ . To convert between these, the following adjustment is used:

$$\text{New Limit} = 20 \log \left( \frac{\text{Original Limit}}{10^6} \right) + 120$$

Example: from 15.209(a) the limit for 30MHz – 88MHz is  $100\mu\text{V}/\text{m}$  at 3m. This gives:

$$\text{New Limit} = 20 \log \left( \frac{100}{10^6} \right) + 120 = 40\text{dB}\mu\text{V}/\text{m} \text{ at } 3\text{m}$$

Additionally, in some cases testing has been performed at distances other than those specified in the tables. When this has occurred, the limits have been adjusted in accordance with the requirements in 47 CFR 15.31, using an extrapolation factor of 40dB/decade at frequencies below 30MHz and 20dB/decade at or above 30MHz

Example: from 15.209(a) the limit for 1.705MHz – 30MHz is  $30\mu\text{V}/\text{m}$  (=29.54  $\text{dB}\mu\text{V}/\text{m}$ ) at 30m

$$\text{Limit@3m} = \text{Limit@30m} + 40 \log \left( \frac{30}{3} \right) = 29.54 + 40.00 = 69.54 \text{ dB}\mu\text{V}/\text{m} \text{ at } 3\text{m}$$

Example: from 15.209(a) the limit for 1GHz – 18GHz is  $500\mu\text{V}/\text{m}$  (=53.98  $\text{dB}\mu\text{V}/\text{m}$ ) at 3m

$$\text{Limit@1m} = \text{Limit@3m} + 20 \log \left( \frac{3}{1} \right) = 53.98 + 9.54 = 63.52 \text{ dB}\mu\text{V}/\text{m} \text{ at } 1\text{m}$$

### 3.4 Description of Test Methods and Equipment Setup

#### 3.4.1 General Description

Testing was performed in accordance with the various requirements of ANSI C63.4 and ANSI C63.10. Any deviations from the test methods are described in section 3.7

Where different arrangements of equipment were used for different types of measurements, these are tabulated in section 3.4.2 and details of each arrangement are included in subsequent sections

#### 3.4.2 Test Equipment Setup Used by Test Type

FCC 47 CFR Rule Part	Test Description	Test Equipment Used
15.207	AC Power Line Conducted Emissions (Intentional Radiators)	Conducted Emissions
15.209	Radiated Emissions (Intentional Radiators)	SAC5
15.247 (d)	Out of Band Emissions	N/A
15.247 (d)	Band Edge Compliance (Authorized band)	N.P.
15.247 (d)	Band Edge Compliance (Restricted band)	SAC 5
15.247 (a)(1)	20dB Bandwidth	N.P.
15.247 (a)(1)	Carrier (Hopping Channel) Separation	N.P.
15.247 (a)(1)	Number of Hopping Channels	N.P.
15.247 (a)(1)	Time of Occupancy (Dwell Time)	N.P.
15.247 (a)(2)	6dB Bandwidth	N.P.
15.247 (b)	Peak Conducted Output Power	N.P.
15.247 (e)	Power Spectral Density	N.P.

### 3.4.3 Test Equipment Setup – Conducted Emissions

- The EUT was placed 0.4 meters from the conducting wall of the shielded room with EUT being connected to the power mains through a line impedance stabilization network (LISN). Other support units were connected to the power mains through another LISN. The LISNs provide  $50\Omega/50\mu\text{H}$  of coupling impedance for the measuring instrument.
- The lines of the power mains connected to the EUT were checked for maximum conducted interference.
- The frequency range from 150 kHz to 30 MHz was searched. Emission levels over 10 dB under the prescribed limits could not be reported.

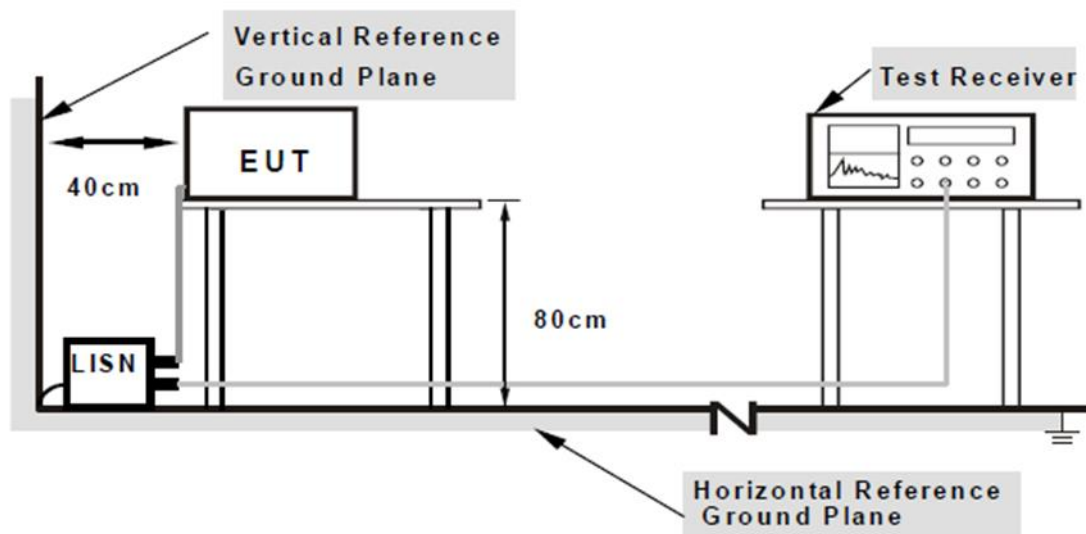

### 3.4.4 Test Equipment Setup – SAC 5 (Radiated Emissions and Restricted Band Edge)

- For frequency range 30MHz-1GHz Log-Periodic Antenna was used. Antenna elevated from 100 cm from floor to 400 cm from floor, and was placed at 3 m from center of turntable in tilted position. The equipment under test (EUT) was placed at the middle of the turntable at 150 cm height from floor. The antenna rotated to repeat the measurements for both the horizontal and vertical antenna polarizations. Repeat the measurement steps until the maximum emissions were obtained.
- For frequency range 1GHz-18GHz horn Antenna was used. Antenna elevated from 100 cm from floor to 200 cm from floor, and was placed at 3 m from center of turntable. The equipment under test (EUT) was placed at the middle of the turntable at 150 cm height from floor. The antenna rotated to repeat the measurements for both the horizontal and vertical antenna polarizations. Repeat the measurement steps until the maximum emissions were obtained.
- For frequency range 18GHz-40GHz double horn Antenna was used. Antenna's height was adjusted to 150 cm from floor, and 1 m distance to center of turntable. The equipment under test (EUT) was placed at the middle of the turntable on at 150 cm height from floor.
- For all frequency ranges the turntable was rotated 360° for obtaining the maximum emission.

SAC 5 Test Setup Configuration 30MHz – 1GHz

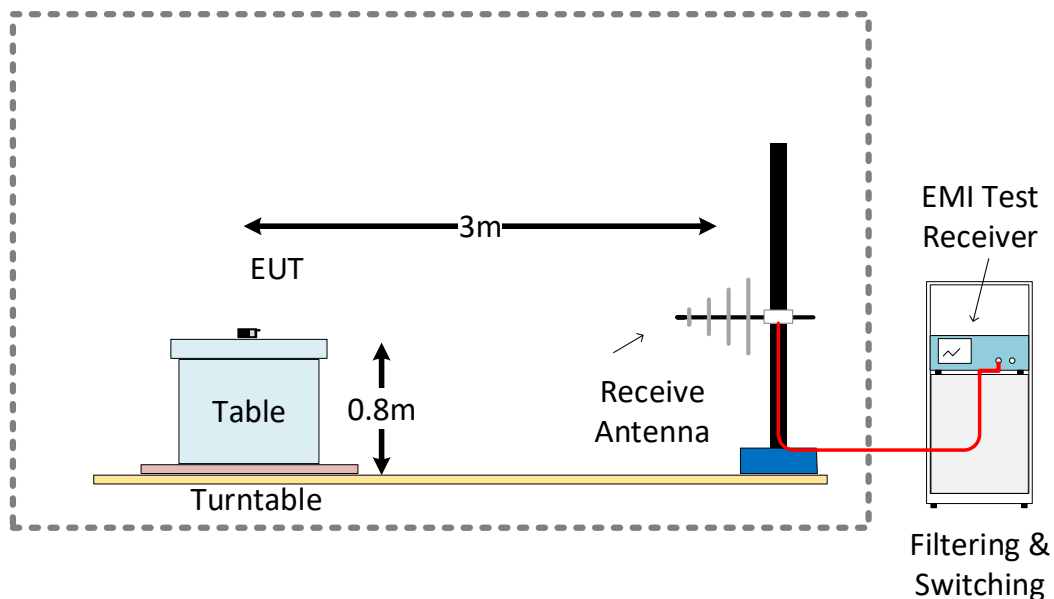

### SAC 5 Test Setup Configuration 1GHz – 18GHz

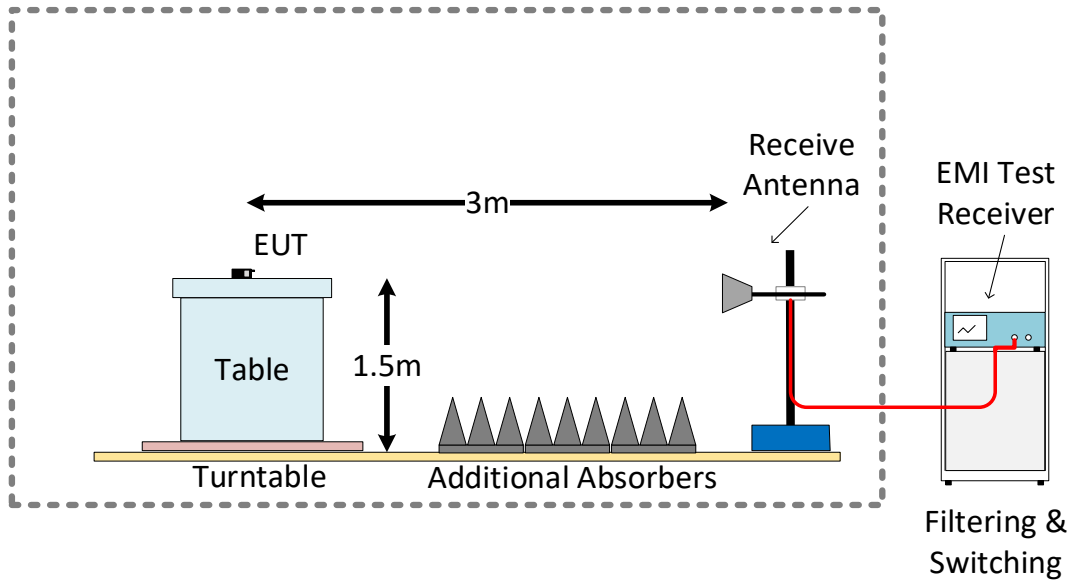

### SAC 5 Test Setup Configuration 18GHz – 40GHz

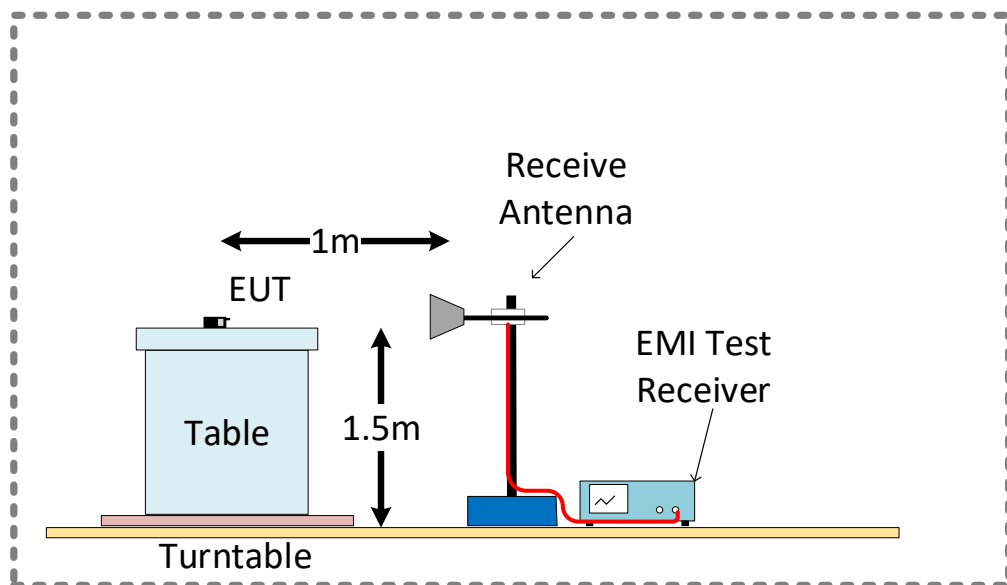

### 3.5 EUT Configuration During Test

#### AC Power Line Conducted Emissions

For AC power line conducted emissions testing, the device was connected to the USB Charger and set to continuous transmit mode on the mid channel with appropriate modulation. A LAN cable was connected between the device and a laptop PC placed outside of the test area. Conducted emissions tests were run on the Mains AC connection to the charger. See test setup photographs for more detail.

#### Radiated Emissions

For radiated emissions testing, the device was connected to the USB Charger and set to continuous transmit mode on an appropriate channel, with appropriate modulation. A LAN cable was connected between the device and a laptop PC placed outside of the test area.

#### Conducted Power Measurements

For conducted power measurements, the RF output of the device was connected to the test equipment via an RF cable. The device was connected to the USB Charger and set to continuous transmit mode on an appropriate channel, with appropriate modulation. A LAN cable was connected between the device and a laptop PC placed outside of the test area.

### 3.6 EUT Operation Modes

Operation mode	Description
Continuous Tx	The device was set to transmit continuously with an appropriate frequency and modulation.

### 3.7 Deviations from the Test Standard

This product is based on pre-certified modules as described in section 2.1, hence a limited test scope has been verified.

Measurement data from certification reports for the modules was used in determining which tests to include or exclude from the scope. A comparison of conducted output power between the module and the device covered by this report is included in section 4.13

### 3.8 Environmental Conditions

#### 3.8.1 Environmental Conditions – Conducted Power Measurements

Date	Time	Temperature (°C)	Relative Humidity (%)
2021.04.22	07:56	20.3	24

#### 3.8.2 Environmental Conditions – Conducted Emissions System

Date	Time	Temperature (°C)	Relative Humidity (%)
2020.12.21	09:00	21.8	36

#### 3.8.3 Environmental Conditions – SAC5 (Radiated Emissions)

Date	Time	Temperature (°C)	Relative Humidity (%)
2020.12.01	07:52	18.3	37
2020.12.03	07:53	18.5	37
2020.12.10	07:38	18.3	39
2021.01.21	07:22	18.4	35

## 4. TEST RESULTS

### 4.1 Test Results – AC Power Line Conducted Emissions (Intentional Transmitter)

#### 4.1.1 AC Power Line Conducted Emissions (Intentional) – Test Summary

<b>Test Specification</b>	FCC 47 CFR 15.207 (Part 15 Subpart C)		
<b>Test Engineer &amp; Date</b>	Fariborz Abasi	2020.12.21	
<b>EUT and Ancillary Equipment IDs</b>	A002959287-010	A002959287-017	A002959287-018 A002959287-020
<b>EUT Operation Mode(s)</b>	Continuous Tx		
<b>EUT Wireless Configuration(s)</b>	Bluetooth Low Energy 1M (see below for details)		
<b>EUT Hardware Configuration(s)</b>	Power from AC Adapter		
<b>Overall Result</b>	PASS		
<b>Test Parameter</b>	<b>Wireless Configuration</b>	<b>Frequency Range</b>	<b>Result*</b>
AC Conducted Power Line Emissions – “N” Line	Bluetooth Low Energy 1M Mid Channel (GFSK 2440 MHz)	150 kHz – 30 MHz	PASS
AC Conducted Power Line Emissions – “L1” Line	Bluetooth Low Energy 1M Mid Channel (GFSK 2440 MHz)	150 kHz – 30 MHz	PASS

\* For detailed measurements, see tables and graphs in sections below



4.1.2 AC Power Line Conducted Emissions (Intentional) – Test Details

<b>Test</b>	Conducted Emission	
<b>Test mode condition</b>	Bluetooth 1M Mid Channel (2440 MHz)	
<b>Standard</b>	47 CFR Part 15.247 Class A	
<b>EUT</b>	A002959287-010	
<b>Ancillary Equipment</b>	A002959287-020 Ethernet cable A002959287-018 USB cable A002959287-017 AC / DC power supply	
<b>Test Engineer</b>	Fariborz Abasi	Date: 2020-12-21

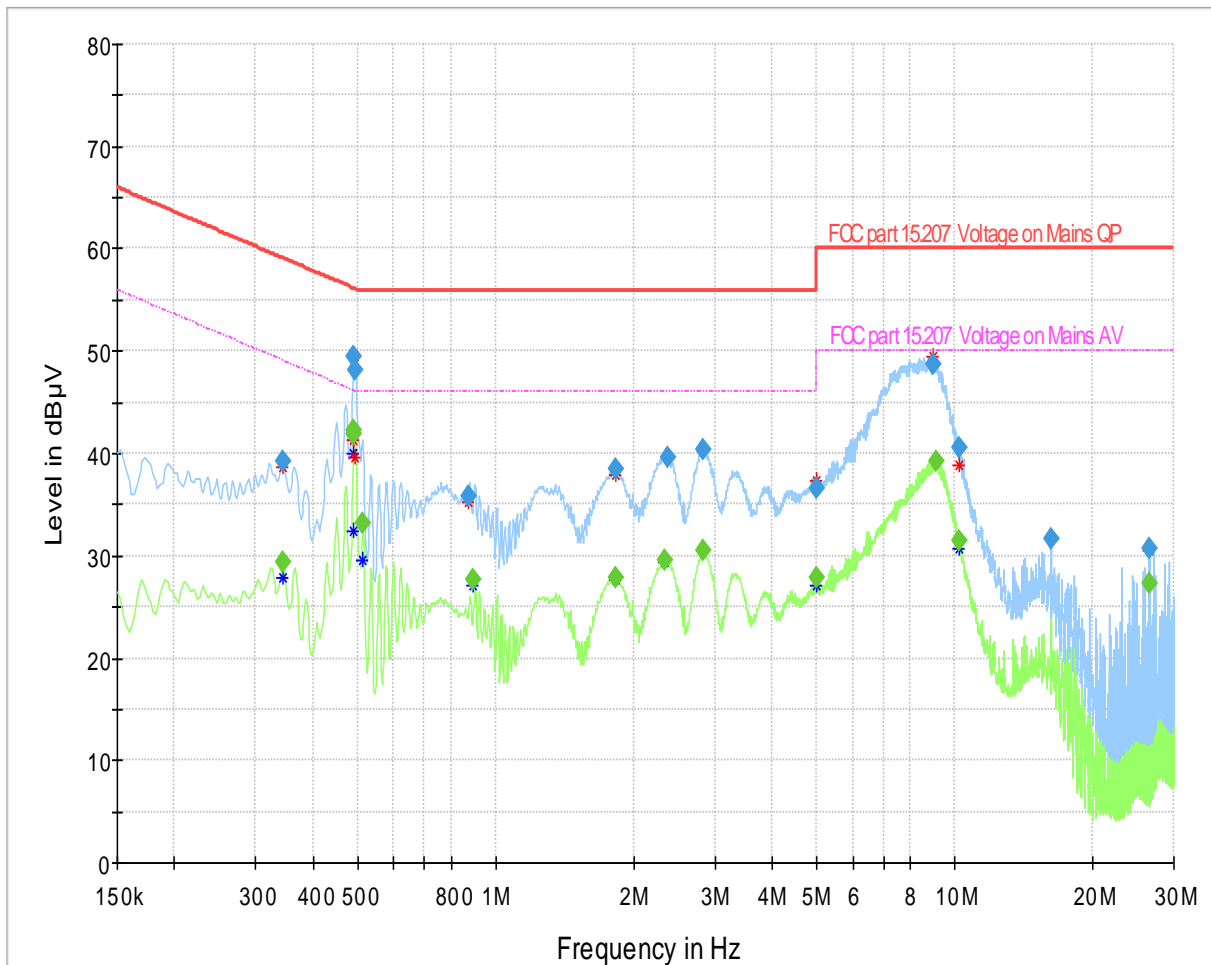

- Preview Result 2-CAV
- Preview Result 1-QPK
- \* Critical\_Freqs CAV
- \* Critical\_Freqs QPK
- FCC part 15.207 Voltage on Mains QP
- FCC part 15.207 Voltage on Mains AV
- ◆ Final\_Result QPK
- ◆ Final\_Result CAV

Frequency (MHz)	QuasiPeak (dBµV)	CAverage (dBµV)	Limit (dBµV)	Margin (dB)	Meas. Time (ms)	Bandwidth (kHz)	Line	Filter	Corr. (dB)
0.343500	---	29.42	49.12	19.70	1000.0	9.000	L1	ON	9.6
0.343500	39.25	---	59.12	19.87	1000.0	9.000	L1	ON	9.6
0.489750	---	41.96	46.17	4.21	1000.0	9.000	L1	ON	9.6
0.492000	---	42.26	46.13	3.87	1000.0	9.000	L1	ON	9.6
0.492000	49.52	---	56.13	6.61	1000.0	9.000	L1	ON	9.6
0.494250	48.16	---	56.10	7.94	1000.0	9.000	L1	ON	9.6
0.514500	---	33.12	46.00	12.88	1000.0	9.000	L1	ON	9.6
0.872250	35.84	---	56.00	20.16	1000.0	9.000	L1	ON	9.6
0.894750	---	27.59	46.00	18.41	1000.0	9.000	L1	ON	9.6
1.826250	38.41	---	56.00	17.59	1000.0	9.000	L1	ON	9.7
1.828500	---	27.93	46.00	18.07	1000.0	9.000	L1	ON	9.7
2.332500	---	29.54	46.00	16.46	1000.0	9.000	L1	ON	9.8
2.370750	39.55	---	56.00	16.45	1000.0	9.000	L1	ON	9.8
2.841000	40.34	---	56.00	15.66	1000.0	9.000	L1	ON	9.8
2.841000	---	30.45	46.00	15.55	1000.0	9.000	L1	ON	9.8
4.998750	36.63	---	56.00	19.37	1000.0	9.000	L1	ON	9.8
4.998750	---	27.86	46.00	18.14	1000.0	9.000	L1	ON	9.8
8.965500	48.80	---	60.00	11.20	1000.0	9.000	N	ON	9.9
9.089250	---	39.20	50.00	10.80	1000.0	9.000	L1	ON	9.9
10.243500	40.63	---	60.00	19.37	1000.0	9.000	L1	ON	9.9
10.243500	---	31.44	50.00	18.56	1000.0	9.000	L1	ON	9.9
16.228500	31.72	---	60.00	28.28	1000.0	9.000	N	ON	10.0
26.610000	---	27.26	50.00	22.74	1000.0	9.000	N	ON	10.1
26.610000	30.64	---	60.00	29.36	1000.0	9.000	N	ON	10.1

## 4.2 Test Results – Radiated Emissions (Intentional Transmitter)

### 4.2.1 Radiated Emissions (Intentional) – Test Summary

<b>Test Specification</b>	FCC 47 CFR 15.209 (Part 15 Subpart C)		
<b>Test Engineer &amp; Date</b>	Niall Forrester Simon Palmhager	2020.12.01 – 2021.01.21	
<b>EUT and Ancillary Equipment IDs</b>	A002959287-010 A002959287-013	A002959287-011 A002959287-012 A002959287-025	
<b>EUT Operation Mode(s)</b>	Continuous Tx		
<b>EUT Wireless Configuration(s)</b>	Bluetooth Low Energy 1M (see below for details)		
<b>EUT Hardware Configuration(s)</b>	Power from AC Adapter		
<b>Overall Result</b>	PASS		
Test Parameter	Wireless Configuration	Frequency Range	Result
Radiated Emissions	Bluetooth Low Energy 1M Low Channel (GFSK 2402 MHz)	1 GHz – 18 GHz	PASS
Radiated Emissions	Bluetooth Low Energy 1M Low Channel (GFSK 2402 MHz)	18 GHz – 40 GHz	PASS
Radiated Emissions	Bluetooth Low Energy 1M Mid Channel (GFSK 2440 MHz)	9 kHz – 30 MHz	PASS
Radiated Emissions	Bluetooth Low Energy 1M Mid Channel (GFSK 2440 MHz)	30 MHz – 1 GHz	PASS
Radiated Emissions	Bluetooth Low Energy 1M Mid Channel (GFSK 2440 MHz)	1 GHz – 18 GHz	PASS
Radiated Emissions	Bluetooth Low Energy 1M Mid Channel (GFSK 2440 MHz)	18 GHz – 40 GHz	PASS
Radiated Emissions	Bluetooth Low Energy 1M High Channel (GFSK 2480 MHz)	1 GHz – 18 GHz	PASS
Radiated Emissions	Bluetooth Low Energy 1M High Channel (GFSK 2480 MHz)	18 GHz – 40 GHz	PASS

4.2.2 Radiated Emissions (Intentional) – Test Details  
Low Channel

<b>Test mode condition</b>	Bluetooth Low Energy 1M, Low channel (2402 MHz)	
<b>Antenna orientation</b>	Horizontal and Vertical	
<b>Sweep frequency</b>	1 GHz – 18 GHz	
<b>Standard</b>	47 CFR FCC Part 15 subpart C	
<b>EUT</b>	A002959287-010	
<b>Ancillary Equipment</b>	A002959287-011, A002959287-012, A002959287-025	
<b>Test Engineer</b>	Niall Forrester	Date: 2020-12-03
<b>Chamber details</b>	Chamber: SAC 5	

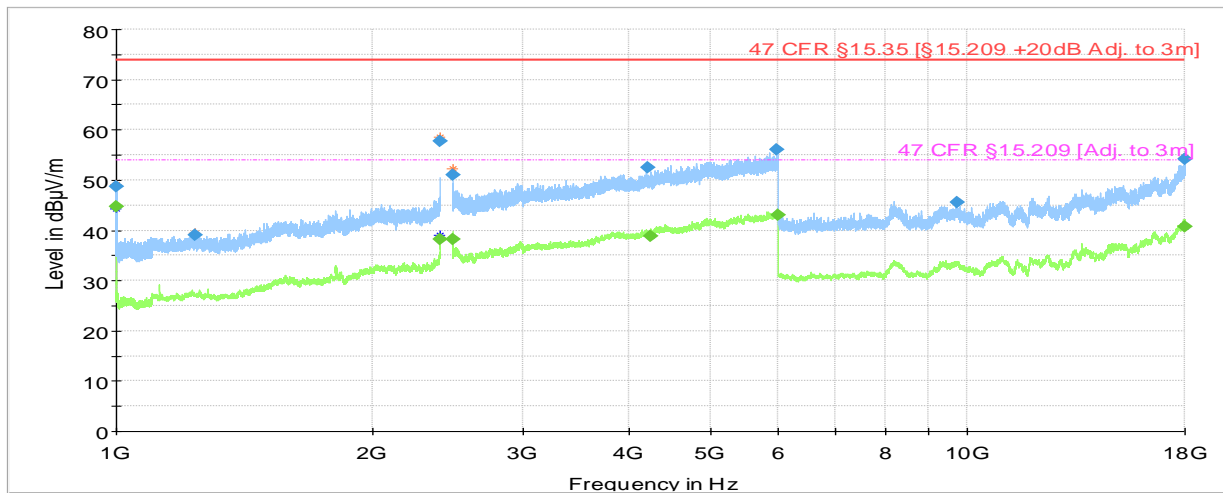







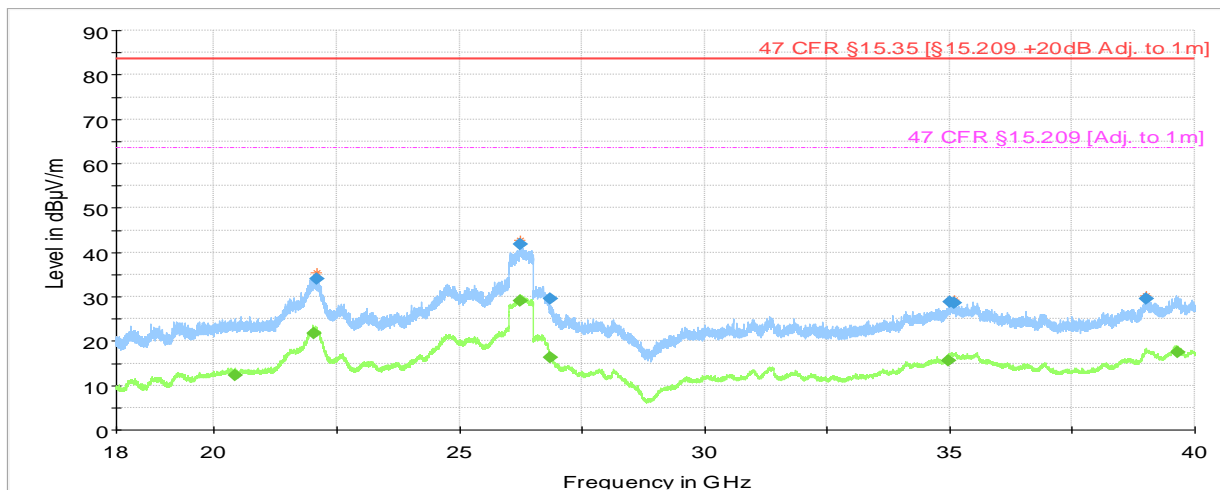

— Preview Result 2-AVG  
— Preview Result 1-PK+  
— \* 47 CFR §15.35 [§15.209 +20dB Adj. to 3m]  
— \* 47 CFR §15.209 [Adj. to 3m]  
◆ Final\_Result PK+  
◆ Final\_Result AVG

Frequency (MHz)	MaxPeak (dBµV/m)	Average (dBµV/m)	Limit (dBµV/m)	Margin (dB)	Meas. Time (ms)	Bandwidth (kHz)	Height (cm)	Pol	Azimuth (deg)
1000.008000	48.63	---	73.98	25.35	1000.0	1000.000	147.0	H	267.0
1000.022770	---	44.83	53.98	9.15	1000.0	1000.000	148.0	H	270.0
1236.506000	38.98	---	73.98	35.00	1000.0	1000.000	175.0	V	87.0
2399.944000	57.67	---	73.98	16.31	1000.0	1000.000	125.0	H	338.0
2399.982500	---	38.24	53.98	15.74	1000.0	1000.000	175.0	H	252.0
2483.591500	50.96	---	73.98	23.02	1000.0	1000.000	210.0	H	20.0
2483.627000	---	38.30	53.98	15.68	1000.0	1000.000	198.0	H	177.0
4203.277000	52.54	---	73.98	21.44	1000.0	1000.000	210.0	V	87.0
4243.275000	---	38.86	53.98	15.12	1000.0	1000.000	175.0	V	248.0
5976.940000	56.05	---	73.98	17.93	1000.0	1000.000	175.0	V	20.0
5985.575000	---	42.95	53.98	11.03	1000.0	1000.000	210.0	V	20.0
9720.455000	45.64	---	73.98	28.34	1000.0	1000.000	210.0	V	112.0
17991.306000	---	40.64	53.98	13.34	1000.0	1000.000	125.0	V	244.0
17999.094240	54.23	---	73.98	19.75	1000.0	1000.000	210.0	V	244.0

<b>Test mode condition</b>	Bluetooth Low Energy 1M, Low channel (2402 MHz)	
<b>Antenna orientation</b>	Horizontal and Vertical	
<b>Sweep frequency</b>	18 GHz – 40 GHz	
<b>Standard</b>	47 CFR FCC Part 15 subpart C	
<b>EUT</b>	A002959287-013	
<b>Ancillary Equipment</b>	A002959287-011, A002959287-012, A002959287-025	
<b>Test Engineer</b>	Simon Palmhager	Date: 2020-12-29
<b>Chamber details</b>	Chamber: SAC 5	



	Preview Result 2-AVG		Preview Result 1-PK+
	Critical_Freqs AVG		Critical_Freqs PK+
	47 CFR §15.35 [§15.209 +20dB Adj. to 1m]		47 CFR §15.209 [Adj. to 1m]
	Final_Result PK+		Final_Result AVG

Frequency (MHz)	MaxPeak (dBµV/m)	Average (dBµV/m)	Limit (dBµV/m)	Margin (dB)	Meas. Time (ms)	Bandwidth (kHz)	Height (cm)	Pol	Azimuth (deg)
20414.976000	---	12.23	63.52	51.29	1000.0	1000.000	155.0	V	218.0
22017.346000	---	21.70	63.52	41.82	1000.0	1000.000	155.0	H	248.0
22079.487000	34.13	---	83.52	49.39	1000.0	1000.000	155.0	V	296.0
26247.332000	---	29.16	63.52	34.36	1000.0	1000.000	155.0	V	292.0
26252.043000	41.90	---	83.52	41.62	1000.0	1000.000	155.0	V	232.0
26839.693000	29.51	---	83.52	54.01	1000.0	1000.000	155.0	V	38.0
26842.376000	---	16.20	63.52	47.32	1000.0	1000.000	155.0	V	82.0
34985.101000	---	15.61	63.52	47.91	1000.0	1000.000	155.0	V	128.0
35011.377000	28.72	---	83.52	54.81	1000.0	1000.000	155.0	H	36.0
35097.212000	28.63	---	83.52	54.89	1000.0	1000.000	155.0	H	252.0
39017.965000	29.59	---	83.52	53.93	1000.0	1000.000	155.0	V	52.0
39641.599000	---	17.48	63.52	46.04	1000.0	1000.000	155.0	V	188.0

Mid Channel

<b>Test mode condition</b>	Bluetooth Low Energy 1M, Mid channel (2440 MHz)	
<b>Antenna orientation</b>	Loop Antenna Parallel to Axis	
<b>Sweep frequency</b>	9 kHz-30 MHz	
<b>Standard</b>	47 CFR FCC Part 15 subpart C	
<b>EUT</b>	A002959287-010	
<b>Ancillary Equipment</b>	A002959287-011, A002959287-012, A002959287-025	
<b>Test Engineer</b>	Niall Forrester	Date: 2021-01-21
<b>Chamber details</b>	Chamber: SAC 5	

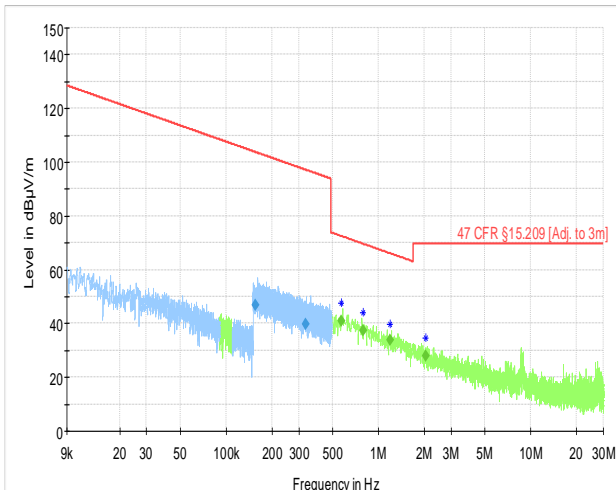

— Preview Result 2-PK+      — Preview Result 1-AVG  
♦ Critical\_Freqs PK+      ♦ Critical\_Freqs AVG  
— 47 CFR §15.209 [Adj. to 3m]      ♦ Final\_Result AVG  
♦ Final\_Result QPK

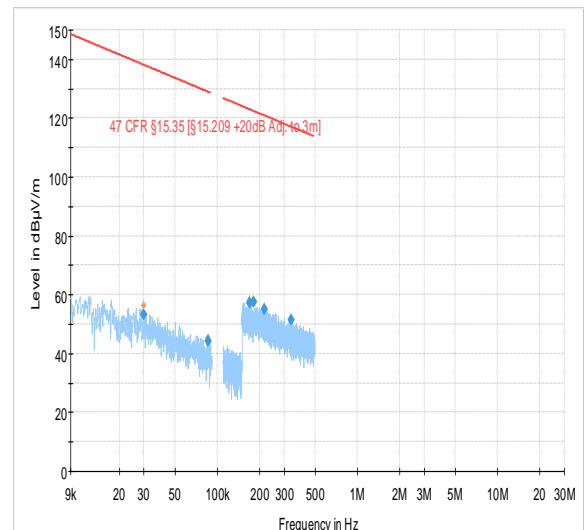

— Preview Result 1-PK+      ♦ Critical\_Freqs PK+  
— 47 CFR §15.35 [§15.209 +20dB Adj. to 3m]      ♦ Final\_Result PK+

Frequency (MHz)	Average (dBµV/m)	QuasiPeak (dBµV/m)	MaxPeak (dBµV/m)	Limit (dBµV/m)	Margin (dB)	Meas. Time (ms)	Bandwidth (kHz)	Height (cm)	Pol	Azimuth (deg)
0.155295	46.71	---	---	103.78	57.08	1000.0	9.000	100.0	H	256.0
0.332998	39.75	---	---	97.16	57.41	1000.0	9.000	100.0	H	191.0
0.569816	---	40.83	---	72.49	31.66	1000.0	9.000	100.0	H	256.0
0.790817	---	37.57	---	69.64	32.07	1000.0	9.000	100.0	H	49.0
1.190430	---	33.68	---	66.09	32.41	1000.0	9.000	100.0	H	166.0
2.051217	---	28.12	---	69.54	41.42	1000.0	9.000	100.0	H	135.0
0.029744	---	---	53.38	138.14	84.76	1000.0	0.200	100.0	H	243.0
0.086263	---	---	44.15	128.89	84.74	1000.0	0.200	100.0	H	243.0
0.170485	---	---	57.15	122.97	65.82	1000.0	9.000	100.0	H	178.0
0.182404	---	---	57.42	122.38	64.97	1000.0	9.000	100.0	H	255.0
0.215765	---	---	55.00	120.93	65.92	1000.0	9.000	100.0	H	315.0
0.337803	---	---	51.34	117.03	65.69	1000.0	9.000	100.0	H	280.0

<b>Test mode condition</b>	Bluetooth Low Energy 1M, Mid channel (2440 MHz)	
<b>Antenna orientation</b>	Loop Antenna Perpendicular to Axis	
<b>Sweep frequency</b>	9 kHz-30 MHz	
<b>Standard</b>	47 CFR FCC Part 15 subpart C	
<b>EUT</b>	A002959287-010	
<b>Ancillary Equipment</b>	A002959287-011, A002959287-012, A002959287-025	
<b>Test Engineer</b>	Niall Forrester	Date: 2021-01-21
<b>Chamber details</b>	Chamber: SAC 5	

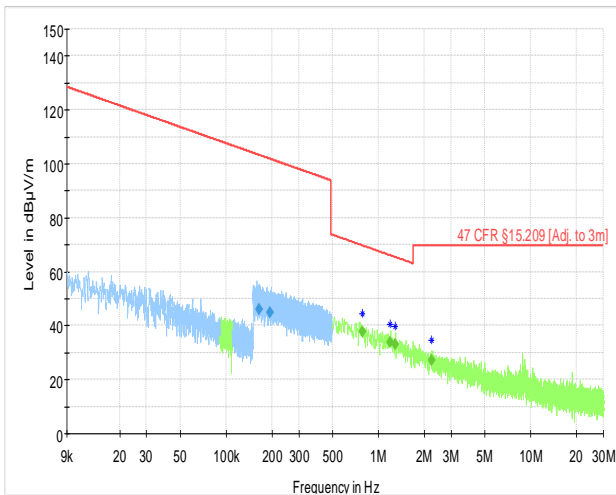

— Preview Result 2-PK+  
— Preview Result 1-AVG  
\* Critical\_Freqs PK+  
— 47 CFR §15.209 [Adj. to 3m]  
♦ Final\_Result QPK  
\* Critical\_Freqs AVG  
♦ Final\_Result AVG

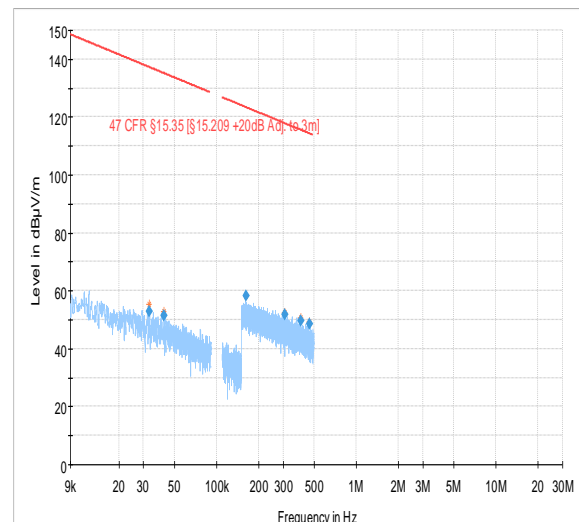

— Preview Result 1-PK+  
— 47 CFR §15.35 [§15.209 +20dB Adj. to 3m]  
\* Critical\_Freqs PK+  
♦ Final\_Result PK+

Frequency (MHz)	Average (dBµV/m)	QuasiPeak (dBµV/m)	MaxPeak (dBµV/m)	Limit (dBµV/m)	Margin (dB)	Meas. Time (ms)	Bandwidth (kHz)	Height (cm)	Pol	Azimuth (deg)
0.164281	46.21	---	---	103.29	57.08	1000.0	9.000	100.0	H	135.0
0.193630	44.80	---	---	101.87	57.07	1000.0	9.000	100.0	H	204.0
0.783219	---	37.83	---	69.73	31.90	1000.0	9.000	100.0	H	309.0
1.189355	---	33.74	---	66.10	32.36	1000.0	9.000	100.0	H	191.0
1.286263	---	32.91	---	65.42	32.51	1000.0	9.000	100.0	H	24.0
2.243739	---	27.13	---	69.54	42.41	1000.0	9.000	100.0	H	45.0
0.033023	---	---	52.71	137.23	84.52	1000.0	0.200	100.0	H	75.0
0.042101	---	---	51.40	135.12	83.72	1000.0	0.200	100.0	H	203.0
0.162057	---	---	58.31	123.41	65.11	1000.0	9.000	100.0	H	34.0
0.308249	---	---	51.93	117.83	65.89	1000.0	9.000	100.0	H	34.0
0.401687	---	---	49.77	115.53	65.76	1000.0	9.000	100.0	H	45.0
0.462723	---	---	48.58	114.30	65.71	1000.0	9.000	100.0	H	315.0

<b>Test mode condition</b>	Bluetooth Low Energy 1M, Mid channel (2440 MHz)	
<b>Antenna orientation</b>	Loop Antenna Parallel to floor	
<b>Sweep frequency</b>	9 kHz-30 MHz	
<b>Standard</b>	47 CFR FCC Part 15 subpart C	
<b>EUT</b>	A002959287-010	
<b>Ancillary Equipment</b>	A002959287-011, A002959287-012, A002959287-025	
<b>Test Engineer</b>	Niall Forrester	Date: 2021-01-21
<b>Chamber details</b>	Chamber: SAC 5	

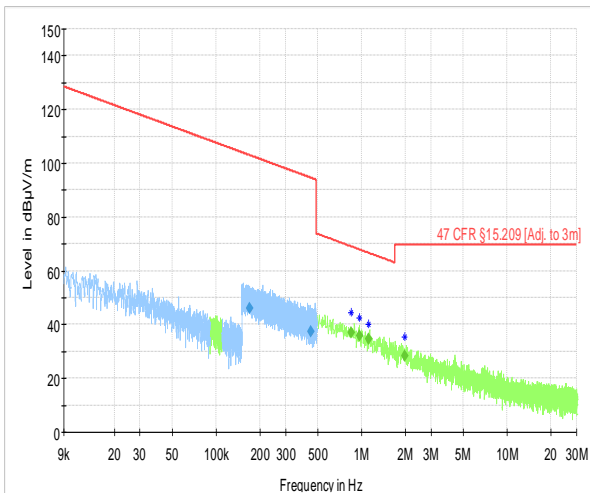

— Preview Result 2-PK+      — Preview Result 1-AVG  
+ Critical\_Freqs PK+      + Critical\_Freqs AVG  
— 47 CFR §15.209 [Adj. to 3m]      ♦ Final\_Result AVG  
♦ Final\_Result QPK

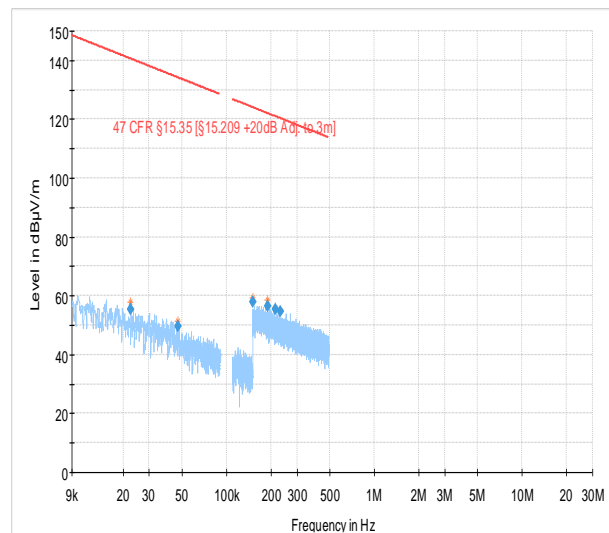

— Preview Result 1-PK+      + Critical\_Freqs PK+  
— 47 CFR §15.35 [§15.209 +20dB Adj. to 3m]      ♦ Final\_Result PK+

Frequency (MHz)	Average (dBµV/m)	QuasiPeak (dBµV/m)	MaxPeak (dBµV/m)	Limit (dBµV/m)	Margin (dB)	Meas. Time (ms)	Bandwidth (kHz)	Height (cm)	Pol	Azimuth (deg)
0.170654	45.87	---	---	102.96	57.09	1000.0	9.000	100.0	H	127.0
0.446324	37.32	---	---	94.61	57.29	1000.0	9.000	100.0	H	135.0
0.849181	---	36.87	---	69.02	32.15	1000.0	9.000	100.0	H	12.0
0.970232	---	35.89	---	67.87	31.98	1000.0	9.000	100.0	H	315.0
1.110556	---	34.50	---	66.69	32.19	1000.0	9.000	100.0	H	45.0
1.981626	---	28.29	---	69.54	41.25	1000.0	9.000	100.0	H	45.0
0.022352	---	---	55.43	140.62	85.19	1000.0	0.200	100.0	H	49.0
0.046946	---	---	49.72	134.17	84.45	1000.0	0.200	100.0	H	45.0
0.150483	---	---	57.93	124.06	66.12	1000.0	9.000	100.0	H	127.0
0.189053	---	---	56.46	122.07	65.61	1000.0	9.000	100.0	H	-41.0
0.214481	---	---	55.35	120.98	65.63	1000.0	9.000	100.0	H	100.0
0.231182	---	---	54.52	120.33	65.81	1000.0	9.000	100.0	H	225.0



<b>Test mode condition</b>	Bluetooth Low Energy 1M, Mid channel (2440 MHz)	
<b>Antenna orientation</b>	Horizontal and Vertical	
<b>Sweep frequency</b>	30 MHz – 1 GHz	
<b>Standard</b>	47 CFR FCC Part 15 subpart C	
<b>EUT</b>	A002959287-010	
<b>Ancillary Equipment</b>	A002959287-011, A002959287-012, A002959287-025	
<b>Test Engineer</b>	Niall Forrester	Date: 2020-12-01
<b>Chamber details</b>	Chamber: SAC 5	

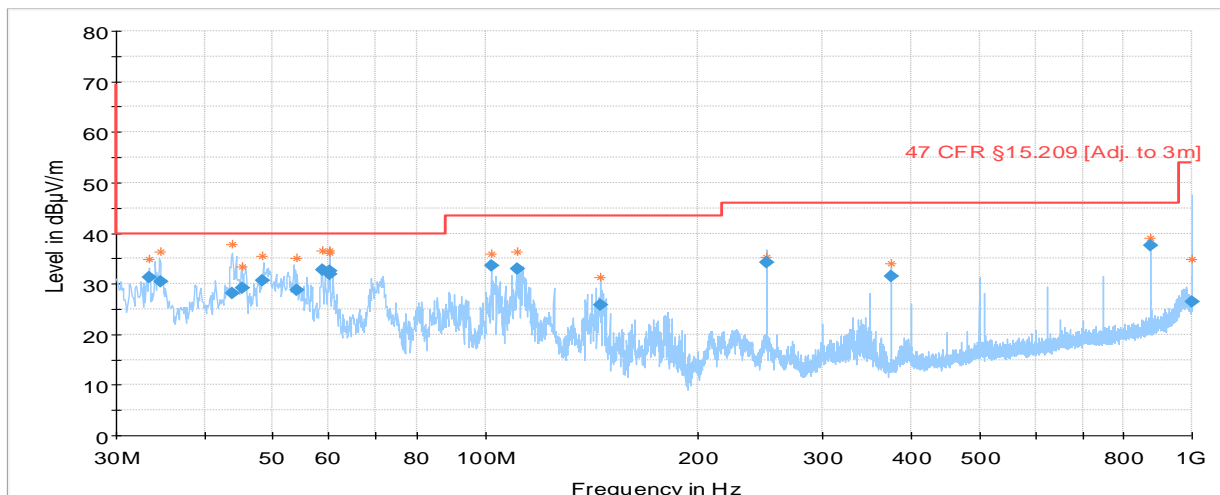

- Preview Result 2-AVG
- \* Critical\_Freqs AVG
- 47 CFR §15.209 [Adj. to 3m]
- ◆ Final\_Result AVG
- Preview Result 1-PK+
- \* Critical\_Freqs PK+
- ◆ Final\_Result QPK

Frequency (MHz)	QuasiPeak (dBµV/m)	Limit (dBµV/m)	Margin (dB)	Meas. Time (ms)	Bandwidth (kHz)	Height (cm)	Pol	Azimuth (deg)
33.430400	31.18	40.00	8.82	1000.0	120.000	100.0	V	292.0
34.644560	30.47	40.00	9.53	1000.0	120.000	133.0	V	158.0
43.788280	28.14	40.00	11.86	1000.0	120.000	125.0	V	296.0
45.247600	29.17	40.00	10.83	1000.0	120.000	175.0	V	322.0
48.405520	30.64	40.00	9.36	1000.0	120.000	100.0	V	199.0
53.922000	28.79	40.00	11.21	1000.0	120.000	225.0	V	176.0
58.743560	32.77	40.00	7.23	1000.0	120.000	175.0	V	338.0
60.212600	32.46	40.00	7.54	1000.0	120.000	275.0	V	-18.0
60.217400	32.02	40.00	7.98	1000.0	120.000	133.0	V	-18.0
101.880360	33.60	43.52	9.92	1000.0	120.000	100.0	V	19.0
110.794760	32.97	43.52	10.55	1000.0	120.000	100.0	V	8.0
145.254600	25.83	43.52	17.69	1000.0	120.000	275.0	H	266.0
250.014120	34.23	46.02	11.79	1000.0	120.000	175.0	V	176.0
375.007000	31.46	46.02	14.56	1000.0	120.000	154.0	V	-18.0
874.998480	37.56	46.02	8.46	1000.0	120.000	225.0	H	131.0
999.406180	26.50	53.98	27.48	1000.0	120.000	100.0	H	296.0

<b>Test mode condition</b>	Bluetooth Low Energy 1M, Mid channel (2440 MHz)	
<b>Antenna orientation</b>	Horizontal and Vertical	
<b>Sweep frequency</b>	1 GHz – 18 GHz	
<b>Standard</b>	47 CFR FCC Part 15 subpart C	
<b>EUT</b>	A002959287-010	
<b>Ancillary Equipment</b>	A002959287-011, A002959287-012, A002959287-025	
<b>Test Engineer</b>	Niall Forrester	Date: 2020-12-01
<b>Chamber details</b>	Chamber: SAC 5	

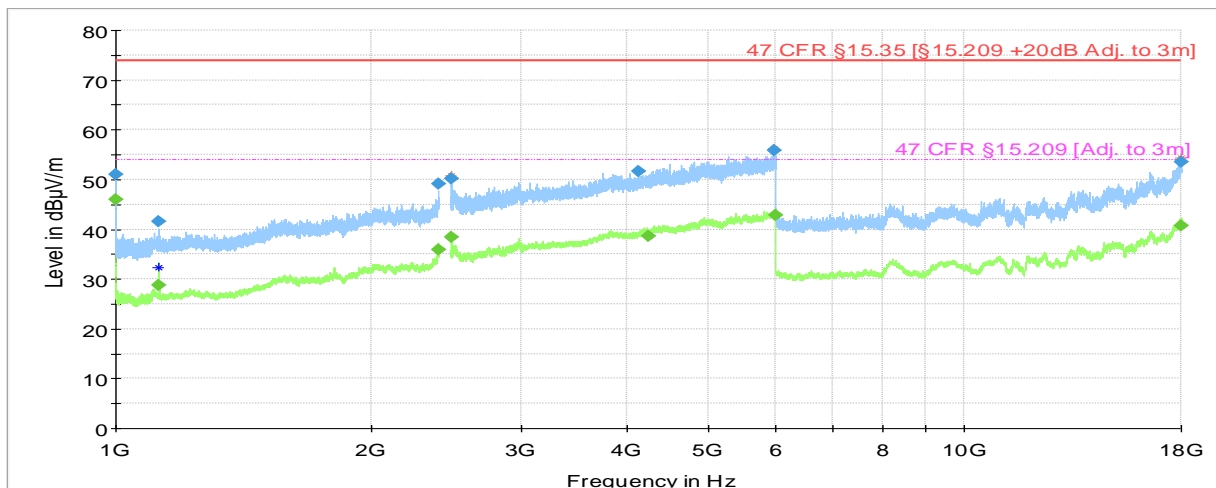

- Preview Result 2-AVG
- Preview Result 1-PK+
- \* Critical\_Freqs AVG
- \* Critical\_Freqs PK+
- 47 CFR §15.35 [§15.209 +20dB Adj. to 3m]
- 47 CFR §15.209 [Adj. to 3m]
- ◆ Final\_Result PK+
- ◆ Final\_Result AVG

Frequency (MHz)	MaxPeak (dBµV/m)	Average (dBµV/m)	Limit (dBµV/m)	Margin (dB)	Meas. Time (ms)	Bandwidth (kHz)	Height (cm)	Pol	Azimuth (deg)
1000.003507	---	46.04	53.98	7.94	1000.0	1000.000	147.0	H	267.0
1000.108575	50.97	---	73.98	23.01	1000.0	1000.000	138.0	H	268.0
1124.759000	41.54	---	73.98	32.44	1000.0	1000.000	170.0	H	112.0
1125.063000	---	28.87	53.98	25.11	1000.0	1000.000	100.0	H	72.0
2399.885000	49.06	---	73.98	24.92	1000.0	1000.000	159.0	H	68.0
2399.890500	---	35.97	53.98	18.01	1000.0	1000.000	170.0	V	41.0
2483.536372	---	38.39	53.98	15.59	1000.0	1000.000	206.0	H	100.0
2483.833914	50.26	---	73.98	23.72	1000.0	1000.000	199.0	H	42.0
4123.144000	51.61	---	73.98	22.37	1000.0	1000.000	206.0	V	234.0
4236.742000	---	38.67	53.98	15.31	1000.0	1000.000	120.0	V	-22.0
5977.009000	55.83	---	73.98	18.15	1000.0	1000.000	210.0	V	41.0
5981.716000	---	42.86	53.98	11.12	1000.0	1000.000	175.0	H	202.0
17994.132740	53.49	---	73.98	20.49	1000.0	1000.000	119.0	H	22.0
17999.083000	---	40.71	53.98	13.27	1000.0	1000.000	100.0	V	116.0

<b>Test mode condition</b>	Bluetooth Low Energy 1M, Mid channel (2440 MHz)	
<b>Antenna orientation</b>	Horizontal and Vertical	
<b>Sweep frequency</b>	18 GHz – 40 GHz	
<b>Standard</b>	47 CFR FCC Part 15 subpart C	
<b>EUT</b>	A002959287-013	
<b>Ancillary Equipment</b>	A002959287-011, A002959287-012, A002959287-025	
<b>Test Engineer</b>	Simon Palmhager	Date: 2020-12-29
<b>Chamber details</b>	Chamber: SAC 5	

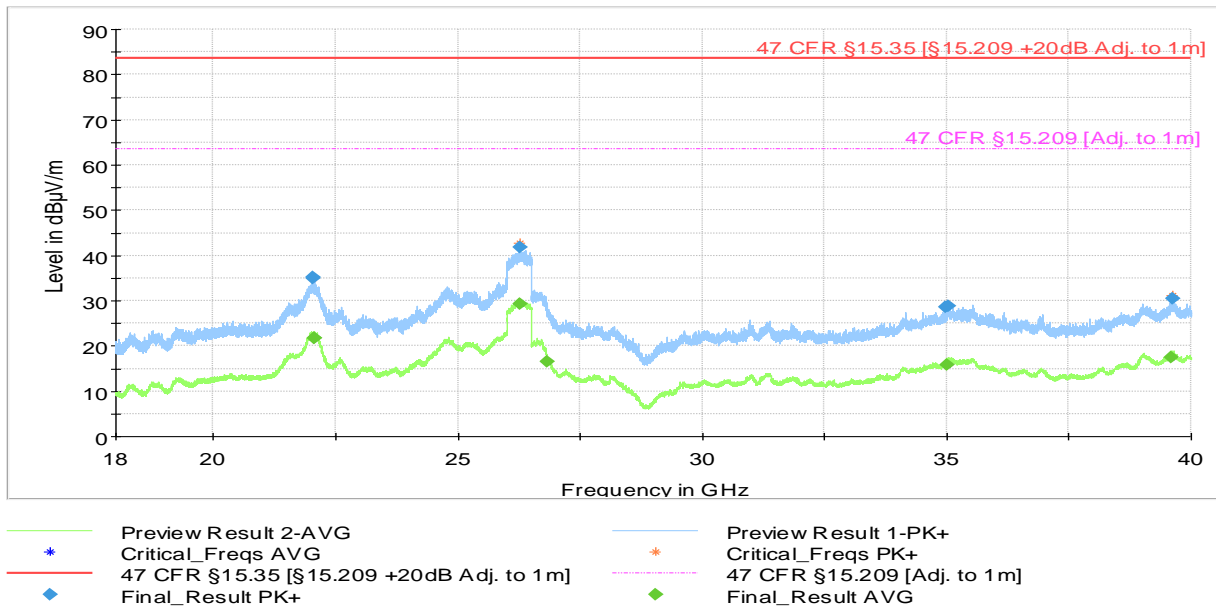

Frequency (MHz)	MaxPeak (dBµV/m)	Average (dBµV/m)	Limit (dBµV/m)	Margin (dB)	Meas. Time (ms)	Bandwidth (kHz)	Height (cm)	Pol	Azimuth (deg)
22037.988000	35.01	---	83.52	48.51	1000.0	1000.000	155.0	V	8.0
22044.188000	35.18	---	83.52	48.34	1000.0	1000.000	155.0	V	-8.0
22051.584000	---	21.67	63.52	41.86	1000.0	1000.000	155.0	V	26.0
22053.584000	---	21.67	63.52	41.85	1000.0	1000.000	155.0	V	22.0
26255.944000	---	29.19	63.52	34.33	1000.0	1000.000	155.0	V	126.0
26257.911000	41.78	---	83.52	41.74	1000.0	1000.000	155.0	H	38.0
26830.145000	---	16.52	63.52	47.00	1000.0	1000.000	155.0	V	312.0
34975.435000	28.62	---	83.52	54.91	1000.0	1000.000	155.0	H	186.0
35002.479000	---	15.88	63.52	47.65	1000.0	1000.000	155.0	V	112.0
35042.252000	28.93	---	83.52	54.59	1000.0	1000.000	155.0	H	12.0
39592.343000	---	17.50	63.52	46.03	1000.0	1000.000	155.0	V	202.0
39632.548000	30.44	---	83.52	53.09	1000.0	1000.000	155.0	H	322.0

High Channel

Test mode condition	Bluetooth Low Energy 1M, High channel (2480 MHz)	
Antenna orientation	Horizontal and Vertical	
Sweep frequency	1 GHz – 18 GHz	
Standard	47 CFR FCC Part 15 subpart C	
EUT	A002959287-010	
Ancillary Equipment	A002959287-011, A002959287-012, A002959287-025	
Test Engineer	Niall Forrester	Date: 2020-12-03
Chamber details	Chamber: SAC 5	

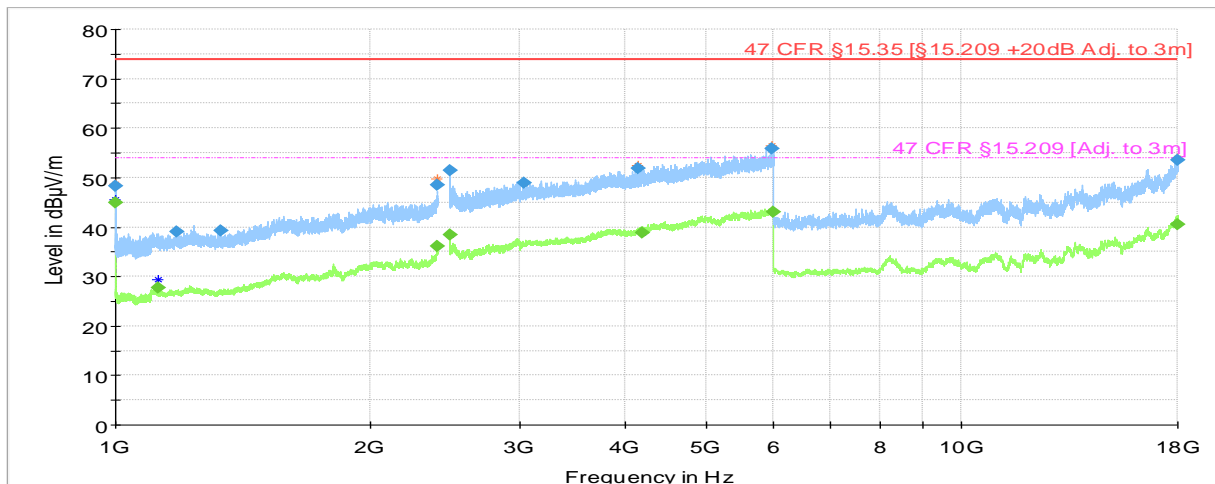

- Preview Result 2-AVG
- Preview Result 1-PK+
- \* Critical\_Freqs AVG
- \* Critical\_Freqs PK+
- 47 CFR §15.35 [§15.209 +20dB Adj. to 3m]
- 47 CFR §15.209 [Adj. to 3m]
- ◆ Final\_Result PK+
- ◆ Final\_Result AVG

Frequency (MHz)	MaxPeak (dBµV/m)	Average (dBµV/m)	Limit (dBµV/m)	Margin (dB)	Meas. Time (ms)	Bandwidth (kHz)	Height (cm)	Pol	Azimuth (deg)
1000.028056	---	44.99	53.98	8.99	1000.0	1000.000	137.0	H	267.0
1000.201388	48.34	---	73.98	25.64	1000.0	1000.000	148.0	H	267.0
1125.026000	---	27.76	53.98	26.22	1000.0	1000.000	100.0	H	72.0
1182.804000	38.97	---	73.98	35.01	1000.0	1000.000	159.0	V	87.0
1333.209000	39.21	---	73.98	34.77	1000.0	1000.000	188.0	H	110.0
2399.813781	48.58	---	73.98	25.40	1000.0	1000.000	100.0	V	68.0
2399.926000	---	36.18	53.98	17.80	1000.0	1000.000	125.0	V	-3.0
2483.595476	---	38.46	53.98	15.52	1000.0	1000.000	175.0	H	177.0
2483.650386	51.47	---	73.98	22.50	1000.0	1000.000	175.0	V	234.0
3040.362000	48.89	---	73.98	25.09	1000.0	1000.000	169.0	H	131.0
4143.531000	51.76	---	73.98	22.22	1000.0	1000.000	198.0	H	116.0
4187.078000	---	38.85	53.98	15.13	1000.0	1000.000	125.0	H	155.0
5976.031000	55.94	---	73.98	18.04	1000.0	1000.000	127.0	H	158.0
5979.156000	---	43.01	53.98	10.97	1000.0	1000.000	100.0	H	248.0
17977.754000	---	40.58	53.98	13.40	1000.0	1000.000	206.0	H	252.0
17994.408560	53.48	---	73.98	20.50	1000.0	1000.000	206.0	V	244.0

<b>Test mode condition</b>	Bluetooth Low Energy 1M, High channel (2480 MHz)	
<b>Antenna orientation</b>	Horizontal and Vertical	
<b>Sweep frequency</b>	18 GHz – 40 GHz	
<b>Standard</b>	47 CFR FCC Part 15 subpart C	
<b>EUT</b>	A002959287-013	
<b>Ancillary Equipment</b>	A002959287-011, A002959287-012, A002959287-025	
<b>Test Engineer</b>	Simon Palmhager	Date: 2020-12-30
<b>Chamber details</b>	Chamber: SAC 5	

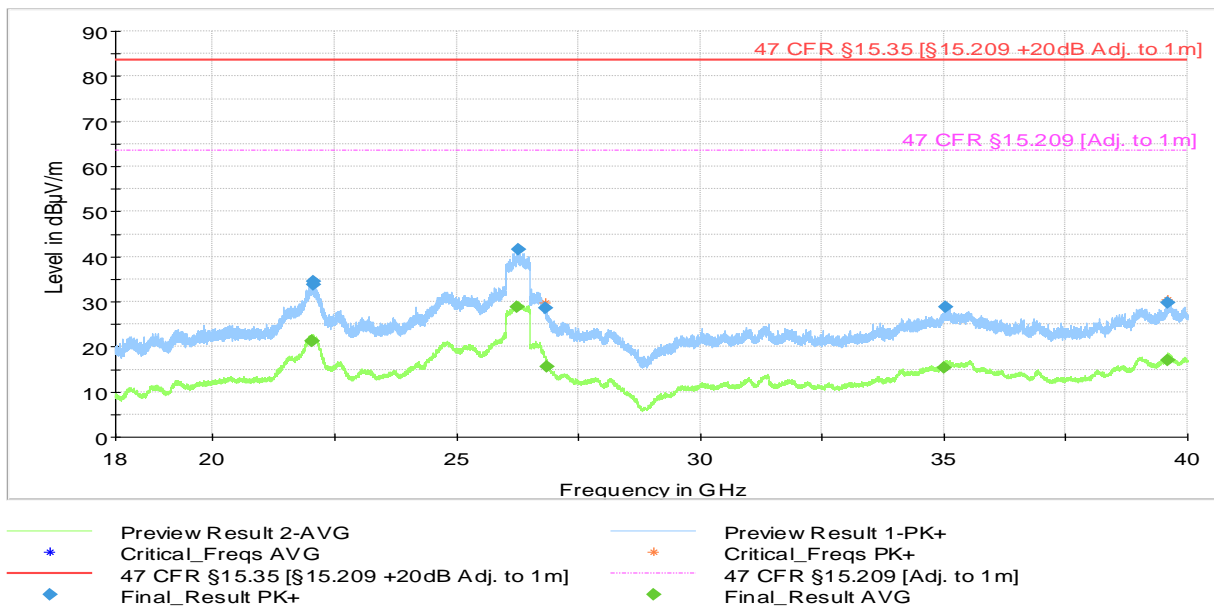

Frequency (MHz)	MaxPeak (dBµV/m)	Average (dBµV/m)	Limit (dBµV/m)	Margin (dB)	Meas. Time (ms)	Bandwidth (kHz)	Height (cm)	Pol	Azimuth (deg)
22039.395000	---	21.35	63.52	42.17	1000.0	1000.000	155.0	H	232.0
22040.178000	---	21.36	63.52	42.16	1000.0	1000.000	155.0	H	232.0
22059.610000	33.70	---	83.52	49.82	1000.0	1000.000	155.0	V	252.0
22061.695000	34.39	---	83.52	49.13	1000.0	1000.000	155.0	V	248.0
26247.686000	---	28.80	63.52	34.73	1000.0	1000.000	155.0	V	158.0
26261.077000	41.49	---	83.52	42.03	1000.0	1000.000	155.0	V	172.0
26836.969000	28.56	---	83.52	54.96	1000.0	1000.000	155.0	V	142.0
26848.495000	---	15.62	63.52	47.90	1000.0	1000.000	155.0	V	252.0
34998.670000	---	15.46	63.52	48.06	1000.0	1000.000	155.0	V	296.0
35030.400000	28.90	---	83.52	54.63	1000.0	1000.000	155.0	V	312.0
39588.826000	29.70	---	83.52	53.83	1000.0	1000.000	155.0	H	338.0
39594.916000	---	17.10	63.52	46.42	1000.0	1000.000	155.0	V	352.0

### 4.3 Test Results – Antenna Conducted Emissions

#### 4.3.1 Antenna Conducted Emissions – Test Summary

Emissions measurements have been performed as radiated test (see section 4.2)

### 4.4 Test Results – Band Edge Compliance (Authorized Band)

#### 4.4.1 Band Edge Compliance (Authorized Band) – Test Summary

This test has not been performed. The device is based on certified modules as described in section 2.1

### 4.5 Test Results – Band Edge Compliance (Restricted Band)

#### 4.5.1 Band Edge Compliance (Restricted Band) – Test Summary

<b>Test Specification</b>	47 CFR 15.209 & 15.247 (d)	
<b>Test Engineer &amp; Date</b>	Niall Forrester Simon Palmhager	2020.12.10
<b>EUT and Ancillary Equipment IDs</b>	A002959287-010 A002959287-013	A002959287-011 A002959287-012 A002959287-025
<b>EUT Operation Mode(s)</b>	Continuous Tx	
<b>EUT Wireless Configuration(s)</b>	Bluetooth Low Energy 1M (see below for details)	
<b>EUT Hardware Configuration(s)</b>	Power from AC Adapter	
<b>Overall Result</b>	PASS	
<b>Test Parameter</b>	<b>Wireless Configuration</b>	<b>Result*</b>
Emissions at Band Edge (Rest. Band – Low Edge)	Bluetooth Low Energy 1M Low Channel (GFSK 2402 MHz)	PASS
Emissions at Band Edge (Rest. Band – High Edge)	Bluetooth Low Energy 1M High Channel (GFSK 2480 MHz)	PASS

\* For detailed measurements, see tables and graphs in sections below

4.5.2 Band Edge Compliance (Restricted Band) – Test Details  
Restricted Band – Low Edge

<b>Test mode condition</b>	Bluetooth Low Energy 1M, Low channel (2402 MHz)	
<b>Antenna orientation</b>	Horizontal and Vertical	
<b>Sweep frequency</b>	1 GHz – 18 GHz Lower Band Edge	
<b>Standard</b>	47 CFR FCC Part 15 subpart C	
<b>EUT</b>	A002959287-010	
<b>Ancillary Equipment</b>	A002959287-011, A002959287-012, A002959287-025	
<b>Test Engineer</b>	Niall Forrester	Date: 2020-12-10
<b>Chamber details</b>	Chamber: SAC 5	

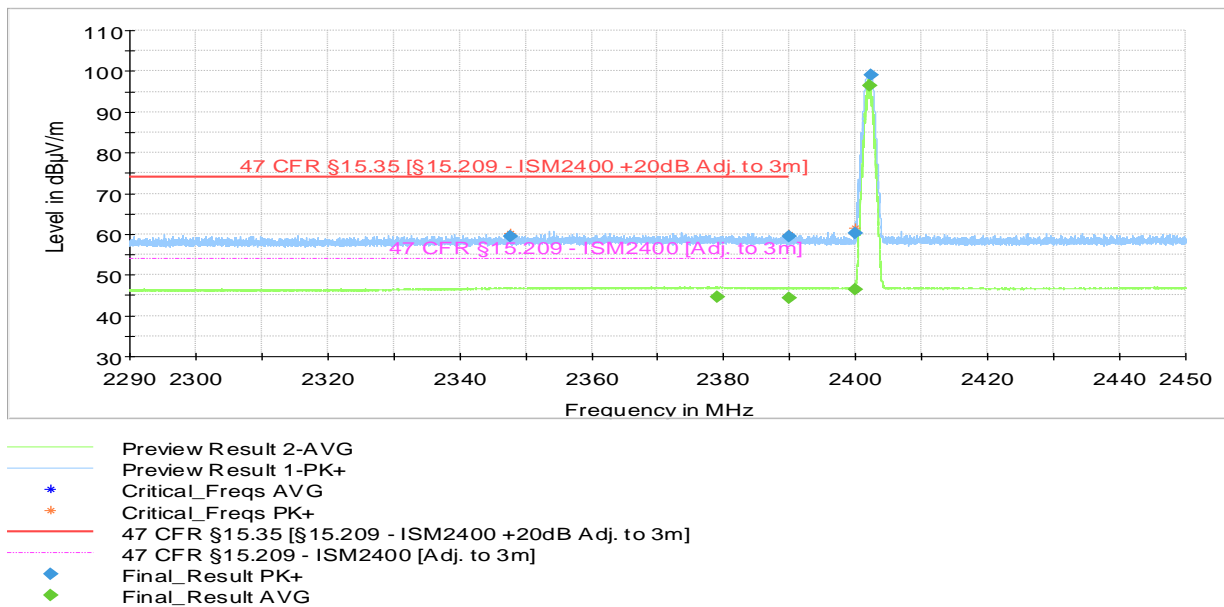

Frequency (MHz)	MaxPeak (dBµV/m)	Average (dBµV/m)	Limit (dBµV/m)	Margin (dB)	Meas. Time (ms)	Bandwidth (kHz)	Height (cm)	Pol	Azimuth (deg)
2347.776000	59.46	---	73.98	14.52	1000.0	1000.000	111.0	V	300.0
2378.960000	---	44.52	53.98	9.46	1000.0	1000.000	193.0	H	208.0
2390.000000	---	44.38	53.98	9.60	1000.0	1000.000	210.0	H	106.0
2390.000000	59.52	---	73.98	14.46	1000.0	1000.000	210.0	V	117.0
2400.000000	60.32	---	---	---	1000.0	1000.000	204.0	V	302.0
2400.000000	---	46.42	---	---	1000.0	1000.000	100.0	H	330.0
2402.032000	---	96.52	---	---	1000.0	1000.000	100.0	H	315.0
2402.240000	99.03	---	---	---	1000.0	1000.000	100.0	H	315.0

**Restricted Band – High Edge**

<b>Test mode condition</b>	Bluetooth Low Energy 1M, High channel (2480 MHz)	
<b>Antenna orientation</b>	Horizontal and Vertical	
<b>Sweep frequency</b>	1 GHz – 18 GHz Upper Band Edge	
<b>Standard</b>	47 CFR FCC Part 15 subpart C	
<b>EUT</b>	A002959287-010	
<b>Ancillary Equipment</b>	A002959287-011, A002959287-012, A002959287-025	
<b>Test Engineer</b>	Simon Palmhager	Date: 2020-12-10
<b>Chamber details</b>	Chamber: SAC 5	

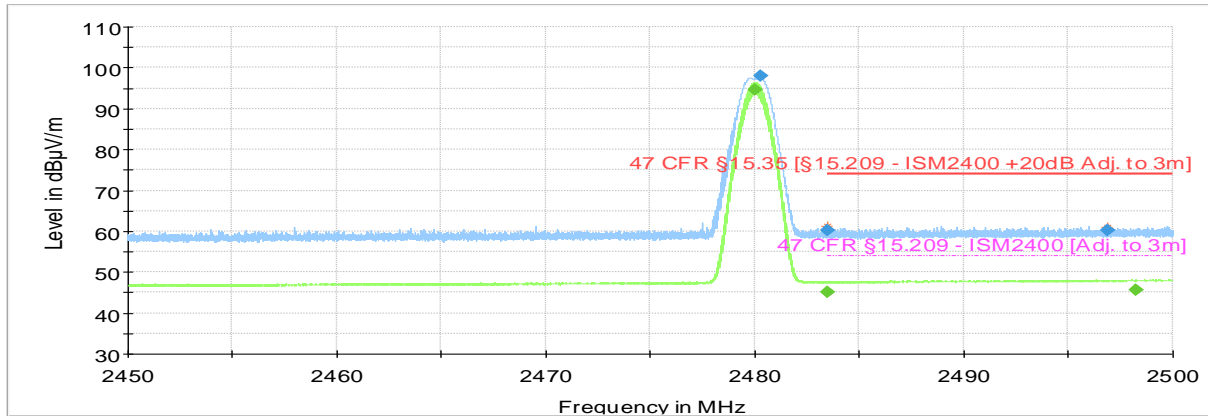

- Preview Result 2-AVG
- Preview Result 1-PK+
- \* Critical\_Freqs AVG
- \* Critical\_Freqs PK+
- 47 CFR §15.35 [§15.209 - ISM2400 +20dB Adj. to 3m]
- 47 CFR §15.209 - ISM2400 [Adj. to 3m]
- ◆ Final\_Result PK+
- ◆ Final\_Result AVG

Frequency (MHz)	MaxPeak (dBµV/m)	Average (dBµV/m)	Limit (dBµV/m)	Margin (dB)	Meas. Time (ms)	Bandwidth (kHz)	Height (cm)	Pol	Azimuth (deg)
2480.005000	---	94.63	---	---	1000.0	1000.000	100.0	H	313.0
2480.255000	98.06	---	---	---	1000.0	1000.000	100.0	H	319.0
2483.500000	---	45.24	53.98	8.74	1000.0	1000.000	100.0	H	307.0
2483.500000	60.27	---	73.98	13.71	1000.0	1000.000	180.0	H	265.0
2496.885000	60.18	---	73.98	13.80	1000.0	1000.000	100.0	V	338.0
2498.250000	---	45.66	53.98	8.32	1000.0	1000.000	122.0	H	351.0



## **4.6 Test Results – 20dB Bandwidth**

### **4.6.1 20dB Bandwidth – Test Summary**

This requirement is not applicable as the radio technology is non-hopping

## **4.7 Test Results – Carrier (Hopping Channel) Separation**

### **4.7.1 Carrier (Hopping Channel) Separation – Test Summary**

This requirement is not applicable as the radio technology is non-hopping

## **4.8 Test Results – Number of Hopping Channels**

### **4.8.1 Number of Hopping Channels – Test Summary**

This requirement is not applicable as the radio technology is non-hopping

## **4.9 Test Results – Time of Occupancy (Dwell Time)**

### **4.9.1 Time of Occupancy (Dwell Time) – Test Summary**

This requirement is not applicable as the radio technology is non-hopping

## **4.10 Test Results – 6dB Bandwidth**

### **4.10.1 6dB Bandwidth – Test Summary**

This test has not been performed. The device is based on certified modules as described in section 2.1

## **4.11 Test Results – Peak Conducted Output Power**

### **4.11.1 Peak Conducted Output Power – Test Summary**

This test has not been performed. The device is based on certified modules as described in section 2.1

## **4.12 Test Results – Power Spectral Density**

### **4.12.1 Power Spectral Density – Test Summary**

This test has not been performed. The device is based on certified modules as described in section 2.1

## 4.13 Test Results – Conducted Power Comparison

### 4.13.1 Conducted Power Comparison – Test Summary

<b>Test Specification</b>	ANSI C63.10 clause 11.9.1.1		
<b>Test Engineer &amp; Date</b>	Niall Forrester	2021.04.22	
<b>EUT and Ancillary Equipment IDs</b>	A002959287-036	A002959287-011	A002959287-012 A002959287-025
<b>EUT Operation Mode(s)</b>	Continuous Tx		
<b>EUT Wireless Configuration(s)</b>	Bluetooth Low Energy 1M (see below for details)		
<b>EUT Hardware Configuration(s)</b>	Power from USB Power Supply		
<b>Overall Result</b>	Measured power does not exceed the maximum measured power from the module by more than the measurement uncertainty listed in section 6.1		
<b>Test Parameter</b>	<b>Wireless Configuration</b>	<b>Measured Level (dBm)</b>	<b>Reference Level (dBm) See Note 1</b>
Peak Output Power	Bluetooth Low Energy 1M Low Channel (GFSK 2402 MHz)	5.29	5.11
Peak Output Power	Bluetooth Low Energy 1M Mid Channel (GFSK 2440 MHz)	5.39	
Peak Output Power	Bluetooth Low Energy 1M High Channel (GFSK 2480 MHz)	4.97	

**Note 1: The reference level is the maximum measured power of a given configuration for the pre-certified module. This data is taken from MRT Laboratory report number 1802WSU008-U3.**

## 5. TEST EQUIPMENT STATUS

### 5.1 List of Hardware with Calibration Dates

#### 5.1.1 Hardware List – Conducted Power Measurements

Type	Manufacturer	Model	Serial Number / ID	Calibration Date	Calibration Due
Spectrum Analyzer	Rohde & Schwarz	FSU26	100308 2704108	14.07.2020	14.07.2021

#### 5.1.2 Hardware List – Conducted Emissions System

Type	Manufacturer	Model	Serial Number / ID	Calibration Date	Calibration Due
Two-Line V-network	Rohde & Schwarz	ENV216	101090 2704076	2020.07.16	2021.07.16
Test Receiver 9KHz to 3.5 GHz	Rohde & Schwarz	ESR3	101674 2704016	2020.07.17	2021.07.17

#### 5.1.3 Hardware List – SAC5 System

Type	Manufacturer	Model	Serial Number / ID	Calibration Date	Calibration Due
EMI Test Receiver	Rohde & Schwarz	ESW44	101760 2881044	2020.07.17	2021.07.17
Ultra Broadband Antenna	Rohde & Schwarz	HL562E	100988 2823181	2019.07.23	2021.07.23
Double Ridged Waveguide Horn Antenna	Rohde & Schwarz	HF907	102678 2823164	2019.07.15	2021.07.15
Control Device	Maturo	NCD	NCD/393/2372.01	N/A	N/A
Open Switch & Control Unit	Rohde & Schwarz	OSP150	100081 2884198	2020.08.04	2021.08.04
Open Switch & Control Unit	Rohde & Schwarz	OSP120	100084 2761253	2020.08.04	2021.08.04
Shielded Filter Unit	Rohde & Schwarz	OSP-F Extension 1	101333 2761265	2020.08.04	2021.08.04
Shielded Filter Unit	Rohde & Schwarz	OSP-F Extension 2	101335 2761266	2020.08.04	2021.08.04
Shielded Filter Unit	Rohde & Schwarz	OSP-F Base Unit	101330 2761262	2020.08.04	2021.08.04
Humidity Temperature Probe	Lufft	OPUS 20	1236.0118.0802.033 2771042	2020.07.31	2022.07.31

## 5.2 Software / Firmware Versions

Equipment	Software / Firmware Name	Version
Conducted Emissions System	EMC 32	V10.60.10
SAC 5	EMC 32	V10.60.10

## 6. MEASUREMENT UNCERTAINTY

### 6.1 Measurement Uncertainty for Conducted Power Measurements

Parameter	Uncertainty (Coverage Factor k=2)
Conducted power	0.51 dB

### 6.2 Measurement Uncertainty for Conducted Emissions

Parameter	Uncertainty (Coverage Factor k=2)
Conducted emissions with LISN 150KHz to 30 MHz	2.98 dB

### 6.3 Measurement Uncertainty for SAC 5 (Radiated Emissions & Band Edge)

Parameter	Uncertainty (Coverage Factor k=2)
Field Strength 10 Hz -9 kHz	3.38 dB
Field Strength 9 kHz -30 MHz	3.38 dB
Field Strength 30 MHz -1000 MHz	3.38 dB
Field Strength 1 GHz -18 GHz	4.88 dB
Field Strength 18 GHz - 40 GHz	5.14 dB

## 7. PHOTOGRAPHS

For photographs, see Appendix 1