



Report Number: 13603575-E2V3
Issue Date: 2021/07/23
Product Name: WIRELESS DEVICE
Model Number: E1915
FCC ID: FHO-E1915

Electromagnetic Compatibility Test Report

For

**IKEA OF SWEDEN AB
BOX 702
SE-343 81, ÄLMHULT, SWEDEN**



Copyright © 2021 UL LLC

UL Verification Services Inc. authorizes the above-named company to reproduce this Report provided it is reproduced in its entirety.

Test Report Details

Tests Performed By: UL VERIFICATION SERVICES INC.
47173 BENICIA STREET
FREMONT, CA 94538, U.S.A.

Tests Performed For: IKEA OF SWEDEN AB
BOX 702
SE-343 81, ÄLMHULT, SWEDEN

Issue Date: 2021/07/23

Product Name: WIRELESS DEVICE

Model Number Tested: E1915

Sample Serial Number: **NA 2105K 542A1B51DB466**

Applicable Standards: FCC 47 CFR PART 15 SUBPART B
ICES-003 ISSUE 7:2020

Date Test Item Received: **2021/06/29**

Testing Start Date: **2021/06/30**

Date Testing Complete: **2021/07/01**

Overall Results: Compliant

UL Verification Services Inc. tested the above equipment in accordance with the requirements set forth in the above standards. The test results show that the equipment tested is capable of demonstrating compliance with the requirements as documented in this report.

The results documented in this report apply only to the tested sample, under the conditions and modes of operation as described herein. It is the manufacturer's responsibility to assure that additional production units of this model are manufactured with identical electrical and mechanical components. All samples tested were in good operating condition throughout the entire test program. Measurement Uncertainties are published for informational purposes only and were not taken into account unless noted otherwise.

This document may not be altered or revised in any way unless done so by UL Verification Services Inc. and all revisions are duly noted in the revisions section. Any alteration of this document not carried out by UL Verification Services Inc. will constitute fraud and shall nullify the document. This report must not be used by the client to claim product certification, approval, or endorsement by A2LA, NIST, any agency of the Federal Government, or any agency of the U.S. government.

*This report contains data that are not covered by the A2LA accreditation. The scope of accreditation is limited to the specific tests that are listed on the A2LA websites referenced at the end of this report.

Report Directory

1.0	SUMMARY	5
1.1	Deviations from standard test methods	5
1.2	Device Modifications Necessary for Compliance	5
1.3	Applicable Standards	5
1.4	Summary of Tests	6
2.0	DECISION RULES AND MEASUREMENT UNCERTAINTY	7
2.1	Metrological Traceability	7
2.2	Decision Rules	7
2.3	Measurement Uncertainty	7
2.4	Sample Calculation	7
3.0	GENERAL - Product Description	8
3.1	Equipment Description	8
3.2	Equipment Marking Plate	8
3.3	Device Configuration During Test	9
3.3.1	Equipment Used During Test:.....	9
3.3.2	Input/Output Ports:.....	9
3.3.3	EUT Internal Operating Frequencies:	9
3.3.4	Power Interface:.....	10
3.3.5	Software and Firmware.....	10
3.4	Block Diagram:	10
3.5	EUT Configurations	11
3.6	EUT Operation Modes	11
3.7	Rationale for EUT Configurations	11
3.8	Rationale for EUT Mode of Operation.....	11
4.0	APPLICABLE EMISSIONS LIMITS AND TEST RESULTS	12
4.1	Test Conditions and Results - MAINS TERMINAL - CONDUCTED EMISSIONS.....	12
4.2	Test Conditions and Results - RADIATED EMISSIONS.....	15
5.0	SETUP PHOTOS	25
Appendix A		28
Facilities, Accreditations and Authorizations.....		28

Report Revision History

Revision Date	Revision Version	Description	Revised By	Revision Reviewed By
2021/07/08	V1	Initial Issue	--	Dan Corona
2021/07/21	V2	Updated Section page 18 to address TCB's question	Tina Chu	Dan Corona
2021/07/23	V3	Corrected header report number and Added statement on Section 4.2 Supplementary information	Tina Chu	Dan Corona

1.0 SUMMARY

All tests were performed in accordance with ANSI C63.4:2014, ICES-003 ISSUE 7: 2020

1.1 Deviations from standard test methods

None

1.2 Device Modifications Necessary for Compliance

None

1.3 Applicable Standards

Standard
FCC 47 CFR PART 15 SUBPART B
ICES-003 ISSUE 7: 2020

1.4 Summary of Tests

This product is considered Class B

Requirement – Test	Result (Compliant / Non-Compliant)
CONDUCTED EMISSIONS	Complies
RADIATED EMISSIONS	Complies

Approved & Released For

UL Verification Services Inc. By:



Dan Coronio
 Operations Leader
 Consumer Technology Division
 UL Verification Services Inc.

Prepared By:



Adrian Fong
 Test Engineer
 Consumer Technology Division
 UL Verification Services Inc.

Reviewed By:

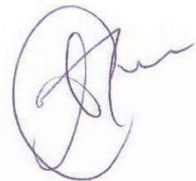

Tina Chu
 Senior Project Engineer
 Consumer Technology Division
 UL Verification Services Inc.

2.0 DECISION RULES AND MEASUREMENT UNCERTAINTY

2.1 Metrological Traceability

All test and measuring equipment utilized to perform the tests documented in this report are calibrated on a regular basis, with a maximum time between calibrations of one year or the manufacturers' recommendation, whichever is less, and where applicable is traceable to recognized national standards

2.2 Decision Rules

The Decision Rule is based on Simple Acceptance in accordance with ISO Guide 98-4: 2012 Clause 8.2. (Measurement uncertainty is not taken into account when stating conformity with a specified requirement).

2.3 Measurement Uncertainty

Where relevant, the following measurement uncertainty levels have been estimated for tests performed on the apparatus:

PARAMETER	U _{lab}
Worst Case Conducted Disturbance, 9KHz to 0.15 MHz	3.78 dB
Worst Case Conducted Disturbance, 0.15 to 30 MHz	3.40 dB
Worst Case Radiated Disturbance, 9KHz to 30 MHz	2.84 dB
Worst Case Radiated Disturbance, 30 to 1000 MHz	6.01 dB
Worst Case Radiated Disturbance, 1000 to 18000 MHz	4.73 dB
Worst Case Radiated Disturbance, 18000 to 26000 MHz	4.51 dB
Worst Case Radiated Disturbance, 26000 to 40000 MHz	5.29 dB

Uncertainty figures are valid to a confidence level of 95%.

2.4 Sample Calculation

RADIATED EMISSIONS

Where relevant, the following sample calculation is provided:

Field Strength (dBuV/m) = Measured Voltage (dBuV) + Antenna Factor (dB/m) + Cable Loss (dB) – Preamp Gain (dB)

$$36.5 \text{ dBuV} + 18.7 \text{ dB/m} + 0.6 \text{ dB} - 26.9 \text{ dB} = 28.9 \text{ dBuV/m}$$

MAINS CONDUCTED EMISSIONS

Where relevant, the following sample calculation is provided:

Final Voltage (dBuV) = Measured Voltage (dBuV) + Cable Loss (dB) + Limiter Factor (dB) + LISN Insertion Loss.

$$36.5 \text{ dBuV} + 0 \text{ dB} + 10.1 \text{ dB} + 0 \text{ dB} = 46.6 \text{ dBuV}$$

3.0 GENERAL - Product Description

3.1 Equipment Description

EUT is a wireless device contains a certified module FCC ID: FHO-920-00632, IC: 10912A-92000632.

3.2 Equipment Marking Plate

Not available.

3.3 Device Configuration During Test

3.3.1 Equipment Used During Test:

Use	Product Type	Manufacturer	Model	Comments
EUT	Wireless Device	IKEA	E1922	None
AE	Router	ASUS	RT-AC68U	Outside the chamber in the control room during radiated emission test.
AE	Tablet	Samsung	SM-T290	Outside the chamber in the control room during radiated emission test.
AE	Ferrite	KGS	GRFC-10	Outside the chamber in the control room during radiated emission test.

Note: **EUT** - Equipment Under Test, **AE** - Auxiliary/Associated Equipment, or **SIM** - Simulator (Not Subjected to Test)

3.3.2 Input/Output Ports:

Port #	Name	Type*	Cable Max. >3m (Y/N)	Cable Shielded (Y/N)	Comments
0	Enclosure	N/E	—	—	None
1	Mains	AC	Y	N	None
1	Router adapter	DC	N	N	None
1	RJ45 (CAT5)	I/O	Y	N	50 foot cable. Radiated emission test. EUT to router
1	RJ45 (CAT5)	I/O	Y	N	20 foot cable. AC Power Line conducted emission test. EUT to router

*Note:
 AC = AC Power Port DC = DC Power Port N/E = Non-Electrical
 I/O = Signal Input or Output Port (Not Involved in Process Control)
 TP = Telecommunication Ports

3.3.3 EUT Internal Operating Frequencies:

Frequency (MHz)	Description
5825	Highest operating frequency

3.3.4 Power Interface:

Mode # /Rated	Voltage (V)	Current (A)	Power (W)	Frequency (DC/AC-Hz)	Phases (#)	Comments
Rated	100-240	1	120	50/60	Single	
1	120 Vac	-	-	60Hz	Single	

3.3.5 Software and Firmware

Software version is: 20.0f1. The software is: Sonos GUI.

3.4 Block Diagram:

The diagram below illustrates the configuration of the equipment above.

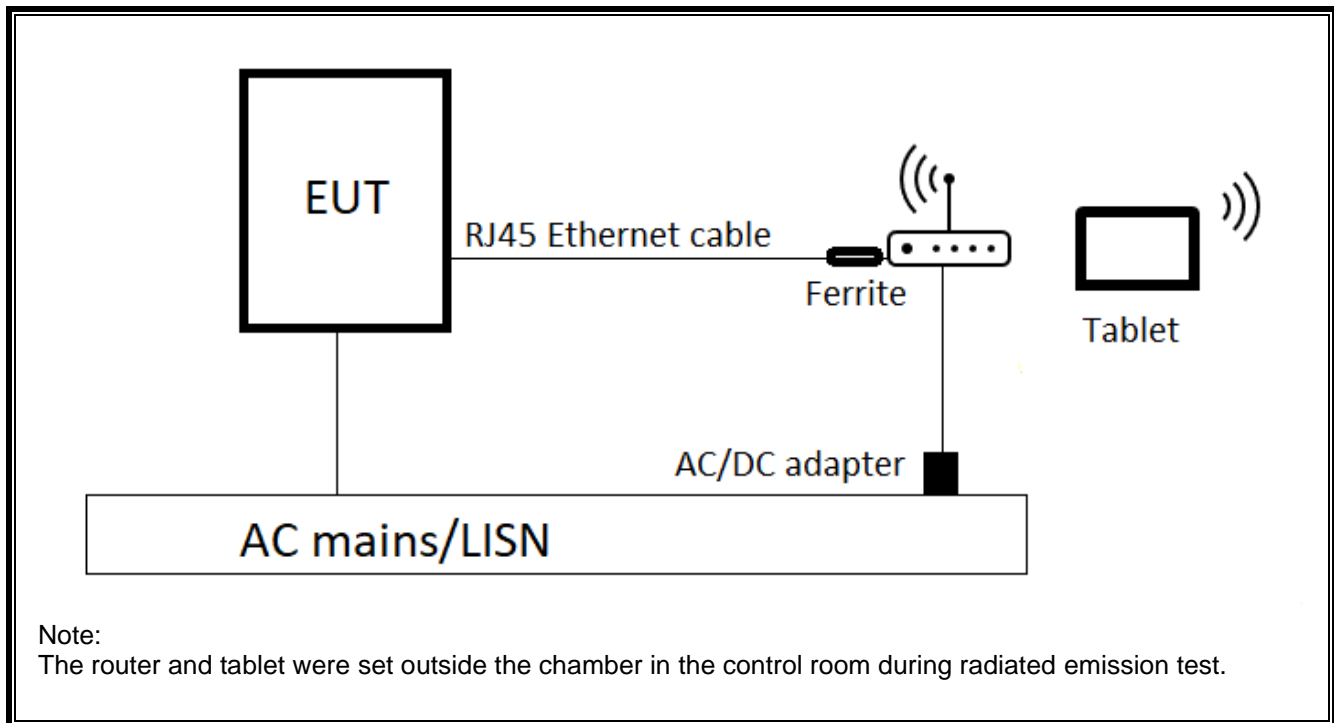

3.5 EUT Configurations

Configuration #	Description
1	EUT was configured for normal operation. RJ45 port of EUT is terminated with ethernet cable which was connected to a router. The router connected with a tablet wirelessly.

3.6 EUT Operation Modes

Mode of Operation#	Description
1	EUT was powered on and placed in its normal operating mode, EUT is configured for household mode and playing pink noise audio. EUT and router was communicating via RJ45 port. The router communicated with tablet wirelessly.

3.7 Rationale for EUT Configurations

Configuration #	Description
1	The selected EUT configuration was chosen to maximize emissions.

3.8 Rationale for EUT Mode of Operation

Mode of Operation #	Description
1	The selected EUT mode of operation was chosen to maximize emissions.

4.0 APPLICABLE EMISSIONS LIMITS AND TEST RESULTS**4.1 Test Conditions and Results - MAINS TERMINAL - CONDUCTED EMISSIONS**

Test Description	Measurements were made on a ground plane. All power was connected to the system through Artificial Mains Network (AMN). Conducted voltage measurements on mains lines were made at the output of the AMN.	
Test Standards	ANSI C63.4-2014 ICES-003 ISSUE 7: 2020	
Test Engineer	19497 AF	
Test Date	2021/07/01	
Laboratory Parameters	Required prior to the test	During the test
Ambient Temperature	10 to 40 °C	24.1 °C
Humidity	10 % to 90 %	43%
	Frequency range on each side of line	Measurement Point
Fully configured sample scanned over the following frequency range	150kHz to 30MHz	Mains
Limits - Class B		
Frequency (MHz)	Limit (dBµV)	
	Quasi-Peak	Average
0.15-0.5	66 to 56	56 to 46
0.5-5	56	46
5-30	60	50
Supplementary information: None		

Conducted Emissions EUT Configuration Settings

Power Interface #	EUT Configurations #	EUT Mode of Operation#
1	1	1
Supplementary information: None		

Conducted Emissions Test Equipment

Test Equipment List					
Description	Manufacturer	Model	Local ID (T No.)	Cal Date	Cal Due
LISN	Fischer Custom Communications, Inc	FCC-LISN-50/250-25-2-01-480V	PRE0186446	2021/01/20	2022/01/20
EMI TEST RECEIVER	Rohde & Schwarz	ESR	T1436	2021/02/19	2022/02/19
Transient Limiter	COM-POWER	LIT-930A	PRE0213145	2021/01/20	2022/01/20
AC Line Conducted Software	UL	UL EMC	Ver 9.5, July 07, 2020		

Results – 120 V, 60 Hz

Conducted Emissions Graph

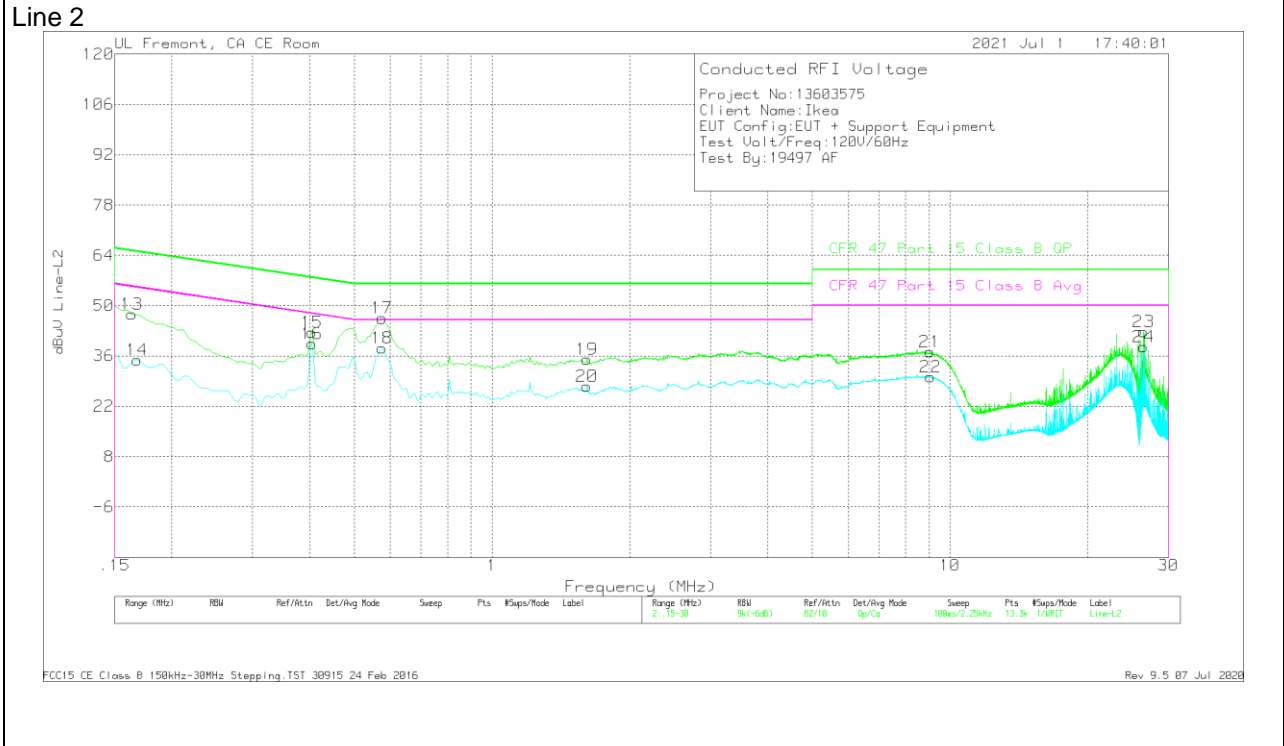

Conducted Emissions Data Points**Line-L1 .15 - 30MHz**

Marker	Frequency (MHz)	Meter Reading (dBuV)	Det	PRE018644 6 L1	LC Cables C1&C3 dB	TekBox Limiter TBFL1 Model 207	Corrected Reading dBuV	CFR 47 Part 15 Class B QP	QP Margin (dB)	CFR 47 Part 15 Class B Avg	Av(CISPR)M argin (dB)
1	.1725	38.22	Qp	0	0	9.4	47.62	64.84	-17.22	-	-
2	.1725	25.92	Ca	0	0	9.4	35.32	-	-	54.84	-19.52
3	.40425	33.37	Qp	0	0	9.3	42.67	57.77	-15.1	-	-
4	.40425	29.65	Ca	0	0	9.3	38.95	-	-	47.77	-8.82
5	.57525	37.85	Qp	0	0	9.3	47.15	56	-8.85	-	-
6	.57525	29.79	Ca	0	0	9.3	39.09	-	-	46	-6.91
7	1.6125	25.9	Qp	0	.1	9.3	35.3	56	-20.7	-	-
8	1.6125	18.31	Ca	0	.1	9.3	27.71	-	-	46	-18.29
9	9.06225	27.52	Qp	0	.2	9.3	37.02	60	-22.98	-	-
10	9.033	20.81	Ca	0	.2	9.3	30.31	-	-	50	-19.69
11	26.48625	32.84	Qp	0	.3	9.3	42.44	60	-17.56	-	-
12	26.48625	28.42	Ca	0	.3	9.3	38.02	-	-	50	-11.98

Line-L2 .15 - 30MHz

Marker	Frequency (MHz)	Meter Reading (dBuV)	Det	PRE018644 6 L2	LC Cables C2&C3 dB	TekBox Limiter TBFL1 Model 207	Corrected Reading dBuV	CFR 47 Part 15 Class B QP	QP Margin (dB)	CFR 47 Part 15 Class B Avg	Av(CISPR)M argin (dB)
13	.1635	38.31	Qp	0	0	9.4	47.71	65.28	-17.57	-	-
14	.168	25.51	Ca	0	0	9.4	34.91	-	-	55.06	-20.15
15	.40425	33.31	Qp	0	0	9.3	42.61	57.77	-15.16	-	-
16	.40425	30.13	Ca	0	0	9.3	39.43	-	-	47.77	-8.34
17	.57525	37.21	Qp	0	0	9.3	46.51	56	-9.49	-	-
18	.57525	28.95	Ca	0	0	9.3	38.25	-	-	46	-7.75
19	1.6125	25.73	Qp	0	.1	9.3	35.13	56	-20.87	-	-
20	1.6125	18.19	Ca	0	.1	9.3	27.59	-	-	46	-18.41
21	9.0285	27.6	Qp	0	.2	9.3	37.1	60	-22.9	-	-
22	9.0555	20.64	Ca	0	.2	9.3	30.14	-	-	50	-19.86
23	26.48625	33.08	Qp	.1	.3	9.3	42.78	60	-17.22	-	-
24	26.48625	28.81	Ca	.1	.3	9.3	38.51	-	-	50	-11.49

Qp - Quasi-Peak detector

Ca - CISPR average detection

4.2 Test Conditions and Results - RADIATED EMISSIONS

Test Description	Measurements were made in a 3-meter/10-meter semi-anechoic chamber that complies to CISPR 16/ANSI C63.4. Preliminary (peak) measurements were performed at an antenna to EUT separation distance of 3 meter/10-meter. The EUT was rotated 360° about its azimuth with the receive antenna located at various heights in both horizontal and vertical polarities. Final measurements (quasi-peak or average as noted) were then performed by rotating the EUT 360° and adjusting the receive antenna height from 1 to 4-meters. All frequencies were investigated in both horizontal and vertical antenna polarity, where applicable.	
Test Standards	ANSI C63.4-2014	
Test Engineer	19497 AF	
Test Date	2021/06/30 and 2021/07/01	
Laboratory Parameters	Required prior to the test	During the test
Ambient Temperature	10 to 40 °C	23.8 °C
Humidity	10 % to 90 %	44%
	Frequency range	Measurement Point
Fully configured sample scanned over the following frequency range	30MHz to 40GHz	3 Meter measurement distance
Limits - Class B		
Frequency (MHz)	Frequency (MHz)	
FCC Limits for radiated disturbance of Class B ITE at measuring distance of 3 m		
	Quasi-Peak	Average
30-88	40	NA
88-216	43.5	NA
216-960	46	NA
Above 960	54	NA
	Peak	Average
Above 1 GHz	74	54
ISED Limits for radiated disturbance of Class B ITE at measuring distance of 3 m		
	Quasi-Peak	NA
30-88	40	NA
88-216	43.5	NA
216-230	46	NA
230-960	47	NA
Above 960	54	NA
	Peak	Average
Above 1GHz	74	54
Supplementary information: Maximization was performed at 3 meter distance.		

Radiated Emissions EUT Configuration Settings

Power Interface #	EUT Configurations #	EUT Mode of Operation#
1	1	1
Supplementary information: None		

Radiated Emissions Test Equipment

Test Equipment List					
Description	Manufacturer	Model	Local ID (T No.)	Cal Date	Cal Due
Antenna, Broadband Hybrid, 30MHz to 2GHz	Sunol Sciences Corp.	JB3	T477(AF 81560)	2020/09/24	2021/09/24
Amplifier, 9KHz to 1GHz, 32dB	SONOMA INSTRUMENT	310	175953	2021/01/21	2022/01/21
Antenna, Horn 1-18GHz	ETS-Lindgren	3117	T863	2020/08/31	2021/08/31
Amplifier, 100MHz-18GHz	AMPLICAL	AMP0.1G18-47-20	PRE0197319	2021/04/08	2022/04/08
Filter, BRF 2400 to 2500 MHz	MICRO-TRONICS	BRM50702-02	204778	2021/06/21	2022/06/21
EMI TEST RECEIVER	Rohde & Schwarz	ESW44	PRE0179367	2021/02/21	2022/02/21
Antenna, Horn 18 to 26.5GHz	ARA	MWH-1826/B	T447	2020/09/24	2021/09/24
Amplifier, 1 to 26.5GHz, 23.5dB Gain minimum	Keysight Technologies Inc	8449B	T404	2021/04/19	2022/04/19
Antenna, Horn 26.5 to 40GHz	ARA	MWH-2640/B	T446	2020/09/24	2021/09/24
Amplifier, 26 - 40GHz	MITEQ	TTA2640-35-HG	T1864	2021/04/19	2022/04/19
Radiated Software	UL	UL EMC	Rev 9.5, April 30, 2020 Rev 9.5, Oct 21, 2019 (above 18G)		

RADIATED EMISSIONS 30 TO 1000 MHz (WORST-CASE CONFIGURATION)

Radiated Emissions Graph

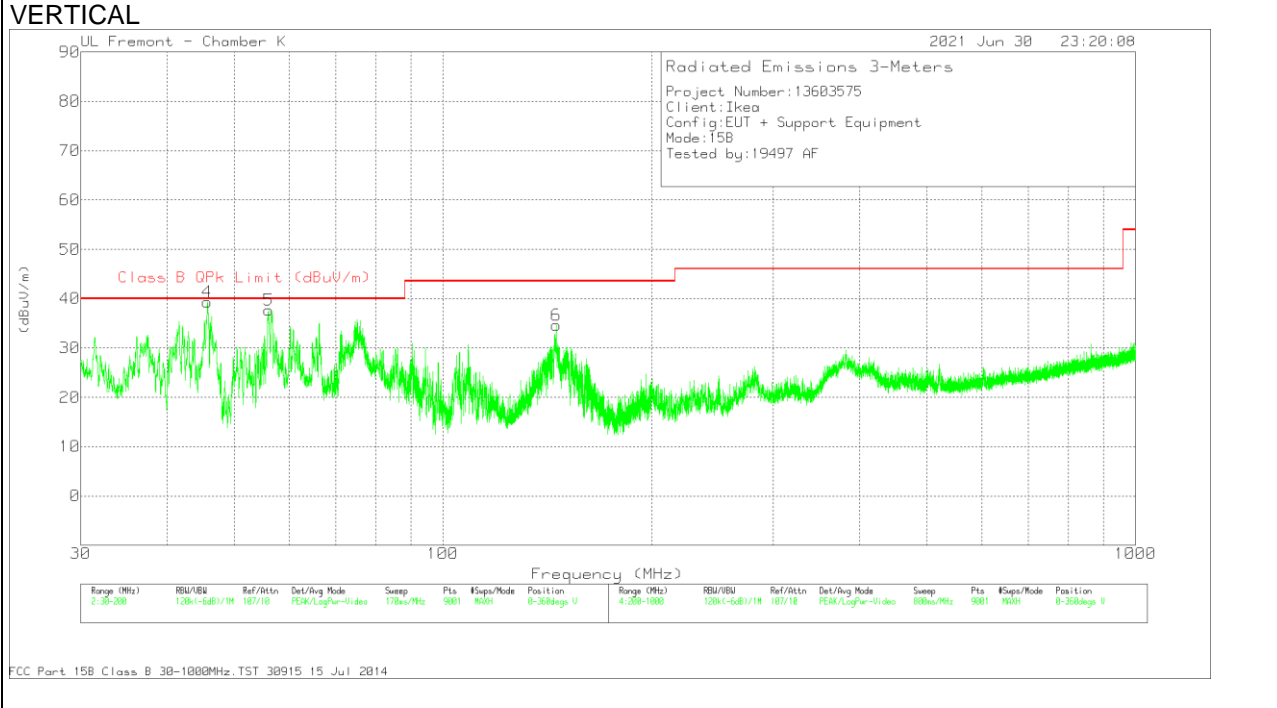
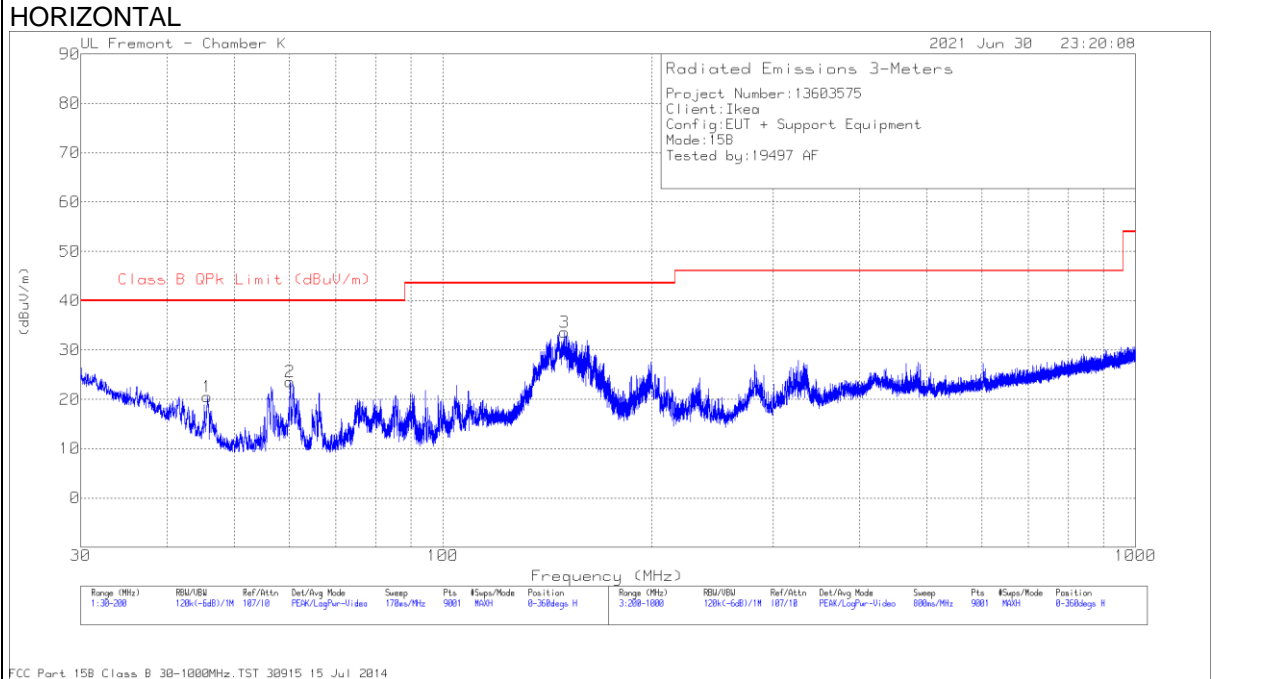

Radiated Emissions Data Points

Marker	Frequency (MHz)	Meter Reading (dBuV)	Det	AF 81560 (dB/m)	Amp/Cbl (dB)	Corrected Reading (dBuV/m)	Class B QPk Limit (dBuV/m)	Margin (dB)	Azimuth (Degs)	Height (cm)	Polarity
1	45.7345	35.45	Pk	16.5	-31.4	20.55	40	-19.45	0-360	99	H
2	60.2224	41.17	Pk	13.6	-31.2	23.57	40	-16.43	0-360	299	H
3	149.8129	45.51	Pk	18.7	-30.6	33.61	43.52	-9.91	0-360	199	H
4	45.74361	53.24	Qp	16.5	-31.4	38.34	40	-1.66	49	95	V
5	56.00876	51.24	Qp	13.5	-31.3	33.44	40	-6.56	47	97	V
6	145.7896	46.48	Pk	18.8	-30.6	34.68	43.52	-8.84	0-360	95	V

Pk - Peak detector
 Qp - Quasi-Peak detector

RADIATED EMISSIONS 1000 TO 18,000 MHz – FCC

Radiated Emissions Graph

HORIZONTAL

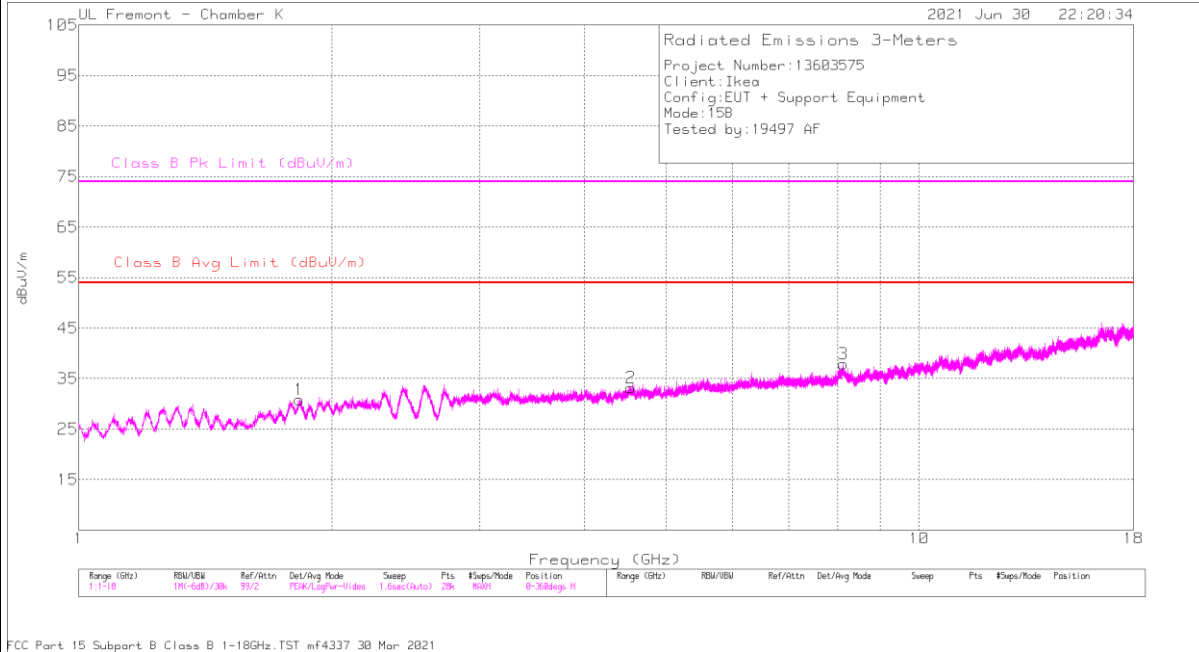

VERTICAL

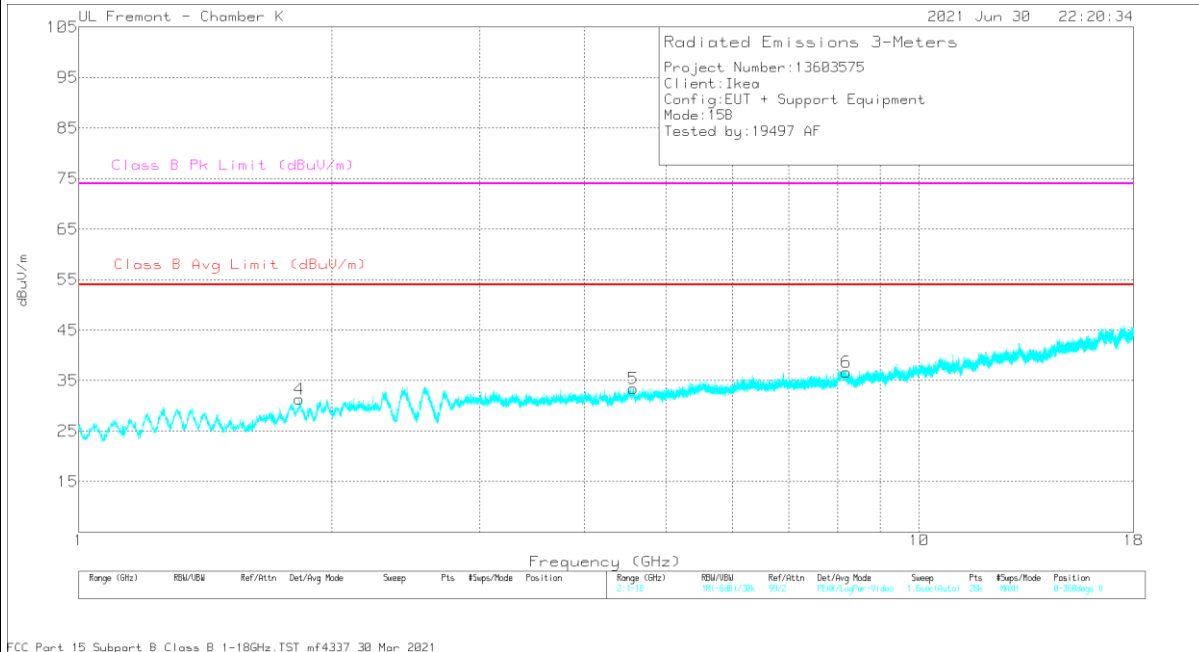

Radiated Emissions Data Points

Marker	Frequency (GHz)	Meter Reading (dBuV)	Det	AF T863 (dB/m)	Amp/Cbi (dB)	BRF 204778 (dB)	Corrected Reading dBuV/m	Class B Avg Limit (dBuV/m)	Margin (dB)	Class B Pk Limit (dBuV/m)	PK Margin (dB)	Azimuth (Degs)	Height (cm)	Polarity
1	1.83193	56.19	Pk	30.6	-45.8	1	41.99	-	-	74	-32.01	190	355	H
	1.83193	42.3	Av	30.6	-45.8	1	28.1	54	-25.9	-	-	190	355	H
2	4.53966	50.43	Pk	34.2	-41.4	1	44.23	-	-	74	-29.77	356	188	H
	4.53966	36.29	Av	34.2	-41.4	1	30.09	54	-23.91	-	-	356	188	H
3	8.12607	48.41	Pk	36.1	-37.3	1	48.21	-	-	74	-25.79	145	110	H
	8.12607	34.41	Av	36.1	-37.3	1	34.21	54	-19.79	-	-	145	110	H
4	1.83292	55.44	Pk	30.7	-45.8	1	41.34	-	-	74	-32.66	245	256	V
	1.83292	42.37	Av	30.7	-45.8	1	28.27	54	-25.73	-	-	245	256	V
5	4.57335	51.12	Pk	34.3	-41.3	1	45.12	-	-	74	-28.88	155	102	V
	4.57335	36.57	Av	34.3	-41.3	1	30.57	54	-23.43	-	-	155	102	V
6	8.20253	47.14	Pk	36.1	-37.4	1	46.84	-	-	74	-27.16	58	354	V
	8.20253	33.81	Av	36.1	-37.4	1	33.51	54	-20.49	-	-	58	354	V

Pk - Peak detector
 Av - Average detection

RADIATED EMISSIONS 18,000 TO 26,000 MHz – FCC

Radiated Emissions Graph

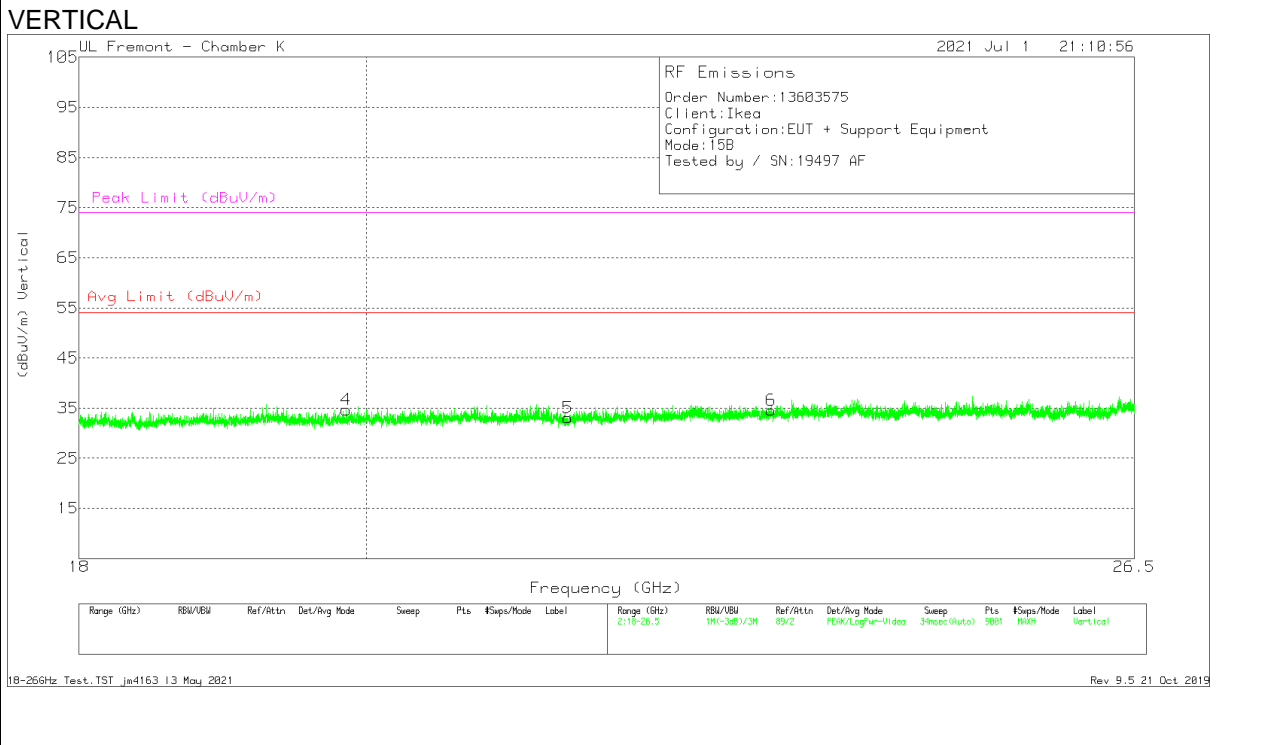
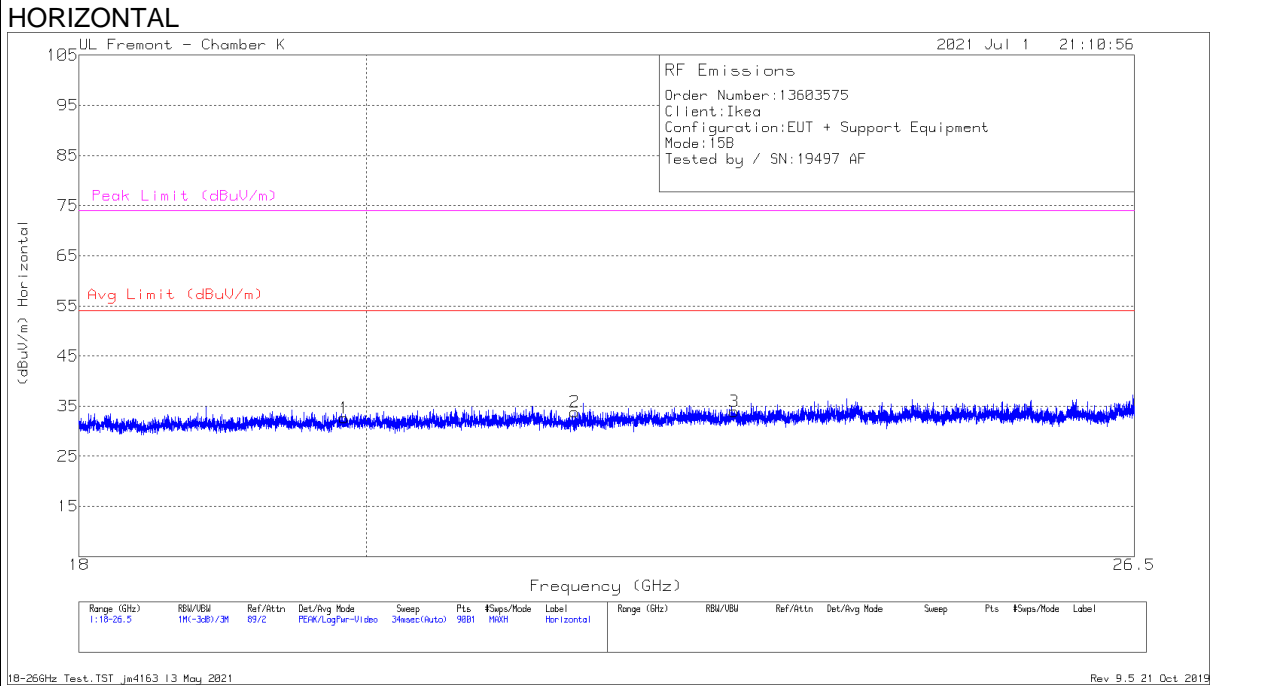

Radiated Emissions Data Points

Marker	Frequency (GHz)	Meter Reading (dBuV)	Det	T447 AF (dB/m)	Amp/Cbl (dB)	Dist Corr (dB)	Corrected Reading (dBuV/m)	Avg Limit (dBuV/m)	Margin (dB)	Peak Limit (dBuV/m)	PK Margin (dB)
1	19.83694	66.41	Pk	32.8	-57.1	-9.5	32.61	54	-21.39	74	-41.39
2	21.58511	67.53	Pk	33.2	-57.4	-9.5	33.83	54	-20.17	74	-40.17
3	22.88561	67	Pk	33.7	-57.3	-9.5	33.9	54	-20.1	74	-40.1
4	19.85111	68.47	Pk	32.8	-57.1	-9.5	34.67	54	-19.33	74	-39.33
5	21.52939	66.47	Pk	33.2	-57.1	-9.5	33.07	54	-20.93	74	-40.93
6	23.19728	67.46	Pk	33.8	-57.2	-9.5	34.56	54	-19.44	74	-39.44

Pk - Peak detector

RADIATED EMISSIONS 26,000 TO 40,000 MHz – FCC

Radiated Emissions Graph

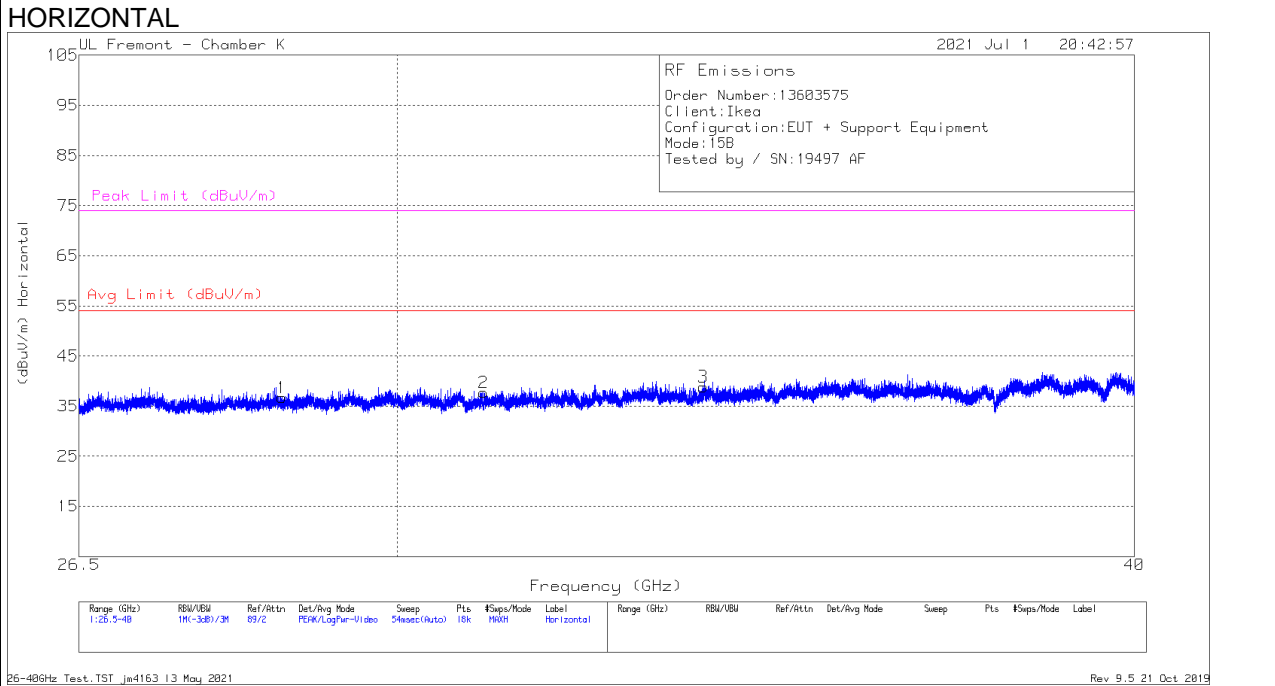

Radiated Emissions Data Points

Marker	Frequency (GHz)	Meter Reading (dBuV)	Det	T446 AF (dB/m)	Amp/Cbl (dB)	Dist Corr (dB)	Corrected Reading (dBuV/m)	Avg Limit (dBuV/m)	Margin (dB)	Peak Limit (dBuV/m)	PK Margin (dB)
1	28.684	63.22	Pk	36.4	-53.4	-9.5	36.72	54	-17.28	74	-37.28
2	31.03075	64.72	Pk	36.8	-54.3	-9.5	37.72	54	-16.28	74	-36.28
3	33.80425	63.84	Pk	37.8	-53.3	-9.5	38.84	54	-15.16	74	-35.16
4	28.8985	62.15	Pk	36.4	-52.9	-9.5	36.15	54	-17.85	74	-37.85
5	30.98125	63.54	Pk	36.8	-54	-9.5	36.84	54	-17.16	74	-37.16
6	34.00525	64.1	Pk	37.6	-54.1	-9.5	38.1	54	-15.9	74	-35.9

Pk - Peak detector

Appendix A**Facilities, Accreditations and Authorizations**

UL LLC is accredited by A2LA, certification #0751.05, for all testing performed within the scope of this report. Testing was performed at the locations noted below.

	Address	ISED CABID	ISED Company Number	FCC Registration
<input type="checkbox"/>	Building 1: 47173 Benicia Street, Fremont, CA 94538, USA	US0104	2324A	208313
<input type="checkbox"/>	Building 2: 47266 Benicia Street, Fremont, CA 94538, USA	US0104	22541	208313
<input checked="" type="checkbox"/>	Building 4: 47658 Kato Rd, Fremont, CA 94538, USA	US0104	2324B	208313

END OF TEST REPORT