



A D T

FCC TEST REPORT

REPORT NO.: RF981015L10F
MODEL NO.: SRDW01
FCC ID: FDISRDW01-0
RECEIVED: May 09, 2012
TESTED: May 19 ~ May 25, 2012
ISSUED: May 29, 2012

APPLICANT: BUFFALO INC.

ADDRESS: AKAMONDORI Bldg., 30-20, Ohsu 3-chome,
Naka-ku, Nagoya. Aichi, 460-8315, Japan

ISSUED BY: Bureau Veritas Consumer Products Services
(H.K.) Ltd., Taoyuan Branch

LAB ADDRESS: No. 47, 14th Ling, Chia Pau Vil., Lin Kou Dist.,
New Taipei City, Taiwan, R.O.C.

TEST LOCATION: No. 19, Hwa Ya 2nd Rd, Wen Hwa Tsuen, Kwei
Shan Hsiang, Taoyuan Hsien 333, Taiwan, R.O.C.

This report should not be used by the client to claim product certification, approval, or endorsement by TAF or any government agencies.



This report is for your exclusive use. Any copying or replication of this report to or for any other person or entity, or use of our name or trademark, is permitted only with our prior written permission. This report sets forth our findings solely with respect to the test samples identified herein. The results set forth in this report are not indicative or representative of the quality or characteristics of the lot from which a test sample was taken or any similar or identical product unless specifically and expressly noted. Our report includes all of the tests requested by you and the results thereof based upon the information that you provided to us. You have 60 days from date of issuance of this report to notify us of any material error or omission caused by our negligence, provided, however, that such notice shall be in writing and shall specifically address the issue you wish to raise. A failure to raise such issue within the prescribed time shall constitute your unqualified acceptance of the completeness of this report, the tests conducted and the correctness of the report contents. Unless specific mention, the uncertainty of measurement has been explicitly taken into account to declare the compliance or non-compliance to the specification.



Table of Contents

RELEASE CONTROL RECORD	3
1. CERTIFICATION	4
2. SUMMARY OF TEST RESULTS	5
2.1 MEASUREMENT UNCERTAINTY	5
3. GENERAL INFORMATION	6
3.1 GENERAL DESCRIPTION OF EUT	6
3.2 DESCRIPTION OF TEST MODES	7
3.2.1 TEST MODE APPLICABILITY AND TESTED CHANNEL DETAIL	7
3.3 DESCRIPTION OF SUPPORT UNITS	8
3.3.1 CONFIGURATION OF SYSTEM UNDER TEST	9
3.4 GENERAL DESCRIPTION OF APPLIED STANDARDS	9
4. TEST TYPES AND RESULTS	10
4.1 RADIATED EMISSION AND BAND EDGE MEASUREMENT	10
4.1.1 LIMITS OF RADIATED EMISSION AND BAND EDGE MEASUREMENT	10
4.1.2 TEST INSTRUMENTS	11
4.1.3 TEST PROCEDURES	12
4.1.4 DEVIATION FROM TEST STANDARD	12
4.1.5 TEST SETUP	13
4.1.6 EUT OPERATING CONDITIONS	13
4.1.7 TEST RESULTS	14
4.2 CONDUCTED EMISSION MEASUREMENT	19
4.2.1 LIMITS OF CONDUCTED EMISSION MEASUREMENT	19
4.2.2 TEST INSTRUMENTS	19
4.2.3 TEST PROCEDURES	20
4.2.4 DEVIATION FROM TEST STANDARD	20
4.2.5 TEST SETUP	20
4.2.6 EUT OPERATING CONDITIONS	20
4.2.7 TEST RESULTS	21
5. PHOTOGRAPHS OF THE TEST CONFIGURATION	23
6. INFORMATION ON THE TESTING LABORATORIES	24
7. APPENDIX A – MODIFICATION RECORDERS FOR ENGINEERING CHANGES TO THE EUT BY THE LAB	25



A D T

RELEASE CONTROL RECORD

ISSUE NO.	REASON FOR CHANGE	DATE ISSUED
RF981015L10F	Original release	May 29, 2012



1. CERTIFICATION

PRODUCT: 2.4GHz Wireless Receiver

MODEL NO.: SRDW01

BRAND: iBUFFALO

APPLICANT: BUFFALO INC.

TESTED: May 19 ~ May 25, 2012

TEST SAMPLE: ENGINEERING SAMPLE

STANDARDS: FCC Part 15, Subpart C (Section 15.249)

ANSI C63.10-2009

The above equipment (model: SRDW01) has been tested by **Bureau Veritas Consumer Products Services (H.K.) Ltd., Taoyuan Branch**, and found compliance with the requirement of the above standards. The test record, data evaluation & Equipment Under Test (EUT) configurations represented herein are true and accurate accounts of the measurements of the sample's EMC characteristics under the conditions specified in this report.

PREPARED BY : Evelyn Wu , DATE : May 29, 2012
Evelyn Wu / Specialist

APPROVED BY : Gary Chang , DATE : May 29, 2012
Gary Chang / Technical Manager



A D T

2. SUMMARY OF TEST RESULTS

The EUT has been tested according to the following specifications:

APPLIED STANDARD: FCC Part 15, Subpart C (Section 15.249)			
STANDARD PARAGRAPH	TEST TYPE	RESULT	REMARK
15.207	Conducted Emission Test	PASS	Meet the requirement of limit. Minimum passing margin is -7.99dB at 0.17734MHz.
15.209 15.249 15.249 (d)	Radiated Emission Test Band Edge Measurement Limit: 50dB less than the peak value of fundamental frequency or meet radiated emission limit in section 15.209	PASS	Meet the requirement of limit. Minimum passing margin is -9.9dB at 239.88MHz.

2.1 MEASUREMENT UNCERTAINTY

Where relevant, the following measurement uncertainty levels have been estimated for tests performed on the EUT as specified in CISPR 16-4-2:

MEASUREMENT	FREQUENCY	UNCERTAINTY
Conducted emissions	9kHz~30MHz	2.44 dB
Radiated emission	30MHz ~ 200MHz	3.34 dB
	200MHz ~1000MHz	3.35 dB
	1GHz ~ 18GHz	2.26 dB
	18GHz ~ 40GHz	1.94 dB

This uncertainty represents an expanded uncertainty expressed at approximately the 95% confidence level using a coverage factor of k=2.

3. GENERAL INFORMATION

3.1 GENERAL DESCRIPTION OF EUT

EUT	2.4GHz Wireless Receiver
MODEL NO.	SRDW01
POWER SUPPLY	5Vdc from host equipment
MODULATION TYPE	GFSK
DATA RATE	2Mbps
OPERATING FREQUENCY	2406 ~ 2478MHz
NUMBER OF CHANNEL	5
ANTENNA TYPE	Copper trace antenna with -4.26dBi gain
DATA CABLE	N/A
I/O PORT	USB
ACCESSORY DEVICES	N/A

NOTE:

1. The EUT has transmitter and receiver functions.
2. The above EUT information is declared by the manufacturer and for more detailed features description, please refer to the manufacturer's specifications or User's Manual.



A D T

3.2 DESCRIPTION OF TEST MODES

5 channels are provided to this EUT:

CHANNEL	FREQUENCY
1	2406 MHz
2	2425 MHz
3	2440 MHz
4	2470 MHz
5	2478 MHz

3.2.1 TEST MODE APPLICABILITY AND TESTED CHANNEL DETAIL

EUT CONFIGURE MODE	APPLICABLE TO				DESCRIPTION
	RE \geq 1G	RE $<$ 1G	PLC	BM	
-	√	√	√	√	-

Where **RE $<$ 1G**: Radiated Emission below 1GHz **RE \geq 1G**: Radiated Emission above 1GHz
PLC: Power Line Conducted Emission **BM**: Bandedge Measurement

RADIATED EMISSION TEST (ABOVE 1 GHz):

- Pre-Scan has been conducted to determine the worst-case mode from all possible combinations between available modulations axis and antenna ports (if EUT with antenna diversity architecture).
- Following channel(s) was (were) selected for the final test as listed below.

EUT CONFIGURE MODE	AVAILABLE CHANNEL	TESTED CHANNEL	MODULATION TYPE
-	1 to 5	1, 3, 5	GFSK

RADIATED EMISSION TEST (BELOW 1 GHz):

- Pre-Scan has been conducted to determine the worst-case mode from all possible combinations between available modulations axis and antenna ports (if EUT with antenna diversity architecture).
- Following channel(s) was (were) selected for the final test as listed below.

EUT CONFIGURE MODE	AVAILABLE CHANNEL	TESTED CHANNEL	MODULATION TYPE
-	1 to 5	1	GFSK



A D T

POWER LINE CONDUCTED EMISSION TEST:

- Pre-Scan has been conducted to determine the worst-case mode from all possible combinations between available modulations, data rates and antenna ports (if EUT with antenna diversity architecture).
- Following channel(s) was (were) selected for the final test as listed below.

EUT CONFIGURE MODE	AVAILABLE CHANNEL	TESTED CHANNEL	MODULATION TYPE
-	1 to 5	1	GFSK

BANDEDGE MEASUREMENT:

- Pre-Scan has been conducted to determine the worst-case mode from all possible combinations between available modulations and antenna ports (if EUT with antenna diversity architecture).
- Following channel(s) was (were) selected for the final test as listed below.

EUT CONFIGURE MODE	AVAILABLE CHANNEL	TESTED CHANNEL	MODULATION TYPE
-	1 to 5	1, 5	GFSK

TEST CONDITION:

APPLICABLE TO	ENVIRONMENTAL CONDITIONS	INPUT POWER (SYSTEM) (SYSTEM)	TESTED BY
RE≥1G	25deg. C, 65%RH	120Vac, 60Hz	Aska Huang
RE<1G	25deg. C, 65%RH	120Vac, 60Hz	Aska Huang
PLC	23deg. C, 65%RH	120Vac, 60Hz	Daniel Lin
BM	25deg. C, 65%RH	120Vac, 60Hz	Aska Huang

3.3 DESCRIPTION OF SUPPORT UNITS

The EUT has been tested as an independent unit together with other necessary accessories or support units. The following support units or accessories were used to form a representative test configuration during the tests.

NO.	PRODUCT	BRAND	MODEL NO.	SERIAL NO.	FCC ID
1	NOTEBOOK	DELL	E5410	5JBC7N1	FCC DoC Approved

NO.	SIGNAL CABLE DESCRIPTION OF THE ABOVE SUPPORT UNITS
1	NA

NOTE: All power cords of the above support units are non shielded (1.8m).

3.3.1 CONFIGURATION OF SYSTEM UNDER TEST

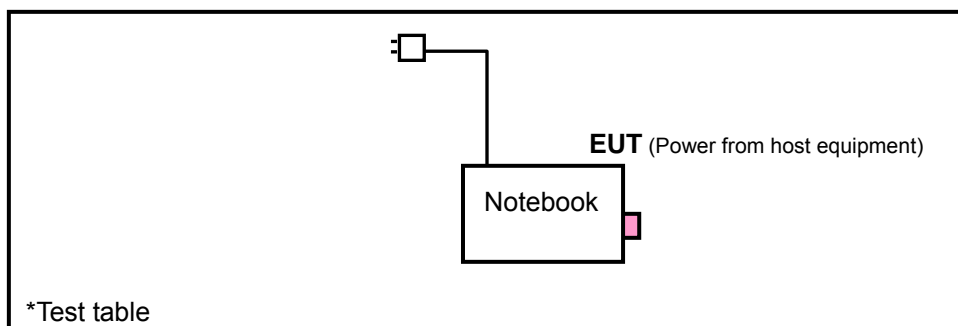

3.4 GENERAL DESCRIPTION OF APPLIED STANDARDS

The EUT is a RF Product. According to the specifications of the manufacturer, it must comply with the requirements of the following standards:

FCC Part 15, Subpart C (Section 15.249)

ANSI C63.10-2009

All test items have been performed and recorded as per the above standards.

NOTE: The EUT is also considered as a kind of computer peripheral, because the connection to computer is necessary for typical use. It has been verified to comply with the requirements of FCC Part 15, Subpart B, Class B (DoC). The test report has been issued separately.

4. TEST TYPES AND RESULTS

4.1 RADIATED EMISSION AND BAND EDGE MEASUREMENT

4.1.1 LIMITS OF RADIATED EMISSION and BAND EDGE MEASUREMENT

The field strength of emissions from intentional radiators operated within these frequency bands shall comply with the following

Fundamental Frequency	Field Strength of Fundamental (millivolts/meter)	Field Strength of Harmonics (microvolts/meter)
902 ~ 928 MHz	50	500
2400 ~ 2483.5 MHz	50	500
5725 ~ 5875 MHz	50	500
24 ~ 24.25 GHz	250	2500

Emissions radiated outside of the specified frequency bands, except for harmonics, shall be attenuated by at least 50 dB below the level of the fundamental or to the general radiated emission limits as below table, whichever is the lesser attenuation

Frequencies (MHz)	Field strength (microvolts/meter)	Measurement distance (meters)
0.009 ~ 0.490	2400/F(kHz)	300
0.490 ~ 1.705	24000/F(kHz)	30
1.705 ~ 30.0	30	30
30 ~ 88	100	3
88 ~ 216	150	3
216 ~ 960	200	3
Above 960	500	3

NOTE:

1. The lower limit shall apply at the transition frequencies.
2. Emission level (dBuV/m) = 20 log Emission level (uV/m).
3. For frequencies above 1000MHz, the field strength limits are based on average detector, however, the peak field strength of any emission shall not exceed the maximum permitted average limits, specified above by more than 20dB under any condition of modulation.



A D T

4.1.2 TEST INSTRUMENTS

DESCRIPTION & MANUFACTURER	MODEL NO.	SERIAL NO.	DATE OF CALIBRATION	DUE DATE OF CALIBRATION
Test Receiver ROHDE & SCHWARZ	ESIB7	100212	Aug. 02, 2011	Aug. 01, 2012
Spectrum Analyzer ROHDE & SCHWARZ	FSP40	100041	Jul. 21, 2011	Jul. 20, 2012
BILOG Antenna SCHWARZBECK	VULB9168	9168-160	Apr. 06, 2012	Apr. 05, 2013
HORN Antenna SCHWARZBECK	9120D	209	Aug. 25, 2011	Aug. 24, 2012
HORN Antenna SCHWARZBECK	BBHA 9170	148	Jul. 20, 2011	Jul. 19, 2012
Preamplifier Agilent	8447D	2944A10633	Oct. 29, 2011	Oct. 28, 2012
Preamplifier Agilent	8449B	3008A01964	Oct. 29, 2011	Oct. 28, 2012
RF signal cable HUBER+SUHNNER	SUCOFLEX 104	250723/4	Aug. 30, 2011	Aug. 29, 2012
RF signal cable HUBER+SUHNNER	SUCOFLEX 106	12738/6+309224/4	Aug. 30, 2011	Aug. 29, 2012
Software ADT.	ADT_Radiated_ V7.6.15.9.2	NA	NA	NA
Antenna Tower inn-co GmbH	MA 4000	013303	NA	NA
Antenna Tower Controller inn-co GmbH	CO2000	017303	NA	NA
Turn Table ADT.	TT100	TT93021703	NA	NA
Turn Table Controller ADT.	SC100	SC93021703	NA	NA

- NOTE:**
1. The calibration interval of the above test instruments is 12 months and the calibrations are traceable to NML/ROC and NIST/USA.
 2. The test was performed in HwaYa Chamber 3.
 3. The horn antenna and HP preamplifier (model: 8449B) are used only for the measurement of emission frequency above 1GHz if tested.
 4. The FCC Site Registration No. is 988962.
 5. The IC Site Registration No. is IC 7450F-3.

4.1.3 TEST PROCEDURES

- a. The EUT was placed on the top of a rotating table 0.8 meters above the ground at a 3 meter semi-anechoic chamber. The table was rotated 360 degrees to determine the position of the highest radiation.
- b. The EUT was set 3 meters away from the interference-receiving antenna, which was mounted on the top of a variable-height antenna tower.
- c. The antenna is a broadband antenna, and its height is varied from one meter to four meters above the ground to determine the maximum value of the field strength. Both horizontal and vertical polarizations of the antenna are set to make the measurement.
- d. For each suspected emission, the EUT was arranged to its worst case and then the antenna was tuned to heights from 1 meter to 4 meters and the rotatable table was turned from 0 degrees to 360 degrees to find the maximum reading.
- e. The test-receiver system was set to Peak Detect Function and Specified Bandwidth with Maximum Hold Mode.
- f. If the emission level of the EUT in peak mode was lower than the limit specified, then testing could be stopped and the peak values of the EUT would be reported. Otherwise the emissions would be re-tested one by one using peak, quasi-peak or average method as specified and then reported in a data sheet.

NOTE:

1. The resolution bandwidth and video bandwidth of test receiver/spectrum analyzer is 120kHz for Quasi-peak detection at frequency below 1GHz.
2. The resolution bandwidth of test receiver/spectrum analyzer is 1MHz and video bandwidth is 3MHz for Peak detection at frequency above 1GHz.
3. All modes of operation were investigated and the worst-case emissions are reported.

4.1.4 DEVIATION FROM TEST STANDARD

No deviation.

4.1.5 TEST SETUP

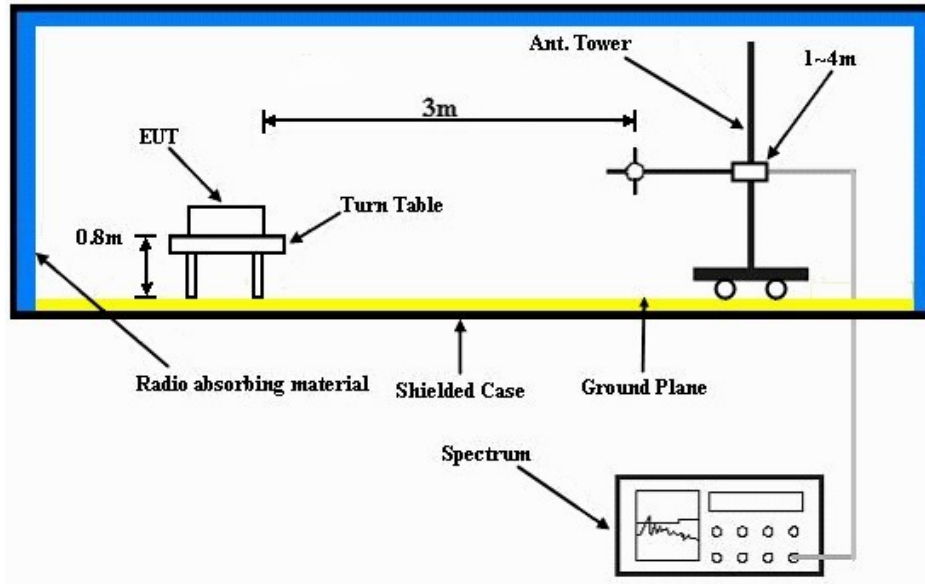

For the actual test configuration, please refer to the attached file (Test Setup Photo).

4.1.6 EUT OPERATING CONDITIONS

- a. Plugged the EUT to notebook and placed on a testing table.
- b. Set the transmitter part of EUT under transmission condition continuously at specific channel frequency.



4.1.7 TEST RESULTS

ABOVE 1GHz DATA

EUT TEST CONDITION		MEASUREMENT DETAIL	
TEST CHANNEL	1	FREQUENCY RANGE	1 ~ 25GHz
INPUT POWER (SYSTEM)	5 Vdc	DETECTOR FUNCTION	Peak (PK) Average (AV)
ENVIRONMENTAL CONDITIONS	25deg. C, 65%RH	TESTED BY	Aska Huang

ANTENNA POLARITY & TEST DISTANCE: HORIZONTAL AT 3 M								
NO.	FREQ. (MHz)	EMISSION LEVEL (dBuV/m)	LIMIT (dBuV/m)	MARGIN (dB)	ANTENNA HEIGHT (m)	TABLE ANGLE (Degree)	RAW VALUE (dBuV)	CORRECTION FACTOR (dB/m)
1	2390.00	47.9 PK	74.0	-26.1	1.09 H	154	16.60	31.30
2	2390.00	29.9 AV	54.0	-24.1	1.09 H	154	-1.40	31.30
3	2400.00	56.0 PK	74.0	-18.0	1.09 H	154	24.70	31.30
4	2400.00	28.7 AV	54.0	-25.3	1.09 H	154	-2.60	31.30
5	*2406.00	86.9 PK	114.0	-27.1	1.09 H	154	55.50	31.40
6	*2406.00	50.2 AV	94.0	-43.8	1.09 H	154	18.80	31.40
7	4812.00	51.5 PK	74.0	-22.5	1.00 H	321	14.30	37.20
8	4812.00	14.8 AV	54.0	-39.2	1.00 H	321	-22.40	37.20
ANTENNA POLARITY & TEST DISTANCE: VERTICAL AT 3 M								
NO.	FREQ. (MHz)	EMISSION LEVEL (dBuV/m)	LIMIT (dBuV/m)	MARGIN (dB)	ANTENNA HEIGHT (m)	TABLE ANGLE (Degree)	RAW VALUE (dBuV)	CORRECTION FACTOR (dB/m)
1	2390.00	44.4 PK	74.0	-29.6	1.71 V	207	13.10	31.30
2	2390.00	28.4 AV	54.0	-25.6	1.71 V	207	-2.90	31.30
3	2400.00	53.8 PK	74.0	-20.2	1.71 V	207	22.50	31.30
4	2400.00	28.3 AV	54.0	-25.7	1.71 V	207	-3.00	31.30
5	*2406.00	84.9 PK	114.0	-29.1	1.71 V	207	53.50	31.40
6	*2406.00	48.2 AV	94.0	-45.8	1.71 V	207	16.80	31.40
7	4812.00	51.8 PK	74.0	-22.2	1.29 V	230	14.60	37.20
8	4812.00	15.1 AV	54.0	-38.9	1.29 V	230	-22.10	37.20

REMARKS:

1. Emission level (dBuV/m) = Raw Value (dBuV) + Correction Factor (dB/m).
2. Correction Factor (dB/m) = Antenna Factor (dB/m) + Cable Factor (dB).
3. The other emission levels were very low against the limit.
4. Margin value = Emission level – Limit value.
5. " * " : Fundamental frequency.
6. The average value of fundamental frequency is: Average = Peak value + 20log(Duty cycle) Where the duty factor is calculated from following formula:
 $20 \log (\text{Duty cycle}) = 20 \log (0.104 \times 14 \text{ ms} / 100 \text{ ms}) = -36.7 \text{ dB}$
 Please see page 17 for plotted duty.



EUT TEST CONDITION		MEASUREMENT DETAIL	
TEST CHANNEL	3	FREQUENCY RANGE	1 ~ 25GHz
INPUT POWER (SYSTEM)	5 Vdc	DETECTOR FUNCTION	Peak (PK) Average (AV)
ENVIRONMENTAL CONDITIONS	25deg. C, 65%RH	TESTED BY	Aska Huang

ANTENNA POLARITY & TEST DISTANCE: HORIZONTAL AT 3 M								
NO.	FREQ. (MHz)	EMISSION LEVEL (dBuV/m)	LIMIT (dBuV/m)	MARGIN (dB)	ANTENNA HEIGHT (m)	TABLE ANGLE (Degree)	RAW VALUE (dBuV)	CORRECTION FACTOR (dB/m)
1	*2440.00	85.7 PK	114.0	-28.3	1.06 H	154	54.20	31.50
2	*2440.00	49.0 AV	94.0	-45.0	1.06 H	154	17.50	31.50
3	4880.00	48.9 PK	74.0	-25.1	1.00 H	313	11.60	37.30
4	4880.00	12.2 AV	54.0	-41.8	1.00 H	313	-25.10	37.30
5	7320.00	60.1 PK	74.0	-13.9	1.59 H	124	16.60	43.50
6	7320.00	23.4 AV	54.0	-30.6	1.59 H	124	-20.10	43.50
ANTENNA POLARITY & TEST DISTANCE: VERTICAL AT 3 M								
NO.	FREQ. (MHz)	EMISSION LEVEL (dBuV/m)	LIMIT (dBuV/m)	MARGIN (dB)	ANTENNA HEIGHT (m)	TABLE ANGLE (Degree)	RAW VALUE (dBuV)	CORRECTION FACTOR (dB/m)
1	*2440.00	83.8 PK	114.0	-30.2	1.66 V	195	52.30	31.50
2	*2440.00	47.1 AV	94.0	-46.9	1.66 V	195	15.60	31.50
3	4880.00	51.2 PK	74.0	-22.8	1.27 V	223	13.90	37.30
4	4880.00	14.5 AV	54.0	-39.5	1.27 V	223	-22.80	37.30
5	7320.00	60.4 PK	74.0	-13.6	1.29 V	237	16.90	43.50
6	7320.00	23.7 AV	54.0	-30.3	1.29 V	237	-19.80	43.50

REMARKS:

1. Emission level (dBuV/m) = Raw Value (dBuV) + Correction Factor (dB/m).
2. Correction Factor (dB/m) = Antenna Factor (dB/m) + Cable Factor (dB).
3. The other emission levels were very low against the limit.
4. Margin value = Emission level – Limit value.
5. " * ": Fundamental frequency.
6. The average value of fundamental frequency is: Average = Peak value + 20log(Duty cycle) Where the duty factor is calculated from following formula:

$$20 \log (\text{Duty cycle}) = 20 \log (0.104 \times 14 \text{ ms} / 100 \text{ ms}) = -36.7 \text{ dB}$$
Please see page 17 for plotted duty.



EUT TEST CONDITION		MEASUREMENT DETAIL	
TEST CHANNEL	5	FREQUENCY RANGE	1 ~ 25GHz
INPUT POWER (SYSTEM)	5 Vdc	DETECTOR FUNCTION	Peak (PK) Average (AV)
ENVIRONMENTAL CONDITIONS	25deg. C, 65%RH	TESTED BY	Aska Huang

ANTENNA POLARITY & TEST DISTANCE: HORIZONTAL AT 3 M								
NO.	FREQ. (MHz)	EMISSION LEVEL (dBuV/m)	LIMIT (dBuV/m)	MARGIN (dB)	ANTENNA HEIGHT (m)	TABLE ANGLE (Degree)	RAW VALUE (dBuV)	CORRECTION FACTOR (dB/m)
1	*2478.00	84.0 PK	114.0	-30.0	1.04 H	155	52.40	31.60
2	*2478.00	47.3 AV	94.0	-46.7	1.04 H	155	15.70	31.60
3	2483.50	52.4 PK	74.0	-21.6	1.04 H	155	20.80	31.60
4	2483.50	28.4 AV	54.0	-25.6	1.04 H	155	-3.20	31.60
5	4956.00	52.4 PK	74.0	-21.6	1.01 H	354	14.90	37.50
6	4956.00	15.7 AV	54.0	-38.3	1.01 H	354	-21.80	37.50
ANTENNA POLARITY & TEST DISTANCE: VERTICAL AT 3 M								
NO.	FREQ. (MHz)	EMISSION LEVEL (dBuV/m)	LIMIT (dBuV/m)	MARGIN (dB)	ANTENNA HEIGHT (m)	TABLE ANGLE (Degree)	RAW VALUE (dBuV)	CORRECTION FACTOR (dB/m)
1	*2478.00	81.8 PK	114.0	-32.2	1.63 V	210	50.20	31.60
2	*2478.00	45.1 AV	94.0	-48.9	1.63 V	210	13.50	31.60
3	2483.50	50.1 PK	74.0	-23.9	1.63 V	210	18.50	31.60
4	2483.50	28.0 AV	54.0	-26.0	1.63 V	210	-3.60	31.60
5	4956.00	55.6 PK	74.0	-18.4	1.00 V	222	18.10	37.50
6	4956.00	18.9 AV	54.0	-35.1	1.00 V	222	-18.60	37.50

REMARKS:

1. Emission level (dBuV/m) = Raw Value (dBuV) + Correction Factor (dB/m).
2. Correction Factor (dB/m) = Antenna Factor (dB/m) + Cable Factor (dB).
3. The other emission levels were very low against the limit.
4. Margin value = Emission level – Limit value.
5. " * ": Fundamental frequency.
6. The average value of fundamental frequency is: Average = Peak value + 20log(Duty cycle) Where the duty factor is calculated from following formula:

$$20 \log (\text{Duty cycle}) = 20 \log (0.104 \times 14 \text{ ms} / 100 \text{ ms}) = -36.7 \text{ dB}$$
Please see page 17 for plotted duty.



A D T

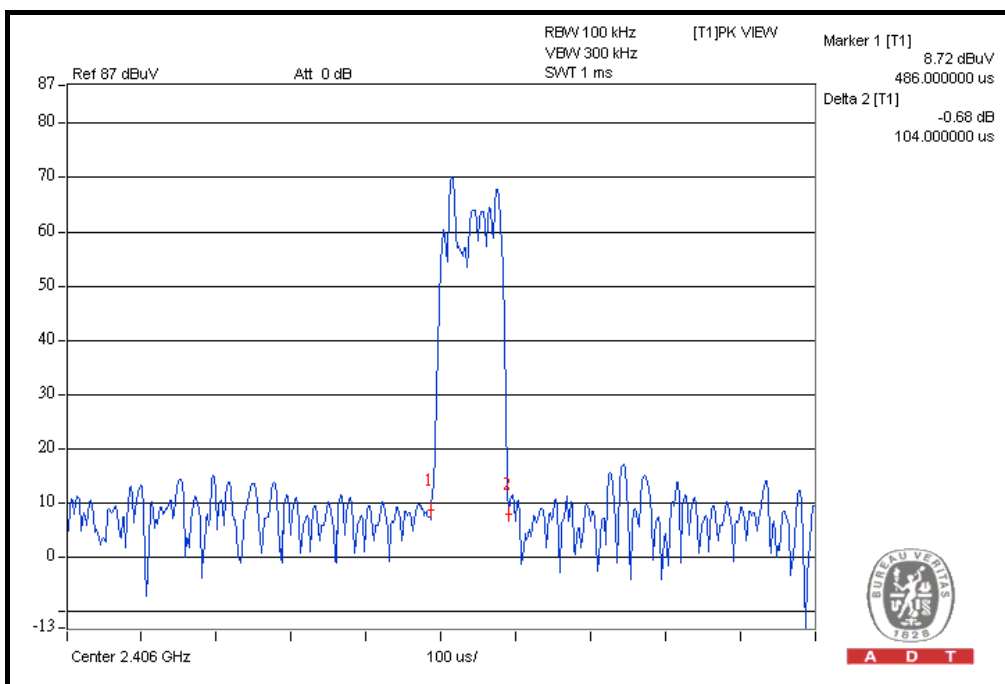

A D T

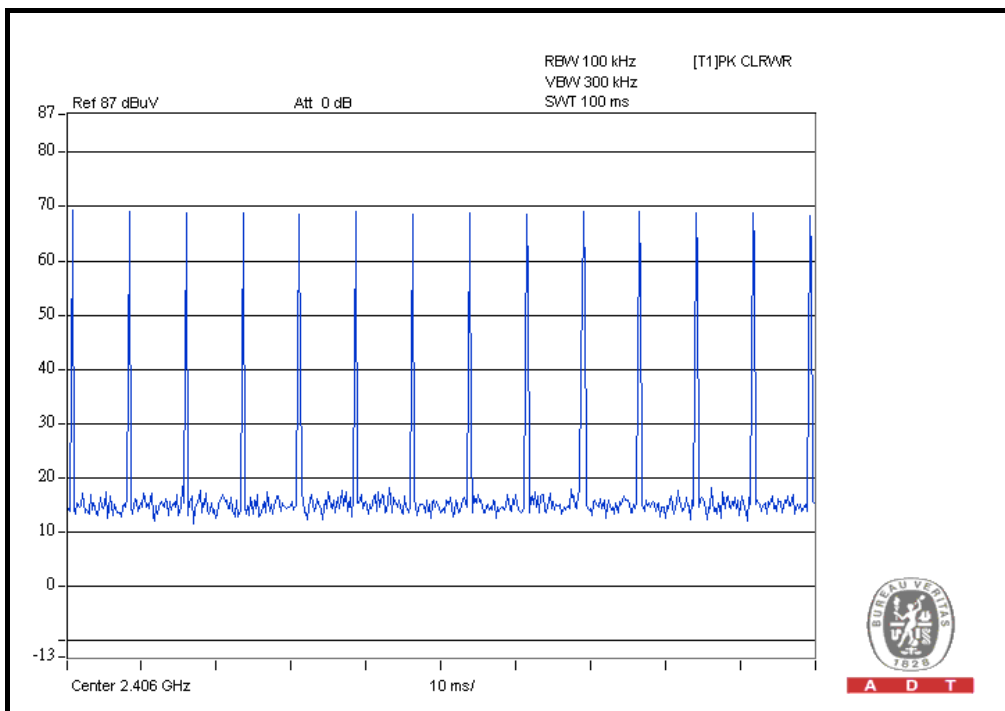

A D T

$$20 \log (\text{Duty cycle}) = 20 \log (0.104 \cdot 14 \text{ ms} / 100 \text{ ms}) = -36.7 \text{ dB}$$

**BELOW 1GHz WORST-CASE DATA**

EUT TEST CONDITION		MEASUREMENT DETAIL	
TEST CHANNEL	1	FREQUENCY RANGE	Below 1000MHz
INPUT POWER (SYSTEM)	5 Vdc	DETECTOR FUNCTION	Quasi-Peak
ENVIRONMENTAL CONDITIONS	23deg. C, 65%RH	TESTED BY	Antony Lee

ANTENNA POLARITY & TEST DISTANCE: HORIZONTAL AT 3 M								
NO.	FREQ. (MHz)	EMISSION LEVEL (dBuV/m)	LIMIT (dBuV/m)	MARGIN (dB)	ANTENNA HEIGHT (m)	TABLE ANGLE (Degree)	RAW VALUE (dBuV)	CORRECTION FACTOR (dB/m)
1	142.67	25.9 QP	43.5	-17.6	1.00 H	244	12.20	13.70
2	166.00	26.7 QP	43.5	-16.8	1.49 H	70	12.90	13.80
3	239.88	36.1 QP	46.0	-9.9	1.49 H	73	23.50	12.60
4	364.32	29.8 QP	46.0	-16.2	1.00 H	88	13.20	16.60
5	432.37	30.6 QP	46.0	-15.4	2.00 H	242	12.30	18.30
6	667.63	34.0 QP	46.0	-12.0	1.25 H	36	11.30	22.70
ANTENNA POLARITY & TEST DISTANCE: VERTICAL AT 3 M								
NO.	FREQ. (MHz)	EMISSION LEVEL (dBuV/m)	LIMIT (dBuV/m)	MARGIN (dB)	ANTENNA HEIGHT (m)	TABLE ANGLE (Degree)	RAW VALUE (dBuV)	CORRECTION FACTOR (dB/m)
1	72.67	25.5 QP	40.0	-14.5	1.99 V	109	13.80	11.70
2	142.67	24.9 QP	43.5	-18.6	1.00 V	240	11.20	13.70
3	232.11	24.8 QP	46.0	-21.2	1.00 V	295	12.50	12.30
4	335.15	27.6 QP	46.0	-18.4	1.49 V	83	11.70	15.90
5	432.37	29.4 QP	46.0	-16.6	1.00 V	168	11.10	18.30
6	665.68	29.6 QP	46.0	-16.4	1.49 V	190	6.90	22.70

REMARKS:

1. Emission level (dBuV/m) = Raw Value (dBuV) + Correction Factor (dB/m).
2. Correction Factor (dB/m) = Antenna Factor (dB/m) + Cable Factor (dB).
3. The other emission levels were very low against the limit.
4. Margin value = Emission level – Limit value.

4.2 CONDUCTED EMISSION MEASUREMENT

4.2.1 LIMITS OF CONDUCTED EMISSION MEASUREMENT

FREQUENCY OF EMISSION (MHz)	CONDUCTED LIMIT (dB μ V)	
	Quasi-peak	Average
0.15 ~ 0.5	66 to 56	56 to 46
0.5 ~ 5	56	46
5 ~ 30	60	50

- NOTE:** 1. The lower limit shall apply at the transition frequencies.
2. The limit decreases in line with the logarithm of the frequency in the range of 0.15 to 0.50MHz.
3. All emanations from a class A/B digital device or system, including any network of conductors and apparatus connected thereto, shall not exceed the level of field strengths specified above.

4.2.2 TEST INSTRUMENTS

DESCRIPTION & MANUFACTURER	MODEL NO.	SERIAL NO.	DATE OF CALIBRATION	DUE DATE OF CALIBRATION
Test Receiver ROHDE & SCHWARZ	ESCS30	100291	Nov. 23, 2011	Nov. 22, 2012
RF signal cable Woken	5D-FB	Cable-HYC01-01	Dec. 22, 2011	Dec. 21, 2012
LISN ROHDE & SCHWARZ (Peripheral)	ESH3-Z5	100312	Jul. 07, 2011	Jul. 06, 2012
LISN ROHDE & SCHWARZ (EUT)	ESH3-Z5	835239/001	Feb. 07, 2012	Feb. 06, 2013
Software ADT	BV ADT_Cond_ V7.3.7.3	NA	NA	NA

- NOTE:** 1. The calibration interval of the above test instruments is 12 months and the calibrations are traceable to NML/ROC and NIST/USA.
2. The test was performed in HwaYa Shielded Room 1.
3. The VCCI Site Registration No. is C-2040.

4.2.3 TEST PROCEDURES

- a. The EUT was placed 0.4 meters from the conducting wall of the shielded room with EUT being connected to the power mains through a line impedance stabilization network (LISN). Other support units were connected to the power mains through another LISN. The two LISNs provide 50 ohm/ 50uH of coupling impedance for the measuring instrument.
- b. Both lines of the power mains connected to the EUT were checked for maximum conducted interference.
- c. The frequency range from 150kHz to 30MHz was searched. Emission levels under (Limit - 20dB) was not recorded.

NOTE: All modes of operation were investigated and the worst-case emissions are reported.

4.2.4 DEVIATION FROM TEST STANDARD

No deviation.

4.2.5 TEST SETUP

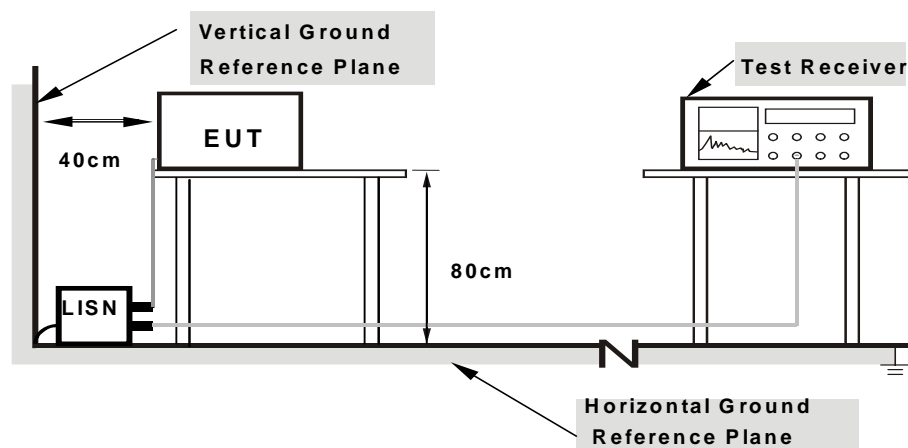

- Note:**
1. Support units were connected to second LISN.
 2. Both of LISNs (AMN) are 80 cm from EUT and at least 80 cm from other units and other metal planes

For the actual test configuration, please refer to the attached file (Test Setup Photo).

4.2.6 EUT OPERATING CONDITIONS

Same as 4.1.6.

4.2.7 TEST RESULTS

CONDUCTED WORST-CASE DATA :

PHASE	Line 1	6dB BANDWIDTH	9kHz
-------	--------	---------------	------

No	Freq. [MHz]	Corr. Factor (dB)	Reading Value		Emission Level		Limit		Margin	
			[dB (uV)]		[dB (uV)]		[dB (uV)]		(dB)	
			Q.P.	AV.	Q.P.	AV.	Q.P.	AV.	Q.P.	AV.
1	0.15000	0.11	49.90	35.66	50.01	35.77	66.00	56.00	-15.99	-20.23
2	0.17734	0.12	48.26	46.50	48.38	46.62	64.61	54.61	-16.23	-7.99
3	0.19687	0.13	45.38	33.79	45.51	33.92	63.74	53.74	-18.23	-19.82
4	0.23594	0.13	39.65	39.57	39.78	39.70	62.24	52.24	-22.46	-12.54
5	0.30625	0.13	35.74	10.71	35.87	10.84	60.07	50.07	-24.20	-39.23
6	2.42841	0.25	31.57	23.11	31.82	23.36	56.00	46.00	-24.18	-22.64
7	3.84766	0.33	34.48	23.67	34.81	24.00	56.00	46.00	-21.19	-22.00

REMARKS:

1. Q.P. and AV. are abbreviations of quasi-peak and average individually.
2. The emission levels of other frequencies were very low against the limit.
3. Margin value = Emission level - Limit value
4. Correction factor = Insertion loss + Cable loss
5. Emission Level = Correction Factor + Reading Value.

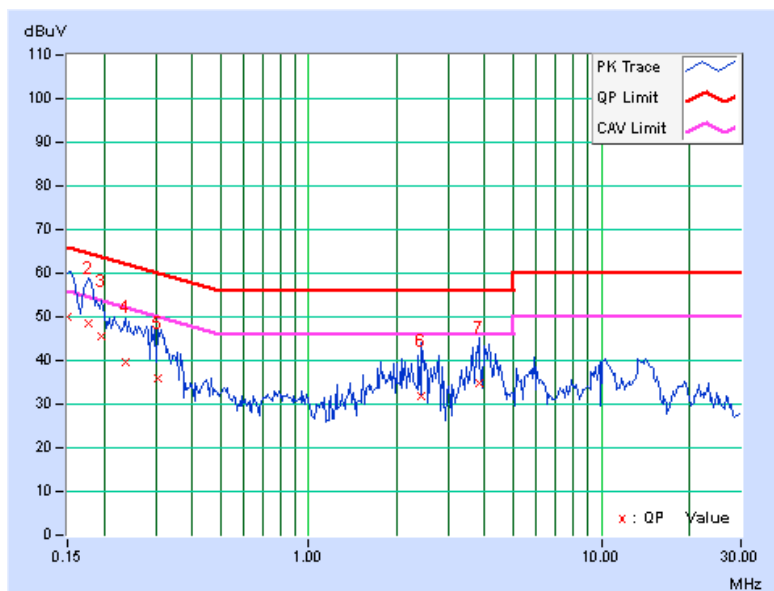

PHASE	Line 2	6dB BANDWIDTH	9kHz
-------	--------	---------------	------

No	Freq. [MHz]	Corr. Factor (dB)	Reading Value		Emission Level		Limit		Margin	
			[dB (uV)]		[dB (uV)]		[dB (uV)]		(dB)	
			Q.P.	AV.	Q.P.	AV.	Q.P.	AV.	Q.P.	AV.
1	0.15000	0.12	53.14	21.92	53.26	22.04	66.00	56.00	-12.74	-33.96
2	0.17344	0.13	52.17	38.25	52.30	38.38	64.79	54.79	-12.49	-16.41
3	0.18906	0.14	50.23	37.43	50.37	37.57	64.08	54.08	-13.71	-16.51
4	0.23594	0.14	41.05	39.32	41.19	39.46	62.24	52.24	-21.05	-12.78
5	0.88047	0.20	31.48	15.25	31.68	15.45	56.00	46.00	-24.32	-30.55
6	3.72656	0.33	33.55	19.85	33.88	20.18	56.00	46.00	-22.12	-25.82

REMARKS:

1. Q.P. and AV. are abbreviations of quasi-peak and average individually.
2. The emission levels of other frequencies were very low against the limit.
3. Margin value = Emission level - Limit value
4. Correction factor = Insertion loss + Cable loss
5. Emission Level = Correction Factor + Reading Value.

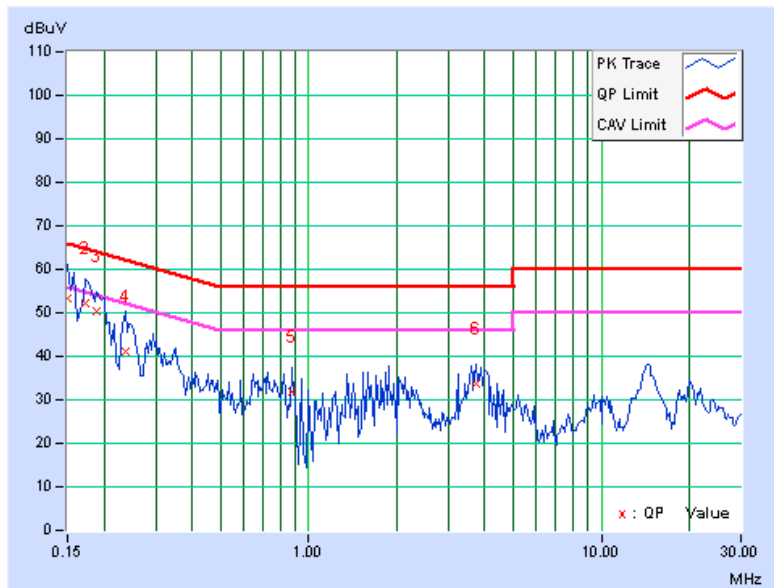

5. PHOTOGRAPHS OF THE TEST CONFIGURATION

Please refer to the attached file (Test Setup Photo).



6. INFORMATION ON THE TESTING LABORATORIES

We, Bureau Veritas Consumer Products Services (H.K.) Ltd., Taoyuan Branch, were founded in 1988 to provide our best service in EMC, Radio, Telecom and Safety consultation. Our laboratories are accredited and approved according to ISO/IEC 17025.

If you have any comments, please feel free to contact us at the following:

Linko EMC/RF Lab

Tel: 886-2-26052180

Fax: 886-2-26051924

Hsin Chu EMC/RF Lab

Tel: 886-3-5935343

Fax: 886-3-5935342

Hwa Ya EMC/RF/Safety/Telecom Lab

Tel: 886-3-3183232

Fax: 886-3-3270892

Email: service.adt@tw.bureauveritas.com

Web Site: www.adt.com.tw

The address and road map of all our labs can be found in our web site also.

7. APPENDIX A – MODIFICATION RECORDERS FOR ENGINEERING CHANGES TO THE EUT BY THE LAB

No any modifications are made to the EUT by the lab during the test.

---END---