



A D T

FCC TEST REPORT

REPORT NO.: RF120430C12
MODEL NO.: BSMBW12H
FCC ID: FDIBSMBW12H-0
RECEIVED: Apr. 30, 2012
TESTED: Jun. 25 ~ Jul. 02, 2012
ISSUED: Jul. 04, 2012

APPLICANT: BUFFALO INC.

ADDRESS: AKAMONDORI Bldg., 30-20, Ohsu 3-chome,
Naka-Ku, Nagoya 460-8315, Japan

ISSUED BY: Bureau Veritas Consumer Products Services
(H.K.) Ltd., Taoyuan Branch

LAB ADDRESS: No. 47, 14th Ling, Chia Pau Vil., Lin Kou Dist.,
New Taipei City, Taiwan, R.O.C.

TEST LOCATION: No. 19, Hwa Ya 2nd Rd, Wen Hwa Tsuen, Kwei
Shan Hsiang, Taoyuan Hsien 333, Taiwan, R.O.C.

This report should not be used by the client to claim product certification, approval, or endorsement by TAF or any government agencies.



This report is for your exclusive use. Any copying or replication of this report to or for any other person or entity, or use of our name or trademark, is permitted only with our prior written permission. This report sets forth our findings solely with respect to the test samples identified herein. The results set forth in this report are not indicative or representative of the quality or characteristics of the lot from which a test sample was taken or any similar or identical product unless specifically and expressly noted. Our report includes all of the tests requested by you and the results thereof based upon the information that you provided to us. You have 60 days from date of issuance of this report to notify us of any material error or omission caused by our negligence, provided, however, that such notice shall be in writing and shall specifically address the issue you wish to raise. A failure to raise such issue within the prescribed time shall constitute your unqualified acceptance of the completeness of this report, the tests conducted and the correctness of the report contents. Unless specific mention, the uncertainty of measurement has been explicitly taken into account to declare the compliance or non-compliance to the specification.



Table of Contents

RELEASE CONTROL RECORD	3
1. CERTIFICATION	4
2. SUMMARY OF TEST RESULTS	5
2.1 MEASUREMENT UNCERTAINTY	5
3. GENERAL INFORMATION	6
3.1 GENERAL DESCRIPTION OF EUT	6
3.2 DESCRIPTION OF TEST MODES	7
3.2.1 TEST MODE APPLICABILITY AND TESTED CHANNEL DETAIL	8
3.3 DESCRIPTION OF SUPPORT UNITS	9
3.3.1 CONFIGURATION OF SYSTEM UNDER TEST	10
3.4 GENERAL DESCRIPTION OF APPLIED STANDARDS	10
4. TEST TYPES AND RESULTS	11
4.1 RADIATED EMISSION AND BAND EDGE MEASUREMENT	11
4.1.1 LIMITS OF RADIATED EMISSION AND BAND EDGE MEASUREMENT	11
4.1.2 TEST INSTRUMENTS	12
4.1.3 TEST PROCEDURES	13
4.1.4 DEVIATION FROM TEST STANDARD	13
4.1.5 TEST SETUP	14
4.1.6 EUT OPERATING CONDITIONS	14
4.1.7 TEST RESULTS	15
4.2 CONDUCTED EMISSION MEASUREMENT	20
4.2.1 LIMITS OF CONDUCTED EMISSION MEASUREMENT	20
4.2.2 TEST INSTRUMENTS	20
4.2.3 TEST PROCEDURES	21
4.2.4 DEVIATION FROM TEST STANDARD	21
4.2.5 TEST SETUP	21
4.2.6 EUT OPERATING CONDITIONS	21
4.2.7 TEST RESULTS	22
5. PHOTOGRAPHS OF THE TEST CONFIGURATION	24
6. INFORMATION ON THE TESTING LABORATORIES	25
7. APPENDIX A – MODIFICATION RECORDERS FOR ENGINEERING CHANGES TO THE EUT BY THE LAB	26



A D T

RELEASE CONTROL RECORD

ISSUE NO.	REASON FOR CHANGE	DATE ISSUED
RF120430C12	Original release	Jul. 04, 2012



1. CERTIFICATION

PRODUCT: 2.4G Blue LED Mouse

MODEL NO.: BSMBW12H

BRAND: iBUFFALO

APPLICANT: BUFFALO INC.

TESTED: Jun. 25 ~ Jul. 02, 2012

TEST SAMPLE: ENGINEERING SAMPLE

STANDARDS: FCC Part 15, Subpart C (Section 15.249)

ANSI C63.10-2009

The above equipment (model: BSMBW12H) has been tested by **Bureau Veritas Consumer Products Services (H.K.) Ltd., Taoyuan Branch**, and found compliance with the requirement of the above standards. The test record, data evaluation & Equipment Under Test (EUT) configurations represented herein are true and accurate accounts of the measurements of the sample's EMC characteristics under the conditions specified in this report.

PREPARED BY :  , DATE : Jul. 04, 2012
Pettie Chen / Specialist

APPROVED BY :  , DATE : Jul. 04, 2012
Gary Chang / Technical Manager



A D T

2. SUMMARY OF TEST RESULTS

The EUT has been tested according to the following specifications:

APPLIED STANDARD: FCC Part 15, Subpart C (Section 15.249)			
STANDARD PARAGRAPH	TEST TYPE	RESULT	REMARK
15.207	Conducted Emission Test	PASS	Meet the requirement of limit. Minimum passing margin is -5.24dB at 0.50000MHz.
15.209 15.249 15.249 (d)	Radiated Emission Test Band Edge Measurement Limit: 50dB less than the peak value of fundamental frequency or meet radiated emission limit in section 15.209	PASS	Meet the requirement of limit. Minimum passing margin is -3.2dB at 68.80MHz.

2.1 MEASUREMENT UNCERTAINTY

Where relevant, the following measurement uncertainty levels have been estimated for tests performed on the EUT as specified in CISPR 16-4-2:

MEASUREMENT	FREQUENCY	UNCERTAINTY
Conducted emissions	9kHz~30MHz	2.44 dB
Radiated emission	30MHz ~ 200MHz	3.19 dB
	200MHz ~1000MHz	3.21 dB
	1GHz ~ 18GHz	2.26 dB
	18GHz ~ 40GHz	1.94 dB

This uncertainty represents an expanded uncertainty expressed at approximately the 95% confidence level using a coverage factor of k=2.

3. GENERAL INFORMATION

3.1 GENERAL DESCRIPTION OF EUT

EUT	2.4G Blue LED Mouse
MODEL NO.	BSMBW12H
POWER SUPPLY	3.7Vdc from battery 5.0Vdc from host equipment
MODULATION TYPE	FSK
OPERATING FREQUENCY	2405 ~ 2477MHz
NUMBER OF CHANNEL	12
ANTENNA TYPE	PCB antenna with -9.76dBi gain
DATA CABLE	1.0m non-shielded USB cable without core 6.5cm non-shielded USB cable without core (Note 2)
I/O PORT	USB
ACCESSORY DEVICES	Receiver of 2.4G Blue LED Mouse (Brand: iBUFFALO, Model: BSMBW12H-R)

NOTE:

1. This EUT has transmission function when charging.
2. The EUT was pre-tested under following conditions, condition 2 is found to be the worst for the final test.

Condition	Test Model
1	EUT Standalone
2	EUT connected with Notebook via 1.0m USB cable
3	EUT connected with Notebook via 6.5cm USB cable

3. The above EUT information is declared by manufacturer and for more detailed feature description, please refer to the manufacturer's specifications or user's manual.

3.2 DESCRIPTION OF TEST MODES

12 channels are provided to this EUT:

Channel	Freq. (MHz)
1	2405
2	2434
3	2472
4	2419
5	2439
6	2448
7	2427
8	2457
9	2477
10	2417
11	2432
12	2468



3.2.1 TEST MODE APPLICABILITY AND TESTED CHANNEL DETAIL

EUT CONFIGURE MODE	APPLICABLE TO				DESCRIPTION
	RE \geq 1G	RE $<$ 1G	PLC	BM	
-	√	√	√	√	-

Where **RE $<$ 1G**: Radiated Emission below 1GHz **RE \geq 1G**: Radiated Emission above 1GHz
PLC: Power Line Conducted Emission **BM**: Bandedge Measurement

RADIATED EMISSION TEST (ABOVE 1 GHz):

- Pre-Scan has been conducted to determine the worst-case mode from all possible combinations between available modulations axis and antenna ports (if EUT with antenna diversity architecture).
- Following channel(s) was (were) selected for the final test as listed below.

EUT CONFIGURE MODE	OPERATING FREQUENCY(MHz)	TESTED FREQUENCY (MHz)	MODULATION TYPE
-	2405 ~ 2477	2405, 2448, 2477	FSK

RADIATED EMISSION TEST (BELOW 1 GHz):

- Pre-Scan has been conducted to determine the worst-case mode from all possible combinations between available modulations axis and antenna ports (if EUT with antenna diversity architecture).
- Following channel(s) was (were) selected for the final test as listed below.

EUT CONFIGURE MODE	OPERATING FREQUENCY(MHz)	TESTED FREQUENCY (MHz)	MODULATION TYPE
-	2405 ~ 2477	2448	FSK

*After pre-testing standalone and charging condition, the charging condition was the worst case for the final test.

POWER LINE CONDUCTED EMISSION TEST:

- Pre-Scan has been conducted to determine the worst-case mode from all possible combinations between available modulations, data rates and antenna ports (if EUT with antenna diversity architecture).
- Following channel(s) was (were) selected for the final test as listed below.

EUT CONFIGURE MODE	OPERATING FREQUENCY(MHz)	TESTED FREQUENCY (MHz)	MODULATION TYPE
-	2405 ~ 2477	2448	FSK



BANDEDGE MEASUREMENT:

- Pre-Scan has been conducted to determine the worst-case mode from all possible combinations between available modulations and antenna ports (if EUT with antenna diversity architecture).
- Following channel(s) was (were) selected for the final test as listed below.

EUT CONFIGURE MODE	OPERATING FREQUENCY(MHz)	TESTED FREQUENCY (MHz)	MODULATION TYPE
-	2405 ~ 2477	2405, 2477	FSK

TEST CONDITION:

APPLICABLE TO	ENVIRONMENTAL CONDITIONS	INPUT POWER (SYSTEM)	TESTED BY
RE≥1G	22deg. C, 70%RH	120Vac, 60Hz	Anderson Hong
RE<1G	25deg. C, 65%RH	120Vac, 60Hz	Sun Lin
PLC	25deg. C, 68%RH	120Vac, 60Hz	Anderson Hong
BM	22deg. C, 70%RH	120Vac, 60Hz	Anderson Hong

3.3 DESCRIPTION OF SUPPORT UNITS

The EUT has been tested as an independent unit together with other necessary accessories or support units. The following support units or accessories were used to form a representative test configuration during the tests.

NO.	PRODUCT	BRAND	MODEL NO.	SERIAL NO.	FCC ID
1	Notebook	DELL	E5410	1HC2XM1	FCC DoC Approved

NO.	SIGNAL CABLE DESCRIPTION OF THE ABOVE SUPPORT UNITS
1	NA

NOTE: All power cords of the above support units are non shielded (1.8m).

3.3.1 CONFIGURATION OF SYSTEM UNDER TEST

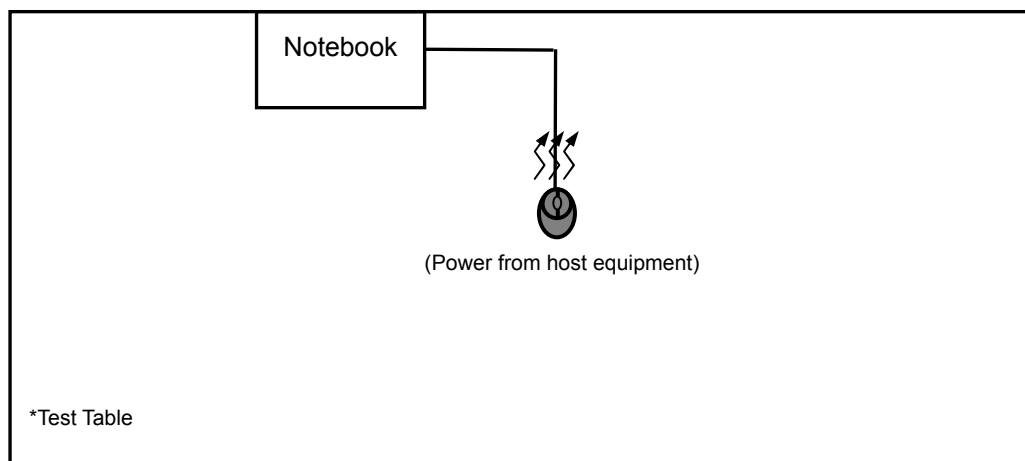

3.4 GENERAL DESCRIPTION OF APPLIED STANDARDS

The EUT is a RF Product. According to the specifications of the manufacturer, it must comply with the requirements of the following standards:

FCC Part 15, Subpart C (Section 15.249)

ANSI C63.10-2009

All test items have been performed and recorded as per the above standards.

NOTE: The EUT is also considered as a kind of computer peripheral, because the connection to computer is necessary for typical use. It has been verified to comply with the requirements of FCC Part 15, Subpart B, Class B (DoC). The test report has been issued separately.

4. TEST TYPES AND RESULTS

4.1 RADIATED EMISSION AND BAND EDGE MEASUREMENT

4.1.1 LIMITS OF RADIATED EMISSION AND BAND EDGE MEASUREMENT

The field strength of emissions from intentional radiators operated within these frequency bands shall comply with the following

Fundamental Frequency	Field Strength of Fundamental (millivolts/meter)	Field Strength of Harmonics (microvolts/meter)
902 ~ 928 MHz	50	500
2400 ~ 2483.5 MHz	50	500
5725 ~ 5875 MHz	50	500
24 ~ 24.25 GHz	250	2500

Emissions radiated outside of the specified frequency bands, except for harmonics, shall be attenuated by at least 50 dB below the level of the fundamental or to the general radiated emission limits as below table, whichever is the lesser attenuation

Frequencies (MHz)	Field strength (microvolts/meter)	Measurement distance (meters)
0.009 ~ 0.490	2400/F(kHz)	300
0.490 ~ 1.705	24000/F(kHz)	30
1.705 ~ 30.0	30	30
30 ~ 88	100	3
88 ~ 216	150	3
216 ~ 960	200	3
Above 960	500	3

NOTE:

1. The lower limit shall apply at the transition frequencies.
2. Emission level (dBuV/m) = 20 log Emission level (uV/m).
3. For frequencies above 1000MHz, the field strength limits are based on average detector, however, the peak field strength of any emission shall not exceed the maximum permitted average limits, specified above by more than 20dB under any condition of modulation.



4.1.2 TEST INSTRUMENTS

DESCRIPTION & MANUFACTURER	MODEL NO.	SERIAL NO.	DATE OF CALIBRATION	DUE DATE OF CALIBRATION
Test Receiver ROHDE & SCHWARZ	ESCI	100744	Apr. 19, 2012	Apr. 18, 2013
Spectrum Analyzer ROHDE & SCHWARZ	FSP40	100040	Aug. 04, 2011	Aug. 03, 2012
BILOG Antenna SCHWARZBECK	VULB9168	9168-156	Apr. 03, 2012	Apr. 02, 2013
HORN Antenna SCHWARZBECK	BBHA 9120 D	9120D-563	Sep. 06, 2011	Sep. 05, 2012
HORN Antenna SCHWARZBECK	BBHA 9170	148	Jul. 20, 2011	Jul. 19, 2012
Loop Antenna	HFH2-Z2	100070	Jan. 31, 2012	Jan. 30, 2014
Preamplifier Agilent	8449B	3008A01911	Oct. 29, 2011	Oct. 28, 2012
Preamplifier Agilent	8447D	2944A10638	Oct. 29, 2011	Oct. 28, 2012
RF signal cable HUBER+SUHNNER	SUCOFLEX 104	295013/4 283403/4	Aug. 19, 2011	Aug. 18, 2012
RF signal cable Worken	8D-FB	Cable-HYCH9-01	Aug. 13, 2011	Aug. 12, 2012
Software	ADT_Radiated_ V7.6.15.9.2	NA	NA	NA
Antenna Tower EMCO	2070/2080	512.835.4684	NA	NA
Turn Table EMCO	2087-2.03	NA	NA	NA
Antenna Tower & Turn Table Controller EMCO	2090	NA	NA	NA

- NOTE:**
1. The calibration interval of the above test instruments is 12 months and the calibrations are traceable to NML/ROC and NIST/USA.
 2. The calibration interval of the loop antenna is 24 months and the calibrations are traceable to NML/ROC and NIST/USA.
 3. The test was performed in HwaYa Chamber 9.
 4. The horn antenna and HP preamplifier (model: 8449B) are used only for the measurement of emission frequency above 1GHz if tested.
 5. The FCC Site Registration No. is 460141.
 6. The IC Site Registration No. is IC 7450F-4.

4.1.3 TEST PROCEDURES

- a. The EUT was placed on the top of a rotating table 0.8 meters above the ground at a 3 meter semi-anechoic chamber. The table was rotated 360 degrees to determine the position of the highest radiation.
- b. The EUT was set 3 meters away from the interference-receiving antenna, which was mounted on the top of a variable-height antenna tower.
- c. The antenna is a broadband antenna, and its height is varied from one meter to four meters above the ground to determine the maximum value of the field strength. Both horizontal and vertical polarizations of the antenna are set to make the measurement.
- d. For each suspected emission, the EUT was arranged to its worst case and then the antenna was tuned to heights from 1 meter to 4 meters and the rotatable table was turned from 0 degrees to 360 degrees to find the maximum reading.
- e. The test-receiver system was set to Peak Detect Function and Specified Bandwidth with Maximum Hold Mode.
- f. If the emission level of the EUT in peak mode was lower than the limit specified, then testing could be stopped and the peak values of the EUT would be reported. Otherwise the emissions would be re-tested one by one using peak, quasi-peak or average method as specified and then reported in a data sheet.

NOTE:

1. The resolution bandwidth and video bandwidth of test receiver/spectrum analyzer is 120kHz for Quasi-peak detection at frequency below 1GHz.
2. The resolution bandwidth of test receiver/spectrum analyzer is 1MHz and video bandwidth is 3MHz for Peak detection at frequency above 1GHz.
3. All modes of operation were investigated and the worst-case emissions are reported.

4.1.4 DEVIATION FROM TEST STANDARD

No deviation.

4.1.5 TEST SETUP

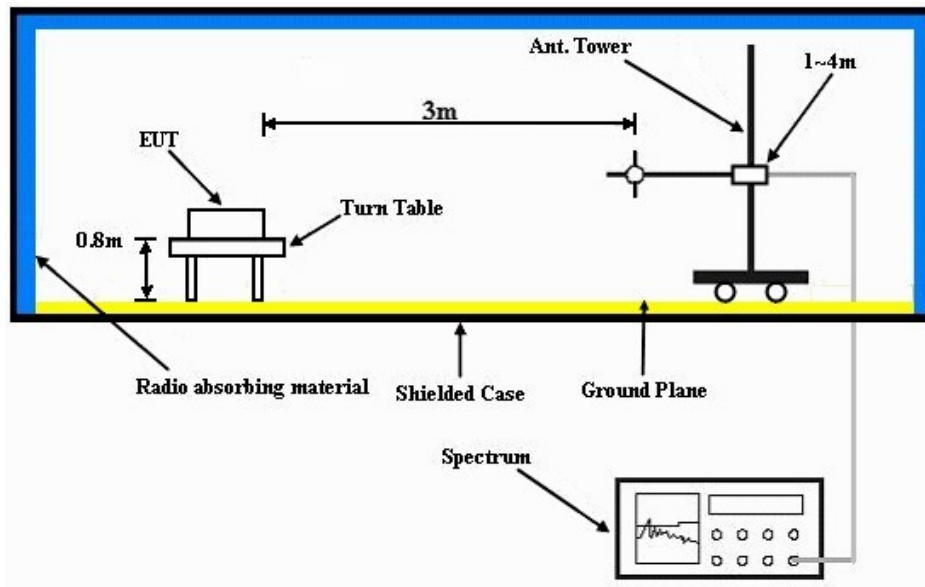

For the actual test configuration, please refer to the attached file (Test Setup Photo).

4.1.6 EUT OPERATING CONDITIONS

Set the EUT under charging and transmission condition continuously at specific channel frequency.



4.1.7 TEST RESULTS

ABOVE 1GHz DATA

EUT TEST CONDITION		MEASUREMENT DETAIL	
CHANNEL	Channel 1	FREQUENCY RANGE	1 ~ 25GHz
INPUT POWER (SYSTEM)	120Vac, 60 Hz	DETECTOR FUNCTION	Peak (PK) Average (AV)
ENVIRONMENTAL CONDITIONS	25deg. C, 65%RH	TESTED BY	Anderson Hong

ANTENNA POLARITY & TEST DISTANCE: HORIZONTAL AT 3 M								
NO.	FREQ. (MHz)	EMISSION LEVEL (dBuV/m)	LIMIT (dBuV/m)	MARGIN (dB)	ANTENNA HEIGHT (m)	TABLE ANGLE (Degree)	RAW VALUE (dBuV)	CORRECTION FACTOR (dB/m)
1	2390.00	37.7 PK	74.0	-36.3	1.47 H	169	6.30	31.40
2	2390.00	25.0 AV	54.0	-29.0	1.47 H	169	-6.40	31.40
3	2393.00	44.2 PK	74.0	-29.8	1.47 H	169	12.80	31.40
4	2393.00	30.9 AV	54.0	-23.1	1.47 H	169	-0.50	31.40
5	2400.00	37.5 PK	74.0	-36.5	1.47 H	169	6.10	31.40
6	2400.00	6.8 AV	54.0	-47.2	1.47 H	169	-24.60	31.40
7	*2405.00	78.7 PK	114.0	-35.3	1.47 H	169	47.30	31.40
8	*2405.00	48.0 AV	94.0	-46.0	1.47 H	169	16.60	31.40
9	4810.00	49.8 PK	74.0	-24.2	1.07 H	31	12.40	37.40
10	4810.00	19.1 AV	54.0	-34.9	1.07 H	31	-18.30	37.40
ANTENNA POLARITY & TEST DISTANCE: VERTICAL AT 3 M								
NO.	FREQ. (MHz)	EMISSION LEVEL (dBuV/m)	LIMIT (dBuV/m)	MARGIN (dB)	ANTENNA HEIGHT (m)	TABLE ANGLE (Degree)	RAW VALUE (dBuV)	CORRECTION FACTOR (dB/m)
1	2390.00	54.6 PK	74.0	-19.4	1.20 V	100	23.20	31.40
2	2390.00	43.2 AV	54.0	-10.8	1.20 V	100	11.80	31.40
3	2393.00	41.7 PK	74.0	-32.3	1.20 V	100	10.30	31.40
4	2393.00	27.5 AV	54.0	-26.5	1.20 V	100	-3.90	31.40
5	2400.00	32.9 PK	74.0	-41.1	1.20 V	100	1.50	31.40
6	2400.00	2.2 AV	54.0	-51.8	1.20 V	100	-29.20	31.40
7	*2405.00	75.7 PK	114.0	-38.3	1.20 V	100	44.30	31.40
8	*2405.00	45.0 AV	94.0	-49.0	1.20 V	100	13.60	31.40
9	4810.00	49.7 PK	74.0	-24.3	1.00 V	3	12.30	37.40
10	4810.00	19.0 AV	54.0	-35.0	1.00 V	3	-18.40	37.40

REMARKS: 1. Emission level (dBuV/m) = Raw Value (dBuV) + Correction Factor (dB/m).

2. Correction Factor (dB/m) = Antenna Factor (dB/m) + Cable Factor (dB).

3. The other emission levels were very low against the limit.

4. Margin value = Emission level – Limit value.

5. “ * ” : Fundamental frequency

6. The average value of fundamental frequency is: Average = Peak value + 20log(Duty cycle) Where the duty factor is calculated from following formula:

$$20 \log (\text{Duty cycle}) = 20 \log (13 \times 0.224 \text{ ms} / 100 \text{ ms}) = -30.7 \text{ dB}$$

Please see page 18 for plotted duty.



EUT TEST CONDITION		MEASUREMENT DETAIL	
CHANNEL	Channel 6	FREQUENCY RANGE	1 ~ 25GHz
INPUT POWER (SYSTEM)	120Vac, 60 Hz	DETECTOR FUNCTION	Peak (PK) Average (AV)
ENVIRONMENTAL CONDITIONS	25deg. C, 65%RH	TESTED BY	Anderson Hong

ANTENNA POLARITY & TEST DISTANCE: HORIZONTAL AT 3 M								
NO.	FREQ. (MHz)	EMISSION LEVEL (dBuV/m)	LIMIT (dBuV/m)	MARGIN (dB)	ANTENNA HEIGHT (m)	TABLE ANGLE (Degree)	RAW VALUE (dBuV)	CORRECTION FACTOR (dB/m)
1	*2448.00	80.7 PK	114.0	-33.3	1.32 H	245	49.10	31.60
2	*2448.00	50.0 AV	94.0	-44.0	1.32 H	245	18.40	31.60
3	4896.00	48.2 PK	74.0	-25.8	1.00 H	98	10.60	37.60
4	4896.00	17.5 AV	54.0	-36.5	1.00 H	98	-20.10	37.60
5	7344.00	51.2 PK	74.0	-22.8	1.58 H	35	7.40	43.80
6	7344.00	20.5 AV	54.0	-33.5	1.58 H	35	-23.30	43.80
ANTENNA POLARITY & TEST DISTANCE: VERTICAL AT 3 M								
NO.	FREQ. (MHz)	EMISSION LEVEL (dBuV/m)	LIMIT (dBuV/m)	MARGIN (dB)	ANTENNA HEIGHT (m)	TABLE ANGLE (Degree)	RAW VALUE (dBuV)	CORRECTION FACTOR (dB/m)
1	*2448.00	75.4 PK	114.0	-38.6	1.48 V	285	43.80	31.60
2	*2448.00	44.7 AV	94.0	-49.3	1.48 V	285	13.10	31.60
3	4896.00	48.4 PK	74.0	-25.6	1.00 V	352	10.80	37.60
4	4896.00	17.7 AV	54.0	-36.3	1.00 V	352	-19.90	37.60
5	7344.00	54.4 PK	74.0	-19.6	1.60 V	350	10.60	43.80
6	7344.00	23.7 AV	54.0	-30.3	1.60 V	350	-20.10	43.80

- REMARKS:**
- Emission level (dBuV/m) = Raw Value (dBuV) + Correction Factor (dB/m).
 - Correction Factor (dB/m) = Antenna Factor (dB/m) + Cable Factor (dB).
 - The other emission levels were very low against the limit.
 - Margin value = Emission level – Limit value.
 - * * : Fundamental frequency
 - The average value of fundamental frequency is: Average = Peak value + 20log(Duty cycle) Where the duty factor is calculated from following formula:
 $20 \log (\text{Duty cycle}) = 20 \log (13 \times 0.224 \text{ ms} / 100 \text{ ms}) = -30.7 \text{ dB}$
Please see page 18 for plotted duty.



A D T

EUT TEST CONDITION		MEASUREMENT DETAIL	
CHANNEL	Channel 9	FREQUENCY RANGE	1 ~ 25GHz
INPUT POWER (SYSTEM)	120Vac, 60 Hz	DETECTOR FUNCTION	Peak (PK) Average (AV)
ENVIRONMENTAL CONDITIONS	25deg. C, 65%RH	TESTED BY	Anderson Hong

ANTENNA POLARITY & TEST DISTANCE: HORIZONTAL AT 3 M								
NO.	FREQ. (MHz)	EMISSION LEVEL (dBuV/m)	LIMIT (dBuV/m)	MARGIN (dB)	ANTENNA HEIGHT (m)	TABLE ANGLE (Degree)	RAW VALUE (dBuV)	CORRECTION FACTOR (dB/m)
1	*2477.00	79.9 PK	114.0	-34.1	1.34 H	239	48.20	31.70
2	*2477.00	49.2 AV	94.0	-44.8	1.34 H	239	17.50	31.70
3	2483.50	35.8 PK	74.0	-38.2	1.34 H	239	4.10	31.70
4	2483.50	5.1 AV	54.0	-48.9	1.34 H	239	-26.60	31.70
5	2485.50	40.8 PK	74.0	-33.2	1.34 H	239	9.10	31.70
6	2485.50	25.9 AV	54.0	-28.1	1.34 H	239	-5.80	31.70
7	4954.00	48.5 PK	74.0	-25.5	1.02 H	107	10.70	37.80
8	4954.00	17.8 AV	54.0	-36.2	1.02 H	107	-20.00	37.80
ANTENNA POLARITY & TEST DISTANCE: VERTICAL AT 3 M								
NO.	FREQ. (MHz)	EMISSION LEVEL (dBuV/m)	LIMIT (dBuV/m)	MARGIN (dB)	ANTENNA HEIGHT (m)	TABLE ANGLE (Degree)	RAW VALUE (dBuV)	CORRECTION FACTOR (dB/m)
1	*2477.00	74.2 PK	114.0	-39.8	1.39 V	284	42.50	31.70
2	*2477.00	43.5 AV	94.0	-50.5	1.39 V	284	11.80	31.70
3	2483.50	31.2 PK	74.0	-42.8	1.39 V	284	-0.50	31.70
4	2483.50	0.5 AV	54.0	-53.5	1.39 V	284	-31.20	31.70
5	2485.50	42.8 PK	74.0	-31.2	1.39 V	284	11.10	31.70
6	2485.50	25.5 AV	54.0	-28.5	1.39 V	284	-6.20	31.70
7	4954.00	54.7 PK	74.0	-19.3	1.52 V	347	16.90	37.80
8	4954.00	24.0 AV	54.0	-30.0	1.52 V	347	-13.80	37.80

- REMARKS:**
1. Emission level (dBuV/m) = Raw Value (dBuV) + Correction Factor (dB/m).
 2. Correction Factor (dB/m) = Antenna Factor (dB/m) + Cable Factor (dB).
 3. The other emission levels were very low against the limit.
 4. Margin value = Emission level – Limit value.
 5. “ * “ : Fundamental frequency
 6. The average value of fundamental frequency is: Average = Peak value + 20log(Duty cycle) Where the duty factor is calculated from following formula:
 $20 \log (\text{Duty cycle}) = 20 \log (13 \times 0.224 \text{ ms} / 100 \text{ ms}) = -30.7 \text{ dB}$
Please see page 18 for plotted duty.



A D T

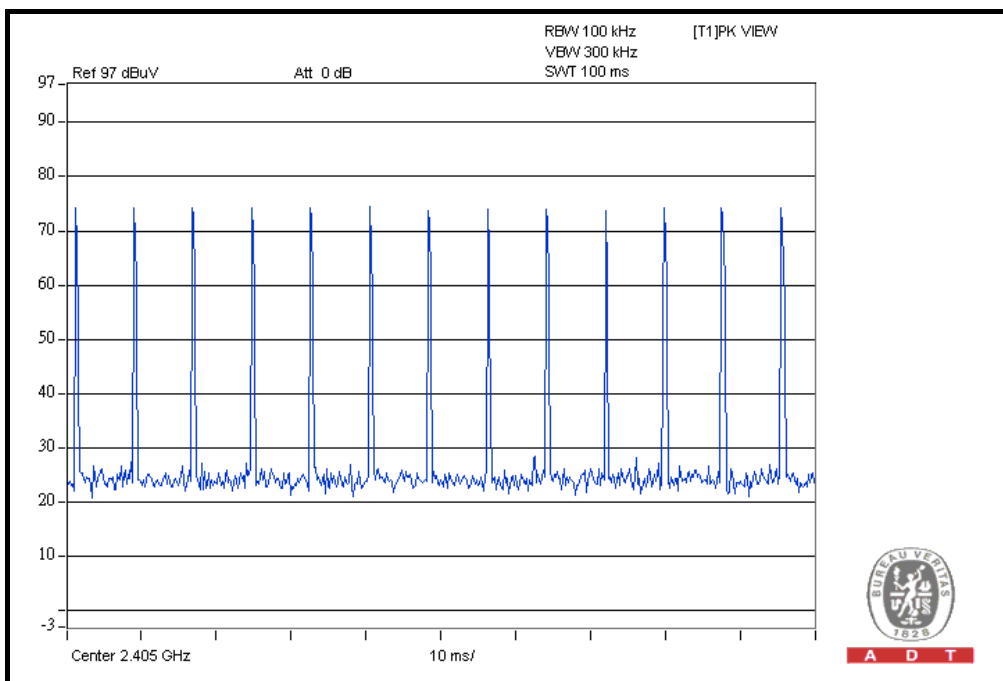

A D T

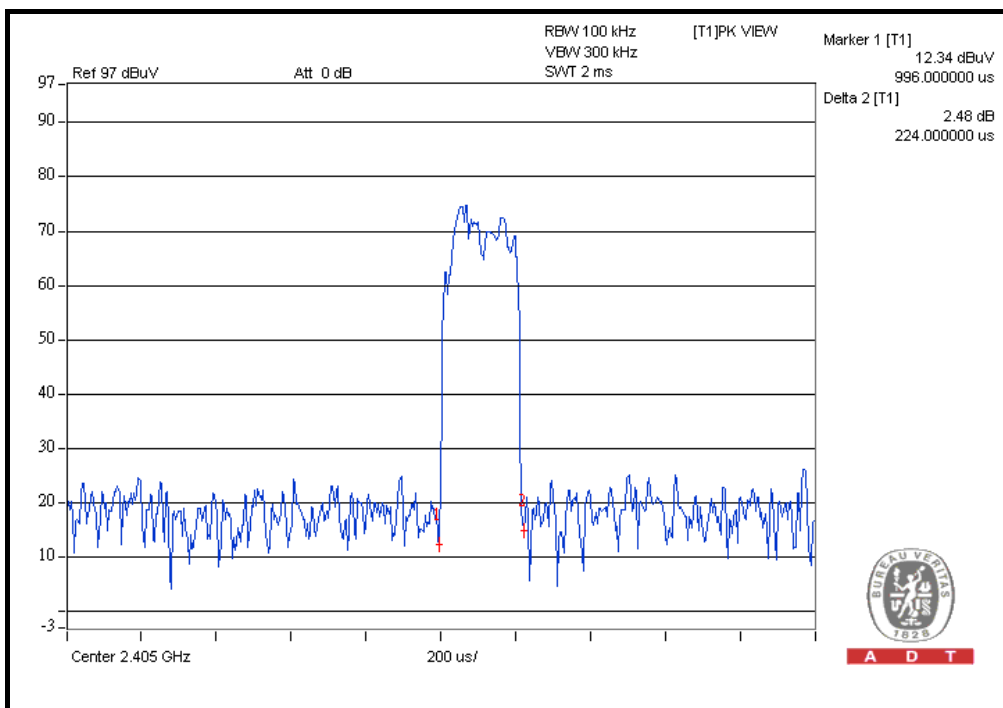

A D T

$$20 \log (\text{Duty cycle}) = 20 \log (13 \times 0.224 \text{ ms} / 100 \text{ ms}) = -30.7 \text{ dB}$$



A D T

BELOW 1GHz WORST-CASE DATA

EUT TEST CONDITION		MEASUREMENT DETAIL	
CHANNEL	Channel 6	FREQUENCY RANGE	Below 1000MHz
INPUT POWER (SYSTEM)	120Vac, 60 Hz	DETECTOR FUNCTION	Quasi-Peak
ENVIRONMENTAL CONDITIONS	25deg. C, 65%RH	TESTED BY	Sun Lin

ANTENNA POLARITY & TEST DISTANCE: HORIZONTAL AT 3 M								
NO.	FREQ. (MHz)	EMISSION LEVEL (dBuV/m)	LIMIT (dBuV/m)	MARGIN (dB)	ANTENNA HEIGHT (m)	TABLE ANGLE (Degree)	RAW VALUE (dBuV)	CORRECTION FACTOR (dB/m)
1	68.80	36.8 QP	40.0	-3.2	1.50 H	160	24.30	12.50
2	163.86	38.4 QP	43.5	-5.1	2.00 H	99	24.60	13.80
3	267.85	42.7 QP	46.0	-3.3	1.05 H	15	29.00	13.70
4	375.32	23.1 QP	46.0	-22.9	2.00 H	157	6.30	16.80
5	423.82	23.0 QP	46.0	-23.0	2.00 H	153	4.90	18.10
6	528.58	27.3 QP	46.0	-18.7	1.25 H	121	6.50	20.80

ANTENNA POLARITY & TEST DISTANCE: VERTICAL AT 3 M								
NO.	FREQ. (MHz)	EMISSION LEVEL (dBuV/m)	LIMIT (dBuV/m)	MARGIN (dB)	ANTENNA HEIGHT (m)	TABLE ANGLE (Degree)	RAW VALUE (dBuV)	CORRECTION FACTOR (dB/m)
1	68.80	31.0 QP	40.0	-9.0	2.00 V	95	18.50	12.50
2	165.80	29.4 QP	43.5	-14.1	1.00 V	199	15.70	13.70
3	189.08	26.8 QP	43.5	-16.7	1.00 V	17	14.80	12.00
4	262.80	33.9 QP	46.0	-12.1	1.25 V	63	20.40	13.50
5	619.76	24.3 QP	46.0	-21.7	1.50 V	206	1.80	22.50
6	699.30	25.1 QP	46.0	-20.9	1.00 V	166	2.30	22.80

REMARKS:

1. Emission level (dBuV/m) = Raw Value (dBuV) + Correction Factor (dB/m).
2. Correction Factor (dB/m) = Antenna Factor (dB/m) + Cable Factor (dB).
3. The other emission levels were very low against the limit.
4. Margin value = Emission level – Limit value.

4.2 CONDUCTED EMISSION MEASUREMENT

4.2.1 LIMITS OF CONDUCTED EMISSION MEASUREMENT

FREQUENCY OF EMISSION (MHz)	CONDUCTED LIMIT (dB μ V)	
	Quasi-peak	Average
0.15 ~ 0.5	66 to 56	56 to 46
0.5 ~ 5	56	46
5 ~ 30	60	50

- NOTE:** 1. The lower limit shall apply at the transition frequencies.
 2. The limit decreases in line with the logarithm of the frequency in the range of 0.15 to 0.50MHz.
 3. All emanations from a class A/B digital device or system, including any network of conductors and apparatus connected thereto, shall not exceed the level of field strengths specified above.

4.2.2 TEST INSTRUMENTS

DESCRIPTION & MANUFACTURER	MODEL NO.	SERIAL NO.	DATE OF CALIBRATION	DUE DATE OF CALIBRATION
Test Receiver ROHDE & SCHWARZ	ESCS30	100289	Nov. 19, 2011	Nov. 18, 2012
RF signal cable Woken	5D-FB	Cable-HYCO2-01	Dec. 29, 2011	Dec. 28, 2012
LISN ROHDE & SCHWARZ (EUT)	ESH2-Z5	100100	Dec. 30, 2011	Dec. 29, 2012
LISN ROHDE & SCHWARZ (Peripheral)	ESH3-Z5	100311	Jul. 14, 2011	Jul. 13, 2012
Software ADT	BV ADT_Cond_ V7.3.7.3	NA	NA	NA

- NOTE:** 1. The calibration interval of the above test instruments is 12 months and the calibrations are traceable to NML/ROC and NIST/USA.
 2. The test was performed in HwaYa Shielded Room 2.
 3. The VCCI Site Registration No. is C-2047.

4.2.3 TEST PROCEDURES

- a. The EUT was placed 0.4 meters from the conducting wall of the shielded room with EUT being connected to the power mains through a line impedance stabilization network (LISN). Other support units were connected to the power mains through another LISN. The two LISNs provide 50 ohm/ 50uH of coupling impedance for the measuring instrument.
- b. Both lines of the power mains connected to the EUT were checked for maximum conducted interference.
- c. The frequency range from 150kHz to 30MHz was searched. Emission levels under (Limit - 20dB) was not recorded.

NOTE: All modes of operation were investigated and the worst-case emissions are reported.

4.2.4 DEVIATION FROM TEST STANDARD

No deviation.

4.2.5 TEST SETUP

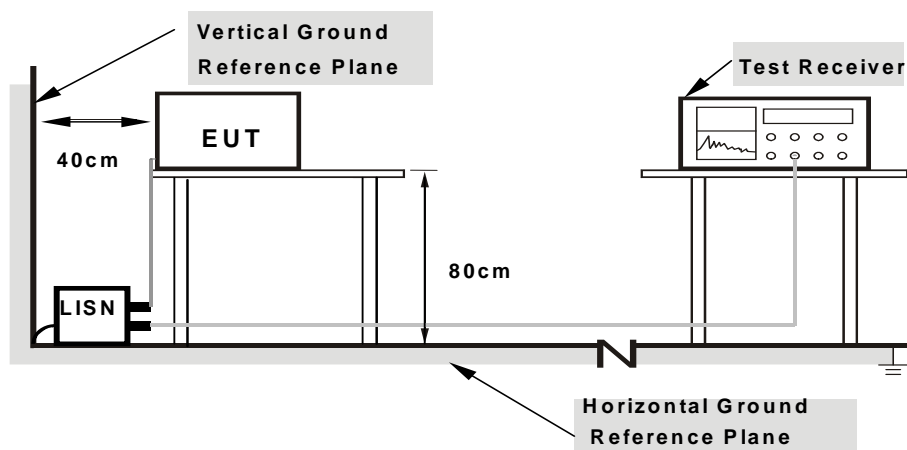

- Note:**
1. Support units were connected to second LISN.
 2. Both of LISNs (AMN) are 80 cm from EUT and at least 80 from other units and other metal planes

For the actual test configuration, please refer to the attached file (Test Setup Photo).

4.2.6 EUT OPERATING CONDITIONS

Same as 4.1.6.

4.2.7 TEST RESULTS

CONDUCTED WORST-CASE DATA :

PHASE	Line 1	6dB BANDWIDTH	9kHz
-------	--------	---------------	------

No	Freq. [MHz]	Corr. Factor (dB)	Reading Value		Emission Level		Limit		Margin	
			[dB (uV)]		[dB (uV)]		[dB (uV)]		(dB)	
			Q.P.	AV.	Q.P.	AV.	Q.P.	AV.	Q.P.	AV.
1	0.18906	0.15	50.08	41.48	50.23	41.63	64.08	54.08	-13.85	-12.45
2	0.50000	0.17	41.40	40.59	41.57	40.76	56.00	46.00	-14.43	-5.24
3	0.61875	0.18	33.57	25.57	33.75	25.75	56.00	46.00	-22.25	-20.25
4	0.75156	0.18	24.33	16.20	24.51	16.38	56.00	46.00	-31.49	-29.62
5	11.87500	0.47	28.40	19.57	28.87	20.04	60.00	50.00	-31.13	-29.96
6	21.08984	0.62	43.85	36.21	44.47	36.83	60.00	50.00	-15.53	-13.17

REMARKS:

1. Q.P. and AV. are abbreviations of quasi-peak and average individually.
2. The emission levels of other frequencies were very low against the limit.
3. Margin value = Emission level - Limit value
4. Correction factor = Insertion loss + Cable loss
5. Emission Level = Correction Factor + Reading Value.

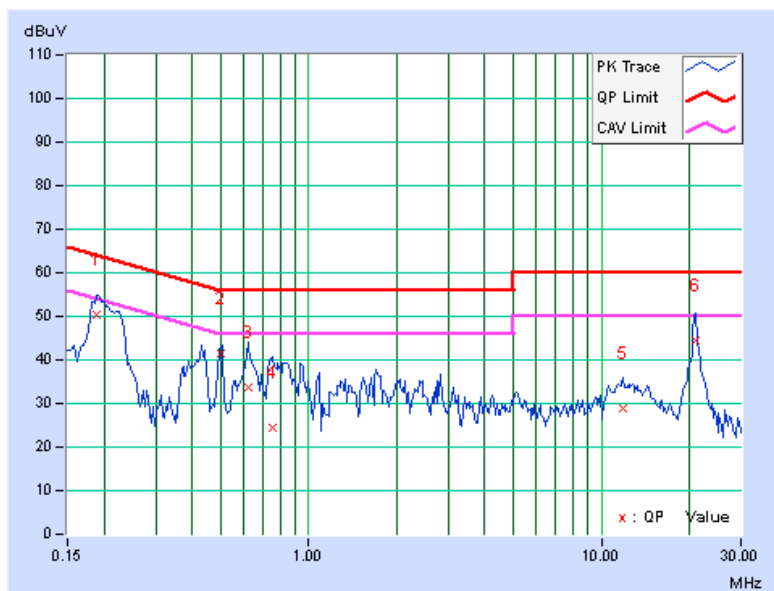

PHASE	Line 2	6dB BANDWIDTH	9kHz
-------	--------	---------------	------

No	Freq. [MHz]	Corr. Factor (dB)	Reading Value		Emission Level		Limit		Margin	
			[dB (uV)]		[dB (uV)]		[dB (uV)]		(dB)	
			Q.P.	AV.	Q.P.	AV.	Q.P.	AV.	Q.P.	AV.
1	0.17734	0.14	38.96	29.27	39.10	29.41	64.61	54.61	-25.51	-25.20
2	0.23594	0.14	33.97	23.81	34.11	23.95	62.24	52.24	-28.12	-28.28
3	0.50938	0.17	38.70	37.19	38.87	37.36	56.00	46.00	-17.13	-8.64
4	0.63438	0.17	31.95	25.51	32.12	25.68	56.00	46.00	-23.88	-20.32
5	13.17969	0.56	26.56	18.19	27.12	18.75	60.00	50.00	-32.88	-31.25
6	20.98438	0.70	44.84	37.65	45.54	38.35	60.00	50.00	-14.46	-11.65

REMARKS:

1. Q.P. and AV. are abbreviations of quasi-peak and average individually.
2. The emission levels of other frequencies were very low against the limit.
3. Margin value = Emission level - Limit value
4. Correction factor = Insertion loss + Cable loss
5. Emission Level = Correction Factor + Reading Value.

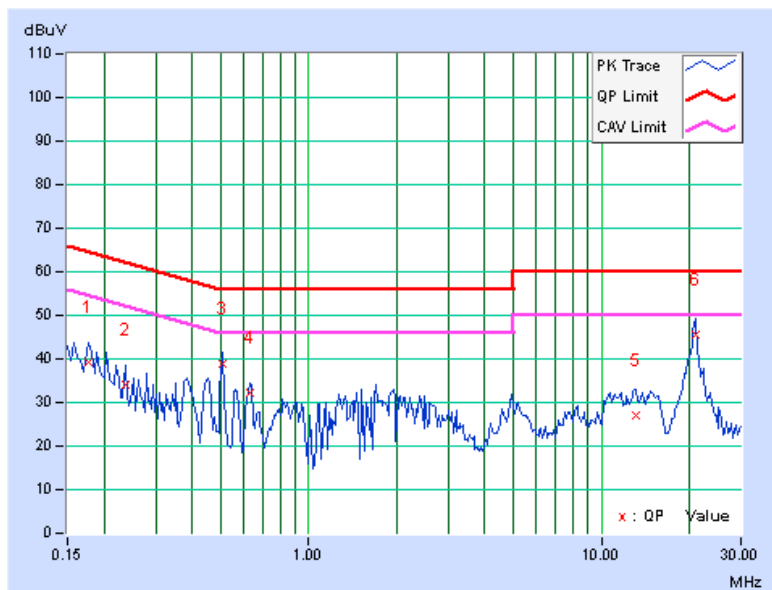



5. PHOTOGRAPHS OF THE TEST CONFIGURATION

Please refer to the attached file (Test Setup Photo).



6. INFORMATION ON THE TESTING LABORATORIES

We, Bureau Veritas Consumer Products Services (H.K.) Ltd., Taoyuan Branch, were founded in 1988 to provide our best service in EMC, Radio, Telecom and Safety consultation. Our laboratories are accredited and approved according to ISO/IEC 17025.

If you have any comments, please feel free to contact us at the following:

Linko EMC/RF Lab

Tel: 886-2-26052180

Fax: 886-2-26051924

Hsin Chu EMC/RF Lab

Tel: 886-3-5935343

Fax: 886-3-5935342

Hwa Ya EMC/RF/Safety/Telecom Lab

Tel: 886-3-3183232

Fax: 886-3-3270892

Email: service.adt@tw.bureauveritas.com

Web Site: www.adt.com.tw

The address and road map of all our labs can be found in our web site also.

7. APPENDIX A – MODIFICATION RECORDERS FOR ENGINEERING CHANGES TO THE EUT BY THE LAB

No any modifications are made to the EUT by the lab during the test.

---END---