



FCC TEST REPORT

REPORT NO. : RF990811C15D
MODEL NO. : BSMBW02R
FCC ID: FDIBSMBW02R-0
RECEIVED : Aug. 11, 2010
TESTED : Aug. 12 ~ Aug. 14, 2010
ISSUED : Mar. 27, 2012

APPLICANT: BUFFALO INC.

ADDRESS: AKAMONDORI B1dg., 30-20, Ohsu 3-chome,
Naka-Ku, Nagoya

ISSUED BY: Bureau Veritas Consumer Products Services
(H.K.) Ltd., Taoyuan Branch

LAB ADDRESS: No. 47, 14th Ling, Chia Pau Tsuen, Lin Kou
Hsiang, Taipei Hsien 244, Taiwan, R.O.C.

TEST LOCATION: No. 19, Hwa Ya 2nd Rd, Wen Hwa Tsuen, Kwei
Shan Hsiang, Taoyuan Hsien 333, Taiwan, R.O.C.

This test report consists of 31 pages in total. It may be duplicated completely for legal use with the approval of the applicant. It should not be reproduced except in full, without the written approval of our laboratory. The client should not use it to claim product, certification, approval or endorsement by TAF or any government agency. The test results in the report only apply to the tested sample. The test results in this report are traceable to the national or international standards.





Table of Contents

RELEASE CONTROL RECORD	3
1. CERTIFICATION	4
2. SUMMARY OF TEST RESULTS	5
2.1 MEASUREMENT UNCERTAINTY	5
3. GENERAL INFORMATION.....	6
3.1 GENERAL DESCRIPTION OF EUT.....	6
3.2 DESCRIPTION OF TEST MODES.....	7
3.2.1 CONFIGURATION OF SYSTEM UNDER TEST	7
3.2.2 TEST MODE APPLICABILITY AND TESTED CHANNEL DETAIL.....	8
3.3 GENERAL DESCRIPTION OF APPLIED STANDARDS	10
3.4 DESCRIPTION OF SUPPORT UNITS	10
4. TEST TYPES AND RESULTS.....	11
4.1 RADIATED EMISSION MEASUREMENT	11
4.1.1 LIMITS OF RADIATED EMISSION MEASUREMENT.....	11
4.1.2 TEST INSTRUMENTS	12
4.1.3 TEST PROCEDURES	13
4.1.4 DEVIATION FROM TEST STANDARD	13
4.1.5 TEST SETUP	14
4.1.6 EUT OPERATING CONDITIONS	14
4.1.7 TEST RESULTS	15
4.2 CONDUCTED EMISSION MEASUREMENT	21
4.2.1 LIMITS OF CONDUCTED EMISSION MEASUREMENT.....	21
4.2.2 TEST INSTRUMENTS	21
4.2.3 TEST PROCEDURES	22
4.2.4 DEVIATION FROM TEST STANDARD	22
4.2.5 TEST SETUP	23
4.2.6 EUT OPERATING CONDITIONS	23
4.2.7 TEST RESULTS	24
4.3 BAND EDGES MEASUREMENT	26
4.3.1 LIMITS OF BAND EDGES MEASUREMENT	26
4.3.2 TEST INSTRUMENTS	26
4.3.3 TEST PROCEDURE	26
4.3.4 DEVIATION FROM TEST STANDARD	26
4.3.5 EUT OPERATING CONDITION	26
4.3.6 TEST RESULTS	27
5. PHOTOGRAPHS OF THE TEST CONFIGURATION.....	29
6. INFORMATION ON THE TESTING LABORATORIES	30
7. APPENDIX A - MODIFICATIONS RECORDERS FOR ENGINEERING CHANGES TO THE EUT BY THE LAB.....	31



RELEASE CONTROL RECORD

ISSUE NO.	REASON FOR CHANGE	DATE ISSUED
RF990811C15D	Original release	Mar. 27, 2012



1. CERTIFICATION

PRODUCT: 2.4GHz wireless receiver
MODEL NO.: BSMBW02R
BRAND: iBUFFALO
APPLICANT: BUFFALO INC.
TESTED: Aug. 12 ~ Aug. 14, 2010
TEST SAMPLE: ENGINEERING SAMPLE
STANDARDS: **FCC Part 15, Subpart C (Section 15.249)**
ANSI C63.4-2003

The above equipment (model: BSMBW02R) have been tested by **Bureau Veritas Consumer Products Services (H.K.) Ltd., Taoyuan Branch**, and found compliance with the requirement of the above standards. The test record, data evaluation & Equipment Under Test (EUT) configurations represented herein are true and accurate accounts of the measurements of the sample's EMC characteristics under the conditions specified in this report.

PREPARED BY : Ivy Lin , **DATE:** Mar. 27, 2012
Ivy Lin / Specialist

APPROVED BY : Gary Chang , **DATE:** Mar. 27, 2012
Gary Chang / Technical Manager

2. SUMMARY OF TEST RESULTS

The EUT has been tested according to the following specifications:

APPLIED STANDARD: FCC Part 15, Subpart C (Section 15.249)			
STANDARD PARAGRAPH	TEST TYPE	RESULT	REMARK
15.207	Conducted Emission Test	PASS	Meet the requirement of limit. Minimum passing margin is -16.85dB at 0.213MHz.
15.209 15.249 15.249 (d)	Radiated Emission Test Band Edge Measurement Limit: 50dB less than the peak value of fundamental frequency or meet radiated emission limit in section 15.209	PASS	Meet the requirement of limit. Minimum passing margin is -4.3dB at 4960.0MHz.

2.1 MEASUREMENT UNCERTAINTY

Where relevant, the following measurement uncertainty levels have been estimated for tests performed on the EUT as specified in CISPR 16-4-2:

MEASUREMENT	FREQUENCY	UNCERTAINTY
Conducted emissions	150kHz~30MHz	2.44 dB
Radiated emissions	30MHz ~ 200MHz	3.19 dB
	200MHz ~1000MHz	3.21 dB
	1GHz ~ 18GHz	2.26 dB
	18GHz ~ 40GHz	1.94 dB

This uncertainty represents an expanded uncertainty expressed at approximately the 95% confidence level using a coverage factor of k=2.

3. GENERAL INFORMATION

3.1 GENERAL DESCRIPTION OF EUT

EUT	2.4GHz wireless receiver
MODEL NO.	BSMBW02R
POWER SUPPLY	5Vdc
MODULATION TYPE	GFSK
DATA RATE	1Mbps
OPERATING FREQUENCY	2403 ~ 2480MHz
NUMBER OF CHANNEL	78
ANTENNA TYPE	Printed antenna
DATA CABLE	NA
I/O PORT	NA
ACCESSORY DEVICES	NA

NOTE:

1. This report is issued as a duplicate report to the original report no.: RF990811C15. The differences are changing applicant, brand and model.
2. The EUT has transmitter and receiver functions.
3. The above EUT information was declared by manufacturer and for more detailed features description, please refer to the manufacturer's specifications or User's Manual.

3.2 DESCRIPTION OF TEST MODES

78 channels are provided to this EUT.

Channel	Freq. (MHz)	Channel	Freq. (MHz)	Channel	Freq. (MHz)
1	2403	27	2429	53	2455
2	2404	28	2430	54	2456
3	2405	29	2431	55	2457
4	2406	30	2432	56	2458
5	2407	31	2433	57	2459
6	2408	32	2434	58	2460
7	2409	33	2435	59	2461
8	2410	34	2436	60	2462
9	2411	35	2437	61	2463
10	2412	36	2438	62	2464
11	2413	37	2439	63	2465
12	2414	38	2440	64	2466
13	2415	39	2441	65	2467
14	2416	40	2442	66	2468
15	2417	41	2443	67	2469
16	2418	42	2444	68	2470
17	2419	43	2445	69	2471
18	2420	44	2446	70	2472
19	2421	45	2447	71	2473
20	2422	46	2448	72	2474
21	2423	47	2449	73	2475
22	2424	48	2450	74	2476
23	2425	49	2451	75	2477
24	2426	50	2452	76	2478
25	2427	51	2453	77	2479
26	2428	52	2454	78	2480

3.2.1 CONFIGURATION OF SYSTEM UNDER TEST

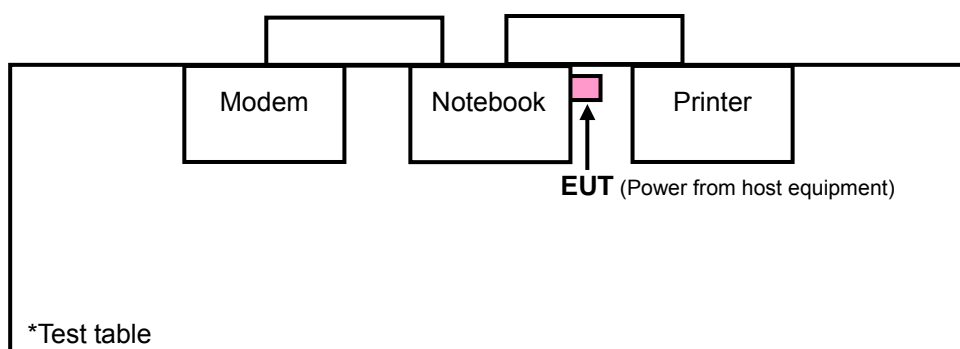

3.2.2 TEST MODE APPLICABILITY AND TESTED CHANNEL DETAIL

EUT CONFIGURE MODE	APPLICABLE TO				DESCRIPTION
	RE \geq 1G	RE<1G	PLC	BM	
-	√	√	√	√	-

Where **PLC**: Power Line Conducted Emission

RE<1G: Radiated Emission below 1GHz

RE \geq 1G: Radiated Emission above 1GHz

BM: Bandedge Measurement

RADIATED EMISSION TEST (ABOVE 1 GHz):

- Pre-Scan has been conducted to determine the worst-case mode from all possible combinations between available modulations axis and antenna ports (if EUT with antenna diversity architecture).
- Following channel(s) was (were) selected for the final test as listed below.

AVAILABLE CHANNEL	TESTED CHANNEL	MODULATION TYPE
1 to 78	1, 38, 78	GFSK

RADIATED EMISSION TEST (BELOW 1 GHz):

- Pre-Scan has been conducted to determine the worst-case mode from all possible combinations between available modulations axis and antenna ports (if EUT with antenna diversity architecture).
- Following channel(s) was (were) selected for the final test as listed below.

AVAILABLE CHANNEL	TESTED CHANNEL	MODULATION TYPE
1 to 78	78	GFSK

POWER LINE CONDUCTED EMISSION TEST:

- Pre-Scan has been conducted to determine the worst-case mode from all possible combinations between available modulations, data rates and antenna ports (if EUT with antenna diversity architecture).
- Following channel(s) was (were) selected for the final test as listed below.

AVAILABLE CHANNEL	TESTED CHANNEL	MODULATION TYPE
1 to 78	78	GFSK

BANDEDGE MEASUREMENT:

- Pre-Scan has been conducted to determine the worst-case mode from all possible combinations between available modulations and antenna ports (if EUT with antenna diversity architecture).
- Following channel(s) was (were) selected for the final test as listed below.

AVAILABLE CHANNEL	TESTED CHANNEL	MODULATION TYPE
1 to 78	1, 78	GFSK

TEST CONDITION:

APPLICABLE TO	ENVIRONMENTAL CONDITIONS	INPUT POWER (SYSTEM)	TESTED BY
RE≥1G	25deg. C, 65%RH, 1008 hPa	120Vac, 60Hz	Antony Lee
RE<1G	25deg. C, 65%RH, 1008 hPa	120Vac, 60Hz	Antony Lee
PLC	25deg. C, 67%RH, 1007 hPa	120Vac, 60Hz	Sun Lin
BM	25deg. C, 65%RH, 1008 hPa	120Vac, 60Hz	Antony Lee



3.3 GENERAL DESCRIPTION OF APPLIED STANDARDS

The EUT is a RF Product. According to the specifications of the manufacturer, it must comply with the requirements of the following standards:

FCC Part 15, Subpart C (Section 15.249)

ANSI C63.4-2003

All test items have been performed and recorded as per the above standards.

NOTE: The EUT is also considered as a kind of computer peripheral, because the connection to computer is necessary for typical use. It has been verified to comply with the requirements of FCC Part 15, Subpart B, Class B (DoC). The test report has been issued separately.

3.4 DESCRIPTION OF SUPPORT UNITS

The EUT has been tested as an independent unit together with other necessary accessories or support units. The following support units or accessories were used to form a representative test configuration during the tests.

NO.	PRODUCT	BRAND	MODEL NO.	SERIAL NO.	FCC ID
1	NOTEBOOK	DELL	D820	21498926752	NA
2	PRINTER	EPSON	LQ-300+	DCGY047265	FCC DoC Approved
3	MODEM	ACEEX	1414V/3	0401008253	IFAXDM1414

NO.	SIGNAL CABLE DESCRIPTION OF THE ABOVE SUPPORT UNITS
1	NA
2	1.8m braid shielded wire, DB25 connector, w/o core.
3	1.2m braid shielded wire, DB25 & DB9 connector, w/o core.

NOTE: All power cords of the above support units are non-shielded (1.8m).

4. TEST TYPES AND RESULTS

4.1 RADIATED EMISSION MEASUREMENT

4.1.1 LIMITS OF RADIATED EMISSION MEASUREMENT

Emissions radiated outside of the specified bands, shall be according to the general radiated limits in 15.209, 15.249 as following:

15.209 Limit		
Frequencies (MHz)	Field strength (microvolts/meter)	Measurement distance (meters)
0.009 ~ 0.490	2400/F(kHz)	300
0.490 ~ 1.705	24000/F(kHz)	30
1.705 ~ 30.0	30	30
30 ~ 88	100	3
88 ~ 216	150	3
216 ~ 960	200	3
Above 960	500	3
15.249 Limit		
Fundamental Frequency	Field Strength of Fundamental (millivolts/meter)	Field Strength of Harmonics (microvolts/meter)
902 ~ 928 MHz	50	500
2400 ~ 2483.5 MHz	50	500
5725 ~ 5875 MHz	50	500
24 ~ 24.25 GHz	250	2500

NOTE:

1. The lower limit shall apply at the transition frequencies.
2. Emission level (dBuV/m) = 20 log Emission level (uV/m).
3. As shown in 15.35(b), for frequencies above 1000MHz, the field strength limits are based on average detector, however, the peak field strength of any emission shall not exceed the maximum permitted average limits, specified above by more than 20dB under any condition of modulation.



4.1.2 TEST INSTRUMENTS

DESCRIPTION & MANUFACTURER	MODEL NO.	SERIAL NO.	DATE OF CALIBRATION	DUE DATE OF CALIBRATION
Test Receiver ROHDE & SCHWARZ	ESI7	838496/016	Dec. 29, 2009	Dec. 28, 2010
Spectrum Analyzer ROHDE & SCHWARZ	FSP40	100039	Jan. 11, 2010	Jan. 10, 2011
BILOG Antenna SCHWARZBECK	VULB9168	9168-155	Apr. 28, 2010	Apr. 27, 2011
HORN Antenna SCHWARZBECK	BBHA 9120D	9120D-408	Jan. 05, 2010	Jan. 04, 2011
HORN Antenna SCHWARZBECK	BBHA 9170	BBHA9170242	Dec. 25, 2009	Dec. 24, 2010
Preamplifier Agilent	8449B	3008A01961	Nov. 04, 2009	Nov. 03, 2010
Preamplifier Agilent	8447D	2944A10738	Nov. 04, 2009	Nov. 03, 2010
RF signal cable HUBER+SUHNNER	SUCOFLEX 104	274041/4	Aug. 28, 2009	Aug. 27, 2010
RF signal cable HUBER+SUHNNER	SUCOFLEX 104	283397/4	Aug. 28, 2009	Aug. 27, 2010
Software ADT.	ADT_Radiated_ V7.6.15.9.2	NA	NA	NA
Antenna Tower inn-co GmbH	MA 4000	010303	NA	NA
Antenna Tower Controller inn-co GmbH	CO2000	019303	NA	NA
Turn Table ADT.	TT100.	TT93021704	NA	NA
Turn Table Controller ADT.	SC100.	SC93021704	NA	NA

- NOTE:**
1. The calibration interval of the above test instruments is 12 months and the calibrations are traceable to NML/ROC and NIST/USA.
 2. The test was performed in HwaYa Chamber 4.
 3. The horn antenna and HP preamplifier (model: 8449B) are used only for the measurement of emission frequency above 1GHz if tested.
 4. The FCC Site Registration No. is 988962.
 5. The IC Site Registration No. is IC7450F-4.

4.1.3 TEST PROCEDURES

- a. The EUT was placed on the top of a rotating table 0.8 meters above the ground at a 3 meter semi-anechoic chamber. The table was rotated 360 degrees to determine the position of the highest radiation.
- b. The EUT was set 3 meters away from the interference-receiving antenna, which was mounted on the top of a variable-height antenna tower.
- c. The antenna is a broadband antenna, and its height is varied from one meter to four meters above the ground to determine the maximum value of the field strength. Both horizontal and vertical polarizations of the antenna are set to make the measurement.
- d. For each suspected emission, the EUT was arranged to its worst case and then the antenna was tuned to heights from 1 meter to 4 meters and the rotatable table was turned from 0 degrees to 360 degrees to find the maximum reading.
- e. The test-receiver system was set to Peak Detect Function and Specified Bandwidth with Maximum Hold Mode.
- f. If the emission level of the EUT in peak mode was lower than the limit specified, then testing could be stopped and the peak values of the EUT would be reported. Otherwise the emissions would be re-tested one by one using peak, quasi-peak or average method as specified and then reported in a data sheet.

NOTE:

1. The resolution bandwidth and video bandwidth of test receiver/spectrum analyzer is 120kHz for Quasi-peak detection at frequency below 1GHz.
2. The resolution bandwidth of test receiver/spectrum analyzer is 1MHz and video bandwidth is 3MHz for Peak detection at frequency above 1GHz.
3. All modes of operation were investigated and the worst-case emissions are reported.

4.1.4 DEVIATION FROM TEST STANDARD

No deviation.

4.1.5 TEST SETUP

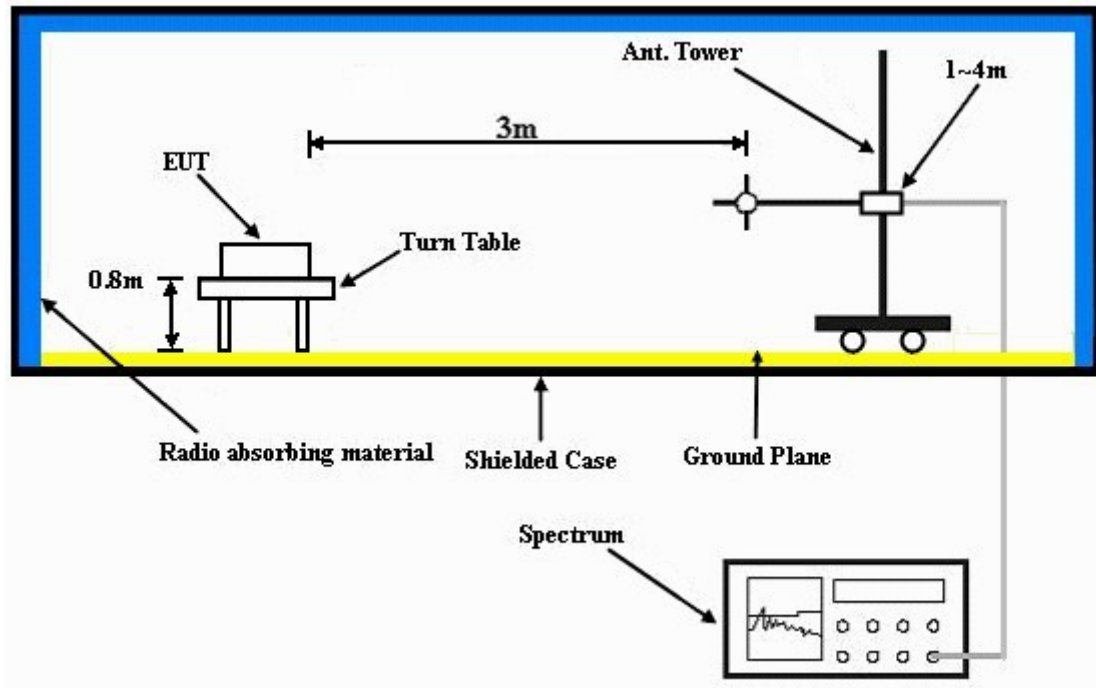

For the actual test configuration, please refer to the attached file (Test Setup Photo).

4.1.6 EUT OPERATING CONDITIONS

- Plugged the EUT to notebook and placed on a testing table.
- Set the transmitter part of EUT under transmission condition continuously at specific channel frequency.
- The necessary accessories enable the EUT in full functions.

4.1.7 TEST RESULTS

ABOVE 1GHz DATA

EUT TEST CONDITION		MEASUREMENT DETAIL	
CHANNEL	Channel 1	FREQUENCY RANGE	1 ~ 25GHz
INPUT POWER (SYSTEM)	120 Vac, 60 Hz	DETECTOR FUNCTION	Peak (PK) Average (AV)
ENVIRONMENTAL CONDITIONS	25deg. C, 65%RH 1008 hPa	TESTED BY	Antony Lee

ANTENNA POLARITY & TEST DISTANCE: HORIZONTAL AT 3 M								
NO.	FREQ. (MHz)	EMISSION LEVEL (dBuV/m)	LIMIT (dBuV/m)	MARGIN (dB)	ANTENNA HEIGHT (m)	TABLE ANGLE (Degree)	RAW VALUE (dBuV)	CORRECTION FACTOR (dB/m)
1	2390.00	40.6 PK	74.0	-33.4	1.00 H	176	7.10	33.50
2	2390.00	29.9 AV	54.0	-24.1	1.00 H	176	-3.60	33.50
3	2398.00	40.6 PK	74.0	-33.4	1.00 H	175	7.10	33.50
4	2398.00	29.1 AV	54.0	-24.9	1.00 H	175	-4.40	33.50
5	2400.00	51.8 PK	74.0	-22.2	1.00 H	177	18.30	33.50
6	2400.00	5.3 AV	54.0	-48.7	1.00 H	177	-28.20	33.50
7	*2403.00	85.0 PK	114.0	-29.0	1.00 H	177	51.50	33.50
8	*2403.00	38.5 AV	94.0	-55.5	1.00 H	177	5.00	33.50
9	4806.00	65.1 PK	74.0	-8.9	1.05 H	166	25.10	40.00
10	4806.00	18.6 AV	54.0	-35.4	1.05 H	166	-21.40	40.00

- REMARKS:**
1. Emission level (dBuV/m) = Raw Value (dBuV) + Correction Factor (dB/m).
 2. Correction Factor (dB/m) = Antenna Factor (dB/m) + Cable Factor (dB).
 3. The other emission levels were very low against the limit.
 4. Margin value = Emission level – Limit value.
 5. “ * “ : Fundamental frequency
 6. The average value of fundamental frequency is: Average = Peak value + 20log(Duty cycle) Where the duty factor is calculated from following formula:
 $20 \log (\text{Duty cycle}) = 20 \log (2 * 0.238 \text{ ms} / 100 \text{ ms}) = -46.5 \text{ dB}$
 Please see page 19 for plotted duty.

EUT TEST CONDITION		MEASUREMENT DETAIL	
CHANNEL	Channel 1	FREQUENCY RANGE	1 ~ 25GHz
INPUT POWER (SYSTEM)	120 Vac, 60 Hz	DETECTOR FUNCTION	Peak (PK) Average (AV)
ENVIRONMENTAL CONDITIONS	25deg. C, 65%RH 1008 hPa	TESTED BY	Antony Lee

ANTENNA POLARITY & TEST DISTANCE: VERTICAL AT 3 M								
NO.	FREQ. (MHz)	EMISSION LEVEL (dBuV/m)	LIMIT (dBuV/m)	MARGIN (dB)	ANTENNA HEIGHT (m)	TABLE ANGLE (Degree)	RAW VALUE (dBuV)	CORRECTION FACTOR (dB/m)
1	2390.00	41.5 PK	74.0	-32.5	1.00 V	269	8.00	33.50
2	2390.00	28.6 AV	54.0	-25.4	1.00 V	269	-4.90	33.50
3	2398.00	40.3 PK	74.0	-33.7	1.00 V	274	6.80	33.50
4	2398.00	28.7 AV	54.0	-25.3	1.00 V	274	-4.80	33.50
5	2400.00	47.1 PK	74.0	-26.9	1.00 V	273	13.60	33.50
6	2400.00	0.6 AV	54.0	-53.4	1.00 V	273	-32.90	33.50
7	*2403.00	80.8 PK	114.0	-33.2	1.00 V	273	47.30	33.50
8	*2403.00	34.3 AV	94.0	-59.7	1.00 V	273	0.80	33.50
9	4806.00	67.2 PK	74.0	-6.8	1.00 V	121	27.20	40.00
10	4806.00	20.7 AV	54.0	-33.3	1.00 V	121	-19.30	40.00

- REMARKS:**
1. Emission level (dBuV/m) = Raw Value (dBuV) + Correction Factor (dB/m).
 2. Correction Factor (dB/m) = Antenna Factor (dB/m) + Cable Factor (dB).
 3. The other emission levels were very low against the limit.
 4. Margin value = Emission level – Limit value.
 5. “ * “ : Fundamental frequency
 6. The average value of fundamental frequency is: Average = Peak value + 20log(Duty cycle) Where the duty factor is calculated from following formula:
 $20 \log (\text{Duty cycle}) = 20 \log (2 * 0.238 \text{ ms} / 100 \text{ ms}) = -46.5 \text{ dB}$
 Please see page 19 for plotted duty.

EUT TEST CONDITION		MEASUREMENT DETAIL	
CHANNEL	Channel 39	FREQUENCY RANGE	1 ~ 25GHz
INPUT POWER (SYSTEM)	120 Vac, 60 Hz	DETECTOR FUNCTION	Peak (PK) Average (AV)
ENVIRONMENTAL CONDITIONS	25deg. C, 65%RH 1008 hPa	TESTED BY	Antony Lee

ANTENNA POLARITY & TEST DISTANCE: HORIZONTAL AT 3 M								
NO.	FREQ. (MHz)	EMISSION LEVEL (dBuV/m)	LIMIT (dBuV/m)	MARGIN (dB)	ANTENNA HEIGHT (m)	TABLE ANGLE (Degree)	RAW VALUE (dBuV)	CORRECTION FACTOR (dB/m)
1	*2440.00	87.2 PK	114.0	-26.8	1.00 H	181	53.50	33.70
2	*2440.00	40.7 AV	94.0	-53.3	1.00 H	181	7.00	33.70
3	4880.00	66.3 PK	74.0	-7.7	1.03 H	148	26.20	40.10
4	4880.00	19.8 AV	54.0	-34.2	1.03 H	148	-20.30	40.10
ANTENNA POLARITY & TEST DISTANCE: VERTICAL AT 3 M								
NO.	FREQ. (MHz)	EMISSION LEVEL (dBuV/m)	LIMIT (dBuV/m)	MARGIN (dB)	ANTENNA HEIGHT (m)	TABLE ANGLE (Degree)	RAW VALUE (dBuV)	CORRECTION FACTOR (dB/m)
1	*2440.00	82.9 PK	114.0	-31.1	1.00 V	274	49.20	33.70
2	*2440.00	36.4 AV	94.0	-57.6	1.00 V	274	2.70	33.70
3	4880.00	66.1 PK	74.0	-7.9	1.00 V	127	26.00	40.10
4	4880.00	19.6 AV	54.0	-34.4	1.00 V	127	-20.50	40.10

- REMARKS:**
- Emission level (dBuV/m) = Raw Value (dBuV) + Correction Factor (dB/m).
 - Correction Factor (dB/m) = Antenna Factor (dB/m) + Cable Factor (dB).
 - The other emission levels were very low against the limit.
 - Margin value = Emission level – Limit value.
 - “ * “ : Fundamental frequency
 - The average value of fundamental frequency is: Average = Peak value + 20log(Duty cycle) Where the duty factor is calculated from following formula:
 $20 \log (\text{Duty cycle}) = 20 \log (2 * 0.238 \text{ ms} / 100 \text{ ms}) = -46.5 \text{ dB}$
 Please see page 19 for plotted duty.



A D T

EUT TEST CONDITION		MEASUREMENT DETAIL	
CHANNEL	Channel 78	FREQUENCY RANGE	1 ~ 25GHz
INPUT POWER (SYSTEM)	120 Vac, 60 Hz	DETECTOR FUNCTION	Peak (PK) Average (AV)
ENVIRONMENTAL CONDITIONS	25deg. C, 65%RH 1008 hPa	TESTED BY	Antony Lee

ANTENNA POLARITY & TEST DISTANCE: HORIZONTAL AT 3 M

NO.	FREQ. (MHz)	EMISSION LEVEL (dBuV/m)	LIMIT (dBuV/m)	MARGIN (dB)	ANTENNA HEIGHT (m)	TABLE ANGLE (Degree)	RAW VALUE (dBuV)	CORRECTION FACTOR (dB/m)
1	*2480.00	89.4 PK	114.0	-24.6	1.00 H	179	55.60	33.80
2	*2480.00	42.9 AV	94.0	-51.1	1.00 H	179	9.10	33.80
3	2483.50	54.2 PK	74.0	-19.8	1.77 H	181	20.40	33.80
4	2483.50	7.7 AV	54.0	-46.3	1.77 H	181	-26.10	33.80
5	2485.50	42.4 PK	74.0	-31.6	1.00 H	181	8.50	33.90
6	2485.50	33.4 AV	54.0	-20.6	1.00 H	181	-0.50	33.90
7	4960.00	68.2 PK	74.0	-5.8	1.00 H	157	27.90	40.30
8	4960.00	21.7 AV	54.0	-32.3	1.00 H	157	-18.60	40.30

ANTENNA POLARITY & TEST DISTANCE: VERTICAL AT 3 M

NO.	FREQ. (MHz)	EMISSION LEVEL (dBuV/m)	LIMIT (dBuV/m)	MARGIN (dB)	ANTENNA HEIGHT (m)	TABLE ANGLE (Degree)	RAW VALUE (dBuV)	CORRECTION FACTOR (dB/m)
1	*2480.00	85.3 PK	114.0	-28.7	1.00 V	279	51.50	33.80
2	*2480.00	38.8 AV	94.0	-55.2	1.00 V	279	5.00	33.80
3	2483.50	49.6 PK	74.0	-24.4	1.00 V	272	15.80	33.80
4	2483.50	3.1 AV	54.0	-50.9	1.00 V	272	-30.70	33.80
5	2485.50	41.8 PK	74.0	-32.2	1.00 V	273	7.90	33.90
6	2485.50	31.4 AV	54.0	-22.6	1.00 V	273	-2.50	33.90
7	4960.00	69.7 PK	74.0	-4.3	1.00 V	125	29.40	40.30
8	4960.00	23.2 AV	54.0	-30.8	1.00 V	125	-17.10	40.30

- REMARKS:**
- Emission level (dBuV/m) = Raw Value (dBuV) + Correction Factor (dB/m).
 - Correction Factor (dB/m) = Antenna Factor (dB/m) + Cable Factor (dB).
 - The other emission levels were very low against the limit.
 - Margin value = Emission level – Limit value.
 - * * : Fundamental frequency
 - The average value of fundamental frequency is: Average = Peak value + 20log(Duty cycle) Where the duty factor is calculated from following formula:
 $20 \log (\text{Duty cycle}) = 20 \log (2 * 0.238 \text{ ms} / 100 \text{ ms}) = -46.5 \text{ dB}$
 Please see page 19 for plotted duty.



A D T

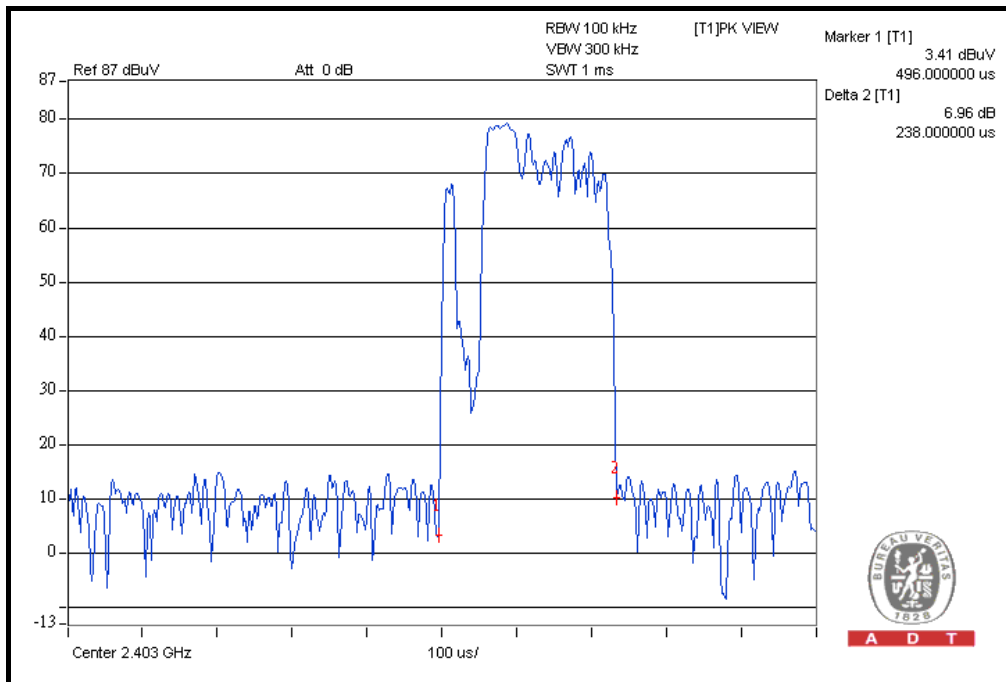

A D T

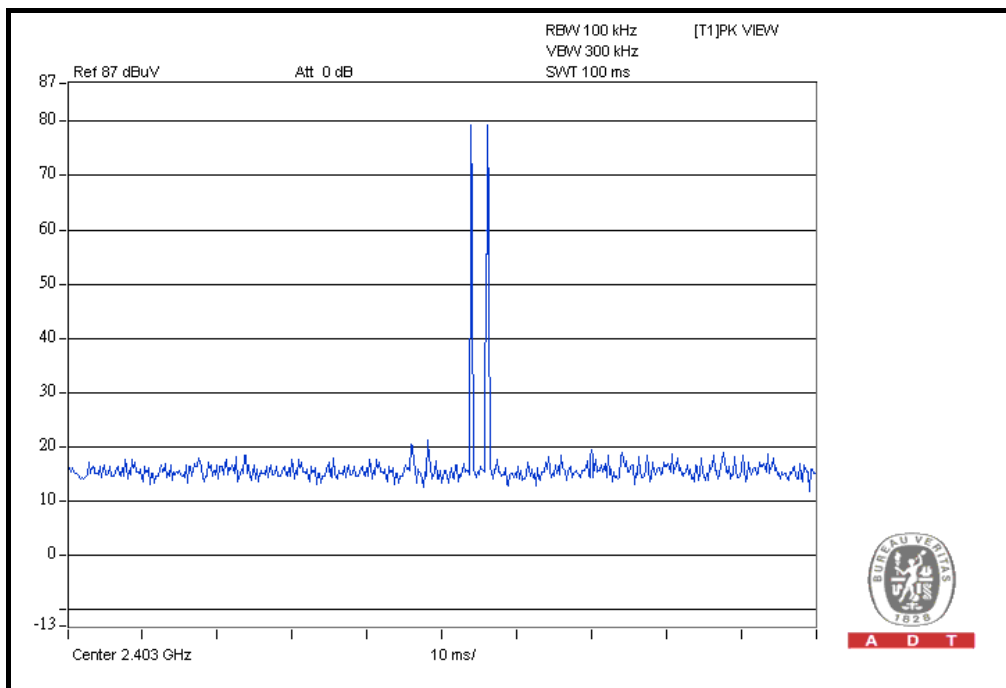

A D T

$$20 \log (\text{Duty cycle}) = 20 \log (2 * 0.238 \text{ ms} / 100 \text{ ms}) = -46.5 \text{ dB}$$

BELOW 1GHz WORST-CASE DATA

EUT TEST CONDITION		MEASUREMENT DETAIL	
CHANNEL	Channel 78	FREQUENCY RANGE	Below 1000MHz
INPUT POWER (SYSTEM)	120 Vac, 60 Hz	DETECTOR FUNCTION	Quasi-Peak
ENVIRONMENTAL CONDITIONS	25deg. C, 65%RH 1008 hPa	TESTED BY	Antony Lee

ANTENNA POLARITY & TEST DISTANCE: HORIZONTAL AT 3 M								
NO.	FREQ. (MHz)	EMISSION LEVEL (dBuV/m)	LIMIT (dBuV/m)	MARGIN (dB)	ANTENNA HEIGHT (m)	TABLE ANGLE (Degree)	RAW VALUE (dBuV)	CORRECTION FACTOR (dB/m)
1	232.10	24.9 QP	46.0	-21.1	2.00 H	139	12.30	12.60
2	261.30	26.5 QP	46.0	-19.5	2.00 H	136	12.70	13.80
3	298.20	28.6 QP	46.0	-17.4	2.00 H	247	13.10	15.50
4	447.90	26.7 QP	46.0	-19.3	1.25 H	268	7.30	19.40
5	523.70	28.0 QP	46.0	-18.0	2.25 H	241	6.60	21.40
6	832.90	34.0 QP	46.0	-12.0	1.00 H	301	6.90	27.10
ANTENNA POLARITY & TEST DISTANCE: VERTICAL AT 3 M								
NO.	FREQ. (MHz)	EMISSION LEVEL (dBuV/m)	LIMIT (dBuV/m)	MARGIN (dB)	ANTENNA HEIGHT (m)	TABLE ANGLE (Degree)	RAW VALUE (dBuV)	CORRECTION FACTOR (dB/m)
1	76.60	26.7 QP	40.0	-13.3	1.00 V	112	15.90	10.80
2	169.90	29.8 QP	43.5	-13.7	1.50 V	112	16.10	13.70
3	300.20	34.5 QP	46.0	-11.5	1.50 V	181	18.90	15.60
4	337.10	31.1 QP	46.0	-14.9	1.50 V	43	14.60	16.50
5	447.90	28.9 QP	46.0	-17.1	1.25 V	109	9.50	19.40
6	784.30	29.9 QP	46.0	-16.1	1.50 V	226	3.80	26.10

- REMARKS:**
1. Emission level (dBuV/m) = Raw Value (dBuV) + Correction Factor (dB/m).
 2. Correction Factor (dB/m) = Antenna Factor (dB/m) + Cable Factor (dB).
 3. The other emission levels were very low against the limit.
 4. Margin value = Emission level – Limit value.

4.2 CONDUCTED EMISSION MEASUREMENT

4.2.1 LIMITS OF CONDUCTED EMISSION MEASUREMENT

FREQUENCY OF EMISSION (MHz)	CONDUCTED LIMIT (dB μ V)	
	Quasi-peak	Average
0.15 ~ 0.5	66 to 56	56 to 46
0.5 ~ 5	56	46
5 ~ 30	60	50

- NOTE:**
1. The lower limit shall apply at the transition frequencies.
 2. The limit decreases in line with the logarithm of the frequency in the range of 0.15 to 0.50 MHz.
 3. All emanations from a class A/B digital device or system, including any network of conductors and apparatus connected thereto, shall not exceed the level of field strengths specified above.

4.2.2 TEST INSTRUMENTS

DESCRIPTION & MANUFACTURER	MODEL NO.	SERIAL NO.	DATE OF CALIBRATION	DUE DATE OF CALIBRATION
Test Receiver ROHDE & SCHWARZ	ESCS30	100288	Sep. 24, 2009	Sep. 23, 2010
RF signal cable Woken	5D-FB	Cable-HYCO2-01	Dec. 31, 2009	Dec. 30, 2010
LISN ROHDE & SCHWARZ	ESH2-Z5	100100	Aug. 24, 2009	Aug. 23, 2010
LISN ROHDE & SCHWARZ	ESH3-Z5	100311	Jul. 08, 2010	Jul. 07, 2011
Software ADT	ADT_Cond_ V7.3.7	NA	NA	NA

- NOTE:**
1. The calibration interval of the above test instruments is 12 months and the calibrations are traceable to NML/ROC and NIST/USA.
 2. The test was performed in HwaYa Shielded Room 2.
 3. The VCCI Site Registration No. is C-2047.

4.2.3 TEST PROCEDURES

- a. The EUT was placed 0.4 meters from the conducting wall of the shielded room with EUT being connected to the power mains through a line impedance stabilization network (LISN). Other support units were connected to the power mains through another LISN. The two LISNs provide 50 ohm/ 50uH of coupling impedance for the measuring instrument.
- b. Both lines of the power mains connected to the EUT were checked for maximum conducted interference.
- c. The frequency range from 150kHz to 30MHz was searched. Emission levels under (Limit - 20dB) was not recorded.

NOTE: All modes of operation were investigated and the worst-case emissions are reported.

4.2.4 DEVIATION FROM TEST STANDARD

No deviation.

4.2.5 TEST SETUP

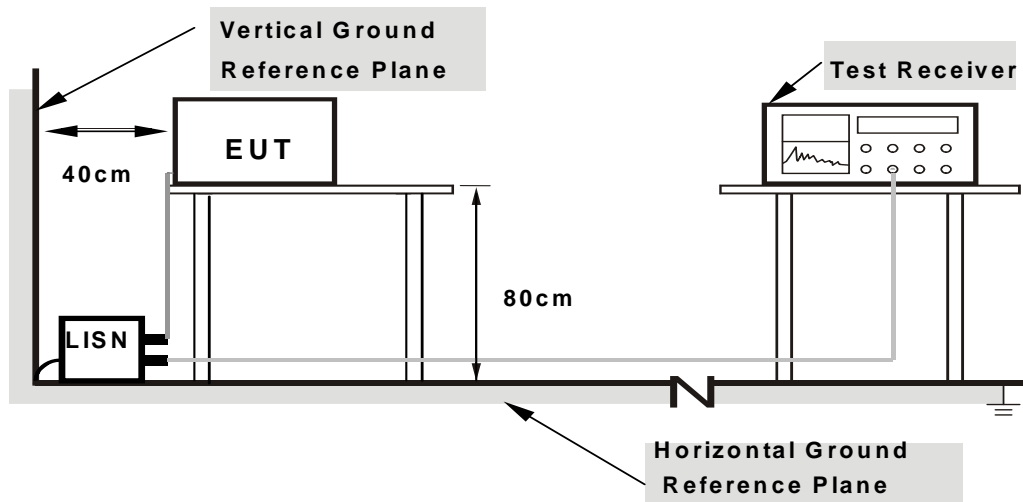

- Note:**
1. Support units were connected to second LISN.
 2. Both of LISNs (AMN) are 80 cm from EUT and at least 80 from other units and other metal planes

For the actual test configuration, please refer to the attached file (Test Setup Photo).

4.2.6 EUT OPERATING CONDITIONS

Same as 4.1.6.

4.2.7 TEST RESULTS

CONDUCTED WORST-CASE DATA

PHASE	Line 1	6dB BANDWIDTH	9kHz
-------	--------	---------------	------

No	Freq. [MHz]	Corr.	Reading Value		Emission Level		Limit		Margin	
		Factor (dB)	Q.P. [dB (uV)]	AV. [dB (uV)]	Q.P. [dB (uV)]	AV. [dB (uV)]	Q.P. [dB (uV)]	AV. [dB (uV)]	Q.P. (dB)	AV. (dB)
1	0.209	0.16	42.83	-	42.99	-	63.26	53.26	-20.27	-
2	0.334	0.17	31.98	-	32.15	-	59.36	49.36	-27.21	-
3	0.416	0.18	29.44	-	29.62	-	57.54	47.54	-27.91	-
4	1.883	0.30	33.41	-	33.71	-	56.00	46.00	-22.29	-
5	3.750	0.34	29.56	-	29.90	-	56.00	46.00	-26.10	-
6	10.664	0.37	32.90	-	33.27	-	60.00	50.00	-26.73	-

- REMARKS:**
1. Q.P. and AV. are abbreviations of quasi-peak and average individually.
 2. "-": The Quasi-peak reading value also meets average limit and measurement with the average detector is unnecessary.
 3. The emission levels of other frequencies were very low against the limit.
 4. Margin value = Emission level - Limit value
 5. Correction factor = Insertion loss + Cable loss
 6. Emission Level = Correction Factor + Reading Value.

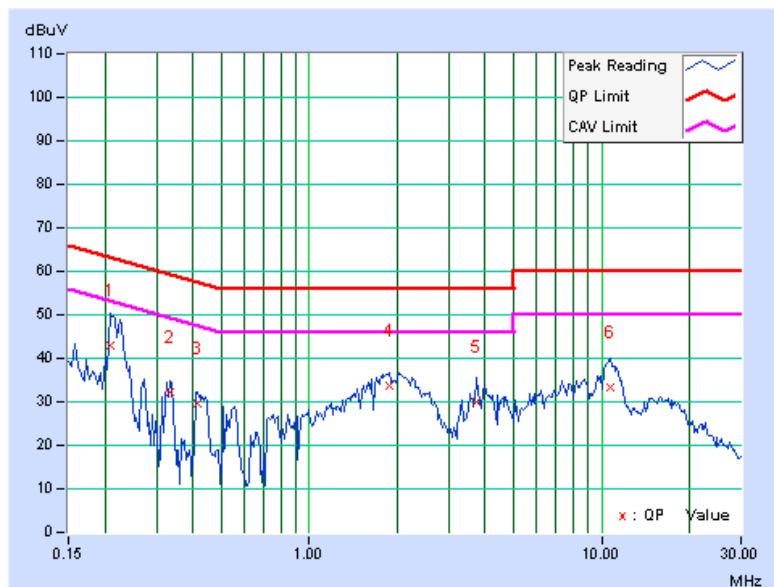

PHASE	Line 2	6dB BANDWIDTH	9kHz
-------	--------	---------------	------

No	Freq. [MHz]	Corr. Factor (dB)	Reading Value [dB (uV)]		Emission Level [dB (uV)]		Limit [dB (uV)]		Margin (dB)	
			Q.P.	AV.	Q.P.	AV.	Q.P.	AV.	Q.P.	AV.
1	0.213	0.13	46.13	-	46.26	-	63.11	53.11	-16.85	-
2	0.322	0.15	29.86	-	30.01	-	59.66	49.66	-29.65	-
3	0.529	0.17	20.85	-	21.02	-	56.00	46.00	-34.98	-
4	1.910	0.29	31.49	-	31.78	-	56.00	46.00	-24.22	-
5	3.906	0.36	27.07	-	27.43	-	56.00	46.00	-28.57	-
6	10.363	0.46	32.19	-	32.65	-	60.00	50.00	-27.35	-

- REMARKS:**
1. Q.P. and AV. are abbreviations of quasi-peak and average individually.
 2. "-": The Quasi-peak reading value also meets average limit and measurement with the average detector is unnecessary.
 3. The emission levels of other frequencies were very low against the limit.
 4. Margin value = Emission level - Limit value
 5. Correction factor = Insertion loss + Cable loss
 6. Emission Level = Correction Factor + Reading Value.

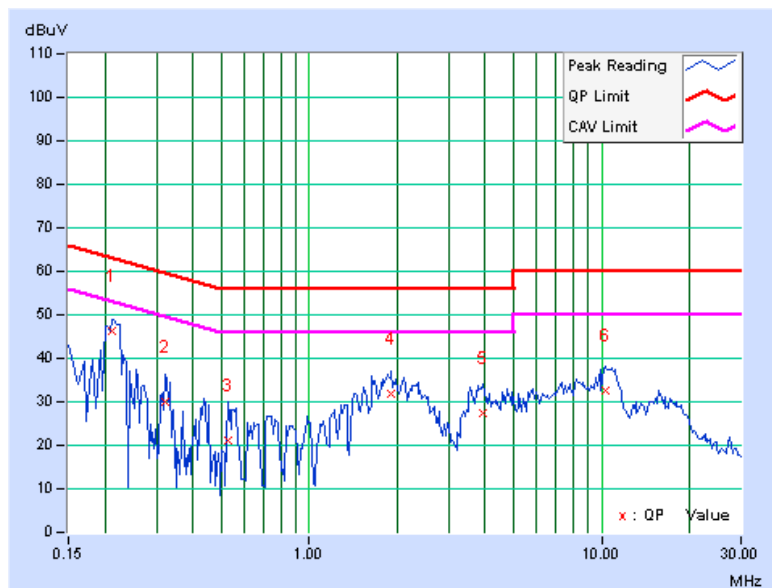



4.3 BAND EDGES MEASUREMENT

4.3.1 LIMITS OF BAND EDGES MEASUREMENT

Below -50dB of the highest emission level of operating band (in 100kHz Resolution Bandwidth).

4.3.2 TEST INSTRUMENTS

DESCRIPTION & MANUFACTURER	MODEL NO.	SERIAL NO.	DATE OF CALIBRATION	DUE DATE OF CALIBRATION
SPECTRUM ANALYZER R&S	FSP40	100040	Jul. 17, 2010	Jul. 16, 2011

NOTE: The calibration interval of the above test instruments is 12 months and the calibrations are traceable to NML/ROC and NIST/USA.

4.3.3 TEST PROCEDURE

The transmitter output was connected to the spectrum analyzer via a low lose cable. Set both RBW and VBW of spectrum analyzer to 100 kHz and 300 kHz with suitable frequency span including 100 MHz bandwidth from band edge. The band edges was measured and recorded.

The spectrum plots are attached on the following pages.

4.3.4 DEVIATION FROM TEST STANDARD

No deviation.

4.3.5 EUT OPERATING CONDITION

The software provided by client to enable the EUT under transmission condition continuously at lowest and highest channel frequencies individually.

4.3.6 TEST RESULTS

The spectrum plots are attached on the following images. D1 line indicates the highest level, and D2 line indicates the 50dB offset below D1. It shows compliance with the requirement in part 15.249 (d).

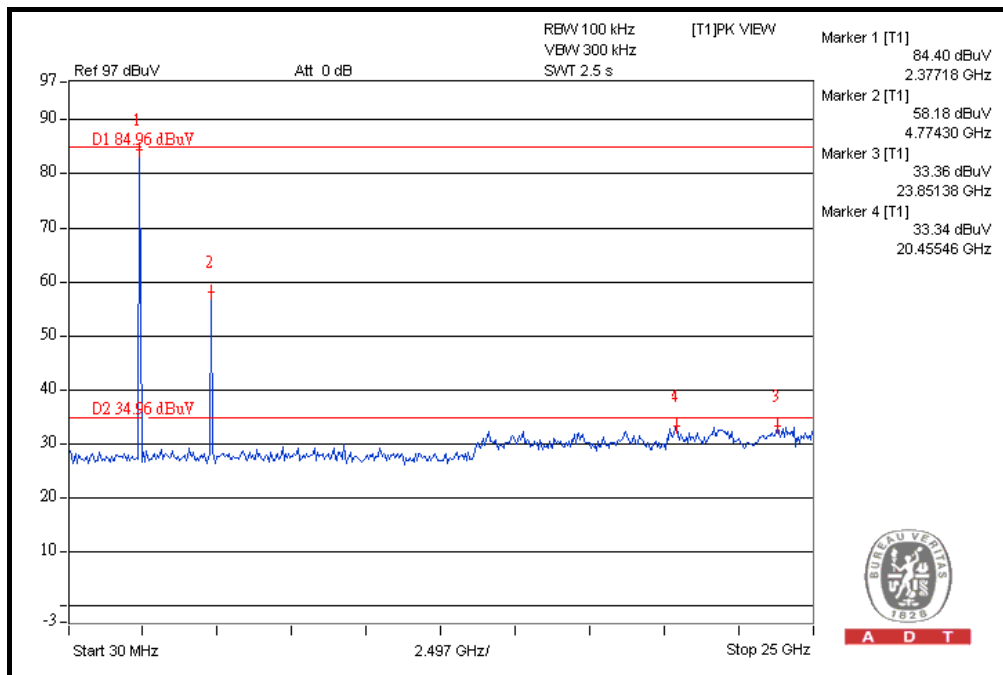
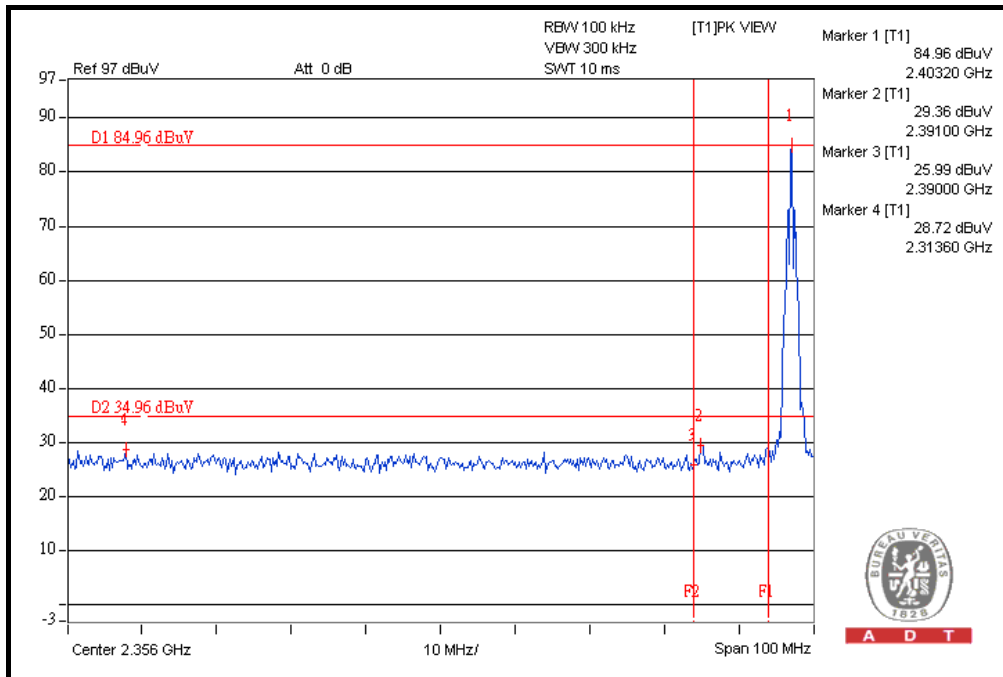



A D T

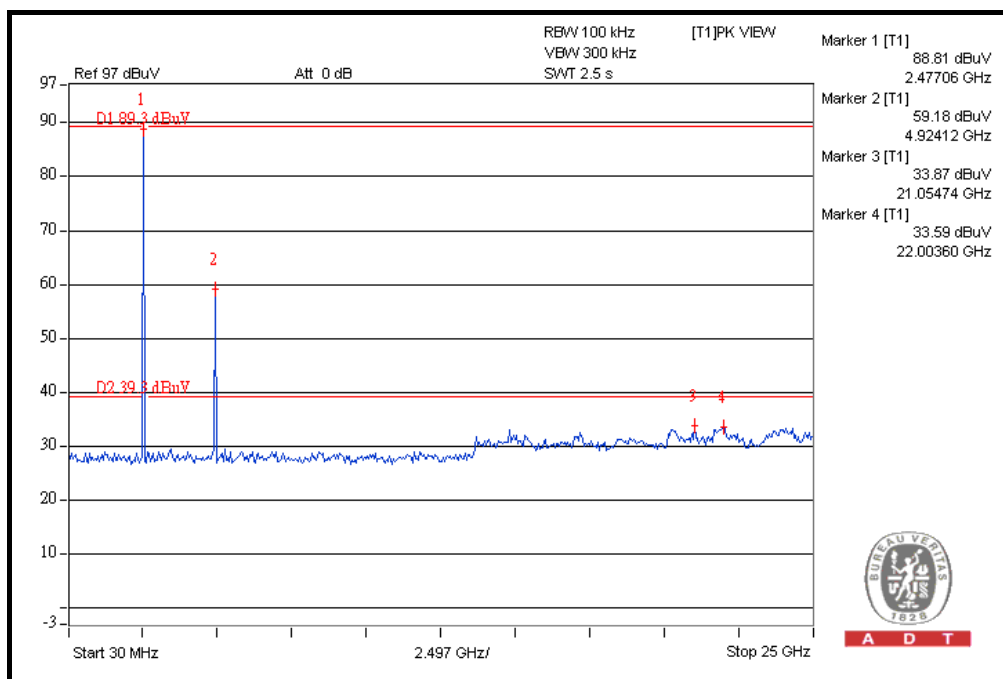
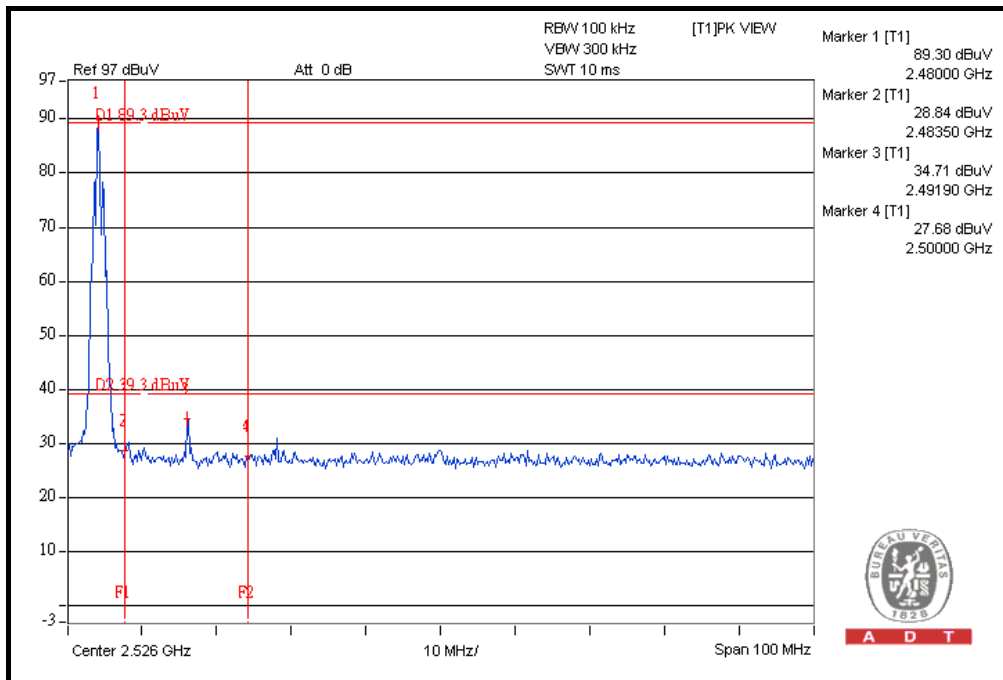

5. PHOTOGRAPHS OF THE TEST CONFIGURATION

Please refer to the attached file (Test Setup Photo).



6. INFORMATION ON THE TESTING LABORATORIES

We, Bureau Veritas Consumer Products Services (H.K.) Ltd., Taoyuan Branch, were founded in 1988 to provide our best service in EMC, Radio, Telecom and Safety consultation. Our laboratories are accredited and approved according to ISO/IEC 17025.

Copies of accreditation and authorization certificates of our laboratories obtained from approval agencies can be downloaded from our web site: www.adt.com.tw/index.5.phtml. If you have any comments, please feel free to contact us at the following:

Linko EMC/RF Lab

Tel: 886-2-26052180

Fax: 886-2-26051924

Hsin Chu EMC/RF Lab

Tel: 886-3-5935343

Fax: 886-3-5935342

Hwa Ya EMC/RF/Safety/Telecom Lab

Tel: 886-3-3183232

Fax: 886-3-3185050

Email: service.adt@tw.bureauveritas.com

Web Site: www.adt.com.tw

The address and road map of all our labs can be found in our web site also.

7. APPENDIX A - MODIFICATIONS RECORDERS FOR ENGINEERING CHANGES TO THE EUT BY THE LAB

No modifications were made to the EUT by the lab during the test.

---END---