

FCC Test Report

FCC ID : FDI000000024
Equipment : AirStation
Model No. : WMR-433
Brand Name : Buffalo Inc.
Applicant : Buffalo Inc.
Address : Akamon-dori Bldg, 30-20, Ohsu 3-chome,
Naka-ku, Nagoya 460-8315, Japan
Standard : 47 CFR FCC Part 15.407
Received Date : Feb. 18, 2014
Tested Date : Feb. 24 ~ Mar. 06, 2014

We, International Certification Corp., would like to declare that the tested sample has been evaluated and in compliance with the requirement of the above standards. The test results contained in this report refer exclusively to the product. It may be duplicated completely for legal use with the approval of the applicant. It shall not be reproduced except in full without the written approval of our laboratory.

Approved & Reviewed by:



Gary Chang / Manager



Table of Contents

1	GENERAL DESCRIPTION	5
1.1	Information.....	5
1.2	Local Support Equipment List	7
1.3	Test Setup Chart	7
1.4	The Equipment List	8
1.5	Testing Applied Standards	9
1.6	Measurement Uncertainty	9
2	TEST CONFIGURATION	10
2.1	Testing Condition	10
2.2	The Worst Test Modes and Channel Details	10
3	TRANSMITTER TEST RESULTS.....	11
3.1	Conducted Emissions.....	11
3.2	Emission Bandwidth	14
3.3	RF Output Power.....	16
3.4	Peak Power Spectral Density.....	18
3.5	Peak Excursion.....	20
3.6	Transmitter Radiated and Band Edge Emissions	23
3.7	Frequency Stability.....	46
4	TEST LABORATORY INFORMATION	48

Release Record

Report No.	Version	Description	Issued Date
FR421803AN	Rev. 01	Initial issue	Apr. 03, 2014

Summary of Test Results

FCC Rules	Test Items	Measured	Result
15.207	Conducted Emissions	[dBuV]: 0.181MHz 43.42 (Margin -11.04dB) - AV	Pass
15.407(b)(1)(2)(3) 15.209	Radiated Emissions	[dBuV/m at 3m]: 232.13MHz 42.93 (Margin -3.07dB) - PK	Pass
15.407(a)(1)(2)(3)	Emission Bandwidth	Meet the requirement of limit	Pass
15.407(a)(1)(2)(3)	RF Output Power	Power [dBm]: 5150~5250 MHz:14.33	Pass
15.407(a)(1)(2)(3)	Peak Power Spectral Density	Meet the requirement of limit	Pass
15.407(a)(6)	Peak Excursion	Meet the requirement of limit	Pass
15.407(g)	Frequency Stability	Meet the requirement of limit	Pass
15.203	Antenna Requirement	Meet the requirement of limit	Pass

1 General Description

1.1 Information

1.1.1 Specification of the Equipment under Test (EUT)

RF General Information					
IEEE Std. 802.11	Frequency Range (MHz)	Ch. Freq. (MHz)	Channel Number	Transmit Chains (N _{TX})	Data Rate / MCS
a	5150-5250	5180-5240	36-48 [4]	1	6-54 Mbps
n (HT20)	5150-5250	5180-5240	36-48 [4]	1	MCS 0-7
n (HT40)	5150-5250	5190-5230	38-46 [2]	1	MCS 0-7
ac (VHT20)	5150-5250	5180-5240	36-48 [4]	1	MCS 0-8
ac (VHT40)	5150-5250	5190-5230	38-46 [2]	1	MCS 0-9
ac (VHT80)	5150-5250	5210	42 [1]	1	MCS 0-9

Note 1: RF output power specifies that Maximum Conducted Output Power.
 Note 2: 802.11a/n uses a combination of OFDM-BPSK, QPSK, 16QAM, 64QAM, 256QAM modulation.

1.1.2 Antenna Details

Ant. No.	Model	Type	Connector	Operating Frequencies (MHz) / Antenna Gain (dBi)				
				2400~2483.5	5150~5250	5250~5350	5470~5725	5725~5850
1	ALA140-222020	PIFA	Murata	2.55	2.68	2.68	2.81	2.96

1.1.3 Power Supply Type of Equipment under Test (EUT)

Power Supply Type	5Vdc from host
--------------------------	----------------

1.1.4 Accessories

Accessories		
No.	Equipment	Description
1	USB Cable	0.3m shielded w/o core.

1.1.5 Channel List

802.11 a / HT20 / VHT20		HT40 / VHT40	
Channel	Frequency(MHz)	Channel	Frequency(MHz)
36	5180	38	5190
40	5200	46	5230
44	5220	VHT 80	
48	5240	42	42

1.1.6 Test Tool and Duty Cycle

Test Tool	MP_TEST, V1.3.8.0		
Duty Cycle and Duty Factor	Mode	Duty cycle (%)	Duty factor (dB)
	11a	100.00%	0.00
	VHT20	100.00%	0.00
	VHT40	100.00%	0.00
	VHT80	100.00%	0.00

1.1.7 Power Setting

Channel	Frequency(MHz)	11a	HT20	VHT20
CH 36	5180	43	43	43
CH 40	5200	43	43	43
CH 48	5240	42	42	42

Channel	Frequency(MHz)	HT40	VHT40	VHT80
CH 38	5190	44	44	---
CH 46	5230	43	43	---
CH 42	5210	---	---	43

1.2 Local Support Equipment List

Support Equipment List						
No.	Equipment	Brand	Model	S/N	FCC ID	Signal cable / Length (m)
1	Notebook	DELL	E6430	---	DoC	USB 0.3m shielded w/o core. RJ45, 1.5m non-shielded w/o core.

Note: The USB Cable was supplied by applicant.

1.3 Test Setup Chart

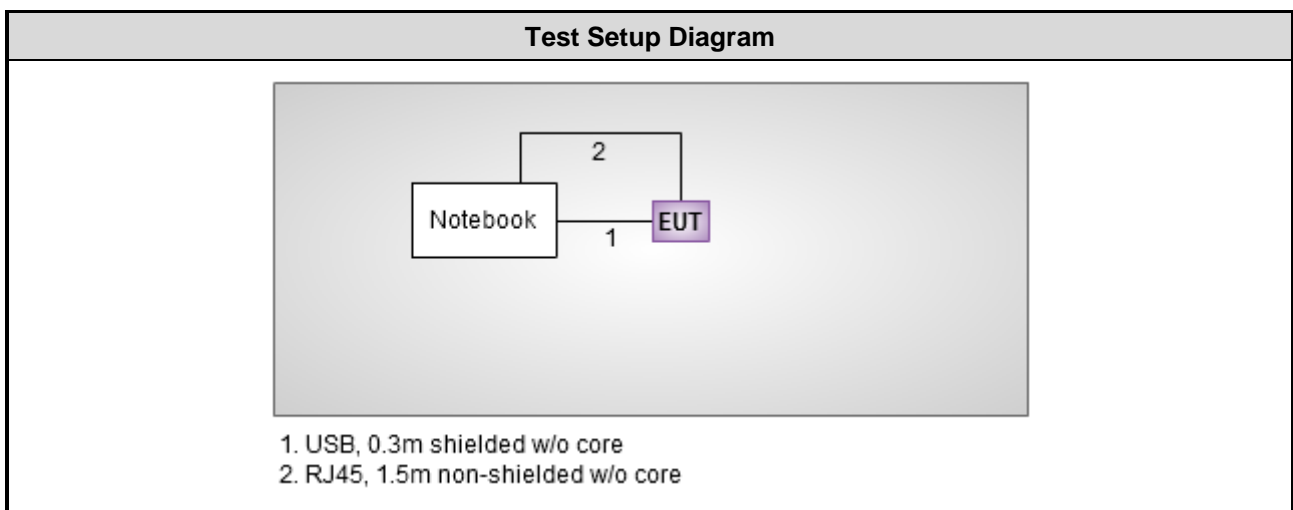

1.4 The Equipment List

Test Item	Conducted Emission				
Test Site	Conduction room 1 / (CO01-WS)				
Instrument	Manufacturer	Model No.	Serial No.	Calibration Date	Calibration Until
EMC Receiver	R&S	ESCS 30	100169	Oct. 15, 2013	Oct. 14, 2014
LISN	SCHWARZBECK	Schwarzbeck 8127	8127-667	Nov. 23, 2013	Nov. 22, 2014
LISN (Support Unit)	SCHWARZBECK	Schwarzbeck 8127	8127-666	Dec. 04, 2013	Dec. 03, 2014
RF Cable-CON	Woken	CFD200-NL	CFD200-NL-001	Apr. 24, 2013	Apr. 23, 2014
50 ohm terminal (Support Unit)	NA	50	04	Apr. 22, 2013	Apr. 21, 2014
Note: Calibration Interval of instruments listed above is one year.					

Test Item	Radiated Emission				
Test Site	966 chamber1 / (03CH01-WS)				
Instrument	Manufacturer	Model No.	Serial No.	Calibration Date	Calibration Until
Spectrum Analyzer	R&S	FSV40	101498	Jan. 25, 2014	Jan. 24, 2015
Receiver	R&S	ESR3	101658	Jan. 10, 2014	Jan. 09, 2015
Bilog Antenna	SCHWARZBECK	VULB9168	VULB9168-522	Jan. 02, 2014	Jan. 01, 2015
Horn Antenna 1G-18G	SCHWARZBECK	BBHA 9120 D	BBHA 9120 D 1096	Feb. 13, 2014	Feb. 12, 2015
Horn Antenna 18G-40G	SCHWARZBECK	BBHA 9170	BBHA 9170517	Dec. 27, 2013	Dec. 26, 2014
Preamplifier	Burgeon	BPA-530	SN:100219	Nov. 28, 2013	Nov. 27, 2014
Preamplifier	Agilent	83017A	MY39501308	Dec. 16, 2013	Dec. 15, 2014
Preamplifier	EM	EM18G40G	060572	Jun. 20, 2013	Jun. 19, 2014
RF Cable	HUBER+SUHNER	SUCOFLEX104	MY16014/4	Dec. 16, 2013	Dec. 15, 2014
RF Cable	HUBER+SUHNER	SUCOFLEX104	MY16019/4	Dec. 16, 2013	Dec. 15, 2014
RF Cable	HUBER+SUHNER	SUCOFLEX104	MY16139/4	Dec. 16, 2013	Dec. 15, 2014
LF cable 3M	Woken	CFD400NL-LW	CFD400NL-001	Dec. 16, 2013	Dec. 15, 2014
LF cable 10M	Woken	CFD400NL-LW	CFD400NL-002	Dec. 16, 2013	Dec. 15, 2014
Note: Calibration Interval of instruments listed above is one year.					

Test Item	Radiated Emission above 1GHz				
Test Site	966 chamber 2 / (03CH02-WS)				
Instrument	Manufacturer	Model No.	Serial No.	Calibration Date	Calibration Until
Loop Antenna	R&S	HFH2-Z2	100330	Nov. 15, 2012	Nov. 14, 2014
Note: Calibration Interval of instruments listed above is two year.					

Test Item	RF Conducted				
Test Site	(TH01-WS)				
Instrument	Manufacturer	Model No.	Serial No.	Calibration Date	Calibration Until
Spectrum Analyzer	R&S	FSV40	101063	Feb. 17, 2014	Feb. 16, 2015
TEMP&HUMIDITY CHAMBER	GIANT FORCE	GCT-225-40-SP-SD	MAF1212-002	Dec. 11, 2013	Dec. 10, 2014
Power Meter	Anritsu	ML2495A	1241002	Oct. 24, 2013	Oct. 23, 2014
Power Sensor	Anritsu	MA2411B	1207366	Oct. 24, 2013	Oct. 23, 2014
Note: Calibration Interval of instruments listed above is one year.					

1.5 Testing Applied Standards

According to the specification of EUT, the EUT must comply with following standards and KDB documents.

47 CFR FCC Part 15.407

ANSI C63.10-2009

FCC KDB 412172

FCC KDB 789033 D01 General UNII Test procedures v01r03

Note: The EUT has been tested and complied with FCC part 15B requirement. FCC Part 15B test results are issued to another report.

1.6 Measurement Uncertainty

ISO/IEC 17025 requires that an estimate of the measurement uncertainties associated with the emissions test results be included in the report. The measurement uncertainties given below are based on a 95% confidence level (based on a coverage factor ($k=2$))

Measurement Uncertainty	
Parameters	Uncertainty
Bandwidth	± 74.147 Hz
Conducted power	± 0.717 dB
Power density	± 2.687 dB
Frequency error	± 74.147 Hz
Temperature	± 0.3 °C
AC conducted emission	± 2.43 dB
Radiated emission	± 2.49 dB

2 Test Configuration

2.1 Testing Condition

Test Item	Test Site	Ambient Condition	Tested By
AC Conduction	CO01-WS	19°C / 65%	Skys Huang
Radiated Emissions	03CH01-WS	22-23°C / 64-65%	Haru Yang
RF Conducted	TH01-WS	22°C / 61%	Felix Sung

➤ FCC site registration No.: 657002

➤ IC site registration No.: 10807A-1

2.2 The Worst Test Modes and Channel Details

Test item	Modulation Mode	Test Frequency (MHz)	Data Rate (Mbps) / MCS	Test Configuration
Conducted Emissions	VHT20	5240	6 Mbps	---
Radiated Emissions ≤1GHz	VHT20	5240	6 Mbps	---
RF Output Power	11a	5180 / 5200 / 5240	6 Mbps	---
	HT20	5180 / 5200 / 5240	MCS 0	---
	HT40	5190 / 5230	MCS 0	---
	VHT20	5180 / 5200 / 5240	MCS 0	---
	VHT40	5190 / 5230	MCS 0	---
	VHT80	5210	MCS 0	---
Radiated Emissions >1GHz Emission Bandwidth Peak Power Spectral Density	11a	5180 / 5200 / 5240	6 Mbps	---
	HT20	5180 / 5200 / 5240	MCS 0	---
	HT40	5190 / 5230	MCS 0	---
	VHT80	5210	MCS 0	---
Peak Excursion	11a	5240	6 Mbps	---
	VHT20	5240	MCS 0	---
	VHT40	5190	MCS 0	---
	VHT80	5210 / 5290 / 5530	MCS 0	---
Frequency Stability	Un-modulation	5200	---	---

3 Transmitter Test Results

3.1 Conducted Emissions

3.1.1 Limit of Conducted Emissions

Conducted Emissions Limit		
Frequency Emission (MHz)	Quasi-Peak	Average
0.15-0.5	66 - 56 *	56 - 46 *
0.5-5	56	46
5-30	60	50

Note 1: * Decreases with the logarithm of the frequency.

3.1.2 Test Procedures

1. The device is placed on a test table, raised 80 cm above the reference ground plane. The vertical conducting plane is located 40 cm to the rear of the device.
2. The device is connected to line impedance stabilization network (LISN) and other accessories are connected to other LISN. Measured levels of AC power line conducted emission are across the 50 Ω LISN port.
3. AC conducted emission measurements is made over frequency range from 150 kHz to 30 MHz.
4. This measurement was performed with AC 120V/60Hz

3.1.3 Test Setup



Note: 1. Support units were connected to second LISN.

2. Both of LISNs (AMN) are 80 cm from EUT and at least 80 cm from other units and other metal planes

3.1.4 Test Result of Conducted Emissions

Modulation	VHT20	Test Freq. (MHz)	5240
Power Phase	Line		

Date: 2014-03-03

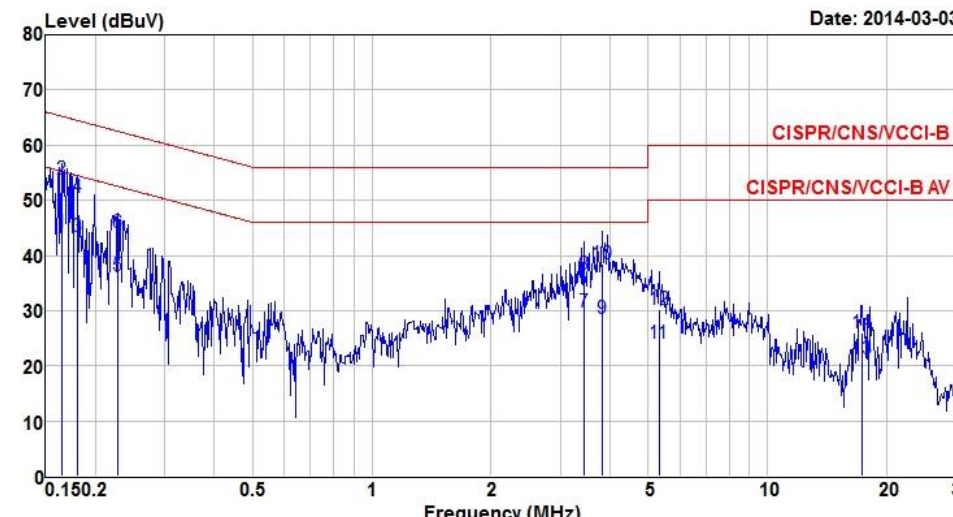

	Freq	Level	Limit	Over	Read	LISN	cable	Remark
	MHz	dBuV	Line	Limit	Level	factor	loss	
			dBuV	dB	dBuV	dB	dB	
1	0.164	44.14	55.25	-11.11	43.64	0.40	0.10	Average
2	0.164	53.84	65.25	-11.41	53.34	0.40	0.10	QP
3*	0.181	43.42	54.46	-11.04	42.89	0.39	0.14	Average
4	0.181	50.47	64.46	-13.99	49.94	0.39	0.14	QP
5	0.228	36.25	52.52	-16.27	35.70	0.39	0.16	Average
6	0.228	44.03	62.52	-18.49	43.48	0.39	0.16	QP
7	3.436	29.69	46.00	-16.31	29.02	0.45	0.22	Average
8	3.436	36.70	56.00	-19.30	36.03	0.45	0.22	QP
9	3.820	28.63	46.00	-17.37	27.94	0.46	0.23	Average
10	3.820	38.52	56.00	-17.48	37.83	0.46	0.23	QP
11	5.333	24.09	50.00	-25.91	23.41	0.48	0.20	Average
12	5.333	30.31	60.00	-29.69	29.63	0.48	0.20	QP
13	17.383	21.18	50.00	-28.82	20.47	0.55	0.16	Average
14	17.383	26.04	60.00	-33.96	25.33	0.55	0.16	QP

Note 1: Level (dBuV) = Read Level (dBuV) + LISN Factor (dB) + Cable Loss (dB).
 Note 2: Over Limit (dB) = Level (dBuV) – Limit Line (dBuV).

Modulation	VHT20	Test Freq. (MHz)	5240
Power Phase	Neutral		

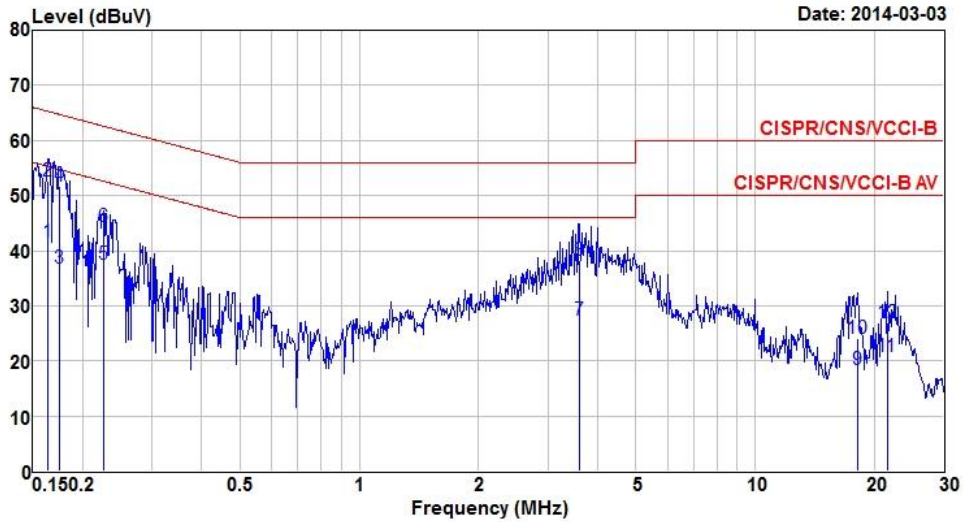

	Freq	Level	Limit	Over	Read	LISN	cable	
	MHz	dBuV	Line	Limit	Level	factor	loss	Remark
			dBuV	dB	dBuV	dB	dB	
1	0.163	41.61	55.30	-13.69	41.04	0.48	0.09	Average
2*	0.163	52.63	65.30	-12.67	52.06	0.48	0.09	QP
3	0.175	36.88	54.72	-17.84	36.27	0.48	0.13	Average
4	0.175	51.73	64.72	-12.99	51.12	0.48	0.13	QP
5	0.226	37.48	52.61	-15.13	36.84	0.48	0.16	Average
6	0.226	44.29	62.61	-18.32	43.65	0.48	0.16	QP
7	3.603	27.41	46.00	-18.59	26.66	0.52	0.23	Average
8	3.603	38.28	56.00	-17.72	37.53	0.52	0.23	QP
9	18.232	18.52	50.00	-31.48	17.79	0.56	0.17	Average
10	18.232	24.09	60.00	-35.91	23.36	0.56	0.17	QP
11	21.600	20.76	50.00	-29.24	19.91	0.55	0.30	Average
12	21.600	26.99	60.00	-33.01	26.14	0.55	0.30	QP

Note 1: Level (dBuV) = Read Level (dBuV) + LISN Factor (dB) + Cable Loss (dB).
 Note 2: Over Limit (dB) = Level (dBuV) – Limit Line (dBuV).

3.2 Emission Bandwidth

3.2.1 Test Procedures

1. Set RBW = approximately 1% of the emission bandwidth.
2. Set the VBW > RBW, Detector = Peak.
3. Trace mode = max hold.
4. Measure the maximum width of the emission that is 26 dB down from the peak of the emission.

3.2.2 Test Setup

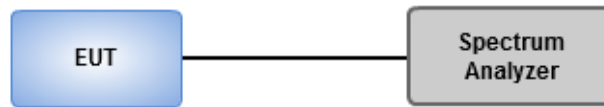

3.2.3 Test Result of Emission Bandwidth

Emission Bandwidth										
Mode	N _{TX}	Freq. (MHz)	26dB Bandwidth (MHz)			99% Bandwidth (MHz)			Power Limit (dBm)	
			Chain 0	Chain 1	Chain 2	Chain 0	Chain 1	Chain 2	26dB BW	99% BW
11a	1	5180	21.28	---	---	16.75	---	---	17.00	16.24
11a	1	5200	21.28	---	---	16.79	---	---	17.00	16.25
11a	1	5240	21.33	---	---	16.75	---	---	17.00	16.24
VHT20	1	5180	22.03	---	---	17.87	---	---	17.00	16.52
VHT20	1	5200	22.03	---	---	17.87	---	---	17.00	16.52
VHT20	1	5240	21.97	---	---	17.87	---	---	17.00	16.52
VHT40	1	5190	45.33	---	---	36.92	---	---	17.00	17.00
VHT40	1	5230	45.33	---	---	37.12	---	---	17.00	17.00
VHT80	1	5210	84.41	---	---	75.90	---	---	17.00	17.00

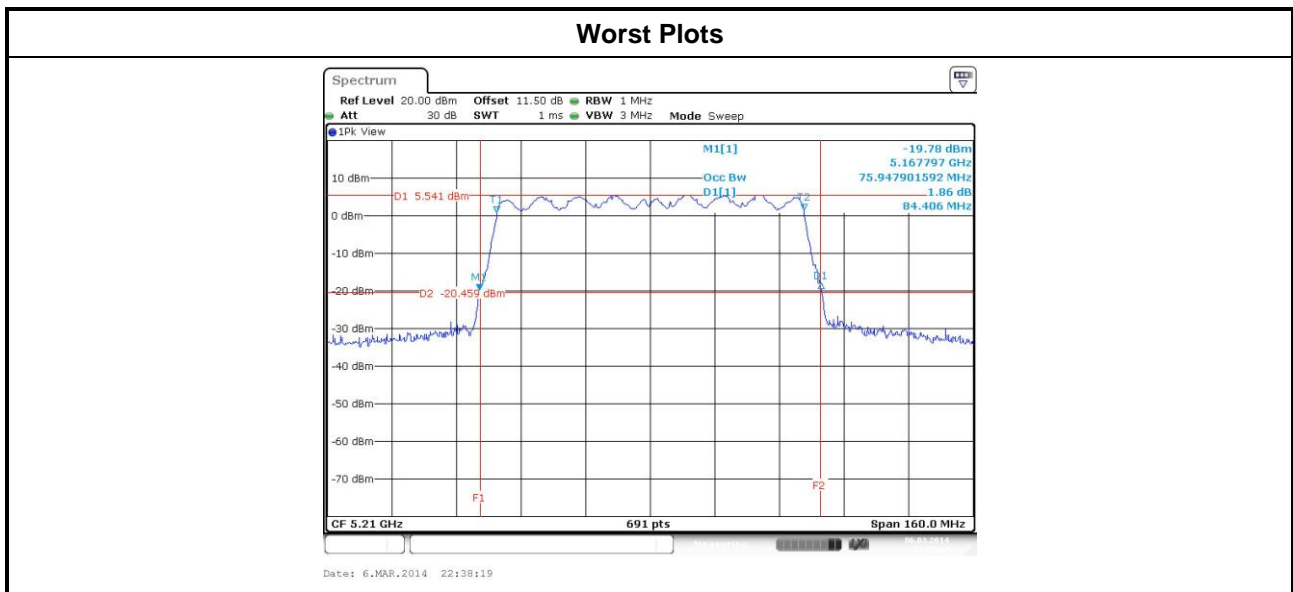

3.3 RF Output Power

3.3.1 Limit of RF Output Power

Frequency Band (GHz)		Limit
<input checked="" type="checkbox"/>	5.15~5.25	50mW or 4dBm+10 log B
<input type="checkbox"/>	5.25~5.35	250mW or 11dBm+10 log B
<input type="checkbox"/>	5.47~5.725	250mW or 11dBm+10 log B

Note: "B" is the 26dB emission bandwidth in MHz.

3.3.2 Test Procedures

- Power meter**
 - Measurements is performed using a wideband gated RF power meter provided that the gate parameters are adjusted such that the power is measured only when the EUT is transmitting at its maximum power control level. Since the measurement is made only during the ON time of the transmitter, no duty cycle correction factor is required

3.3.3 Test Setup

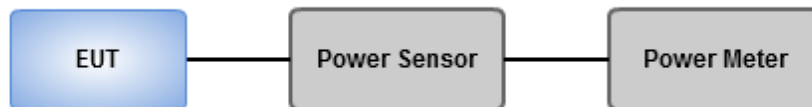

3.3.4 Test Result of Maximum Conducted Output Power

RF Output Power (dBm)								
Mode	N _{TX}	Freq. (MHz)	Chain 0	Chain 1	Chain 2	Total Power (mW)	Total Power (dBm)	Limit
11a	1	5180	14.18	---	---	26.182	14.18	17.00
11a	1	5200	14.27	---	---	26.730	14.27	17.00
11a	1	5240	14.31	---	---	26.977	14.31	17.00
HT20	1	5180	14.11	---	---	25.763	14.11	17.00
HT20	1	5200	14.26	---	---	26.669	14.26	17.00
HT20	1	5240	14.28	---	---	26.792	14.28	17.00
HT40	1	5190	14.15	---	---	26.002	14.15	17.00
HT40	1	5230	14.12	---	---	25.823	14.12	17.00
VHT20	1	5180	14.15	---	---	26.002	14.15	17.00
VHT20	1	5200	14.32	---	---	27.040	14.32	17.00
VHT20	1	5240	14.33	---	---	27.102	14.33	17.00
VHT40	1	5190	14.19	---	---	26.242	14.19	17.00
VHT40	1	5230	14.16	---	---	26.062	14.16	17.00
VHT80	1	5210	14.26	---	---	26.669	14.26	17.00

3.4 Peak Power Spectral Density

3.4.1 Limit of Peak Power Spectral Density

	Frequency Band (GHz)	Limit (dBm)
<input checked="" type="checkbox"/>	5.15~5.25	4
<input type="checkbox"/>	5.25~5.35	11
<input type="checkbox"/>	5.47~5.725	11

3.4.2 Test Procedures

Method SA-1

1. Set RBW = 1 MHz, VBW = 3 MHz, Sweep time = auto, Detector = RMS.
2. Trace average 100 traces.
3. Use the peak marker function to determine the maximum amplitude level.

Method SA-2

1. Set RBW = 1 MHz, VBW = 3 MHz, Detector = RMS.
2. Set sweep time $\geq 10 * (\text{number of points in sweep}) * (\text{symbol period of the transmitted signal})$.
3. Perform a single sweep.
4. Use the peak marker function to determine the maximum amplitude level.

Method SA-2 Alternative

1. Set RBW = 1 MHz, VBW = 3 MHz, Detector = RMS.
2. Set sweep time $\geq 10 * (\text{number of points in sweep}) * (\text{total on/off period of the transmitted signal})$.
3. Perform a single sweep.
4. Use the peak marker function to determine the maximum amplitude level.
5. Add $10 \log(1/x)$, where x is the duty cycle.

3.4.3 Test Setup

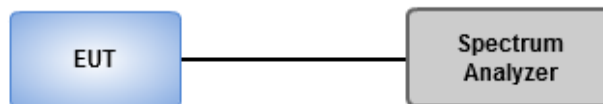

3.4.4 Test Result of Peak Power Spectral Density

Condition			Peak Power Spectral Density (dBm)			
Modulation Mode	N _{TX}	Freq. (MHz)	PPSD w/o D.F (dBm)	Duty factor (dB)	PPSD with D.F (dBm)	PPSD Limit (dBm)
11a	1	5180	1.69	0.00	1.69	4
11a	1	5200	1.89	0.00	1.89	4
11a	1	5240	2.22	0.00	2.22	4
HT20	1	5180	1.39	0.00	1.39	4
HT20	1	5200	1.52	0.00	1.52	4
HT20	1	5240	1.99	0.00	1.99	4
HT40	1	5190	-1.74	0.00	-1.74	4
HT40	1	5230	-1.27	0.00	-1.27	4
VHT80	1	5210	-4.08	0.00	-4.08	4

Note: D.F is duty factor

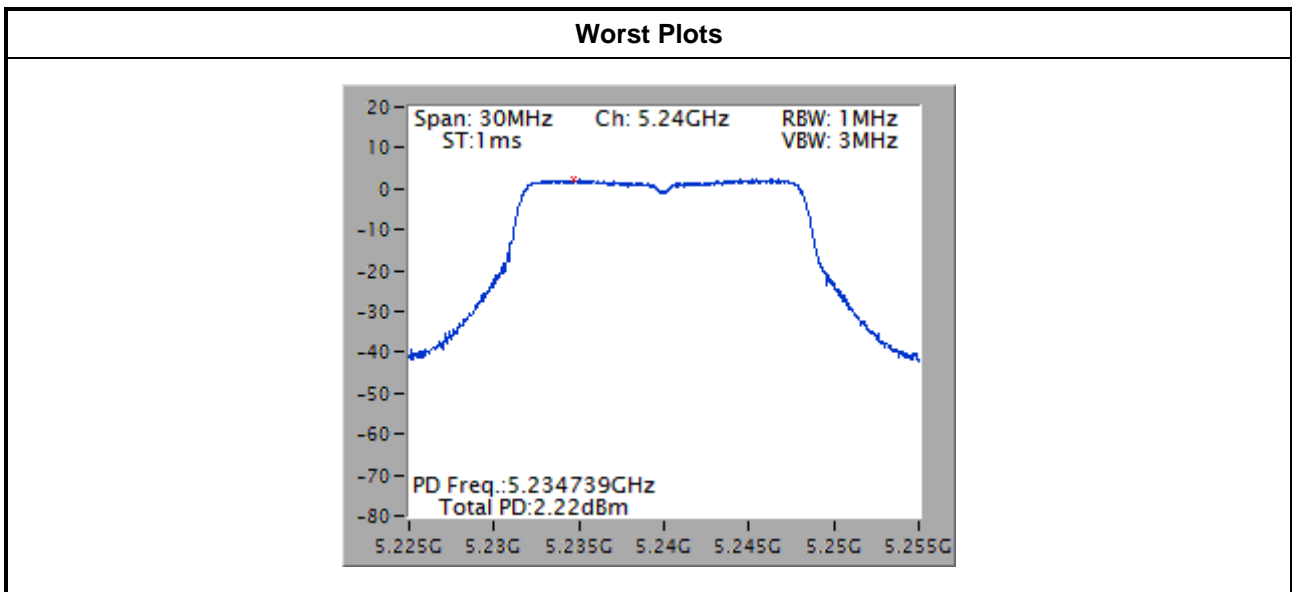

Note: Power density plot without duty factor

3.5 Peak Excursion

3.5.1 Peak Excursion Limit

Peak excursion of the modulation envelope shall not exceed 13 dB across any 1 MHz bandwidth.

3.5.2 Test Procedures

1. Set RBW = 1 MHz, VBW = 3 MHz, Detector = peak.
2. Trace mode = max-hold. Allow the sweeps to continue until the trace stabilizes.
3. Use the peak search function to find the peak of the spectrum.
4. Use the procedure of section 3.4.2 to measure the PPSD.
5. Compute the ratio of the maximum of the peak-max-hold spectrum to the PPSD

3.5.3 Test Setup

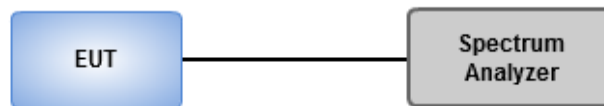

3.5.4 Test Result of Peak Excursion

Frequency band(MHz)		5150~5250					
Mode	Modulation Mode	N _{TX}	Freq. (MHz)	Measured value(dB)	Duty factor (dB)	Peak Excursion (dB)	Limit
11a	BPSK	1	5240	6.96	0.00	6.96	13
11a	QPSK	1	5240	8.92	0.00	8.92	13
11a	16QAM	1	5240	7.95	0.00	7.95	13
11a	64QAM	1	5240	9	0.00	9.00	13
VHT20	BPSK	1	5240	7.22	0.00	7.22	13
VHT20	QPSK	1	5240	8	0.00	8.00	13
VHT20	16QAM	1	5240	8.08	0.00	8.08	13
VHT20	64QAM	1	5240	9.04	0.00	9.04	13
VHT20	256QAM	1	5240	7.95	0.00	7.95	13
VHT40	BPSK	1	5230	6.86	0.00	6.86	13
VHT40	QPSK	1	5230	8.42	0.00	8.42	13
VHT40	16QAM	1	5230	8.19	0.00	8.19	13
VHT40	64QAM	1	5230	9.17	0.00	9.17	13
VHT40	256QAM	1	5230	9.28	0.00	9.28	13
VHT80	BPSK	1	5210	7.54	0.00	7.54	13
VHT80	QPSK	1	5210	7.83	0.00	7.83	13
VHT80	16QAM	1	5210	8.58	0.00	8.58	13
VHT80	64QAM	1	5210	7.57	0.00	7.57	13
VHT80	256QAM	1	5210	8.86	0.00	8.86	13

Note: Measured value = Peak-max-hold spectrum to the maximum of the average spectrum for continuous transmission. If the duty cycle is < 98 %, duty factor is required to average spectrum
Peak exclusion = Measured value – duty factor

Worst Plots

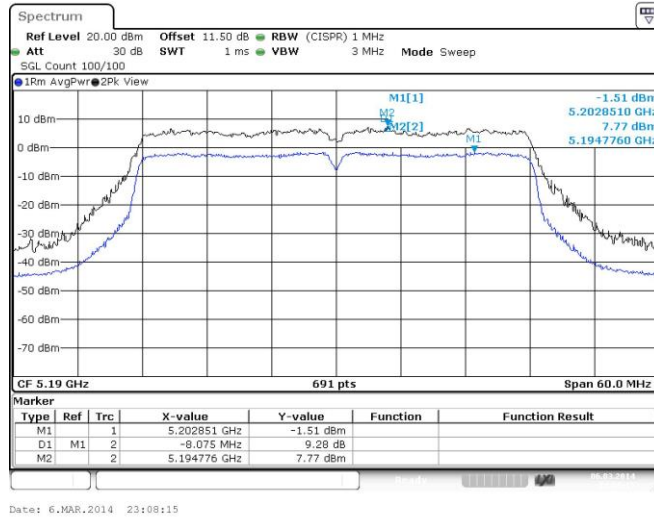

3.6 Transmitter Radiated and Band Edge Emissions

3.6.1 Limit of Transmitter Radiated and Band Edge Emissions

Restricted Band Emissions Limit			
Frequency Range (MHz)	Field Strength (uV/m)	Field Strength (dBuV/m)	Measure Distance (m)
0.009~0.490	2400/F(kHz)	48.5 - 13.8	300
0.490~1.705	24000/F(kHz)	33.8 - 23	30
1.705~30.0	30	29	30
30~88	100	40	3
88~216	150	43.5	3
216~960	200	46	3
Above 960	500	54	3

Note 1:
Qusai-Peak value is measured for frequency below 1GHz except for 9–90 kHz, 110–490 kHz frequency band. Peak and average value are measured for frequency above 1GHz. The limit on average radio frequency emission is as above table. The limit on peak radio frequency emissions is 20 dB above the maximum permitted average emission limit

Note 2:
Measurements may be performed at a distance other than what is specified provided. When performing measurements at a distance other than that specified, the results shall be extrapolated to the specified distance using an extrapolation factor as below, Frequency at or above 30 MHz: 20 dB/decade Frequency below 30 MHz: 40 dB/decade.

Un-restricted band emissions above 1GHz Limit	
Operating Band	Limit
5.15 - 5.25 GHz	e.i.r.p. -27 dBm [68.2 dBuV/m@3m]
5.25 - 5.35 GHz	e.i.r.p. -27 dBm [68.2 dBuV/m@3m]
5.47 - 5.725 GHz	e.i.r.p. -27 dBm [68.2 dBuV/m@3m]
5.725 - 5.825 GHz	5.715 5.725 GHz: e.i.r.p. -17 dBm [78.2 dBuV/m@3m] 5.825 5.835 GHz: e.i.r.p. -17 dBm [78.2 dBuV/m@3m] Other un-restricted band: e.i.r.p. -27 dBm [68.2 dBuV/m@3m]

Note 1: Measurements may be performed at a distance other than the limit distance provided they are not performed in the near field and the emissions to be measured can be detected by the measurement equipment. When performing measurements at a distance other than that specified, the results shall be extrapolated to the specified distance using an extrapolation factor of 20 dB/decade (inverse of linear distance for field-strength measurements, inverse of linear distance-squared for power-density measurements).

3.6.2 Test Procedures

1. Measurement is made at a semi-anechoic chamber that incorporates a turntable allowing a EUT rotation of 360°. A continuously-rotating, remotely-controlled turntable is installed at the test site to support the EUT and facilitate determination of the direction of maximum radiation for each EUT emission frequency. The EUT is placed at a height of 0.8 m test table above the ground plane.
2. Measurement is made with the antenna positioned in both the horizontal and vertical planes of polarization. The measurement antenna is varied in height (1m ~ 4m) above the reference ground plane to obtain the maximum signal strength. Distance between EUT and antenna is 3 m.
3. This investigation is performed with the EUT rotated 360°, the antenna height scanned between 1 m and 4 m, and the antenna rotated to repeat the measurements for both the horizontal and vertical antenna polarizations.

Note:

1. 120kHz measurement bandwidth of test receiver and Quasi-peak detector is for radiated emission below 1GHz.
2. RBW=1MHz, VBW=3MHz and Peak detector is for peak measured value of radiated emission above 1GHz.
3. RBW=1MHz, VBW=1/T and Peak detector is for average measured value of radiated emission above 1GHz.

3.6.3 Test Setup

Radiated Emissions below 1 GHz

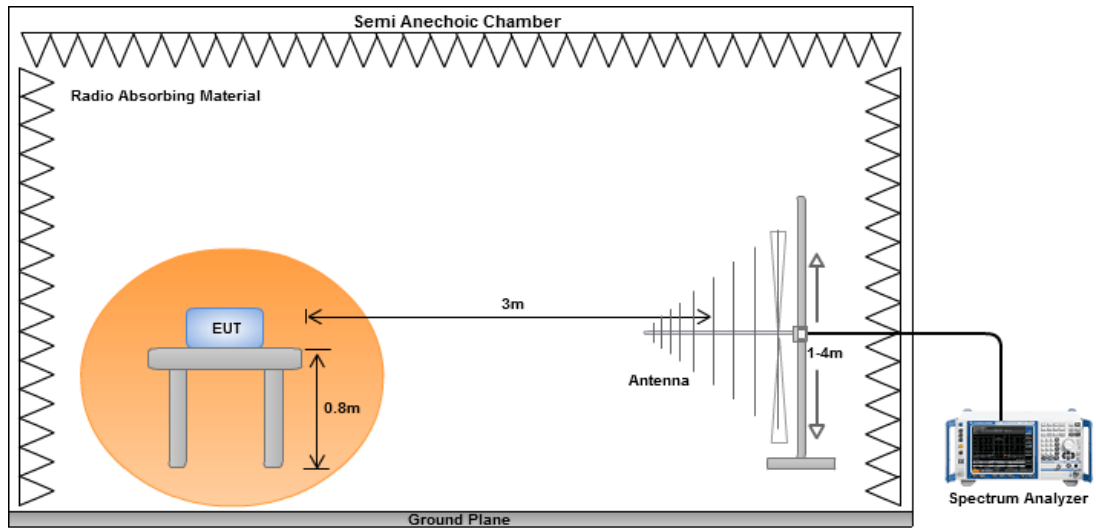

Radiated Emissions above 1 GHz

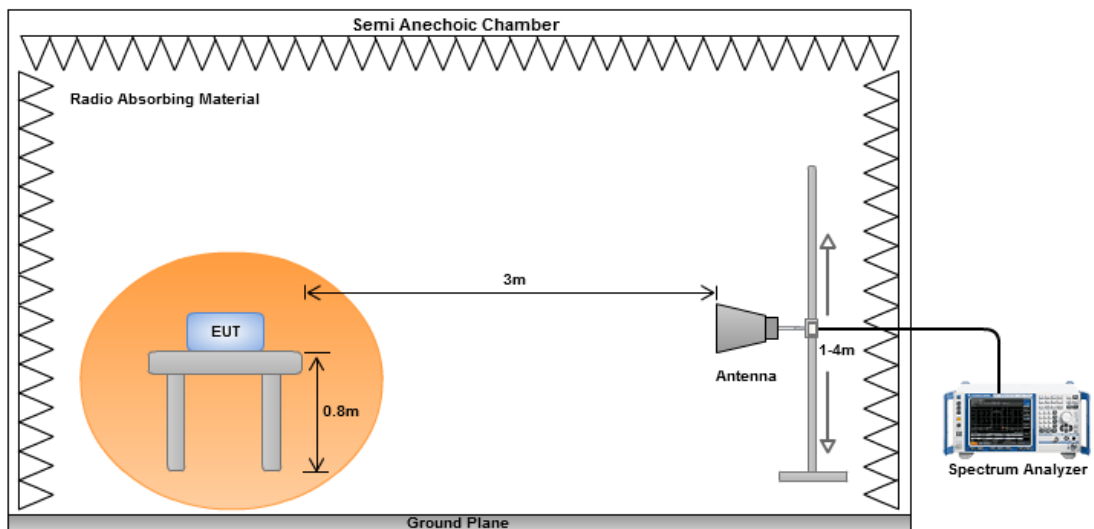

3.6.4 Transmitter Radiated Unwanted Emissions (Below 1GHz)

Modulation	VHT20	Test Freq. (MHz)	5240
Polarization	Horizontal		

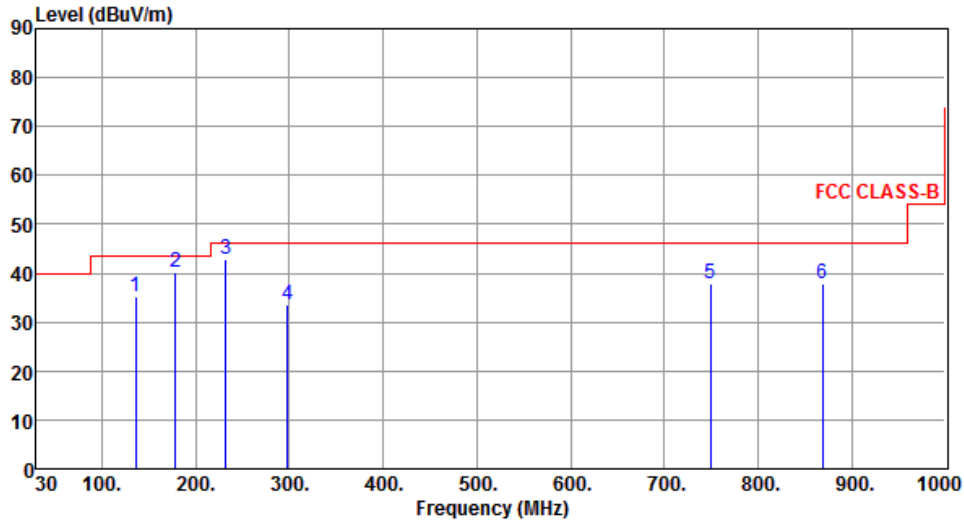

	Freq. MHz	Emission level dBuV/m	Limit dBuV/m	Margin dB	SA reading dBuV	Factor dB	Remark	ANT High cm	Turn Table deg
1	135.72	35.18	43.50	-8.32	52.88	-17.70	Peak	---	---
2	178.64	40.28	43.50	-3.22	58.65	-18.37	QP	---	---
3	232.13	42.93	46.00	-3.07	61.41	-18.48	Peak	---	---
4	298.31	33.67	46.00	-12.33	49.87	-16.20	Peak	---	---
5	749.42	37.91	46.00	-8.09	45.16	-7.25	Peak	---	---
6	868.58	37.91	46.00	-8.09	43.82	-5.91	Peak	---	---

Note 1: Emission Level (dBuV/m) = SA Reading (dBuV/m) + Factor* (dB)

*Factor includes antenna factor , cable loss and amplifier gain

Note 2: Margin (dB) = Emission level (dBuV/m) – Limit (dBuV/m).

Note 3: All spurious emissions below 30MHz are more than 20 dB below the limit.

Modulation	VHT20	Test Freq. (MHz)	5240
Polarization	Vertical		

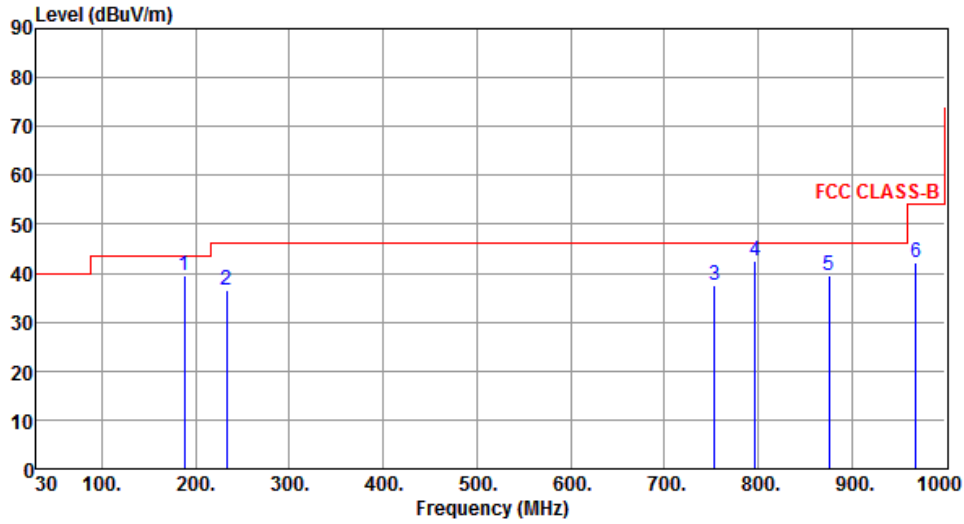

	Freq. MHz	Emission level dBuV/m	Limit dBuV/m	Margin dB	SA reading dBuV	Factor dB	Remark	ANT High cm	Turn Table deg
1	188.29	39.51	43.50	-3.99	58.91	-19.40	Peak	---	---
2	232.61	36.54	46.00	-9.46	55.01	-18.47	Peak	---	---
3	753.46	37.63	46.00	-8.37	44.83	-7.20	Peak	---	---
4	797.13	42.52	46.00	-3.48	49.32	-6.80	Peak	---	---
5	875.41	39.46	46.00	-6.54	45.28	-5.82	Peak	---	---
6	968.49	42.23	54.00	-11.77	46.81	-4.58	Peak	---	---

Note 1: Emission Level (dBuV/m) = SA Reading (dBuV/m) + Factor* (dB)

*Factor includes antenna factor , cable loss and amplifier gain

Note 2: Margin (dB) = Emission level (dBuV/m) – Limit (dBuV/m).

Note 3: All spurious emissions below 30MHz are more than 20 dB below the limit.

3.6.5 Transmitter Radiated Unwanted Emissions (Above 1GHz) for 11a

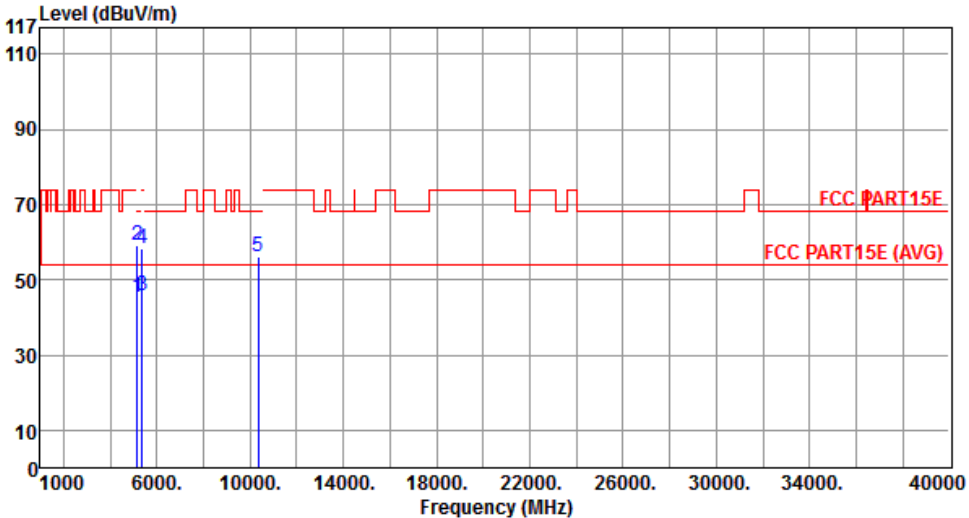
Modulation	11a	Test Freq. (MHz)	5180																																																																
Polarization	Horizontal																																																																		
																																																																			
	<table border="1"> <thead> <tr> <th>Freq.</th> <th>Emission level</th> <th>Limit</th> <th>Margin</th> <th>SA reading</th> <th>Factor</th> <th>Remark</th> <th>ANT High cm</th> <th>Turn Table deg</th> </tr> <tr> <th>MHz</th> <th>dBuV/m</th> <th>dBuV/m</th> <th>dB</th> <th>dBuV</th> <th>dB</th> <th></th> <th></th> <th></th> </tr> </thead> <tbody> <tr> <td>1</td> <td>5150.00</td> <td>45.50</td> <td>54.00</td> <td>-8.50</td> <td>39.94</td> <td>5.56</td> <td>Average</td> <td>---</td> </tr> <tr> <td>2</td> <td>5150.00</td> <td>59.22</td> <td>74.00</td> <td>-14.78</td> <td>53.66</td> <td>5.56</td> <td>Peak</td> <td>---</td> </tr> <tr> <td>3</td> <td>5380.00</td> <td>45.57</td> <td>54.00</td> <td>-8.43</td> <td>39.84</td> <td>5.73</td> <td>Average</td> <td>---</td> </tr> <tr> <td>4</td> <td>5380.00</td> <td>58.49</td> <td>74.00</td> <td>-15.51</td> <td>52.76</td> <td>5.73</td> <td>Peak</td> <td>---</td> </tr> <tr> <td>5</td> <td>10360.00</td> <td>55.97</td> <td>68.20</td> <td>-12.23</td> <td>40.90</td> <td>15.07</td> <td>Peak</td> <td>---</td> </tr> </tbody> </table>	Freq.	Emission level	Limit	Margin	SA reading	Factor	Remark	ANT High cm	Turn Table deg	MHz	dBuV/m	dBuV/m	dB	dBuV	dB				1	5150.00	45.50	54.00	-8.50	39.94	5.56	Average	---	2	5150.00	59.22	74.00	-14.78	53.66	5.56	Peak	---	3	5380.00	45.57	54.00	-8.43	39.84	5.73	Average	---	4	5380.00	58.49	74.00	-15.51	52.76	5.73	Peak	---	5	10360.00	55.97	68.20	-12.23	40.90	15.07	Peak	---			
Freq.	Emission level	Limit	Margin	SA reading	Factor	Remark	ANT High cm	Turn Table deg																																																											
MHz	dBuV/m	dBuV/m	dB	dBuV	dB																																																														
1	5150.00	45.50	54.00	-8.50	39.94	5.56	Average	---																																																											
2	5150.00	59.22	74.00	-14.78	53.66	5.56	Peak	---																																																											
3	5380.00	45.57	54.00	-8.43	39.84	5.73	Average	---																																																											
4	5380.00	58.49	74.00	-15.51	52.76	5.73	Peak	---																																																											
5	10360.00	55.97	68.20	-12.23	40.90	15.07	Peak	---																																																											
<p>Note 1: Emission Level (dBuV/m) = SA Reading (dBuV/m) + Factor* (dB) *Factor includes antenna factor , cable loss and amplifier gain Note 2: Margin (dB) = Emission level (dBuV/m) – Limit (dBuV/m).</p>																																																																			

Modulation	11a	Test Freq. (MHz)	5180
Polarization	Vertical		

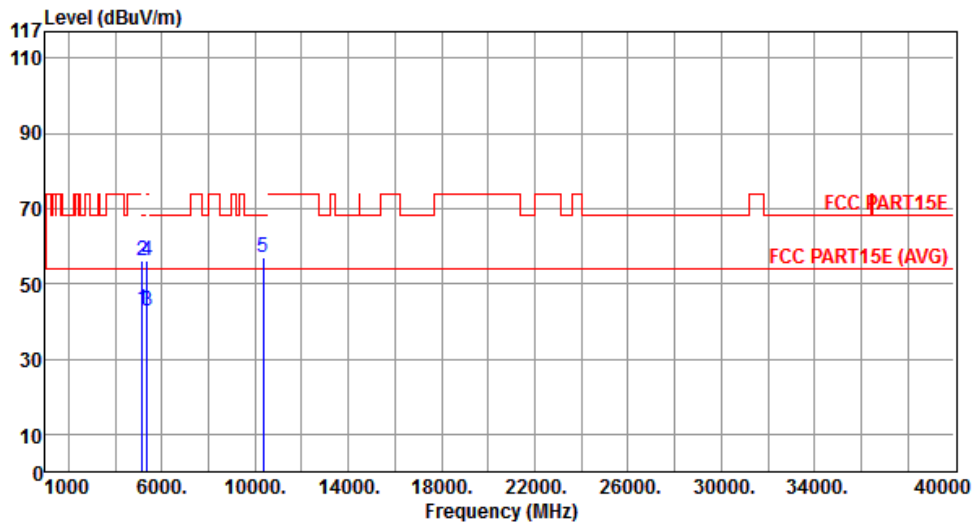

	Freq. MHz	Emission level dBuV/m	Limit dBuV/m	Margin dB	SA reading dBuV	Factor dB	Remark	ANT High cm	Turn Table deg
1	5150.00	43.19	54.00	-10.81	37.63	5.56	Average	---	---
2	5150.00	56.15	74.00	-17.85	50.59	5.56	Peak	---	---
3	5380.00	42.60	54.00	-11.40	36.87	5.73	Average	---	---
4	5380.00	55.93	74.00	-18.07	50.20	5.73	Peak	---	---
5	10360.00	57.14	68.20	-11.06	42.07	15.07	Peak	---	---

Note 1: Emission Level (dBuV/m) = SA Reading (dBuV/m) + Factor* (dB)

*Factor includes antenna factor , cable loss and amplifier gain

Note 2: Margin (dB) = Emission level (dBuV/m) – Limit (dBuV/m).

Modulation	11a	Test Freq. (MHz)	5200
Polarization	Horizontal		

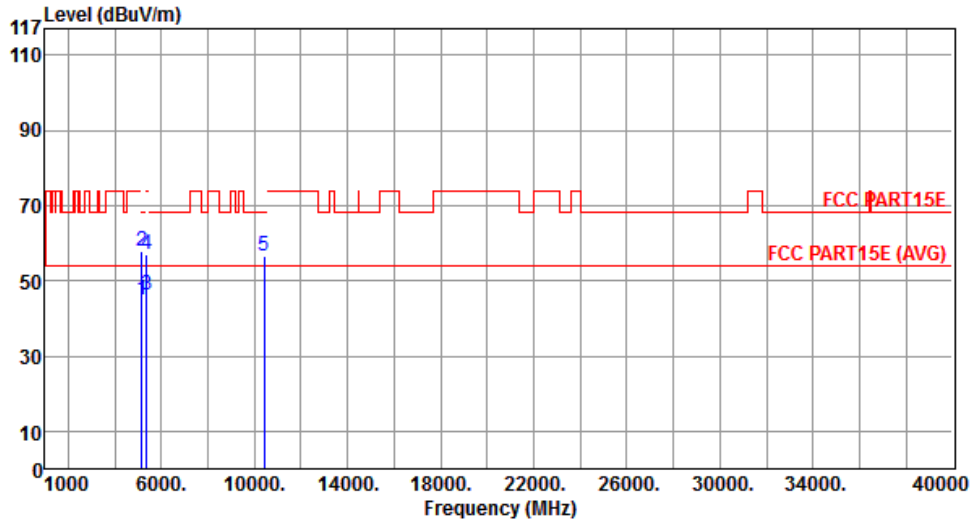

	Freq. MHz	Emission level dBuV/m	Limit dBuV/m	Margin dB	SA reading dBuV	Factor dB	Remark	ANT High cm	Turn Table deg
1	5150.00	44.85	54.00	-9.15	39.29	5.56	Average	---	---
2	5150.00	57.91	74.00	-16.09	52.35	5.56	Peak	---	---
3	5360.00	46.05	54.00	-7.95	40.33	5.72	Average	---	---
4	5360.00	57.07	74.00	-16.93	51.35	5.72	Peak	---	---
5	10400.00	56.36	68.20	-11.84	41.23	15.13	Peak	---	---

Note 1: Emission Level (dBuV/m) = SA Reading (dBuV/m) + Factor* (dB)

*Factor includes antenna factor , cable loss and amplifier gain

Note 2: Margin (dB) = Emission level (dBuV/m) – Limit (dBuV/m).

Modulation	11a	Test Freq. (MHz)	5200
Polarization	Vertical		

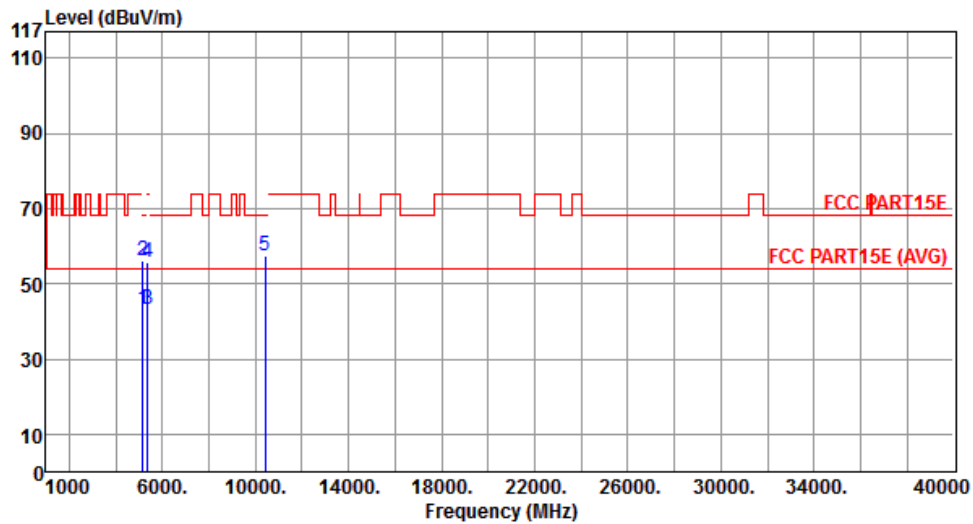

	Freq. MHz	Emission level dBuV/m	Limit dBuV/m	Margin dB	SA reading dBuV	Factor dB	Remark	ANT High cm	Turn Table deg
1	5150.00	43.09	54.00	-10.91	37.53	5.56	Average	---	---
2	5150.00	56.34	74.00	-17.66	50.78	5.56	Peak	---	---
3	5360.00	43.09	54.00	-10.91	37.37	5.72	Average	---	---
4	5360.00	55.84	74.00	-18.16	50.12	5.72	Peak	---	---
5	10400.00	57.47	68.20	-10.73	42.34	15.13	Peak	---	---

Note 1: Emission Level (dBuV/m) = SA Reading (dBuV/m) + Factor* (dB)

*Factor includes antenna factor , cable loss and amplifier gain

Note 2: Margin (dB) = Emission level (dBuV/m) – Limit (dBuV/m).

Modulation	11a	Test Freq. (MHz)	5240
Polarization	Horizontal		

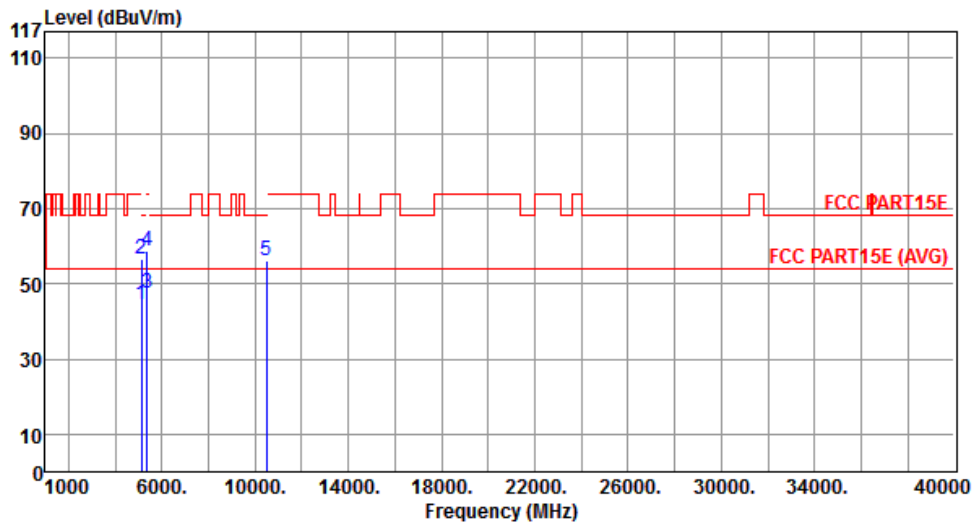

	Freq. MHz	Emission level dBuV/m	Limit dBuV/m	Margin dB	SA reading dBuV	Factor dB	Remark	ANT High cm	Turn Table deg
1	5120.00	44.38	54.00	-9.62	38.86	5.52	Average	---	---
2	5120.00	56.77	74.00	-17.23	51.25	5.52	Peak	---	---
3	5360.00	47.28	54.00	-6.72	41.56	5.72	Average	---	---
4	5360.00	58.91	74.00	-15.09	53.19	5.72	Peak	---	---
5	10480.00	56.10	68.20	-12.10	40.86	15.24	Peak	---	---

Note 1: Emission Level (dBuV/m) = SA Reading (dBuV/m) + Factor* (dB)

*Factor includes antenna factor , cable loss and amplifier gain

Note 2: Margin (dB) = Emission level (dBuV/m) – Limit (dBuV/m).

Modulation	11a	Test Freq. (MHz)	5240
Polarization	Vertical		

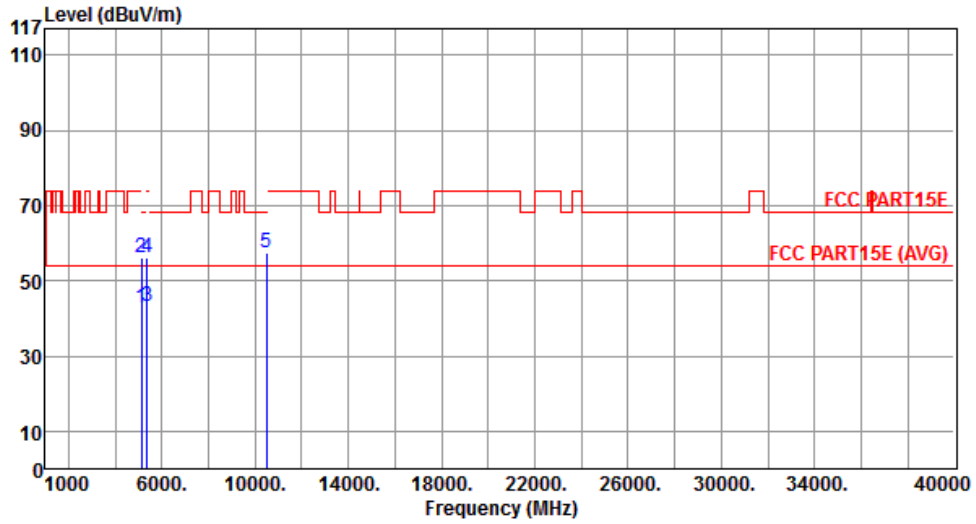

	Freq. MHz	Emission level dBuV/m	Limit dBuV/m	Margin dB	SA reading dBuV	Factor dB	Remark	ANT High cm	Turn Table deg
1	5120.00	42.63	54.00	-11.37	37.11	5.52	Average	---	---
2	5120.00	55.92	74.00	-18.08	50.40	5.52	Peak	---	---
3	5360.00	43.18	54.00	-10.82	37.46	5.72	Average	---	---
4	5360.00	55.94	74.00	-18.06	50.22	5.72	Peak	---	---
5	10480.00	57.58	68.20	-10.62	42.34	15.24	Peak	---	---

Note 1: Emission Level (dBuV/m) = SA Reading (dBuV/m) + Factor* (dB)

*Factor includes antenna factor , cable loss and amplifier gain

Note 2: Margin (dB) = Emission level (dBuV/m) – Limit (dBuV/m).

3.6.6 Transmitter Radiated Unwanted Emissions (Above 1GHz) for VHT20

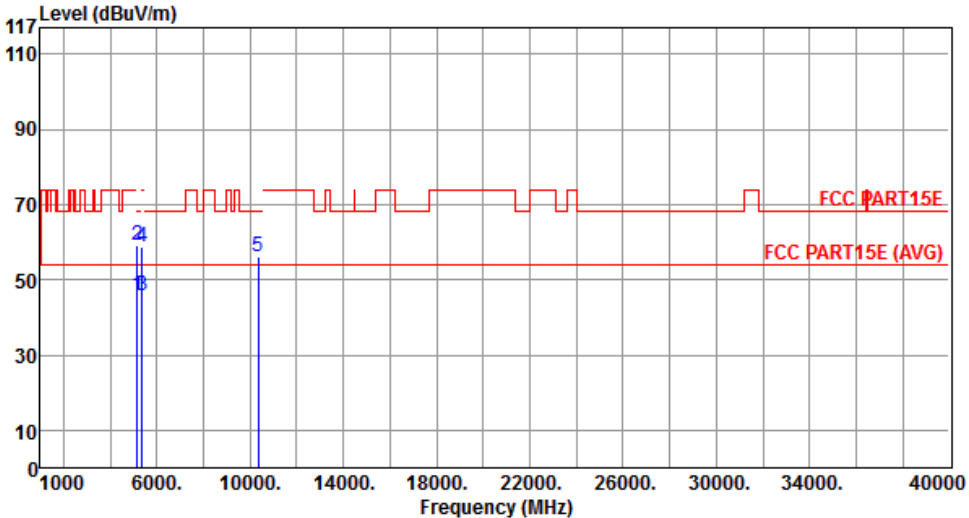
Modulation	VHT20	Test Freq. (MHz)	5180																																																													
Polarization	Horizontal																																																															
																																																																
	<table border="1"> <thead> <tr> <th>Freq.</th> <th>Emission level</th> <th>Limit</th> <th>Margin</th> <th>SA reading</th> <th>Factor</th> <th>Remark</th> <th>ANT High cm</th> <th>Turn Table deg</th> </tr> <tr> <th>MHz</th> <th>dBuV/m</th> <th>dBuV/m</th> <th>dB</th> <th>dBuV</th> <th>dB</th> <th></th> <th></th> <th></th> </tr> </thead> <tbody> <tr> <td>1</td> <td>5150.00</td> <td>45.62</td> <td>54.00</td> <td>-8.38</td> <td>40.06</td> <td>5.56</td> <td>Average</td> <td>---</td> </tr> <tr> <td>2</td> <td>5150.00</td> <td>59.36</td> <td>74.00</td> <td>-14.64</td> <td>53.80</td> <td>5.56</td> <td>Peak</td> <td>---</td> </tr> <tr> <td>3</td> <td>5380.00</td> <td>45.72</td> <td>54.00</td> <td>-8.28</td> <td>39.99</td> <td>5.73</td> <td>Average</td> <td>---</td> </tr> <tr> <td>4</td> <td>5380.00</td> <td>58.69</td> <td>74.00</td> <td>-15.31</td> <td>52.96</td> <td>5.73</td> <td>Peak</td> <td>---</td> </tr> <tr> <td>5</td> <td>10360.00</td> <td>56.24</td> <td>68.20</td> <td>-11.96</td> <td>41.17</td> <td>15.07</td> <td>Peak</td> <td>---</td> </tr> </tbody> </table>	Freq.	Emission level	Limit	Margin	SA reading	Factor	Remark	ANT High cm	Turn Table deg	MHz	dBuV/m	dBuV/m	dB	dBuV	dB				1	5150.00	45.62	54.00	-8.38	40.06	5.56	Average	---	2	5150.00	59.36	74.00	-14.64	53.80	5.56	Peak	---	3	5380.00	45.72	54.00	-8.28	39.99	5.73	Average	---	4	5380.00	58.69	74.00	-15.31	52.96	5.73	Peak	---	5	10360.00	56.24	68.20	-11.96	41.17	15.07	Peak	---
Freq.	Emission level	Limit	Margin	SA reading	Factor	Remark	ANT High cm	Turn Table deg																																																								
MHz	dBuV/m	dBuV/m	dB	dBuV	dB																																																											
1	5150.00	45.62	54.00	-8.38	40.06	5.56	Average	---																																																								
2	5150.00	59.36	74.00	-14.64	53.80	5.56	Peak	---																																																								
3	5380.00	45.72	54.00	-8.28	39.99	5.73	Average	---																																																								
4	5380.00	58.69	74.00	-15.31	52.96	5.73	Peak	---																																																								
5	10360.00	56.24	68.20	-11.96	41.17	15.07	Peak	---																																																								
<p>Note 1: Emission Level (dBuV/m) = SA Reading (dBuV/m) + Factor* (dB) *Factor includes antenna factor , cable loss and amplifier gain Note 2: Margin (dB) = Emission level (dBuV/m) – Limit (dBuV/m).</p>																																																																

Modulation	VHT20	Test Freq. (MHz)	5180
Polarization	Vertical		

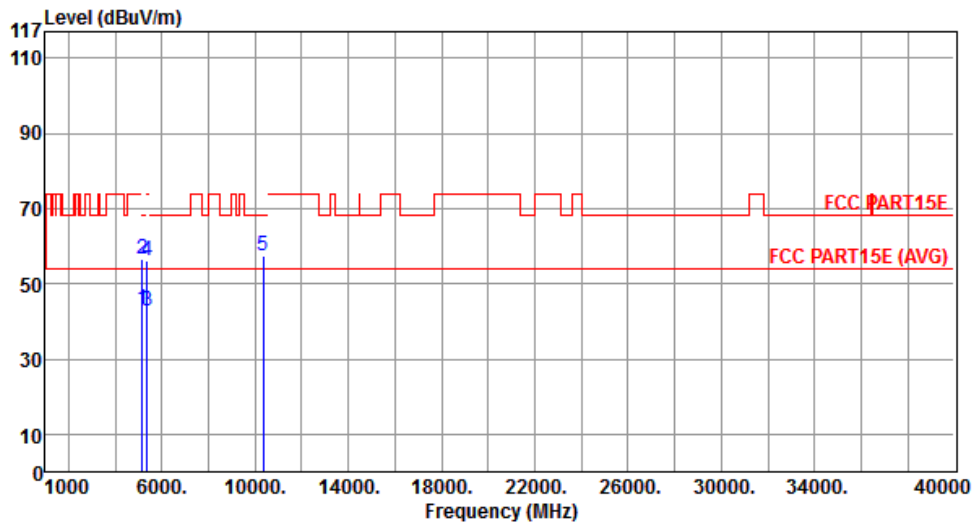

	Freq. MHz	Emission level dBuV/m	Limit dBuV/m	Margin dB	SA reading dBuV	Factor dB	Remark	ANT High cm	Turn Table deg
1	5150.00	43.25	54.00	-10.75	37.69	5.56	Average	---	---
2	5150.00	56.38	74.00	-17.62	50.82	5.56	Peak	---	---
3	5380.00	42.95	54.00	-11.05	37.22	5.73	Average	---	---
4	5380.00	56.14	74.00	-17.86	50.41	5.73	Peak	---	---
5	10360.00	57.28	68.20	-10.92	42.21	15.07	Peak	---	---

Note 1: Emission Level (dBuV/m) = SA Reading (dBuV/m) + Factor* (dB)

*Factor includes antenna factor , cable loss and amplifier gain

Note 2: Margin (dB) = Emission level (dBuV/m) – Limit (dBuV/m).

Modulation	VHT20	Test Freq. (MHz)	5200
Polarization	Horizontal		

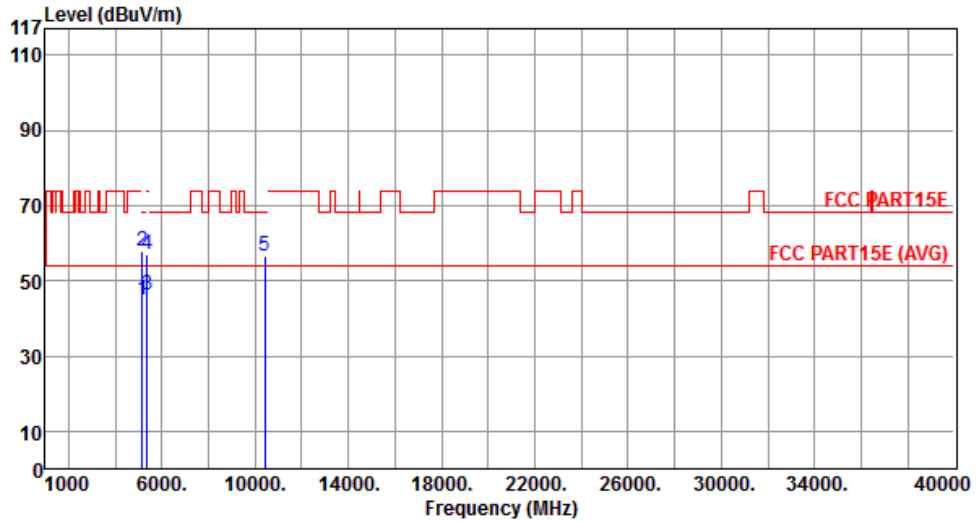

	Freq. MHz	Emission level dBuV/m	Limit dBuV/m	Margin dB	SA reading dBuV	Factor dB	Remark	ANT High cm	Turn Table deg
1	5150.00	44.96	54.00	-9.04	39.40	5.56	Average	---	---
2	5150.00	58.06	74.00	-15.94	52.50	5.56	Peak	---	---
3	5360.00	46.21	54.00	-7.79	40.49	5.72	Average	---	---
4	5360.00	57.18	74.00	-16.82	51.46	5.72	Peak	---	---
5	10400.00	56.48	68.20	-11.72	41.35	15.13	Peak	---	---

Note 1: Emission Level (dBuV/m) = SA Reading (dBuV/m) + Factor* (dB)

*Factor includes antenna factor , cable loss and amplifier gain

Note 2: Margin (dB) = Emission level (dBuV/m) – Limit (dBuV/m).

Modulation	VHT20	Test Freq. (MHz)	5200
Polarization	Vertical		

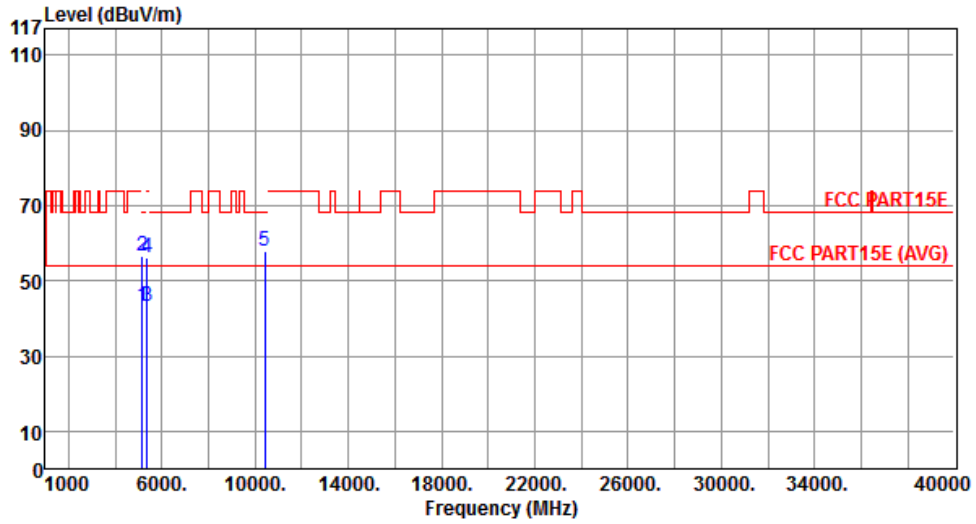

	Freq. MHz	Emission level dBuV/m	Limit dBuV/m	Margin dB	SA reading dBuV	Factor dB	Remark	ANT High cm	Turn Table deg
1	5150.00	43.24	54.00	-10.76	37.68	5.56	Average	---	---
2	5150.00	56.48	74.00	-17.52	50.92	5.56	Peak	---	---
3	5360.00	43.24	54.00	-10.76	37.52	5.72	Average	---	---
4	5360.00	56.13	74.00	-17.87	50.41	5.72	Peak	---	---
5	10400.00	57.89	68.20	-10.31	42.76	15.13	Peak	---	---

Note 1: Emission Level (dBuV/m) = SA Reading (dBuV/m) + Factor* (dB)

*Factor includes antenna factor , cable loss and amplifier gain

Note 2: Margin (dB) = Emission level (dBuV/m) – Limit (dBuV/m).

Modulation	VHT20	Test Freq. (MHz)	5240
Polarization	Horizontal		

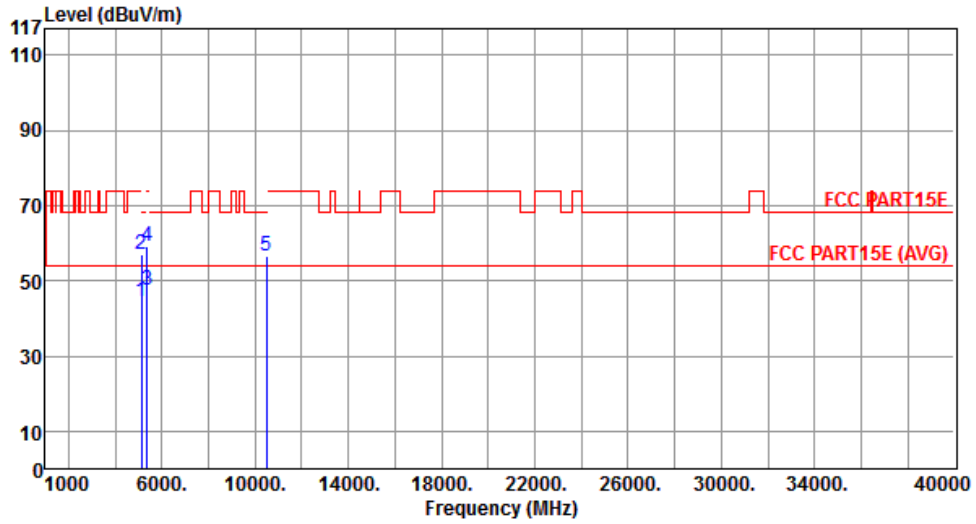

	Freq. MHz	Emission level dBuV/m	Limit dBuV/m	Margin dB	SA reading dBuV	Factor dB	Remark	ANT High cm	Turn Table deg
1	5120.00	44.62	54.00	-9.38	39.10	5.52	Average	---	---
2	5120.00	56.89	74.00	-17.11	51.37	5.52	Peak	---	---
3	5360.00	47.45	54.00	-6.55	41.73	5.72	Average	---	---
4	5360.00	59.24	74.00	-14.76	53.52	5.72	Peak	---	---
5	10480.00	56.38	68.20	-11.82	41.14	15.24	Peak	---	---

Note 1: Emission Level (dBuV/m) = SA Reading (dBuV/m) + Factor* (dB)

*Factor includes antenna factor , cable loss and amplifier gain

Note 2: Margin (dB) = Emission level (dBuV/m) – Limit (dBuV/m).

Modulation	VHT20	Test Freq. (MHz)	5240
Polarization	Vertical		

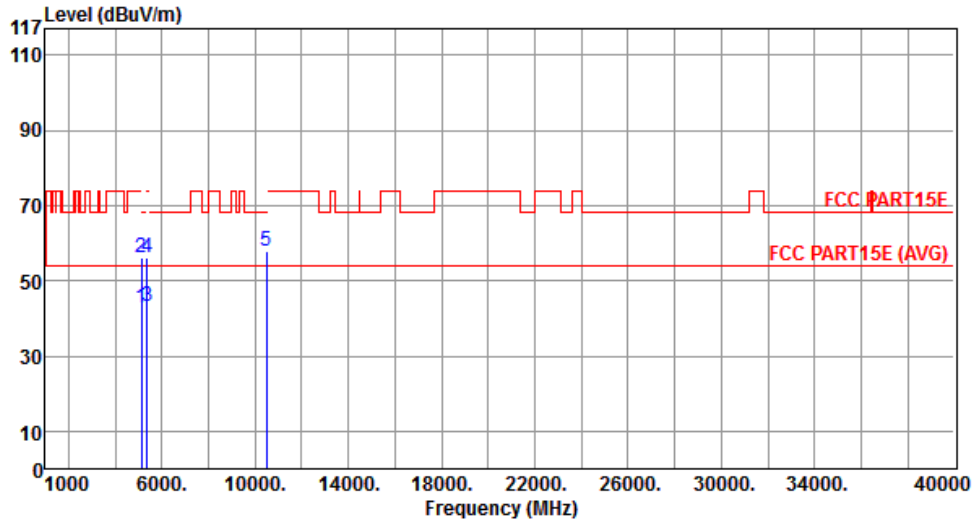

	Freq. MHz	Emission level dBuV/m	Limit dBuV/m	Margin dB	SA reading dBuV	Factor dB	Remark	ANT High cm	Turn Table deg
1	5120.00	42.78	54.00	-11.22	37.26	5.52	Average	---	---
2	5120.00	56.14	74.00	-17.86	50.62	5.52	Peak	---	---
3	5360.00	43.38	54.00	-10.62	37.66	5.72	Average	---	---
4	5360.00	56.25	74.00	-17.75	50.53	5.72	Peak	---	---
5	10480.00	57.81	68.20	-10.39	42.57	15.24	Peak	---	---

Note 1: Emission Level (dBuV/m) = SA Reading (dBuV/m) + Factor* (dB)

*Factor includes antenna factor , cable loss and amplifier gain

Note 2: Margin (dB) = Emission level (dBuV/m) – Limit (dBuV/m).

3.6.7 Transmitter Radiated Unwanted Emissions (Above 1GHz) for VHT40

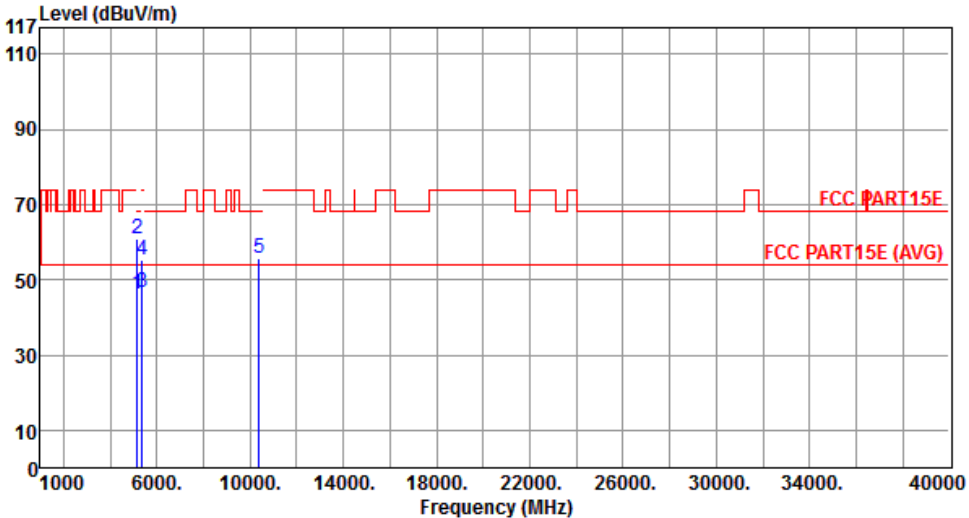
Modulation	VHT40	Test Freq. (MHz)	5190																																																																
Polarization	Horizontal																																																																		
																																																																			
	<table border="1"> <thead> <tr> <th>Freq.</th> <th>Emission level</th> <th>Limit</th> <th>Margin</th> <th>SA reading</th> <th>Factor</th> <th>Remark</th> <th>ANT High</th> <th>Turn Table</th> </tr> <tr> <th>MHz</th> <th>dBuV/m</th> <th>dBuV/m</th> <th>dB</th> <th>dBuV</th> <th>dB</th> <th></th> <th>cm</th> <th>deg</th> </tr> </thead> <tbody> <tr> <td>1</td> <td>5150.00</td> <td>46.34</td> <td>54.00</td> <td>-7.66</td> <td>40.78</td> <td>5.56</td> <td>Average</td> <td>---</td> </tr> <tr> <td>2</td> <td>5150.00</td> <td>61.01</td> <td>74.00</td> <td>-12.99</td> <td>55.45</td> <td>5.56</td> <td>Peak</td> <td>---</td> </tr> <tr> <td>3</td> <td>5350.00</td> <td>46.54</td> <td>54.00</td> <td>-7.46</td> <td>40.83</td> <td>5.71</td> <td>Average</td> <td>---</td> </tr> <tr> <td>4</td> <td>5350.00</td> <td>55.07</td> <td>74.00</td> <td>-18.93</td> <td>49.36</td> <td>5.71</td> <td>Peak</td> <td>---</td> </tr> <tr> <td>5</td> <td>10380.00</td> <td>55.86</td> <td>68.20</td> <td>-12.34</td> <td>40.75</td> <td>15.11</td> <td>Peak</td> <td>---</td> </tr> </tbody> </table>	Freq.	Emission level	Limit	Margin	SA reading	Factor	Remark	ANT High	Turn Table	MHz	dBuV/m	dBuV/m	dB	dBuV	dB		cm	deg	1	5150.00	46.34	54.00	-7.66	40.78	5.56	Average	---	2	5150.00	61.01	74.00	-12.99	55.45	5.56	Peak	---	3	5350.00	46.54	54.00	-7.46	40.83	5.71	Average	---	4	5350.00	55.07	74.00	-18.93	49.36	5.71	Peak	---	5	10380.00	55.86	68.20	-12.34	40.75	15.11	Peak	---			
Freq.	Emission level	Limit	Margin	SA reading	Factor	Remark	ANT High	Turn Table																																																											
MHz	dBuV/m	dBuV/m	dB	dBuV	dB		cm	deg																																																											
1	5150.00	46.34	54.00	-7.66	40.78	5.56	Average	---																																																											
2	5150.00	61.01	74.00	-12.99	55.45	5.56	Peak	---																																																											
3	5350.00	46.54	54.00	-7.46	40.83	5.71	Average	---																																																											
4	5350.00	55.07	74.00	-18.93	49.36	5.71	Peak	---																																																											
5	10380.00	55.86	68.20	-12.34	40.75	15.11	Peak	---																																																											
<p>Note 1: Emission Level (dBuV/m) = SA Reading (dBuV/m) + Factor* (dB) *Factor includes antenna factor , cable loss and amplifier gain Note 2: Margin (dB) = Emission level (dBuV/m) – Limit (dBuV/m).</p>																																																																			

Modulation	VHT40	Test Freq. (MHz)	5190
Polarization	Vertical		

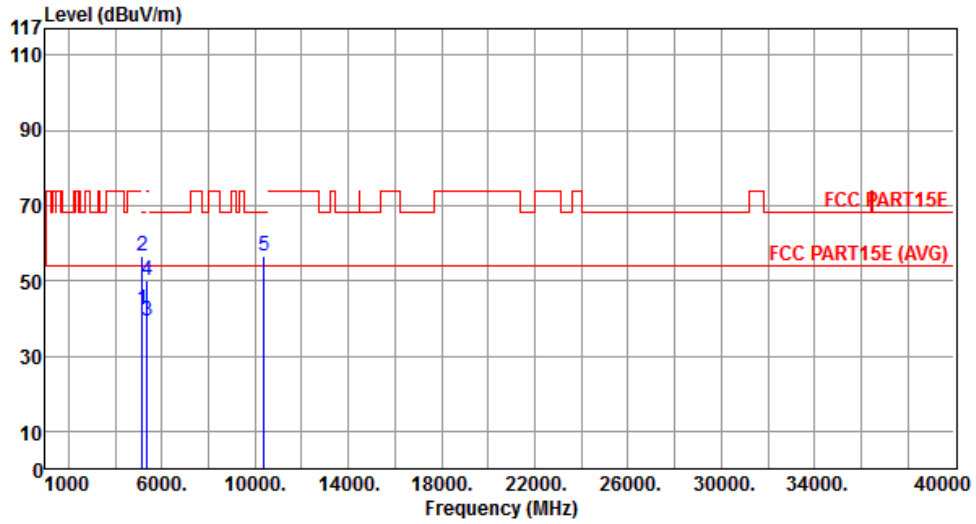

	Freq. MHz	Emission level dBuV/m	Limit dBuV/m	Margin dB	SA reading dBuV	Factor dB	Remark	ANT High cm	Turn Table deg
1	5150.00	42.37	54.00	-11.63	36.81	5.56	Average	---	---
2	5150.00	56.71	74.00	-17.29	51.15	5.56	Peak	---	---
3	5350.00	39.15	54.00	-14.85	33.44	5.71	Average	---	---
4	5350.00	50.15	74.00	-23.85	44.44	5.71	Peak	---	---
5	10380.00	56.52	68.20	-11.68	41.41	15.11	Peak	---	---

Note 1: Emission Level (dBuV/m) = SA Reading (dBuV/m) + Factor* (dB)

*Factor includes antenna factor , cable loss and amplifier gain

Note 2: Margin (dB) = Emission level (dBuV/m) – Limit (dBuV/m).

Modulation	VHT40	Test Freq. (MHz)	5230
Polarization	Horizontal		

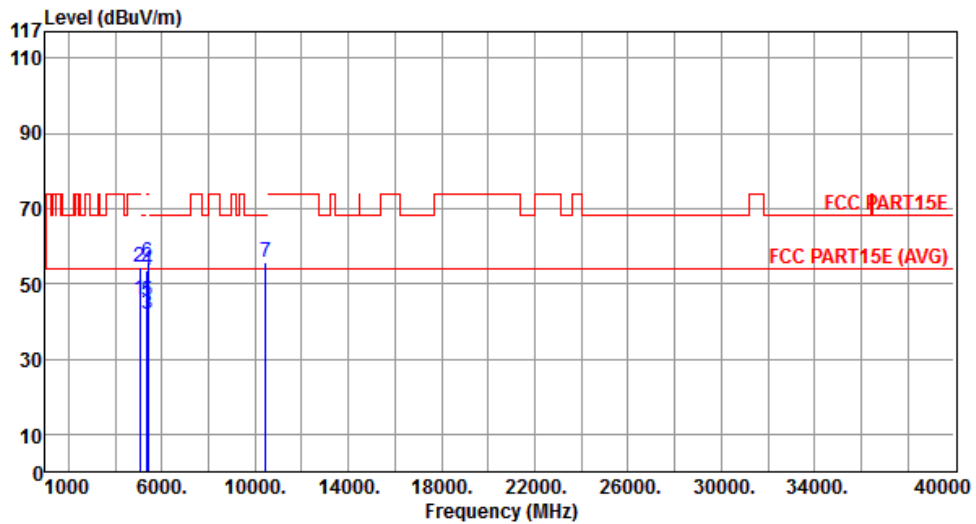

	Freq. MHz	Emission level dBuV/m	Limit dBuV/m	Margin dB	SA reading dBuV	Factor dB	Remark	ANT High cm	Turn Table deg
1	5070.00	45.77	54.00	-8.23	40.32	5.45	Average	---	---
2	5070.00	54.47	74.00	-19.53	49.02	5.45	Peak	---	---
3	5350.00	41.70	54.00	-12.30	35.99	5.71	Average	---	---
4	5350.00	53.43	74.00	-20.57	47.72	5.71	Peak	---	---
5	5390.00	45.49	54.00	-8.51	39.76	5.73	Average	---	---
6	5390.00	55.74	74.00	-18.26	50.01	5.73	Peak	---	---
7	10460.00	55.80	68.20	-12.40	40.59	15.21	Peak	---	---

Note 1: Emission Level (dBuV/m) = SA Reading (dBuV/m) + Factor* (dB)

*Factor includes antenna factor , cable loss and amplifier gain

Note 2: Margin (dB) = Emission level (dBuV/m) – Limit (dBuV/m).

Modulation	VHT40	Test Freq. (MHz)	5230
Polarization	Vertical		

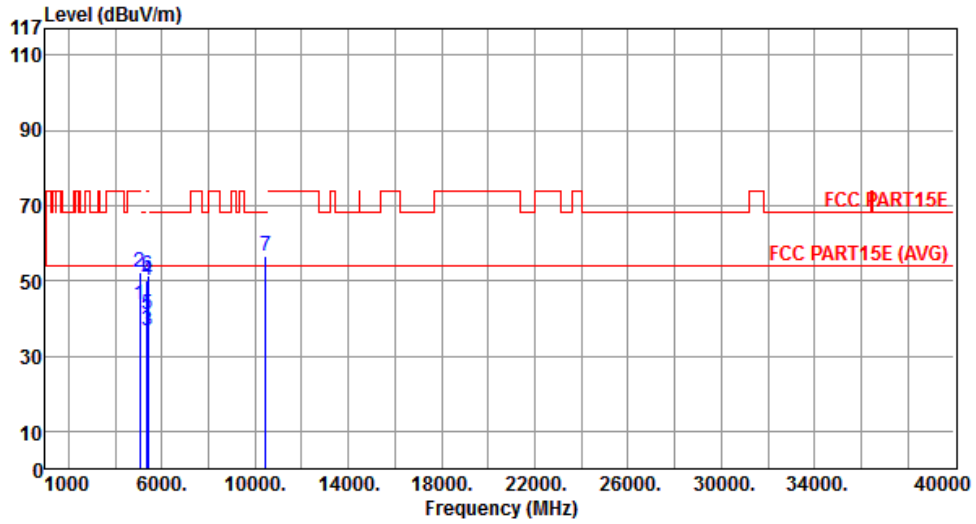

	Freq. MHz	Emission level dBuV/m	Limit dBuV/m	Margin dB	SA reading dBuV	Factor dB	Remark	ANT High cm	Turn Table deg
1	5070.00	43.44	54.00	-10.56	37.99	5.45	Average	---	---
2	5070.00	52.09	74.00	-21.91	46.64	5.45	Peak	---	---
3	5350.00	36.79	54.00	-17.21	31.08	5.71	Average	---	---
4	5350.00	50.05	74.00	-23.95	44.34	5.71	Peak	---	---
5	5390.00	40.82	54.00	-13.18	35.09	5.73	Average	---	---
6	5390.00	51.42	74.00	-22.58	45.69	5.73	Peak	---	---
7	10460.00	56.50	68.20	-11.70	41.29	15.21	Peak	---	---

Note 1: Emission Level (dBuV/m) = SA Reading (dBuV/m) + Factor* (dB)

*Factor includes antenna factor , cable loss and amplifier gain

Note 2: Margin (dB) = Emission level (dBuV/m) – Limit (dBuV/m).

3.6.8 Transmitter Radiated Unwanted Emissions (Above 1GHz) for VHT80

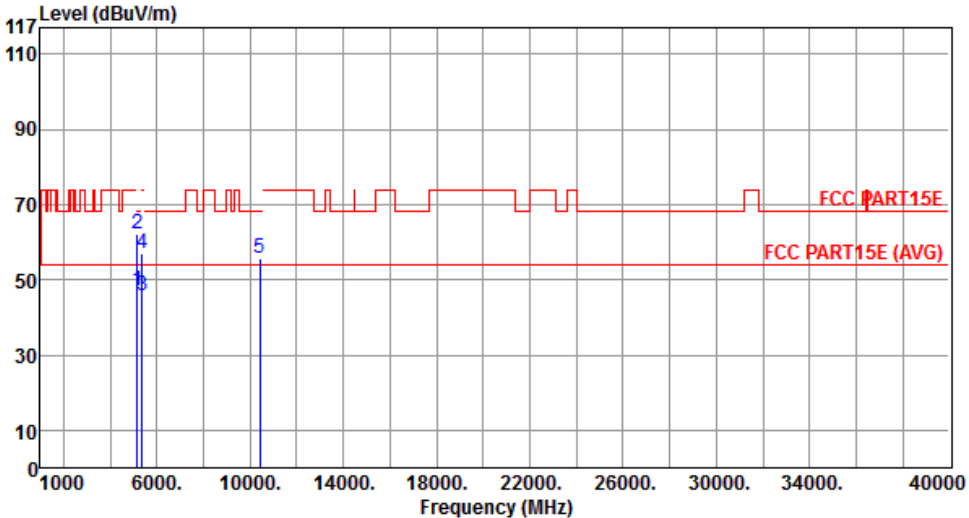
Modulation	VHT80	Test Freq. (MHz)	5210																																																																
Polarization	Horizontal																																																																		
																																																																			
	<table border="1"> <thead> <tr> <th>Freq.</th> <th>Emission level</th> <th>Limit</th> <th>Margin</th> <th>SA reading</th> <th>Factor</th> <th>Remark</th> <th>ANT High cm</th> <th>Turn Table deg</th> </tr> <tr> <th>MHz</th> <th>dBuV/m</th> <th>dBuV/m</th> <th>dB</th> <th>dBuV</th> <th>dB</th> <th></th> <th></th> <th></th> </tr> </thead> <tbody> <tr> <td>1</td> <td>5150.00</td> <td>47.27</td> <td>54.00</td> <td>-6.73</td> <td>41.71</td> <td>5.56</td> <td>Average</td> <td>---</td> </tr> <tr> <td>2</td> <td>5150.00</td> <td>62.28</td> <td>74.00</td> <td>-11.72</td> <td>56.72</td> <td>5.56</td> <td>Peak</td> <td>---</td> </tr> <tr> <td>3</td> <td>5370.00</td> <td>45.94</td> <td>54.00</td> <td>-8.06</td> <td>40.22</td> <td>5.72</td> <td>Average</td> <td>---</td> </tr> <tr> <td>4</td> <td>5370.00</td> <td>56.77</td> <td>74.00</td> <td>-17.23</td> <td>51.05</td> <td>5.72</td> <td>Peak</td> <td>---</td> </tr> <tr> <td>5</td> <td>10420.00</td> <td>55.78</td> <td>68.20</td> <td>-12.42</td> <td>40.63</td> <td>15.15</td> <td>Peak</td> <td>---</td> </tr> </tbody> </table>	Freq.	Emission level	Limit	Margin	SA reading	Factor	Remark	ANT High cm	Turn Table deg	MHz	dBuV/m	dBuV/m	dB	dBuV	dB				1	5150.00	47.27	54.00	-6.73	41.71	5.56	Average	---	2	5150.00	62.28	74.00	-11.72	56.72	5.56	Peak	---	3	5370.00	45.94	54.00	-8.06	40.22	5.72	Average	---	4	5370.00	56.77	74.00	-17.23	51.05	5.72	Peak	---	5	10420.00	55.78	68.20	-12.42	40.63	15.15	Peak	---			
Freq.	Emission level	Limit	Margin	SA reading	Factor	Remark	ANT High cm	Turn Table deg																																																											
MHz	dBuV/m	dBuV/m	dB	dBuV	dB																																																														
1	5150.00	47.27	54.00	-6.73	41.71	5.56	Average	---																																																											
2	5150.00	62.28	74.00	-11.72	56.72	5.56	Peak	---																																																											
3	5370.00	45.94	54.00	-8.06	40.22	5.72	Average	---																																																											
4	5370.00	56.77	74.00	-17.23	51.05	5.72	Peak	---																																																											
5	10420.00	55.78	68.20	-12.42	40.63	15.15	Peak	---																																																											
<p>Note 1: Emission Level (dBuV/m) = SA Reading (dBuV/m) + Factor* (dB) *Factor includes antenna factor , cable loss and amplifier gain Note 2: Margin (dB) = Emission level (dBuV/m) – Limit (dBuV/m).</p>																																																																			

Modulation	VHT80	Test Freq. (MHz)	5210
Polarization	Vertical		

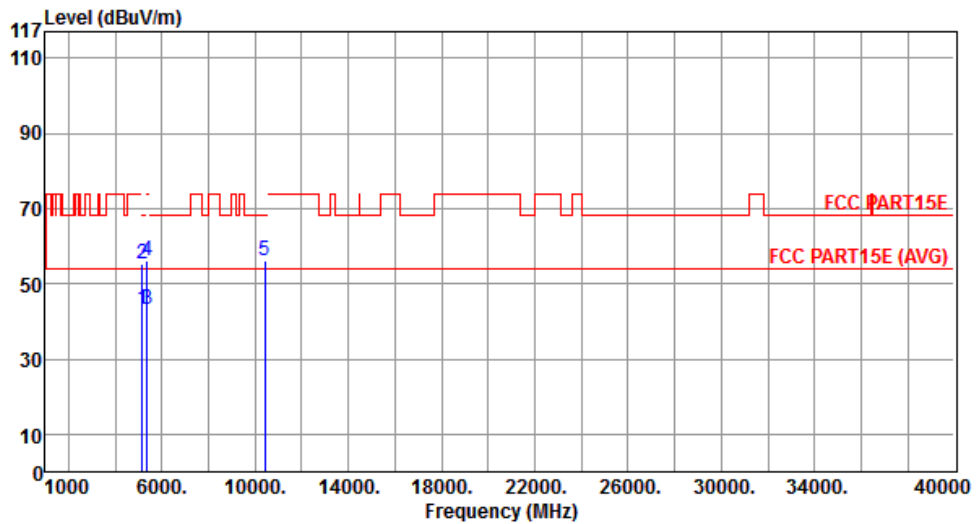

	Freq. MHz	Emission level dBuV/m	Limit dBuV/m	Margin dB	SA reading dBuV	Factor dB	Remark	ANT High cm	Turn Table deg
1	5150.00	43.24	54.00	-10.76	37.68	5.56	Average	---	---
2	5150.00	55.05	74.00	-18.95	49.49	5.56	Peak	---	---
3	5370.00	43.24	54.00	-10.76	37.52	5.72	Average	---	---
4	5370.00	55.93	74.00	-18.07	50.21	5.72	Peak	---	---
5	10420.00	56.29	68.20	-11.91	41.14	15.15	Peak	---	---

Note 1: Emission Level (dBuV/m) = SA Reading (dBuV/m) + Factor* (dB)

*Factor includes antenna factor , cable loss and amplifier gain

Note 2: Margin (dB) = Emission level (dBuV/m) – Limit (dBuV/m).

3.7 Frequency Stability

3.7.1 Limit of Frequency Stability

Manufacturers of U-NII devices are responsible for ensuring frequency stability such that an emission is maintained within the band of operation under all conditions of normal operation as specified in the user's manual.

3.7.2 Test Procedures

1. The EUT is installed in an environment test chamber with external power source.
2. Set the chamber to operate at 50 centigrade and external power source to output at nominal voltage of EUT.
3. A sufficient stabilization period at each temperature is used prior to each frequency measurement.
4. When temperature is stabled, measure the frequency stability.
5. The test shall be performed under -30 to 50 centigrade and 85 to 115 percent of the nominal voltage. Change setting of chamber and external power source to complete all conditions.

3.7.3 Test Setup

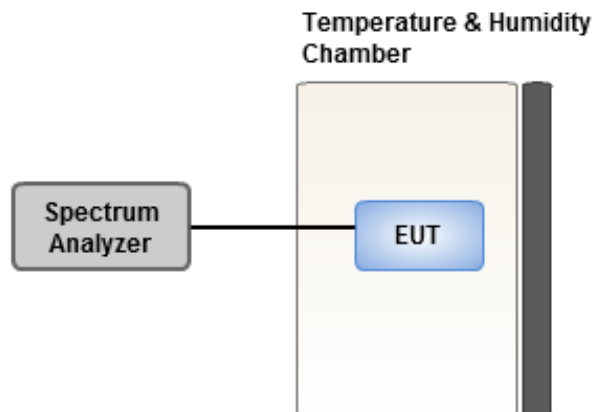

3.7.4 Test Result of Frequency Stability

Frequency: 5200 MHz	Frequency Drift (ppm)			
	0 minute	2 minutes	5 minutes	10 minutes
Temperature (°C)				
T20°CVmax	2.22	1.87	2.65	2.24
T20°CVmin	1.94	2.05	2.00	1.76
T50°CVnom	1.84	2.31	1.94	1.72
T40°CVnom	1.18	1.19	1.66	1.24
T30°CVnom	0.92	1.05	0.97	1.42
T20°CVnom	2.62	2.63	2.58	2.67
T10°CVnom	1.97	2.30	2.35	2.36
T0°CVnom	0.80	1.31	0.90	1.59
T-10°CVnom	1.40	2.00	1.14	1.92
T-20°CVnom	2.54	2.97	3.17	2.46
T-30°CVnom	1.14	1.71	1.05	1.41
T20°CVmax	2.22	1.87	2.65	2.24
Vnom [Vdc]: 110		Vmax [Vdc]: 126.5		Vmin [Vdc]: 93.5
Tnom [°C]: 20		Tmax [°C]: 50		Tmin [°C]: -30

4 Test laboratory information

Established in 2012, ICC provides foremost EMC & RF Testing and advisory consultation services by our skilled engineers and technicians. Our services employ a wide variety of advanced edge test equipment and one of the widest certification extents in the business.

International Certification Corp, it is our definitive objective is to institute long term, trust-based associations with our clients. The expectation we set up with our clients is based on outstanding service, practical expertise and devotion to a certified value structure. Our passion is to grant our clients with best EMC / RF services by oriented knowledgeable and accommodating staff.

Our Test sites are located at Linkou District and Kwei Shan Hsiang. Location map can be found on our website <http://www.icertifi.com.tw>.

Linkou

Tel: 886-2-2601-1640

No. 30-2, Ding Fwu Tsuen, Lin Kou District, New Taipei City, Taiwan, R.O.C.

Kwei Shan

Tel: 886-3-271-8666

No. 3-1, Lane 6, Wen San 3rd St., Kwei Shan Hsiang, Tao Yuan Hsien 333, Taiwan, R.O.C.

If you have any suggestion, please feel free to contact us as below information

Tel: 886-3-271-8666

Fax: 886-3-318-0155

Email: ICC_Service@icertifi.com.tw

==END==