

# FCC Test Report

**FCC ID** : FDI000000024  
**Equipment** : AirStation  
**Model No.** : WMR-433  
**Brand Name** : Buffalo Inc.  
**Applicant** : Buffalo Inc.  
**Address** : Akamon-dori Bldg, 30-20, Ohsu 3-chome,  
Naka-ku, Nagoya 460-8315, Japan  
**Standard** : 47 CFR FCC Part 15.247  
**Received Date** : Feb. 18, 2014  
**Tested Date** : Feb. 24 ~ Mar. 06, 2014

We, International Certification Corp., would like to declare that the tested sample has been evaluated and in compliance with the requirement of the above standards. The test results contained in this report refer exclusively to the product. It may be duplicated completely for legal use with the approval of the applicant. It shall not be reproduced except in full without the written approval of our laboratory.

Approved & Reviewed by:

  
\_\_\_\_\_  
Gary Chang / Manager



---

## Table of Contents

<b>1</b>	<b>GENERAL DESCRIPTION .....</b>	<b>5</b>
1.1	Information.....	5
1.2	Local Support Equipment List .....	7
1.3	Test Setup Chart .....	7
1.4	The Equipment List .....	8
1.5	Test Standards .....	9
1.6	Measurement Uncertainty .....	9
<b>2</b>	<b>TEST CONFIGURATION .....</b>	<b>10</b>
2.1	Testing Condition .....	10
2.2	The Worst Test Modes and Channel Details .....	10
<b>3</b>	<b>TRANSMITTER TEST RESULTS.....</b>	<b>11</b>
3.1	Conducted Emissions.....	11
3.2	6dB and Occupied Bandwidth .....	14
3.3	RF Output Power .....	17
3.4	Power Spectral Density .....	20
3.5	Unwanted Emissions into Restricted Frequency Bands .....	22
3.6	Unwanted Emissions into Non-Restricted Frequency Bands .....	44
<b>4</b>	<b>TEST LABORATORY INFORMATION .....</b>	<b>54</b>

---

## Release Record

Report No.	Version	Description	Issued Date
FR421803AI	Rev. 01	Initial issue	Apr. 03, 2014

## Summary of Test Results

FCC Rules	Test Items	Measured	Result
15.207	Conducted Emissions	[dBuV]: 0.186MHz 48.59 (Margin -5.61dB) - AV	Pass
15.247(d) 15.209	Radiated Emissions	[dBuV/m at 3m]: 178.51MHz 40.07 (Margin -3.43dB) - QP	Pass
15.247(b)(3)	Fundamental Emission Output Power	Power [dBm]: 11a: 23.65 HT20: 23.19 HT40: 23.22 VHT20: 23.26 VHT40: 23.29 VHT80: 22.17	Pass
15.247(a)(2)	6dB Bandwidth	Meet the requirement of limit	Pass
15.247(e)	Power Spectral Density	Meet the requirement of limit	Pass
15.203	Antenna Requirement	Meet the requirement of limit	Pass

# 1 General Description

## 1.1 Information

### 1.1.1 Specification of the Equipment under Test (EUT)

RF General Information					
IEEE Std. 802.11	Frequency Range (MHz)	Ch. Freq. (MHz)	Channel Number	Transmit Chains (N <sub>TX</sub> )	Data Rate / MCS
a	5725-5850	5745-5825	149-165 [5]	1	6-54 Mbps
n (HT20)	5725-5850	5745-5825	149-165 [5]	1	MCS 0-7
n (HT40)	5725-5850	5755-5795	151-159 [2]	1	MCS 0-7
ac (VHT20)	5725-5850	5745-5825	149-165 [5]	1	MCS 0-8
ac (VHT40)	5725-5850	5755-5795	151-159 [2]	1	MCS 0-9
ac (VHT80)	5725-5850	5775	155 [1]	1	MCS 0-9

Note 1: RF output power specifies that Maximum Conducted Output Power.  
 Note 2: 802.11a/n uses a combination of OFDM-BPSK, QPSK, 16QAM, 64QAM, 256QAM modulation.

### 1.1.2 Antenna Details

Ant. No.	Model	Type	Connector	Operating Frequencies (MHz) / Antenna Gain (dBi)				
				2400~2483.5	5150~5250	5250~5350	5470~5725	5725~5850
1	ALA140-222020	PIFA	Murata	2.55	2.68	2.68	2.81	2.96

### 1.1.3 Power Supply Type of Equipment under Test (EUT)

<b>Power Supply Type</b>	5Vdc from host
--------------------------	----------------

### 1.1.4 Accessories

Accessories		
No.	Equipment	Description
1	USB Cable	0.3m shielded w/o core.

### 1.1.5 Channel List

Frequency band (MHz)		5725~5850	
802.11 a / HT20 / VHT20		HT40 / VHT40	
Channel	Frequency(MHz)	Channel	Frequency(MHz)
149	5745	151	5755
153	5765	159	5795
157	5785	<b>VHT 80</b>	
161	5805	155	5775
165	5825	---	---

### 1.1.6 Test Tool and Duty Cycle

Test Tool	MP_TEST, V1.3.8.0		
Duty Cycle and Duty Factor	Mode	Duty cycle (%)	Duty factor (dB)
	11a	100.00%	0.00
	VHT20	100.00%	0.00
	VHT40	100.00%	0.00
	VHT80	100.00%	0.00

### 1.1.7 Power Setting

Modulation Mode	Test Frequency (MHz)	Power Set
11a	5745	34
11a	5785	34
11a	5825	33
HT20	5745	33
HT20	5785	33
HT20	5825	33
HT40	5755	34
HT40	5795	34
VHT20	5745	33
VHT20	5785	33
VHT20	5825	33
VHT40	5755	34
VHT40	5795	34
VHT80	5775	32

## 1.2 Local Support Equipment List

Support Equipment List						
No.	Equipment	Brand	Model	S/N	FCC ID	Signal cable / Length (m)
1	Notebook	DELL	E6430	---	DoC	USB 0.3m shielded w/o core. RJ45, 1.5m non-shielded w/o core.

Note: The USB Cable was supplied by applicant.

## 1.3 Test Setup Chart

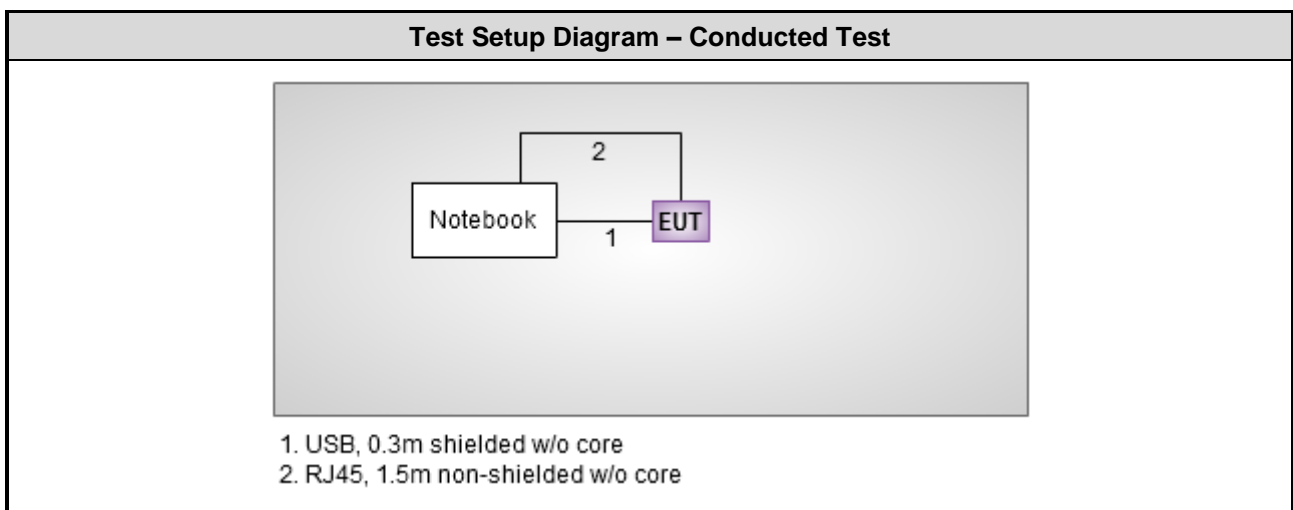

## 1.4 The Equipment List

Test Item	Conducted Emission				
Test Site	Conduction room 1 / (CO01-WS)				
Instrument	Manufacturer	Model No.	Serial No.	Calibration Date	Calibration Until
EMC Receiver	R&S	ESCS 30	100169	Oct. 15, 2013	Oct. 14, 2014
LISN	SCHWARZBECK	Schwarzbeck 8127	8127-667	Nov. 23, 2013	Nov. 22, 2014
LISN (Support Unit)	SCHWARZBECK	Schwarzbeck 8127	8127-666	Dec. 04, 2013	Dec. 03, 2014
RF Cable-CON	Woken	CFD200-NL	CFD200-NL-001	Apr. 24, 2013	Apr. 23, 2014
50 ohm terminal (Support Unit)	NA	50	04	Apr. 22, 2013	Apr. 21, 2014
Note: Calibration Interval of instruments listed above is one year.					

Test Item	Radiated Emission				
Test Site	966 chamber1 / (03CH01-WS)				
Instrument	Manufacturer	Model No.	Serial No.	Calibration Date	Calibration Until
Spectrum Analyzer	R&S	FSV40	101498	Jan. 25, 2014	Jan. 24, 2015
Receiver	R&S	ESR3	101658	Jan. 10, 2014	Jan. 09, 2015
Bilog Antenna	SCHWARZBECK	VULB9168	VULB9168-522	Jan. 02, 2014	Jan. 01, 2015
Horn Antenna 1G-18G	SCHWARZBECK	BBHA 9120 D	BBHA 9120 D 1096	Feb. 13, 2014	Feb. 12, 2015
Horn Antenna 18G-40G	SCHWARZBECK	BBHA 9170	BBHA 9170517	Dec. 27, 2013	Dec. 26, 2014
Preamplifier	Burgeon	BPA-530	SN:100219	Nov. 28, 2013	Nov. 27, 2014
Preamplifier	Agilent	83017A	MY39501308	Dec. 16, 2013	Dec. 15, 2014
Preamplifier	EM	EM18G40G	060572	Jun. 20, 2013	Jun. 19, 2014
RF Cable	HUBER+SUHNER	SUCOFLEX104	MY16014/4	Dec. 16, 2013	Dec. 15, 2014
RF Cable	HUBER+SUHNER	SUCOFLEX104	MY16019/4	Dec. 16, 2013	Dec. 15, 2014
RF Cable	HUBER+SUHNER	SUCOFLEX104	MY16139/4	Dec. 16, 2013	Dec. 15, 2014
LF cable 3M	Woken	CFD400NL-LW	CFD400NL-001	Dec. 16, 2013	Dec. 15, 2014
LF cable 10M	Woken	CFD400NL-LW	CFD400NL-002	Dec. 16, 2013	Dec. 15, 2014
Note: Calibration Interval of instruments listed above is one year.					

Test Item	Radiated Emission above 1GHz				
Test Site	966 chamber 2 / (03CH02-WS)				
Instrument	Manufacturer	Model No.	Serial No.	Calibration Date	Calibration Until
Loop Antenna	R&S	HFH2-Z2	100330	Nov. 15, 2012	Nov. 14, 2014
Note: Calibration Interval of instruments listed above is two year.					



<b>Test Item</b>	RF Conducted				
<b>Test Site</b>	(TH01-WS)				
<b>Instrument</b>	<b>Manufacturer</b>	<b>Model No.</b>	<b>Serial No.</b>	<b>Calibration Date</b>	<b>Calibration Until</b>
Spectrum Analyzer	R&S	FSV40	101063	Feb. 17, 2014	Feb. 16, 2015
Power Meter	Anritsu	ML2495A	1241002	Oct. 24, 2013	Oct. 23, 2014
Power Sensor	Anritsu	MA2411B	1207366	Oct. 24, 2013	Oct. 23, 2014
Note: Calibration Interval of instruments listed above is one year.					

## 1.5 Test Standards

According to the specification of EUT, the EUT must comply with following standards and KDB documents.

47 CFR FCC Part 15.247

ANSI C63.10-2009

FCC KDB 558074 D01 DTS Meas Guidance v03r01

Note: The EUT has been tested and complied with FCC part 15B requirement. FCC Part 15B test results are issued to another report.

## 1.6 Measurement Uncertainty

ISO/IEC 17025 requires that an estimate of the measurement uncertainties associated with the emissions test results be included in the report. The measurement uncertainties given below are based on a 95% confidence level (based on a coverage factor ( $k=2$ ))

Measurement Uncertainty	
Parameters	Uncertainty
Bandwidth	$\pm 35.286$ Hz
Conducted power	$\pm 0.536$ dB
Frequency error	$\pm 35.286$ Hz
Temperature	$\pm 0.3$ °C
Conducted emission	$\pm 2.946$ dB
AC conducted emission	$\pm 2.43$ dB
Radiated emission	$\pm 2.49$ dB

## 2 Test Configuration

### 2.1 Testing Condition

Test Item	Test Site	Ambient Condition	Tested By
AC Conduction	CO01-WS	19°C / 65%	Skys Huang
Radiated Emissions	03CH01-WS	22-23°C / 64-65%	Haru Yang
RF Conducted	TH01-WS	22°C / 61%	Felix Sung

➤ FCC site registration No.: 657002

➤ IC site registration No.: 10807A-1

### 2.2 The Worst Test Modes and Channel Details

Test item	Modulation Mode	Test Frequency (MHz)	Data Rate (Mbps) / MCS	Test Configuration
Conducted Emissions	11a	5785	MCS 0	---
Radiated Emissions $\leq$ 1GHz	11a	5785	MCS 0	---
RF Output Power	11a	5745 / 5785 / 5825	6 Mbps	---
	HT20	5745 / 5785 / 5825	MCS 0	
	HT40	5755 / 5795	MCS 0	
	VHT20	5745 / 5785 / 5825	MCS 0	
	VHT40	5755 / 5795	MCS 0	
	VHT80	5775	MCS 0	
Radiated Emissions >1GHz 6dB bandwidth Power spectral density	11a	5745 / 5785 / 5825	6 Mbps	---
	VHT20	5745 / 5785 / 5825	MCS 0	
	VHT40	5755 / 5795	MCS 0	
	VHT80	5775	MCS 0	

## 3 Transmitter Test Results

### 3.1 Conducted Emissions

#### 3.1.1 Limit of Conducted Emissions

Conducted Emissions Limit		
Frequency Emission (MHz)	Quasi-Peak	Average
0.15-0.5	66 - 56 *	56 - 46 *
0.5-5	56	46
5-30	60	50

Note 1: \* Decreases with the logarithm of the frequency.

#### 3.1.2 Test Procedures

1. The device is placed on a test table, raised 80 cm above the reference ground plane. The vertical conducting plane is located 40 cm to the rear of the device.
2. The device is connected to line impedance stabilization network (LISN) and other accessories are connected to other LISN. Measured levels of AC power line conducted emission are across the 50  $\Omega$  LISN port.
3. AC conducted emission measurements is made over frequency range from 150 kHz to 30 MHz.
4. This measurement was performed with AC 120V / 60Hz.

#### 3.1.3 Test Setup



Note: 1. Support units were connected to second LISN.

2. Both of LISNs (AMN) are 80 cm from EUT and at least 80 cm from other units and other metal planes

### 3.1.4 Test Result of Conducted Emissions

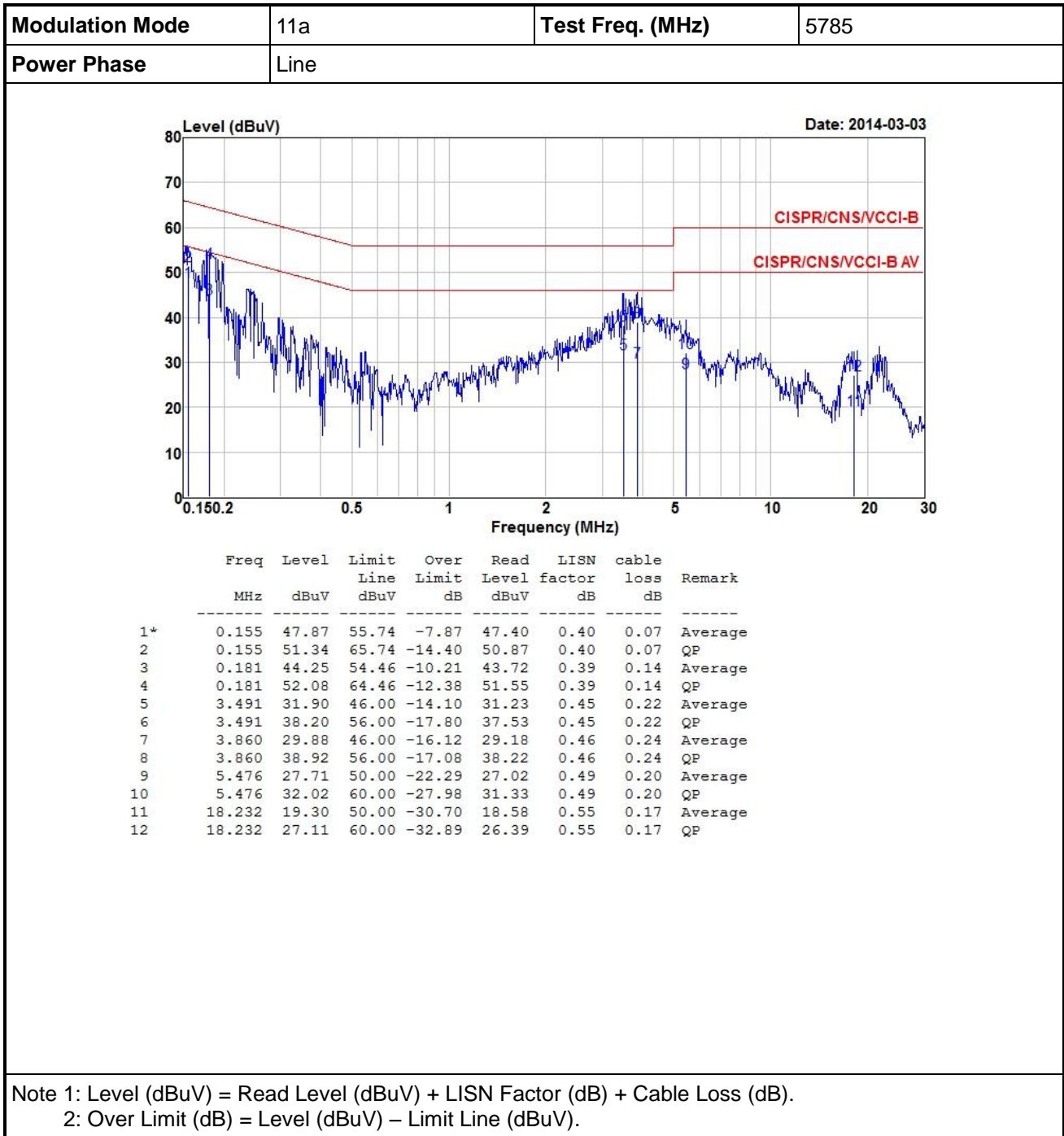

<b>Modulation Mode</b>	11a	<b>Test Freq. (MHz)</b>	5785
<b>Power Phase</b>	Neutral		

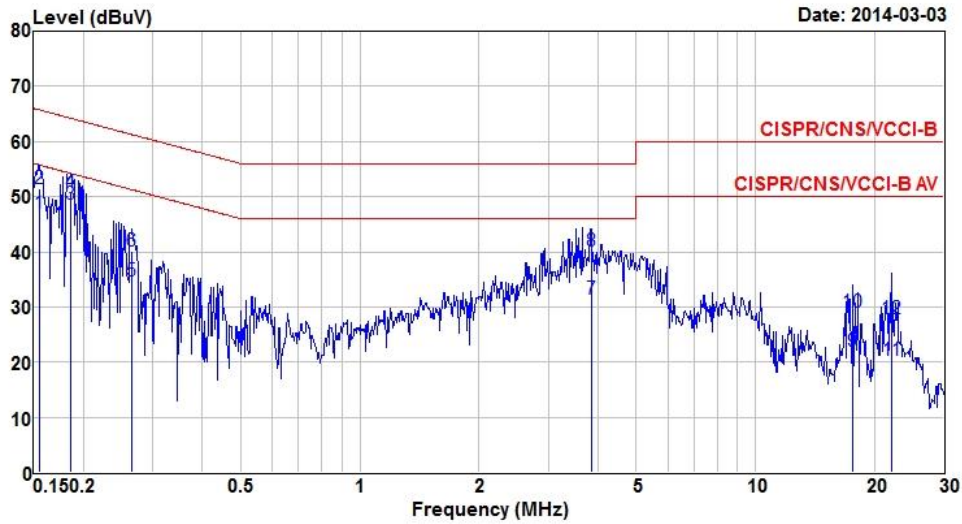

	Freq MHz	Level dBuV	Limit Line dBuV	Over Limit dB	Read Level dBuV	LISN factor dB	cable loss dB	Remark
1	0.155	46.87	55.74	-8.87	46.32	0.48	0.07	Average
2	0.155	51.44	65.74	-14.30	50.89	0.48	0.07	QP
3*	0.186	48.59	54.20	-5.61	47.96	0.48	0.15	Average
4	0.186	50.77	64.20	-13.43	50.14	0.48	0.15	QP
5	0.266	34.68	51.25	-16.57	34.07	0.48	0.13	Average
6	0.266	40.14	61.25	-21.11	39.53	0.48	0.13	QP
7	3.840	31.37	46.00	-14.63	30.61	0.52	0.24	Average
8	3.840	40.01	56.00	-15.99	39.25	0.52	0.24	QP
9	17.661	22.04	50.00	-27.96	21.32	0.56	0.16	Average
10	17.661	29.02	60.00	-30.98	28.30	0.56	0.16	QP
11	22.180	20.33	50.00	-29.67	19.45	0.55	0.33	Average
12	22.180	27.84	60.00	-32.16	26.96	0.55	0.33	QP

Note 1: Level (dBuV) = Read Level (dBuV) + LISN Factor (dB) + Cable Loss (dB).  
 2: Over Limit (dB) = Level (dBuV) – Limit Line (dBuV).

## 3.2 6dB and Occupied Bandwidth

### 3.2.1 Limit of 6dB Bandwidth

The minimum 6dB bandwidth shall be at least 500 kHz.

### 3.2.2 Test Procedures

1. Set resolution bandwidth (RBW) = 100 kHz, Video bandwidth = 300 kHz.
2. Detector = Peak, Trace mode = max hold.
3. Sweep = auto couple, Allow the trace to stabilize.
4. Measure the maximum width of the emission that is constrained by the frequencies associated with the two outermost amplitude points (upper and lower) that are attenuated by 6dB relative to the maximum level measured in the fundamental emission.

### 3.2.3 Test Setup

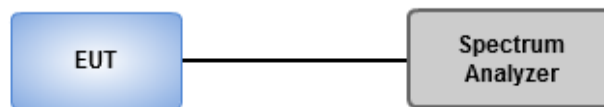

### 3.2.4 Test Result of 6dB and Occupied Bandwidth

Modulation Mode	N <sub>TX</sub>	Freq. (MHz)	6dB Bandwidth (MHz)				Limit (kHz)
			Chain 0	Chain 1	Chain 2	Chain 3	
11a	1	5745	16.52	---	---	---	500
11a	1	5785	16.58	---	---	---	500
11a	1	5825	16.52	---	---	---	500
VHT20	1	5745	17.74	---	---	---	500
VHT20	1	5785	17.68	---	---	---	500
VHT20	1	5825	17.74	---	---	---	500
VHT40	1	5755	36.52	---	---	---	500
VHT40	1	5795	36.52	---	---	---	500
VHT80	1	5775	76.52	---	---	---	500

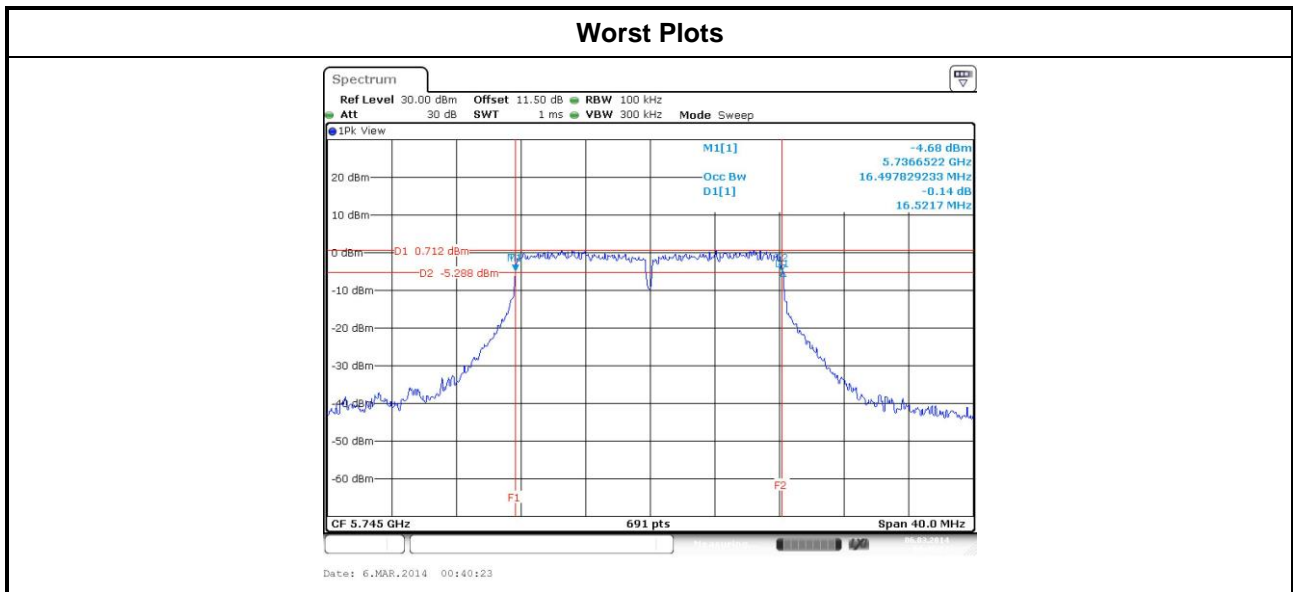

Modulation Mode	N <sub>TX</sub>	Freq. (MHz)	99% Occupied Bandwidth (MHz)			
			Chain 0	Chain 1	Chain 2	Chain 3
11a	1	5745	16.79	---	---	---
11a	1	5785	16.79	---	---	---
11a	1	5825	16.79	---	---	---
VHT20	1	5745	17.87	---	---	---
VHT20	1	5785	17.91	---	---	---
VHT20	1	5825	17.91	---	---	---
VHT40	1	5755	37.05	---	---	---
VHT40	1	5795	37.05	---	---	---
VHT80	1	5775	76.02	---	---	---

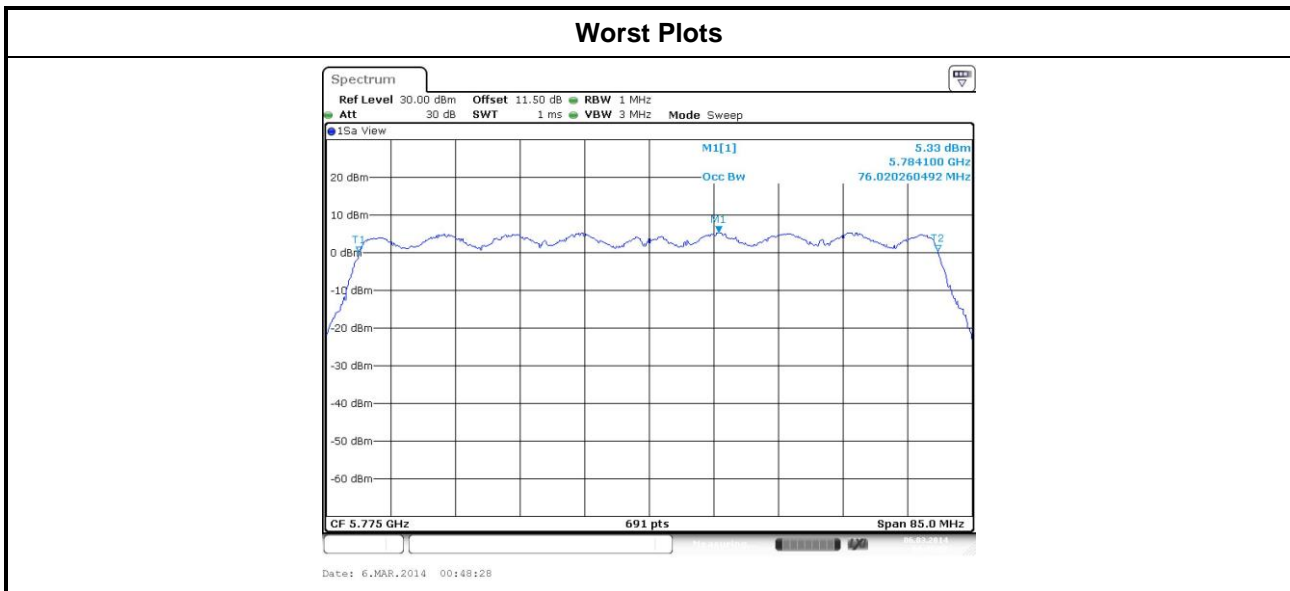



## 3.3 RF Output Power

### 3.3.1 Limit of RF Output Power

Conducted power shall not exceed 1Watt.

- Antenna gain  $\leq$  6dBi, no any corresponding reduction is in output power limit.
- Antenna gain  $>$  6dBi
  - Non Fixed, point to point operations.  
The conducted output power from the intentional radiator shall be reduced by the amount in dB that the directional gain of the antenna exceeds 6 dB
  - Fixed, point to point operations  
Systems operating in the 2400–2483.5 MHz band that are used exclusively for fixed, point-to-point Operations, maximum peak output power of the intentional radiator is reduced by 1 dB for every 3 dB that the directional gain of the antenna exceeds 6 dBi.

Systems operating in the 5725–5850 MHz band that are used exclusively for fixed, point-to-point operations ,no any corresponding reduction is in transmitter peak output power

### 3.3.2 Test Procedures

- Maximum Peak Conducted Output Power
  - Spectrum analyzer** ( For 802.11ac VHT 80)
    1. Set RBW = 1MHz, VBW = 3MHz, Detector = Peak.
    2. Sweep time = auto, Trace mode = max hold, Allow trace to fully stabilize.
    3. Use the spectrum analyzer channel power measurement function with the band limits set equal to the DTS bandwidth edges.
  - Power meter** ( For 802.11a / HT20 / HT40 /VHT20/VHT40)
    1. A broadband Peak RF power meter is used for output power measurement. The video bandwidth of power meter is greater than DTS bandwidth of EUT. If duty cycle of test signal is not 100 %, trigger and gating function of power meter will be enabled to capture transmission burst for measuring output power.
- Maximum Conducted Output Power ( For reference only)
  - Power meter**
    1. A broadband Average RF power meter is used for output power measurement. The video bandwidth of power meter is greater than DTS bandwidth of EUT. If duty cycle of test signal is not 100 %, trigger and gating function of power meter will be enabled to capture transmission burst for measuring output power.

### 3.3.3 Test Setup

For 802.11ac VHT80

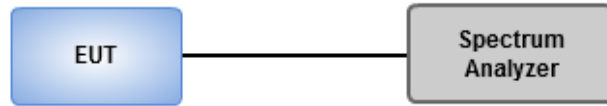

(For 802.11a / HT20 / HT40 /VHT20/VHT40)

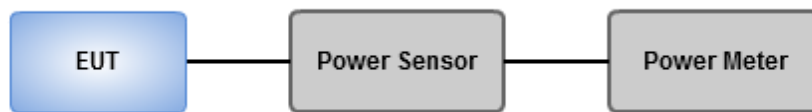

### 3.3.4 Test Result of Maximum Output Power

Modulation Mode	N <sub>TX</sub>	Freq. (MHz)	Maximum Peak Conducted Output Power (dBm)				Total Power (mW)	Total Power (dBm)	Limit (dBm)
			Chain 0	Chain 1	Chain 2	Chain 3			
11a	1	5745	23.54	---	---	---	225.944	23.54	30.00
11a	1	5785	23.65	---	---	---	231.739	23.65	30.00
11a	1	5825	23.43	---	---	---	220.293	23.43	30.00
HT20	1	5745	23.08	---	---	---	203.236	23.08	30.00
HT20	1	5785	23.19	---	---	---	208.449	23.19	30.00
HT20	1	5825	23.12	---	---	---	205.116	23.12	30.00
HT40	1	5755	23.14	---	---	---	206.063	23.14	30.00
HT40	1	5795	23.22	---	---	---	209.894	23.22	30.00
VHT20	1	5745	23.11	---	---	---	204.644	23.11	30.00
VHT20	1	5785	23.26	---	---	---	211.836	23.26	30.00
VHT20	1	5825	23.17	---	---	---	207.491	23.17	30.00
VHT40	1	5755	23.18	---	---	---	207.970	23.18	30.00
VHT40	1	5795	23.29	---	---	---	213.304	23.29	30.00
VHT80	1	5775	22.17	---	---	---	164.816	22.17	30.00

Modulation Mode	N <sub>TX</sub>	Freq. (MHz)	Conducted (average) output power (dBm)				Total Power (mW)	Total Power (dBm)	Limit (dBm)
			Chain 0	Chain 1	Chain 2	Chain 3			
11a	1	5745	14.37	---	---	---	27.353	14.37	30.00
11a	1	5785	14.41	---	---	---	27.606	14.41	30.00
11a	1	5825	14.28	---	---	---	26.792	14.28	30.00
HT20	1	5745	14.31	---	---	---	26.977	14.31	30.00
HT20	1	5785	14.36	---	---	---	27.290	14.36	30.00
HT20	1	5825	14.12	---	---	---	25.823	14.12	30.00
HT40	1	5755	14.29	---	---	---	26.853	14.29	30.00
HT40	1	5795	14.36	---	---	---	27.290	14.36	30.00
VHT20	1	5745	14.35	---	---	---	27.227	14.35	30.00
VHT20	1	5785	14.42	---	---	---	27.669	14.42	30.00
VHT20	1	5825	14.21	---	---	---	26.363	14.21	30.00
VHT40	1	5755	14.36	---	---	---	27.290	14.36	30.00
VHT40	1	5795	14.42	---	---	---	27.669	14.42	30.00
VHT80	1	5775	14.02	---	---	---	25.235	14.02	30.00

Note: Conducted average output power is for reference only.

## 3.4 Power Spectral Density

### 3.4.1 Limit of Power Spectral Density

Power spectral density shall not be greater than 8 dBm in any 3 kHz band.

### 3.4.2 Test Procedures

- Maximum peak conducted output power was used to demonstrate compliance to the fundamental output power limit.
  1. Set the RBW = 3kHz, VBW = 10kHz.
  2. Detector = Peak, Sweep time = auto couple.
  3. Trace mode = max hold, allow trace to fully stabilize.
  4. Use the peak marker function to determine the maximum amplitude level.
- Maximum (average) conducted output power was used to demonstrate compliance to the fundamental output power limit.
  1. Set the RBW = 30kHz, VBW = 100 kHz.
  2. Detector = RMS, Sweep time = auto couple.
  3. Set the sweep time to:  $\geq 10 \times$  (number of measurement points in sweep)  $\times$  (maximum data rate per stream).
  4. Perform the measurement over a single sweep.
  5. Use the peak marker function to determine the maximum amplitude level.

### 3.4.3 Test Setup

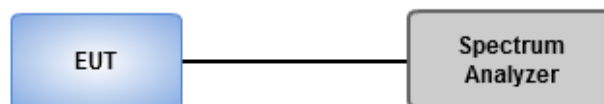

### 3.4.4 Test Result of Power Spectral Density

Modulation Mode	N <sub>TX</sub>	Freq. (MHz)	Total Power Spectral Density (dBm/30kHz)	Limit (dBm/3kHz)
11a	1	5745	-13.72	8
11a	1	5785	-13.52	8
11a	1	5825	-13.25	8
VHT20	1	5745	-11.87	8
VHT20	1	5785	-12.41	8
VHT20	1	5825	-12.27	8
VHT40	1	5755	-14.68	8
VHT40	1	5795	-14.21	8
VHT80	1	5775	-19.07	8

**Worst Plots**

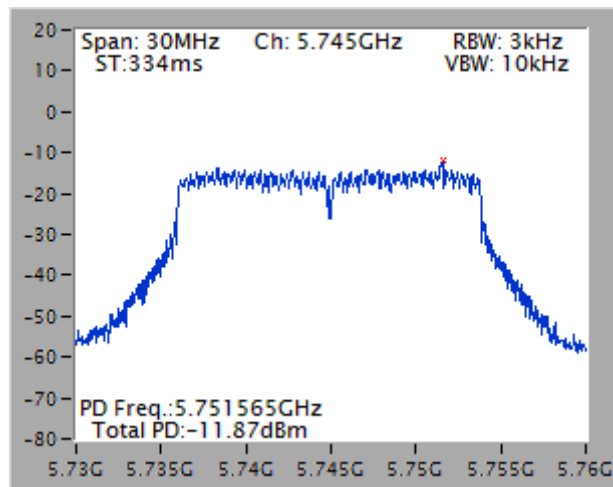

## 3.5 Unwanted Emissions into Restricted Frequency Bands

### 3.5.1 Limit of Unwanted Emissions into Restricted Frequency Bands

Restricted Band Emissions Limit			
Frequency Range (MHz)	Field Strength (uV/m)	Field Strength (dBuV/m)	Measure Distance (m)
0.009~0.490	2400/F(kHz)	48.5 - 13.8	300
0.490~1.705	24000/F(kHz)	33.8 - 23	30
1.705~30.0	30	29	30
30~88	100	40	3
88~216	150	43.5	3
216~960	200	46	3
Above 960	500	54	3

**Note 1:**  
Qusai-Peak value is measured for frequency below 1GHz except for 9–90 kHz, 110–490 kHz frequency band. Peak and average value are measured for frequency above 1GHz. The limit on average radio frequency emission is as above table. The limit on peak radio frequency emissions is 20 dB above the maximum permitted average emission limit

**Note 2:**  
Measurements may be performed at a distance other than what is specified provided. When performing measurements at a distance other than that specified, the results shall be extrapolated to the specified distance using an extrapolation factor as below, Frequency at or above 30 MHz: 20 dB/decade Frequency below 30 MHz: 40 dB/decade.

### 3.5.2 Test Procedures

1. Measurement is made at a semi-anechoic chamber that incorporates a turntable allowing a EUT rotation of 360°. A continuously-rotating, remotely-controlled turntable is installed at the test site to support the EUT and facilitate determination of the direction of maximum radiation for each EUT emission frequency. The EUT is placed at a height of 0.8 m test table above the ground plane.
2. Measurement is made with the antenna positioned in both the horizontal and vertical planes of polarization. The measurement antenna is varied in height (1m ~ 4m) above the reference ground plane to obtain the maximum signal strength. Distance between EUT and antenna is 3 m.
3. This investigation is performed with the EUT rotated 360°, the antenna height scanned between 1 m and 4 m, and the antenna rotated to repeat the measurements for both the horizontal and vertical antenna polarizations.

Note:

1. 120kHz measurement bandwidth of test receiver and Quasi-peak detector is for radiated emission below 1GHz.
2. RBW=1MHz, VBW=3MHz and Peak detector is for peak measured value of radiated emission above 1GHz.
3. RBW=1MHz, VBW=1/T and Peak detector is for average measured value of radiated emission above 1GHz.

### 3.5.3 Test Setup

#### Radiated Emissions below 1 GHz

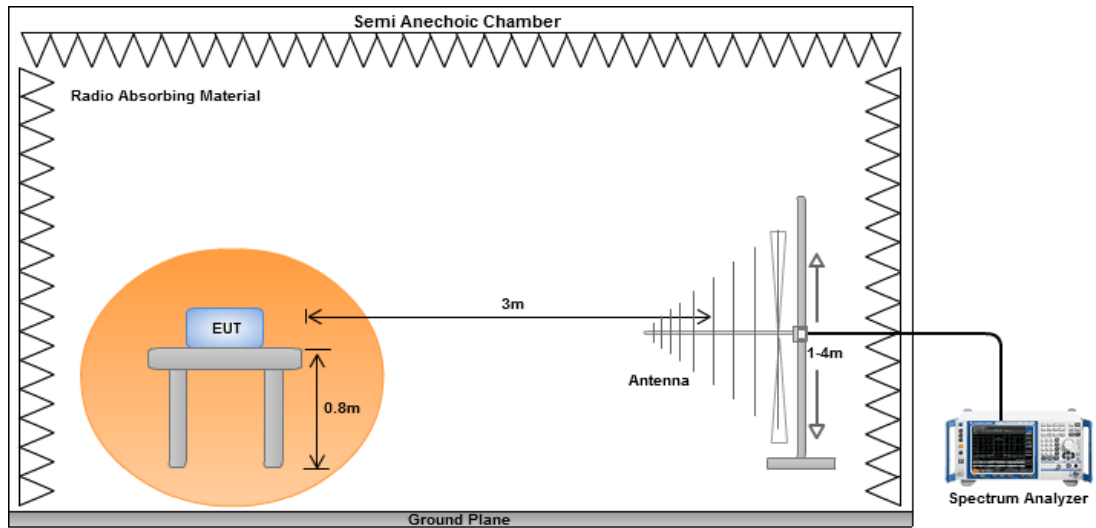

#### Radiated Emissions above 1 GHz

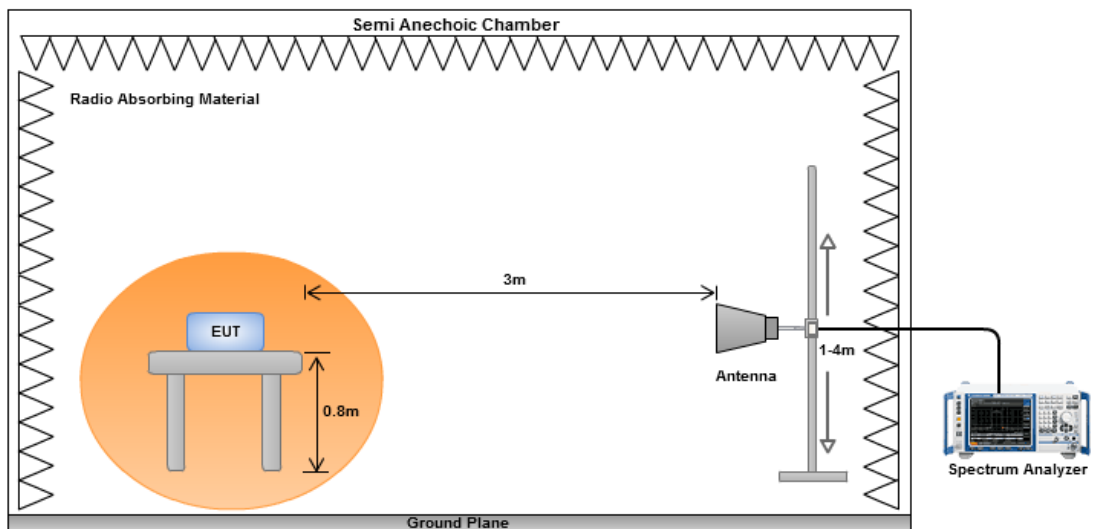

### 3.5.4 Transmitter Radiated Unwanted Emissions (Below 1GHz)

<b>Modulation</b>	11a	<b>Test Freq. (MHz)</b>	5785
<b>Polarization</b>	Horizontal		

  

	Freq. MHz	Emission level dBuV/m	Limit dBuV/m	Margin dB	SA reading dBuV	Factor dB	Remark	ANT High cm	Turn Table deg
1	135.73	35.27	43.50	-8.23	52.97	-17.70	Peak	---	---
2	178.51	40.07	43.50	-3.43	58.43	-18.36	QP	---	---
3	232.73	42.26	46.00	-3.74	60.72	-18.46	Peak	---	---
4	298.69	32.90	46.00	-13.10	49.09	-16.19	Peak	---	---
5	749.74	37.85	46.00	-8.15	45.09	-7.24	Peak	---	---
6	868.08	37.67	46.00	-8.33	43.58	-5.91	Peak	---	---

Note 1: Emission Level (dBuV/m) = SA Reading (dBuV/m) + Factor\* (dB)  
\*Factor includes antenna factor , cable loss and amplifier gain  
Note 2: Margin (dB) = Emission level (dBuV/m) – Limit (dBuV/m).  
Note 3: All spurious emissions below 30MHz are more than 20 dB below the limit.



<b>Modulation</b>	11a	<b>Test Freq. (MHz)</b>	5785
<b>Polarization</b>	Vertical		

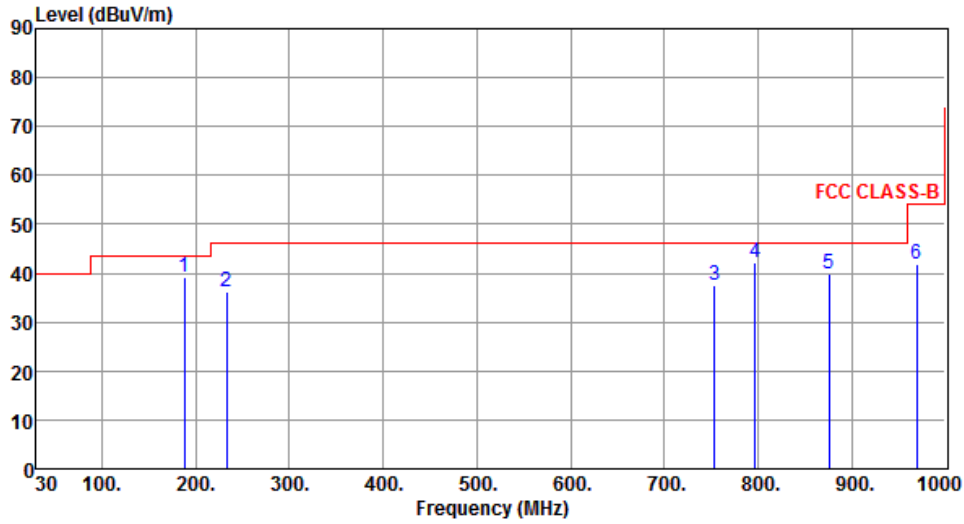

	Freq. MHz	Emission level dBuV/m	Limit dBuV/m	Margin dB	SA reading dBuV	Factor dB	Remark	ANT High cm	Turn Table deg
1	188.11	39.06	43.50	-4.44	58.44	-19.38	Peak	---	---
2	232.73	36.04	46.00	-9.96	54.50	-18.46	Peak	---	---
3	753.62	37.37	46.00	-8.63	44.57	-7.20	Peak	---	---
4	797.27	42.06	46.00	-3.94	48.86	-6.80	Peak	---	---
5	875.84	39.77	46.00	-6.23	45.58	-5.81	Peak	---	---
6	968.96	41.84	54.00	-12.16	46.41	-4.57	Peak	---	---

Note 1: Emission Level (dBuV/m) = SA Reading (dBuV/m) + Factor\* (dB)

\*Factor includes antenna factor , cable loss and amplifier gain

Note 2: Margin (dB) = Emission level (dBuV/m) – Limit (dBuV/m).

Note 3: All spurious emissions below 30MHz are more than 20 dB below the limit.

### 3.5.5 Transmitter Radiated Unwanted Emissions (Above 1GHz) for 11a

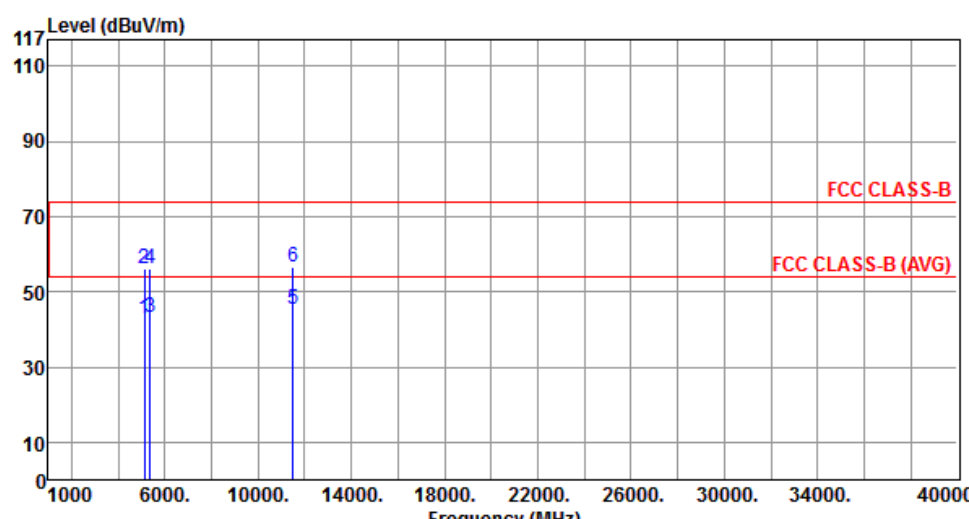
Modulation	11a	Test Freq. (MHz)	5745						
Polarization	Horizontal								
									
	Freq.	Emission level	Limit	Margin	SA reading	Factor	Remark	ANT High	Turn Table
	MHz	dBuV/m	dBuV/m	dB	dBuV	dB		cm	deg
1	5140.00	42.81	54.00	-11.19	37.26	5.55	Average	---	---
2	5140.00	56.22	74.00	-17.78	50.67	5.55	Peak	---	---
3	5356.00	43.21	54.00	-10.79	37.50	5.71	Average	---	---
4	5356.00	56.00	74.00	-18.00	50.29	5.71	Peak	---	---
5	11490.00	45.40	54.00	-8.60	30.83	14.57	Average	---	---
6	11490.00	56.59	74.00	-17.41	42.02	14.57	Peak	---	---
<p>Note 1: Emission Level (dBuV/m) = SA Reading (dBuV/m) + Factor* (dB)            *Factor includes antenna factor , cable loss and amplifier gain            Note 2: Margin (dB) = Emission level (dBuV/m) – Limit (dBuV/m).</p>									

<b>Modulation</b>	11a	<b>Test Freq. (MHz)</b>	5745
<b>Polarization</b>	Vertical		

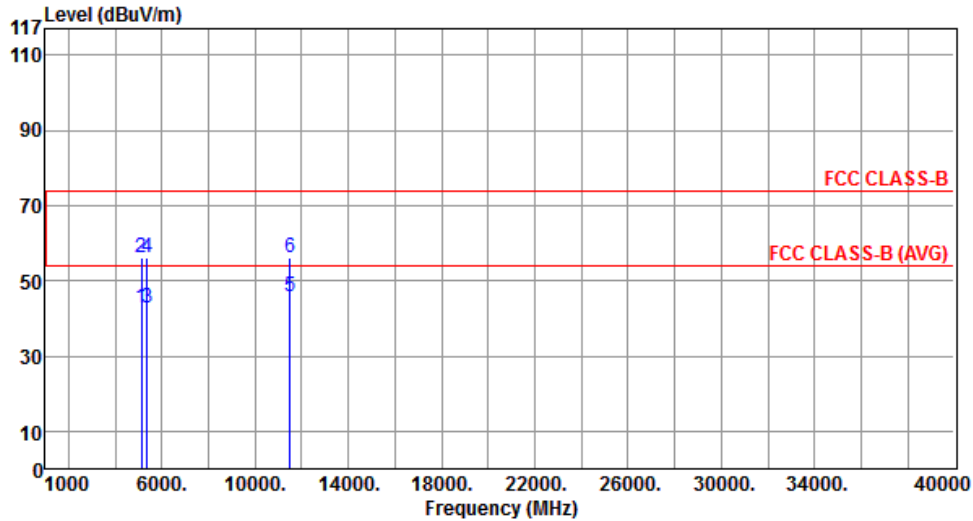

	Freq. MHz	Emission level dBuV/m	Limit dBuV/m	Margin dB	SA reading dBuV	Factor dB	Remark	ANT High cm	Turn Table deg
1	5140.00	42.59	54.00	-11.41	37.04	5.55	Average	---	---
2	5140.00	55.98	74.00	-18.02	50.43	5.55	Peak	---	---
3	5356.00	42.88	54.00	-11.12	37.17	5.71	Average	---	---
4	5356.00	55.95	74.00	-18.05	50.24	5.71	Peak	---	---
5	11490.00	45.77	54.00	-8.23	31.20	14.57	Average	---	---
6	11490.00	56.17	74.00	-17.83	41.60	14.57	Peak	---	---

Note 1: Emission Level (dBuV/m) = SA Reading (dBuV/m) + Factor\* (dB)

\*Factor includes antenna factor , cable loss and amplifier gain

Note 2: Margin (dB) = Emission level (dBuV/m) – Limit (dBuV/m).

<b>Modulation</b>	11a	<b>Test Freq. (MHz)</b>	5785
<b>Polarization</b>	Horizontal		

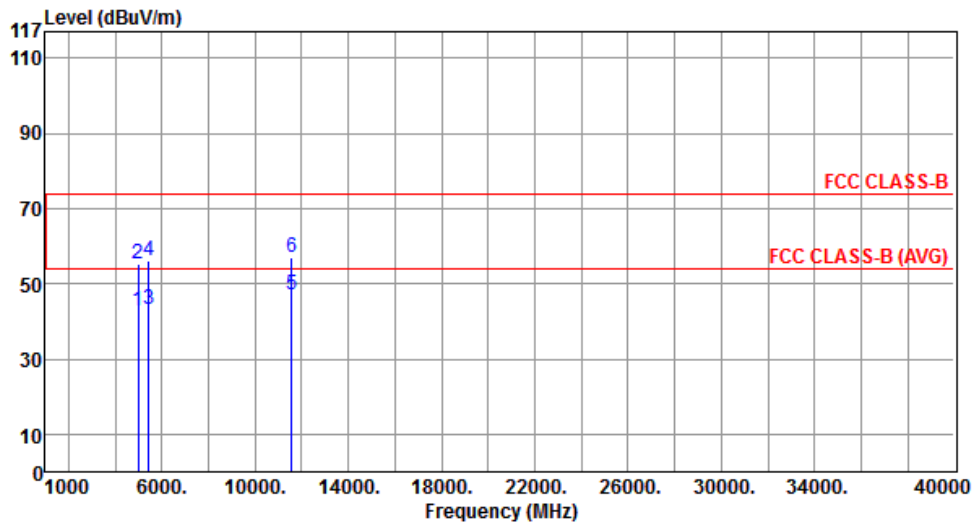

	Freq. MHz	Emission level dBuV/m	Limit dBuV/m	Margin dB	SA reading dBuV	Factor dB	Remark	ANT High cm	Turn Table deg
1	5000.00	42.59	54.00	-11.41	37.23	5.36	Average	---	---
2	5000.00	55.32	74.00	-18.68	49.96	5.36	Peak	---	---
3	5425.00	43.18	54.00	-10.82	37.46	5.72	Average	---	---
4	5425.00	56.06	74.00	-17.94	50.34	5.72	Peak	---	---
5	11570.00	47.16	54.00	-6.84	32.67	14.49	Average	---	---
6	11570.00	56.99	74.00	-17.01	42.50	14.49	Peak	---	---

Note 1: Emission Level (dBuV/m) = SA Reading (dBuV/m) + Factor\* (dB)

\*Factor includes antenna factor , cable loss and amplifier gain

Note 2: Margin (dB) = Emission level (dBuV/m) – Limit (dBuV/m).

<b>Modulation</b>	11a	<b>Test Freq. (MHz)</b>	5785
<b>Polarization</b>	Vertical		

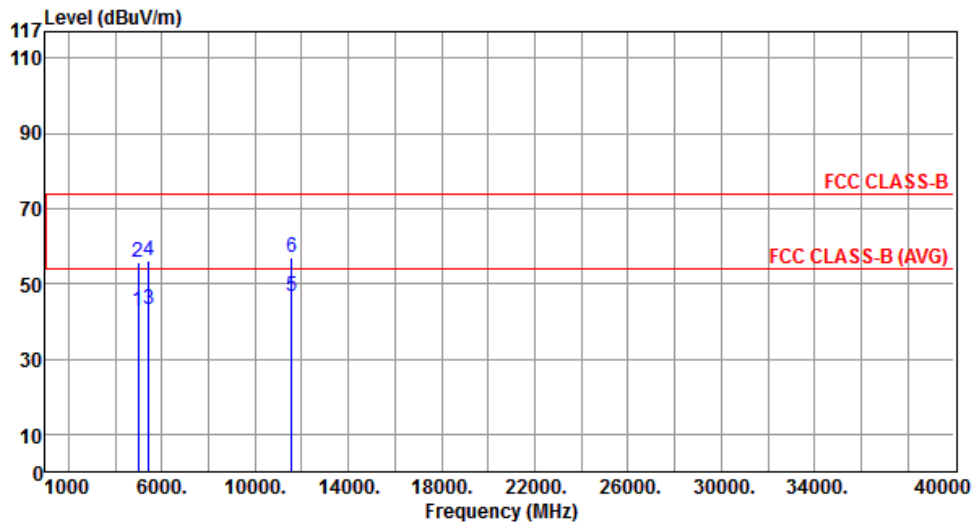

	Freq. MHz	Emission level dBuV/m	Limit dBuV/m	Margin dB	SA reading dBuV	Factor dB	Remark	ANT High cm	Turn Table deg
1	5000.00	42.72	54.00	-11.28	37.36	5.36	Average	---	---
2	5000.00	55.68	74.00	-18.32	50.32	5.36	Peak	---	---
3	5425.00	43.02	54.00	-10.98	37.30	5.72	Average	---	---
4	5425.00	56.21	74.00	-17.79	50.49	5.72	Peak	---	---
5	11570.00	46.84	54.00	-7.16	32.35	14.49	Average	---	---
6	11570.00	56.91	74.00	-17.09	42.42	14.49	Peak	---	---

Note 1: Emission Level (dBuV/m) = SA Reading (dBuV/m) + Factor\* (dB)

\*Factor includes antenna factor , cable loss and amplifier gain

Note 2: Margin (dB) = Emission level (dBuV/m) – Limit (dBuV/m).

<b>Modulation</b>	11a	<b>Test Freq. (MHz)</b>	5825
<b>Polarization</b>	Horizontal		

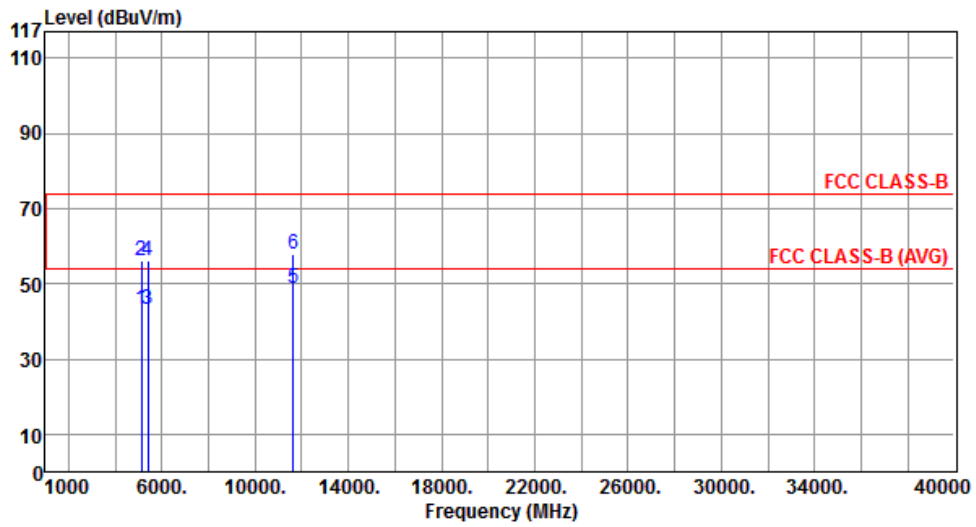

	Freq. MHz	Emission level dBuV/m	Limit dBuV/m	Margin dB	SA reading dBuV	Factor dB	Remark	ANT High cm	Turn Table deg
1	5140.00	43.07	54.00	-10.93	37.52	5.55	Average	---	---
2	5140.00	56.00	74.00	-18.00	50.45	5.55	Peak	---	---
3	5400.00	43.09	54.00	-10.91	37.35	5.74	Average	---	---
4	5400.00	55.92	74.00	-18.08	50.18	5.74	Peak	---	---
5	11650.00	48.83	54.00	-5.17	34.44	14.39	Average	---	---
6	11650.00	58.06	74.00	-15.94	43.67	14.39	Peak	---	---

Note 1: Emission Level (dBuV/m) = SA Reading (dBuV/m) + Factor\* (dB)

\*Factor includes antenna factor , cable loss and amplifier gain

Note 2: Margin (dB) = Emission level (dBuV/m) – Limit (dBuV/m).

<b>Modulation</b>	11a	<b>Test Freq. (MHz)</b>	5825
<b>Polarization</b>	Vertical		

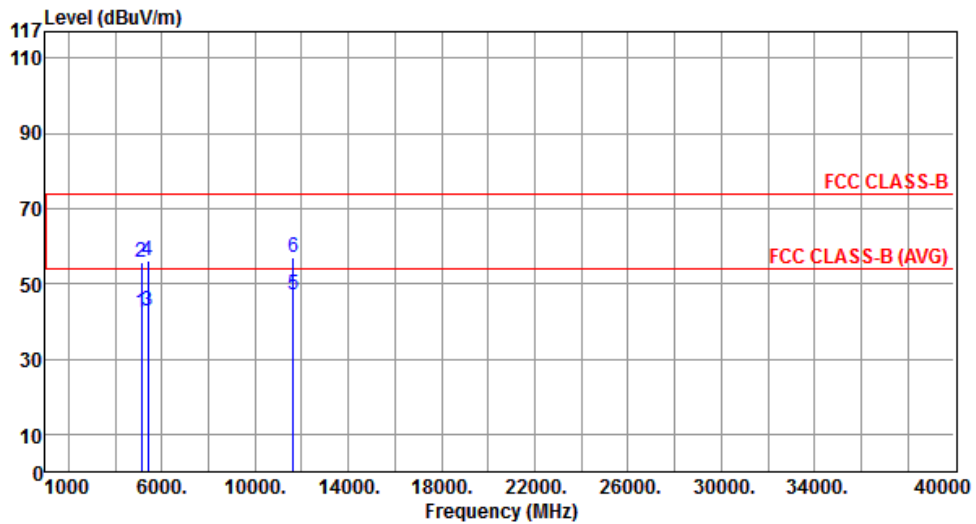

	Freq. MHz	Emission level dBuV/m	Limit dBuV/m	Margin dB	SA reading dBuV	Factor dB	Remark	ANT High cm	Turn Table deg
1	5140.00	42.36	54.00	-11.64	36.81	5.55	Average	---	---
2	5140.00	55.62	74.00	-18.38	50.07	5.55	Peak	---	---
3	5400.00	42.71	54.00	-11.29	36.97	5.74	Average	---	---
4	5400.00	56.08	74.00	-17.92	50.34	5.74	Peak	---	---
5	11650.00	46.94	54.00	-7.06	32.55	14.39	Average	---	---
6	11650.00	57.18	74.00	-16.82	42.79	14.39	Peak	---	---

Note 1: Emission Level (dBuV/m) = SA Reading (dBuV/m) + Factor\* (dB)

\*Factor includes antenna factor , cable loss and amplifier gain

Note 2: Margin (dB) = Emission level (dBuV/m) – Limit (dBuV/m).

### 3.5.6 Transmitter Radiated Unwanted Emissions (Above 1GHz) for VHT20

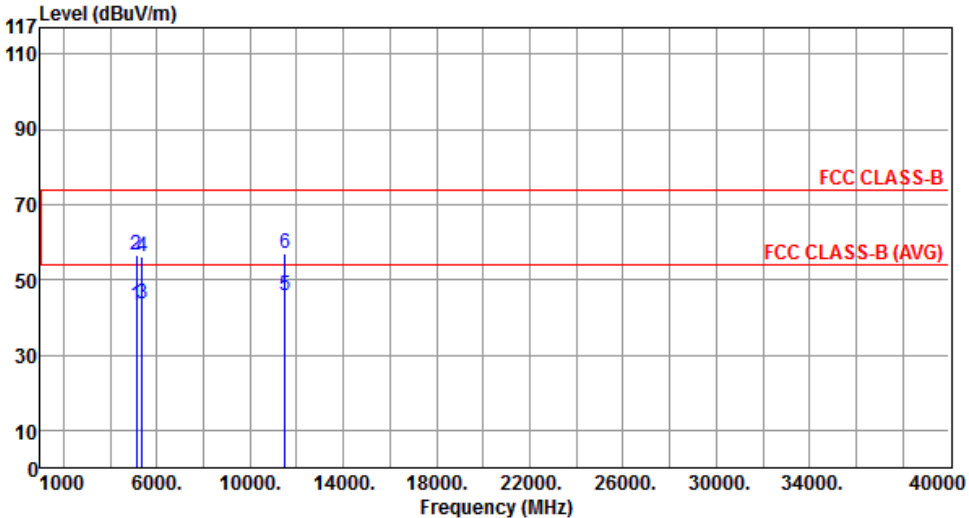
Modulation	VHT20	Test Freq. (MHz)	5745						
Polarization	Horizontal								
									
	Freq.	Emission level	Limit	Margin	SA reading	Factor	Remark	ANT High	Turn Table
	MHz	dBuV/m	dBuV/m	dB	dBuV	dB		cm	deg
1	5140.00	42.96	54.00	-11.04	37.41	5.55	Average	---	---
2	5140.00	56.38	74.00	-17.62	50.83	5.55	Peak	---	---
3	5356.00	43.45	54.00	-10.55	37.74	5.71	Average	---	---
4	5356.00	56.23	74.00	-17.77	50.52	5.71	Peak	---	---
5	11490.00	45.62	54.00	-8.38	31.05	14.57	Average	---	---
6	11490.00	56.84	74.00	-17.16	42.27	14.57	Peak	---	---
<p>Note 1: Emission Level (dBuV/m) = SA Reading (dBuV/m) + Factor* (dB)            *Factor includes antenna factor , cable loss and amplifier gain            Note 2: Margin (dB) = Emission level (dBuV/m) – Limit (dBuV/m).</p>									



<b>Modulation</b>	VHT20	<b>Test Freq. (MHz)</b>	5745
<b>Polarization</b>	Vertical		

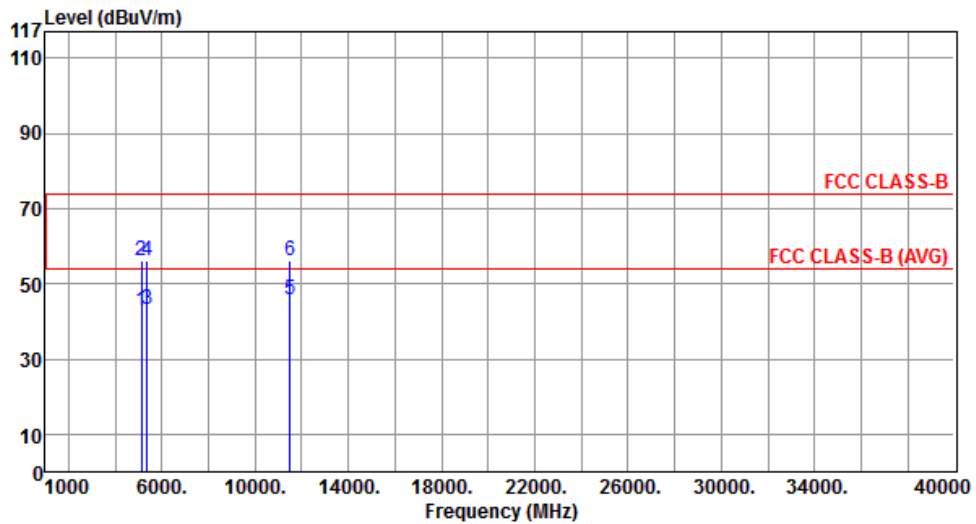

	Freq. MHz	Emission level dBuV/m	Limit dBuV/m	Margin dB	SA reading dBuV	Factor dB	Remark	ANT High cm	Turn Table deg
1	5140.00	42.75	54.00	-11.25	37.20	5.55	Average	---	---
2	5140.00	56.23	74.00	-17.77	50.68	5.55	Peak	---	---
3	5356.00	43.08	54.00	-10.92	37.37	5.71	Average	---	---
4	5356.00	56.15	74.00	-17.85	50.44	5.71	Peak	---	---
5	11490.00	45.95	54.00	-8.05	31.38	14.57	Average	---	---
6	11490.00	56.32	74.00	-17.68	41.75	14.57	Peak	---	---

Note 1: Emission Level (dBuV/m) = SA Reading (dBuV/m) + Factor\* (dB)

\*Factor includes antenna factor , cable loss and amplifier gain

Note 2: Margin (dB) = Emission level (dBuV/m) – Limit (dBuV/m).

<b>Modulation</b>	VHT20	<b>Test Freq. (MHz)</b>	5785
<b>Polarization</b>	Horizontal		

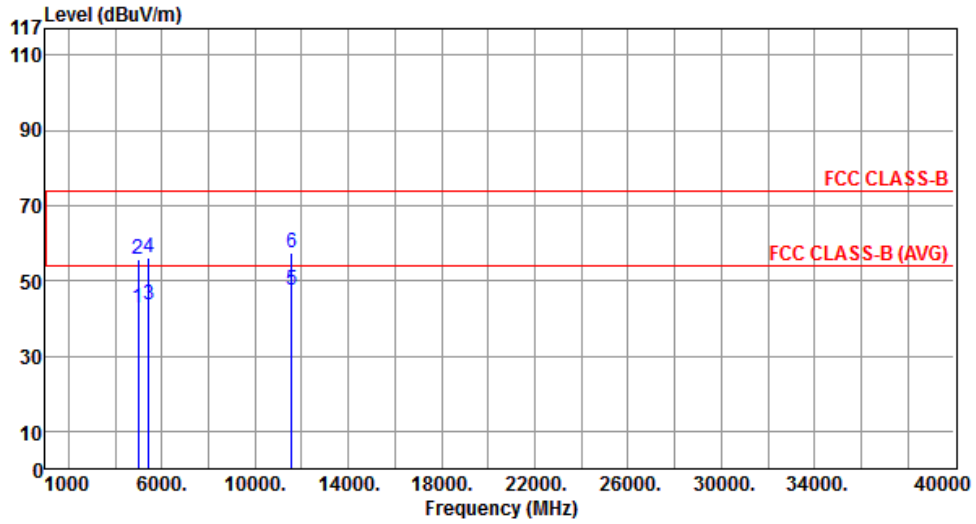

	Freq. MHz	Emission level dBuV/m	Limit dBuV/m	Margin dB	SA reading dBuV	Factor dB	Remark	ANT High cm	Turn Table deg
1	5000.00	42.83	54.00	-11.17	37.47	5.36	Average	---	---
2	5000.00	55.54	74.00	-18.46	50.18	5.36	Peak	---	---
3	5425.00	43.45	54.00	-10.55	37.73	5.72	Average	---	---
4	5425.00	56.28	74.00	-17.72	50.56	5.72	Peak	---	---
5	11570.00	47.36	54.00	-6.64	32.87	14.49	Average	---	---
6	11570.00	57.21	74.00	-16.79	42.72	14.49	Peak	---	---

Note 1: Emission Level (dBuV/m) = SA Reading (dBuV/m) + Factor\* (dB)

\*Factor includes antenna factor , cable loss and amplifier gain

Note 2: Margin (dB) = Emission level (dBuV/m) – Limit (dBuV/m).

<b>Modulation</b>	VHT20	<b>Test Freq. (MHz)</b>	5785
<b>Polarization</b>	Vertical		

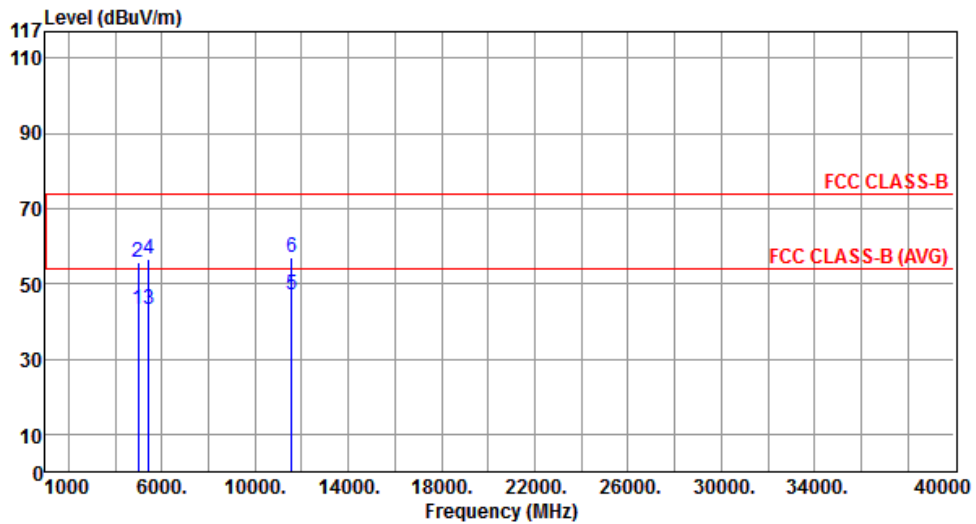

	Freq. MHz	Emission level dBuV/m	Limit dBuV/m	Margin dB	SA reading dBuV	Factor dB	Remark	ANT High cm	Turn Table deg
1	5000.00	42.96	54.00	-11.04	37.60	5.36	Average	---	---
2	5000.00	55.84	74.00	-18.16	50.48	5.36	Peak	---	---
3	5425.00	43.26	54.00	-10.74	37.54	5.72	Average	---	---
4	5425.00	56.48	74.00	-17.52	50.76	5.72	Peak	---	---
5	11570.00	47.04	54.00	-6.96	32.55	14.49	Average	---	---
6	11570.00	57.12	74.00	-16.88	42.63	14.49	Peak	---	---

Note 1: Emission Level (dBuV/m) = SA Reading (dBuV/m) + Factor\* (dB)

\*Factor includes antenna factor , cable loss and amplifier gain

Note 2: Margin (dB) = Emission level (dBuV/m) – Limit (dBuV/m).

<b>Modulation</b>	VHT20	<b>Test Freq. (MHz)</b>	5825
<b>Polarization</b>	Horizontal		

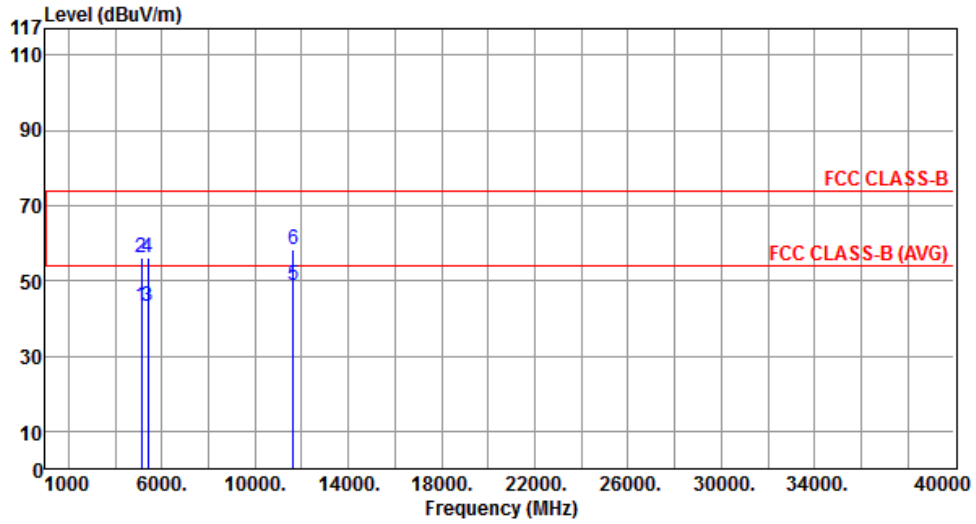

	Freq. MHz	Emission level dBuV/m	Limit dBuV/m	Margin dB	SA reading dBuV	Factor dB	Remark	ANT High cm	Turn Table deg
1	5140.00	43.25	54.00	-10.75	37.70	5.55	Average	---	---
2	5140.00	56.24	74.00	-17.76	50.69	5.55	Peak	---	---
3	5400.00	43.26	54.00	-10.74	37.52	5.74	Average	---	---
4	5400.00	56.14	74.00	-17.86	50.40	5.74	Peak	---	---
5	11650.00	48.96	54.00	-5.04	34.57	14.39	Average	---	---
6	11650.00	58.21	74.00	-15.79	43.82	14.39	Peak	---	---

Note 1: Emission Level (dBuV/m) = SA Reading (dBuV/m) + Factor\* (dB)

\*Factor includes antenna factor , cable loss and amplifier gain

Note 2: Margin (dB) = Emission level (dBuV/m) – Limit (dBuV/m).

<b>Modulation</b>	VHT20	<b>Test Freq. (MHz)</b>	5825
<b>Polarization</b>	Vertical		

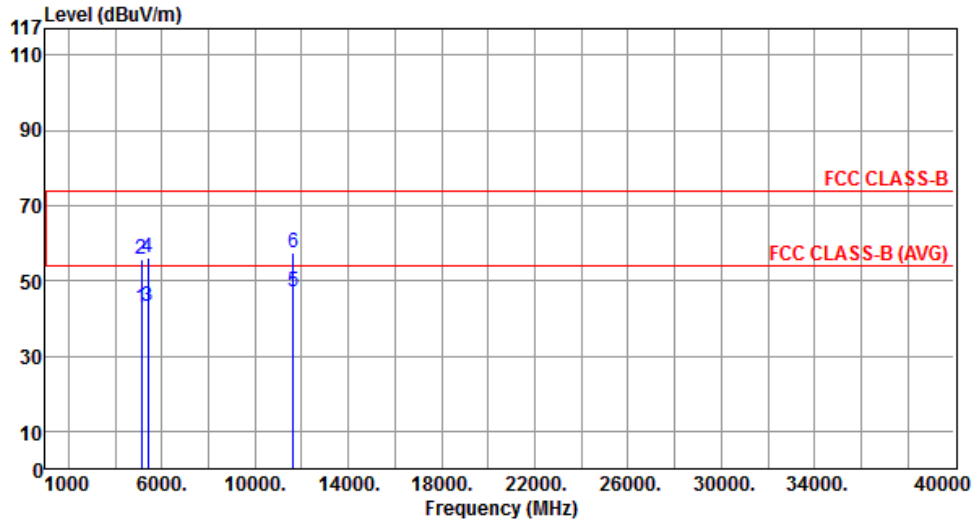

	Freq. MHz	Emission level dBuV/m	Limit dBuV/m	Margin dB	SA reading dBuV	Factor dB	Remark	ANT High cm	Turn Table deg
1	5140.00	42.65	54.00	-11.35	37.10	5.55	Average	---	---
2	5140.00	55.89	74.00	-18.11	50.34	5.55	Peak	---	---
3	5400.00	42.96	54.00	-11.04	37.22	5.74	Average	---	---
4	5400.00	56.24	74.00	-17.76	50.50	5.74	Peak	---	---
5	11650.00	47.23	54.00	-6.77	32.84	14.39	Average	---	---
6	11650.00	57.36	74.00	-16.64	42.97	14.39	Peak	---	---

Note 1: Emission Level (dBuV/m) = SA Reading (dBuV/m) + Factor\* (dB)

\*Factor includes antenna factor , cable loss and amplifier gain

Note 2: Margin (dB) = Emission level (dBuV/m) – Limit (dBuV/m).

### 3.5.7 Transmitter Radiated Unwanted Emissions (Above 1GHz) for VHT40

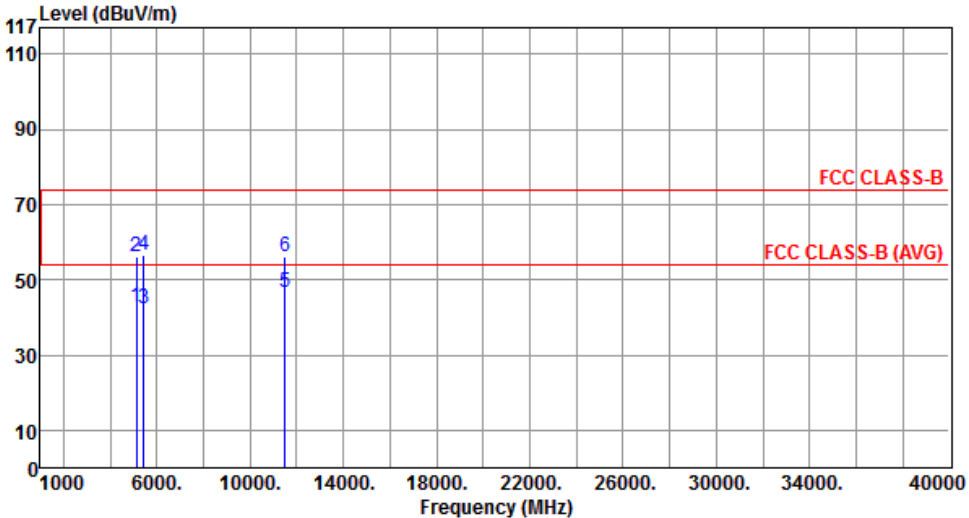
Modulation	VHT40	Test Freq. (MHz)	5755																																																																						
Polarization	Horizontal																																																																								
																																																																									
	<table border="1"> <thead> <tr> <th>Freq.</th> <th>Emission level</th> <th>Limit</th> <th>Margin</th> <th>SA reading</th> <th>Factor</th> <th>Remark</th> <th>ANT High</th> <th>Turn Table</th> </tr> <tr> <th>MHz</th> <th>dBuV/m</th> <th>dBuV/m</th> <th>dB</th> <th>dBuV</th> <th>dB</th> <th></th> <th>cm</th> <th>deg</th> </tr> </thead> <tbody> <tr> <td>1</td> <td>5140.00</td> <td>42.67</td> <td>54.00</td> <td>-11.33</td> <td>37.12</td> <td>5.55</td> <td>Average</td> <td>---</td> </tr> <tr> <td>2</td> <td>5140.00</td> <td>55.98</td> <td>74.00</td> <td>-18.02</td> <td>50.43</td> <td>5.55</td> <td>Peak</td> <td>---</td> </tr> <tr> <td>3</td> <td>5425.00</td> <td>42.29</td> <td>54.00</td> <td>-11.71</td> <td>36.57</td> <td>5.72</td> <td>Average</td> <td>---</td> </tr> <tr> <td>4</td> <td>5425.00</td> <td>56.65</td> <td>74.00</td> <td>-17.35</td> <td>50.93</td> <td>5.72</td> <td>Peak</td> <td>---</td> </tr> <tr> <td>5</td> <td>11510.00</td> <td>46.55</td> <td>54.00</td> <td>-7.45</td> <td>32.00</td> <td>14.55</td> <td>Average</td> <td>---</td> </tr> <tr> <td>6</td> <td>11510.00</td> <td>56.33</td> <td>74.00</td> <td>-17.67</td> <td>41.78</td> <td>14.55</td> <td>Peak</td> <td>---</td> </tr> </tbody> </table>	Freq.	Emission level	Limit	Margin	SA reading	Factor	Remark	ANT High	Turn Table	MHz	dBuV/m	dBuV/m	dB	dBuV	dB		cm	deg	1	5140.00	42.67	54.00	-11.33	37.12	5.55	Average	---	2	5140.00	55.98	74.00	-18.02	50.43	5.55	Peak	---	3	5425.00	42.29	54.00	-11.71	36.57	5.72	Average	---	4	5425.00	56.65	74.00	-17.35	50.93	5.72	Peak	---	5	11510.00	46.55	54.00	-7.45	32.00	14.55	Average	---	6	11510.00	56.33	74.00	-17.67	41.78	14.55	Peak	---
Freq.	Emission level	Limit	Margin	SA reading	Factor	Remark	ANT High	Turn Table																																																																	
MHz	dBuV/m	dBuV/m	dB	dBuV	dB		cm	deg																																																																	
1	5140.00	42.67	54.00	-11.33	37.12	5.55	Average	---																																																																	
2	5140.00	55.98	74.00	-18.02	50.43	5.55	Peak	---																																																																	
3	5425.00	42.29	54.00	-11.71	36.57	5.72	Average	---																																																																	
4	5425.00	56.65	74.00	-17.35	50.93	5.72	Peak	---																																																																	
5	11510.00	46.55	54.00	-7.45	32.00	14.55	Average	---																																																																	
6	11510.00	56.33	74.00	-17.67	41.78	14.55	Peak	---																																																																	
<p>Note 1: Emission Level (dBuV/m) = SA Reading (dBuV/m) + Factor* (dB)            *Factor includes antenna factor , cable loss and amplifier gain            Note 2: Margin (dB) = Emission level (dBuV/m) – Limit (dBuV/m).</p>																																																																									

<b>Modulation</b>	VHT40	<b>Test Freq. (MHz)</b>	5755
<b>Polarization</b>	Vertical		

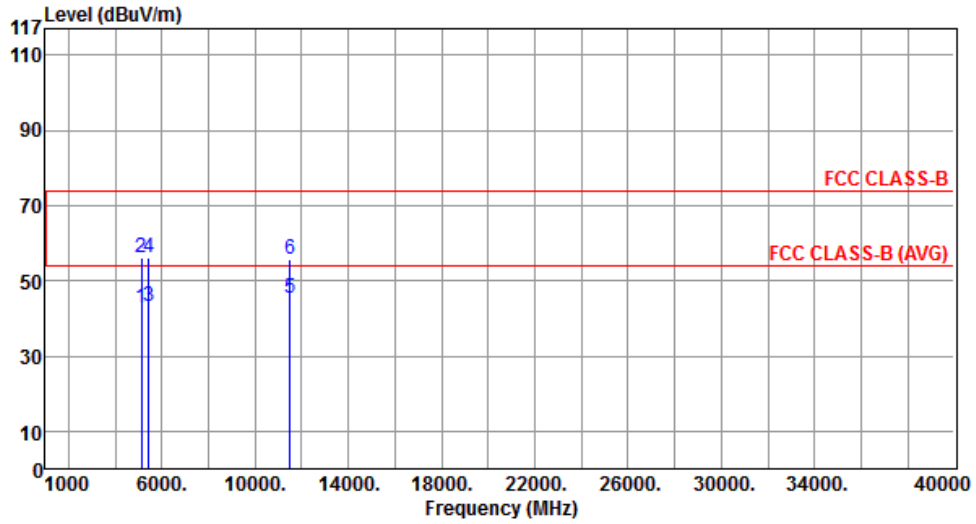

	Freq. MHz	Emission level dBuV/m	Limit dBuV/m	Margin dB	SA reading dBuV	Factor dB	Remark	ANT High cm	Turn Table deg
1	5140.00	42.53	54.00	-11.47	36.98	5.55	Average	---	---
2	5140.00	56.07	74.00	-17.93	50.52	5.55	Peak	---	---
3	5425.00	42.97	54.00	-11.03	37.25	5.72	Average	---	---
4	5425.00	56.04	74.00	-17.96	50.32	5.72	Peak	---	---
5	11510.00	45.31	54.00	-8.69	30.76	14.55	Average	---	---
6	11510.00	55.67	74.00	-18.33	41.12	14.55	Peak	---	---

Note 1: Emission Level (dBuV/m) = SA Reading (dBuV/m) + Factor\* (dB)

\*Factor includes antenna factor , cable loss and amplifier gain

Note 2: Margin (dB) = Emission level (dBuV/m) – Limit (dBuV/m).

<b>Modulation</b>	VHT40	<b>Test Freq. (MHz)</b>	5795
<b>Polarization</b>	Horizontal		

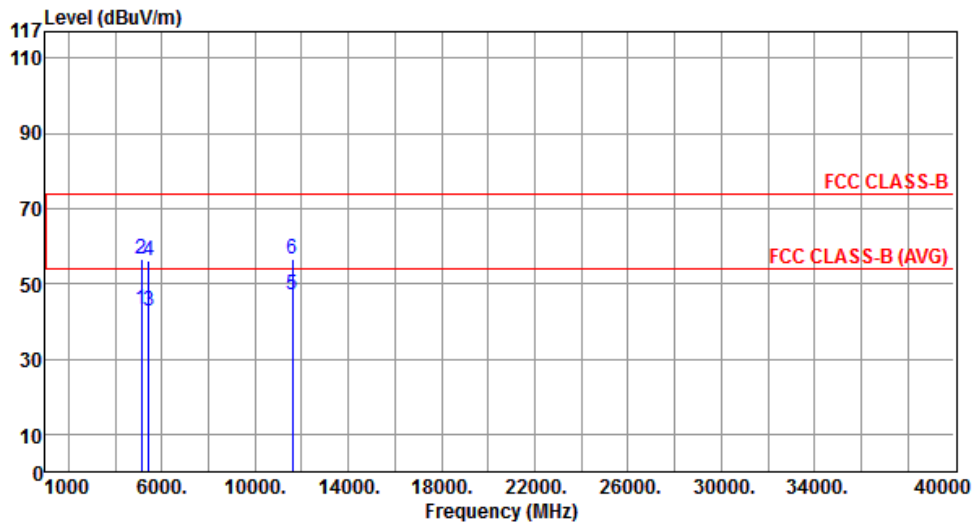

	Freq. MHz	Emission level dBuV/m	Limit dBuV/m	Margin dB	SA reading dBuV	Factor dB	Remark	ANT High cm	Turn Table deg
1	5140.00	43.07	54.00	-10.93	37.52	5.55	Average	---	---
2	5140.00	56.42	74.00	-17.58	50.87	5.55	Peak	---	---
3	5434.00	42.92	54.00	-11.08	37.22	5.70	Average	---	---
4	5434.00	56.26	74.00	-17.74	50.56	5.70	Peak	---	---
5	11590.00	47.11	54.00	-6.89	32.66	14.45	Average	---	---
6	11590.00	56.42	74.00	-17.58	41.97	14.45	Peak	---	---

Note 1: Emission Level (dBuV/m) = SA Reading (dBuV/m) + Factor\* (dB)

\*Factor includes antenna factor , cable loss and amplifier gain

Note 2: Margin (dB) = Emission level (dBuV/m) – Limit (dBuV/m).



<b>Modulation</b>	VHT40	<b>Test Freq. (MHz)</b>	5795
<b>Polarization</b>	Vertical		

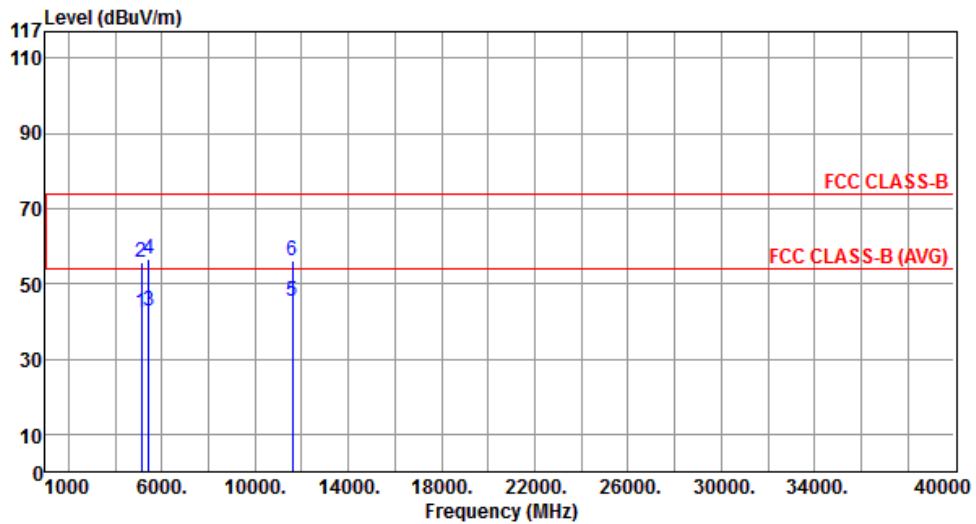

	Freq. MHz	Emission level dBuV/m	Limit dBuV/m	Margin dB	SA reading dBuV	Factor dB	Remark	ANT High cm	Turn Table deg
1	5140.00	42.40	54.00	-11.60	36.85	5.55	Average	---	---
2	5140.00	55.78	74.00	-18.22	50.23	5.55	Peak	---	---
3	5434.00	42.68	54.00	-11.32	36.98	5.70	Average	---	---
4	5434.00	56.44	74.00	-17.56	50.74	5.70	Peak	---	---
5	11590.00	45.14	54.00	-8.86	30.69	14.45	Average	---	---
6	11590.00	56.14	74.00	-17.86	41.69	14.45	Peak	---	---

Note 1: Emission Level (dBuV/m) = SA Reading (dBuV/m) + Factor\* (dB)

\*Factor includes antenna factor , cable loss and amplifier gain

Note 2: Margin (dB) = Emission level (dBuV/m) – Limit (dBuV/m).

### 3.5.8 Transmitter Radiated Unwanted Emissions (Above 1GHz) for VHT80

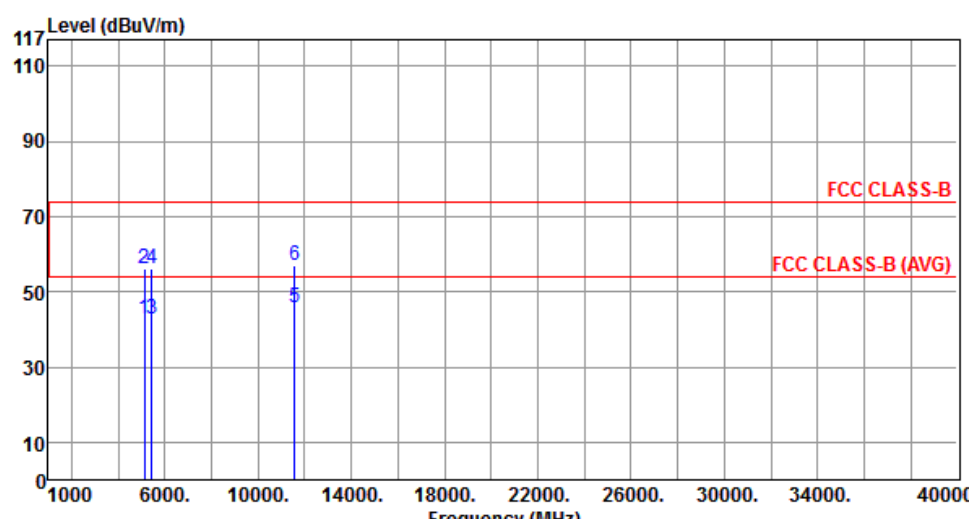
Modulation	VHT80	Test Freq. (MHz)	5775																																																																						
Polarization	Horizontal																																																																								
																																																																									
	<table border="1"> <thead> <tr> <th>Freq.</th> <th>Emission level</th> <th>Limit</th> <th>Margin</th> <th>SA reading</th> <th>Factor</th> <th>Remark</th> <th>ANT High</th> <th>Turn Table</th> </tr> <tr> <th>MHz</th> <th>dBuV/m</th> <th>dBuV/m</th> <th>dB</th> <th>dBuV</th> <th>dB</th> <th></th> <th>cm</th> <th>deg</th> </tr> </thead> <tbody> <tr> <td>1</td> <td>5140.00</td> <td>42.83</td> <td>54.00</td> <td>-11.17</td> <td>37.28</td> <td>5.55</td> <td>Average</td> <td>---</td> </tr> <tr> <td>2</td> <td>5140.00</td> <td>56.19</td> <td>74.00</td> <td>-17.81</td> <td>50.64</td> <td>5.55</td> <td>Peak</td> <td>---</td> </tr> <tr> <td>3</td> <td>5445.00</td> <td>42.58</td> <td>54.00</td> <td>-11.42</td> <td>36.89</td> <td>5.69</td> <td>Average</td> <td>---</td> </tr> <tr> <td>4</td> <td>5445.00</td> <td>56.15</td> <td>74.00</td> <td>-17.85</td> <td>50.46</td> <td>5.69</td> <td>Peak</td> <td>---</td> </tr> <tr> <td>5</td> <td>11550.00</td> <td>45.97</td> <td>54.00</td> <td>-8.03</td> <td>31.47</td> <td>14.50</td> <td>Average</td> <td>---</td> </tr> <tr> <td>6</td> <td>11550.00</td> <td>56.84</td> <td>74.00</td> <td>-17.16</td> <td>42.34</td> <td>14.50</td> <td>Peak</td> <td>---</td> </tr> </tbody> </table>	Freq.	Emission level	Limit	Margin	SA reading	Factor	Remark	ANT High	Turn Table	MHz	dBuV/m	dBuV/m	dB	dBuV	dB		cm	deg	1	5140.00	42.83	54.00	-11.17	37.28	5.55	Average	---	2	5140.00	56.19	74.00	-17.81	50.64	5.55	Peak	---	3	5445.00	42.58	54.00	-11.42	36.89	5.69	Average	---	4	5445.00	56.15	74.00	-17.85	50.46	5.69	Peak	---	5	11550.00	45.97	54.00	-8.03	31.47	14.50	Average	---	6	11550.00	56.84	74.00	-17.16	42.34	14.50	Peak	---
Freq.	Emission level	Limit	Margin	SA reading	Factor	Remark	ANT High	Turn Table																																																																	
MHz	dBuV/m	dBuV/m	dB	dBuV	dB		cm	deg																																																																	
1	5140.00	42.83	54.00	-11.17	37.28	5.55	Average	---																																																																	
2	5140.00	56.19	74.00	-17.81	50.64	5.55	Peak	---																																																																	
3	5445.00	42.58	54.00	-11.42	36.89	5.69	Average	---																																																																	
4	5445.00	56.15	74.00	-17.85	50.46	5.69	Peak	---																																																																	
5	11550.00	45.97	54.00	-8.03	31.47	14.50	Average	---																																																																	
6	11550.00	56.84	74.00	-17.16	42.34	14.50	Peak	---																																																																	
<p>Note 1: Emission Level (dBuV/m) = SA Reading (dBuV/m) + Factor* (dB)            *Factor includes antenna factor , cable loss and amplifier gain            Note 2: Margin (dB) = Emission level (dBuV/m) – Limit (dBuV/m).</p>																																																																									

<b>Modulation</b>	VHT80	<b>Test Freq. (MHz)</b>	5775
<b>Polarization</b>	Vertical		

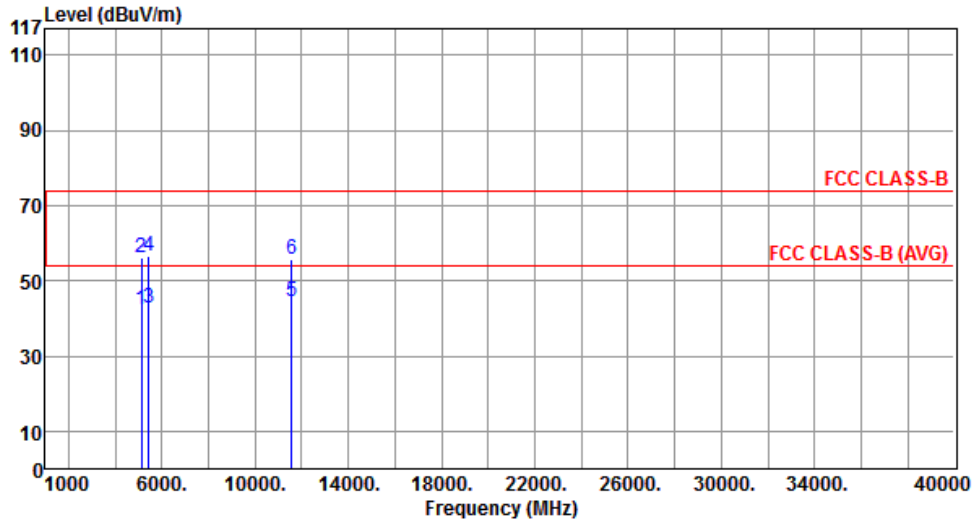

	Freq. MHz	Emission level dBuV/m	Limit dBuV/m	Margin dB	SA reading dBuV	Factor dB	Remark	ANT High cm	Turn Table deg
1	5140.00	42.27	54.00	-11.73	36.72	5.55	Average	---	---
2	5140.00	56.04	74.00	-17.96	50.49	5.55	Peak	---	---
3	5445.00	42.70	54.00	-11.30	37.01	5.69	Average	---	---
4	5445.00	56.61	74.00	-17.39	50.92	5.69	Peak	---	---
5	11550.00	44.58	54.00	-9.42	30.08	14.50	Average	---	---
6	11550.00	55.74	74.00	-18.26	41.24	14.50	Peak	---	---

Note 1: Emission Level (dBuV/m) = SA Reading (dBuV/m) + Factor\* (dB)

\*Factor includes antenna factor , cable loss and amplifier gain

Note 2: Margin (dB) = Emission level (dBuV/m) – Limit (dBuV/m).

## 3.6 Unwanted Emissions into Non-Restricted Frequency Bands

### 3.6.1 Limit of Unwanted Emissions into Non-Restricted Frequency Bands

The peak output power measured in any 100 kHz bandwidth outside of the authorized frequency band shall be attenuated by at least 20 dB relative to the maximum in-band peak PSD level in 100 kHz.

### 3.6.2 Test Procedures

#### Reference Level Measurement

1. Set the RBW = 100 kHz, VBW = 300 kHz, Detector = peak.
2. Set Sweep time = auto couple, Trace mode = max hold.
3. Allow trace to fully stabilize.
4. Use the peak marker function to determine the maximum amplitude level.

#### Unwanted Emissions Level Measurement

1. Set RBW = 100 kHz, VBW = 300 kHz, Detector = peak.
2. Trace Mode = max hold, Sweep = auto couple.
3. Allow the trace to stabilize.
4. Use peak marker function to determine maximum amplitude of all unwanted emissions within any 100 kHz bandwidth.

### 3.6.3 Test Setup

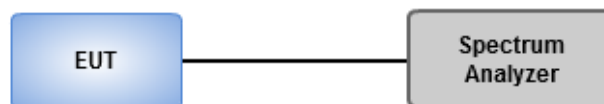

### 3.6.4 Unwanted Emissions into Non-Restricted Frequency Bands

802.11a

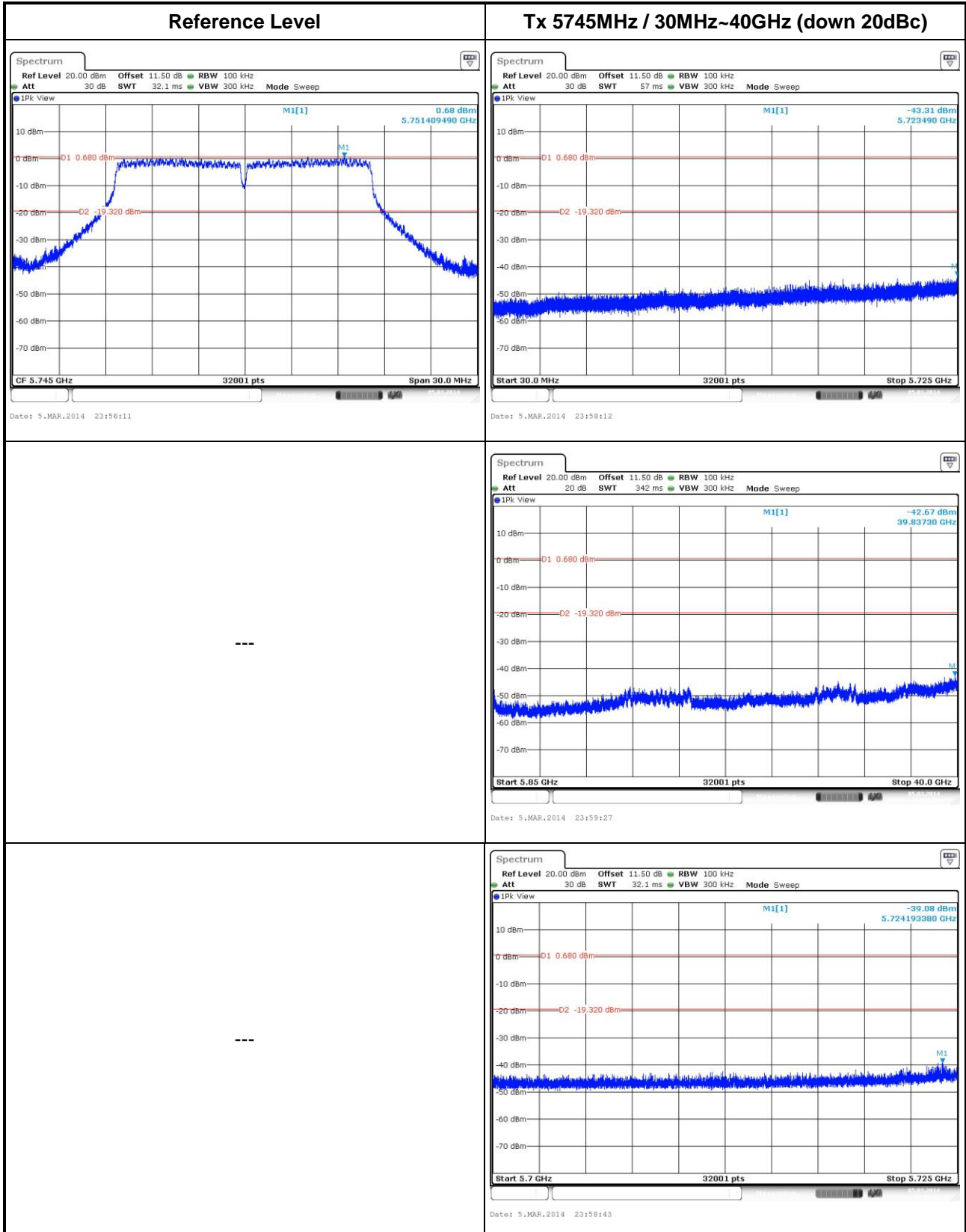

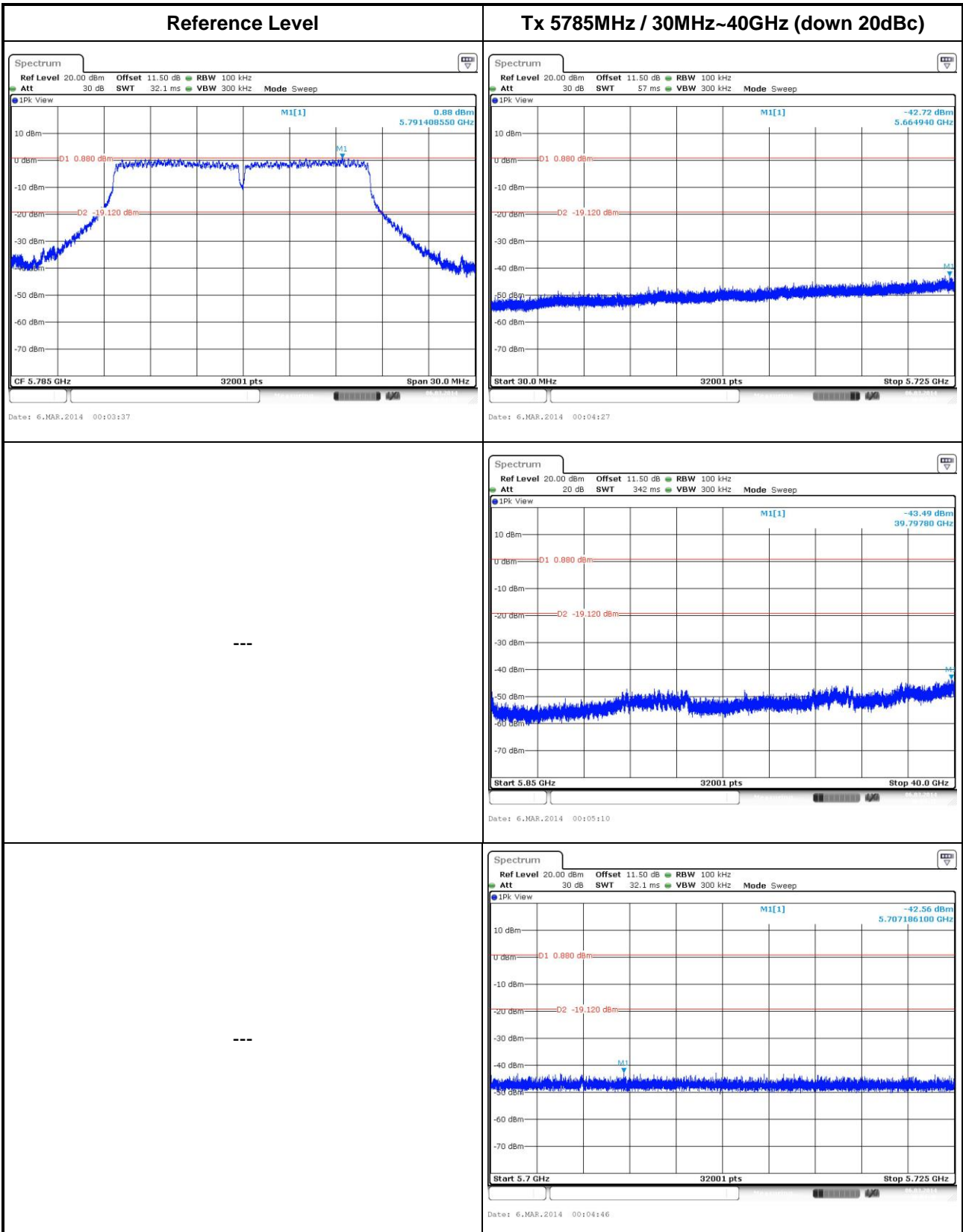

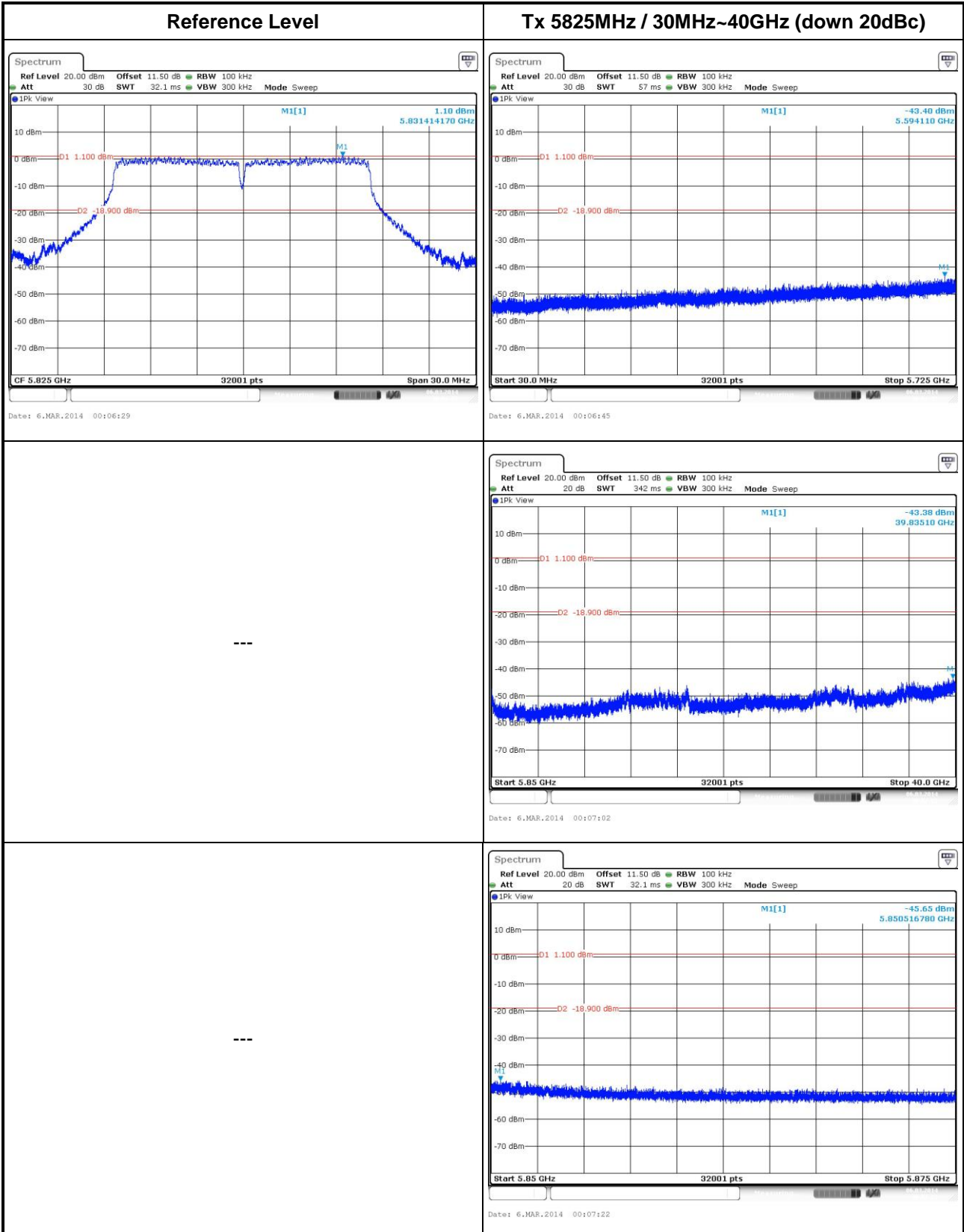

802.11n VHT20

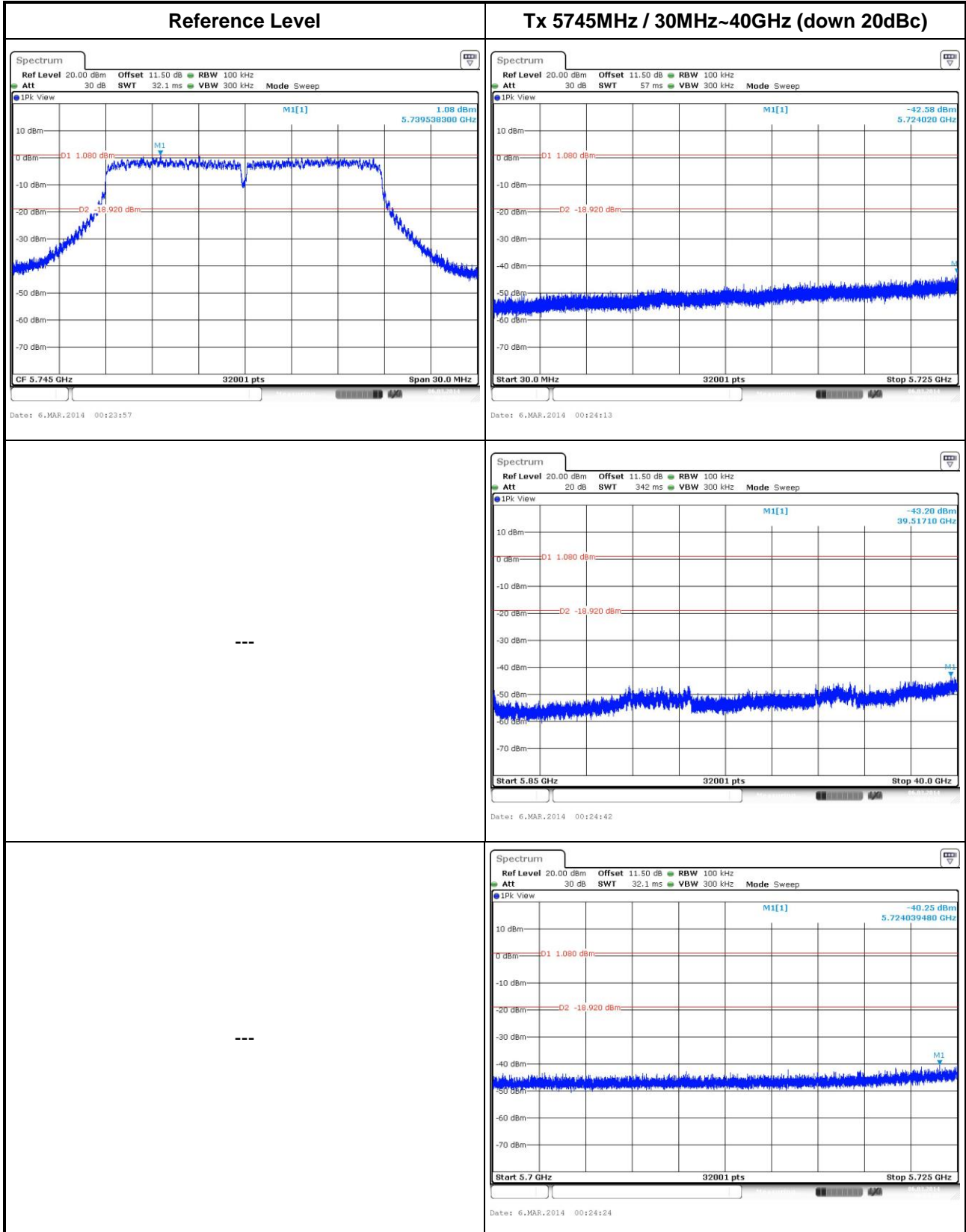



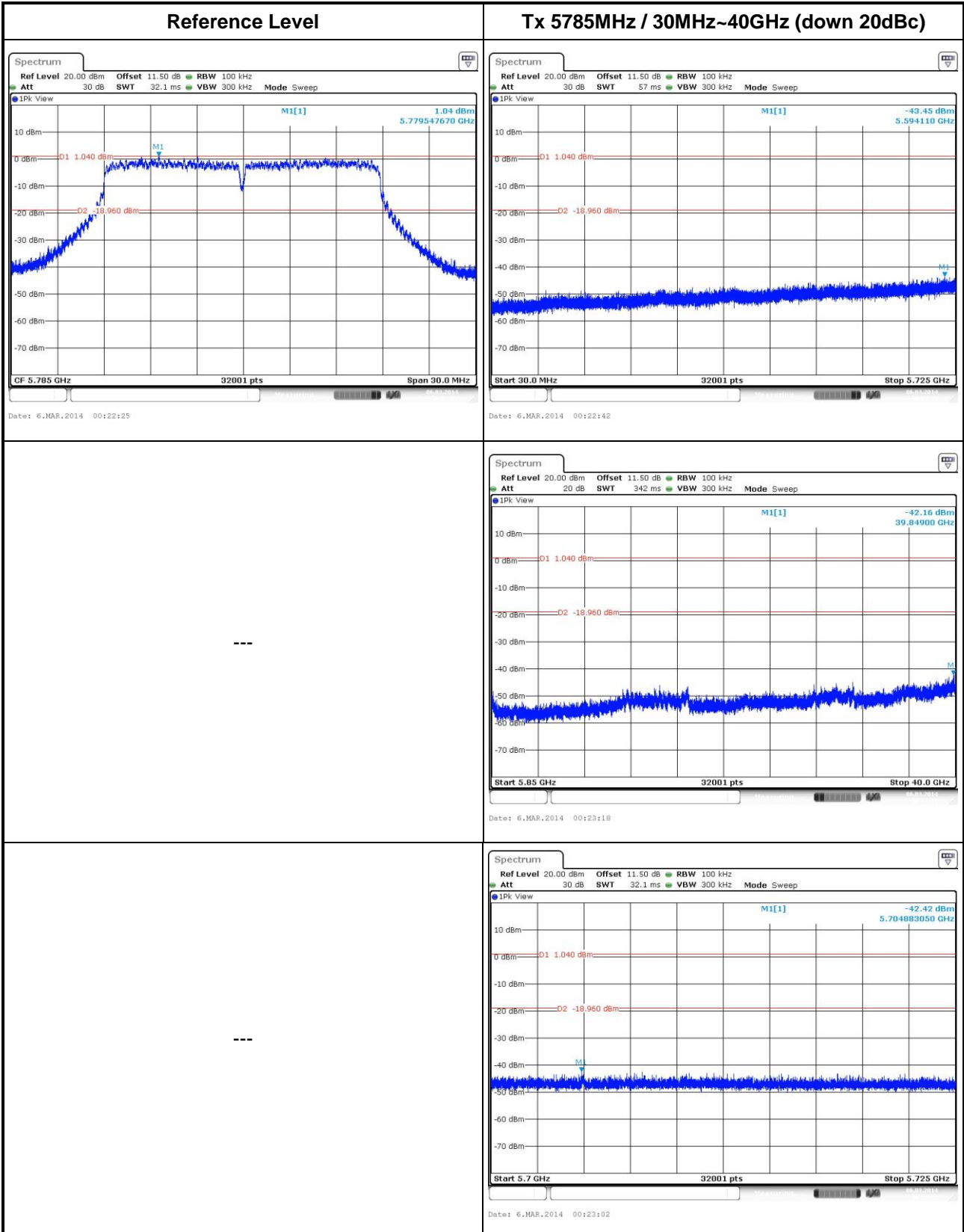

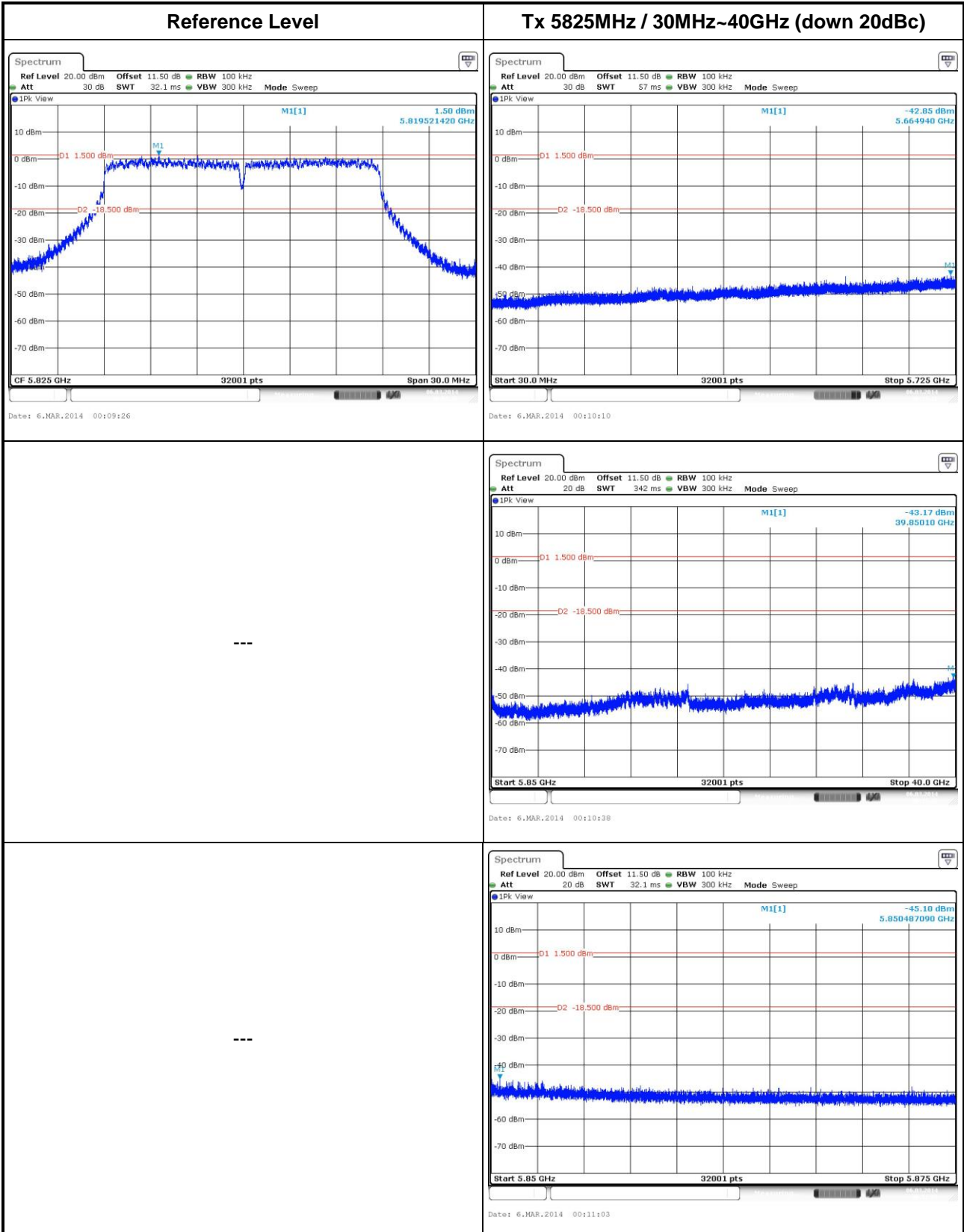

802.11n VHT40

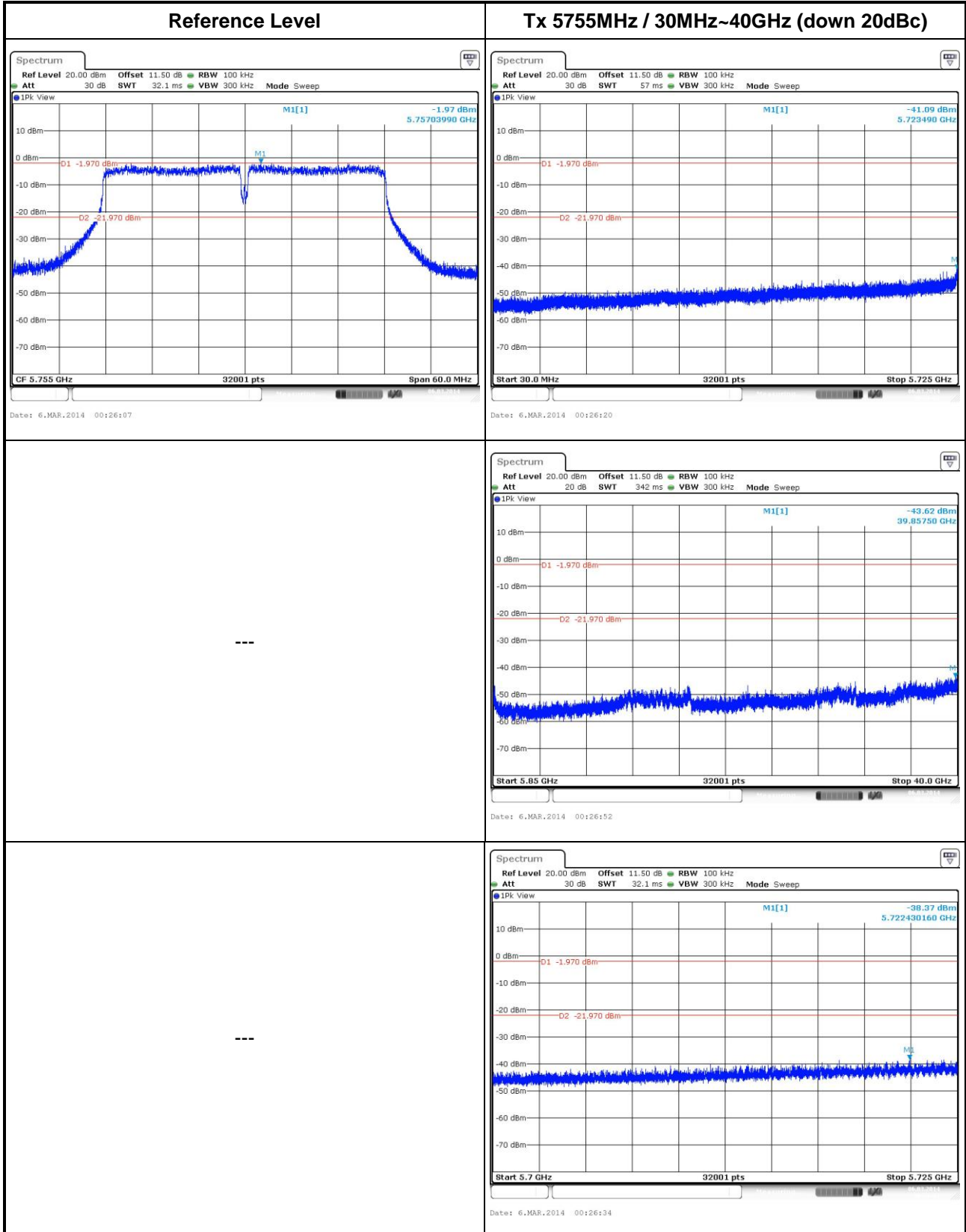

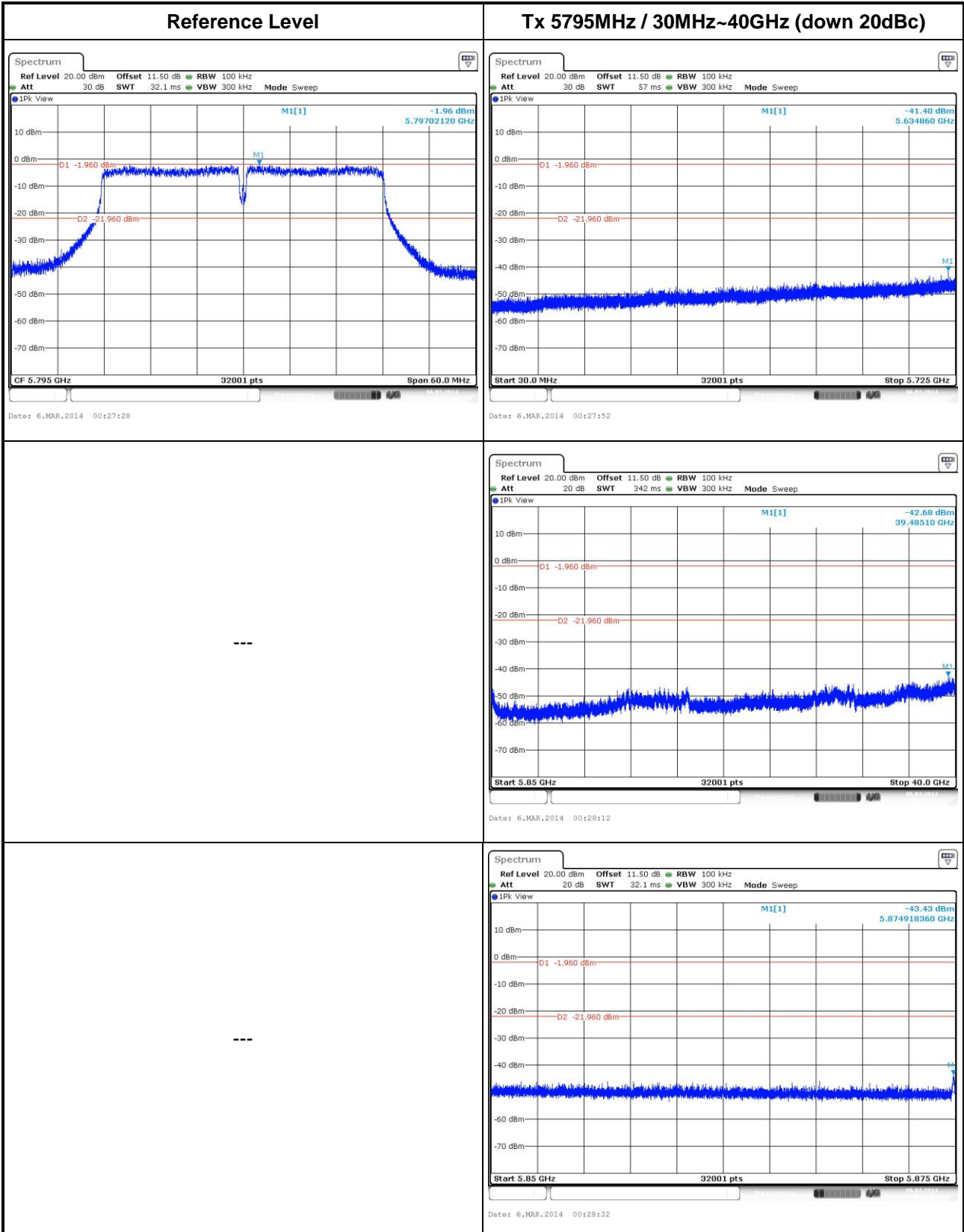

802.11n VHT80

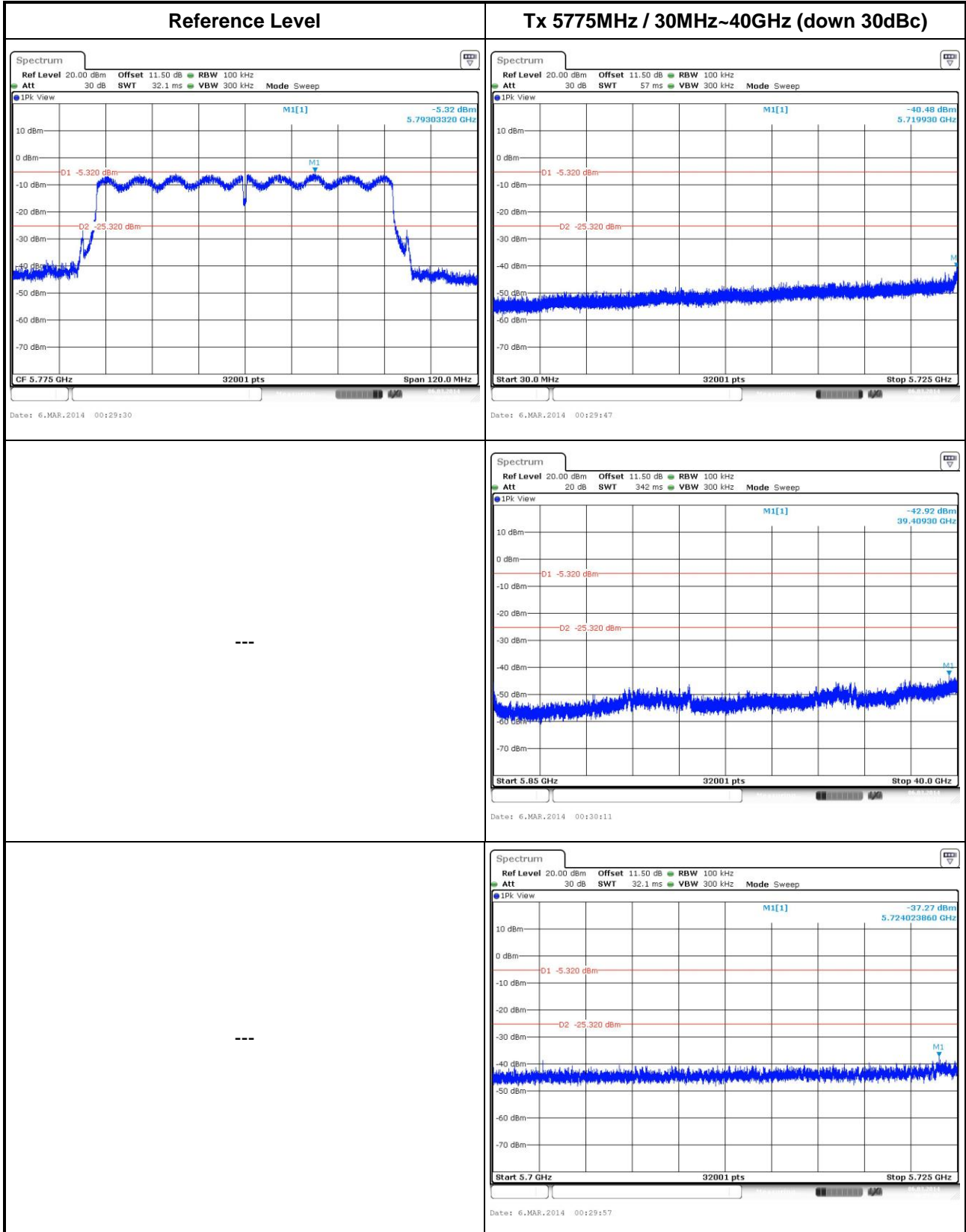

## 4 Test laboratory information

Established in 2012, ICC provides foremost EMC & RF Testing and advisory consultation services by our skilled engineers and technicians. Our services employ a wide variety of advanced edge test equipment and one of the widest certification extents in the business.

International Certification Corp, it is our definitive objective is to institute long term, trust-based associations with our clients. The expectation we set up with our clients is based on outstanding service, practical expertise and devotion to a certified value structure. Our passion is to grant our clients with best EMC / RF services by oriented knowledgeable and accommodating staff.

Our Test sites are located at Linkou District and Kwei Shan Hsiang. Location map can be found on our website <http://www.icertifi.com.tw>.

### **Linkou**

Tel: 886-2-2601-1640

No. 30-2, Ding Fwu Tsuen, Lin Kou District, New Taipei City, Taiwan, R.O.C.

### **Kwei Shan**

Tel: 886-3-271-8666

No. 3-1, Lane 6, Wen San 3rd St., Kwei Shan Hsiang, Tao Yuan Hsien 333, Taiwan, R.O.C.

If you have any suggestion, please feel free to contact us as below information

Tel: 886-3-271-8666

Fax: 886-3-318-0155

Email: ICC\_Service@icertifi.com.tw

==END==