



SPORTON International Inc.

No. 52, Hwa Ya 1st Rd., Hwa Ya Technology Park, Kwei-Shan Hsiang, Tao Yuan Hsien, Taiwan, R.O.C.
Ph: 886-3-327-3456 / FAX: 886-3-327-0973 / www.sporton.com.tw

FCC RADIO TEST REPORT

Applicant's company	Buffalo Inc.
Applicant Address	AKAMONDORI Bldg., 30-20, Ohsu 3-chome, Naka-ku, Nagoya 460-8315 Japan
FCC ID	FDI000000022
Manufacturer's company	Buffalo Inc.
Manufacturer Address	AKAMONDORI Bldg., 30-20, Ohsu 3-chome, Naka-ku, Nagoya 460-8315 Japan

Product Name	AirStation
Brand Name	Buffalo Inc.
Model No.	WXR-1900DHP, WXR-1900DHPD
Test Rule	47 CFR FCC Part 15 Subpart C § 15.247
Test Freq. Range	2400 ~ 2483.5MHz
Received Date	Aug. 15, 2014
Final Test Date	Jul. 05, 2016
Submission Type	Class II Change

Statement

Test result included in this report is for the IEEE 802.11n and IEEE 802.11b/g of the product.

The test result in this report refers exclusively to the presented test model / sample.

Without written approval of SPORTON International Inc., the test report shall not be reproduced except in full.

The measurements and test results shown in this test report were made in accordance with the procedures and found in compliance with the limit given in ANSI C63.10-2013, 47 CFR FCC Part 15 Subpart C, KDB558074 D01 v03r05 and KDB 662911 D01 v02r01.

The test equipment used to perform the test is calibrated and traceable to NML/ROC.



Table of Contents

1. VERIFICATION OF COMPLIANCE	1
2. SUMMARY OF THE TEST RESULT	2
3. GENERAL INFORMATION	3
3.1. Product Details.....	3
3.2. Accessories.....	4
3.3. Table for Filed Antenna.....	4
3.4. Table for Carrier Frequencies	5
3.5. Table for Test Modes.....	6
3.6. Table for Testing Locations.....	6
3.7. Table for Class II Change	7
3.8. Table for Multiple Listing.....	7
3.9. Table for Supporting Units	7
3.10. Test Configurations	8
4. TEST RESULT	10
4.1. AC Power Line Conducted Emissions Measurement.....	10
4.2. Radiated Emissions Measurement	14
4.3. Antenna Requirements	20
5. LIST OF MEASURING EQUIPMENTS	21
6. MEASUREMENT UNCERTAINTY	22
APPENDIX A. PHOTOGRAPHS OF EUT	A1 ~ A18
APPENDIX B. TEST PHOTOS	B1 ~ B3



History of This Test Report

REPORT NO.	VERSION	DESCRIPTION	ISSUED DATE
FR481508-08AA	Rev. 01	Initial issue of report	Aug. 01, 2016

1. VERIFICATION OF COMPLIANCE

Product Name : AirStation
Brand Name : Buffalo Inc.
Model No. : WXR-1900DHP, WXR-1900DHPD
Applicant : Buffalo Inc.
Test Rule Part(s) : 47 CFR FCC Part 15 Subpart C § 15.247

Sporton International as requested by the applicant to evaluate the EMC performance of the product sample received on Aug. 15, 2014 would like to declare that the tested sample has been evaluated and found to be in compliance with the tested rule parts. The data recorded as well as the test configuration specified is true and accurate for showing the sample's EMC nature.

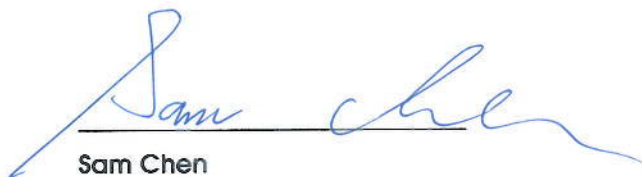

Sam Chen

SPORTON INTERNATIONAL INC.

2. SUMMARY OF THE TEST RESULT

Applied Standard: 47 CFR FCC Part 15 Subpart C			
Part	Rule Section	Description of Test	Result
4.1	15.207	AC Power Line Conducted Emissions	Complies
4.2	15.247(d)	Radiated Emissions	Complies
4.3	15.203	Antenna Requirements	Complies

3. GENERAL INFORMATION

3.1. Product Details

Items	Description
Product Type	WLAN (3TX, 3RX)
Radio Type	Intentional Transceiver
Power Type	From power adapter
Modulation	IEEE 802.11b: DSSS IEEE 802.11g: OFDM IEEE 802.11n: see the below table
Data Modulation	IEEE 802.11b: DSSS (BPSK / QPSK / CCK) IEEE 802.11g/n: OFDM (BPSK / QPSK / 16QAM / 64QAM)
Data Rate (Mbps)	IEEE 802.11b: DSSS (1/ 2/ 5.5/11) IEEE 802.11g: OFDM (6/9/12/18/24/36/48/54) IEEE 802.11n: see the below table
Frequency Range	2400 ~ 2483.5MHz
Channel Number	11 for 20MHz bandwidth ; 7 for 40MHz bandwidth
Carrier Frequencies	Please refer to section 3.4
Antenna	Please refer to section 3.3

Items	Description
Beamforming Function	<input checked="" type="checkbox"/> With beamforming for 802.11n/ac in 5GHz <input type="checkbox"/> Without beamforming

Antenna and Band width

Antenna	Three (TX)	
Band width Mode	20 MHz	40 MHz
IEEE 802.11b	V	X
IEEE 802.11g	V	X
IEEE 802.11n	V	V

IEEE 11n Spec.

Protocol	Number of Transmit Chains (NTX)	Data Rate / MCS
802.11n (HT20)	3	MCS 0-23
802.11n (HT40)	3	MCS 0-23
Note 1: IEEE Std. 802.11n modulation consists of HT20 and HT40 (HT: High Throughput). Then EUT supports HT20 and HT40. Note 2: Modulation modes consist of below configuration: HT20/HT40: IEEE 802.11n		

3.2. Accessories

Power	Brand	Model	Rating
Adapter	APD	WA-36A12U	Input: 100-240V ~ 50-60Hz 0.9A Max Output: 12V, 3A
Other			
Cradle*1			

3.3. Table for Filed Antenna

Ant.	Brand	Model Name	Antenna Type	Connector	Gain (dBi)	
					2.4GHz	5GHz
1	M.gear	C600-510026-A	Dipole Antenna	Reversed-SMA	2	3
2	M.gear	C600-510026-A	Dipole Antenna	Reversed-SMA	2	3
3	M.gear	C600-510026-A	Dipole Antenna	Reversed-SMA	2	3

Note1: The EUT has three antennas.

For 2.4GHz function:

For IEEE 802.11 b/g/n mode (3TX/3RX):

Chain 1, Chain 2 and Chain 3 will transmit/receive the same signal simultaneously.

Chain 1, Chain 2 and Chain 3 can be used as transmitting/receiving antennas.

For 5GHz function:

For IEEE 802.11 a/n/ac mode (3TX, 3RX):

Chain 1, Chain 2 and Chain 3 will transmit/receive the same signal simultaneously.

Chain 1, Chain 2 and Chain 3 can be used as transmitting/receiving antennas.

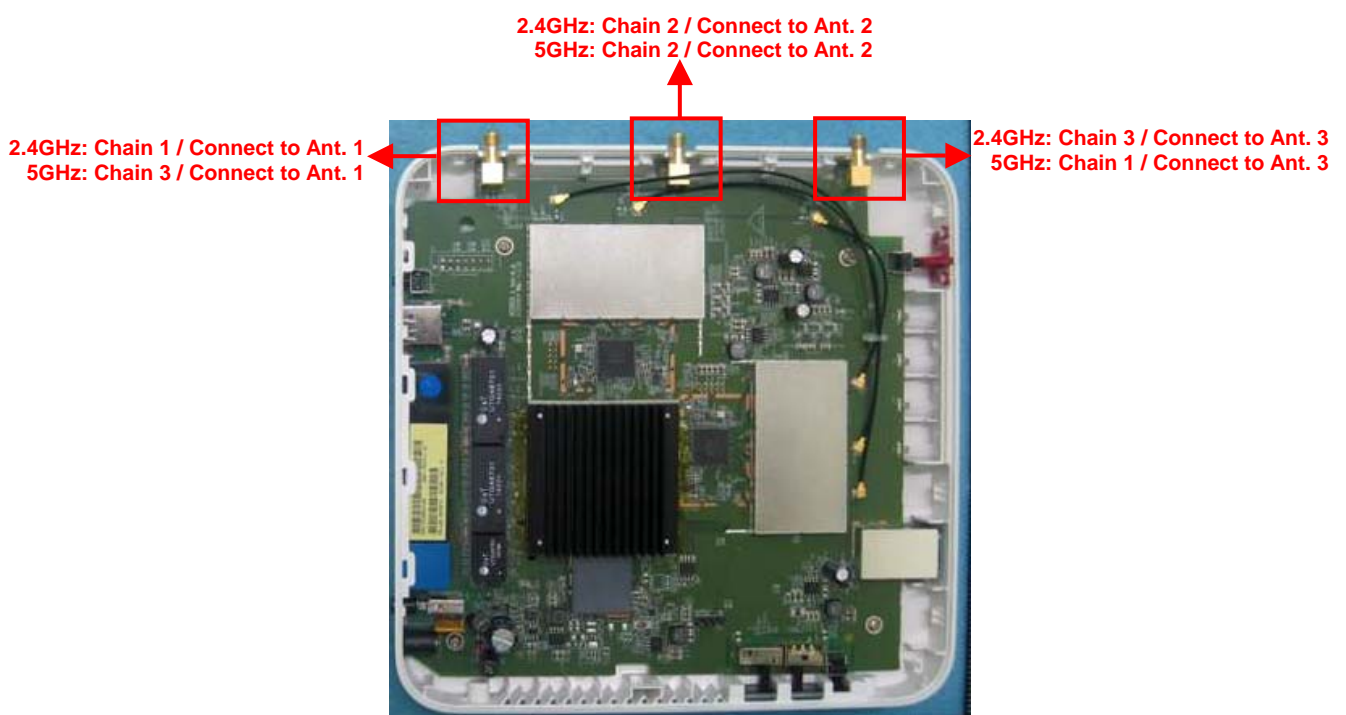

3.4. Table for Carrier Frequencies

There are two bandwidth systems.

For 20MHz bandwidth systems, use Channel 1~Channel 11.

For 40MHz bandwidth systems, use Channel 3~Channel 9.

Frequency Band	Channel No.	Frequency	Channel No.	Frequency
2400~2483.5MHz	1	2412 MHz	7	2442 MHz
	2	2417 MHz	8	2447 MHz
	3	2422 MHz	9	2452 MHz
	4	2427 MHz	10	2457 MHz
	5	2432 MHz	11	2462 MHz
	6	2437 MHz	-	-

3.5. Table for Test Modes

Preliminary tests were performed in different data rate to find the worst radiated emission. The data rate shown in the table below is the worst-case rate with respect to the specific test item. Investigation has been done on all the possible configurations for searching the worst cases. The following table is a list of the test modes shown in this test report.

Test Items	Mode	Data Rate	Channel	Chain
AC Power Line Conducted Emissions	Normal Link	-	-	-
Radiated Emissions 9kHz~1GHz	Normal Link	-	-	-

Note 1: The EUT can only be used at Y axis position.

The following test modes were performed for all tests:

For Conducted Emission test:

Mode 1: Normal Link - Client mode + 2.4GHz function

Mode 2: Normal Link - Client mode + 5GHz function

Mode 1 generated the worst test result, so it was recorded in this report.

For Radiated Emission test<Below 1GHz>:

Mode 1: Normal Link - Client mode + 2.4GHz function

Mode 2: Normal Link - Client mode + 5GHz function

Mode 2 generated the worst test result, so it was recorded in this report.

3.6. Table for Testing Locations

Test Site Location				
Address:	No.8, Lane 724, Bo-ai St., Jhubei City, Hsinchu County 302, Taiwan, R.O.C.			
TEL:	886-3-656-9065			
FAX:	886-3-656-9085			
Test Site No.	Site Category	Location	FCC Designation No.	IC File No.
03CH01-CB	SAC	Hsin Chu	TW0006	IC 4086D
CO01-CB	Conduction	Hsin Chu	TW0006	IC 4086D

Open Area Test Site (OATS); Semi Anechoic Chamber (SAC).

3.7. Table for Class II Change

This product is an extension of original one reported under Sporton project number: FR481508-07

Below is the table for the change of the product with respect to the original one.

Modifications	Performance Checking
1. Adding client mode and updating 5GHz band 1. 2. Adding model name: WXR-1900DHPD.	It's not necessary to re-test.
1. Adding an adapter (model name: WA-36A12FU)	1. AC Power Line Conducted Emissions 2. Radiated Emissions (Below 1GHz)

Note: The other rest test results were based on original test report.

3.8. Table for Multiple Listing

The EUT has two model names which are identical to each other in all aspects except for the following table:

Model Name	Description
WXR-1900DHP	The different model names served as marketing strategy.
WXR-1900DHPD	

Note: From the above models, model: WXR-1900DHP was selected as representative model for the test and its data was recorded in this report.

3.9. Table for Supporting Units

For Test Site No: 03CH01-CB

Support Unit	Brand	Model	FCC ID
NB*2	DELL	E4300	DoC
Flash disk	Silicon Power	Touch 835	DoC
Flash disk3.0	Silicon Power	B06	DoC
WLAN AP	D-LINK	DIR860L	KA2IR860LA1

For Test Site No: CO01-CB

Support Unit	Brand	Model	FCC ID
NB*2	DELL	E6430	DoC
AP Router	Planex	GW-AP54SGX	KA220030603014-1
Flash disk3.0	ADATA	C103	DoC
Flash disk	Silicon power	I-Series	DoC

3.10. Test Configurations

3.10.1. AC Power Line Conduction Emissions Test Configuration

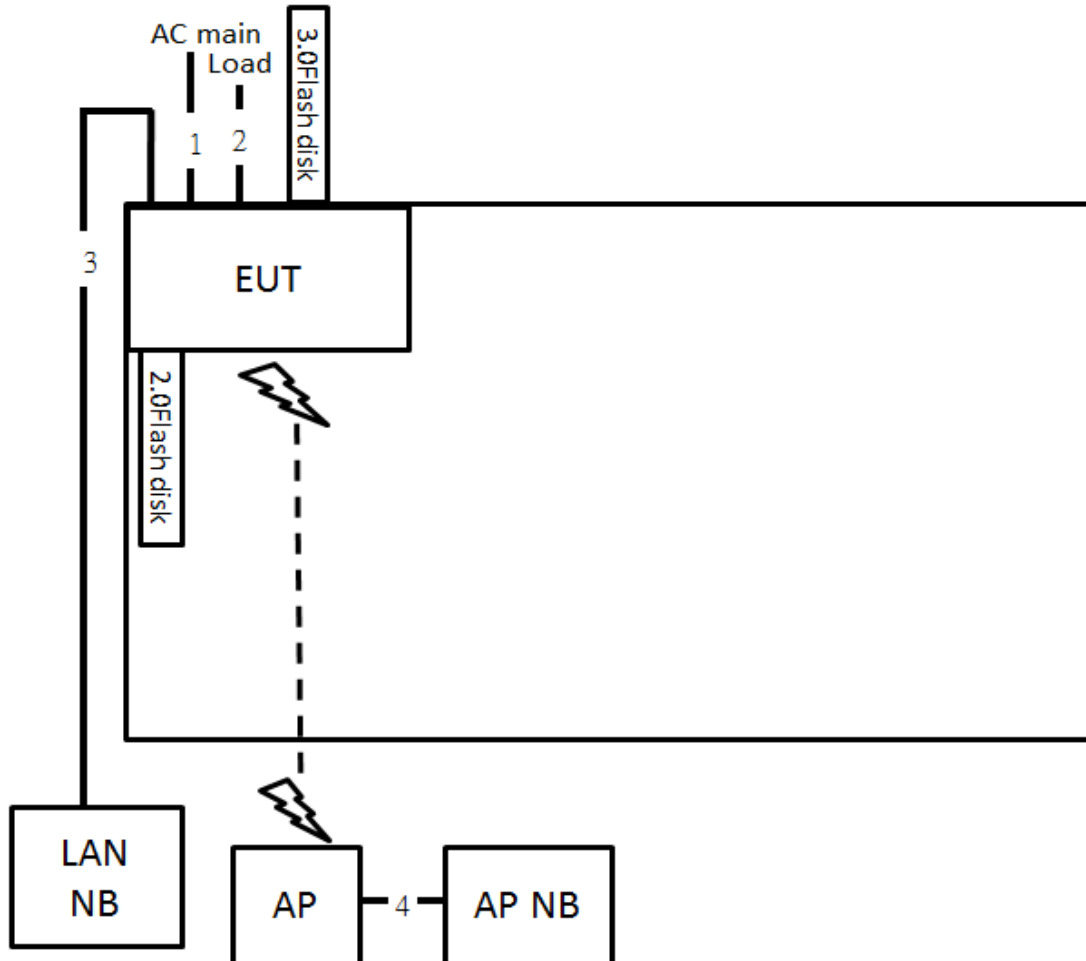

Item	Connection	Shielded	Length
1	Power cable	No	1.5m
2	RJ-45 cable*4	No	1.5m
3	RJ-45 cable	No	10m
4	RJ-45 cable	No	1.5m

3.10.2. Radiation Emissions Test Configuration

Test Configuration: 30MHz ~1GHz

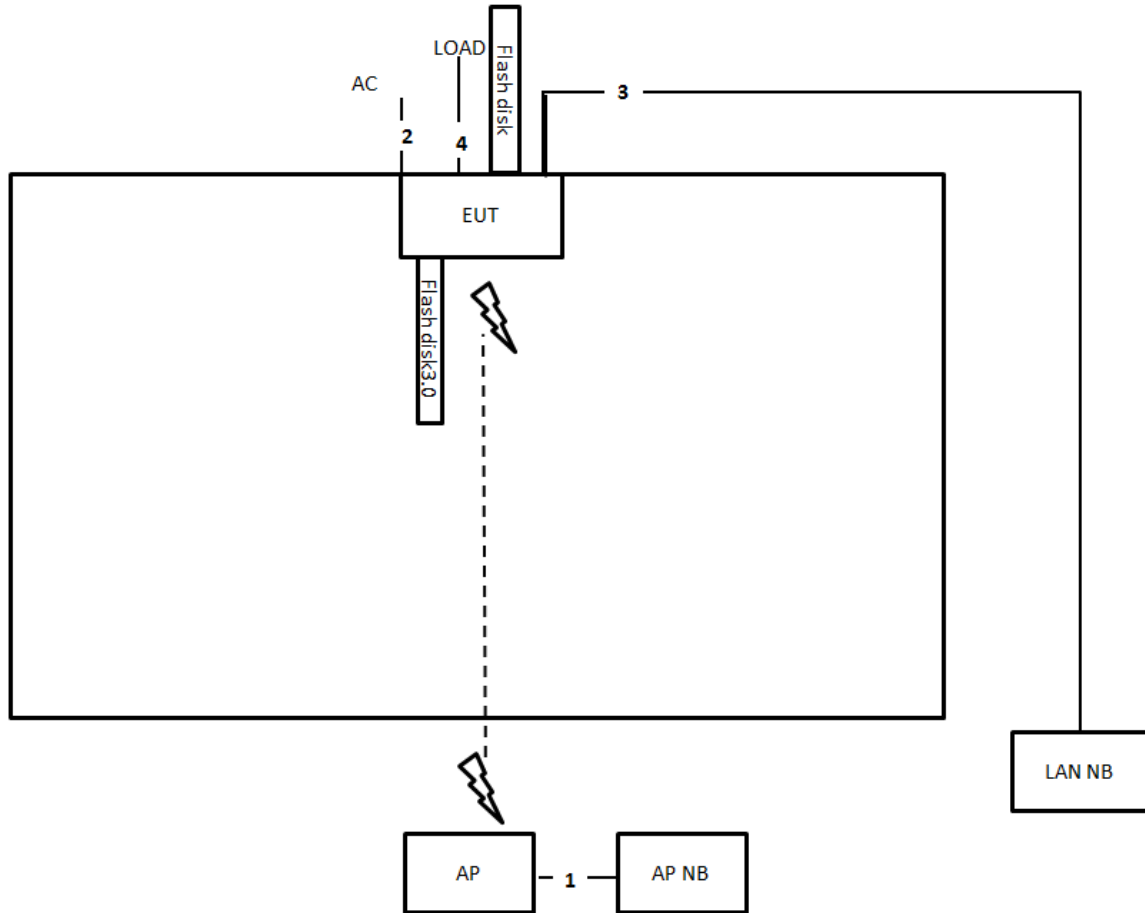

Item	Connection	Shielded	Length
1	RJ-45 cable	No	1.5m
2	Power cable	No	1.5m
3	RJ-45 cable	No	10m
4	RJ-45 cable*4	No	1.5m

4. TEST RESULT

4.1. AC Power Line Conducted Emissions Measurement

4.1.1. Limit

For this product which is designed to be connected to the AC power line, the radio frequency voltage that is conducted back onto the AC power line on any frequency or frequencies within the band 150 kHz to 30 MHz shall not exceed below limits table.

Frequency (MHz)	QP Limit (dBuV)	AV Limit (dBuV)
0.15~0.5	66~56	56~46
0.5~5	56	46
5~30	60	50

4.1.2. Measuring Instruments and Setting

Please refer to section 5 of equipments list in this report. The following table is the setting of the receiver.

Receiver Parameters	Setting
Attenuation	10 dB
Start Frequency	0.15 MHz
Stop Frequency	30 MHz
IF Bandwidth	9 kHz

4.1.3. Test Procedures

1. Configure the EUT according to ANSI C63.10. The EUT or host of EUT has to be placed 0.4 meter far from the conducting wall of the shielding room and at least 80 centimeters from any other grounded conducting surface.
2. Connect EUT or host of EUT to the power mains through a line impedance stabilization network (LISN).
3. All the support units are connected to the other LISNs. The LISN should provide 50uH/50ohms coupling impedance.
4. The frequency range from 150 kHz to 30 MHz was searched.
5. Set the test-receiver system to Peak Detect Function and Specified Bandwidth with Maximum Hold Mode.
6. The measurement has to be done between each power line and ground at the power terminal.

4.1.7. Results of AC Power Line Conducted Emissions Measurement

Temperature	22°C	Humidity	63%
Test Engineer	GN Hou	Phase	Line
Configuration	Normal Link	Test Mode	Mode 1

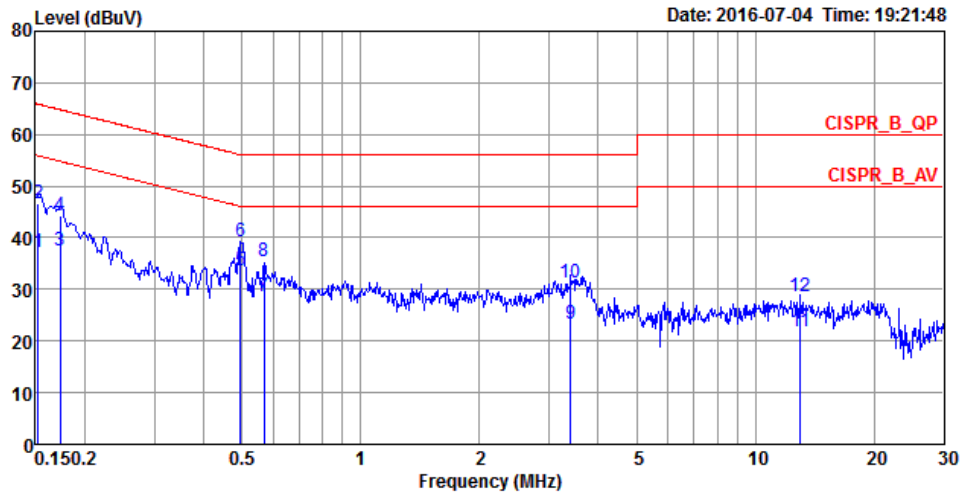

	Freq	Level	Over Limit	Limit Line	Read Level	LISN Factor	Cable Loss	Pol/Phase	Remark
	MHz	dBuV	dB	dBuV	dBuV	dB	dB		
1	0.1524	37.15	-18.72	55.87	26.97	10.02	0.16	LINE	Average
2	0.1524	46.54	-19.33	65.87	36.36	10.02	0.16	LINE	QP
3	0.1731	37.38	-17.43	54.81	27.18	10.02	0.18	LINE	Average
4	0.1731	44.29	-20.52	64.81	34.09	10.02	0.18	LINE	QP
5	0.4967	33.70	-12.35	46.05	23.60	9.92	0.18	LINE	Average
6	0.4967	39.20	-16.85	56.05	29.10	9.92	0.18	LINE	QP
7	0.5701	28.62	-17.38	46.00	18.40	9.93	0.29	LINE	Average
8	0.5701	35.32	-20.68	56.00	25.10	9.93	0.29	LINE	QP
9	3.3994	23.27	-22.73	46.00	13.21	9.98	0.08	LINE	Average
10	3.3994	31.32	-24.68	56.00	21.26	9.98	0.08	LINE	QP
11	12.9885	21.89	-28.11	50.00	11.50	10.20	0.19	LINE	Average
12	12.9885	28.55	-31.45	60.00	18.16	10.20	0.19	LINE	QP

Temperature	22°C	Humidity	63%
Test Engineer	GN Hou	Phase	Neutral
Configuration	Normal Link	Test Mode	Mode 1

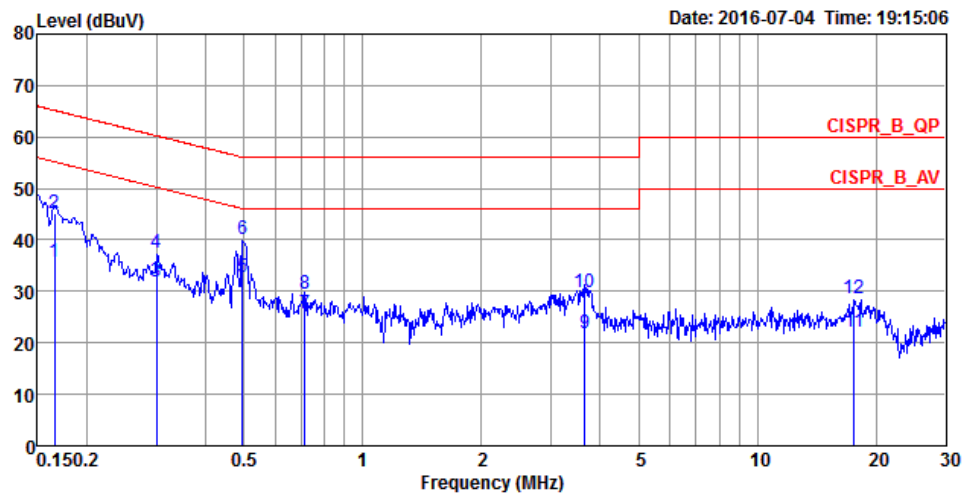

	Freq	Level	Over Limit	Limit Line	Read Level	LISN Factor	Cable Loss	Pol/Phase	Remark
	MHz	dBuV	dB	dBuV	dBuV	dB	dB		
1	0.1659	35.85	-19.31	55.16	25.66	10.02	0.17	NEUTRAL	Average
2	0.1659	45.04	-20.12	65.16	34.85	10.02	0.17	NEUTRAL	QP
3	0.3003	31.92	-18.32	50.24	21.91	9.92	0.09	NEUTRAL	Average
4	0.3003	37.43	-22.81	60.24	27.42	9.92	0.09	NEUTRAL	QP
5	0.4967	32.79	-13.26	46.05	22.69	9.92	0.18	NEUTRAL	Average
6	0.4967	40.01	-16.04	56.05	29.91	9.92	0.18	NEUTRAL	QP
7	0.7122	25.77	-20.23	46.00	15.37	9.93	0.47	NEUTRAL	Average
8	0.7122	29.49	-26.51	56.00	19.09	9.93	0.47	NEUTRAL	QP
9	3.6611	21.80	-24.20	46.00	11.72	9.99	0.09	NEUTRAL	Average
10	3.6611	29.68	-26.32	56.00	19.60	9.99	0.09	NEUTRAL	QP
11	17.5678	22.08	-27.92	50.00	11.58	10.27	0.23	NEUTRAL	Average
12	17.5678	28.67	-31.33	60.00	18.17	10.27	0.23	NEUTRAL	QP

Note:

Level = Read Level + LISN Factor + Cable Loss.

4.2. Radiated Emissions Measurement

4.2.1. Limit

30dBc in any 100 kHz bandwidth outside the operating frequency band. In case the emission fall within the restricted band specified on 15.205(a), then the 15.209(a) limit in the table below has to be followed.

Frequencies (MHz)	Field Strength (micorvolts/meter)	Measurement Distance (meters)
0.009~0.490	2400/F(kHz)	300
0.490~1.705	24000/F(kHz)	30
1.705~30.0	30	30
30~88	100	3
88~216	150	3
216~960	200	3
Above 960	500	3

4.2.2. Measuring Instruments and Setting

Please refer to section 5 of equipments list in this report. The following table is the setting of spectrum analyzer and receiver.

Spectrum Parameter	Setting
Attenuation	Auto
Start Frequency	1000 MHz
Stop Frequency	10th carrier harmonic
RBW / VBW (Emission in restricted band)	1MHz / 3MHz for Peak, 1MHz / 1/T for Average
RBW / VBW (Emission in non-restricted band)	100kHz / 300kHz for peak

Receiver Parameter	Setting
Attenuation	Auto
Start ~ Stop Frequency	9kHz~150kHz / RBW 200Hz for QP
Start ~ Stop Frequency	150kHz~30MHz / RBW 9kHz for QP
Start ~ Stop Frequency	30MHz~1000MHz / RBW 120kHz for QP

4.2.3. Test Procedures

1. Configure the EUT according to ANSI C63.10. The EUT was placed on the top of the turntable 1.5 meter above ground. The phase center of the receiving antenna mounted on the top of a height-variable antenna tower was placed 1m & 3m far away from the turntable.
2. Power on the EUT and all the supporting units. The turntable was rotated by 360 degrees to determine the position of the highest radiation.
3. The height of the broadband receiving antenna was varied between one meter and four meters above ground to find the maximum emissions field strength of both horizontal and vertical polarization.
4. For each suspected emissions, the antenna tower was scan (from 1 m to 4 m) and then the turntable was rotated (from 0 degree to 360 degrees) to find the maximum reading.
5. Set the test-receiver system to Peak or CISPR quasi-peak Detect Function with specified bandwidth under Maximum Hold Mode.
6. For emissions above 1GHz, use 1MHz VBW and 3MHz RBW for peak reading. Then 1MHz RBW and 1/T VBW for average reading in spectrum analyzer.
7. If the emissions level of the EUT in peak mode was 3 dB lower than the average limit specified, then testing will be stopped and peak values of EUT will be reported, otherwise, the emissions which do not have 3 dB margin will be repeated one by one using the quasi-peak method for below 1GHz.
8. For testing above 1GHz, the emissions level of the EUT in peak mode was lower than average limit (that means the emissions level in peak mode also complies with the limit in average mode), then testing will be stopped and peak values of EUT will be reported, otherwise, the emissions will be measured in average mode again and reported.
9. In case the emission is lower than 30MHz, loop antenna has to be used for measurement and the recorded data should be QP measured by receiver. High – Low scan is not required in this case.

4.2.4. Test Setup Layout

For Radiated Emissions: 9kHz ~30MHz

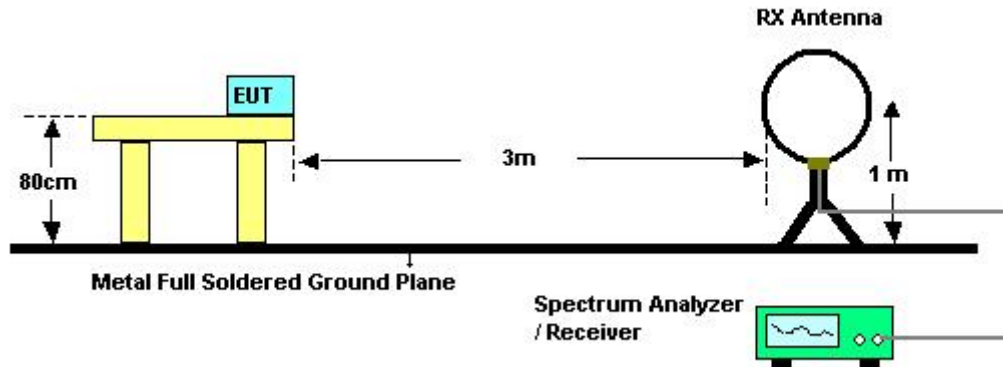

For Radiated Emissions: 30MHz~1GHz

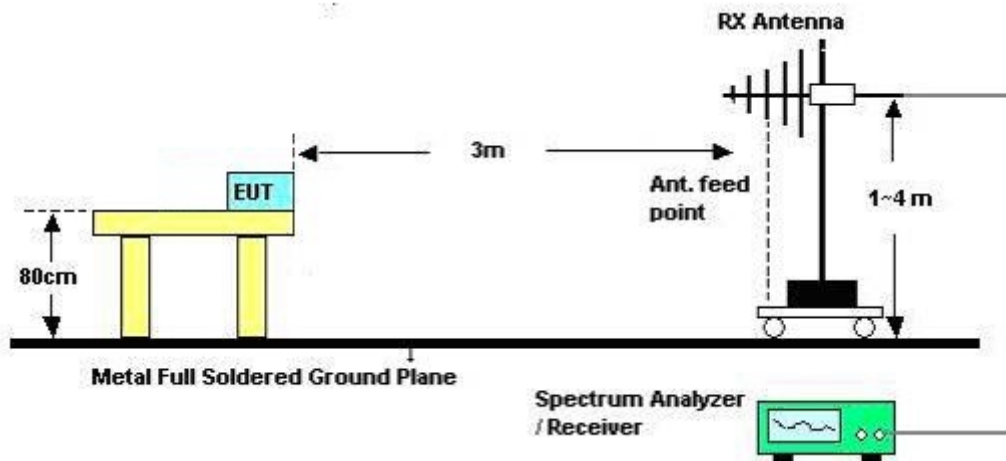

4.2.5. Test Deviation

There is no deviation with the original standard.

4.2.6. EUT Operation during Test

The EUT was programmed to be in continuously transmitting mode.

4.2.7. Results of Radiated Emissions (9kHz~30MHz)

Temperature	22°C	Humidity	54%
Test Engineer	DK Chang	Configurations	Normal Link
Test Date	Jul. 05, 2016	Test Mode	Mode 2

Freq. (MHz)	Level (dBuV)	Over Limit (dB)	Limit Line (dBuV)	Remark
-	-	-	-	See Note

Note:

The amplitude of spurious emissions which are attenuated by more than 20 dB below the permissible value has no need to be reported.

Distance extrapolation factor = $40 \log(\text{specific distance} / \text{test distance})$ (dB);

Limit line = specific limits (dBuV) + distance extrapolation factor.

4.2.8. Results of Radiated Emissions (30MHz~1GHz)

Temperature	22°C	Humidity	54%
Test Engineer	DK Chang	Configurations	Normal Link
Test Mode	Mode 2		

Horizontal

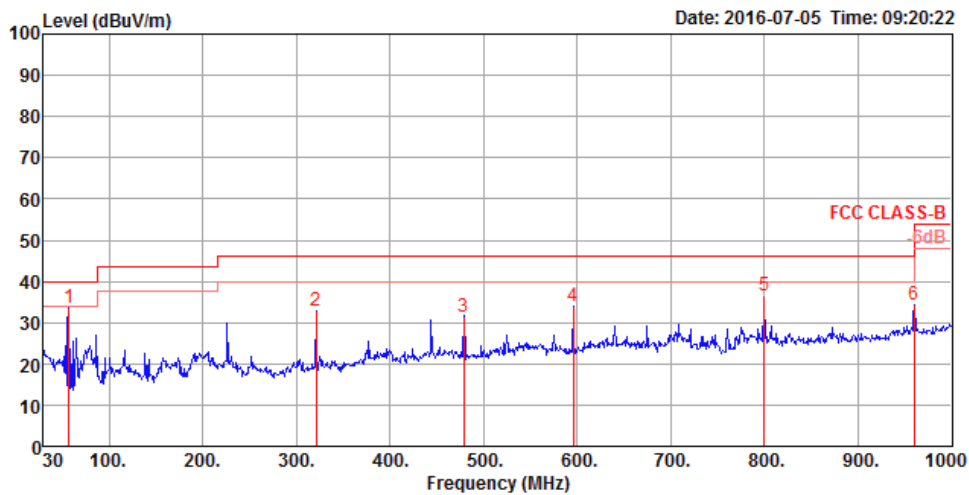

	Freq	Level	Limit Line	Over Limit	Read Level	CableAntenna Loss	Preamp Factor	A/Pos	T/Pos	Remark	Pol/Phase
	MHz	dBuV/m	dBuV/m	dB	dBuV	dB	dB/m	dB	cm	deg	
1	57.16	33.61	40.00	-6.39	51.33	0.67	14.02	32.41	200	61 Peak	HORIZONTAL
2	321.00	32.77	46.00	-13.23	42.92	1.54	20.60	32.29	300	191 Peak	HORIZONTAL
3	479.11	31.34	46.00	-14.66	38.11	1.90	23.68	32.35	200	296 Peak	HORIZONTAL
4	595.51	34.06	46.00	-11.94	39.01	2.11	25.35	32.41	300	274 Peak	HORIZONTAL
5	800.18	36.45	46.00	-9.55	39.43	2.46	26.80	32.24	100	193 Peak	HORIZONTAL
6	960.23	34.39	54.00	-19.61	34.69	2.69	28.20	31.19	100	70 Peak	HORIZONTAL

Vertical

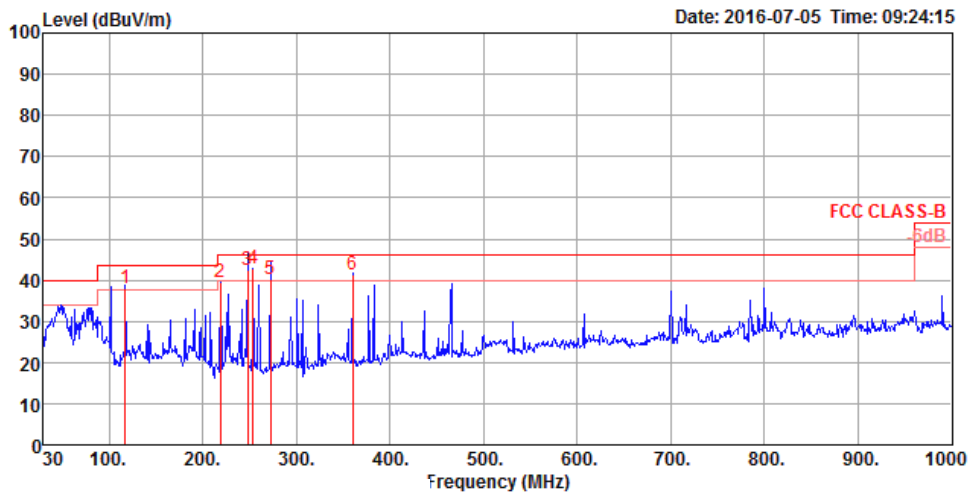

	Freq	Level	Limit Line	Over Limit	Read Level	CableAntenna Loss	Preamp Factor	A/Pos	T/Pos	Remark	Pol/Phase
	MHz	dBuV/m	dBuV/m	dB	dBuV	dB	dB/m	dB	cm	deg	
1	117.30	37.83	43.50	-5.67	50.25	0.94	19.02	32.38	100	198	Peak VERTICAL
2	219.15	39.32	46.00	-6.68	53.49	1.27	16.88	32.32	150	311	Peak VERTICAL
3	248.25	42.46	46.00	-3.54	54.44	1.34	18.98	32.30	100	109	QP VERTICAL
4	254.07	42.94	46.00	-3.06	54.50	1.35	19.39	32.30	300	246	Peak VERTICAL
5	272.50	40.28	46.00	-5.72	51.55	1.40	19.62	32.29	150	288	QP VERTICAL
6	359.80	41.29	46.00	-4.71	50.33	1.63	21.64	32.31	150	283	Peak VERTICAL

Note:

The amplitude of spurious emissions that are attenuated by more than 20dB below the permissible value has no need to be reported.

Emission level (dBuV/m) = 20 log Emission level (uV/m).

Corrected Reading: Antenna Factor + Cable Loss + Read Level - Preamp Factor = Level.

4.3. Antenna Requirements

4.3.1. Limit

Except for special regulations, the Low-power Radio-frequency Devices must not be equipped with any jacket for installing an antenna with extension cable. An intentional radiator shall be designed to ensure that no antenna other than that furnished by the responsible party shall be used with the device. The use of a permanently attached antenna or of an antenna that uses a unique coupling to the intentional radiator shall be considered sufficient to comply with the provisions of this Section. The manufacturer may design the unit so that the user can replace a broken antenna, but the use of a standard antenna jack or electrical connector is prohibited. Further, this requirement does not apply to intentional radiators that must be professionally installed.

4.3.2. Antenna Connector Construction

Please refer to section 3.3 in this test report; antenna connector complied with the requirements.

5. LIST OF MEASURING EQUIPMENTS

Instrument	Manufacturer	Model No.	Serial No.	Characteristics	Calibration Date	Remark
EMI Receiver	Agilent	N9038A	My52260123	9kHz ~ 8.45GHz	Jan. 27, 2016	Conduction (CO01-CB)
LISN	F.C.C.	FCC-LISN-50-16-2	04083	150kHz ~ 100MHz	Dec. 08, 2015	Conduction (CO01-CB)
LISN	Schwarzbeck	NSLK 8127	8127647	9kHz ~ 30MHz	Dec. 23, 2015	Conduction (CO01-CB)
COND Cable	Woken	Cable	01	150kHz ~ 30MHz	May 24, 2016	Conduction (CO01-CB)
Software	Audix	E3	6.120210n	-	N.C.R.	Conduction (CO01-CB)
BILOG ANTENNA	TESEQ	CBL6112D	37880	20MHz ~ 2GHz	Sep. 03, 2015	Radiation (03CH01-CB)
Loop Antenna	Teseq	HLA 6120	24155	9kHz - 30 MHz	Mar. 16, 2016*	Radiation (03CH01-CB)
Pre-Amplifier	Agilent	8447D	2944A10991	0.1MHz ~ 1.3GHz	Mar. 15, 2016	Radiation (03CH01-CB)
Spectrum Analyzer	R&S	FSP40	100056	9kHz ~ 40GHz	Oct. 27, 2015	Radiation (03CH01-CB)
EMI Test	R&S	ESCS	100355	9kHz ~ 2.75GHz	May 16, 2016	Radiation (03CH01-CB)
RF Cable-low	Woken	Low Cable-1	N/A	30 MHz ~ 1 GHz	Nov. 02, 2015	Radiation (03CH01-CB)
Test Software	Audix	E3	6.2009-10-7	N/A	N/A	Radiation (03CH01-CB)

Note: Calibration Interval of instruments listed above is one year.

"*" Calibration Interval of instruments listed above is two years.

NCR means Non-Calibration required.

6. MEASUREMENT UNCERTAINTY

Test Items	Uncertainty	Remark
Conducted Emission (150kHz ~ 30MHz)	3.2 dB	Confidence levels of 95%
Radiated Emission (30MHz ~ 1,000MHz)	3.6 dB	Confidence levels of 95%