



A D T

FCC TEST REPORT

REPORT NO.: RF980223L04

MODEL NO.: WLI-UC-G300N-V1

RECEIVED: Feb. 23, 2009

TESTED: Apr. 14 ~ Apr. 30, 2009

ISSUED: May 08, 2009

APPLICANT: Buffalo Inc.

ADDRESS: 4-15, Shibata Hondori, Minami-ku, Nagoya
457-8520, Japan

ISSUED BY: Bureau Veritas Consumer Products Services
(H.K.) Ltd., Taoyuan Branch

LAB ADDRESS: No. 47, 14th Ling, Chia Pau Tsuen, Lin Kou
Hsiang, Taipei Hsien 244, Taiwan, R.O.C.

TEST LOCATION: No. 19, Hwa Ya 2nd Rd, Wen Hwa Tsuen, Kwei
Shan Hsiang, Taoyuan Hsien 333, Taiwan,
R.O.C.

This test report consists of 90 pages in total. It may be duplicated completely for legal use with the approval of the applicant. It should not be reproduced except in full, without the written approval of our laboratory. The client should not use it to claim product endorsement by TAF or any government agencies. The test results in the report only apply to the tested sample.





A D T

TABLE OF CONTENTS

1.	CERTIFICATION.....	4
2.	SUMMARY OF TEST RESULTS	5
2.1	MEASUREMENT UNCERTAINTY.....	5
3.	GENERAL INFORMATION.....	6
3.1	GENERAL DESCRIPTION OF EUT	6
3.2	DESCRIPTION OF TEST MODES	7
3.2.1	CONFIGURATION OF SYSTEM UNDER TEST	7
3.2.2	TEST MODE APPLICABILITY AND TESTED CHANNEL DETAIL	8
3.3	GENERAL DESCRIPTION OF APPLIED STANDARDS	10
3.4	DESCRIPTION OF SUPPORT UNITS	10
4.	TEST TYPES AND RESULTS	11
4.1	RADIATED EMISSION MEASUREMENT	11
4.1.1	LIMITS OF RADIATED EMISSION MEASUREMENT.....	11
4.1.2	TEST INSTRUMENTS.....	12
4.1.3	TEST PROCEDURES	13
4.1.4	DEVIATION FROM TEST STANDARD.....	13
4.1.5	TEST SETUP.....	14
4.1.6	EUT OPERATING CONDITIONS	14
4.1.7	TEST RESULTS	15
4.2	CONDUCTED EMISSION MEASUREMENT	28
4.2.1	LIMITS OF CONDUCTED EMISSION MEASUREMENT.....	28
4.2.2	TEST INSTRUMENTS.....	28
4.2.3	TEST PROCEDURES	29
4.2.4	DEVIATION FROM TEST STANDARD.....	29
4.2.5	TEST SETUP.....	30
4.2.6	EUT OPERATING CONDITIONS	30
4.2.7	TEST RESULTS	31
4.3	6dB BANDWIDTH MEASUREMENT.....	33
4.3.1	LIMITS OF 6dB BANDWIDTH MEASUREMENT	33
4.3.2	TEST INSTRUMENTS.....	33
4.3.3	TEST PROCEDURE.....	33
4.3.4	DEVIATION FROM TEST STANDARD.....	33
4.3.5	TEST SETUP.....	34
4.3.6	EUT OPERATING CONDITIONS	34
4.3.7	TEST RESULTS	35
4.4	MAXIMUM PEAK OUTPUT POWER.....	49
4.4.1	LIMITS OF MAXIMUM PEAK OUTPUT POWER MEASUREMENT	49
4.4.2	INSTRUMENTS.....	49
4.4.3	TEST PROCEDURES	49
4.4.4	DEVIATION FROM TEST STANDARD.....	50
4.4.5	TEST SETUP.....	50



4.4.6	EUT OPERATING CONDITIONS	50
4.4.7	TEST RESULTS	51
4.5	POWER SPECTRAL DENSITY MEASUREMENT	53
4.5.1	LIMITS OF POWER SPECTRAL DENSITY MEASUREMENT	53
4.5.2	TEST INSTRUMENTS.....	53
4.5.3	TEST PROCEDURE.....	53
4.5.4	DEVIATION FROM TEST STANDARD.....	54
4.5.5	TEST SETUP.....	54
4.5.6	EUT OPERATING CONDITION.....	54
4.5.7	TEST RESULTS	55
4.6	BAND EDGES MEASUREMENT	69
4.6.1	LIMITS OF BAND EDGES MEASUREMENT.....	69
4.6.2	TEST INSTRUMENTS.....	69
4.6.3	TEST PROCEDURE.....	70
4.6.4	DEVIATION FROM TEST STANDARD.....	70
4.6.5	EUT OPERATING CONDITION.....	70
4.6.6	TEST RESULTS	71
4.7	ANTENNA REQUIREMENT	87
4.7.1	STANDARD APPLICABLE	87
4.7.2	ANTENNA CONNECTED CONSTRUCTION	87
5.	PHOTOGRAPHS OF THE TEST CONFIGURATION.....	88
6.	INFORMATION ON THE TESTING LABORATORIES	89
7.	APPENDIX A - MODIFICATIONS RECORDERS FOR ENGINEERING CHANGES TO THE EUT BY THE LAB.....	90



A D T

1. CERTIFICATION

PRODUCT: AirStation Wireless-N NFINITI Keychain USB2.0 Adapter

MODEL: WLI-UC-G300N-V1

BRAND: Buffalo

APPLICANT: Buffalo Inc.

TESTED: Apr. 14 ~ Apr. 30, 2009

TEST SAMPLE: ENGINEERING SAMPLE

STANDARDS: **FCC Part 15, Subpart C (Section 15.247)**

ANSI C63.4-2003

The above equipment (Model: WLI-UC-G300N-V1) has been tested by **Bureau Veritas Consumer Products Services (H.K.) Ltd., Taoyuan Branch**, and found compliance with the requirement of the above standards. The test record, data evaluation & Equipment Under Test (EUT) configurations represented herein are true and accurate accounts of the measurements of the sample's EMC characteristics under the conditions specified in this report.

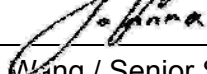
PREPARED BY :  , **DATE** : May 08, 2009
Joanna Wang / Senior Specialist

TECHNICAL ACCEPTANCE :  , **DATE** : May 08, 2009
Responsible for RF Long Chen / Senior Engineer

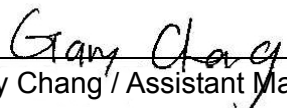
APPROVED BY :  , **DATE** : May 08, 2009
Gary Chang / Assistant Manager



2. SUMMARY OF TEST RESULTS

The EUT has been tested according to the following specifications:

APPLIED STANDARD: FCC PART 15, SUBPART C (SECTION 15.247)			
STANDARD SECTION	TEST TYPE AND LIMIT	RESULT	REMARK
15.207	AC Power Conducted Emission	PASS	Meet the requirement of limit. Minimum passing margin is -15.54dB at 1.789MHz.
15.247(a)(2)	Spectrum Bandwidth of a Direct Sequence Spread Spectrum System Limit: min. 500kHz	PASS	Meet the requirement of limit.
15.247(b)	Maximum Peak Output Power Limit: max. 30dBm	PASS	Meet the requirement of limit.
15.247(d)	Radiated Emissions Limit: Table 15.209	PASS	Meet the requirement of limit. Minimum passing margin is -1.26dB at 4874.00MHz.
15.247(e)	Power Spectral Density Limit: max. 8dBm	PASS	Meet the requirement of limit.
15.247(d)	Band Edge Measurement Limit: 20dB less than the peak value of fundamental frequency	PASS	Meet the requirement of limit.

2.1 MEASUREMENT UNCERTAINTY

Where relevant, the following measurement uncertainty levels have been estimated for tests performed on the EUT as specified in CISPR 16-4-2:

MEASUREMENT	FREQUENCY	UNCERTAINTY
Conducted emissions	150kHz~30MHz	2.44dB
Radiated emissions	30MHz ~ 200MHz	2.93dB
	200MHz ~1000MHz	2.95dB
	1GHz ~ 18GHz	2.26dB
	18GHz ~ 40GHz	1.94dB

This uncertainty represents an expanded uncertainty expressed at approximately the 95% confidence level using a coverage factor of $k = 2$.



3. GENERAL INFORMATION

3.1 GENERAL DESCRIPTION OF EUT

EUT	AirStation Wireless-N NFINITI Keychain USB2.0 Adapter
MODEL NO.	WLI-UC-G300N-V1
FCC ID	FDI-09102067-1
POWER SUPPLY	5Vdc from host equipment
MODULATION TYPE	CCK, DQPSK, DBPSK for DSSS 64QAM, 16QAM, QPSK, BPSK for OFDM
MODULATION TECHNOLOGY	DSSS, OFDM
TRANSFER RATE	802.11b:11.0/ 5.5/ 2.0/ 1.0Mbps 802.11g: 54.0/ 48.0/ 36.0/ 24.0/ 18.0/ 12.0/ 9.0/ 6.0Mbps Draft 802.11n: up to 300.0Mbps
OPERATING FREQUENCY	2412 ~ 2462MHz
NUMBER OF CHANNEL	11 for 802.11b, 802.11g, draft 802.11n (20MHz) 7 for draft 802.11n (40MHz)
OUTPUT POWER	304.655mW
ANTENNA TYPE	Printed antenna with 1dBi gain
DATA CABLE	0.34m shielded USB cable without core
I/O PORTS	USB
ACCESSORY DEVICES	NA

NOTE:

1. The EUT incorporates a MIMO function. Physically, the EUT provides two completed transmitters and two receivers.

MODULATION MODE	TX FUNCTION
802.11b	1TX
802.11g	1TX
Draft 802.11n (20MHz)	2TX
Draft 802.11n (40MHz)	2TX

2. The above EUT information was declared by manufacturer and for more detailed features description, please refer to the manufacturer's specifications or user's manual.

3.2 DESCRIPTION OF TEST MODES

11 channels are provided for 802.11b, 802.11g and draft 802.11n (20MHz):

CHANNEL	FREQUENCY	CHANNEL	FREQUENCY
1	2412MHz	7	2442MHz
2	2417MHz	8	2447MHz
3	2422MHz	9	2452MHz
4	2427MHz	10	2457MHz
5	2432MHz	11	2462MHz
6	2437MHz		

7 channels are provided for draft 802.11n (40MHz):

CHANNEL	FREQUENCY	CHANNEL	FREQUENCY
1	2422MHz	5	2442MHz
2	2427MHz	6	2447MHz
3	2432MHz	7	2452MHz
4	2437MHz		

3.2.1 CONFIGURATION OF SYSTEM UNDER TEST

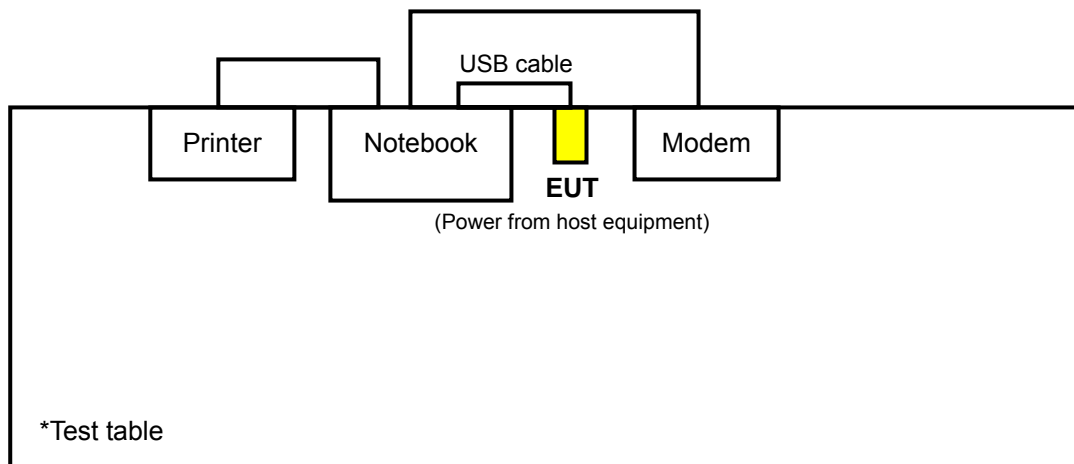

3.2.2 TEST MODE APPLICABILITY AND TESTED CHANNEL DETAIL

EUT CONFIGURE MODE	APPLICABLE TO				DESCRIPTION
	RE≥1G	RE<1G	PLC	APCM	
-	√	√	√	√	-

Where **RE≥1G**: Radiated Emission above 1GHz **RE<1G**: Radiated Emission below 1GHz
PLC: Power Line Conducted Emission **APCM**: Antenna Port Conducted Measurement

NOTE: The EUT had two configure mode, one was plugged into the notebook directly, and the other was connected with notebook via USB cable. After pre-tested two configure mode found EUT via USB cable to notebook was the worst, therefore chosen for the final test and presented in the test report.

RADIATED EMISSION TEST (ABOVE 1GHz):

- Pre-Scan has been conducted to determine the worst-case mode from all possible combinations between available modulations, data rates, XYZ Axis and antenna ports (if EUT with antenna diversity architecture).
- Following channel(s) was (were) selected for the final test as listed below.

MODE	AVAILABLE CHANNEL	TESTED CHANNEL	MODULATION TECHNOLOGY	MODULATION TYPE	DATA RATE (Mbps)	AXIS
802.11b	1 to 11	1, 6, 11	DSSS	DBPSK	1.0	Z
802.11g	1 to 11	1, 6, 11	OFDM	BPSK	6.0	
Draft 802.11n (20MHz)	1 to 11	1, 6, 11	OFDM	BPSK	6.5	
Draft 802.11n (40MHz)	1 to 7	1, 4, 7	OFDM	BPSK	13.5	

RADIATED EMISSION TEST (BELOW 1GHz):

- Pre-Scan has been conducted to determine the worst-case mode from all possible combinations between available modulations, data rates, XYZ Axis and antenna ports (if EUT with antenna diversity architecture).
- Following channel(s) was (were) selected for the final test as listed below.

MODE	AVAILABLE CHANNEL	TESTED CHANNEL	MODULATION TECHNOLOGY	MODULATION TYPE	DATA RATE (Mbps)	AXIS
Draft 802.11n (40MHz)	1 to 7	4	OFDM	BPSK	13.5	Z

POWER LINE CONDUCTED EMISSION TEST:

- Pre-Scan has been conducted to determine the worst-case mode from all possible combinations between available modulations, data rates and antenna ports (if EUT with antenna diversity architecture).
- Following channel(s) was (were) selected for the final test as listed below.

MODE	AVAILABLE CHANNEL	TESTED CHANNEL	MODULATION TECHNOLOGY	MODULATION TYPE	DATA RATE (Mbps)	AXIS
Draft 802.11n (40MHz)	1 to 7	4	OFDM	BPSK	13.5	Z



A D T

BANDEDGE MEASUREMENT:

- Pre-Scan has been conducted to determine the worst-case mode from all possible combinations between available modulations, data rates, XYZ Axis and antenna ports (if EUT with antenna diversity architecture).
- Following channel(s) was (were) selected for the final test as listed below.

MODE	AVAILABLE CHANNEL	TESTED CHANNEL	MODULATION TECHNOLOGY	MODULATION TYPE	DATA RATE (Mbps)	AXIS
802.11b	1 to 11	1, 11	DSSS	DBPSK	1.0	Z
802.11g	1 to 11	1, 11	OFDM	BPSK	6.0	
Draft 802.11n (20MHz)	1 to 11	1, 11	OFDM	BPSK	6.5	
Draft 802.11n (40MHz)	1 to 7	1, 7	OFDM	BPSK	13.5	

ANTENNA PORT CONDUCTED MEASUREMENT:

- Pre-Scan has been conducted to determine the worst-case mode from all possible combinations between available modulations, data rates and antenna ports (if EUT with antenna diversity architecture).
- Following channel(s) was (were) selected for the final test as listed below.

MODE	AVAILABLE CHANNEL	TESTED CHANNEL	MODULATION TECHNOLOGY	MODULATION TYPE	DATA RATE (Mbps)
802.11b	1 to 11	1, 6, 11	DSSS	DBPSK	1.0
802.11g	1 to 11	1, 6, 11	OFDM	BPSK	6.0
Draft 802.11n (20MHz)	1 to 11	1, 6, 11	OFDM	BPSK	6.5
Draft 802.11n (40MHz)	1 to 7	1, 4, 7	OFDM	BPSK	13.5



A D T

3.3 GENERAL DESCRIPTION OF APPLIED STANDARDS

The EUT is a RF Product. According to the specifications of the manufacturer, it must comply with the requirements of the following standards:

FCC Part 15, Subpart C (15.247)

ANSI C63.4-2003

All test items have been performed and recorded as per the above standards.

NOTE: The EUT is also considered as a kind of computer peripheral, because the connection to computer is necessary for typical use. It has been verified to comply with the requirements of FCC Part 15, Subpart B, Class B (DoC). The test report has been issued separately.

3.4 DESCRIPTION OF SUPPORT UNITS

The EUT has been tested as an independent unit together with other necessary accessories or support units. The following support units or accessories were used to form a representative test configuration during the tests.

NO.	PRODUCT	BRAND	MODEL NO.	SERIAL NO.	FCC ID
1	NOTEBOOK	DELL	PP05L	12130898320	E2K24CLNS
2	PRINTER	EPSON	LQ-300+	DCGY054011	FCC DoC Approved
3	MODEM	ACEEX	1414V/3	0401008253	IFAXDM1414

NO.	SIGNAL CABLE DESCRIPTION OF THE ABOVE SUPPORT UNITS
1	NA
2	1.8m braid shielded wire, DB25 connector, w/o core.
3	1.2m braid shielded wire, DB25 & DB9 connector, w/o core.

NOTE: All power cords of the above support units are non shielded (1.8m).



A D T

4. TEST TYPES AND RESULTS

4.1 RADIATED EMISSION MEASUREMENT

4.1.1 LIMITS OF RADIATED EMISSION MEASUREMENT

Emissions radiated outside of the specified bands, shall be according to the general radiated limits in 15.209 as following:

FREQUENCIES (MHz)	FIELD STRENGTH (microvolts/meter)	MEASUREMENT DISTANCE (meters)
0.009 ~ 0.490	2400/F(kHz)	300
0.490 ~ 1.705	24000/F(kHz)	30
1.705 ~ 30.0	30	30
30 ~ 88	100	3
88 ~ 216	150	3
216 ~ 960	200	3
Above 960	500	3

NOTE:

1. The lower limit shall apply at the transition frequencies.
2. Emission level (dBuV/m) = 20 log Emission level (uV/m).
3. As shown in 15.35(b), for frequencies above 1000MHz, the field strength limits are based on average detector, however, the peak field strength of any emission shall not exceed the maximum permitted average limits, specified above by more than 20dB under any condition of modulation.



A D T

4.1.2 TEST INSTRUMENTS

DESCRIPTION & MANUFACTURER	MODEL NO.	SERIAL NO.	DATE OF CALIBRATION	DUE DATE OF CALIBRATION
Test Receiver ROHDE & SCHWARZ	ESIB7	100212	May 28, 2008	May 27, 2009
Spectrum Analyzer ROHDE & SCHWARZ	FSP40	100269	Aug. 08, 2008	Aug. 07, 2009
BILOG Antenna SCHWARZBECK	VULB9168	9168-316	May 01, 2008	Apr. 30, 2009
HORN Antenna SCHWARZBECK	BBHA 9120 D	9120D-563	Aug. 06, 2008	Aug. 05, 2009
HORN Antenna SCHWARZBECK	BBHA 9170	BBHA9170242	Jan. 06, 2009	Jan. 05, 2010
Preamplifier Agilent	8449B	3008A01911	Sep. 10, 2008	Sep. 09, 2009
Preamplifier Agilent	8447D	2944A10638	Dec. 26, 2008	Dec. 25, 2009
RF signal cable HUBER+SUHNNER	SUCOFLEX 104	218190/4 231241/4	May 20, 2008	May 19, 2009
RF signal cable Worken	8D-FB	Cable-HYCH9-01	Aug. 09, 2008	Aug. 08, 2009
Software	ADT_Radiated_ V7.6.15.9.2	NA	NA	NA
Antenna Tower EMCO	2070/2080	512.835.4684	NA	NA
Turn Table EMCO	2087-2.03	NA	NA	NA
Antenna Tower & Turn Table Controller EMCO	2090	NA	NA	NA

- NOTE:**
1. The calibration interval of the above test instruments is 12 months and the calibrations are traceable to NML/ROC and NIST/USA.
 2. The test was performed in HwaYa Chamber 9.
 3. The horn antenna and HP preamplifier (model: 8449B) are used only for the measurement of emission frequency above 1GHz if tested.
 4. The FCC Site Registration No. is 460141.
 5. The IC Site Registration No. is IC 7450F-4.



4.1.3 TEST PROCEDURES

- a. The EUT was placed on the top of a rotating table 0.8 meters above the ground at a 3 meters semi-anechoic chamber. The table was rotated 360 degrees to determine the position of the highest radiation.
- b. The EUT was set 3 meters away from the interference-receiving antenna, which was mounted on the top of a variable-height antenna tower.
- c. The antenna is a broadband antenna, and its height is varied from one meter to four meters above the ground to determine the maximum value of the field strength. Both horizontal and vertical polarizations of the antenna are set to make the measurement.
- d. For each suspected emission, the EUT was arranged to its worst case and then the antenna was tuned to heights from 1 meter to 4 meters and the rotatable table was turned from 0 degrees to 360 degrees to find the maximum reading.
- e. The test-receiver system was set to Peak Detect Function and Specified Bandwidth with Maximum Hold Mode.
- f. If the emission level of the EUT in peak mode was lower than the limit specified, then testing could be stopped and the peak values of the EUT would be reported. Otherwise the emissions would be re-tested one by one using peak, quasi-peak or average method as specified and then reported in a data sheet.

NOTE:

1. The resolution bandwidth and video bandwidth of test receiver/spectrum analyzer is 120kHz for Quasi-peak detection at frequency below 1GHz.
2. The resolution bandwidth of test receiver/spectrum analyzer is 1MHz and video bandwidth is 3MHz for Peak detection at frequency above 1GHz.
3. The resolution bandwidth of test receiver/spectrum analyzer is 1MHz and the video bandwidth is 10Hz for Average detection (AV) at frequency above 1GHz.
4. All modes of operation were investigated and the worst-case emissions are reported.

4.1.4 DEVIATION FROM TEST STANDARD

No deviation.

4.1.5 TEST SETUP

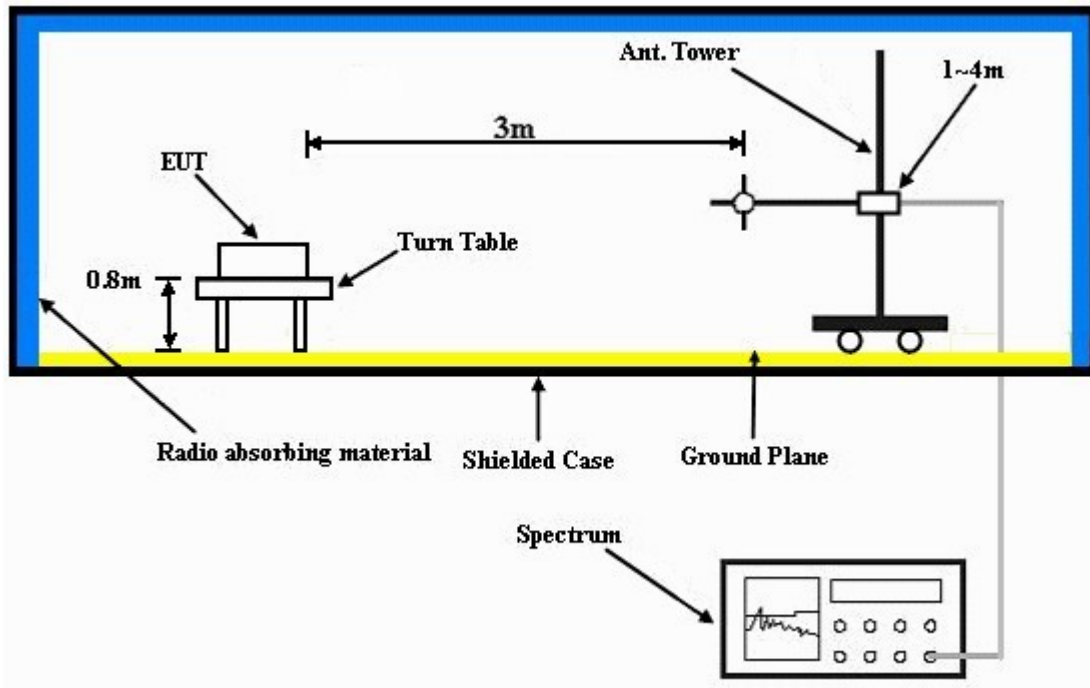

For the actual test configuration, please refer to the attached file (Test Setup Photo).

4.1.6 EUT OPERATING CONDITIONS

- a. Connected the EUT to a notebook via USB cable and placed on a testing table.
- b. The notebook ran a test program (provided by manufacturer) to enable EUT under transmission condition continuously at specific channel frequency.
- c. The necessary accessories enable the system in full functions.



A D T

4.1.7 TEST RESULTS

802.11b DSSS MODULATION

EUT TEST CONDITION		MEASUREMENT DETAIL	
CHANNEL	Channel 1	FREQUENCY RANGE	1 ~ 25GHz
INPUT POWER (SYSTEM)	120Vac, 60 Hz	DETECTOR FUNCTION	Peak (PK) Average (AV)
ENVIRONMENTAL CONDITIONS	20deg. C, 70%RH 1007hPa	TESTED BY	Match Tsui

ANTENNA POLARITY & TEST DISTANCE: HORIZONTAL AT 3 M								
NO.	FREQ. (MHz)	EMISSION LEVEL (dBuV/m)	LIMIT (dBuV/m)	MARGIN (dB)	ANTENNA HEIGHT (m)	TABLE ANGLE (Degree)	RAW VALUE (dBuV)	CORRECTION FACTOR (dB/m)
1	2390.00	56.87 PK	74.00	-17.13	1.48 H	39	23.79	33.08
2	2390.00	46.97 AV	54.00	-7.03	1.48 H	39	13.89	33.08
3	*2412.00	101.21 PK			1.48 H	39	68.03	33.18
4	*2412.00	96.69 AV			1.48 H	39	63.51	33.18
5	4824.00	52.52 PK	74.00	-21.48	1.07 H	356	13.37	39.15
6	4824.00	46.47 AV	54.00	-7.53	1.07 H	356	7.32	39.15
ANTENNA POLARITY & TEST DISTANCE: VERTICAL AT 3 M								
NO.	FREQ. (MHz)	EMISSION LEVEL (dBuV/m)	LIMIT (dBuV/m)	MARGIN (dB)	ANTENNA HEIGHT (m)	TABLE ANGLE (Degree)	RAW VALUE (dBuV)	CORRECTION FACTOR (dB/m)
1	2390.00	57.42 PK	74.00	-16.58	1.16 V	48	24.34	33.08
2	2390.00	46.88 AV	54.00	-7.12	1.16 V	48	13.80	33.08
3	*2412.00	99.94 PK			1.16 V	48	66.76	33.18
4	*2412.00	95.39 AV			1.16 V	48	62.21	33.18
5	4824.00	55.65 PK	74.00	-18.35	1.02 V	21	16.50	39.15
6	4824.00	52.17 AV	54.00	-1.83	1.02 V	21	13.02	39.15

- REMARKS:**
1. Emission level (dBuV/m) = Raw Value (dBuV) + Correction Factor (dB/m).
 2. Correction Factor (dB/m) = Antenna Factor (dB/m) + Cable Factor (dB).
 3. The other emission levels were very low against the limit.
 4. Margin value = Emission level – Limit value.
 5. “ * ”: Fundamental frequency.



A D T

EUT TEST CONDITION		MEASUREMENT DETAIL	
CHANNEL	Channel 6	FREQUENCY RANGE	1 ~ 25GHz
INPUT POWER (SYSTEM)	120Vac, 60 Hz	DETECTOR FUNCTION	Peak (PK) Average (AV)
ENVIRONMENTAL CONDITIONS	20deg. C, 70%RH 1007hPa	TESTED BY	Match Tsui

ANTENNA POLARITY & TEST DISTANCE: HORIZONTAL AT 3 M								
NO.	FREQ. (MHz)	EMISSION LEVEL (dBuV/m)	LIMIT (dBuV/m)	MARGIN (dB)	ANTENNA HEIGHT (m)	TABLE ANGLE (Degree)	RAW VALUE (dBuV)	CORRECTION FACTOR (dB/m)
1	*2437.00	102.03 PK			1.34 H	188	68.75	33.28
2	*2437.00	97.61 AV			1.34 H	188	64.33	33.28
3	4874.00	53.23 PK	74.00	-20.77	1.18 H	360	14.08	39.14
4	4874.00	46.91 AV	54.00	-7.09	1.18 H	360	7.76	39.14
ANTENNA POLARITY & TEST DISTANCE: VERTICAL AT 3 M								
NO.	FREQ. (MHz)	EMISSION LEVEL (dBuV/m)	LIMIT (dBuV/m)	MARGIN (dB)	ANTENNA HEIGHT (m)	TABLE ANGLE (Degree)	RAW VALUE (dBuV)	CORRECTION FACTOR (dB/m)
1	*2437.00	100.93 PK			1.09 V	103	67.65	33.28
2	*2437.00	96.35 AV			1.09 V	103	63.07	33.28
3	4874.00	56.11 PK	74.00	-17.89	1.14 V	27	16.96	39.14
4	4874.00	52.74 AV	54.00	-1.26	1.14 V	27	13.59	39.14

- REMARKS:**
1. Emission level (dBuV/m) = Raw Value (dBuV) + Correction Factor (dB/m).
 2. Correction Factor (dB/m) = Antenna Factor (dB/m) + Cable Factor (dB).
 3. The other emission levels were very low against the limit.
 4. Margin value = Emission level – Limit value.
 5. “ * “: Fundamental frequency.



A D T

EUT TEST CONDITION		MEASUREMENT DETAIL	
CHANNEL	Channel 11	FREQUENCY RANGE	1 ~ 25GHz
INPUT POWER (SYSTEM)	120Vac, 60 Hz	DETECTOR FUNCTION	Peak (PK) Average (AV)
ENVIRONMENTAL CONDITIONS	20deg. C, 70%RH 1007hPa	TESTED BY	Match Tsui

ANTENNA POLARITY & TEST DISTANCE: HORIZONTAL AT 3 M								
NO.	FREQ. (MHz)	EMISSION LEVEL (dBuV/m)	LIMIT (dBuV/m)	MARGIN (dB)	ANTENNA HEIGHT (m)	TABLE ANGLE (Degree)	RAW VALUE (dBuV)	CORRECTION FACTOR (dB/m)
1	*2462.00	101.97 PK			1.44 H	42	68.59	33.38
2	*2462.00	97.83 AV			1.44 H	42	64.45	33.38
3	2483.50	55.69 PK	74.00	-18.31	1.44 H	42	22.23	33.46
4	2483.50	47.30 AV	54.00	-6.70	1.44 H	42	13.84	33.46
5	4924.00	52.21 PK	74.00	-21.79	1.05 H	42	12.85	39.35
6	4924.00	46.02 AV	54.00	-7.98	1.05 H	42	6.66	39.35
ANTENNA POLARITY & TEST DISTANCE: VERTICAL AT 3 M								
NO.	FREQ. (MHz)	EMISSION LEVEL (dBuV/m)	LIMIT (dBuV/m)	MARGIN (dB)	ANTENNA HEIGHT (m)	TABLE ANGLE (Degree)	RAW VALUE (dBuV)	CORRECTION FACTOR (dB/m)
1	*2462.00	100.66 PK			1.09 V	103	67.28	33.38
2	*2462.00	96.32 AV			1.09 V	103	62.94	33.38
3	2483.50	57.54 PK	74.00	-16.46	1.09 V	103	24.08	33.46
4	2483.50	47.53 AV	54.00	-6.47	1.09 V	103	14.07	33.46
5	4924.00	56.42 PK	74.00	-17.58	1.00 V	6	17.06	39.35
6	4924.00	52.43 AV	54.00	-1.57	1.00 V	6	13.07	39.35

- REMARKS:**
1. Emission level (dBuV/m) = Raw Value (dBuV) + Correction Factor (dB/m).
 2. Correction Factor (dB/m) = Antenna Factor (dB/m) + Cable Factor (dB).
 3. The other emission levels were very low against the limit.
 4. Margin value = Emission level – Limit value.
 5. “ * “: Fundamental frequency.



A D T

802.11g OFDM MODULATION

EUT TEST CONDITION		MEASUREMENT DETAIL	
CHANNEL	Channel 1	FREQUENCY RANGE	1 ~ 25GHz
INPUT POWER (SYSTEM)	120Vac, 60 Hz	DETECTOR FUNCTION	Peak (PK) Average (AV)
ENVIRONMENTAL CONDITIONS	20deg. C, 70%RH 1007hPa	TESTED BY	Match Tsui

ANTENNA POLARITY & TEST DISTANCE: HORIZONTAL AT 3 M								
NO.	FREQ. (MHz)	EMISSION LEVEL (dBuV/m)	LIMIT (dBuV/m)	MARGIN (dB)	ANTENNA HEIGHT (m)	TABLE ANGLE (Degree)	RAW VALUE (dBuV)	CORRECTION FACTOR (dB/m)
1	2390.00	57.93 PK	74.00	-16.07	1.50 H	35	24.85	33.08
2	2390.00	46.92 AV	54.00	-7.08	1.50 H	35	13.84	33.08
3	*2412.00	100.50 PK			1.50 H	39	67.32	33.18
4	*2412.00	90.48 AV			1.50 H	39	57.30	33.18
5	4824.00	48.83 PK	74.00	-25.17	1.50 H	342	9.68	39.15
6	4824.00	36.29 AV	54.00	-17.71	1.50 H	342	-2.86	39.15
ANTENNA POLARITY & TEST DISTANCE: VERTICAL AT 3 M								
NO.	FREQ. (MHz)	EMISSION LEVEL (dBuV/m)	LIMIT (dBuV/m)	MARGIN (dB)	ANTENNA HEIGHT (m)	TABLE ANGLE (Degree)	RAW VALUE (dBuV)	CORRECTION FACTOR (dB/m)
1	2390.00	57.95 PK	74.00	-16.05	1.20 V	175	24.87	33.08
2	2390.00	46.95 AV	54.00	-7.05	1.20 V	175	13.87	33.08
3	*2412.00	100.37 PK			1.20 V	175	67.19	33.18
4	*2412.00	90.00 AV			1.20 V	175	56.82	33.18
5	4824.00	53.79 PK	74.00	-20.21	1.02 V	29	14.64	39.15
6	4824.00	39.09 AV	54.00	-14.91	1.02 V	29	-0.06	39.15

- REMARKS:**
1. Emission level (dBuV/m) = Raw Value (dBuV) + Correction Factor (dB/m).
 2. Correction Factor (dB/m) = Antenna Factor (dB/m) + Cable Factor (dB).
 3. The other emission levels were very low against the limit.
 4. Margin value = Emission level – Limit value.
 5. “ * “: Fundamental frequency.



A D T

EUT TEST CONDITION		MEASUREMENT DETAIL	
CHANNEL	Channel 6	FREQUENCY RANGE	1 ~ 25GHz
INPUT POWER (SYSTEM)	120Vac, 60 Hz	DETECTOR FUNCTION	Peak (PK) Average (AV)
ENVIRONMENTAL CONDITIONS	20deg. C, 70%RH 1007hPa	TESTED BY	Match Tsui

ANTENNA POLARITY & TEST DISTANCE: HORIZONTAL AT 3 M								
NO.	FREQ. (MHz)	EMISSION LEVEL (dBuV/m)	LIMIT (dBuV/m)	MARGIN (dB)	ANTENNA HEIGHT (m)	TABLE ANGLE (Degree)	RAW VALUE (dBuV)	CORRECTION FACTOR (dB/m)
1	*2437.00	101.00 PK			1.47 H	355	67.72	33.28
2	*2437.00	90.66 AV			1.47 H	355	57.38	33.28
3	4874.00	49.06 PK	74.00	-24.94	1.37 H	1	9.91	39.14
4	4874.00	36.42 AV	54.00	-17.58	1.37 H	1	-2.73	39.14
ANTENNA POLARITY & TEST DISTANCE: VERTICAL AT 3 M								
NO.	FREQ. (MHz)	EMISSION LEVEL (dBuV/m)	LIMIT (dBuV/m)	MARGIN (dB)	ANTENNA HEIGHT (m)	TABLE ANGLE (Degree)	RAW VALUE (dBuV)	CORRECTION FACTOR (dB/m)
1	*2437.00	100.89 PK			1.43 V	157	67.61	33.28
2	*2437.00	90.40 AV			1.43 V	157	57.12	33.28
3	4874.00	52.29 PK	74.00	-21.71	1.26 V	360	13.14	39.14
4	4874.00	38.55 AV	54.00	-15.45	1.26 V	360	-0.60	39.14

- REMARKS:**
1. Emission level (dBuV/m) = Raw Value (dBuV) + Correction Factor (dB/m).
 2. Correction Factor (dB/m) = Antenna Factor (dB/m) + Cable Factor (dB).
 3. The other emission levels were very low against the limit.
 4. Margin value = Emission level – Limit value.
 5. “ * “: Fundamental frequency.



A D T

EUT TEST CONDITION		MEASUREMENT DETAIL	
CHANNEL	Channel 11	FREQUENCY RANGE	1 ~ 25GHz
INPUT POWER (SYSTEM)	120Vac, 60 Hz	DETECTOR FUNCTION	Peak (PK) Average (AV)
ENVIRONMENTAL CONDITIONS	20deg. C, 70%RH 1007hPa	TESTED BY	Match Tsui

ANTENNA POLARITY & TEST DISTANCE: HORIZONTAL AT 3 M								
NO.	FREQ. (MHz)	EMISSION LEVEL (dBuV/m)	LIMIT (dBuV/m)	MARGIN (dB)	ANTENNA HEIGHT (m)	TABLE ANGLE (Degree)	RAW VALUE (dBuV)	CORRECTION FACTOR (dB/m)
1	*2462.00	102.56 PK			1.00 H	26	69.18	33.38
2	*2462.00	92.20 AV			1.00 H	26	58.82	33.38
3	2483.50	58.41 PK	74.00	-15.59	1.00 H	26	24.95	33.46
4	2483.50	47.94 AV	54.00	-6.06	1.00 H	26	14.48	33.46
5	4924.00	48.91 PK	74.00	-25.09	1.00 H	360	9.56	39.35
6	4924.00	36.34 AV	54.00	-17.66	1.00 H	360	-3.01	39.35
ANTENNA POLARITY & TEST DISTANCE: VERTICAL AT 3 M								
NO.	FREQ. (MHz)	EMISSION LEVEL (dBuV/m)	LIMIT (dBuV/m)	MARGIN (dB)	ANTENNA HEIGHT (m)	TABLE ANGLE (Degree)	RAW VALUE (dBuV)	CORRECTION FACTOR (dB/m)
1	*2462.00	102.47 PK			1.11 V	103	69.09	33.38
2	*2462.00	91.61 AV			1.11 V	103	58.23	33.38
3	2483.50	57.11 PK	74.00	-16.89	1.11 V	103	23.65	33.46
4	2483.50	47.73 AV	54.00	-6.27	1.11 V	103	14.27	33.46
5	4924.00	53.81 PK	74.00	-20.19	1.00 V	35	14.46	39.35
6	4924.00	39.12 AV	54.00	-14.88	1.00 V	35	-0.23	39.35

- REMARKS:**
1. Emission level (dBuV/m) = Raw Value (dBuV) + Correction Factor (dB/m).
 2. Correction Factor (dB/m) = Antenna Factor (dB/m) + Cable Factor (dB).
 3. The other emission levels were very low against the limit.
 4. Margin value = Emission level – Limit value.
 5. “ * “: Fundamental frequency.



A D T

DRAFT 802.11n (20MHz) OFDM MODULATION

EUT TEST CONDITION		MEASUREMENT DETAIL	
CHANNEL	Channel 1	FREQUENCY RANGE	1 ~ 25GHz
INPUT POWER (SYSTEM)	120Vac, 60 Hz	DETECTOR FUNCTION	Peak (PK) Average (AV)
ENVIRONMENTAL CONDITIONS	20deg. C, 70%RH 1007hPa	TESTED BY	Match Tsui

ANTENNA POLARITY & TEST DISTANCE: HORIZONTAL AT 3 M								
NO.	FREQ. (MHz)	EMISSION LEVEL (dBuV/m)	LIMIT (dBuV/m)	MARGIN (dB)	ANTENNA HEIGHT (m)	TABLE ANGLE (Degree)	RAW VALUE (dBuV)	CORRECTION FACTOR (dB/m)
1	2390.00	57.76 PK	74.00	-16.24	1.36 H	248	24.68	33.08
2	2390.00	47.20 AV	54.00	-6.80	1.36 H	248	14.12	33.08
3	*2412.00	103.43 PK			1.36 H	248	70.25	33.18
4	*2412.00	93.19 AV			1.36 H	248	60.01	33.18
5	4824.00	49.99 PK	74.00	-24.01	1.00 H	360	10.84	39.15
6	4824.00	37.68 AV	54.00	-16.32	1.00 H	360	-1.47	39.15
ANTENNA POLARITY & TEST DISTANCE: VERTICAL AT 3 M								
NO.	FREQ. (MHz)	EMISSION LEVEL (dBuV/m)	LIMIT (dBuV/m)	MARGIN (dB)	ANTENNA HEIGHT (m)	TABLE ANGLE (Degree)	RAW VALUE (dBuV)	CORRECTION FACTOR (dB/m)
1	2390.00	57.75 PK	74.00	-16.25	1.11 V	213	24.67	33.08
2	2390.00	47.60 AV	54.00	-6.40	1.11 V	213	14.52	33.08
3	*2412.00	104.75 PK			1.11 V	213	71.57	33.18
4	*2412.00	94.67 AV			1.11 V	213	61.49	33.18
5	4824.00	53.96 PK	74.00	-20.04	1.00 V	218	14.81	39.15
6	4824.00	39.72 AV	54.00	-14.28	1.00 V	218	0.57	39.15

- REMARKS:**
1. Emission level (dBuV/m) = Raw Value (dBuV) + Correction Factor (dB/m).
 2. Correction Factor (dB/m) = Antenna Factor (dB/m) + Cable Factor (dB).
 3. The other emission levels were very low against the limit.
 4. Margin value = Emission level – Limit value.
 5. “ * “: Fundamental frequency.



A D T

EUT TEST CONDITION		MEASUREMENT DETAIL	
CHANNEL	Channel 6	FREQUENCY RANGE	1 ~ 25GHz
INPUT POWER (SYSTEM)	120Vac, 60 Hz	DETECTOR FUNCTION	Peak (PK) Average (AV)
ENVIRONMENTAL CONDITIONS	20deg. C, 70%RH 1007hPa	TESTED BY	Match Tsui

ANTENNA POLARITY & TEST DISTANCE: HORIZONTAL AT 3 M								
NO.	FREQ. (MHz)	EMISSION LEVEL (dBuV/m)	LIMIT (dBuV/m)	MARGIN (dB)	ANTENNA HEIGHT (m)	TABLE ANGLE (Degree)	RAW VALUE (dBuV)	CORRECTION FACTOR (dB/m)
1	*2437.00	103.84 PK			1.00 H	21	70.56	33.28
2	*2437.00	93.67 AV			1.00 H	21	60.39	33.28
3	4874.00	49.86 PK	74.00	-24.14	1.00 H	0	10.71	39.14
4	4874.00	37.54 AV	54.00	-16.46	1.00 H	0	-1.61	39.14
ANTENNA POLARITY & TEST DISTANCE: VERTICAL AT 3 M								
NO.	FREQ. (MHz)	EMISSION LEVEL (dBuV/m)	LIMIT (dBuV/m)	MARGIN (dB)	ANTENNA HEIGHT (m)	TABLE ANGLE (Degree)	RAW VALUE (dBuV)	CORRECTION FACTOR (dB/m)
1	*2437.00	105.16 PK			1.11 V	215	71.88	33.28
2	*2437.00	94.96 AV			1.11 V	215	61.68	33.28
3	4874.00	54.08 PK	74.00	-19.92	1.11 V	355	14.93	39.14
4	4874.00	39.86 AV	54.00	-14.14	1.11 V	355	0.71	39.14

- REMARKS:**
1. Emission level (dBuV/m) = Raw Value (dBuV) + Correction Factor (dB/m).
 2. Correction Factor (dB/m) = Antenna Factor (dB/m) + Cable Factor (dB).
 3. The other emission levels were very low against the limit.
 4. Margin value = Emission level – Limit value.
 5. “ * “: Fundamental frequency.



A D T

EUT TEST CONDITION		MEASUREMENT DETAIL	
CHANNEL	Channel 11	FREQUENCY RANGE	1 ~ 25GHz
INPUT POWER (SYSTEM)	120Vac, 60 Hz	DETECTOR FUNCTION	Peak (PK) Average (AV)
ENVIRONMENTAL CONDITIONS	20deg. C, 70%RH 1007hPa	TESTED BY	Match Tsui

ANTENNA POLARITY & TEST DISTANCE: HORIZONTAL AT 3 M								
NO.	FREQ. (MHz)	EMISSION LEVEL (dBuV/m)	LIMIT (dBuV/m)	MARGIN (dB)	ANTENNA HEIGHT (m)	TABLE ANGLE (Degree)	RAW VALUE (dBuV)	CORRECTION FACTOR (dB/m)
1	*2462.00	104.56 PK			1.19 H	218	71.18	33.38
2	*2462.00	94.14 AV			1.19 H	218	60.76	33.38
3	2483.50	57.31 PK	74.00	-16.69	1.19 H	218	23.85	33.46
4	2483.50	47.87 AV	54.00	-6.13	1.19 H	218	14.41	33.46
5	4924.00	49.89 PK	74.00	-24.11	1.00 H	360	10.53	39.35
6	4924.00	37.73 AV	54.00	-16.27	1.00 H	360	-1.63	39.35
ANTENNA POLARITY & TEST DISTANCE: VERTICAL AT 3 M								
NO.	FREQ. (MHz)	EMISSION LEVEL (dBuV/m)	LIMIT (dBuV/m)	MARGIN (dB)	ANTENNA HEIGHT (m)	TABLE ANGLE (Degree)	RAW VALUE (dBuV)	CORRECTION FACTOR (dB/m)
1	*2462.00	105.73 PK			1.11 V	219	72.35	33.38
2	*2462.00	95.37 AV			1.11 V	219	61.99	33.38
3	2483.50	58.56 PK	74.00	-15.44	1.11 V	219	25.10	33.46
4	2483.50	47.92 AV	54.00	-6.08	1.11 V	219	14.46	33.46
5	4924.00	54.32 PK	74.00	-19.68	1.11 V	200	14.96	39.35
6	4924.00	40.05 AV	54.00	-13.95	1.11 V	200	0.69	39.35

- REMARKS:**
1. Emission level (dBuV/m) = Raw Value (dBuV) + Correction Factor (dB/m).
 2. Correction Factor (dB/m) = Antenna Factor (dB/m) + Cable Factor (dB).
 3. The other emission levels were very low against the limit.
 4. Margin value = Emission level – Limit value.
 5. “ * “: Fundamental frequency.



A D T

DRAFT 802.11n (40MHz) OFDM MODULATION

EUT TEST CONDITION		MEASUREMENT DETAIL	
CHANNEL	Channel 1	FREQUENCY RANGE	1 ~ 25GHz
INPUT POWER (SYSTEM)	120Vac, 60 Hz	DETECTOR FUNCTION	Peak (PK) Average (AV)
ENVIRONMENTAL CONDITIONS	20deg. C, 70%RH 1007hPa	TESTED BY	Match Tsui

ANTENNA POLARITY & TEST DISTANCE: HORIZONTAL AT 3 M								
NO.	FREQ. (MHz)	EMISSION LEVEL (dBuV/m)	LIMIT (dBuV/m)	MARGIN (dB)	ANTENNA HEIGHT (m)	TABLE ANGLE (Degree)	RAW VALUE (dBuV)	CORRECTION FACTOR (dB/m)
1	2390.00	57.18 PK	74.00	-16.82	1.00 H	12	24.10	33.08
2	2390.00	47.01 AV	54.00	-6.99	1.00 H	12	13.93	33.08
3	*2422.00	101.08 PK			1.00 H	12	67.86	33.22
4	*2422.00	90.83 AV			1.00 H	12	57.61	33.22
5	4844.00	48.88 PK	74.00	-25.12	1.00 H	360	9.74	39.15
6	4844.00	36.88 AV	54.00	-17.12	1.00 H	360	-2.26	39.15
ANTENNA POLARITY & TEST DISTANCE: VERTICAL AT 3 M								
NO.	FREQ. (MHz)	EMISSION LEVEL (dBuV/m)	LIMIT (dBuV/m)	MARGIN (dB)	ANTENNA HEIGHT (m)	TABLE ANGLE (Degree)	RAW VALUE (dBuV)	CORRECTION FACTOR (dB/m)
1	2390.00	59.45 PK	74.00	-14.55	1.09 V	251	26.37	33.08
2	2390.00	47.67 AV	54.00	-6.33	1.09 V	251	14.59	33.08
3	*2422.00	101.80 PK			1.09 V	251	68.58	33.22
4	*2422.00	92.06 AV			1.09 V	251	58.84	33.22
5	4844.00	49.67 PK	74.00	-24.33	1.29 V	178	10.53	39.15
6	4844.00	37.59 AV	54.00	-16.41	1.29 V	178	-1.55	39.15

- REMARKS:**
1. Emission level (dBuV/m) = Raw Value (dBuV) + Correction Factor (dB/m).
 2. Correction Factor (dB/m) = Antenna Factor (dB/m) + Cable Factor (dB).
 3. The other emission levels were very low against the limit.
 4. Margin value = Emission level – Limit value.
 5. “ * “: Fundamental frequency.



A D T

EUT TEST CONDITION		MEASUREMENT DETAIL	
CHANNEL	Channel 4	FREQUENCY RANGE	1 ~ 25GHz
INPUT POWER (SYSTEM)	120Vac, 60 Hz	DETECTOR FUNCTION	Peak (PK) Average (AV)
ENVIRONMENTAL CONDITIONS	20deg. C, 70%RH 1007hPa	TESTED BY	Match Tsui

ANTENNA POLARITY & TEST DISTANCE: HORIZONTAL AT 3 M								
NO.	FREQ. (MHz)	EMISSION LEVEL (dBuV/m)	LIMIT (dBuV/m)	MARGIN (dB)	ANTENNA HEIGHT (m)	TABLE ANGLE (Degree)	RAW VALUE (dBuV)	CORRECTION FACTOR (dB/m)
1	*2437.00	101.32 PK			1.00 H	196	68.04	33.28
2	*2437.00	91.26 AV			1.00 H	196	57.98	33.28
3	4874.00	49.33 PK	74.00	-24.67	1.30 H	360	10.18	39.14
4	4874.00	37.30 AV	54.00	-16.70	1.30 H	360	-1.85	39.14
ANTENNA POLARITY & TEST DISTANCE: VERTICAL AT 3 M								
NO.	FREQ. (MHz)	EMISSION LEVEL (dBuV/m)	LIMIT (dBuV/m)	MARGIN (dB)	ANTENNA HEIGHT (m)	TABLE ANGLE (Degree)	RAW VALUE (dBuV)	CORRECTION FACTOR (dB/m)
1	*2437.00	102.16 PK			1.41 V	46	68.88	33.28
2	*2437.00	92.45 AV			1.41 V	46	59.17	33.28
3	4874.00	49.73 PK	74.00	-24.27	1.41 V	360	10.58	39.14
4	4874.00	37.74 AV	54.00	-16.26	1.41 V	360	-1.41	39.14

- REMARKS:**
1. Emission level (dBuV/m) = Raw Value (dBuV) + Correction Factor (dB/m).
 2. Correction Factor (dB/m) = Antenna Factor (dB/m) + Cable Factor (dB).
 3. The other emission levels were very low against the limit.
 4. Margin value = Emission level – Limit value.
 5. “ * “: Fundamental frequency.



A D T

EUT TEST CONDITION		MEASUREMENT DETAIL	
CHANNEL	Channel 7	FREQUENCY RANGE	1 ~ 25GHz
INPUT POWER (SYSTEM)	120Vac, 60 Hz	DETECTOR FUNCTION	Peak (PK) Average (AV)
ENVIRONMENTAL CONDITIONS	20deg. C, 70%RH 1007hPa	TESTED BY	Match Tsui

ANTENNA POLARITY & TEST DISTANCE: HORIZONTAL AT 3 M								
NO.	FREQ. (MHz)	EMISSION LEVEL (dBuV/m)	LIMIT (dBuV/m)	MARGIN (dB)	ANTENNA HEIGHT (m)	TABLE ANGLE (Degree)	RAW VALUE (dBuV)	CORRECTION FACTOR (dB/m)
1	*2452.00	101.64 PK			1.00 H	209	68.30	33.34
2	*2452.00	91.66 AV			1.00 H	209	58.32	33.34
3	2483.50	58.35 PK	74.00	-15.65	1.00 H	209	24.89	33.46
4	2483.50	47.85 AV	54.00	-6.15	1.00 H	209	14.39	33.46
5	4904.00	49.37 PK	74.00	-24.63	1.00 H	0	10.19	39.18
6	4904.00	36.53 AV	54.00	-17.47	1.00 H	0	-2.65	39.18
ANTENNA POLARITY & TEST DISTANCE: VERTICAL AT 3 M								
NO.	FREQ. (MHz)	EMISSION LEVEL (dBuV/m)	LIMIT (dBuV/m)	MARGIN (dB)	ANTENNA HEIGHT (m)	TABLE ANGLE (Degree)	RAW VALUE (dBuV)	CORRECTION FACTOR (dB/m)
1	*2452.00	102.57 PK			1.09 V	102	69.23	33.34
2	*2452.00	92.75 AV			1.09 V	102	59.41	33.34
3	2483.50	60.48 PK	74.00	-13.52	1.09 V	102	27.02	33.46
4	2483.50	48.41 AV	54.00	-5.59	1.09 V	102	14.95	33.46
5	4904.00	50.08 PK	74.00	-23.92	1.09 V	222	10.90	39.18
6	4904.00	37.72 AV	54.00	-16.28	1.09 V	222	-1.46	39.18

- REMARKS:**
1. Emission level (dBuV/m) = Raw Value (dBuV) + Correction Factor (dB/m).
 2. Correction Factor (dB/m) = Antenna Factor (dB/m) + Cable Factor (dB).
 3. The other emission levels were very low against the limit.
 4. Margin value = Emission level – Limit value.
 5. “ * “: Fundamental frequency.



A D T

BELOW 1GHz WORST-CASE DATA : DRAFT 802.11n (40MHz) OFDM MODULATION

EUT TEST CONDITION		MEASUREMENT DETAIL	
CHANNEL	Channel 4	FREQUENCY RANGE	Below 1000MHz
INPUT POWER (SYSTEM)	120Vac, 60 Hz	DETECTOR FUNCTION	Quasi-Peak
ENVIRONMENTAL CONDITIONS	20deg. C, 70%RH 1007hPa	TESTED BY	Match Tsui

ANTENNA POLARITY & TEST DISTANCE: HORIZONTAL AT 3 M								
NO.	FREQ. (MHz)	EMISSION LEVEL (dBuV/m)	LIMIT (dBuV/m)	MARGIN (dB)	ANTENNA HEIGHT (m)	TABLE ANGLE (Degree)	RAW VALUE (dBuV)	CORRECTION FACTOR (dB/m)
1	166.00	36.80 QP	43.50	-6.70	1.50 H	67	23.54	13.25
2	401.26	33.34 QP	46.00	-12.66	2.00 H	34	17.24	16.10
3	531.53	33.64 QP	46.00	-12.36	1.50 H	208	13.44	20.20
4	599.58	32.50 QP	46.00	-13.50	1.50 H	187	10.60	21.90
5	665.68	33.07 QP	46.00	-12.93	1.00 H	241	10.62	22.45
6	840.67	35.24 QP	46.00	-10.76	1.00 H	10	9.67	25.57
ANTENNA POLARITY & TEST DISTANCE: VERTICAL AT 3 M								
NO.	FREQ. (MHz)	EMISSION LEVEL (dBuV/m)	LIMIT (dBuV/m)	MARGIN (dB)	ANTENNA HEIGHT (m)	TABLE ANGLE (Degree)	RAW VALUE (dBuV)	CORRECTION FACTOR (dB/m)
1	57.12	33.76 QP	40.00	-6.24	1.00 V	49	20.28	13.48
2	90.17	32.52 QP	43.50	-10.98	1.00 V	286	23.30	9.22
3	96.01	34.11 QP	43.50	-9.39	1.00 V	160	24.82	9.29
4	144.61	32.64 QP	43.50	-10.86	2.50 V	316	19.47	13.16
5	187.39	30.53 QP	43.50	-12.97	1.00 V	10	18.92	11.61
6	533.47	36.25 QP	46.00	-9.75	1.00 V	301	15.99	20.26
7	840.67	35.52 QP	46.00	-10.48	2.00 V	37	9.94	25.57
8	933.99	36.80 QP	46.00	-9.20	1.25 V	43	10.43	26.37
9	961.21	41.61 QP	54.00	-12.39	1.25 V	322	15.07	26.54

- REMARKS:**
1. Emission level (dBuV/m) = Raw Value (dBuV) + Correction Factor (dB/m).
 2. Correction Factor (dB/m) = Antenna Factor (dB/m) + Cable Factor (dB).
 3. The other emission levels were very low against the limit.
 4. Margin value = Emission level – Limit value.



4.2 CONDUCTED EMISSION MEASUREMENT

4.2.1 LIMITS OF CONDUCTED EMISSION MEASUREMENT

FREQUENCY OF EMISSION (MHz)	CONDUCTED LIMIT (dBµV)	
	Quasi-peak	Average
0.15 ~ 0.5	66 to 56	56 to 46
0.5 ~ 5	56	46
5 ~ 30	60	50

- NOTE:**
1. The lower limit shall apply at the transition frequencies.
 2. The limit decreases in line with the logarithm of the frequency in the range of 0.15 to 0.50MHz.
 3. All emanations from a class A/B digital device or system, including any network of conductors and apparatus connected thereto, shall not exceed the level of field strengths specified above.

4.2.2 TEST INSTRUMENTS

DESCRIPTION & MANUFACTURER	MODEL NO.	SERIAL NO.	DATE OF CALIBRATION	DUE DATE OF CALIBRATION
Test Receiver ROHDE & SCHWARZ	ESCS30	100291	Nov. 19, 2008	Nov. 18, 2009
RF signal cable Woken	5D-FB	Cable-HYC01-01	Dec. 31, 2008	Dec. 30, 2009
LISN ROHDE & SCHWARZ	ESH3-Z5	100312	Jun. 13, 2008	Jun. 12, 2009
LISN ROHDE & SCHWARZ	ESH2-Z5	100104	Dec. 04, 2008	Dec. 03, 2009
Software ADT	ADT_Cond_ V7.3.7	NA	NA	NA

- NOTE:**
1. The calibration interval of the above test instruments is 12 months and the calibrations are traceable to NML/ROC and NIST/USA.
 2. The test was performed in HwaYa Shielded Room 1.
 3. The VCCI Site Registration No. is C-2040.



A D T

4.2.3 TEST PROCEDURES

- a. The EUT was placed 0.4 meters from the conducting wall of the shielded room with EUT being connected to the power mains through a line impedance stabilization network (LISN). Other support units were connected to the power mains through another LISN. The two LISNs provide 50 ohm/ 50uH of coupling impedance for the measuring instrument.
- b. Both lines of the power mains connected to the EUT were checked for maximum conducted interference.
- c. The frequency range from 150kHz to 30MHz was searched. Emission levels under (Limit - 20dB) was not recorded.

NOTE: All modes of operation were investigated and the worst-case emissions are reported.

4.2.4 DEVIATION FROM TEST STANDARD

No deviation.

4.2.5 TEST SETUP

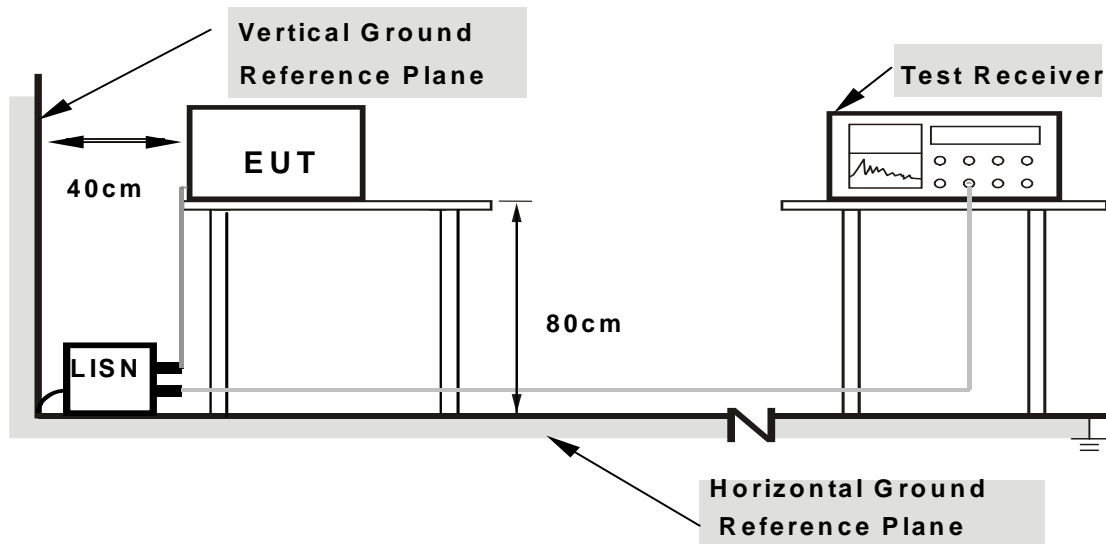

- Note:**
1. Support units were connected to second LISN.
 2. Both of LISNs (AMN) are 80 cm from EUT and at least 80 from other units and other metal planes

For the actual test configuration, please refer to the attached file (Test Setup Photo).

4.2.6 EUT OPERATING CONDITIONS

Same as 4.1.6.

4.2.7 TEST RESULTS

CONDUCTED WORST-CASE DATA : DRAFT 802.11n (40MHz) OFDM MODULATION

EUT TEST CONDITION		MEASUREMENT DETAIL	
CHANNEL	Channel 4	PHASE	Line 1
MODULATION TYPE	BPSK	INPUT POWER	120Vac, 60Hz
TRANSFER RATE	13.5Mbps	6dB BANDWIDTH	9kHz
ENVIRONMENTAL CONDITIONS	25deg. C, 65%RH, 1016hPa	TESTED BY	Lori Chiu

No	Freq. [MHz]	Corr. Factor (dB)	Reading Value [dB (uV)]		Emission Level [dB (uV)]		Limit [dB (uV)]		Margin (dB)	
			Q.P.	AV.	Q.P.	AV.	Q.P.	AV.	Q.P.	AV.
1	0.154	0.13	49.07	-	49.20	-	65.79	55.79	-16.59	-
2	0.177	0.13	45.40	-	45.53	-	64.61	54.61	-19.08	-
3	0.291	0.13	40.18	-	40.31	-	60.51	50.51	-20.19	-
4	1.789	0.22	40.24	-	40.46	-	56.00	46.00	-15.54	-
5	3.809	0.36	36.36	-	36.72	-	56.00	46.00	-19.28	-
6	10.289	0.67	26.80	-	27.47	-	60.00	50.00	-32.53	-

- REMARKS:**
1. Q.P. and AV. are abbreviations of quasi-peak and average individually.
 2. "-": The Quasi-peak reading value also meets average limit and measurement with the average detector is unnecessary.
 3. The emission levels of other frequencies were very low against the limit.
 4. Margin value = Emission level - Limit value
 5. Correction factor = Insertion loss + Cable loss
 6. Emission Level = Correction Factor + Reading Value.

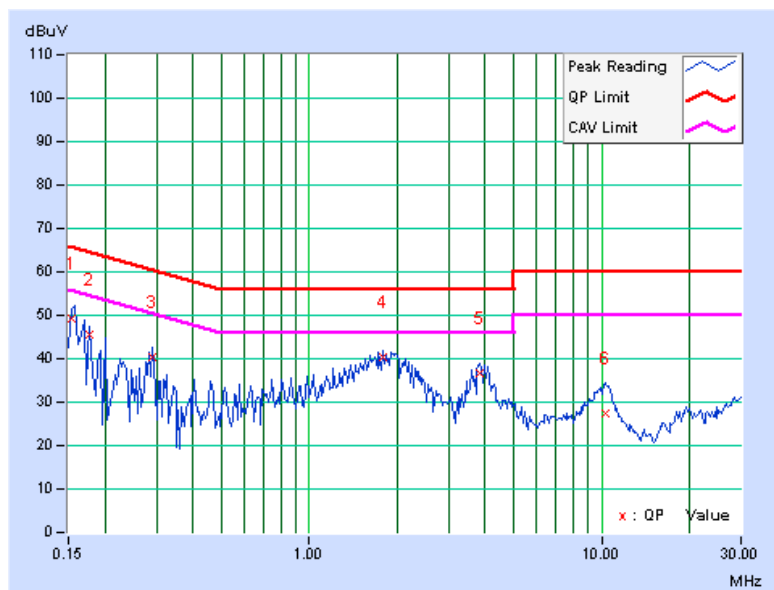



A D T

EUT TEST CONDITION		MEASUREMENT DETAIL	
CHANNEL	Channel 4	PHASE	Line 2
MODULATION TYPE	BPSK	INPUT POWER (SYSTEM)	120Vac, 60Hz
TRANSFER RATE	13.5Mbps	6dB BANDWIDTH	9kHz
ENVIRONMENTAL CONDITIONS	25deg. C, 65%RH, 1016hPa	TESTED BY	Lori Chiu

No	Freq. [MHz]	Corr. Factor [dB]	Reading Value [dB (uV)]		Emission Level [dB (uV)]		Limit [dB (uV)]		Margin (dB)	
			Q.P.	AV.	Q.P.	AV.	Q.P.	AV.	Q.P.	AV.
1	0.154	0.14	49.47	-	49.61	-	65.79	55.79	-16.18	-
2	0.170	0.14	47.60	-	47.74	-	64.98	54.98	-17.24	-
3	0.232	0.15	42.75	-	42.90	-	62.38	52.38	-19.48	-
4	1.852	0.24	38.25	-	38.49	-	56.00	46.00	-17.51	-
5	3.926	0.38	36.70	-	37.08	-	56.00	46.00	-18.92	-
6	10.246	0.67	33.28	-	33.95	-	60.00	50.00	-26.05	-

- REMARKS:**
1. Q.P. and AV. are abbreviations of quasi-peak and average individually.
 2. "-": The Quasi-peak reading value also meets average limit and measurement with the average detector is unnecessary.
 3. The emission levels of other frequencies were very low against the limit.
 4. Margin value = Emission level - Limit value
 5. Correction factor = Insertion loss + Cable loss
 6. Emission Level = Correction Factor + Reading Value.

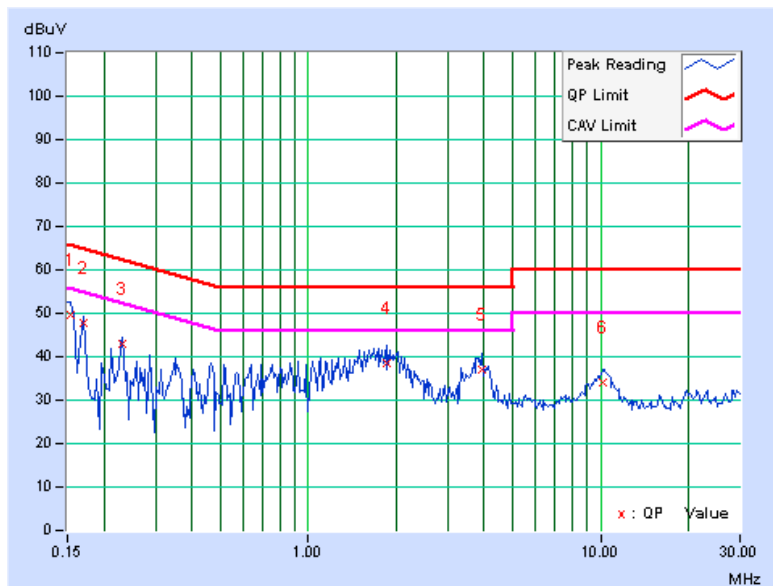



A D T

4.3 6dB BANDWIDTH MEASUREMENT

4.3.1 LIMITS OF 6dB BANDWIDTH MEASUREMENT

The minimum of 6dB Bandwidth Measurement is 0.5 MHz.

4.3.2 TEST INSTRUMENTS

DESCRIPTION & MANUFACTURER	MODEL NO.	SERIAL NO.	DATE OF CALIBRATION	DUE DATE OF CALIBRATION
R&S SPECTRUM ANALYZER	FSP40	100040	Jul. 04, 2008	Jul. 03, 2009

NOTE: The calibration interval of the above test instruments is 12 months and the calibrations are traceable to NML/ROC and NIST/USA.

4.3.3 TEST PROCEDURE

The transmitter output was connected to the spectrum analyzer through an attenuator. The bandwidth of the fundamental frequency was measured by spectrum analyzer with 100kHz RBW and 300kHz VBW. The 6dB bandwidth is defined as the total spectrum the power of which is higher than peak power minus 6dB.

4.3.4 DEVIATION FROM TEST STANDARD

No deviation.

4.3.5 TEST SETUP

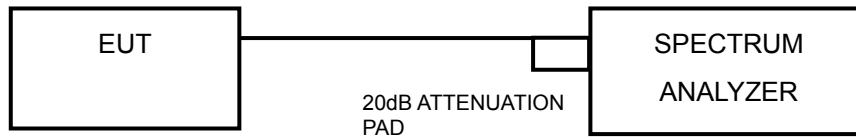

4.3.6 EUT OPERATING CONDITIONS

The software provided by client to enable the EUT under transmission condition continuously at lowest, middle and highest channel frequencies individually.



A D T

4.3.7 TEST RESULTS

802.11b DSSS MODULATION

MODULATION TYPE	DBPSK	TRANSFER RATE	1.0Mbps
INPUT POWER (SYSTEM)	120Vac, 60Hz	ENVIRONMENTAL CONDITIONS	25 deg.C, 65 %RH, 1016hPa
TESTED BY	Brad Wu		

CHANNEL	CHANNEL FREQUENCY (MHz)	6dB BANDWIDTH (MHz)	MINIMUM LIMIT (MHz)	PASS / FAIL
1	2412	12.04	0.5	PASS
6	2437	12.13	0.5	PASS
11	2462	12.11	0.5	PASS



A D T

CH 1

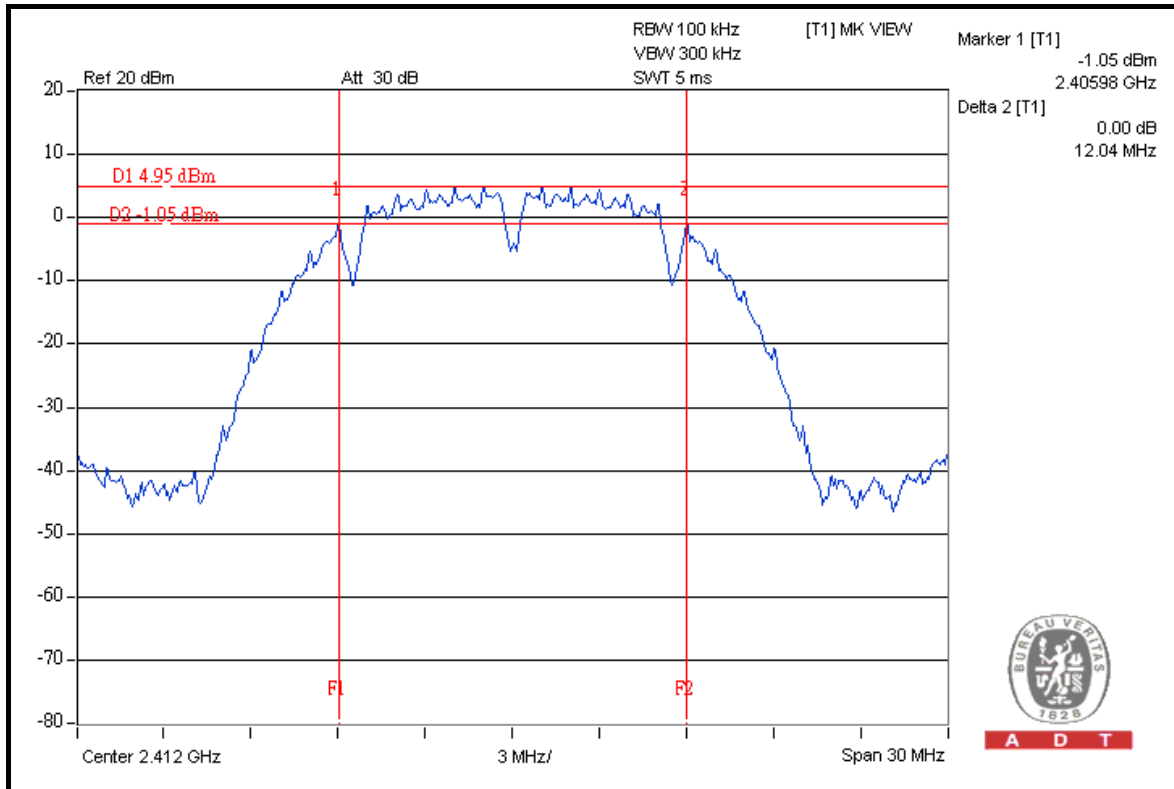

CH 6

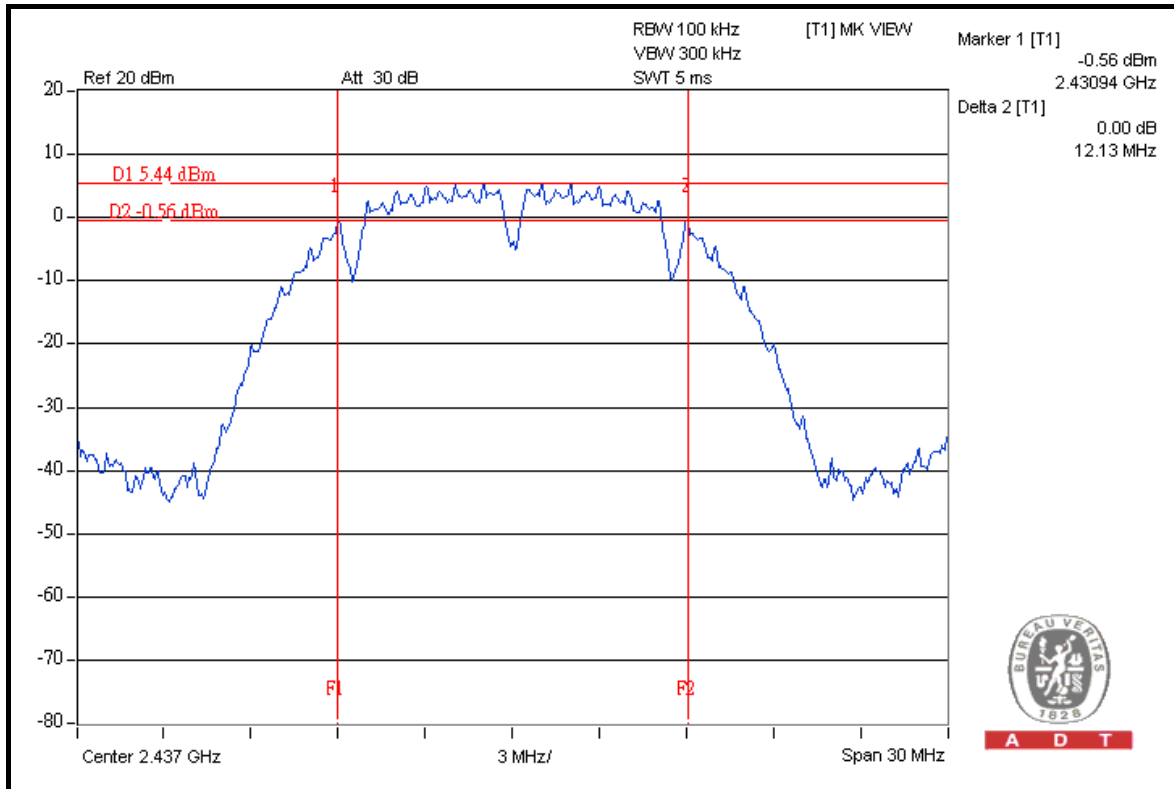



A D T

CH 11

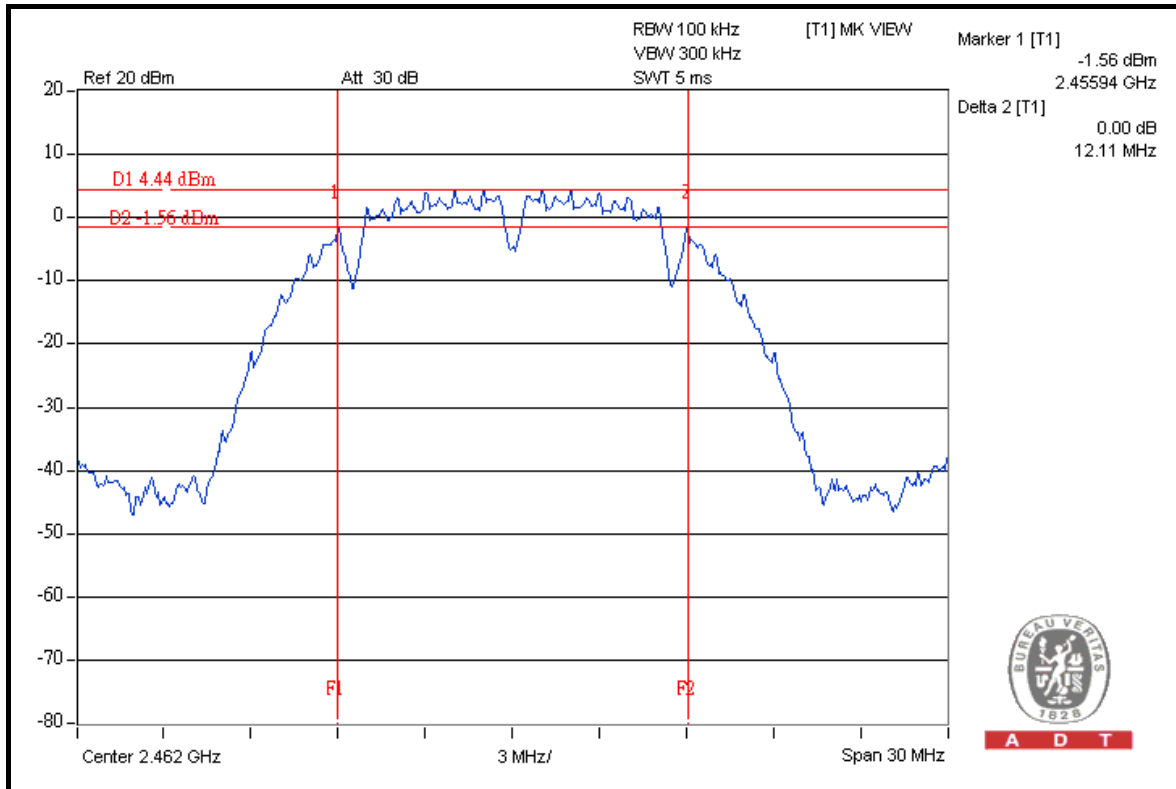



A D T

802.11g OFDM MODULATION

MODULATION TYPE	BPSK	TRANSFER RATE	6.0Mbps
INPUT POWER (SYSTEM)	120Vac, 60Hz	ENVIRONMENTAL CONDITIONS	25 deg.C, 65 %RH, 1016hPa
TESTED BY	Brad Wu		

CHANNEL	CHANNEL FREQUENCY (MHz)	6dB BANDWIDTH (MHz)	MINIMUM LIMIT (MHz)	PASS / FAIL
1	2412	16.54	0.5	PASS
6	2437	16.52	0.5	PASS
11	2462	16.53	0.5	PASS



A D T

CH 1

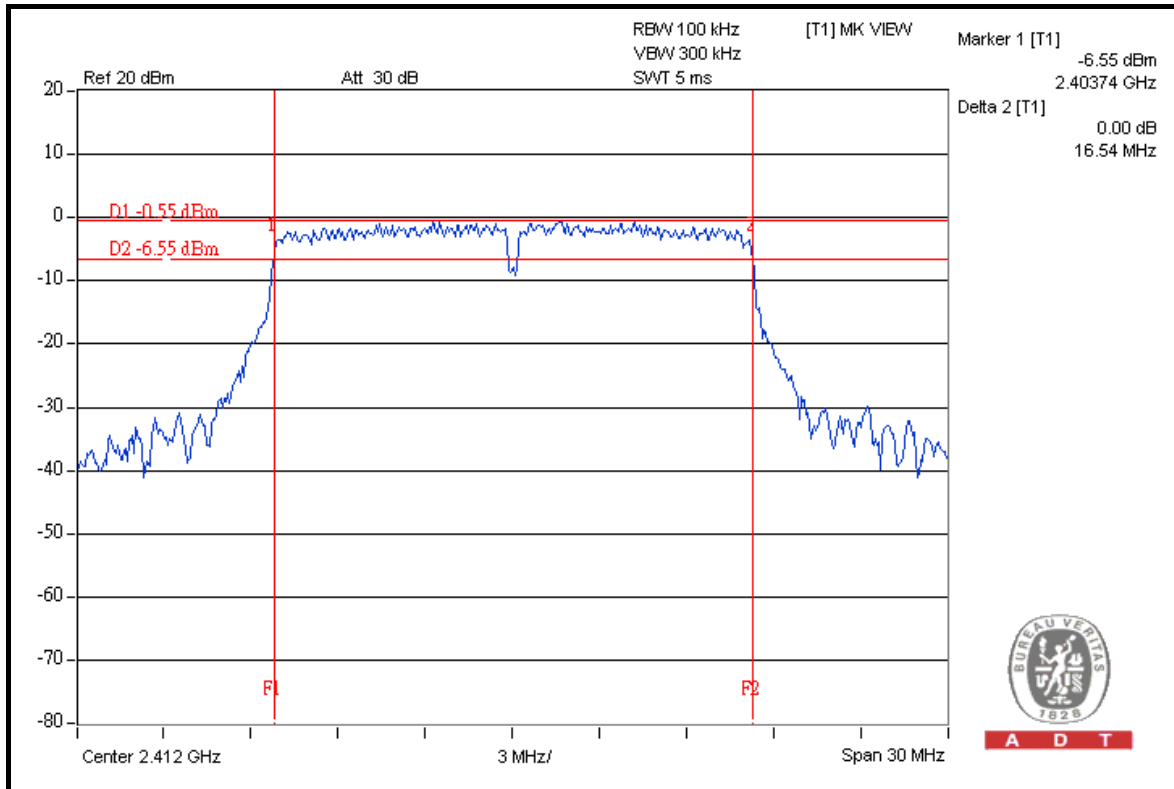

CH 6

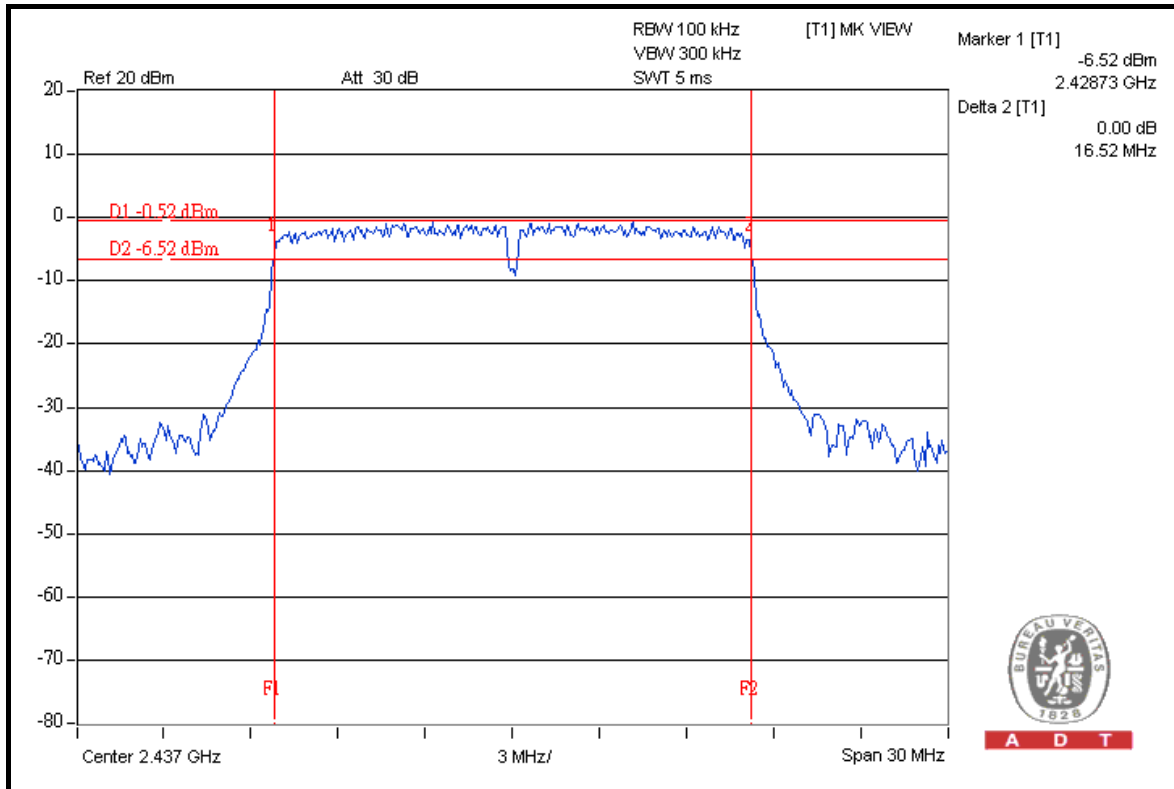



A D T

CH 11

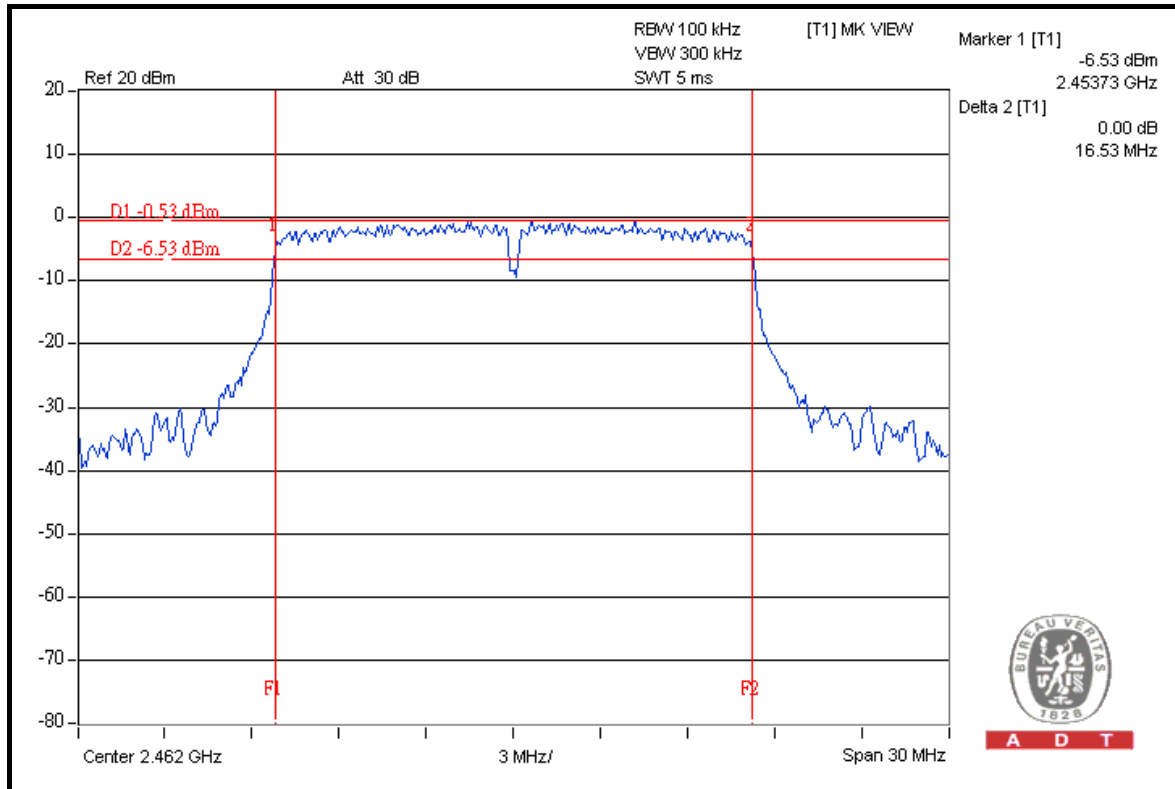



A D T

DRAFT 802.11n (20MHz) OFDM MODULATION

MODULATION TYPE	BPSK	TRANSFER RATE	6.5Mbps
INPUT POWER (SYSTEM)	120Vac, 60Hz	ENVIRONMENTAL CONDITIONS	25 deg.C, 65 %RH, 1016hPa
TESTED BY	Brad Wu		

CHANNEL	CHANNEL FREQUENCY (MHz)	6dB BANDWIDTH (MHz)		MINIMUM LIMIT (MHz)	PASS / FAIL
		CHAIN 0	CHAIN 1		
1	2412	17.04	17.48	0.5	PASS
6	2437	17.70	17.10	0.5	PASS
11	2462	17.66	17.67	0.5	PASS



A D T

FOR CHAIN 0: CH 1

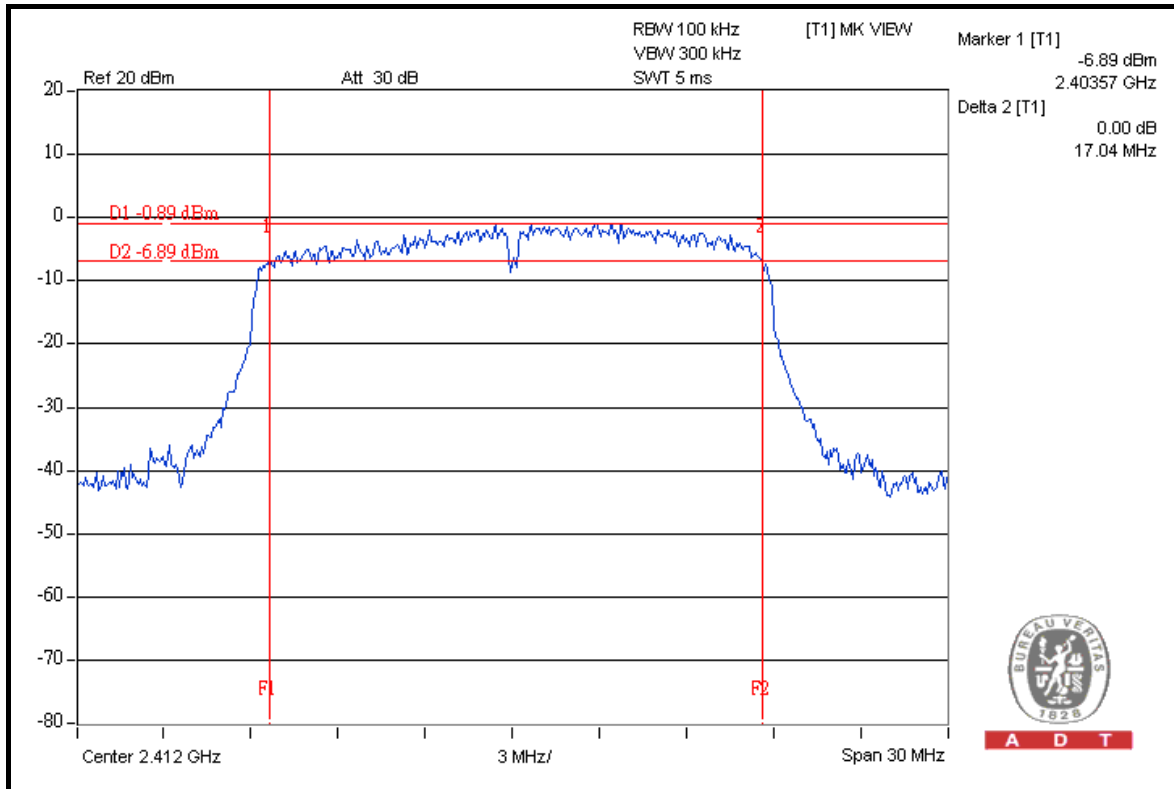

CH 6

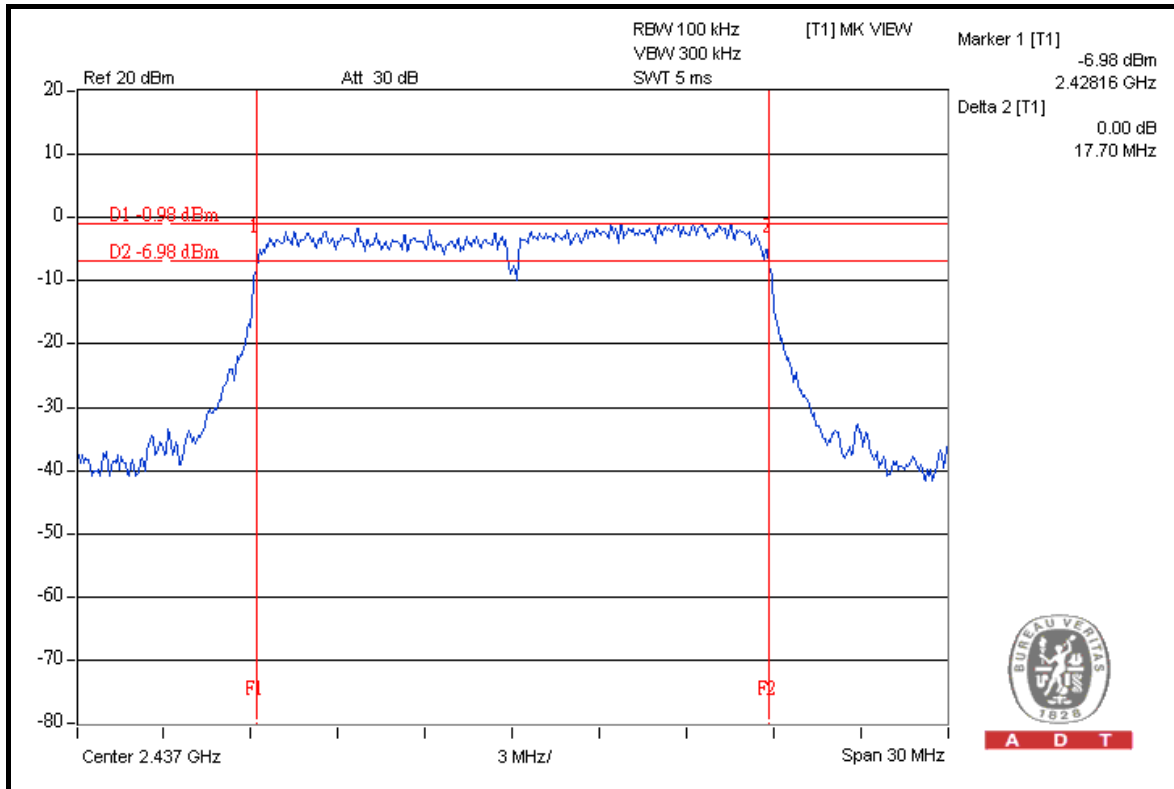



A D T

CH 11

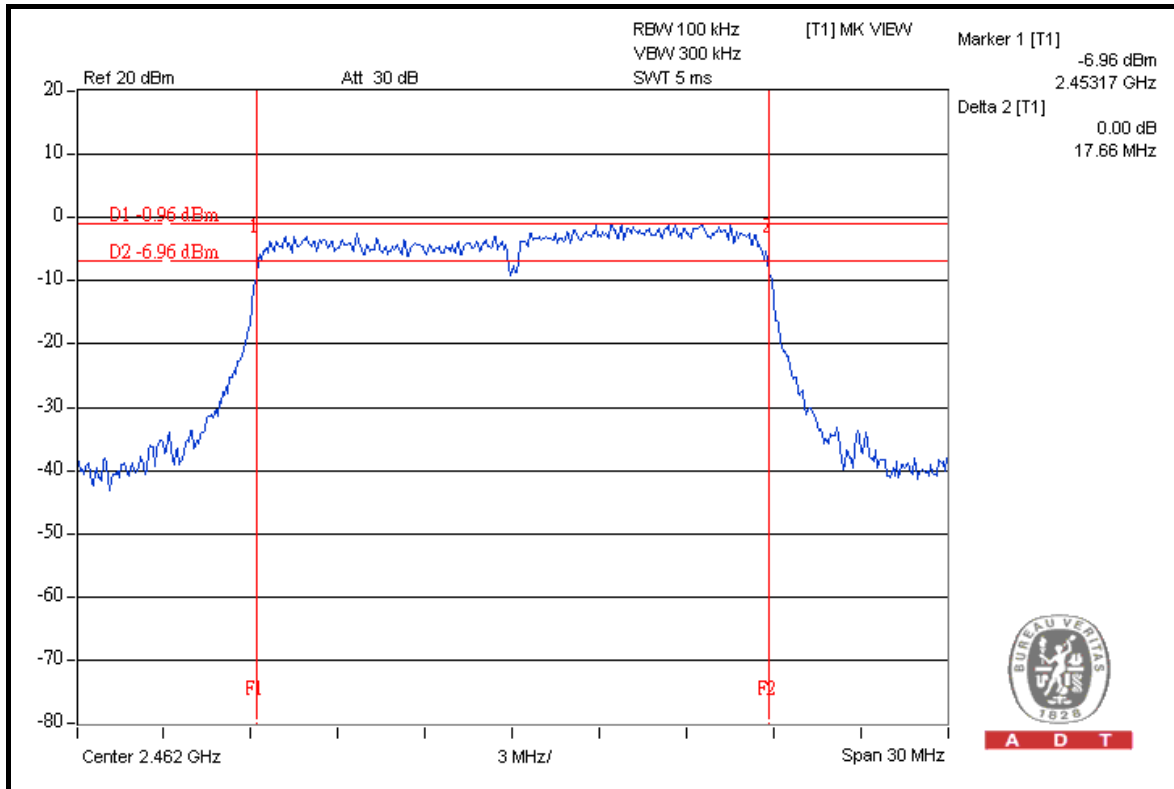

FOR CHAIN 1: CH 1

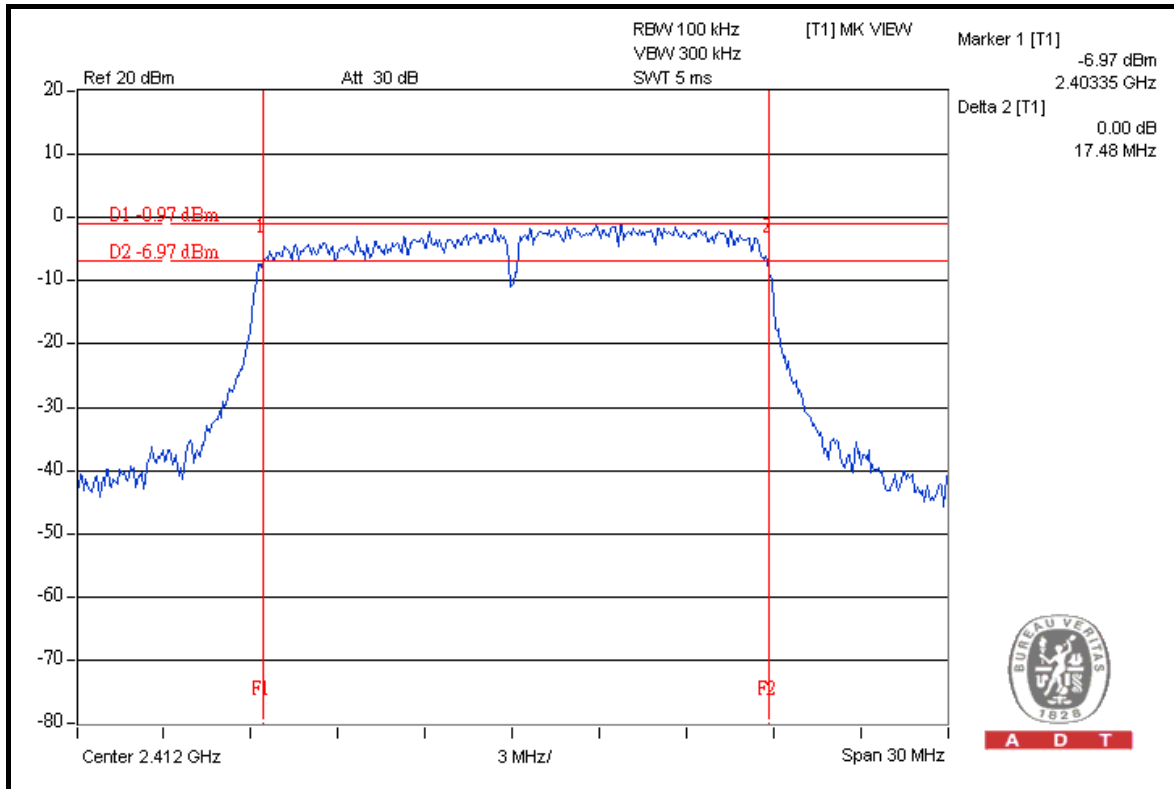



A D T

CH 6

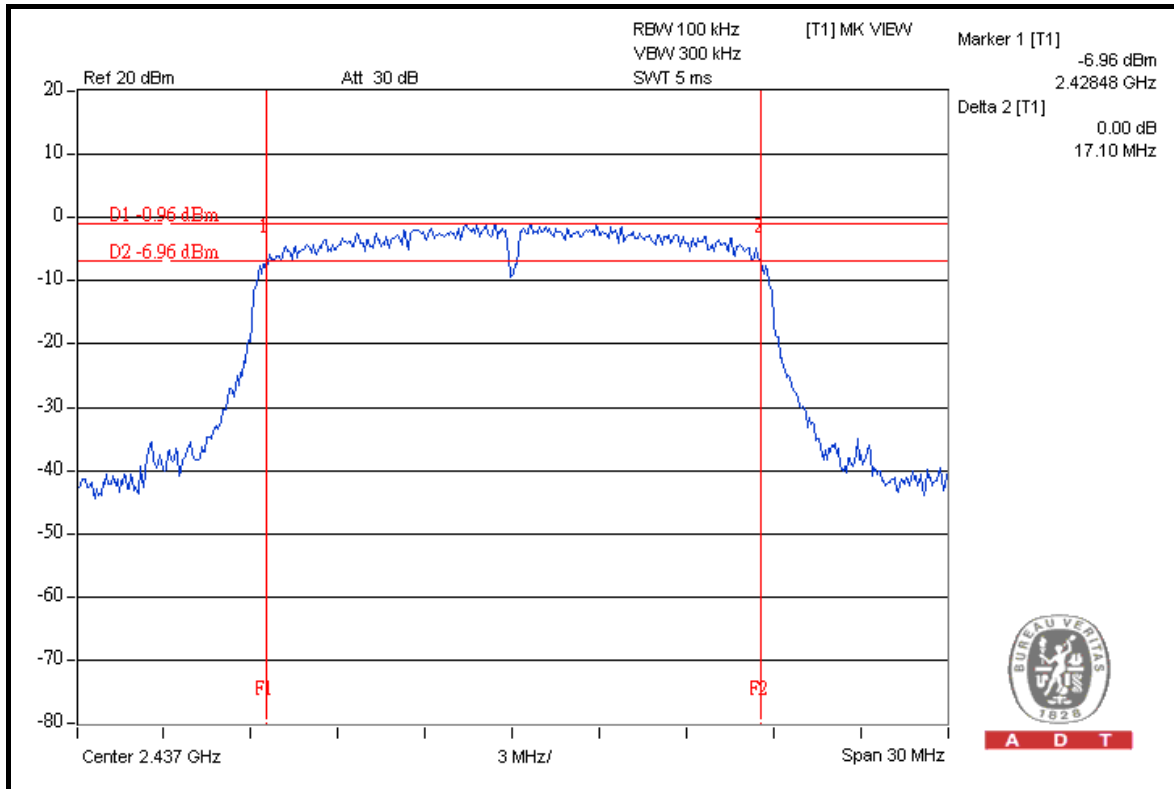

CH 11

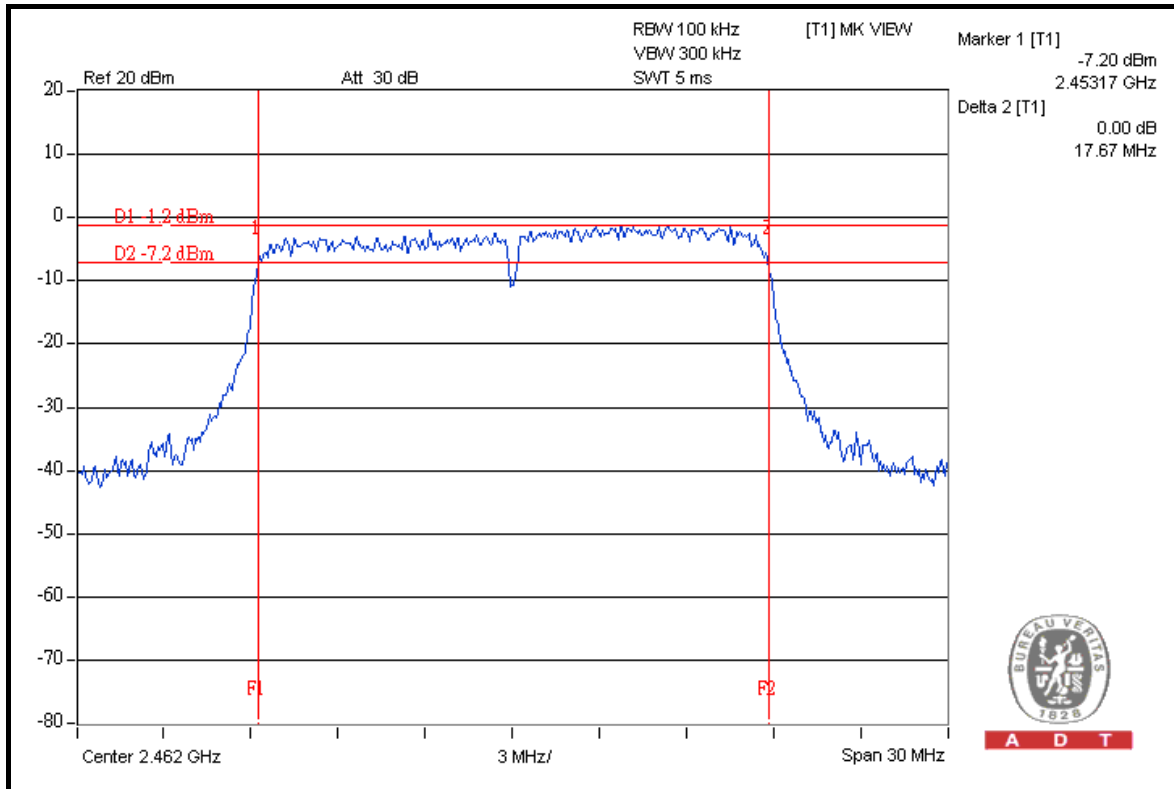



A D T

DRAFT 802.11n (40MHz) OFDM MODULATION

MODULATION TYPE	BPSK	TRANSFER RATE	13.5Mbps
INPUT POWER (SYSTEM)	120Vac, 60Hz	ENVIRONMENTAL CONDITIONS	25 deg.C, 65 %RH, 1016hPa
TESTED BY	Brad Wu		

CHANNEL	CHANNEL FREQUENCY (MHz)	6dB BANDWIDTH (MHz)		MINIMUM LIMIT (MHz)	PASS / FAIL
		CHAIN 0	CHAIN 1		
1	2422	36.47	35.81	0.5	PASS
4	2437	35.56	36.44	0.5	PASS
7	2452	36.36	36.45	0.5	PASS



A D T

FOR CHAIN 0: CH 1

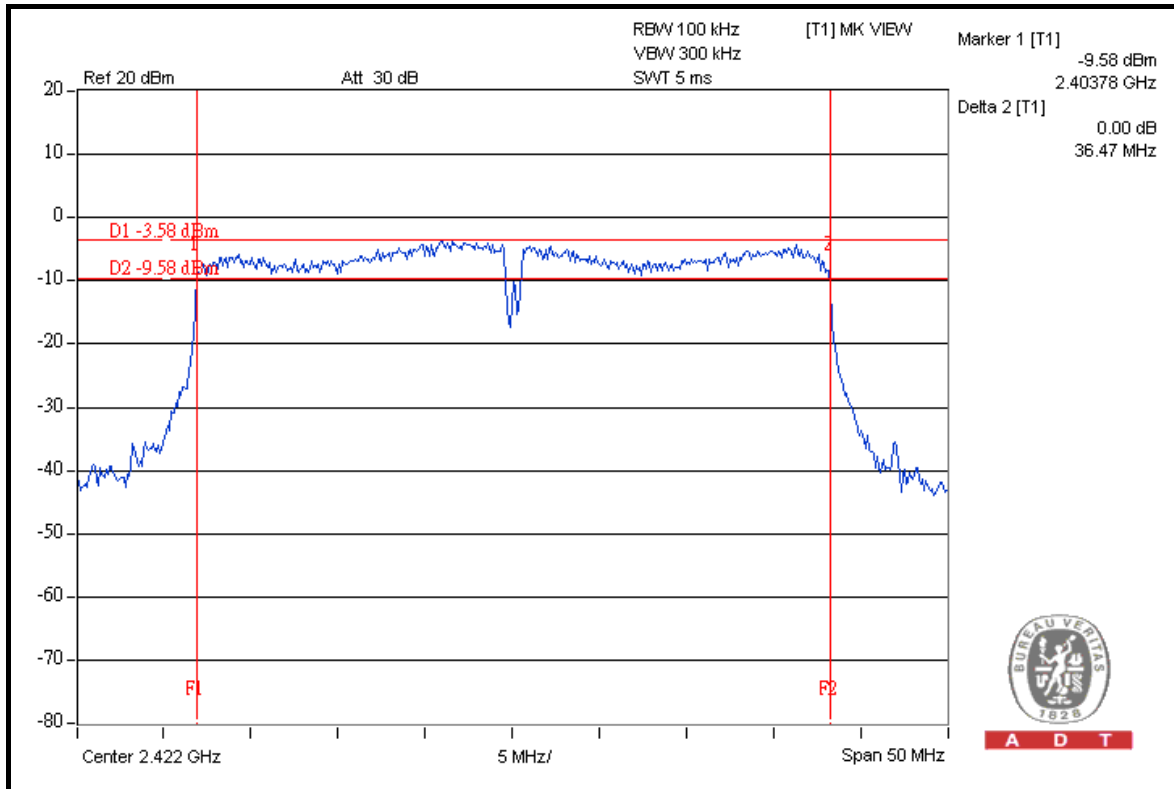

CH 4

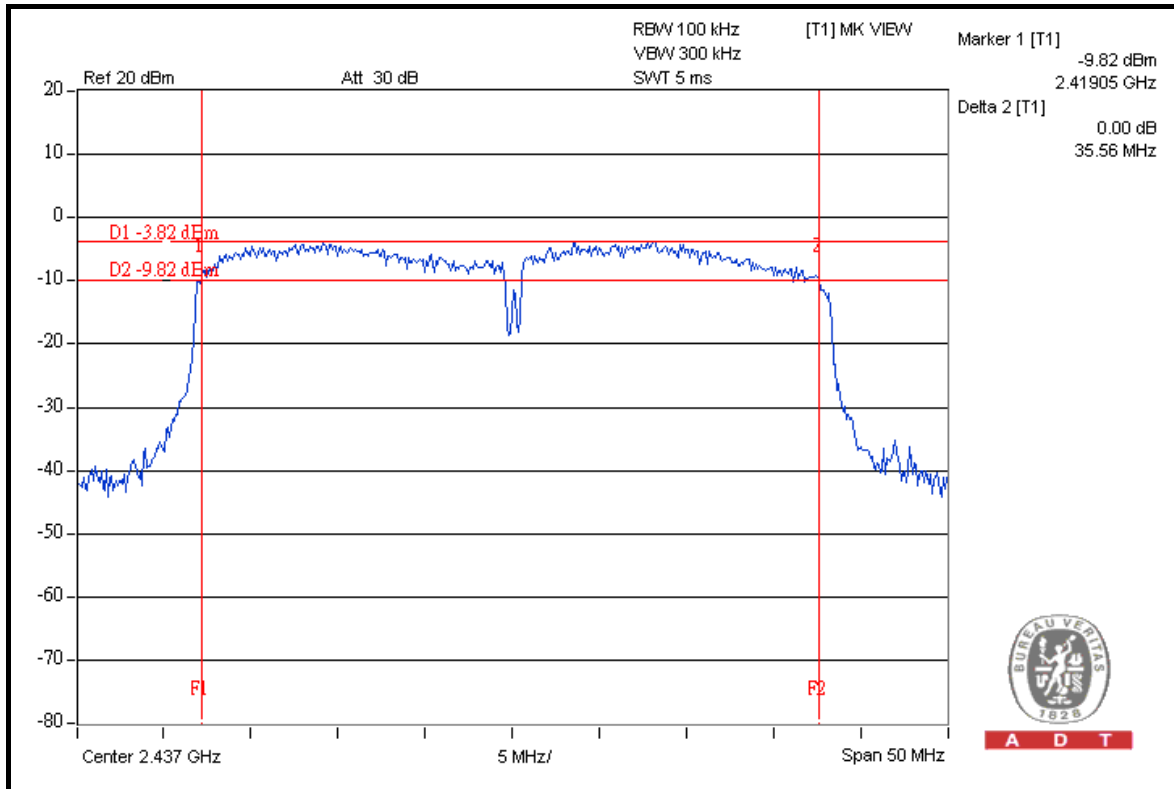



A D T

CH 7

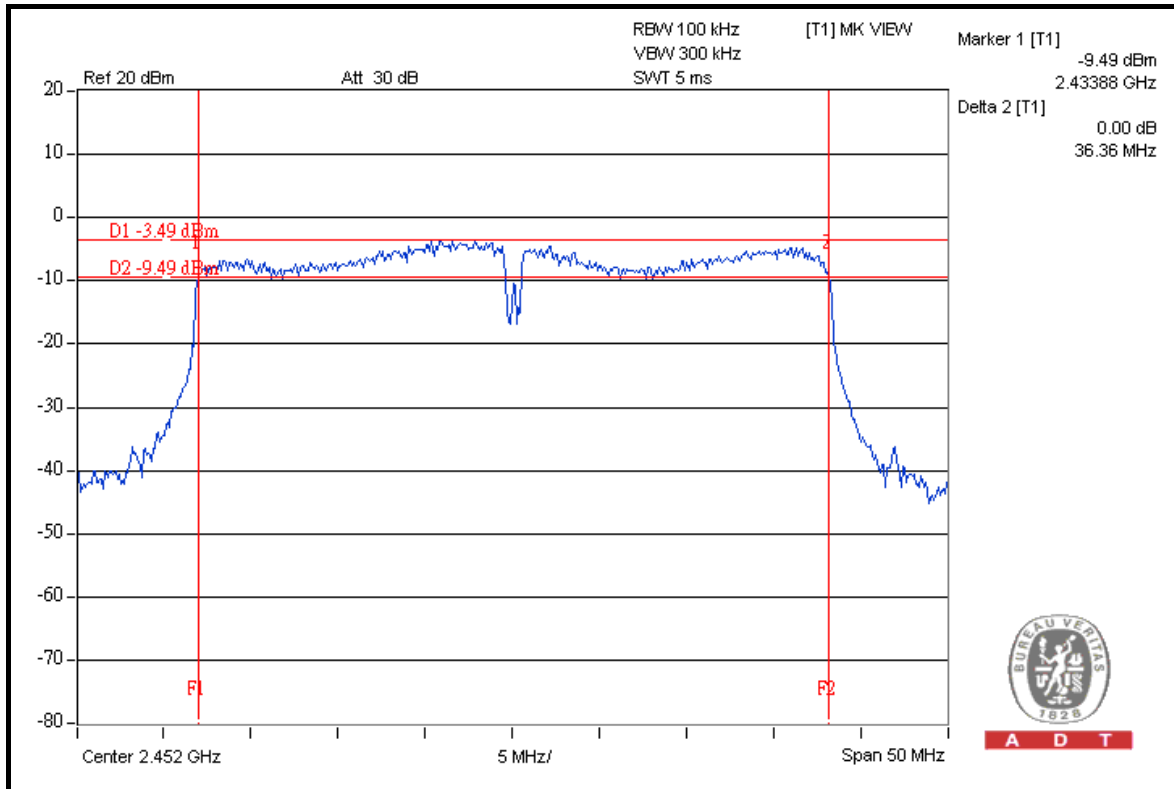

A D T

FOR CHAIN 1: CH 1

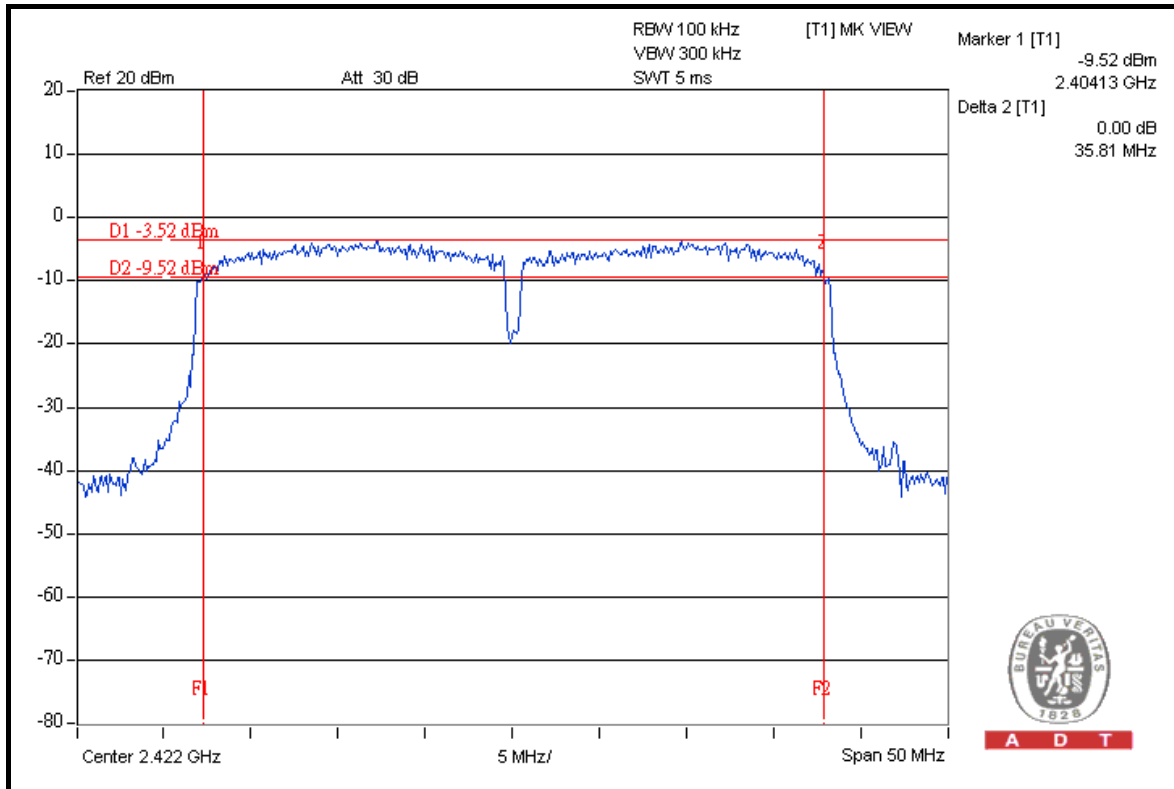

A D T



A D T

CH 4

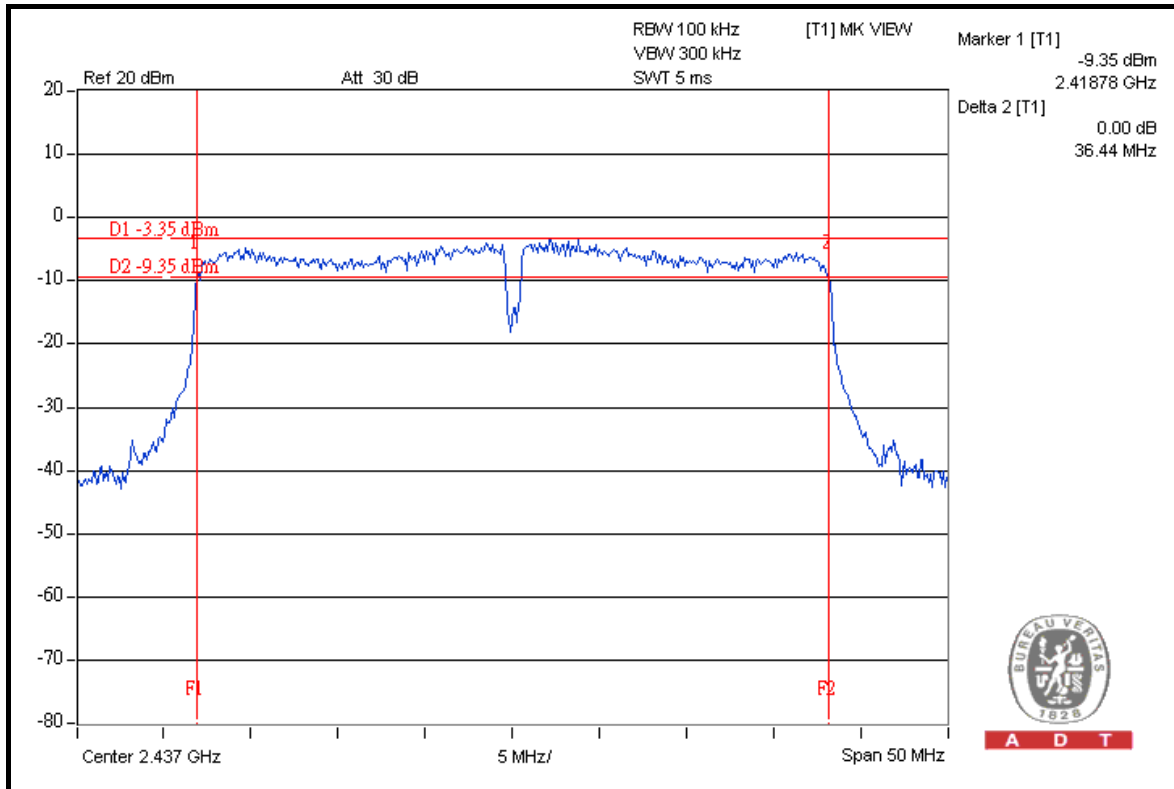

CH 7

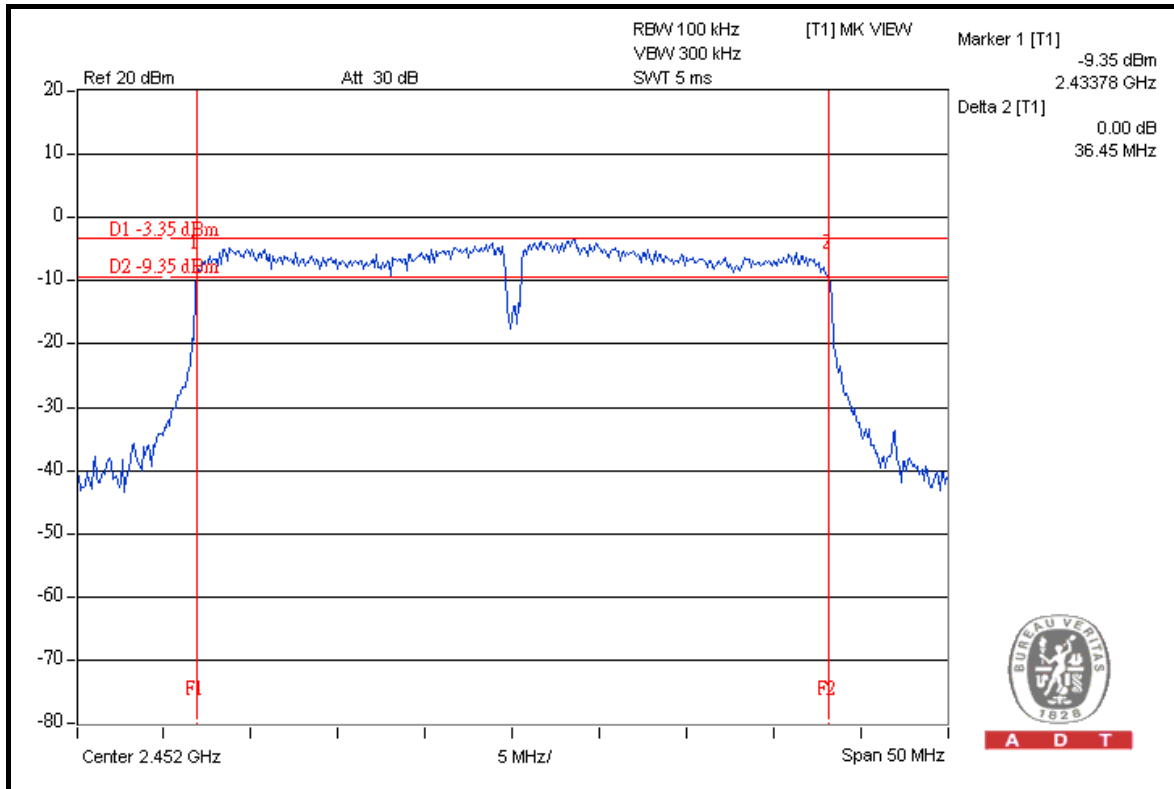



A D T

4.4 MAXIMUM PEAK OUTPUT POWER

4.4.1 LIMITS OF MAXIMUM PEAK OUTPUT POWER MEASUREMENT

The Maximum Peak Output Power Measurement is 30dBm.

4.4.2 INSTRUMENTS

DESCRIPTION & MANUFACTURER	MODEL NO.	SERIAL NO.	DATE OF CALIBRATION	DUE DATE OF CALIBRATION
High Speed Peak Power Meter	ML2495A	0824012	Aug. 04, 2008	Aug. 03, 2009
Power Sensor	MA2411B	0738138	Aug. 04, 2008	Aug. 03, 2009

NOTE:

1. The calibration interval of the above test instruments is 12 months and the calibrations are traceable to NML/ROC and NIST/USA.
2. Measurement Bandwidth of ML2495A is 65MHz greater than 6dB bandwidth of emission.

4.4.3 TEST PROCEDURES

A power sensor was used on the output port of the EUT. A power meter was used to read the response of the power sensor. Record the power level.

4.4.4 DEVIATION FROM TEST STANDARD

No deviation.

4.4.5 TEST SETUP

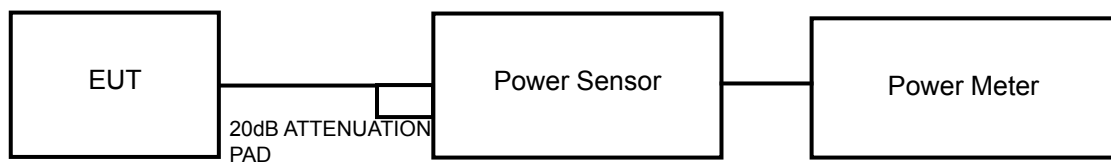

4.4.6 EUT OPERATING CONDITIONS

Same as Item 4.3.6.



A D T

4.4.7 TEST RESULTS

802.11b DSSS MODULATION

MODULATION TYPE	DBPSK	TRANSFER RATE	1.0Mbps
INPUT POWER (SYSTEM)	120Vac, 60Hz	ENVIRONMENTAL CONDITIONS	25 deg.C, 65 %RH, 1016hPa
TESTED BY	Brad Wu		

CHANNEL	CHANNEL FREQUENCY (MHz)	PEAK POWER OUTPUT (mW)	PEAK POWER OUTPUT (dBm)	PEAK POWER LIMIT (dBm)	PASS/FAIL
1	2412	89.536	19.52	30	PASS
6	2437	100.693	20.03	30	PASS
11	2462	80.168	19.04	30	PASS

802.11g OFDM MODULATION

MODULATION TYPE	BPSK	TRANSFER RATE	6.0Mbps
INPUT POWER (SYSTEM)	120Vac, 60Hz	ENVIRONMENTAL CONDITIONS	25 deg.C, 65 %RH, 1016hPa
TESTED BY	Brad Wu		

CHANNEL	CHANNEL FREQUENCY (MHz)	PEAK POWER OUTPUT (mW)	PEAK POWER OUTPUT (dBm)	PEAK POWER LIMIT (dBm)	PASS/FAIL
1	2412	200.909	23.03	30	PASS
6	2437	202.302	23.06	30	PASS
11	2462	201.372	23.04	30	PASS



A D T

DRAFT 802.11n (20MHz) OFDM MODULATION

MODULATION TYPE	BPSK	TRANSFER RATE	6.5Mbps
INPUT POWER (SYSTEM)	120Vac, 60Hz	ENVIRONMENTAL CONDITIONS	25 deg.C, 65 %RH, 1016hPa
TESTED BY	Brad Wu		

CHAN.	CHAN. FREQ. (MHz)	PEAK POWER OUTPUT (dBm)		TOTAL PEAK POWER (mW)	TOTAL PEAK POWER (dBm)	PEAK POWER LIMIT (dBm)	PASS / FAIL
		CHAIN 0	CHAIN 1				
1	2412	21.56	22.04	303.175	24.82	30	PASS
6	2437	21.51	22.06	302.274	24.80	30	PASS
11	2462	21.54	22.01	301.415	24.79	30	PASS

DRAFT 802.11n (40MHz) OFDM MODULATION

MODULATION TYPE	BPSK	TRANSFER RATE	13.5Mbps
INPUT POWER (SYSTEM)	120Vac, 60Hz	ENVIRONMENTAL CONDITIONS	25 deg.C, 65 %RH, 1016hPa
TESTED BY	Brad Wu		

CHAN.	CHAN. FREQ. (MHz)	PEAK POWER OUTPUT (dBm)		TOTAL PEAK POWER (mW)	TOTAL PEAK POWER (dBm)	PEAK POWER LIMIT (dBm)	PASS / FAIL
		CHAIN 0	CHAIN 1				
1	2422	21.58	22.03	303.468	24.82	30	PASS
4	2437	21.56	22.08	304.655	24.84	30	PASS
7	2452	21.53	22.04	302.189	24.80	30	PASS

4.5 POWER SPECTRAL DENSITY MEASUREMENT

4.5.1 LIMITS OF POWER SPECTRAL DENSITY MEASUREMENT

The Maximum of Power Spectral Density Measurement is 8dBm.

4.5.2 TEST INSTRUMENTS

DESCRIPTION & MANUFACTURER	MODEL NO.	SERIAL NO.	DATE OF CALIBRATION	DUE DATE OF CALIBRATION
R&S SPECTRUM ANALYZER	FSP40	100040	Jul. 04, 2008	Jul. 03, 2009

NOTE: The calibration interval of the above test instruments is 12 months and the calibrations are traceable to NML/ROC and NIST/USA.

4.5.3 TEST PROCEDURE

The transmitter output was connected to the spectrum analyzer through an attenuator, the bandwidth of the fundamental frequency was measured with the spectrum analyzer using 3kHz RBW and 30kHz VBW, set sweep time = span/3kHz. The power spectral density was measured and recorded.

The sweep time is allowed to be longer than span/3kHz for a full response of the mixer in the spectrum analyzer.

4.5.4 DEVIATION FROM TEST STANDARD

No deviation.

4.5.5 TEST SETUP

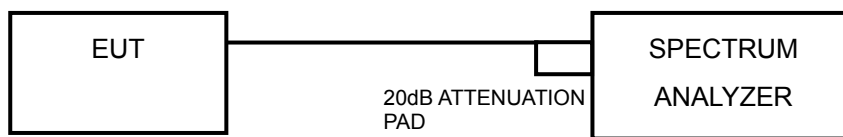

4.5.6 EUT OPERATING CONDITION

Same as Item 4.3.6.



A D T

4.5.7 TEST RESULTS

802.11b DSSS MODULATION

MODULATION TYPE	DBPSK	TRANSFER RATE	1.0Mbps
INPUT POWER (SYSTEM)	120Vac, 60Hz	ENVIRONMENTAL CONDITIONS	25 deg.C, 65 %RH, 1016hPa
TESTED BY	Brad Wu		

CHANNEL	CHANNEL FREQUENCY (MHz)	RF POWER LEVEL IN 3 kHz BW (dBm)	MAXIMUM LIMIT (dBm)	PASS/FAIL
1	2412	-13.18	8	PASS
6	2437	-12.60	8	PASS
11	2462	-13.66	8	PASS



A D T

CH 1

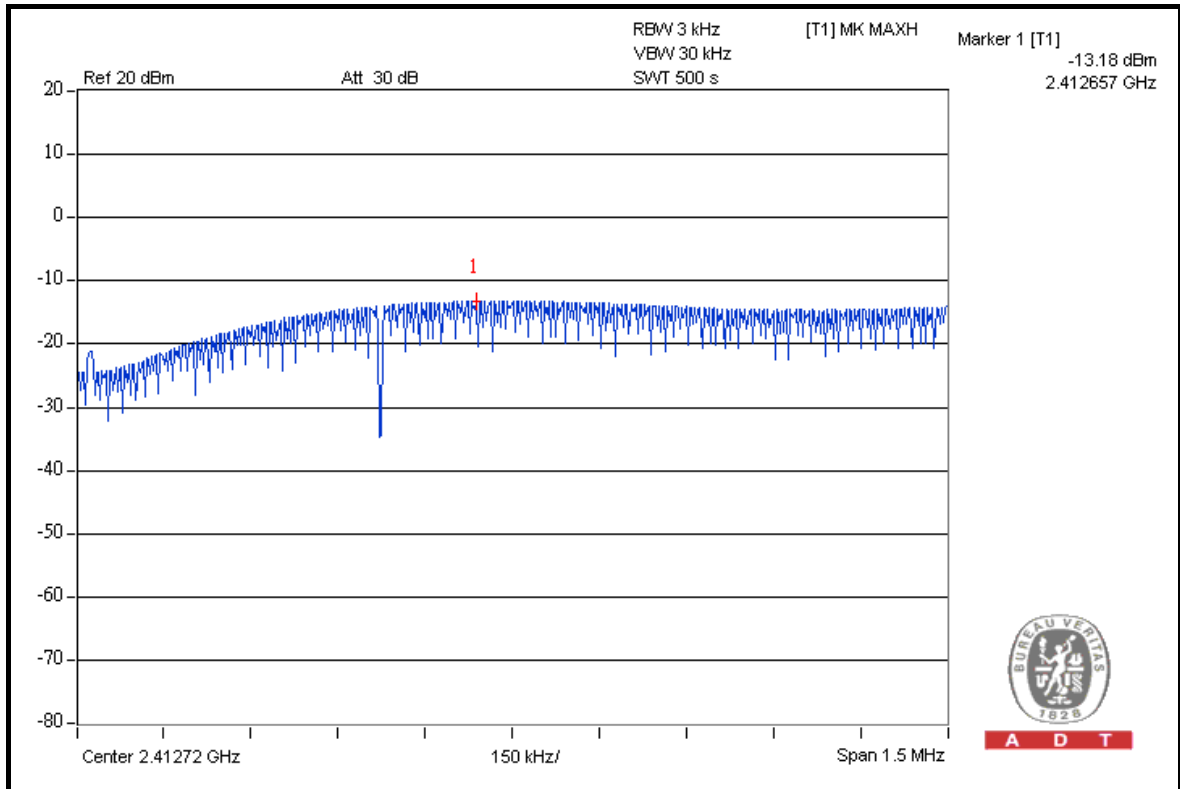

CH 6

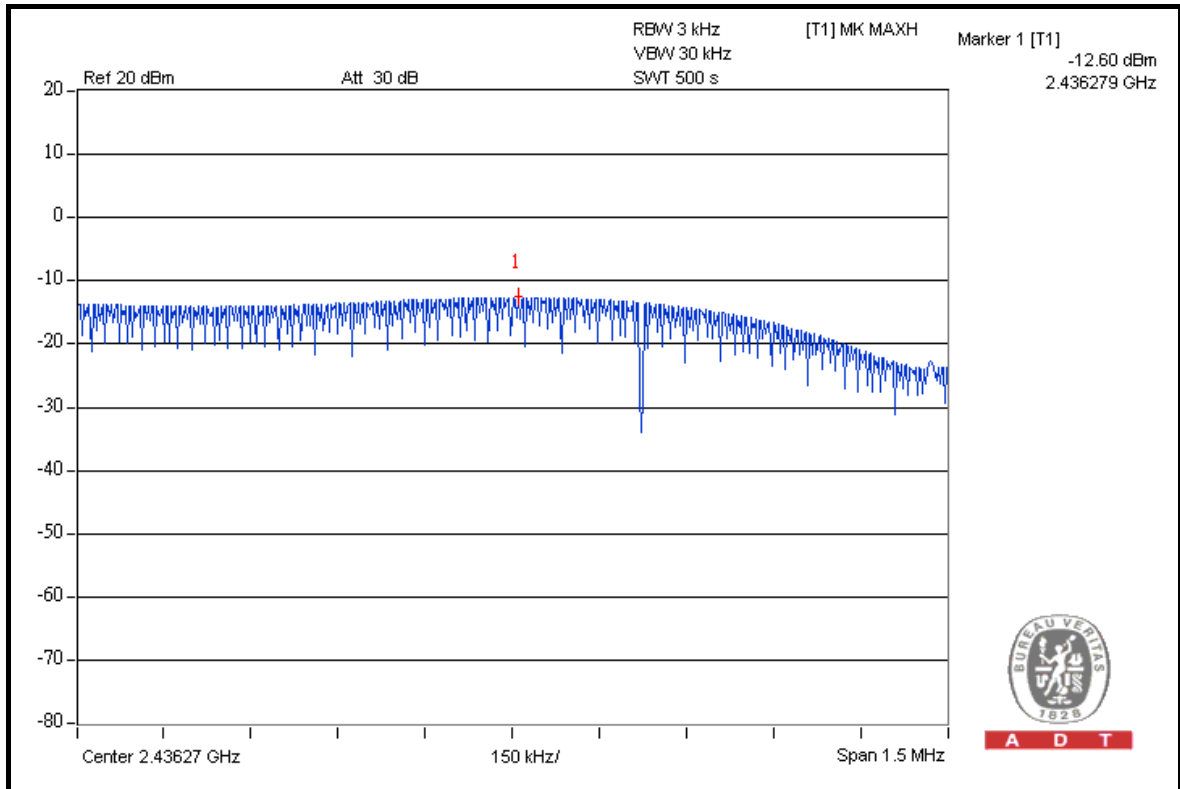



A D T

CH 11

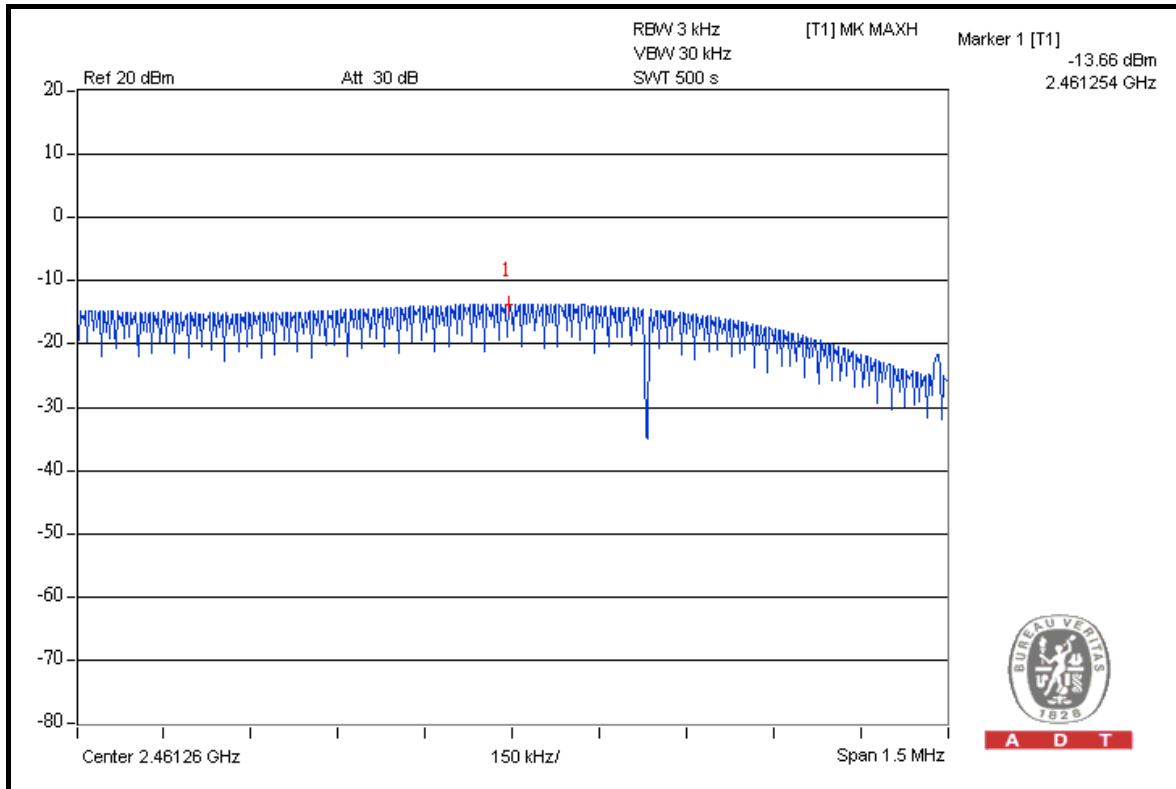



A D T

802.11g OFDM MODULATION

MODULATION TYPE	BPSK	TRANSFER RATE	6.0Mbps
INPUT POWER (SYSTEM)	120Vac, 60Hz	ENVIRONMENTAL CONDITIONS	25 deg.C, 65 %RH, 1016hPa
TESTED BY	Brad Wu		

CHANNEL	CHANNEL FREQUENCY (MHz)	RF POWER LEVEL IN 3 kHz BW (dBm)	MAXIMUM LIMIT (dBm)	PASS/FAIL
1	2412	-14.44	8	PASS
6	2437	-14.47	8	PASS
11	2462	-14.44	8	PASS



A D T

CH 1

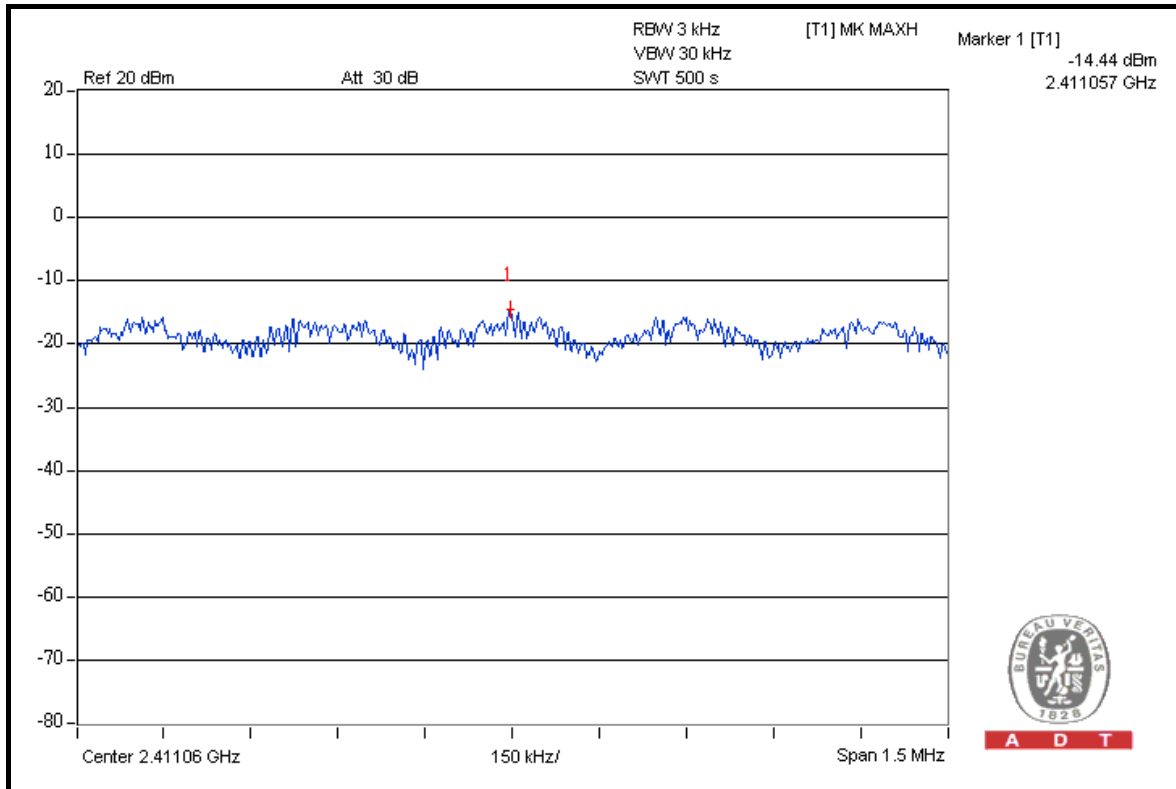

CH 6

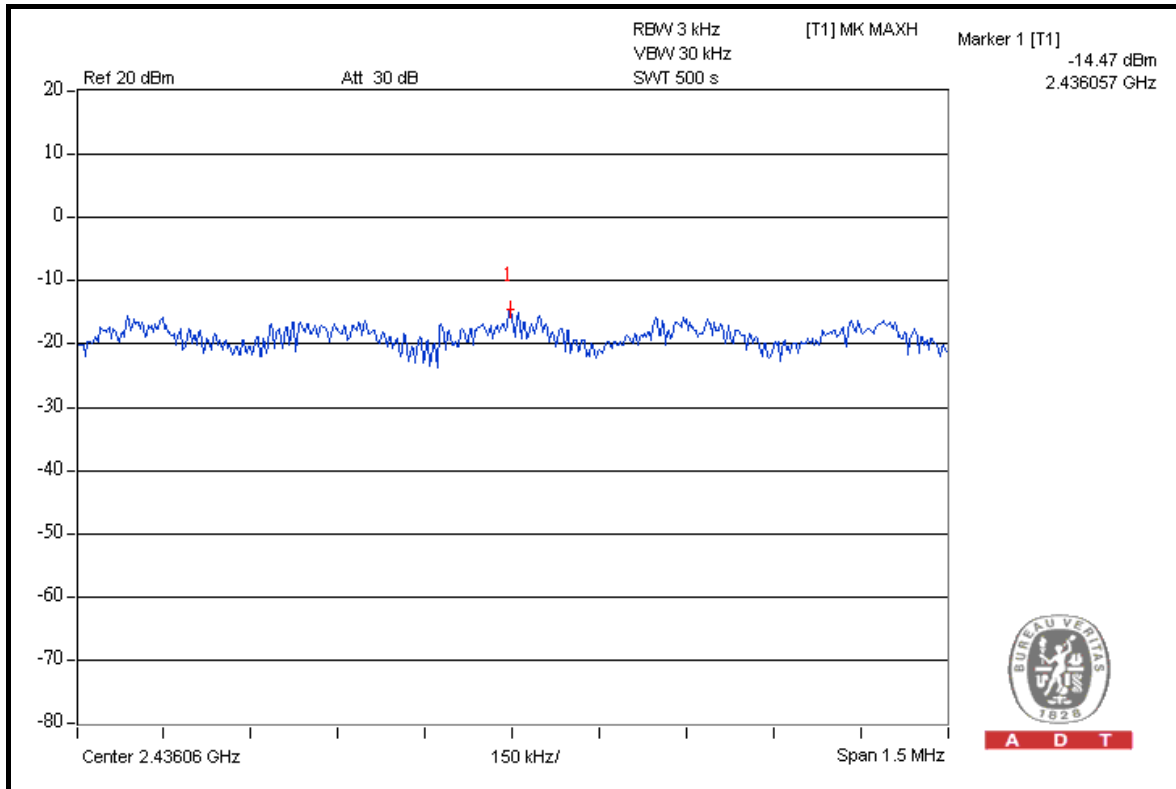



A D T

CH 11

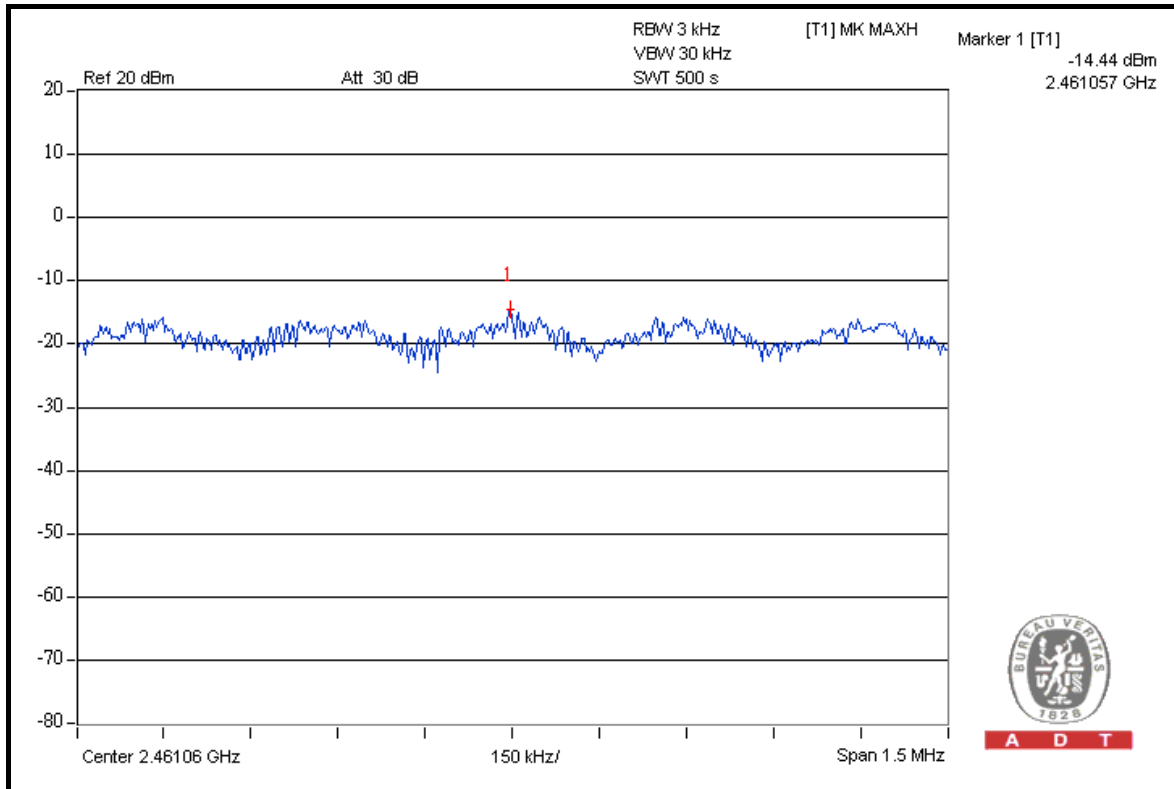

A D T



A D T

DRAFT 802.11n (20MHz) OFDM MODULATION

MODULATION TYPE	BPSK	TRANSFER RATE	6.5Mbps
INPUT POWER (SYSTEM)	120Vac, 60Hz	ENVIRONMENTAL CONDITIONS	25 deg.C, 65 %RH, 1016hPa
TESTED BY	Brad Wu		

CHAN.	CHAN. FREQ. (MHz)	RF POWER LEVEL IN 3kHz BW (dBm)		TOTAL POWER DENSITY (mW)	TOTAL POWER DENSITY (dBm)	MAX. LIMIT (dBm)	PASS / FAIL
		CHAIN 0	CHAIN 1				
1	2412	-12.29	-14.88	0.092	-10.38	8	PASS
6	2437	-12.48	-14.95	0.088	-10.53	8	PASS
11	2462	-12.44	-14.71	0.091	-10.42	8	PASS



A D T

FOR CHAIN 0: CH 1

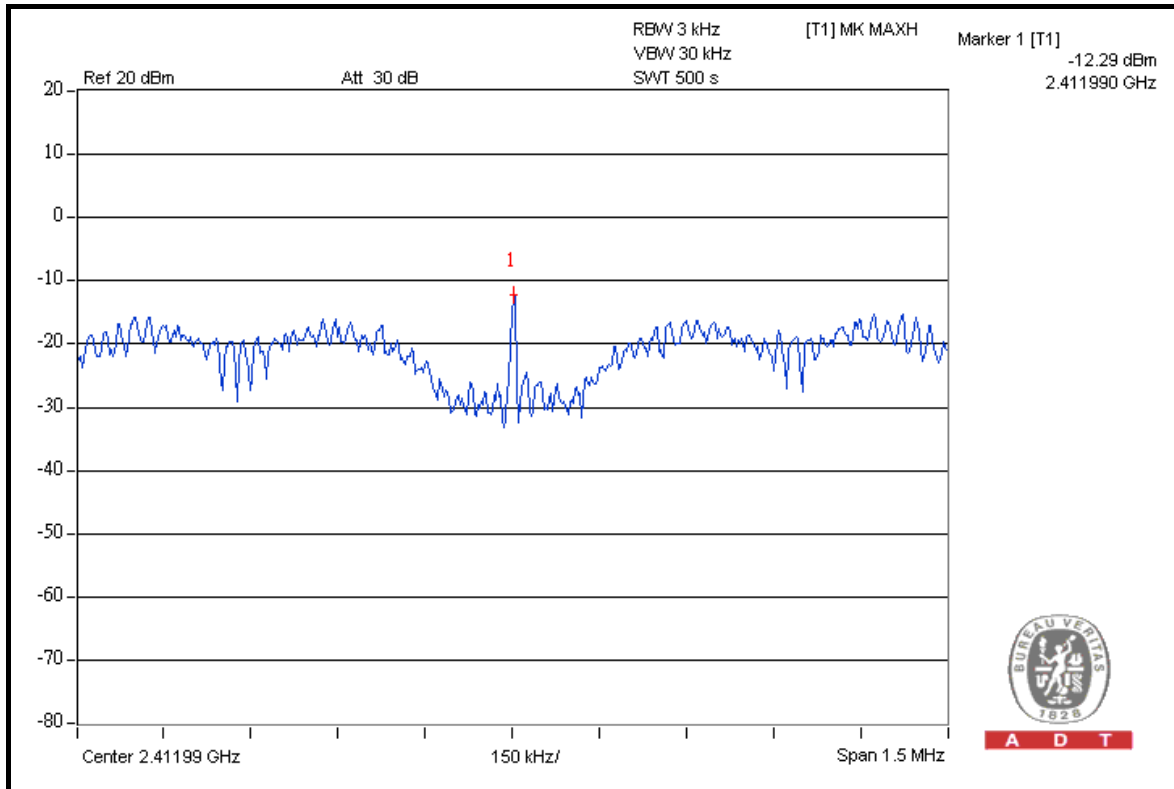

CH 6

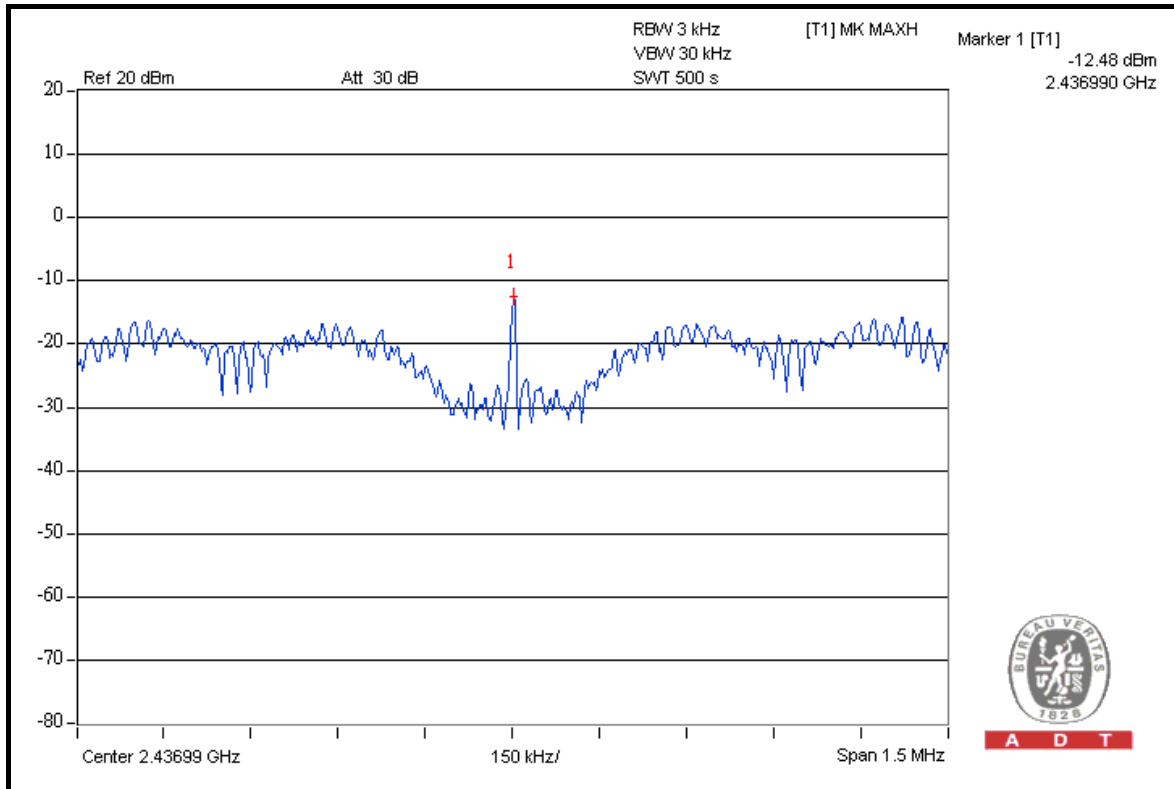



A D T

CH 11

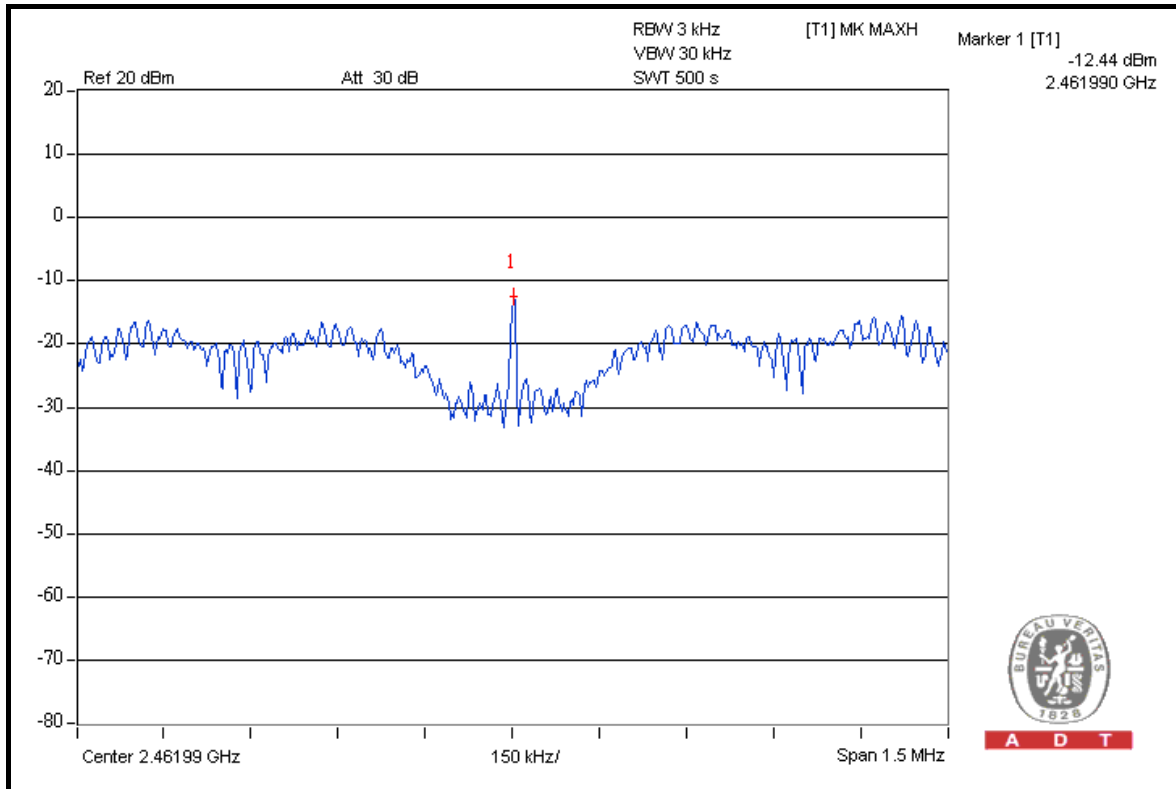

FOR CHAIN 1: CH 1

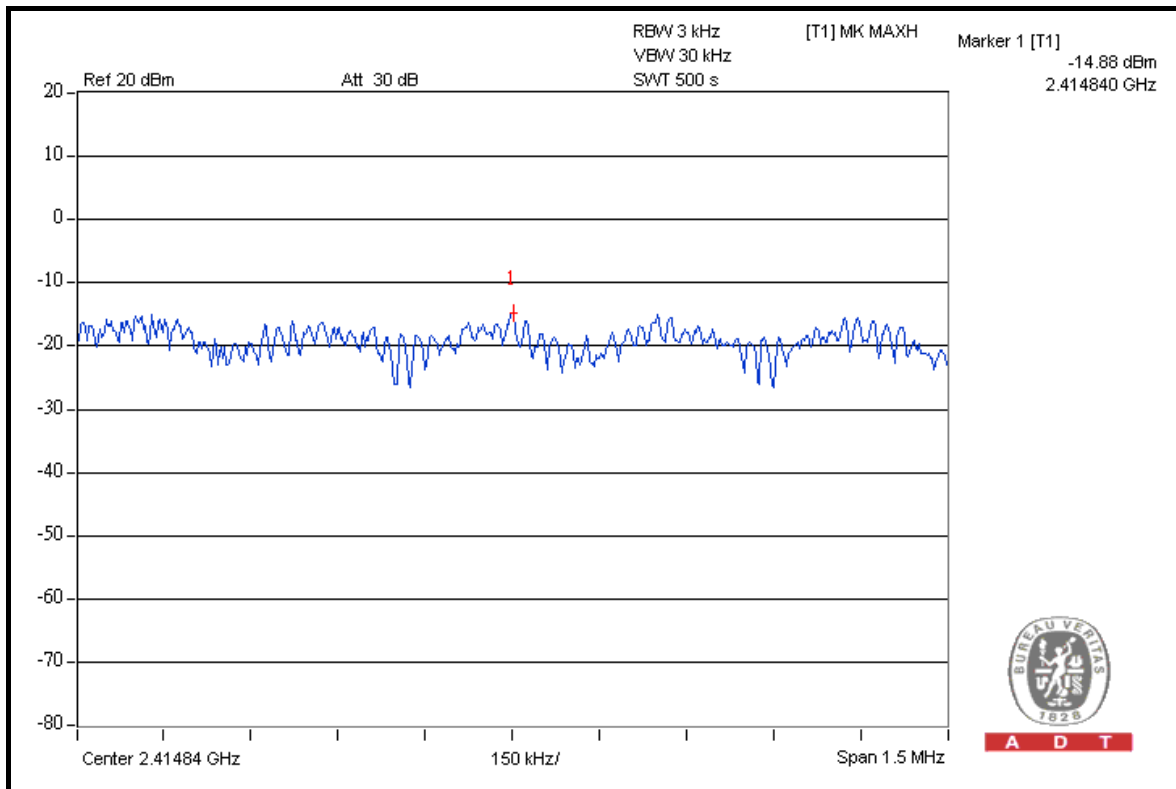



A D T

CH 6

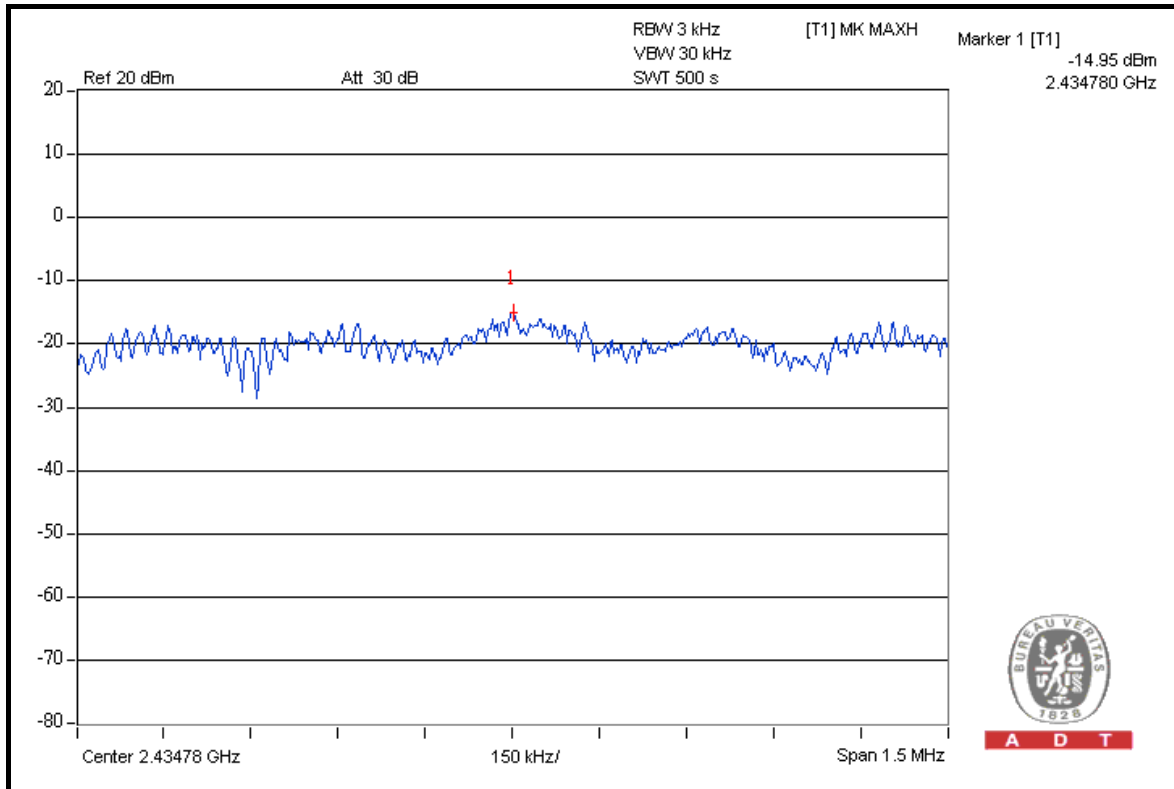

CH 11

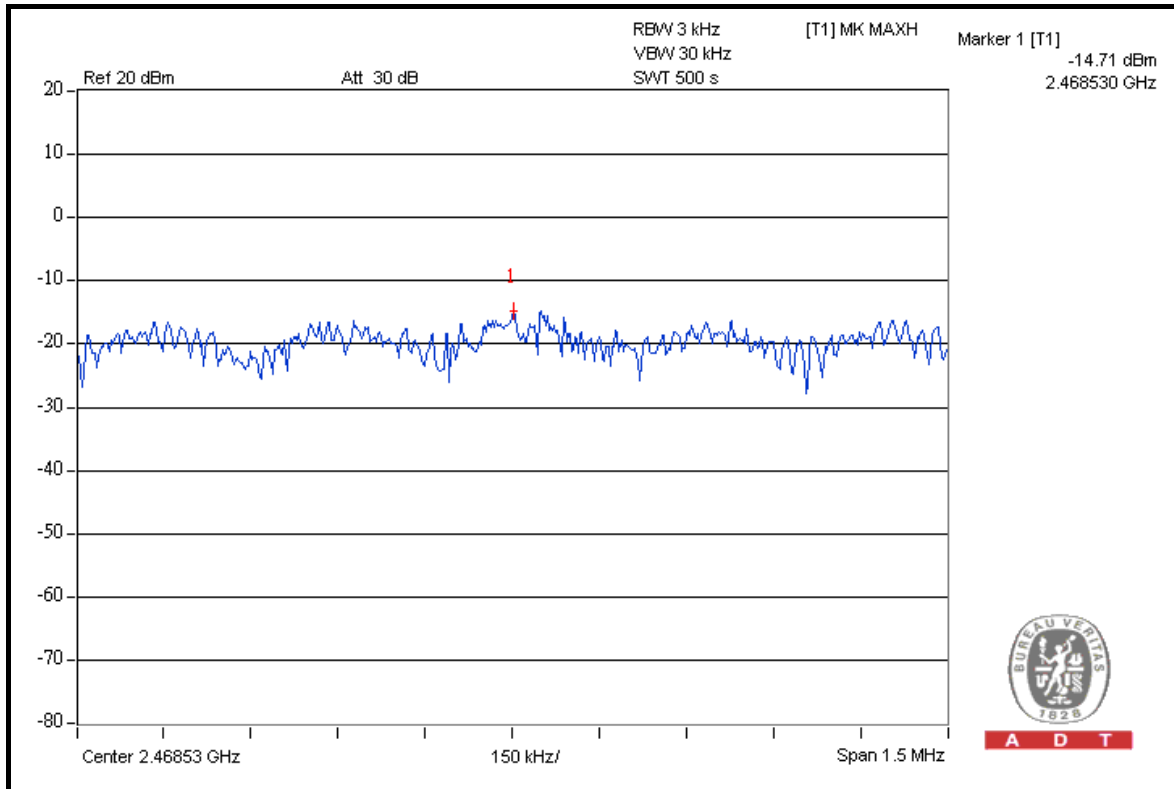



A D T

DRAFT 802.11n (40MHz) OFDM MODULATION

MODULATION TYPE	BPSK	TRANSFER RATE	13.5Mbps
INPUT POWER (SYSTEM)	120Vac, 60Hz	ENVIRONMENTAL CONDITIONS	25 deg.C, 65 %RH, 1016hPa
TESTED BY	Brad Wu		

CHAN.	CHAN. FREQ. (MHz)	RF POWER LEVEL IN 3kHz BW (dBm)		TOTAL POWER DENSITY (mW)	TOTAL POWER DENSITY (dBm)	MAX. LIMIT (dBm)	PASS / FAIL
		CHAIN 0	CHAIN 1				
1	2422	-13.09	-15.97	0.074	-11.29	8	PASS
4	2437	-14.43	-15.80	0.062	-12.05	8	PASS
7	2452	-13.84	-16.09	0.066	-11.81	8	PASS



A D T

FOR CHAIN 0: CH 1

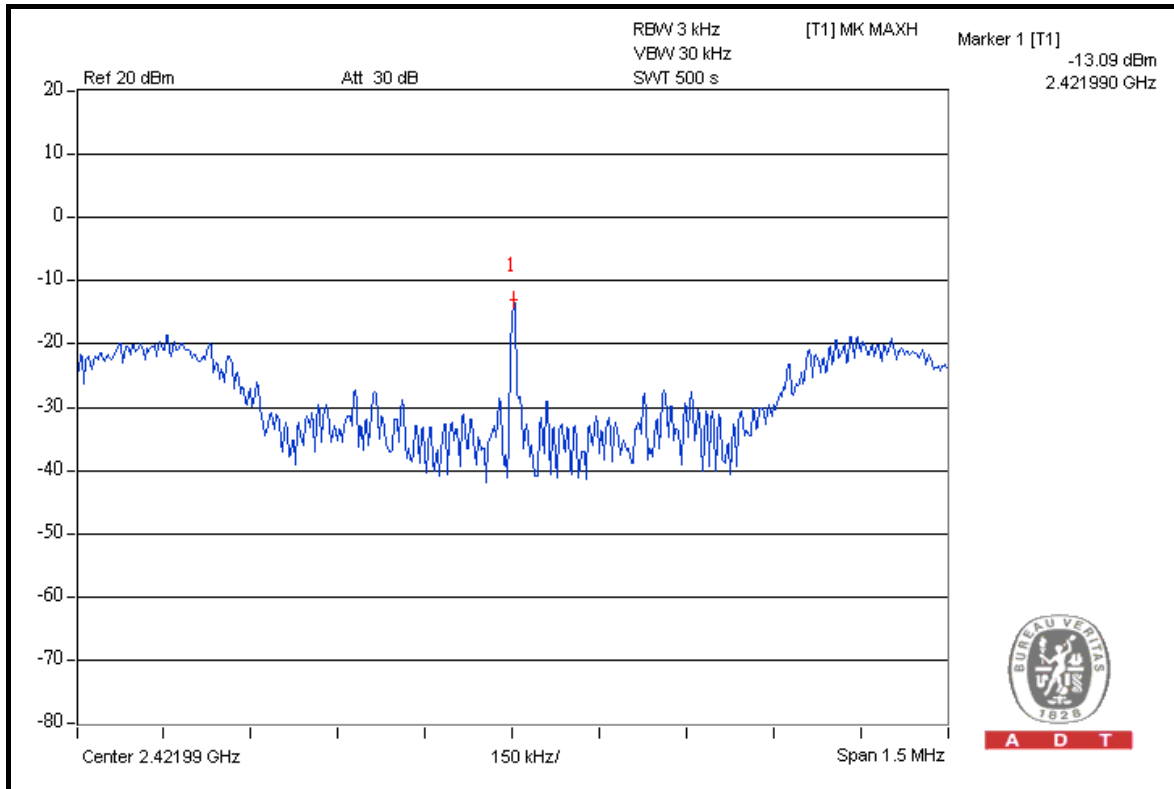

A D T

CH 4

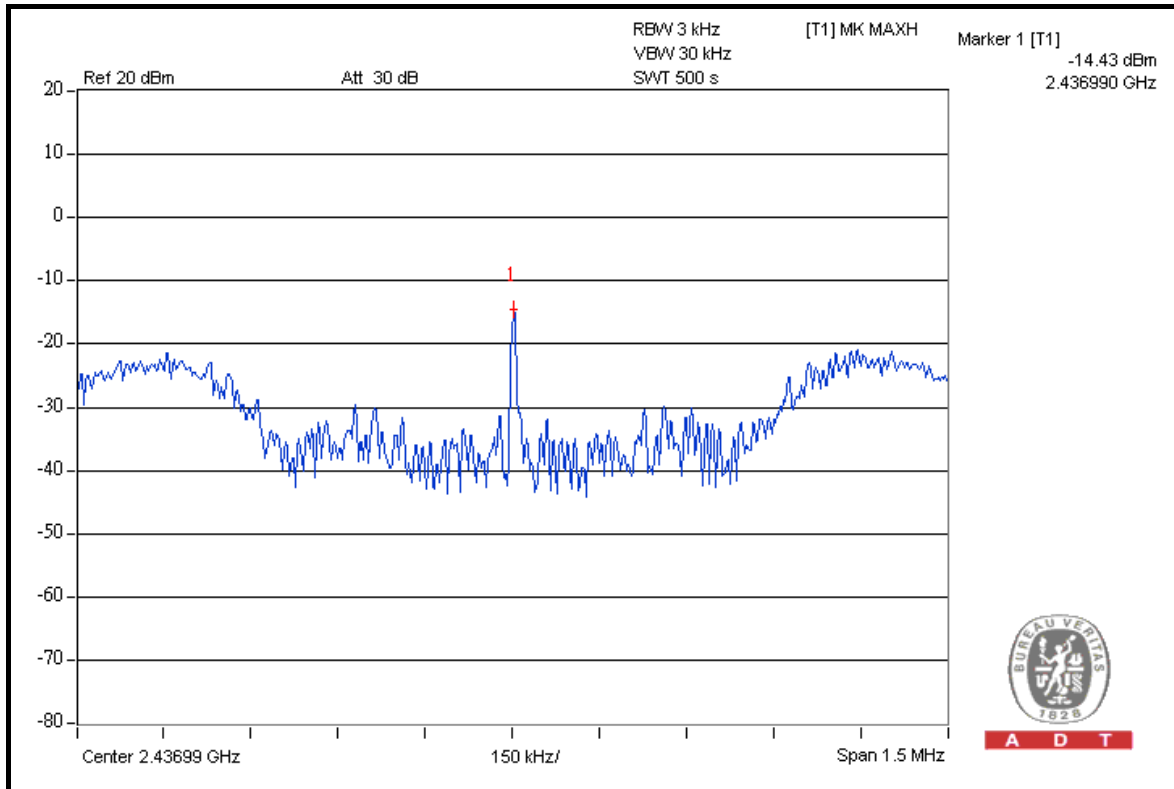

A D T



A D T

CH 7

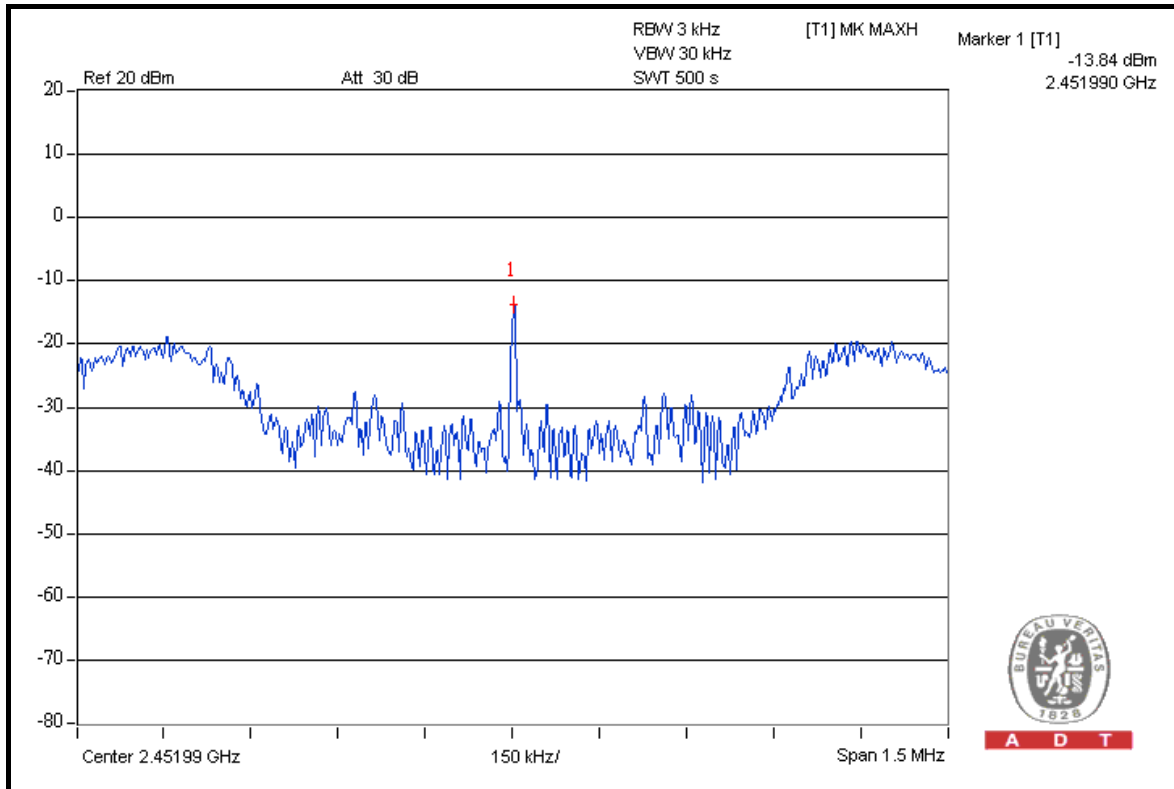

FOR CHAIN 1: CH 1

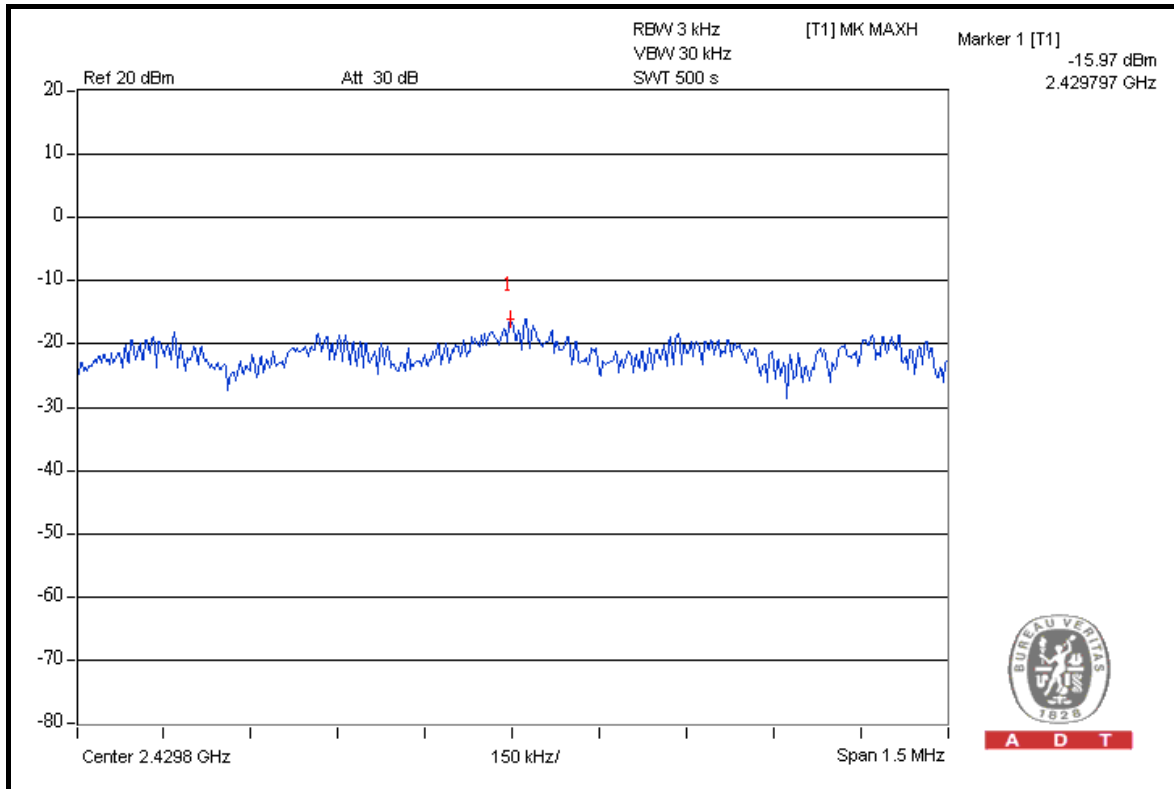



A D T

CH 4

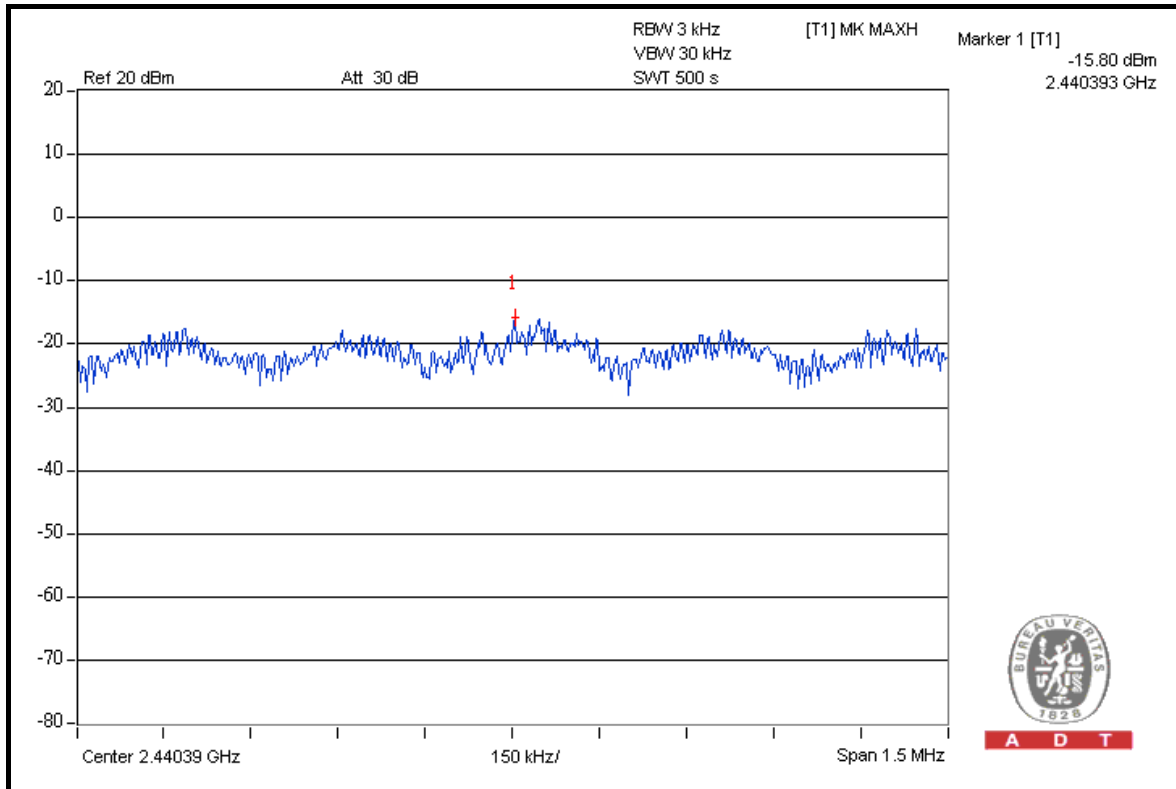

A D T

CH 7

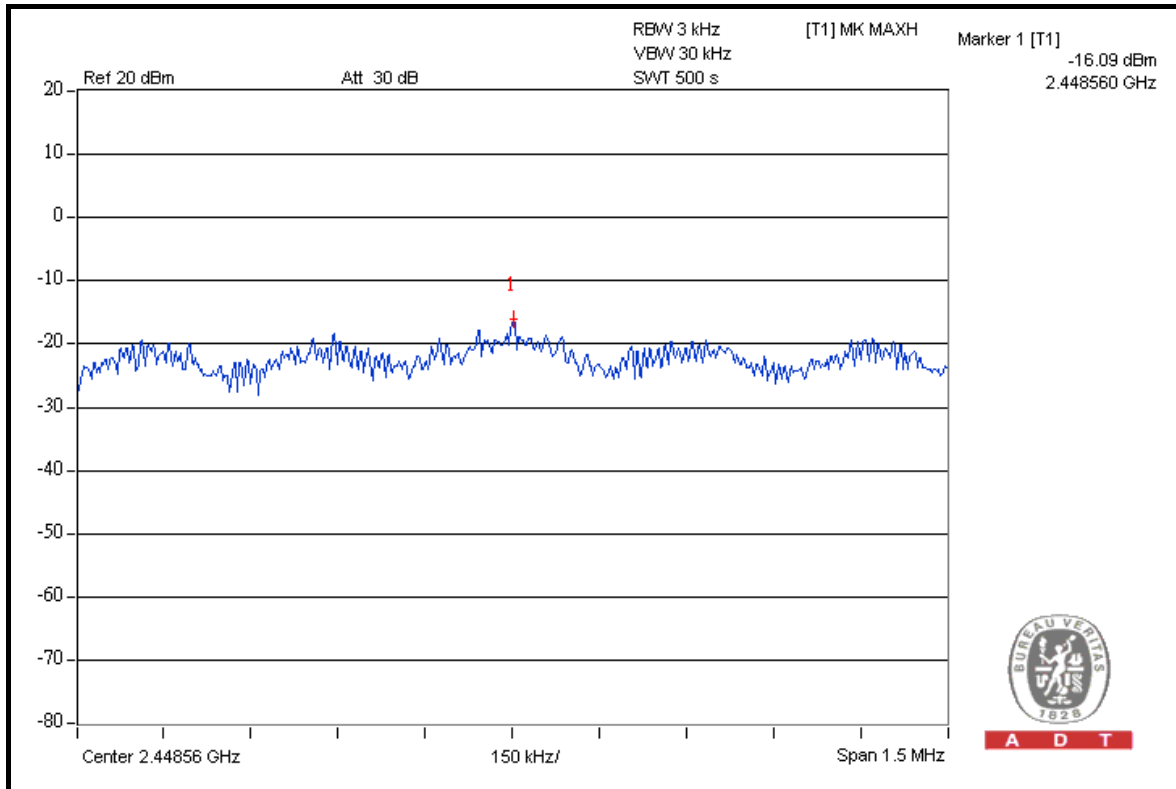

A D T

4.6 BAND EDGES MEASUREMENT

4.6.1 LIMITS OF BAND EDGES MEASUREMENT

Below -20dB of the highest emission level of operating band (in 100kHz Resolution Bandwidth).

4.6.2 TEST INSTRUMENTS

DESCRIPTION & MANUFACTURER	MODEL NO.	SERIAL NO.	DATE OF CALIBRATION	DUE DATE OF CALIBRATION
FOR CONDUCTED MEASUREMENT				
Spectrum Analyzer ROHDE & SCHWARZ	FSP40	100040	Jul. 04, 2008	Jul. 03, 2009
FOR RADIATED MEASUREMENT				
Test Receiver ROHDE & SCHWARZ	ESIB7	100212	May 28, 2008	May 27, 2009
Spectrum Analyzer ROHDE & SCHWARZ	FSP40	100269	Aug. 08, 2008	Aug. 07, 2009
BILOG Antenna SCHWARZBECK	VULB9168	9168-316	May 01, 2008	Apr. 30, 2009
HORN Antenna SCHWARZBECK	BBHA 9120 D	9120D-563	Aug. 06, 2008	Aug. 05, 2009
HORN Antenna SCHWARZBECK	BBHA 9170	BBHA9170242	Jan. 06, 2009	Jan. 05, 2010
Preamplifier Agilent	8449B	3008A01911	Sep. 10, 2008	Sep. 09, 2009
Preamplifier Agilent	8447D	2944A10638	Dec. 26, 2008	Dec. 25, 2009
RF signal cable HUBER+SUHNNER	SUCOFLEX 104	218190/4 231241/4	May 20, 2008	May 19, 2009
RF signal cable Worken	8D-FB	Cable-HYCH9-01	Aug. 09, 2008	Aug. 08, 2009
Software	ADT_Radiated_ V7.6.15.9.2	NA	NA	NA
Antenna Tower EMCO	2070/2080	512.835.4684	NA	NA
Turn Table EMCO	2087-2.03	NA	NA	NA
Antenna Tower & Turn Table Controller EMCO	2090	NA	NA	NA

NOTE: The calibration interval of the above test instruments is 12 months and the calibrations are traceable to NML/ROC and NIST/USA.



A D T

4.6.3 TEST PROCEDURE

- a. The EUT was placed on the top of a rotating table 0.8 meters above the ground at a 3 meter semi-anechoic chamber. The table was rotated 360 degrees to determine the position of the highest radiation.
- b. The EUT was set 3 meters away from the interference-receiving antenna, which was mounted on the top of a variable-height antenna tower.
- c. The antenna is a broadband antenna, and its height is varied from one meter to four meters above the ground to determine the maximum value of the field strength. Both horizontal and vertical polarizations of the antenna are set to make the measurement.
- d. For each suspected emission, the EUT was arranged to its worst case and then the antenna was tuned to heights from 1 meter to 4 meters and the rotatable table was turned from 0 degrees to 360 degrees to find the maximum reading.
- e. Set both RBW and VBW of spectrum analyzer to 100kHz and 300kHz with suitable frequency span including 100MHz bandwidth from band edge. The band edges was measured and recorded.

The spectrum plots (Peak RBW = 100kHz, VBW = 300kHz) are attached on the following pages.

NOTE: The resolution bandwidth of test receiver/spectrum analyzer is 1MHz and the video bandwidth is 10Hz for Average detection (AV) at frequency above 1GHz.

4.6.4 DEVIATION FROM TEST STANDARD

No deviation.

4.6.5 EUT OPERATING CONDITION

Same as Item 4.3.6.



4.6.6 TEST RESULTS

The spectrum plots are attached on the following pages. D1 line indicates the highest level, and D2 line indicates the 20dB offset below D1. It shows compliance with the requirement in part 15.247(d).

802.11b DSSS MODULATION

NOTE 1: The band edge emission plot on the next page shows 51.95dBc between carrier maximum power and local maximum emission in restrict band (2.37420GHz). The emission of carrier strength list in the test result of channel 1 at the item 4.1.7 is 101.21dBuV/m (Peak), so the maximum field strength in restrict band is $101.21 - 51.95 = 49.26$ dBuV/m which is under 74dBuV/m limit.

The band edge emission plot of on the next page shows 61.86dBc between carrier maximum power and local maximum emission in restrict band (2.38900GHz). The emission of carrier strength list in the test result of channel 1 at the item 4.1.7 is 96.69dBuV/m (Average), so the maximum field strength in restrict band is $96.69 - 61.86 = 34.83$ dBuV/m which is under 54dBuV/m limit.

NOTE 2: The band edge emission plot on the next second page shows 51.60dBc between carrier maximum power and local maximum emission in restrict band (2.49260GHz). The emission of carrier strength list in the test result of channel 11 at the item 4.1.7 is 101.97dBuV/m (Peak), so the maximum field strength in restrict band is $101.97 - 51.60 = 50.37$ dBuV/m which is under 74dBuV/m limit.

The band edge emission plot on the next third page shows 61.34dBc between carrier maximum power and local maximum emission in restrict band (2.48380GHz). The emission of carrier strength list in the test result of channel 11 at the item 4.1.7 is 97.83dBuV/m (Average), so the maximum field strength in restrict band is $97.83 - 61.34 = 36.49$ dBuV/m which is under 54dBuV/m limit.



A D T

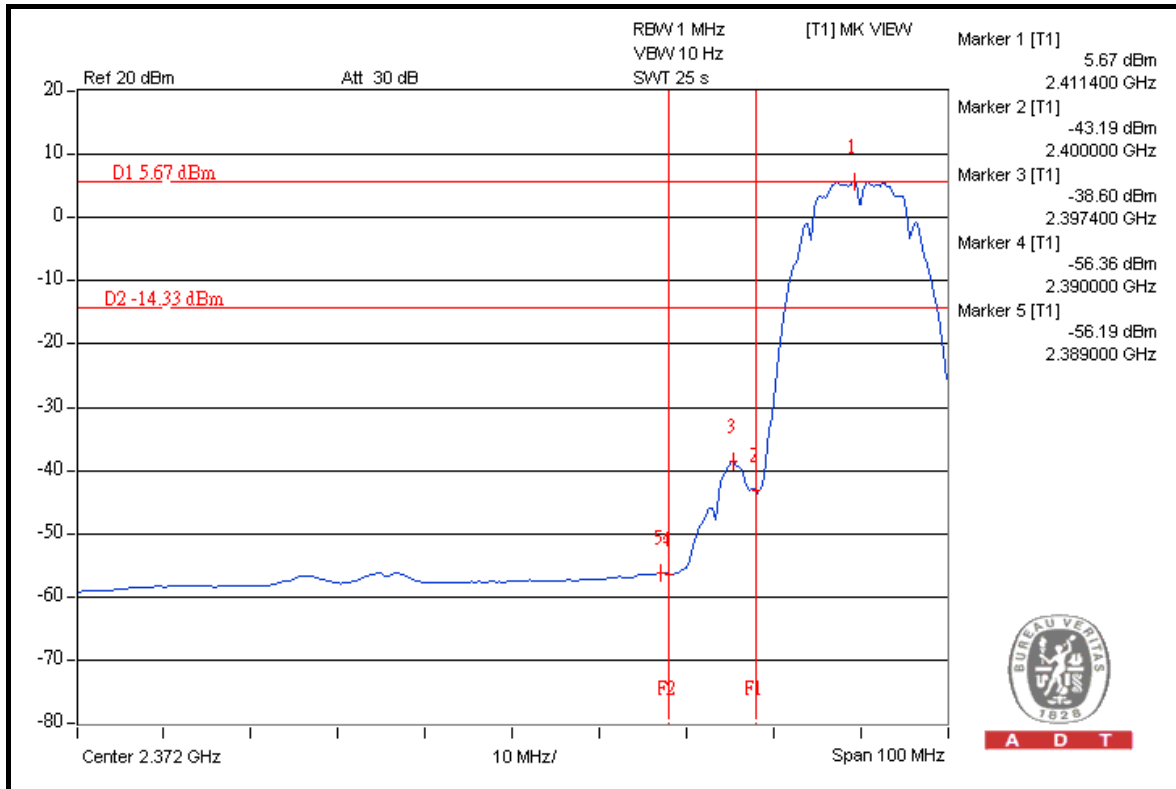
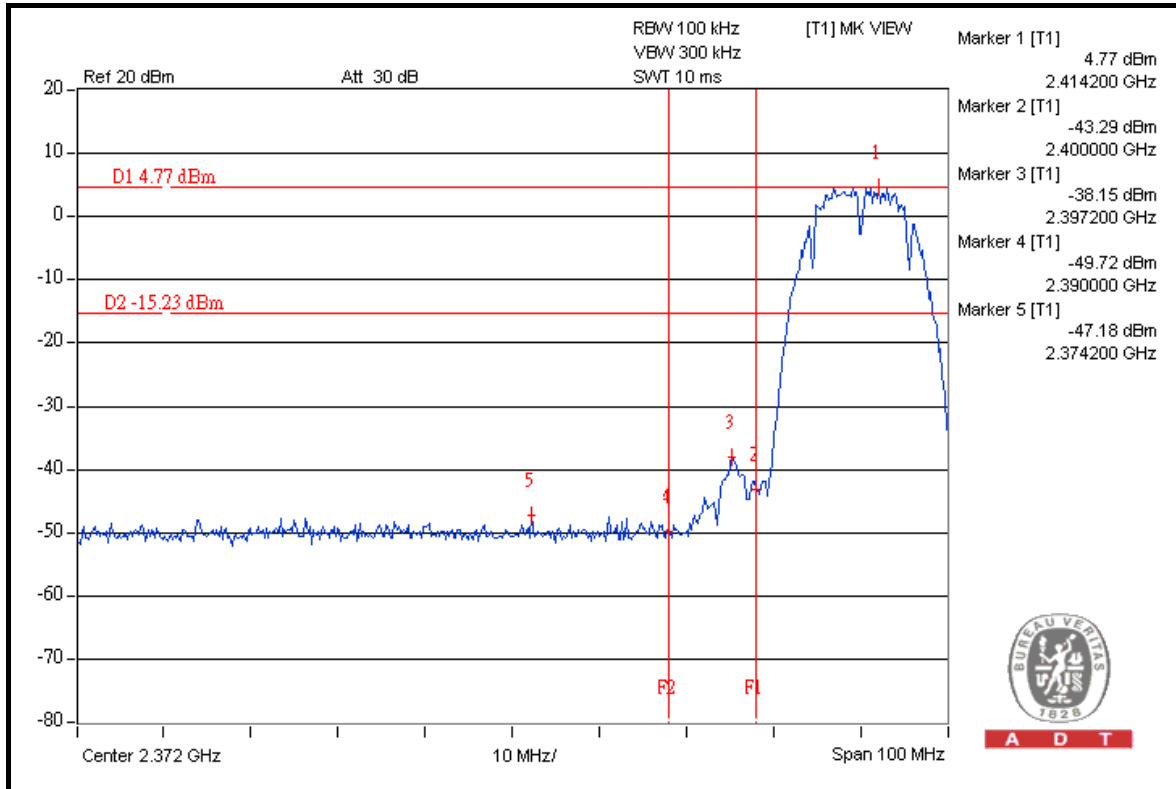



A D T

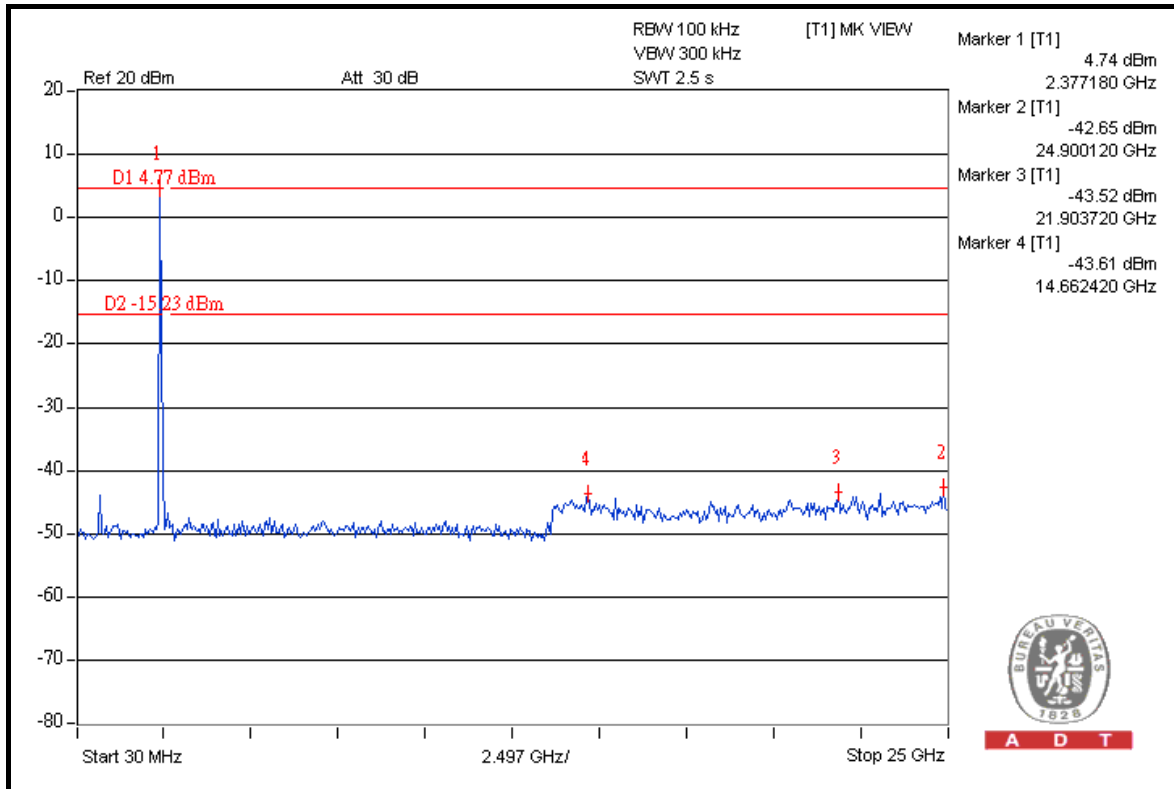

A D T

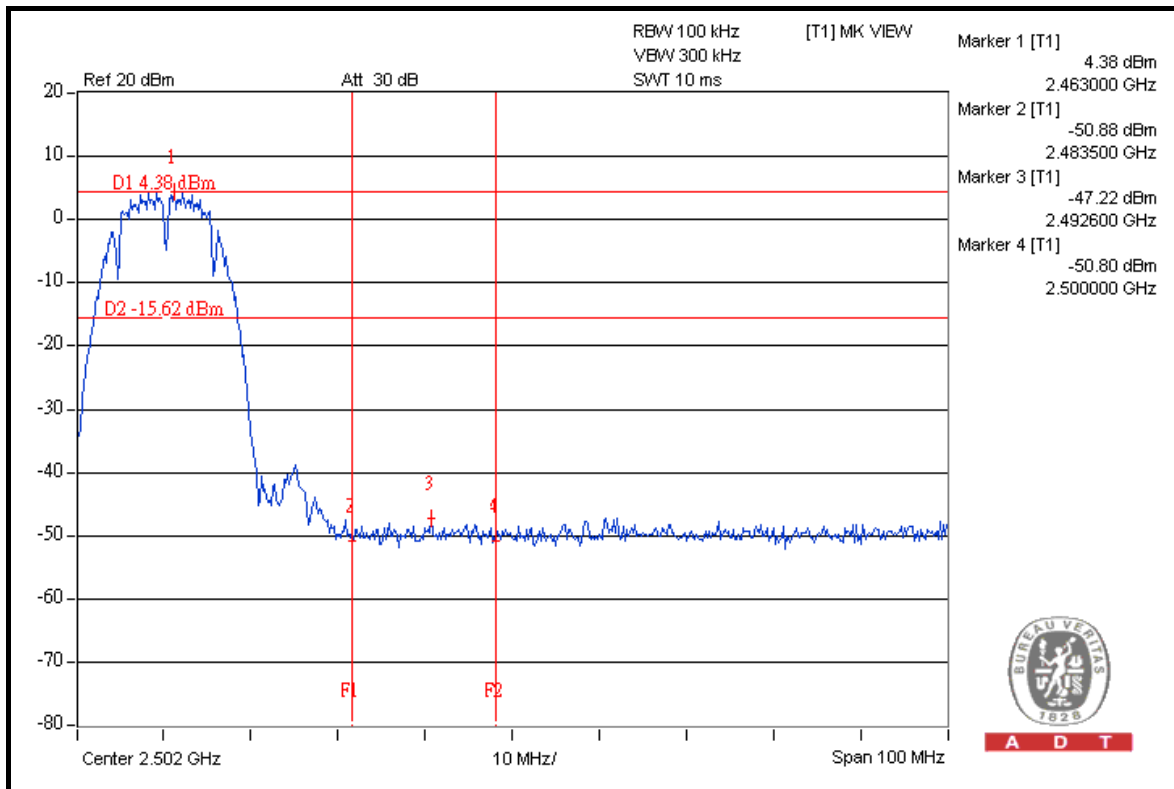

A D T



A D T

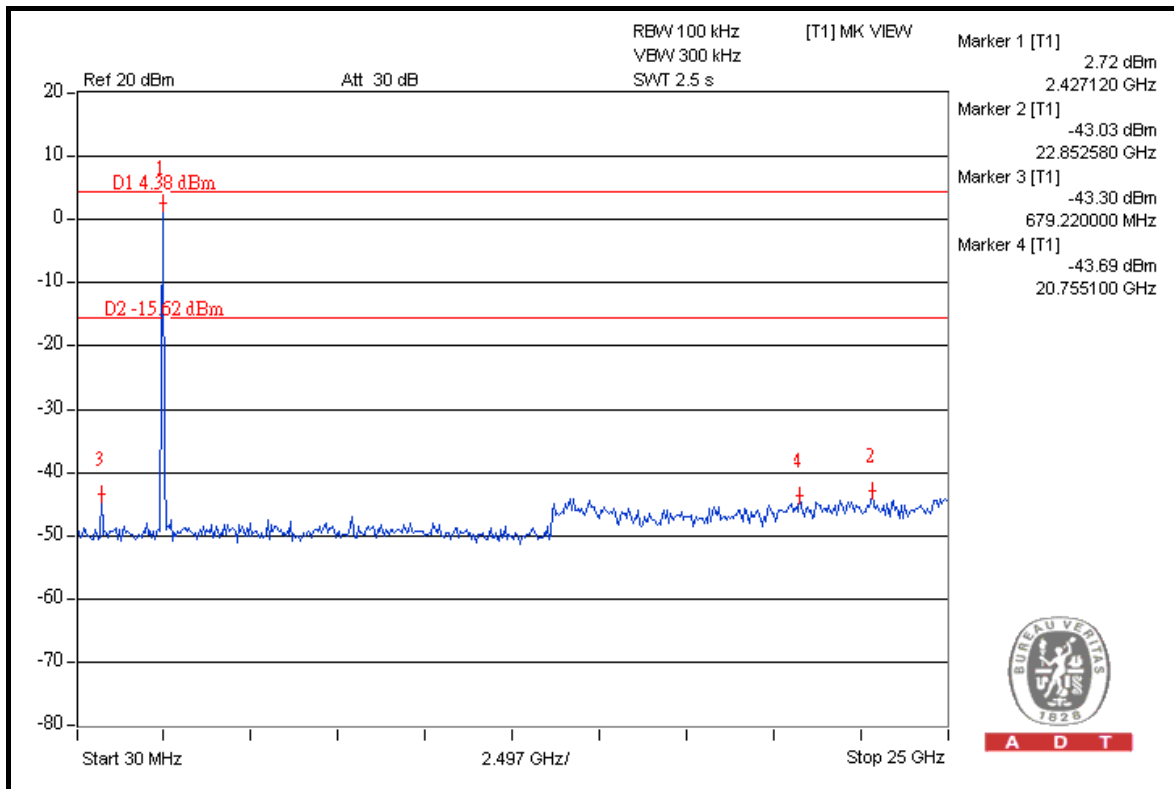
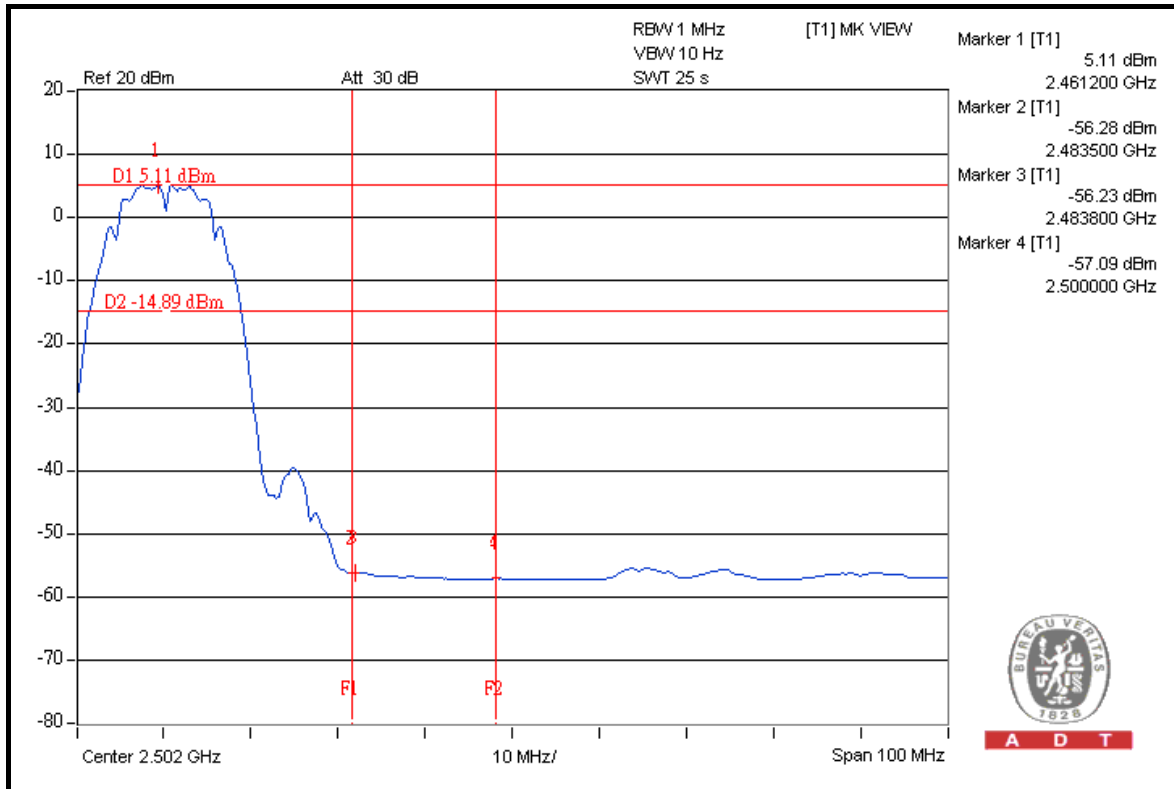



802.11g OFDM MODULATION

NOTE 1: The band edge emission plot on the next page shows 45.16dBc between carrier maximum power and local maximum emission in restrict band (2.38980GHz). The emission of carrier strength list in the test result of channel 1 at the item 4.1.7 is 100.50dBuV/m (Peak), so the maximum field strength in restrict band is $100.50 - 45.16 = 55.34$ dBuV/m which is under 74dBuV/m limit.

The band edge emission plot of on the next page shows 50.58dBc between carrier maximum power and local maximum emission in restrict band (2.35960GHz). The emission of carrier strength list in the test result of channel 1 at the item 4.1.7 is 90.48dBuV/m (Average), so the maximum field strength in restrict band is $90.48 - 50.58 = 39.90$ dBuV/m which is under 54dBuV/m limit.

NOTE 2: The band edge emission plot on the next second page shows 43.78dBc between carrier maximum power and local maximum emission in restrict band (2.48440GHz). The emission of carrier strength list in the test result of channel 11 at the item 4.1.7 is 102.56dBuV/m (Peak), so the maximum field strength in restrict band is $102.56 - 43.78 = 58.78$ dBuV/m which is under 74dBuV/m limit.

The band edge emission plot on the next third page shows 51.05dBc between carrier maximum power and local maximum emission in restrict band (2.48350GHz). The emission of carrier strength list in the test result of channel 11 at the item 4.1.7 is 92.20dBuV/m (Average), so the maximum field strength in restrict band is $92.20 - 51.05 = 41.15$ dBuV/m which is under 54dBuV/m limit.



A D T

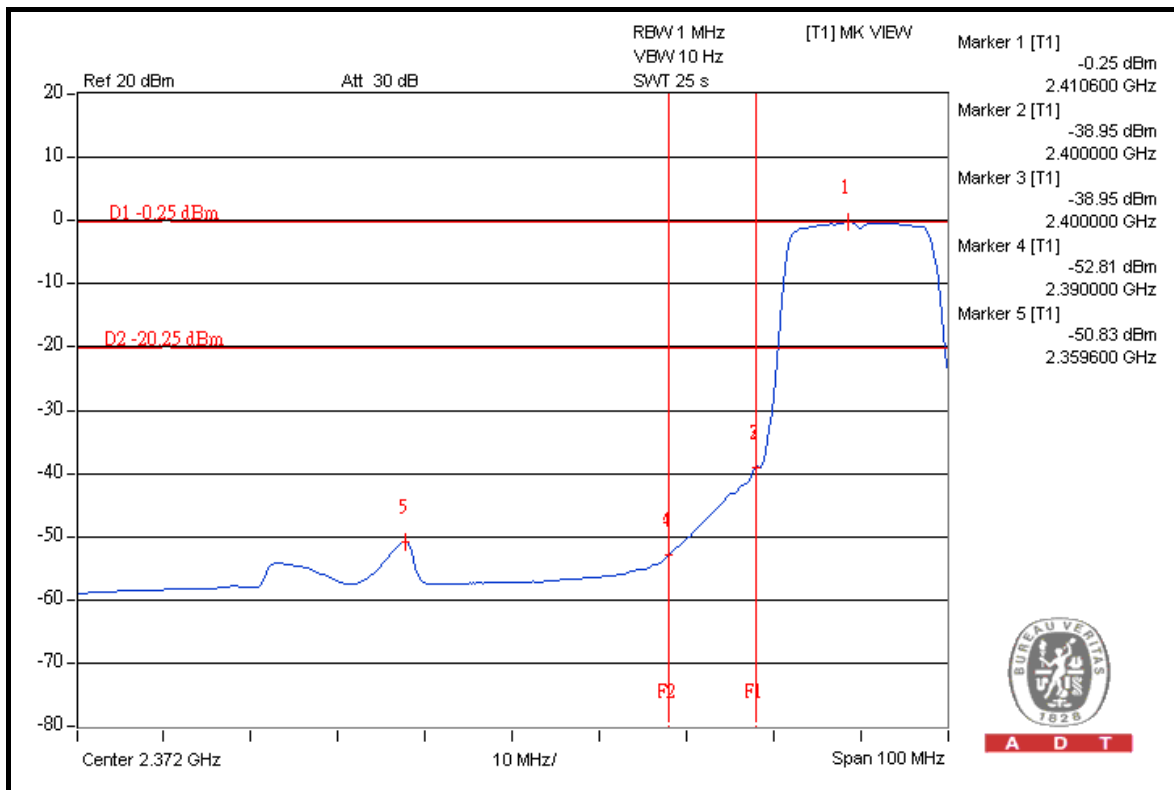
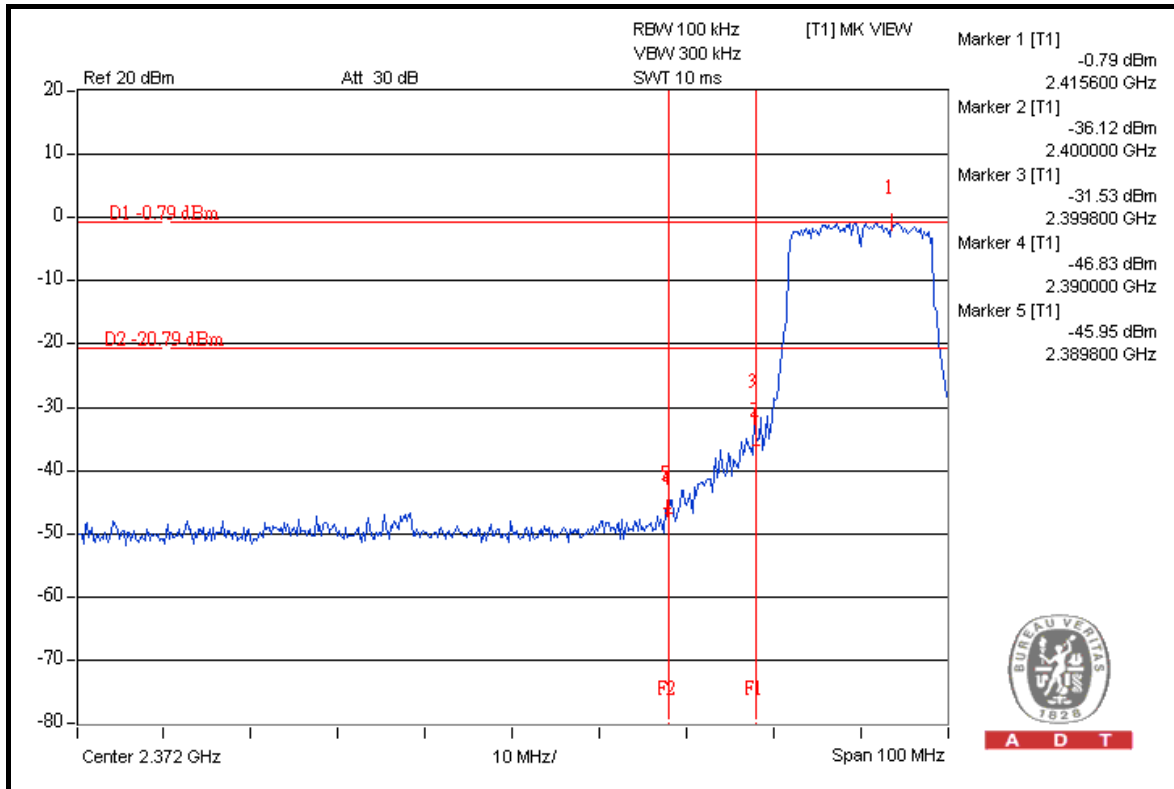



A D T

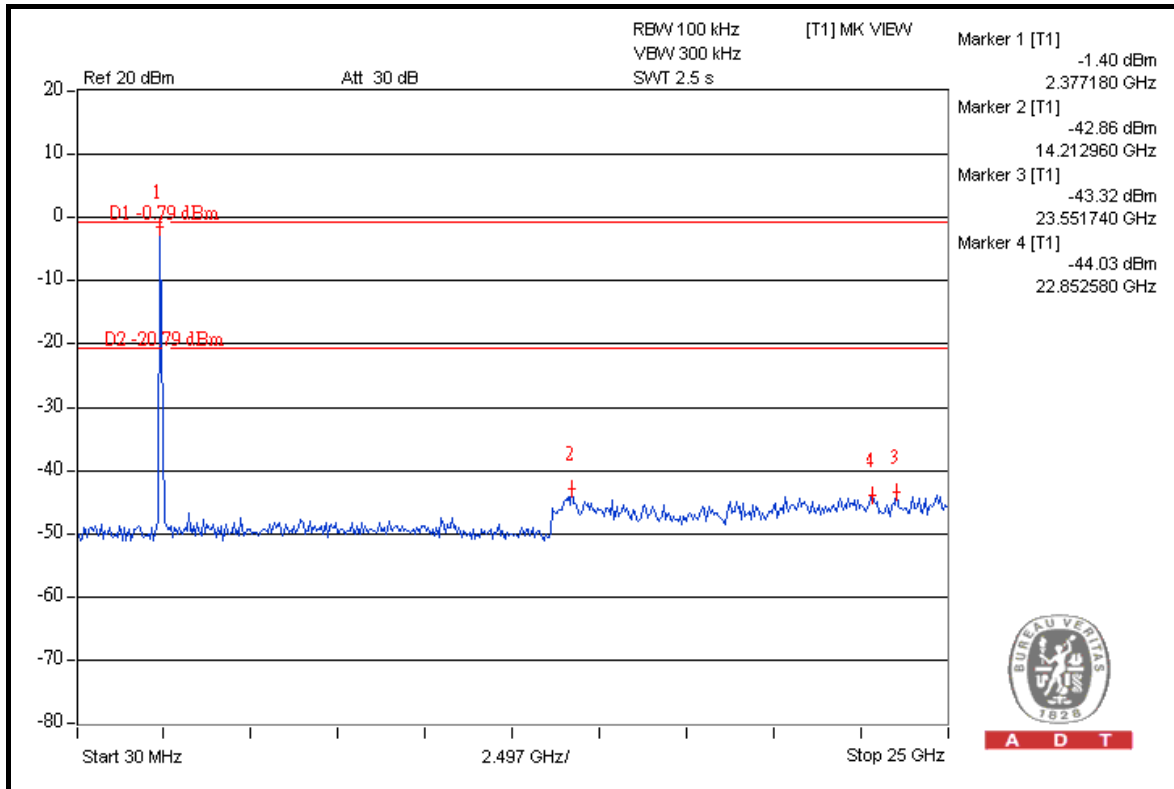

A D T

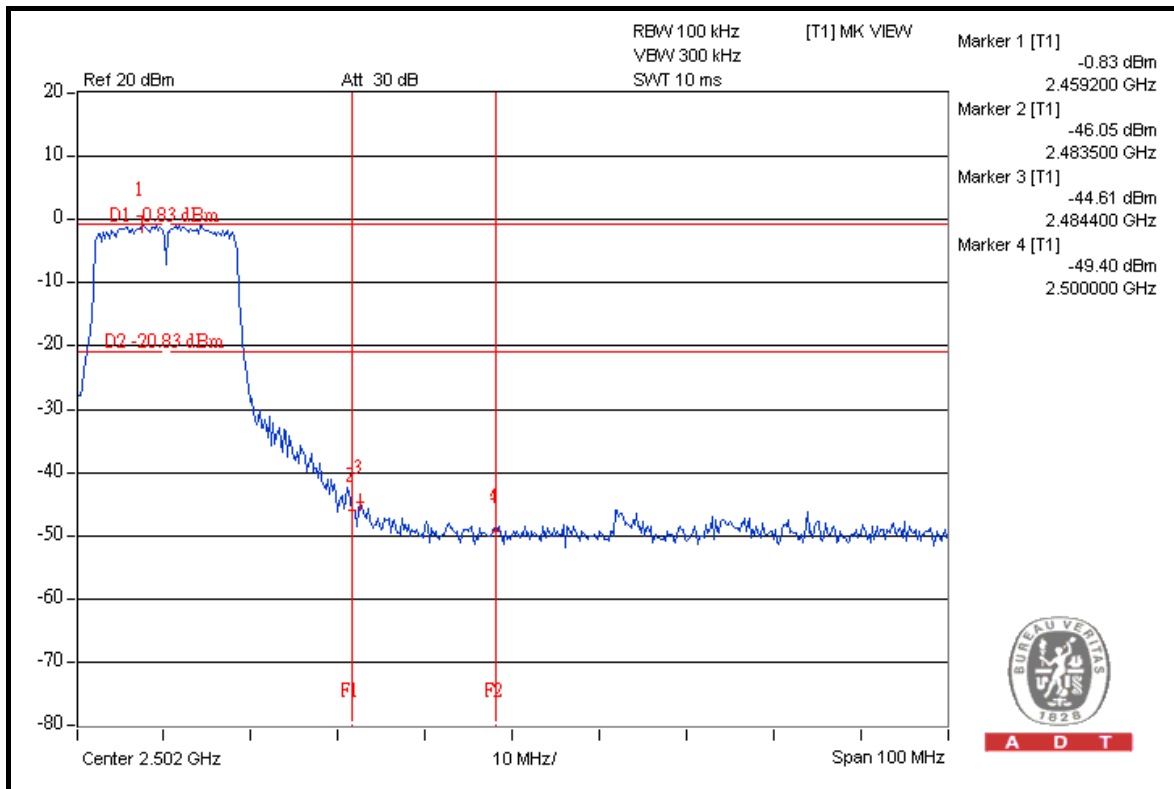

A D T



A D T

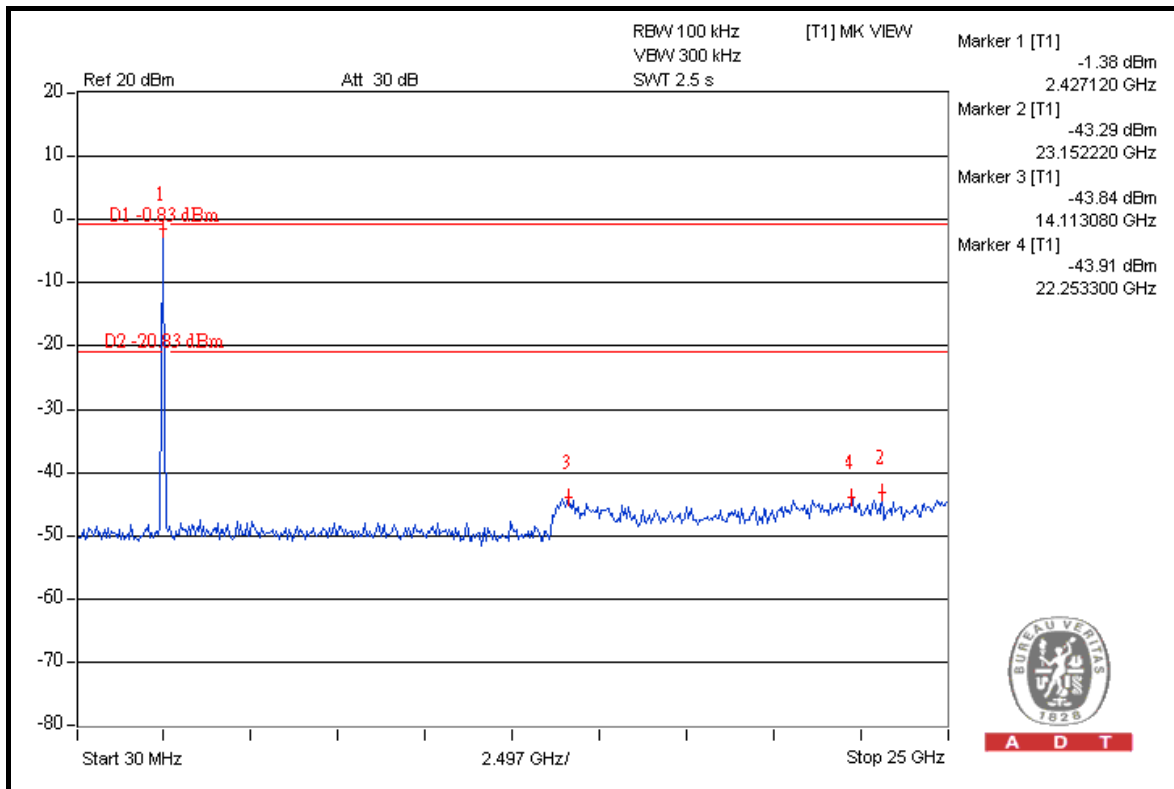
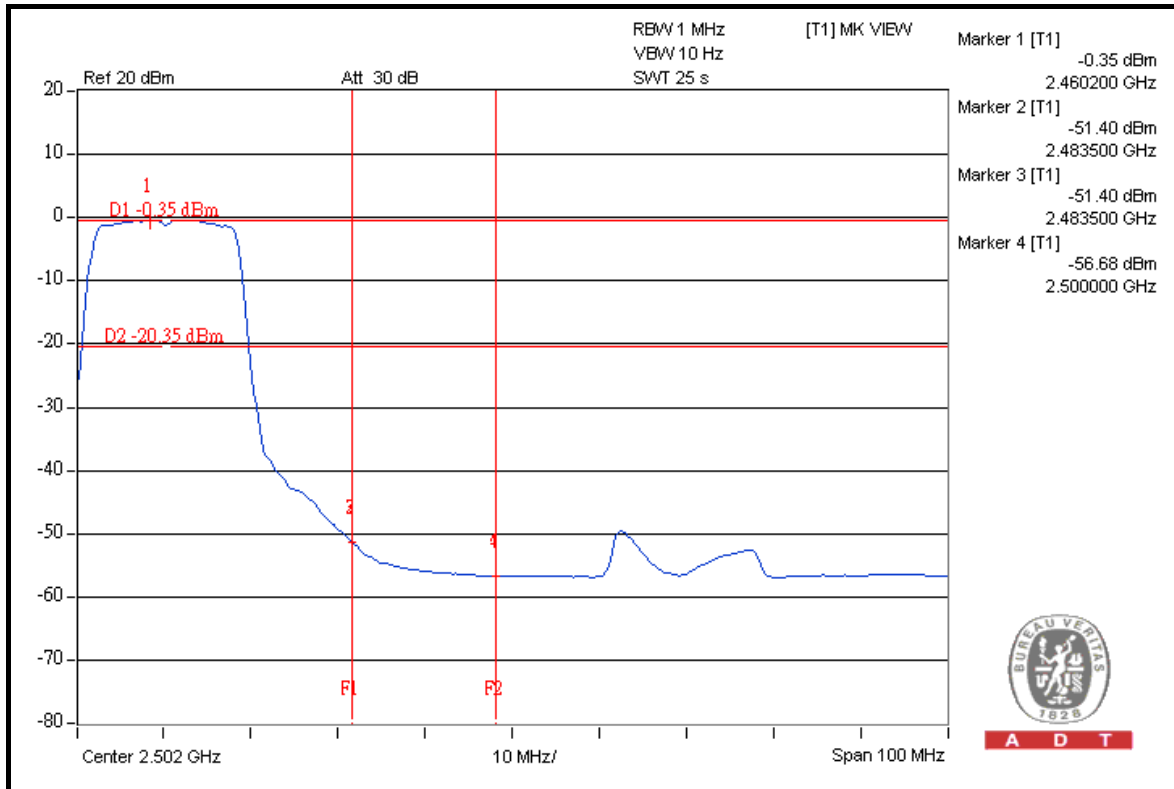



DRAFT 802.11n (20MHz) OFDM MODULATION

NOTE 1: The band edge emission plot on the next page shows 40.25dBc between carrier maximum power and local maximum emission in restrict band (2.35960GHz). The emission of carrier strength list in the test result of channel 1 at the item 4.1.7 is 104.75dBuV/m (Peak), so the maximum field strength in restrict band is $104.75 - 40.25 = 64.50$ dBuV/m which is under 74dBuV/m limit.

The band edge emission plot of on the next page shows 45.14dBc between carrier maximum power and local maximum emission in restrict band (2.36000GHz). The emission of carrier strength list in the test result of channel 1 at the item 4.1.7 is 94.67dBuV/m (Average), so the maximum field strength in restrict band is $94.67 - 45.14 = 49.53$ dBuV/m which is under 54dBuV/m limit.

NOTE 2: The band edge emission plot on the next second page shows 42.17dBc between carrier maximum power and local maximum emission in restrict band (2.49780GHz). The emission of carrier strength list in the test result of channel 11 at the item 4.1.7 is 105.73dBuV/m (Peak), so the maximum field strength in restrict band is $105.73 - 42.17 = 63.56$ dBuV/m which is under 74dBuV/m limit.

The band edge emission plot on the next third page shows 51.30dBc between carrier maximum power and local maximum emission in restrict band (2.48350GHz). The emission of carrier strength list in the test result of channel 11 at the item 4.1.7 is 95.37dBuV/m (Average), so the maximum field strength in restrict band is $95.37 - 51.30 = 44.07$ dBuV/m which is under 54dBuV/m limit.



A D T

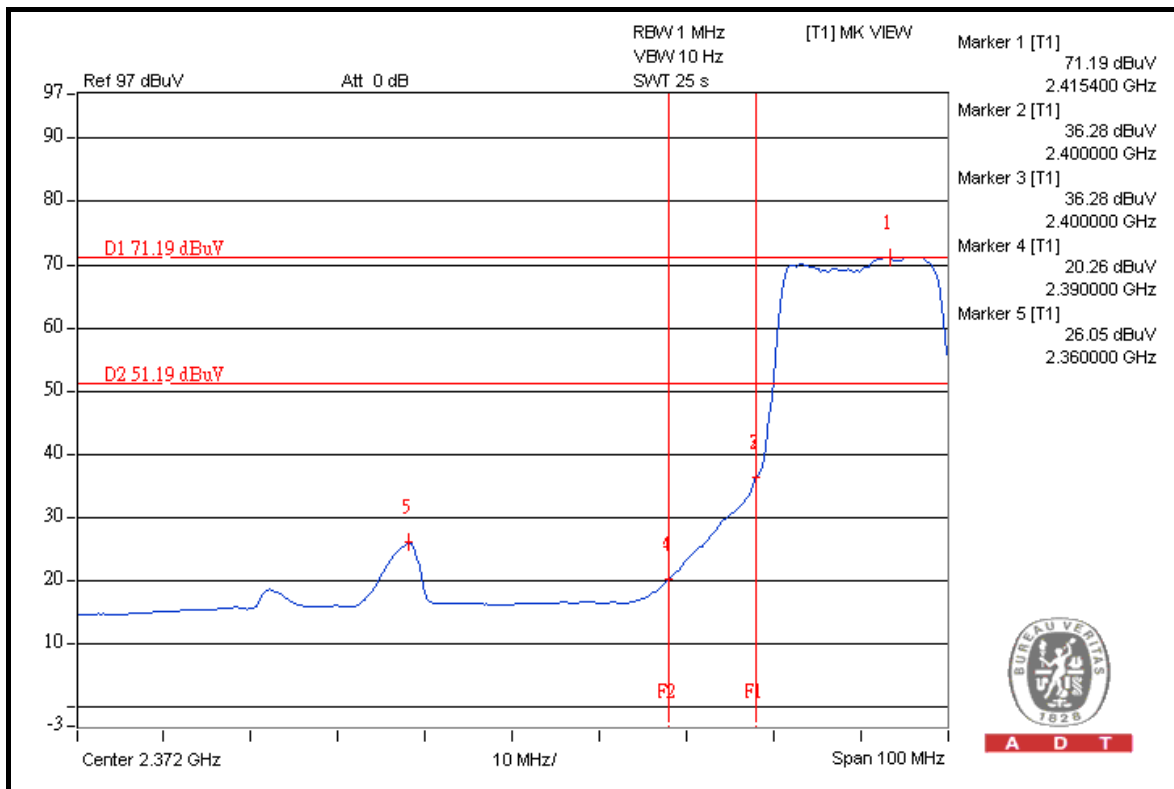
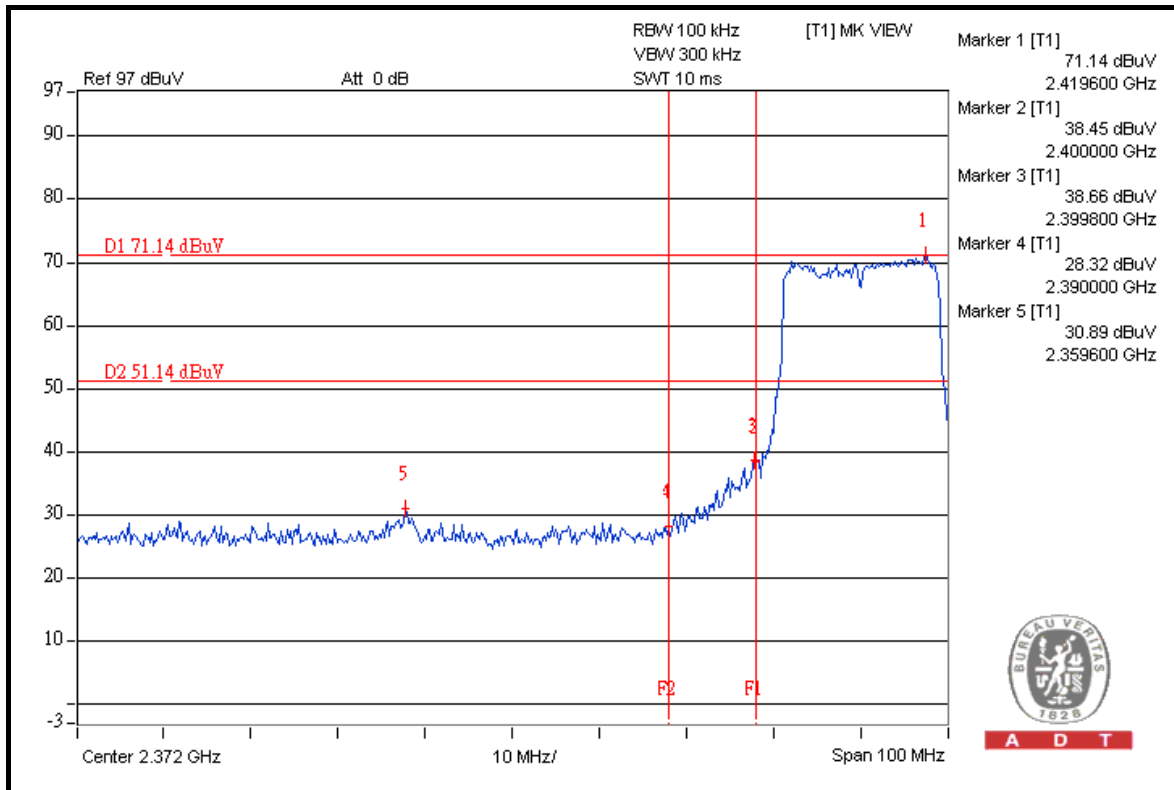



A D T

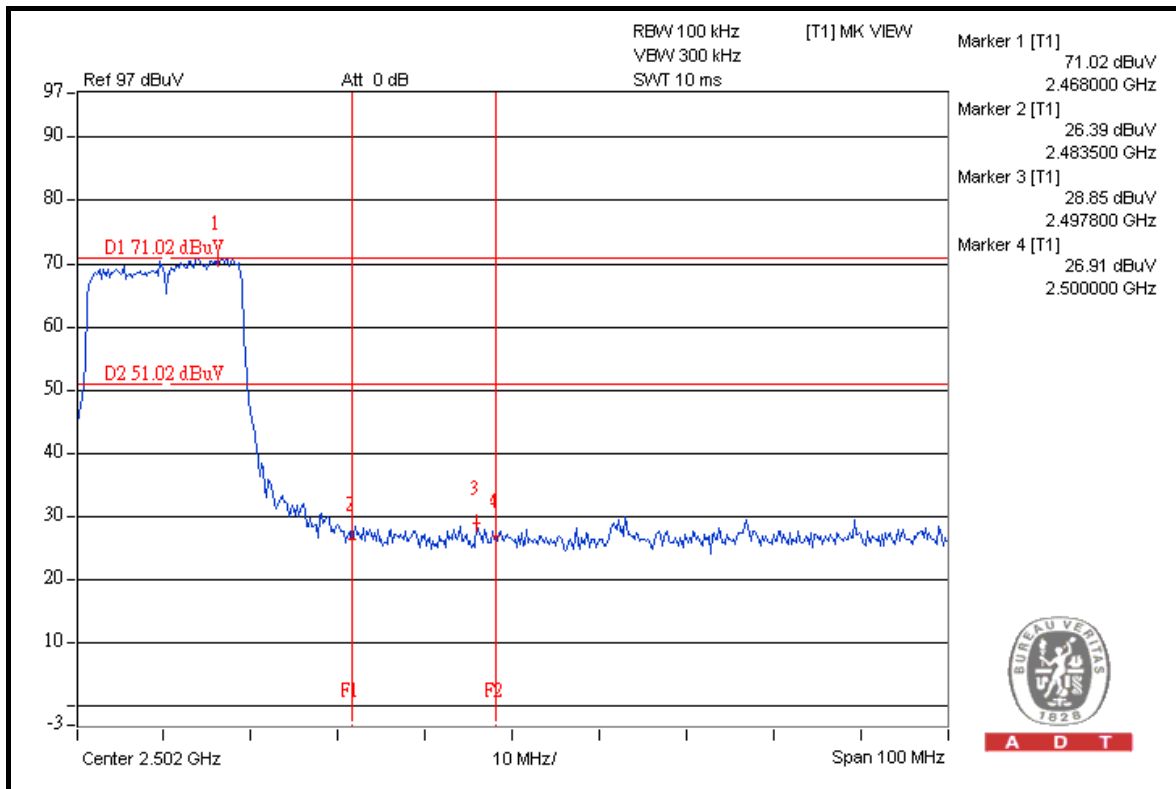
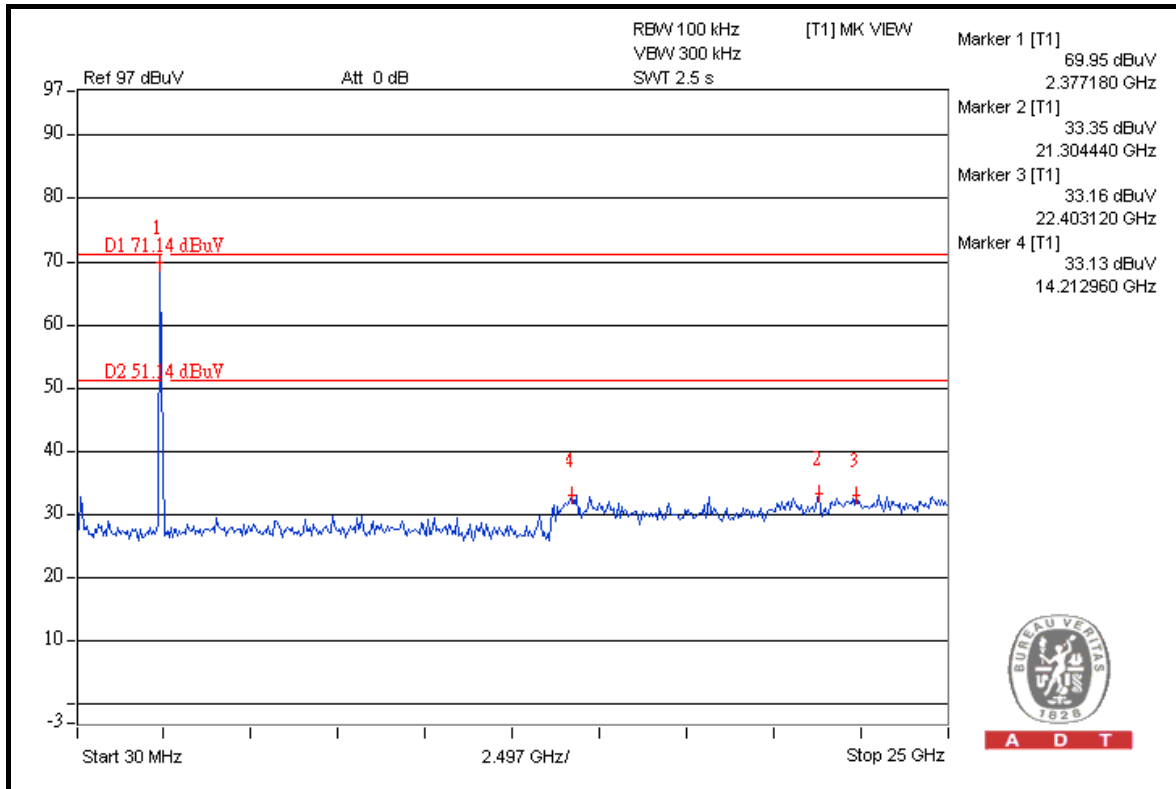



A D T

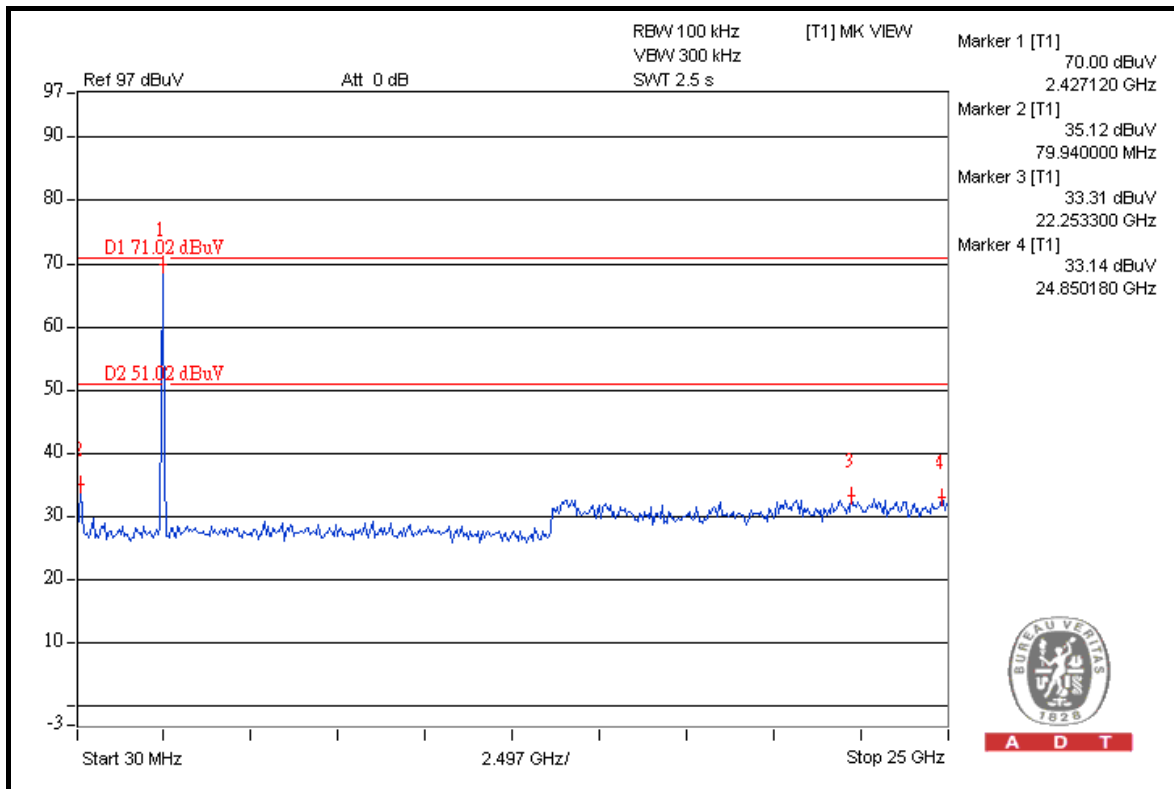
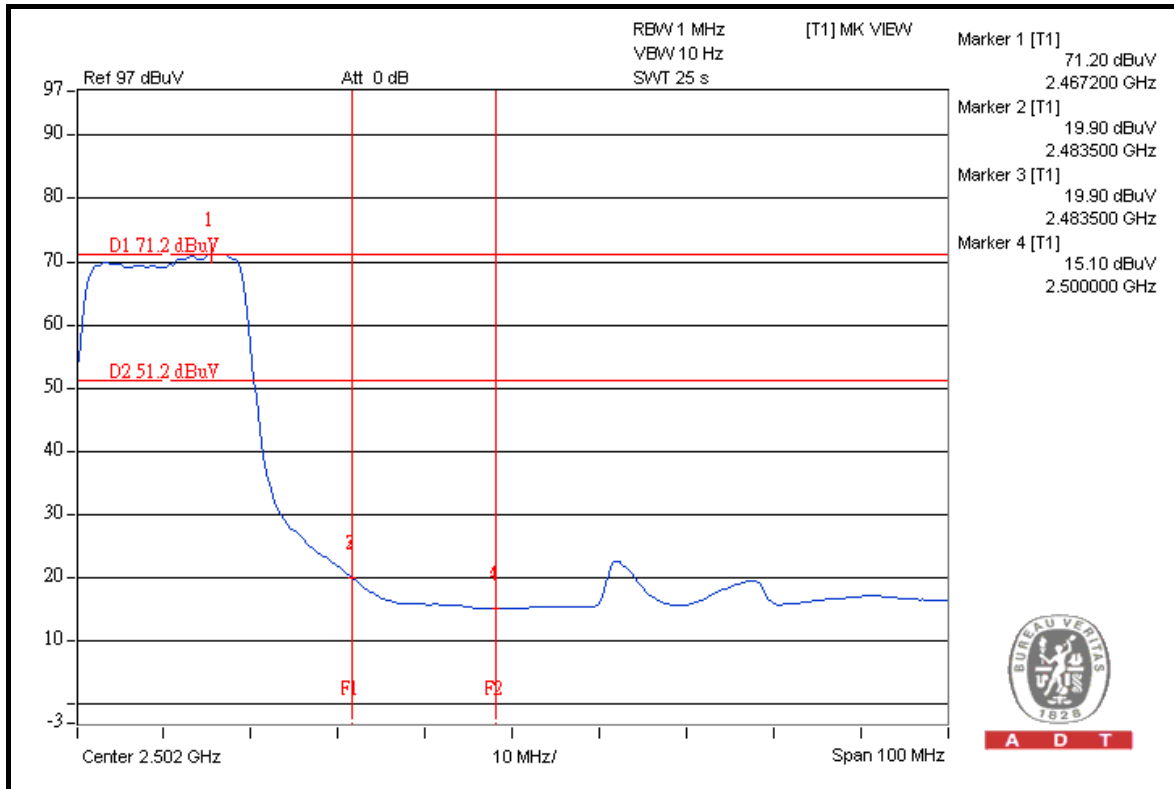

DRAFT 802.11n (40MHz) OFDM MODULATION

NOTE 1: The band edge emission plot on the next page shows 35.73dBc between carrier maximum power and local maximum emission in restrict band (2.38960GHz). The emission of carrier strength list in the test result of channel 1 at the item 4.1.7 is 101.80dBuV/m (Peak), so the maximum field strength in restrict band is $101.80 - 35.73 = 66.07$ dBuV/m which is under 74dBuV/m limit.

The band edge emission plot of on the next page shows 40.35dBc between carrier maximum power and local maximum emission in restrict band (2.39000GHz). The emission of carrier strength list in the test result of channel 1 at the item 4.1.7 is 92.06dBuV/m (Average), so the maximum field strength in restrict band is $92.06 - 40.35 = 51.71$ dBuV/m which is under 54dBuV/m limit.

NOTE 2: The band edge emission plot on the next second page shows 39.00dBc between carrier maximum power and local maximum emission in restrict band (2.49200GHz). The emission of carrier strength list in the test result of channel 7 at the item 4.1.7 is 102.57dBuV/m (Peak), so the maximum field strength in restrict band is $102.57 - 39.00 = 63.57$ dBuV/m which is under 74dBuV/m limit.

The band edge emission plot on the next third page shows 44.68dBc between carrier maximum power and local maximum emission in restrict band (2.48350GHz). The emission of carrier strength list in the test result of channel 7 at the item 4.1.7 is 92.75dBuV/m (Average), so the maximum field strength in restrict band is $92.75 - 44.68 = 48.07$ dBuV/m which is under 54dBuV/m limit.



A D T

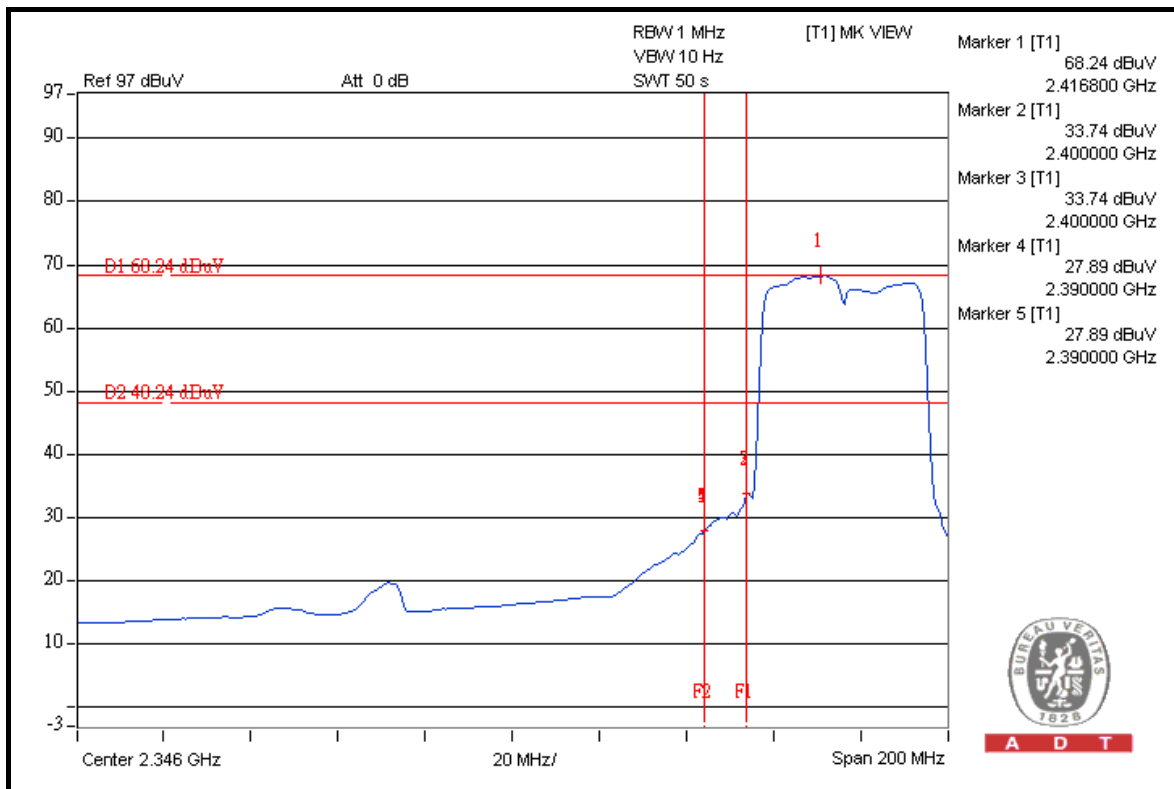
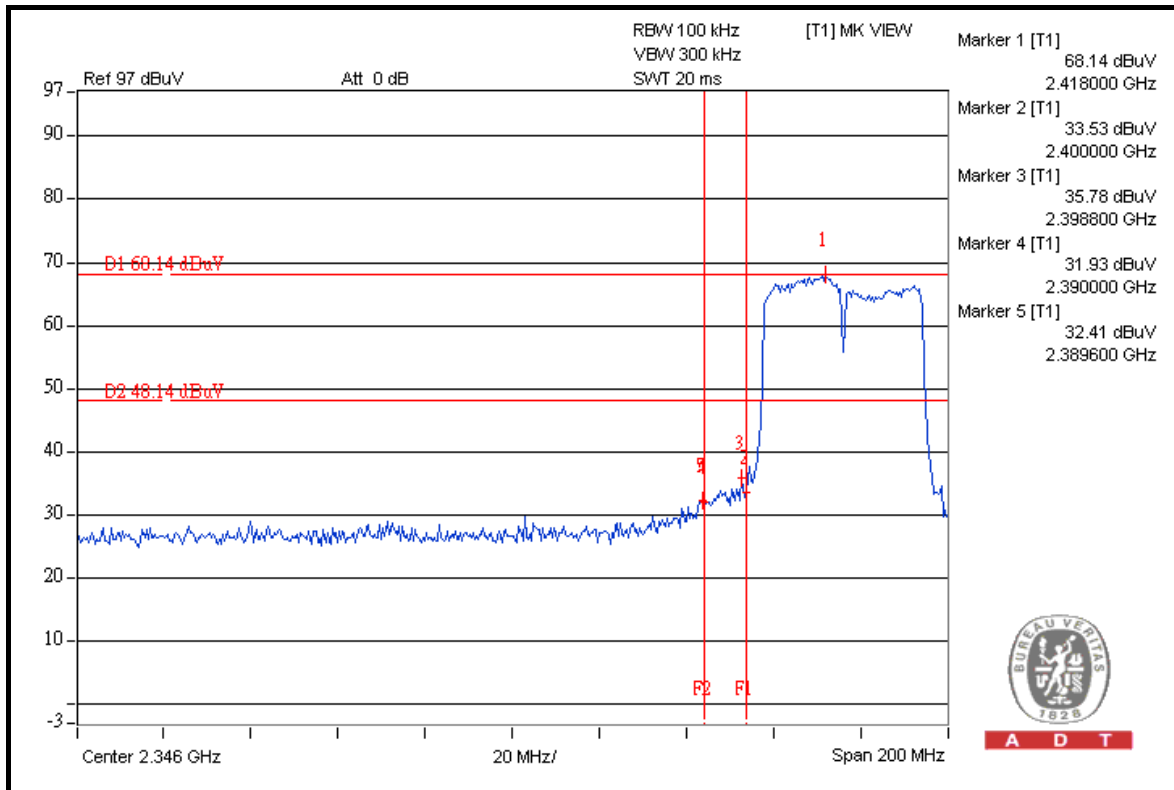



A D T

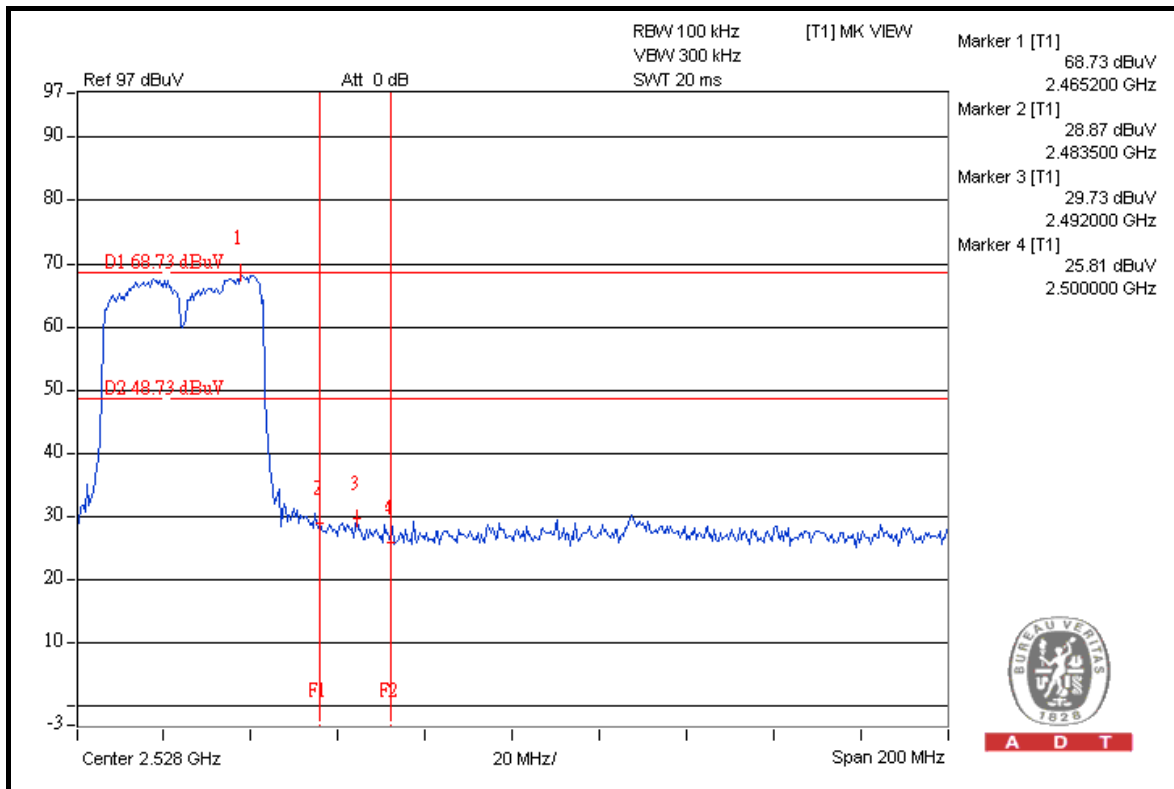
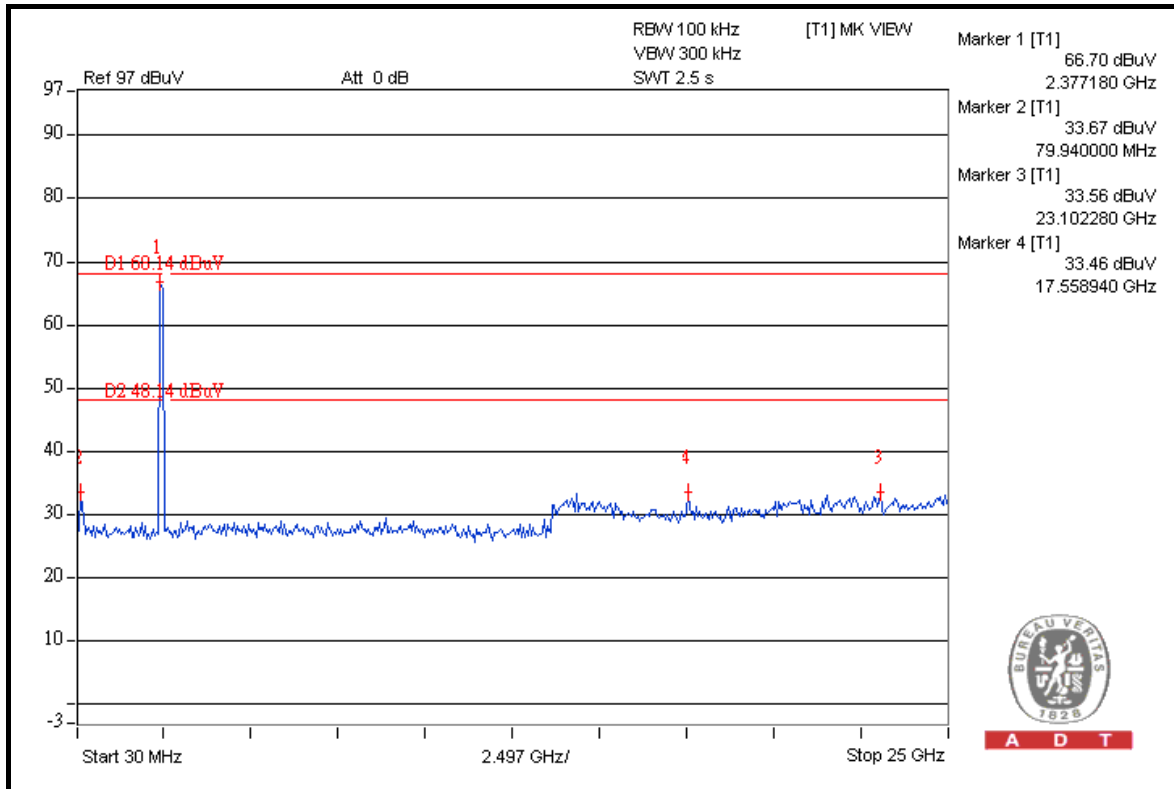



A D T

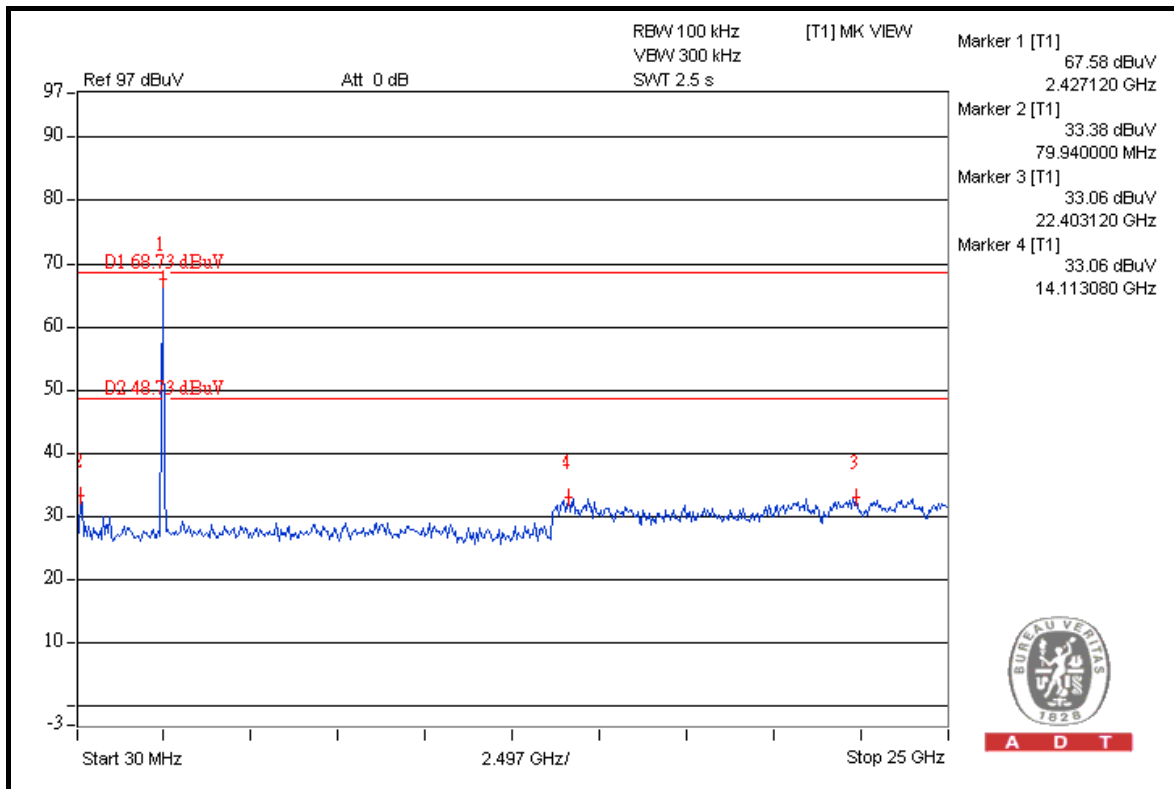
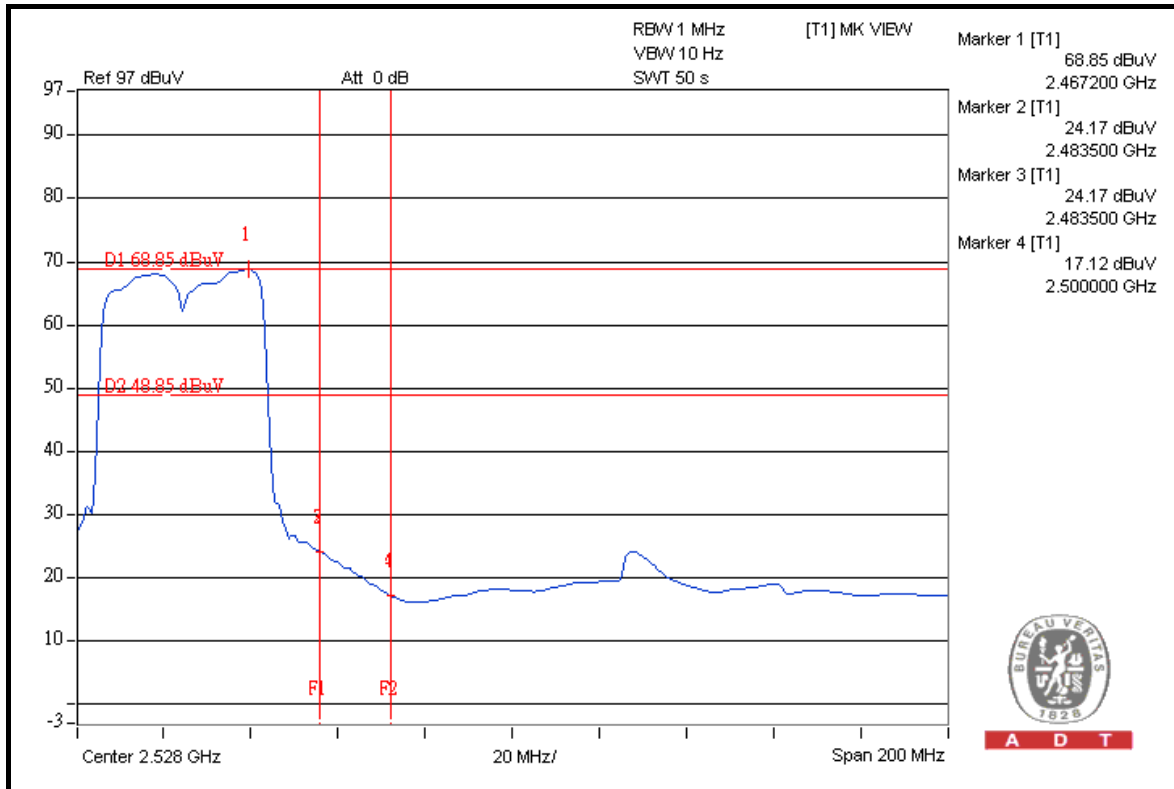



A D T

4.7 ANTENNA REQUIREMENT

4.7.1 STANDARD APPLICABLE

For intentional device, according to FCC 47 CFR Section 15.203, an intentional radiator shall be designed to ensure that no antenna other than that furnished by the responsible party shall be used with the device.

And according to FCC 47 CFR Section 15.247 (b), if transmitting antennas of directional gain greater than 6dBi are used, the power shall be reduced by the amount in dB that the directional gain of the antenna exceeds 6dBi.

4.7.2 ANTENNA CONNECTED CONSTRUCTION

The antenna used in this product is printed antenna without connector. The maximum gain of the antenna is 1dBi.



A D T

5. PHOTOGRAPHS OF THE TEST CONFIGURATION

Please refer to the attached file (Test Setup Photo).



A D T

6. INFORMATION ON THE TESTING LABORATORIES

We, Bureau Veritas Consumer Products Services (H.K.) Ltd., Taoyuan Branch, were founded in 1988 to provide our best service in EMC, Radio, Telecom and Safety consultation. Our laboratories are accredited and approved by the following approval agencies according to ISO/IEC 17025.

USA	FCC, NVLAP
Germany	TUV Rheinland
Japan	VCCI
Norway	NEMKO
Canada	INDUSTRY CANADA, CSA
R.O.C.	TAF, BSMI, NCC
Netherlands	Telefication
Singapore	GOST-ASIA(MOU)
Russia	CERTIS(MOU)

Copies of accreditation certificates of our laboratories obtained from approval agencies can be downloaded from our web site:

www.adt.com.tw/index.5/phtml. If you have any comments, please feel free to contact us at the following:

Linko EMC/RF Lab:

Tel: 886-2-26052180

Fax: 886-2-26051924

Hsin Chu EMC/RF Lab:

Tel: 886-3-5935343

Fax: 886-3-5935342

Hwa Ya EMC/RF/Safety Telecom Lab:

Tel: 886-3-3183232

Fax: 886-3-3185050

Web Site: www.adt.com.tw

The address and road map of all our labs can be found in our web site also.



A D T

7. APPENDIX A - MODIFICATIONS RECORDERS FOR ENGINEERING CHANGES TO THE EUT BY THE LAB

No any modifications are made to the EUT by the lab during the test.

---END---