



Test Report Summary

FCC CFR 47, Part 22

Subpart H Cellular Radiotelephone Service

Manufacturer: ADC Telecommunications

Name of Equipment: FlexWave™ Prism – Cellular 40 Watt

Model Number(s): FWP-B810100MOD

Manufacturer's Address: P.O. Box 1101
Minneapolis, MN 55440-1101

Test Report Number: MN100611 Cellular 40 Watt

Test Date(s): 8 June, 2010 (Intertek)
7, 9, 10 June (ADC)

According to testing performed at Intertek, the above-mentioned unit is in accordance with the applicable electromagnetic compatibility (EMC) portions of the requirements defined in FCC Part 22.

It is the manufacturer's responsibility to assure that additional production units of this model are manufactured with identical electrical and mechanical characteristics. Any modifications necessary for compliance made during testing on the above mentioned date(s) must be implemented in all production units for compliance to be maintained.

All testing was done in accordance with the Federal Communications Commission's CFR 47 Part 22 and the EUT fulfills the requirements of the Federal Communications Commission's CFR 47 Part 22.

Date: 11 June, 2010

Location: Intertek Testing Services (INTERTEK)
7250 Hudson Blvd., Suite 100
Oakdale, MN 55128
Phone: (651) 730-1188
Fax: (651) 730-1282

ADC Telecommunications
1187 Park Place
Shakopee, MN 55379
Phone: (952) 403-8340

Testing Conducted by (ADC):
And Report Written by:

A handwritten signature in blue ink, appearing to read 'Joshua J. Wittman', written over a horizontal line.

Joshua J. Wittman
Compliance Engineer



EMC Emission – T E S T R E P O R T

Test Report File Number: MN100611_Cellular 40 Watt

Date of Issue: 11 June, 2010

Model Number(s): FWP-B810100MOD

Product Name: FlexWave™ Prism – Cellular 40 Watt

Product Type: Repeater

Applicant: ADC Telecommunications

Manufacturer: ADC Telecommunications

License Holder: ADC Telecommunications

Address: P.O. Box 1101
Minneapolis, MN 55440-1101

Test Result: **Positive** Negative

Test Project Number: 100124687MIN-001

Reference(s)

Total pages including Appendices: 95



1.0 TABLE OF CONTENTS

1.0	Table of Contents	3
2.0	Revision Description	4
3.0	Documentation	4
3.1	Test Regulations	4
3.2	Test Operation Mode	5
3.3	Configuration of the Device Under Test:	5
3.4	Product Options:	5
3.5	EUT Specifications and Requirements:	5
3.6	Cables:	5
3.7	Power Requirements:	5
3.8	Typical Installation and/or Operating Environment:	5
3.9	Other Special Requirements:	5
3.10	EUT Software:	5
3.11	EUT System Components	6
3.12	Support Equipment	6
3.13	Deviations from Standard:	6
3.14	General Remarks:	6
3.15	Summary:	6
4.0	Test Set-Up Drawings and Photos	7
4.1	Test Set-up Photo, Radiated Emissions	7
4.2	Test Set-up Photo, Radiated Emissions	8
4.3	Test Set-up Drawings	9
5.0	Test Results	11
5.1.1	22.913 Effective Radiated Power Limits	11
5.1.2	22.355 Frequency Tolerance	12
5.1.3	22.917 Emission Limitations Cellular	13
6.0	Test Equipment	14
7.0	Appendix A	15
7.1	Conducted Emission Limits Test	16
7.2	Conducted Output Power Test	29
7.3	Frequency Stability Test	44
7.4	Intermodulation Test	45
7.5	Occupied Bandwidth Modulation Test	54
8.0	Appendix B	93
9.0	Appendix C	95



2.0 REVISION DESCRIPTION

Rev	Total Pages	Date	Description
A	95	11 June, 2010	Original Release

3.0 DOCUMENTATION

3.1 Test Regulations

22.355	Frequency Tolerance
22.913	Effective Radiated Power Limits
22.917	Emission Limitations for Cellular

The emissions tests were performed according to the following regulations:

■ FCC Part 22

- FCC Part 24
- FCC Part 90
- IC RSS-131 Issue 2

Environmental Conditions in the lab:

ADC

Temperature: 24° C
Relative Humidity: 35%
Atmospheric Pressure: 100.2 kPa

INTERTEK

15-35° C
30-60%
86-106 kPa

Power Supply Utilized:

Power Supply System : 120 VAC, Single Phase

3.2 Test Operation Mode

- Standby
- Test Program
- Practice Operation

■ Max composite in and out

3.3 Configuration of the Device Under Test:

Normal Operation – Cellular - 869 to 894 MHz

3.4 Product Options:

None

3.5 EUT Specifications and Requirements:

Length: 10.0"
Width: 12.0"
Height: 40.0"
Weight: 150 pounds

3.6 Cables:

Cable Type	Length	From	To
RF	> 3M	Ancillary Equip	EUT
RF	< 3M	EUT	50 Ohm Load
Power	< 3M	Power	Input Power
Fiber	> 3M	Ancillary Equip	EUT

3.7 Power Requirements:

Voltage: 120 VAC
Amps: 5.8 A

3.8 Typical Installation and/or Operating Environment:

Outdoor/Indoor. System is typically employed as an outdoor repeater.

3.9 Other Special Requirements:

None

3.10 EUT Software:

Revision Level: Version V.6 or greater
Description: Internet Explorer

3.11 EUT System Components

Description	Model #	Serial #	FCC ID #
Prism Chassis	FP3-0000000000000111	None	
Cellular 40 Watt Module	FWP-B410000MOD	None	

3.12 Support Equipment

Description	Manufacturer	Model #	FCC ID #
Power Meter	HP	437B	
Signal Generator	Aeroflex	3413	
Attenuator	Aeroflex	86-30-12	

3.13 Deviations from Standard:

Modifications required to pass:

- As indicated on the data sheet(s)

■ **None**

Test Specification Deviations; Additions to or Exclusions from:

- As indicated in the Test Plan

■ **None**

3.14 General Remarks:

None.

3.15 Summary:

The requirements according to the technical regulations are

■ **met**

- not Met

The equipment under test does

■ **fulfill the general approval requirements mentioned in Section 3.1.**

- not fulfill the general approval requirements mentioned in Section 3.1.

4.0 TEST SET-UP DRAWINGS AND PHOTOS

[Table of Contents: Section 1.0](#)

4.1 Test Set-up Photo, Radiated Emissions

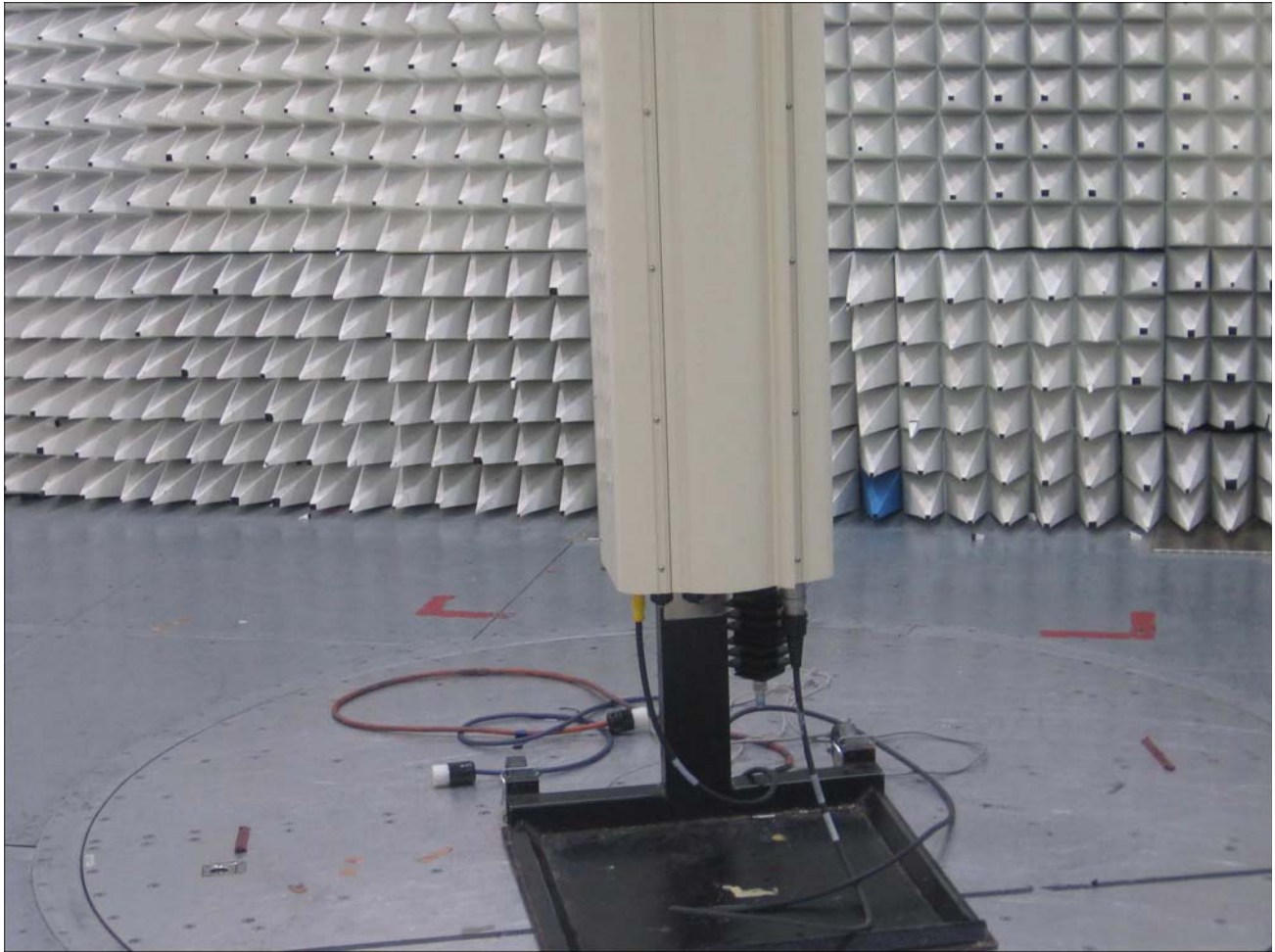

4.2 Test Set-up Photo, Radiated Emissions

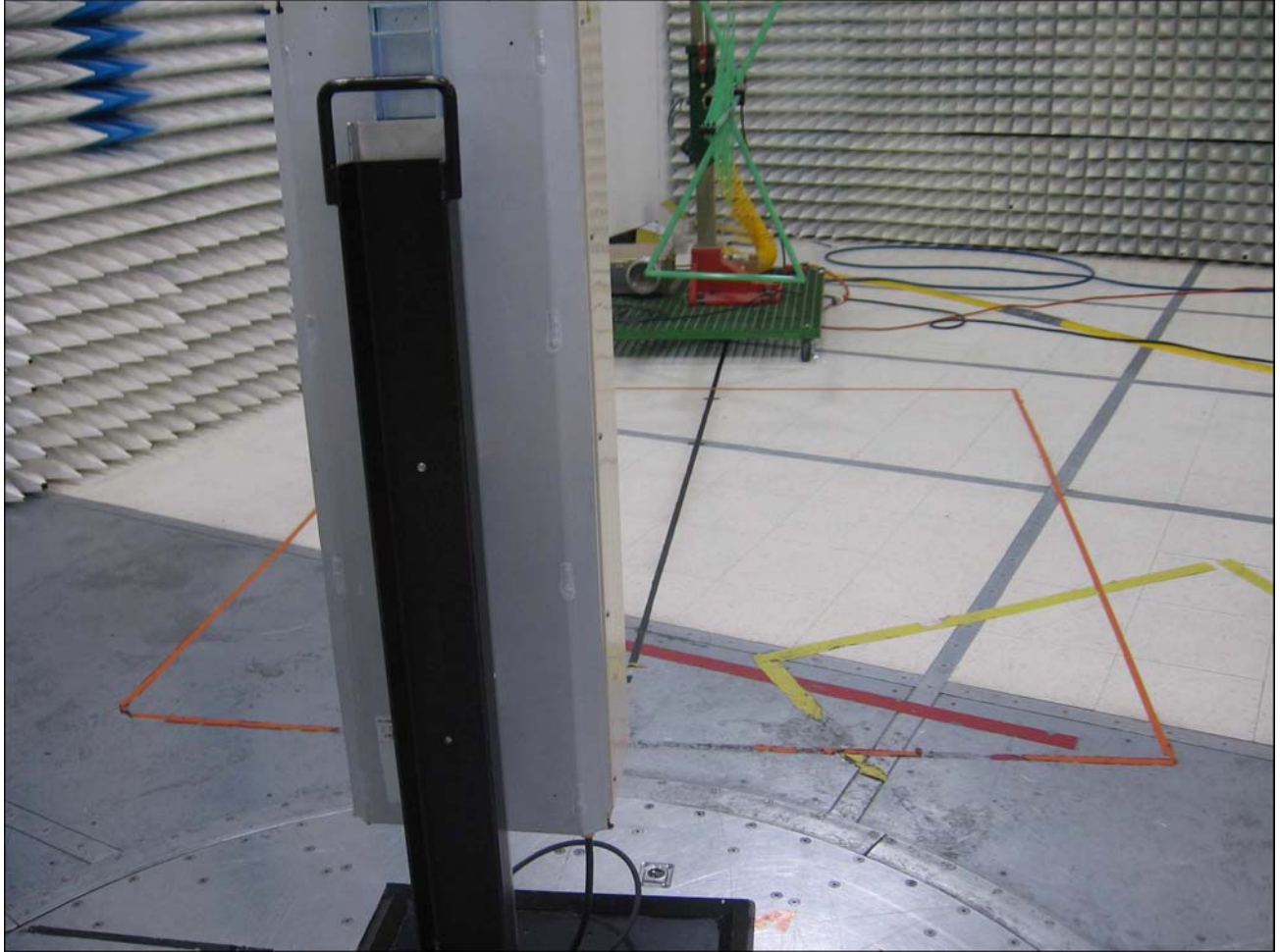

4.3 Test Set-up Drawings

Conducted and Radiated Emission Limits Test

Conducted Output Power Test

Inter-Modulation Test

Occupied Bandwidth Modulation Test

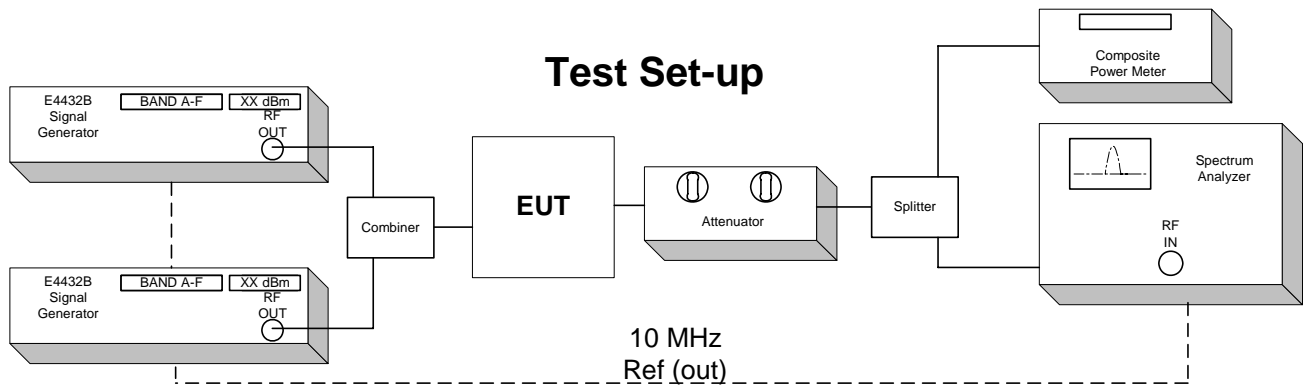

Frequency Tolerance Test

EUT is specified for outdoor use with temperature range of -30° to $+50^{\circ}$ C, and was tested with its range.

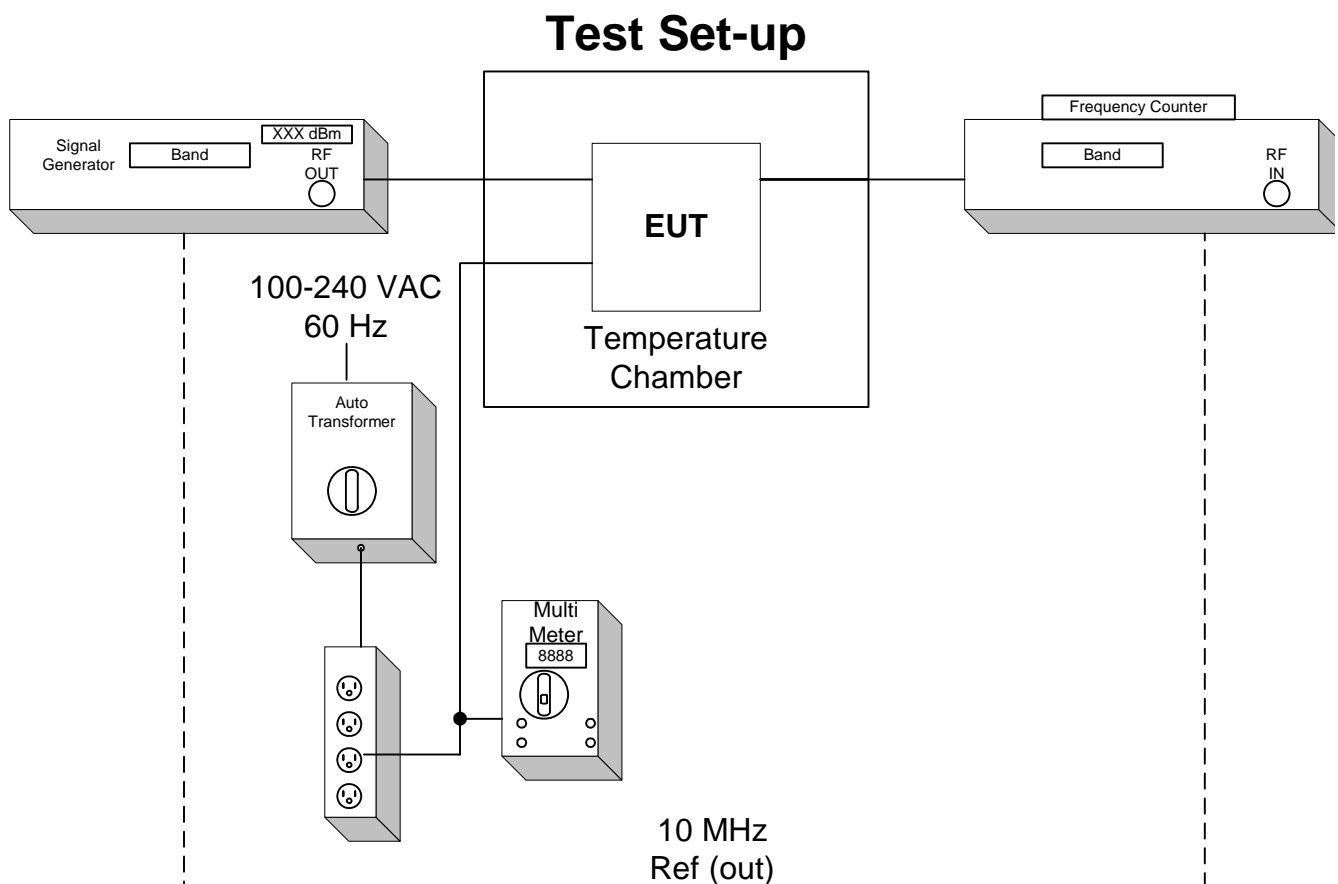

5.0 TEST RESULTS

5.1.1 22.913 Effective Radiated Power Limits

Test Summary:

- The requirements are: **MET** NOT MET

Test Location:

- INTERTEK (Oakdale, MN)
- ADC facility (Shakopee, MN)**

Test Distance:

- 3 Meters
- 10 Meters
- Conducted measurement**

Test Equipment (ADC):

1, 2, 6, 7, 11, 12

Test Limit:

500 Watts or 57 dBm Limit

Test Data:

[Conducted Output Power; Section 7.2](#)

[Table of Contents; Section 1.0](#)

Test Engineer: Joshua J. Wittman

Date: 9 June, 2010

5.1.2 22.355 Frequency Tolerance

Test Summary:

- The requirements are: ■ **MET** □ NOT MET
- The fundamental emission stays within the limit.
- Frequency measured over a temperature range of -30 to 50° C and an input voltage range of 100 to 240 VAC.

Test Location:

- INTERTEK (Oakdale, MN)
- **ADC facility (Shakopee, MN)**

Test Equipment (ADC):

3, 4, 5, 6, 9, 10

Test Limit:

TABLE C-1.—FREQUENCY TOLERANCE FOR TRANSMITTERS IN THE PUBLIC MOBILE SERVICES

Frequency range (MHz)	Base, fixed (ppm)	Mobile ≤3 watts (ppm)	Mobile ≤3 watts (ppm)
25 to 50	20.0	20.0	50.0
50 to 450	5.0	5.0	50.0
450 to 512	2.5	5.0	5.0
821 to 896	1.5	2.5	2.5
928 to 929	5.0	n/a	n/a
929 to 960	1.5	n/a	n/a
2110 to 2220	10.0	n/a	n/a

Test Data:

[Frequency Stability; Section 7.3](#)

[Table of Contents; Section 1.0](#)

Test Engineer: Joshua J. Wittman

Date: 10 June, 2010

5.1.3 22.917 Emission Limitations Cellular

Test Summary:

- The requirements are: **MET** NOT MET
- Out of band emissions were less than -13 dBm.
- Outside the emission bandwidth of the carrier, all emissions are attenuated at least 26 dB below the transmitter power.

Test Location:

INTERTEK (Oakdale, MN)

ADC facility (Shakopee, MN)

Test Equipment (ADC):

1, 2, 6, 7, 11, 12

Test Limit:

Out of band emissions:

Attenuated below the transmitting power (P) by a factor of at least $43 + 10\log(P)$ dB, or -13 dBm.

Outside of the carrier emissions bandwidth:

26 dB below the transmitter power

Test Data:

[Conducted Emissions; Section 7.1](#)

[Intermodulation; Section 7.4](#)

[Occupied Bandwidth; Section 7.5](#)

Radiated Emissions; ([Appendix B](#))

Test Engineer: Joshua J. Wittman

Date: 7 June, 2010

Date: 9 June, 2010

Date: 9 June, 2010

[Table of Contents; Section 1.0](#)

6.0 TEST EQUIPMENT

[Table of Contents: Section 1.0](#)

Number	Description	Manufacturer	Model	ADC Serial Number	Cal Due	Used
1	Spectrum Analyzer	HP	8563E	MC27690	12-23-10	☒
2	Power Meter	HP	437B	MC54002	4-22-11	☒
3	Multimeter	Fluke	79	MC18758	6-15-11	☒
4	Frequency Counter	HP	5347A	MC27569	7-6-10	☒
5	Temperature Chamber	ESPEC	PSL-4G	MC18966	7-22-10	☒
6	Signal Generator	Aeroflex	3413	MC57343	6-18-10	☒
7	Signal Generator	Aeroflex	3413	MC57947	4-15-11	☒
8	Variable Auto Transformer	Staco	1520CT	MC44655	CNR	☒
9	Digital Barometer	Fisher Scientific	02-403	MC50719	12-10-10	☒
10	Attenuator	Aeroflex	49-30-33	N/A	CNR	☒
11	Attenuator	Aeroflex	86-30-12	N/A	CNR	☒
12	RF Power Sensor	Agilent	8482H	MC27519	7-14-10	☒

Equipment with a Calibration Not Required (CNR) listing is verified and compensated for with NIST traceable calibrated equipment.

7.0

APPENDIX A

Conducted Emissions Test Data

[Table of Contents: Section 1.0](#)

Test Engineer: Joshua J. Wittman

7.1 Conducted Emission Limits Test

[Table of Contents: Section 1.0](#)

[Back to Emission Limits: Section 5.1.3](#)

The out of band emissions were measured directly from the EUT antenna output with a spectrum analyzer from 30 MHz to the 10th harmonic of the highest carrier frequency. Test signals used are GSM, EDGE, CDMA, W-CDMA, LTE 1.4MHz BW, LTE 3MHz BW, LTE 5 MHz BW, LTE 10MHz BW, LTE 15MHz BW, and LTE 20MHz BW. The different signals were input one at a time to the EUT. In all cases, the out of band emissions were less than -13 dBm from the equation

$$(19\text{dBm} - [43 + 10\log(0.08\text{W})])$$

Band edge compliance is also demonstrated using a GSM, EDGE, CDMA, W-CDMA, LTE 1.4MHz BW, LTE 3MHz BW, LTE 5 MHz BW, LTE 10MHz BW, LTE 15MHz BW, and LTE 20MHz BW signal at the upper and lower limits of the band.

The Host unit connects directly to the BTS via coax. The Host unit does not connect to an antenna or amplifier, thus it is a Part 15 device and has been tested and is compliant as such. No FCC ID is necessary.

Industry practice has generally set the input signal power level. Test signal used was \approx -25 dBm input to DHU. Industry practice has generally set the output signal power level.

Prism Remote:

Range: 100 - 240 VAC

Tested @: 120 VAC

Tested @: 5.8 A

Digital Host Unit (DHU):

Range: 21-60 VDC

Tested @: 48 VDC

Tested @: 3.5 A

Application details for 2.1033(c)(8), 2.1033(c)(10), and 2.1033(c)(13):

RF amplifier output stage has three devices with 27.5 VDC voltage applied. Current for device #1 is 3.5A max. Devices #2 and #3 have 1.5A max.

The input to the host unit has a digital attenuation chip (ALC) to provide protection from overdrive with 5-10 millisecond attack time / 100 millisecond decay time and 31 dB of head room, such that single channel operation, or multi-channel operation will not exceed nominal gain of the system.

The frequency stability is derived by the BTS, base transceiver station. This product uses internal frequency stability to keep the signal inside our filter bandwidths. This means that the frequency can change, but the frequency that transmits is still at the original frequency. The remote system uses the data over the fiber optic path to phase/frequency lock to the host. The purpose is to frequency lock the up- and down-conversion local oscillators, and thereby eliminate any end-to-end frequency shift.

The spurious limitation is completed with the duplexer. The ALC also suppresses in-band spurious by preventing PA overdrive, while the duplexer suppresses out-of-band spurious. Internal to the electronics, the use of SAW filters provides for higher Q roll-off at band edges.

This equipment does not modulate the RF, so there is no modulation limiter. This equipment does not change the modulation of the RF or the occupied bandwidth of any channel. It transports the signal, as is, over an optical link. The RF input is not changed in the RF output.

This is a constant gain device, so the setup controls the output. There is an overdrive and overpower limit control that prevents excess power.

Results:
Pass (See plots)

Conducted Emissions CDMA CELLULAR 40 W
Center: 881.5 MHz Span: 5 MHz RBW/VBW: 100 kHz

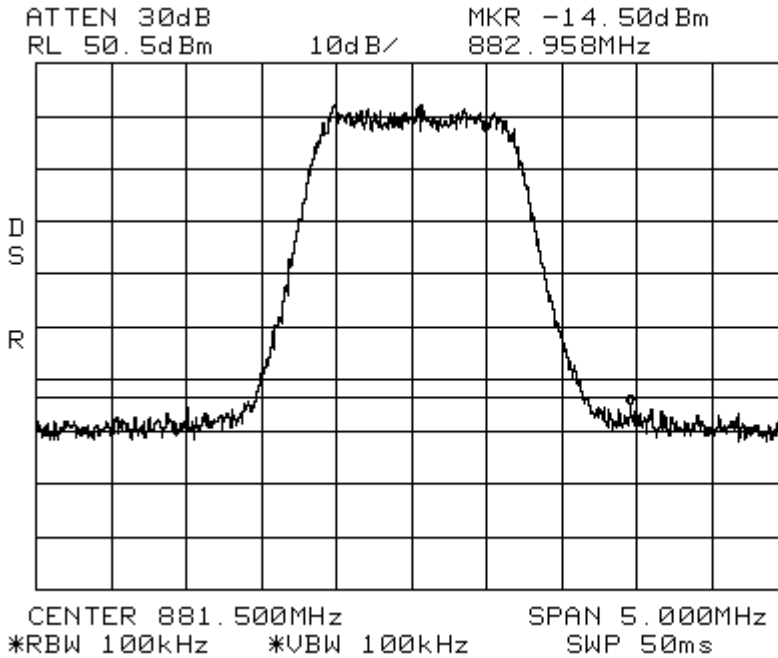

Conducted Emissions CDMA CELLULAR 40 W
Span: 30 MHz to 1 GHz RBW/VBW: 300 kHz

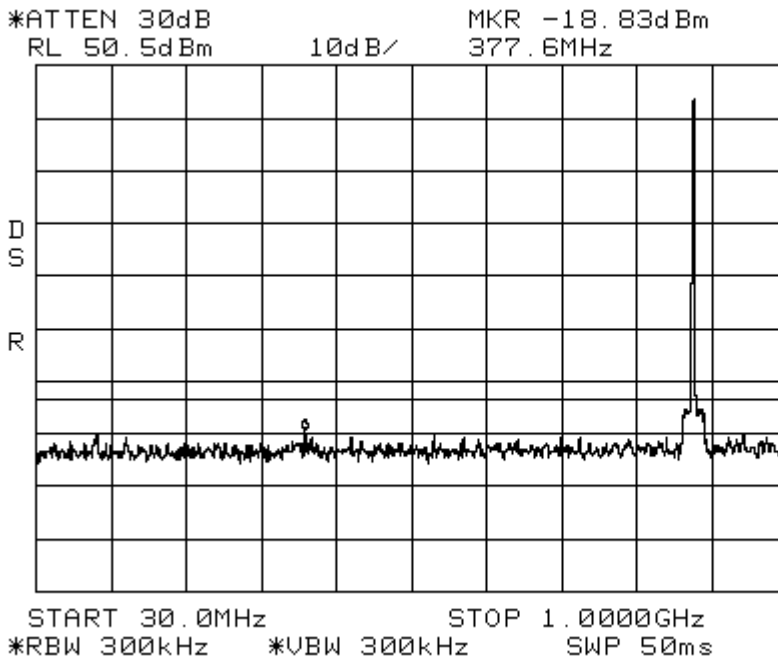

Conducted Emissions
Span: 1 GHz to 10 GHz

CDMA

CELLULAR 40 W
RBW/VBW: 1 MHz

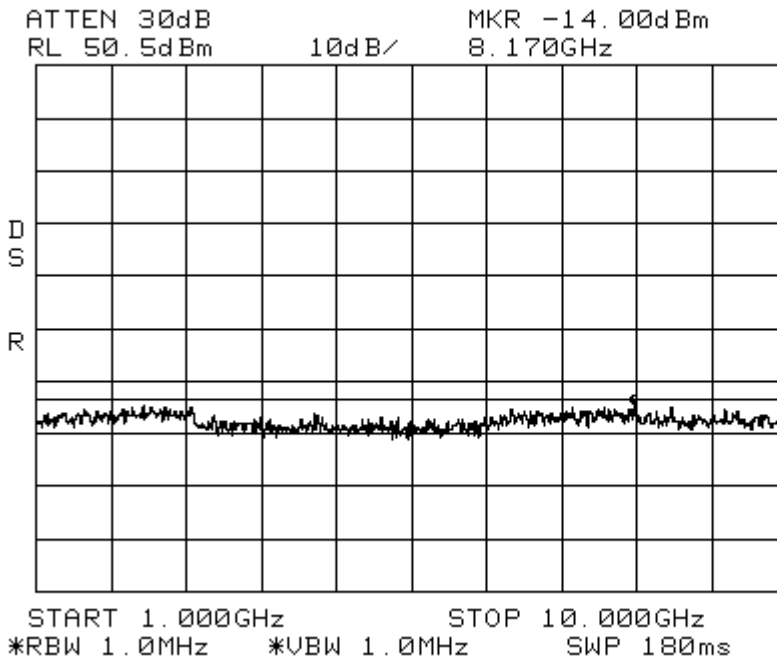

Conducted Emissions
Center: 881.5 MHz Span: 5 MHz

EDGE

CELLULAR 40 W
RBW/VBW: 100 kHz

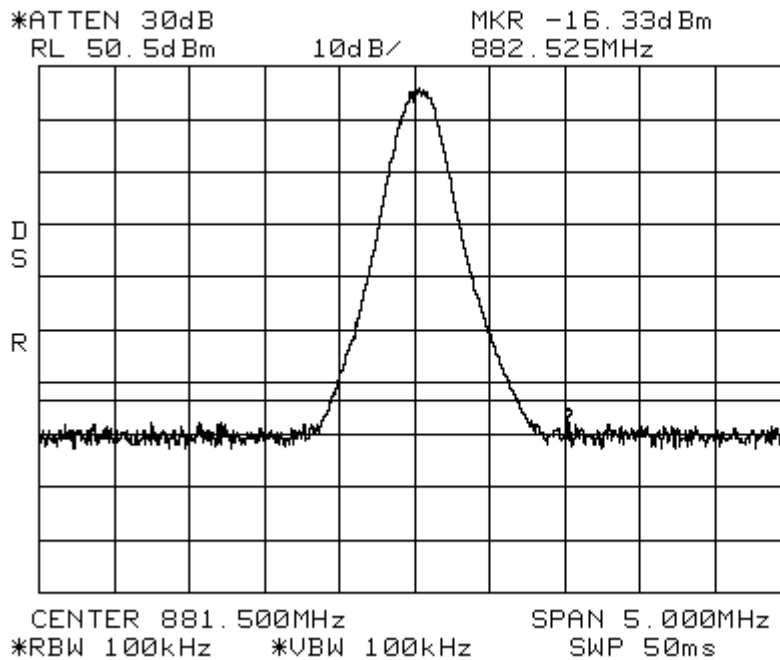

Conducted Emissions
Span: 30 MHz to 1 GHz

EDGE

CELLULAR 40 W
RBW/VBW: 300 kHz

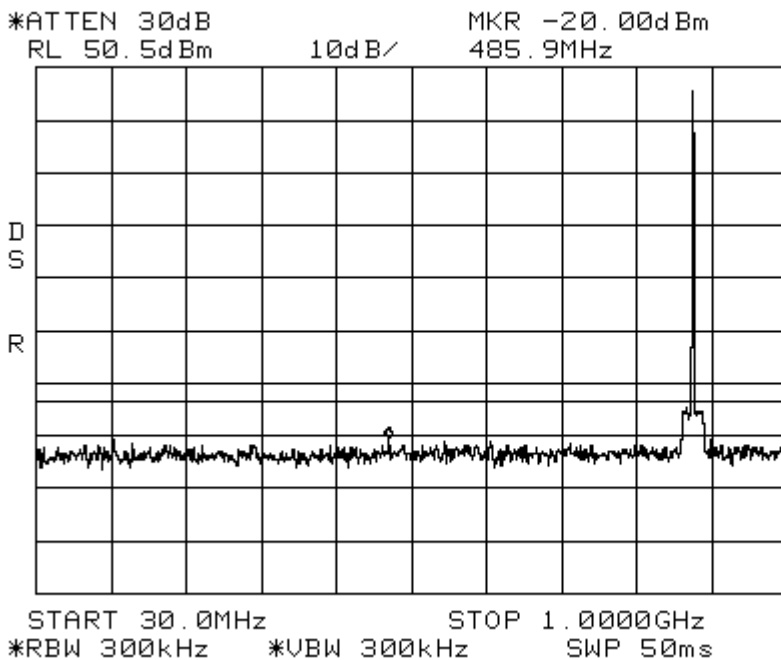

Conducted Emissions
Span: 1 GHz to 10 GHz

EDGE

CELLULAR 40 W
RBW/VBW: 1 MHz

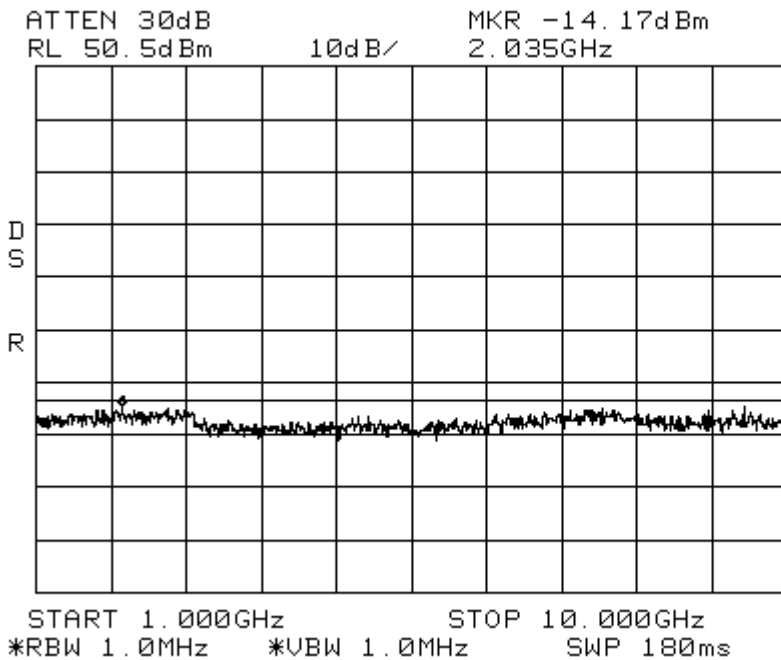

Conducted Emissions GSM CELLULAR 40 W
Center: 881.5 MHz Span: 5 MHz RBW/VBW: 100 kHz
*ATTEN 30dB MKR -15.67dBm
RL 50.5dBm 10dB/ 879.775MHz

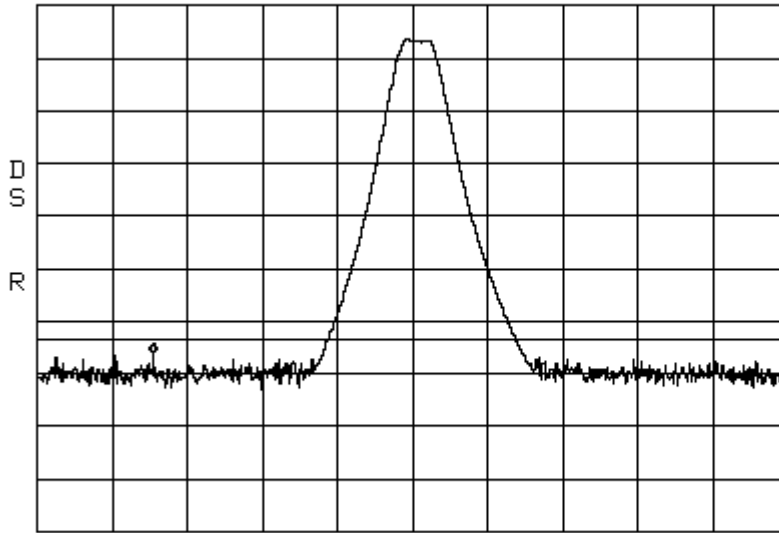

CENTER 881.500MHz SPAN 5.000MHz
*RBW 100kHz *VBW 100kHz SWP 50ms

Conducted Emissions GSM CELLULAR 40 W
Span: 30 MHz to 1 GHz RBW/VBW: 300 kHz

*ATTEN 30dB MKR -19.83dBm
RL 50.5dBm 10dB/ 191.7MHz

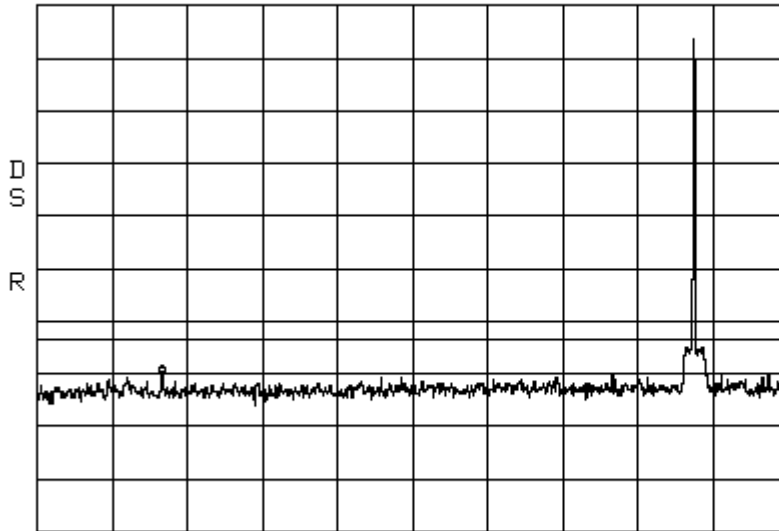

START 30.0MHz STOP 1.0000GHz
*RBW 300kHz *VBW 300kHz SWP 50ms

Conducted Emissions
Span: 1 GHz to 10 GHz

GSM

CELLULAR 40 W
RBW/VBW: 1 MHz

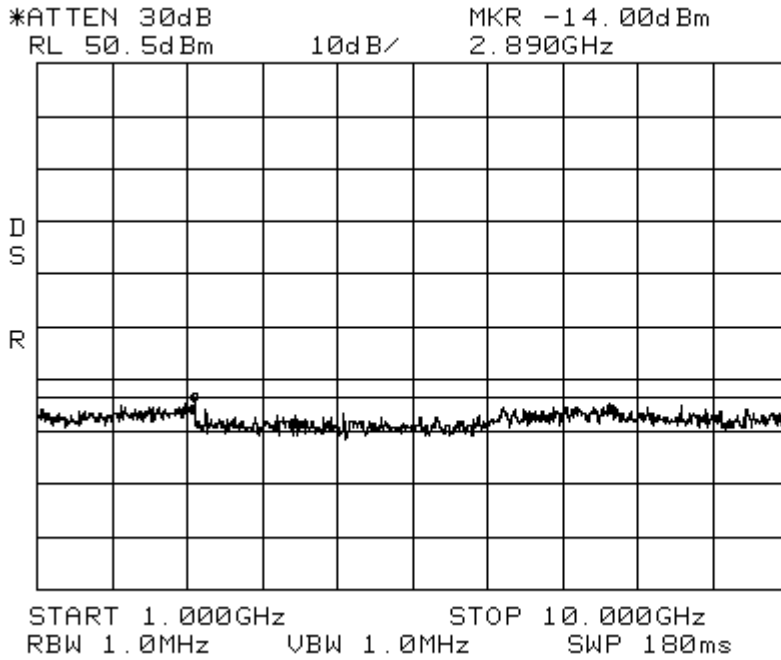

Conducted Emissions LTE 1.4 MHz Channel Bandwidth CELLULAR 40W
Center: 881.5 MHz Span: 5 MHz RBW/VBW: 100 kHz
ATTEN 30dB MKR -14.83dBm
RL 50.5dBm 10dB/ 880.542MHz

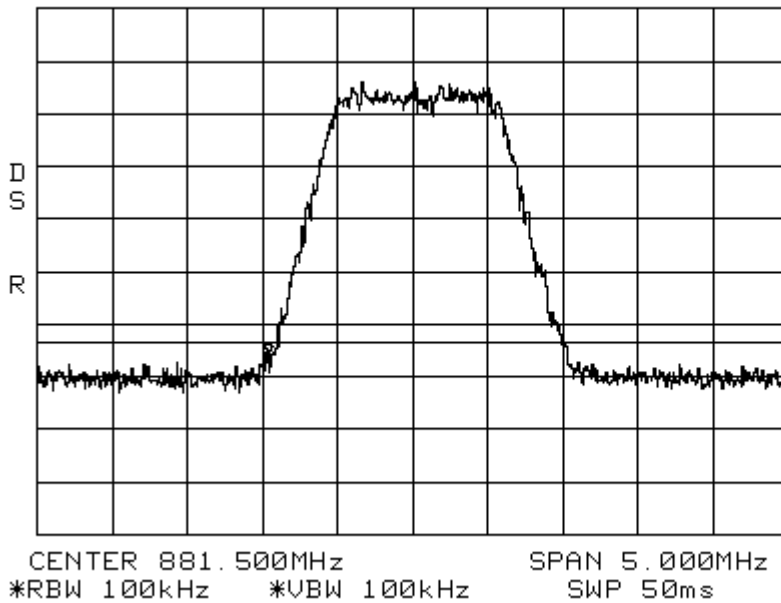

Conducted Emissions LTE 1.4 MHz Channel Bandwidth CELLULAR 40W
Span: 30 MHz to 1 GHz RBW/VBW: 300 kHz

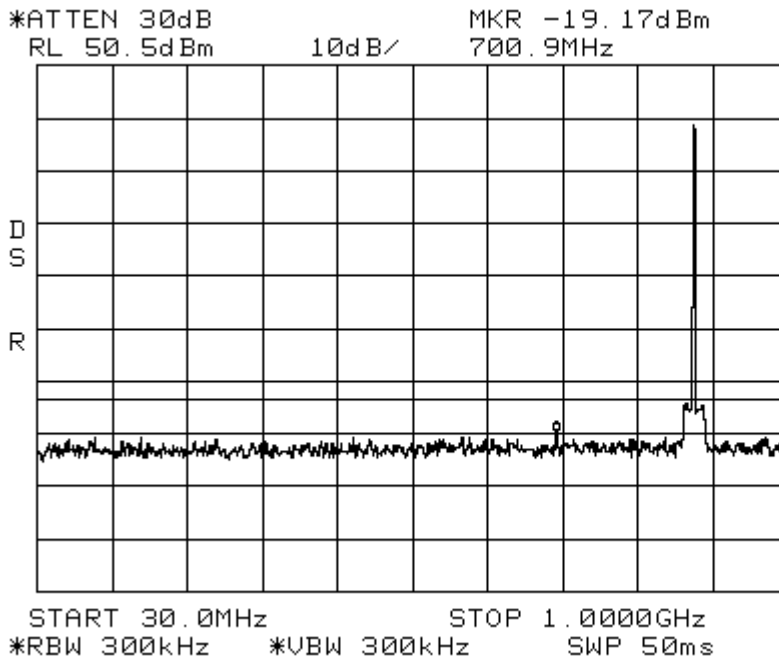

Conducted Emissions LTE 1.4 MHz Channel Bandwidth CELLULAR 40W
Span: 1 GHz to 10 GHz RBW/VBW: 1 MHz

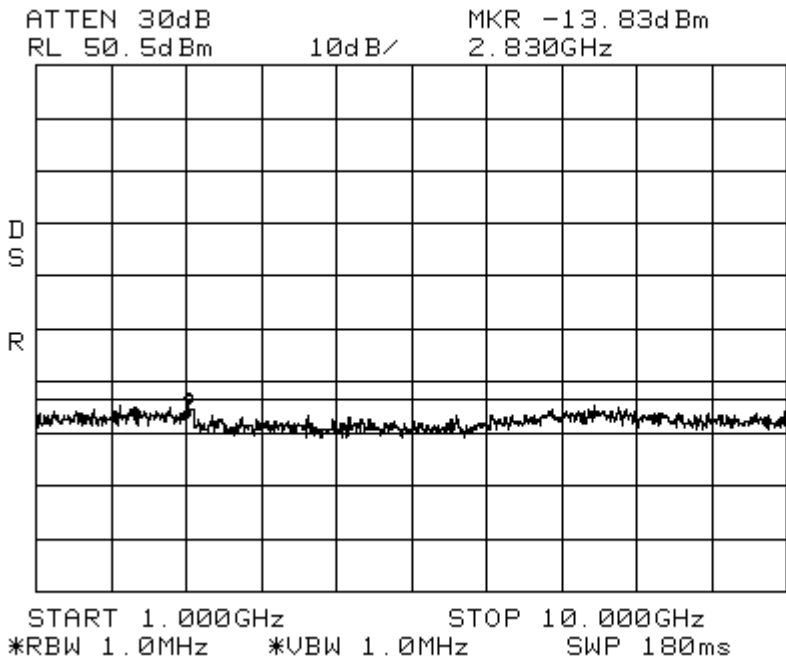

Conducted Emissions

LTE 3 MHz Channel Bandwidth

CELLULAR 40W

Center: 881.5 MHz

Span: 5 MHz

RBW/VBW: 100 kHz

ATTEN 30dB

MKR -15.00dBm

RL 50.5dBm

10dB/

879.183MHz

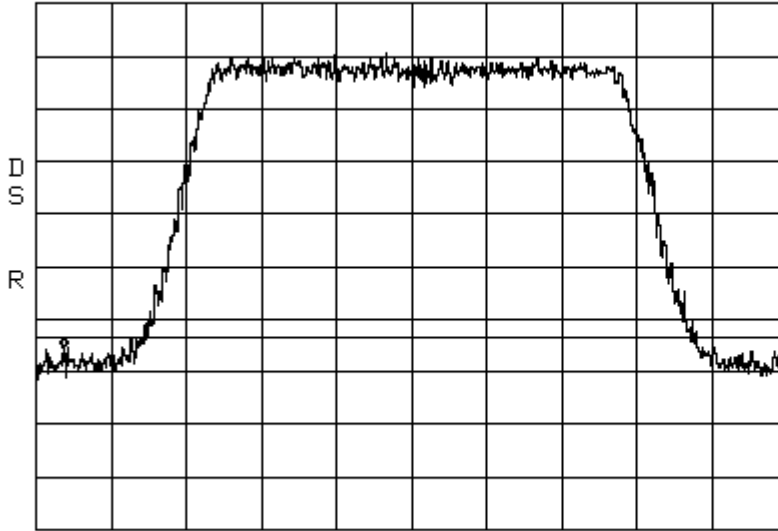

CENTER 881.500MHz SPAN 5.000MHz
*RBW 100kHz *VBW 100kHz SWP 50ms

Conducted Emissions

LTE 3 MHz Channel Bandwidth

CELLULAR 40W

Span: 30 MHz to 1 GHz

RBW/VBW: 300 kHz

ATTEN 30dB

MKR -19.17dBm

RL 50.5dBm

10dB/

387.3MHz

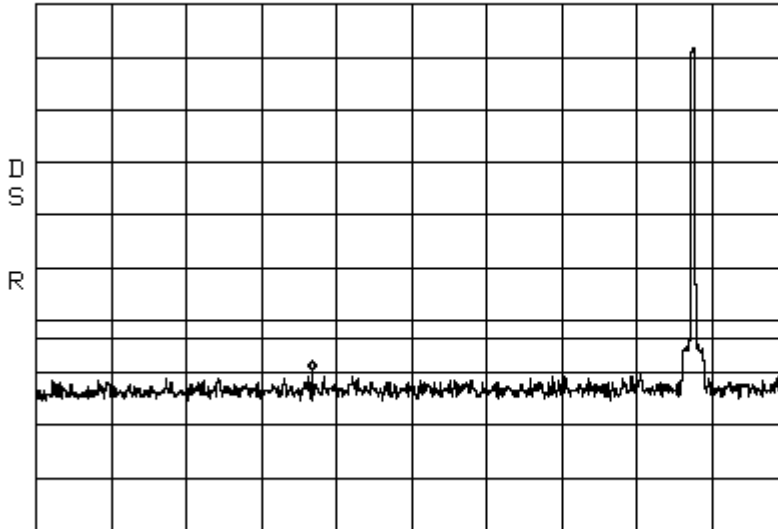

START 30.0MHz STOP 1.0000GHz
*RBW 300kHz *VBW 300kHz SWP 50ms

Conducted Emissions LTE 3 MHz Channel Bandwidth CELLULAR 40W
Span: 1 GHz to 10 GHz RBW/VBW: 1 MHz

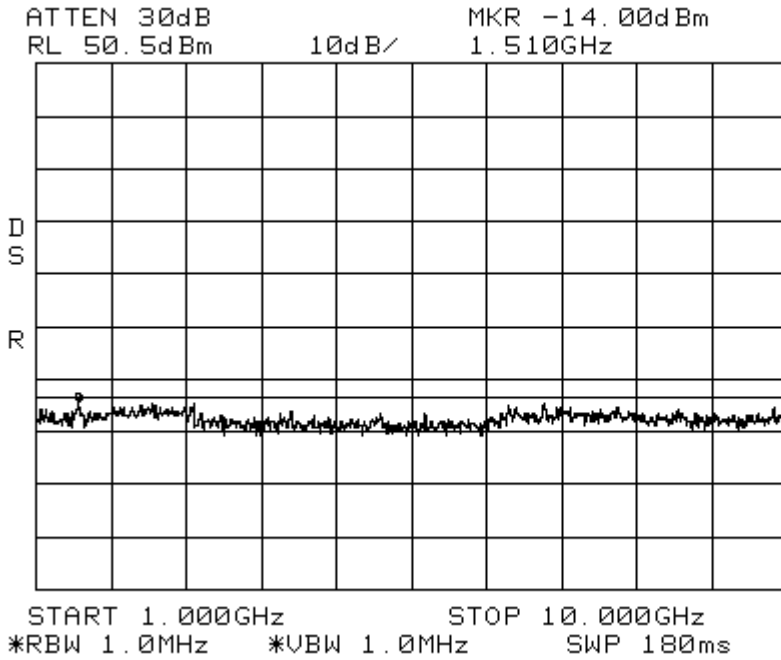

Conducted Emissions LTE 5 MHz Channel Bandwidth CELLULAR 40W
Center: 881.5 MHz Span: 10 MHz RBW/VBW: 100 kHz

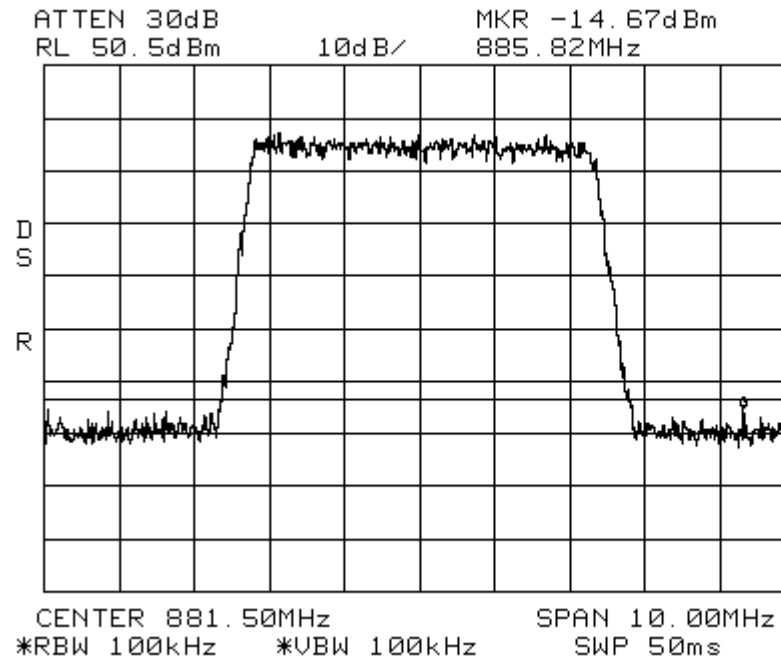

Conducted Emissions LTE 5 MHz Channel Bandwidth CELLULAR 40W
Span: 30 MHz to 1 GHz RBW/VBW: 300 kHz

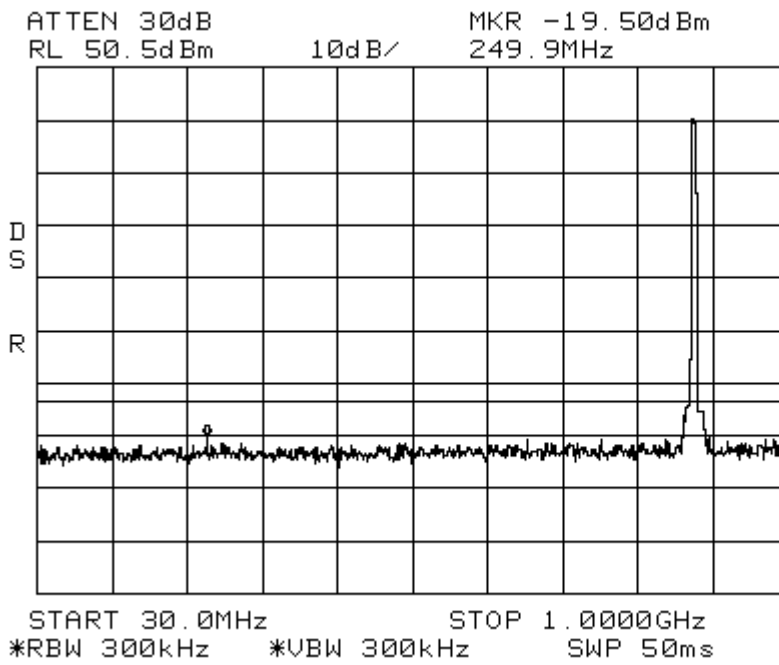

Conducted Emissions LTE 5 MHz Channel Bandwidth CELLULAR 40W
Span: 1 GHz to 10 GHz RBW/VBW: 1 MHz

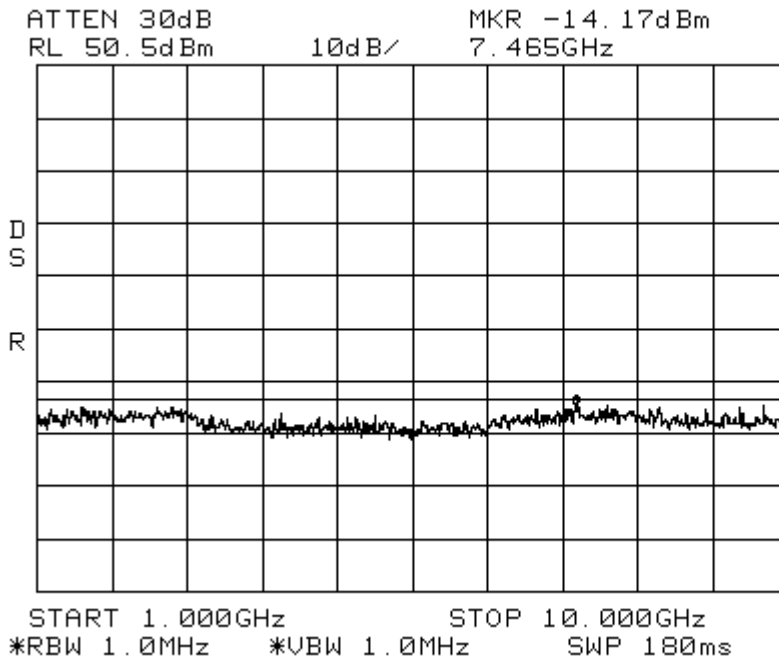

Conducted Emissions LTE 10 MHz Channel Bandwidth CELLULAR 40W
Center: 881.5 MHz Span: 20MHz RBW/VBW: 100 kHz

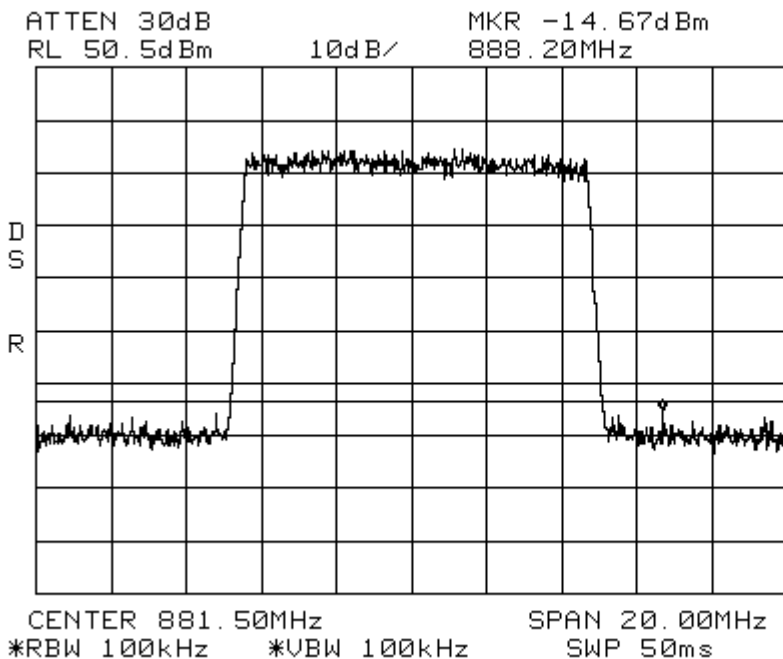

Conducted Emissions LTE 10 MHz Channel Bandwidth CELLULAR 40W
Span: 30 MHz to 1 GHz RBW/VBW: 300 kHz

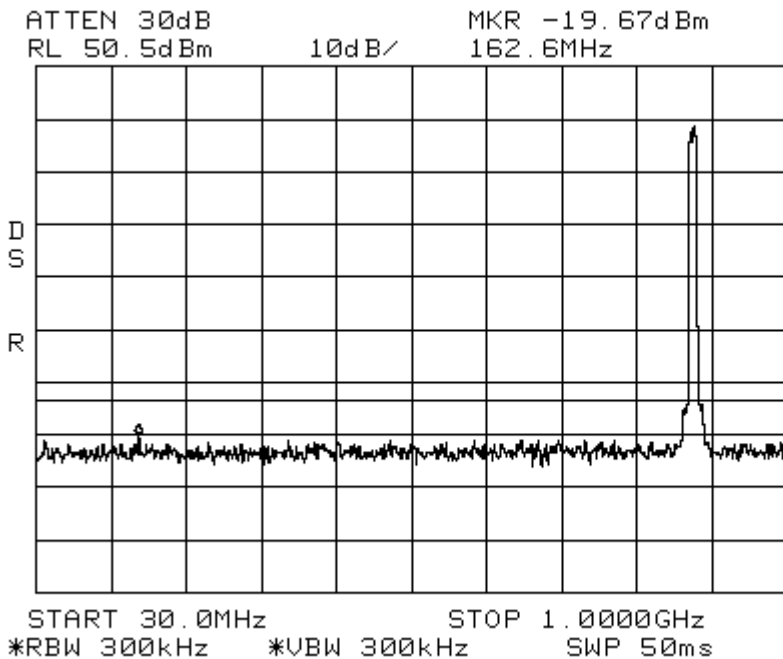

Conducted Emissions LTE 10 MHz Channel Bandwidth CELLULAR 40W
Span: 1 GHz to 10 GHz RBW/VBW: 1 MHz

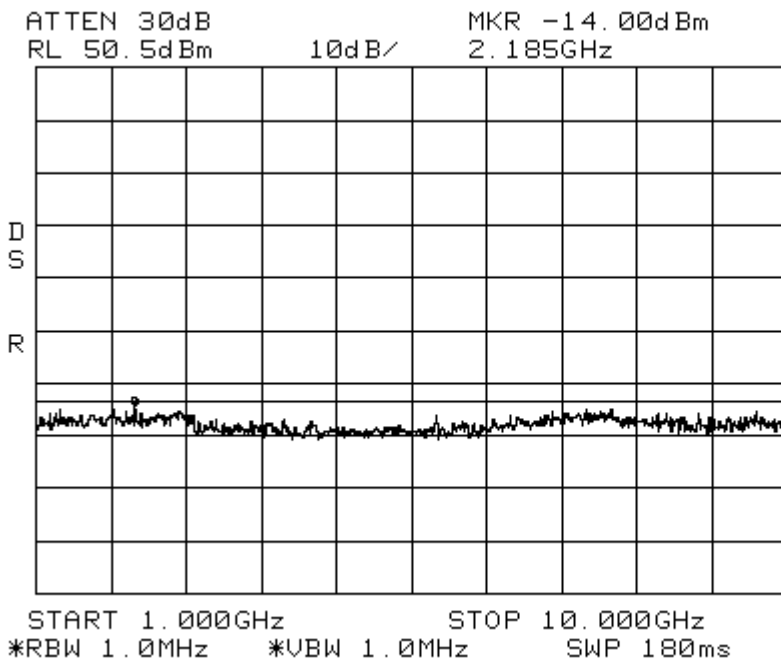

Conducted Emissions LTE 15 MHz Channel Bandwidth CELLULAR 40W
Center: 881.5 MHz Span: 50 MHz RBW/VBW: 100 kHz

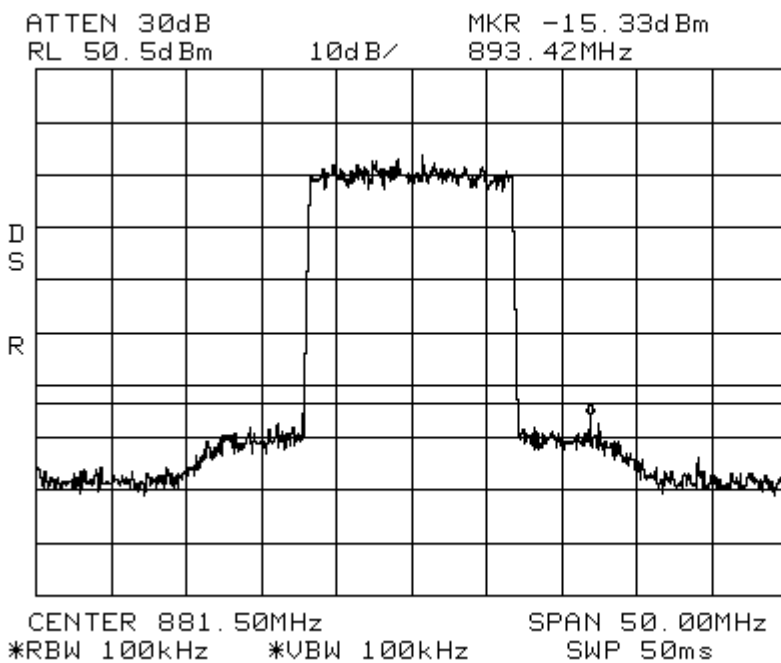

Conducted Emissions LTE 15 MHz Channel Bandwidth CELLULAR 40W
Span: 30 MHz to 1 GHz RBW/VBW: 300 kHz

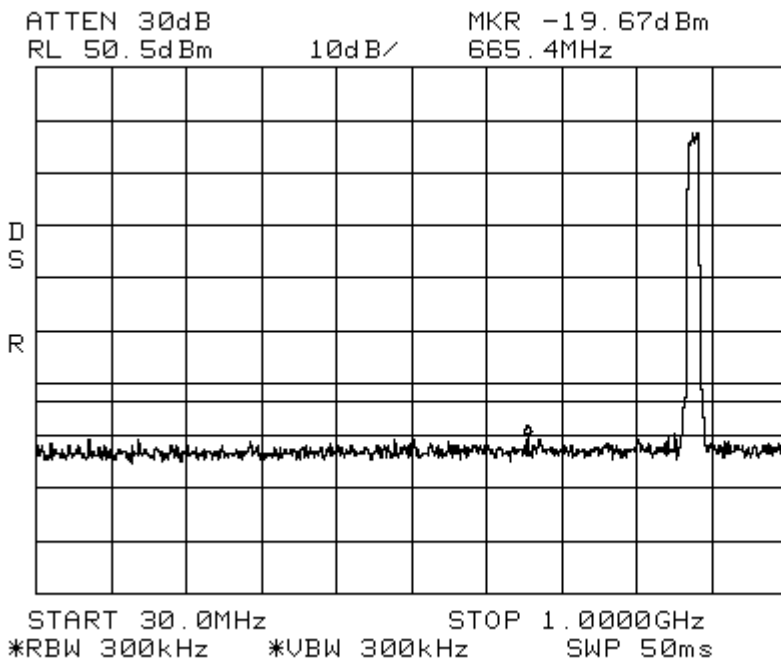

Conducted Emissions LTE 15 MHz Channel Bandwidth CELLULAR 40W
Span: 1 GHz to 10 GHz RBW/VBW: 1 MHz

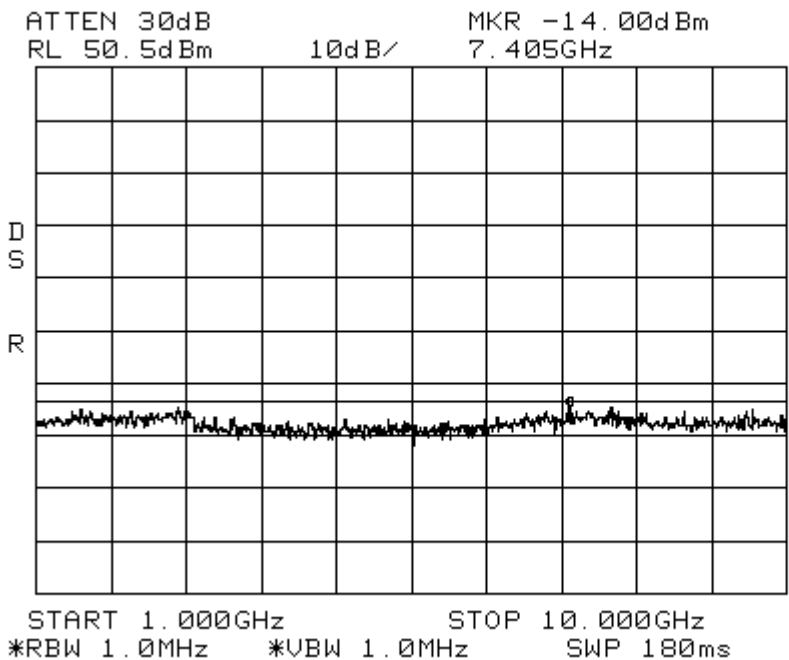

Conducted Emissions LTE 20 MHz Channel Bandwidth CELLULAR 40W
Center: 881.5 MHz Span: 50MHz RBW/VBW: 100 kHz

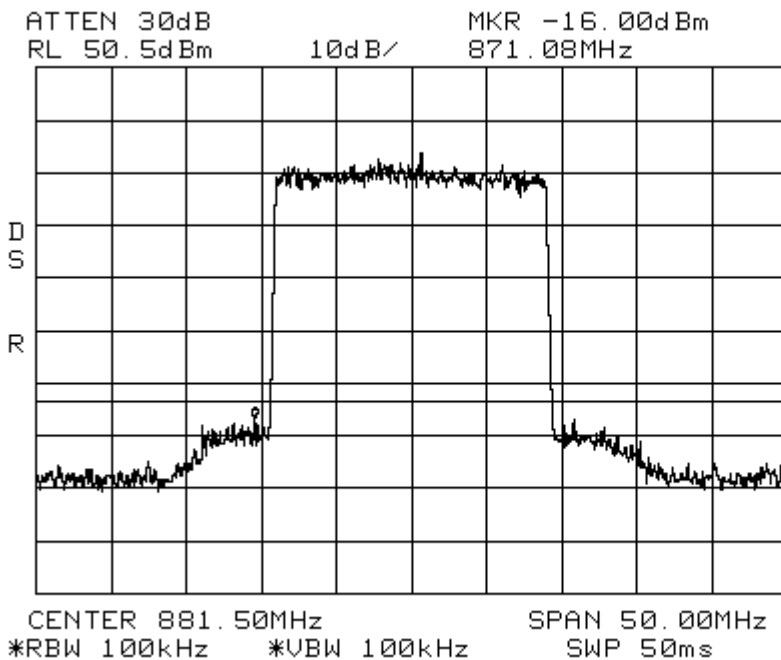

Conducted Emissions LTE 20 MHz Channel Bandwidth CELLULAR 40W
Span: 30 MHz to 1 GHz RBW/VBW: 300 kHz

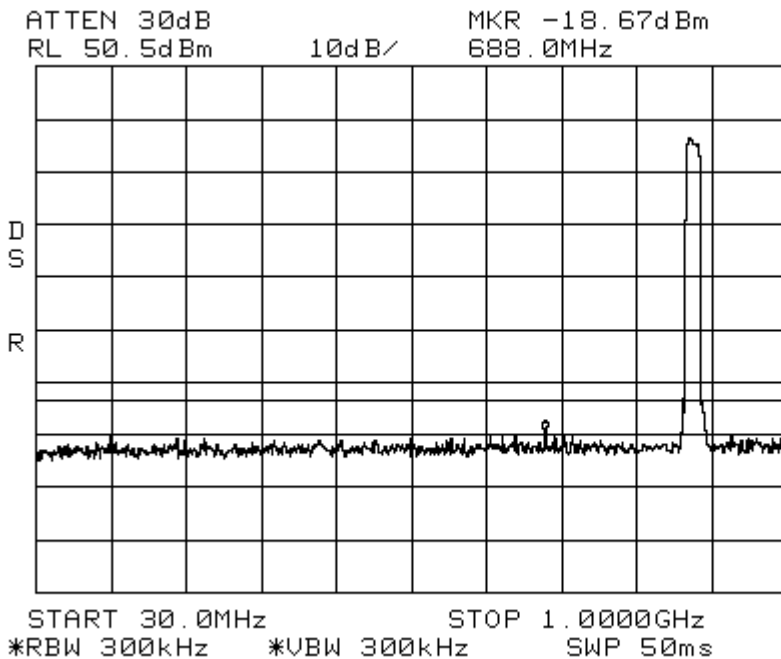

Conducted Emissions

LTE 20 MHz Channel Bandwidth

CELLULAR 40W

Span: 1 GHz to 10 GHz

RBW/VBW: 1 MHz

ATTEN 30dB

MKR -13.67dBm

RL 50.5dBm

10dB/

6.535GHz

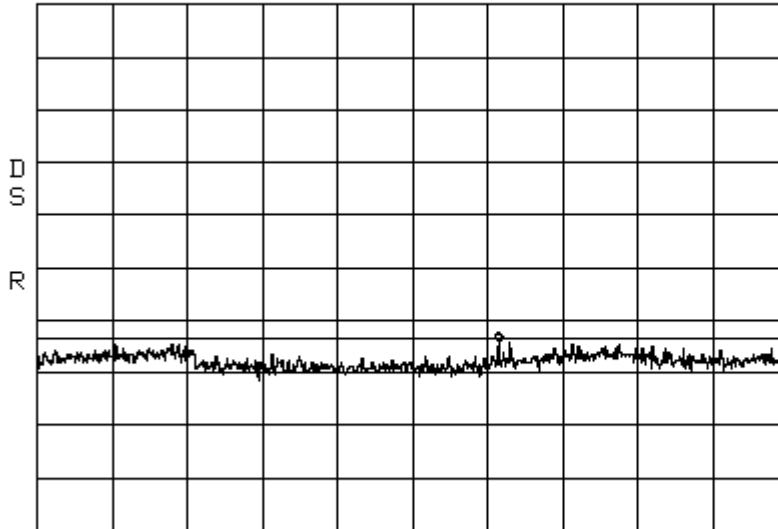

START 1.000GHz

STOP 10.000GHz

*RBW 1.0MHz

*VBW 1.0MHz

SWP 180ms

Conducted Emissions

WCDMA

CELLULAR 40W

Center: 881.5 MHz

Span: 10 MHz

RBW/VBW: 100 kHz

*ATTEN 30dB

MKR -15.67dBm

RL 50.5dBm

10dB/

886.17MHz

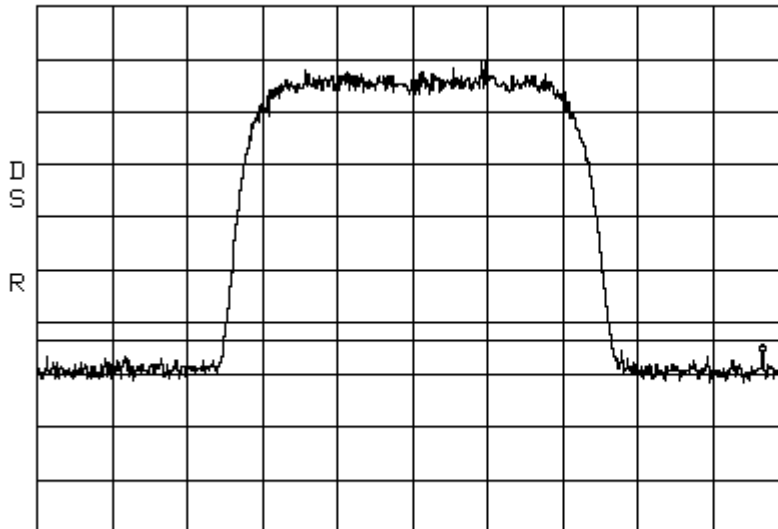

CENTER 881.50MHz

SPAN 10.00MHz

*RBW 100kHz

*VBW 100kHz

SWP 50ms

Conducted Emissions
Span: 30 MHz to 1 GHz

WCDMA

CELLULAR 40W

RBW/VBW: 300 kHz

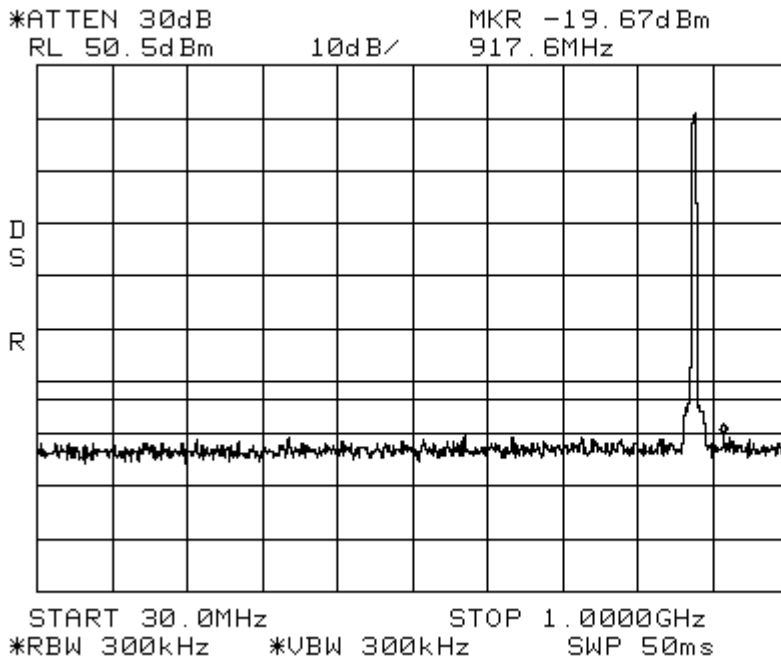

Conducted Emissions
Span: 1 GHz to 10 GHz

WCDMA

CELLULAR 40W

RBW/VBW: 1 MHz

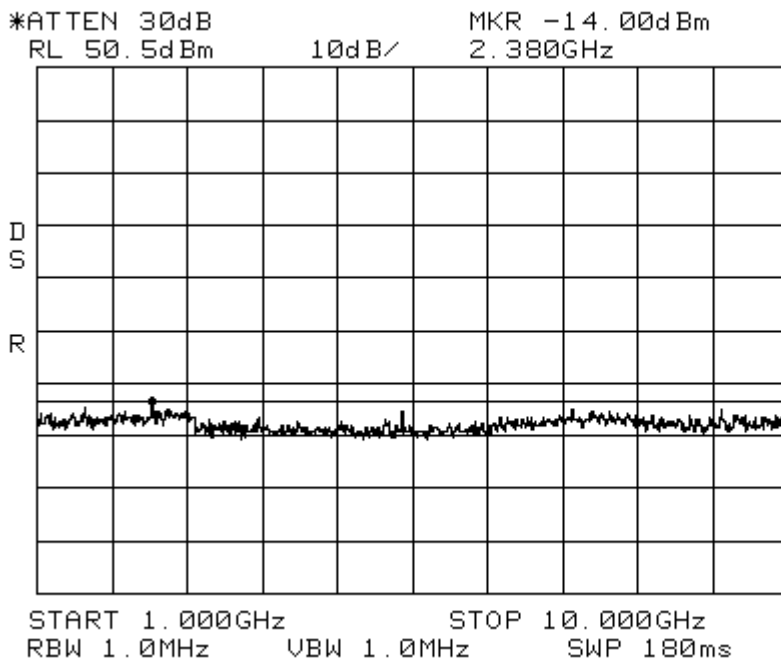

Band_Edge CDMA CELLULAR 40W
Center: 869.73 MHz Span: 2 MHz RBW: 10 kHz VBW: 10 kHz

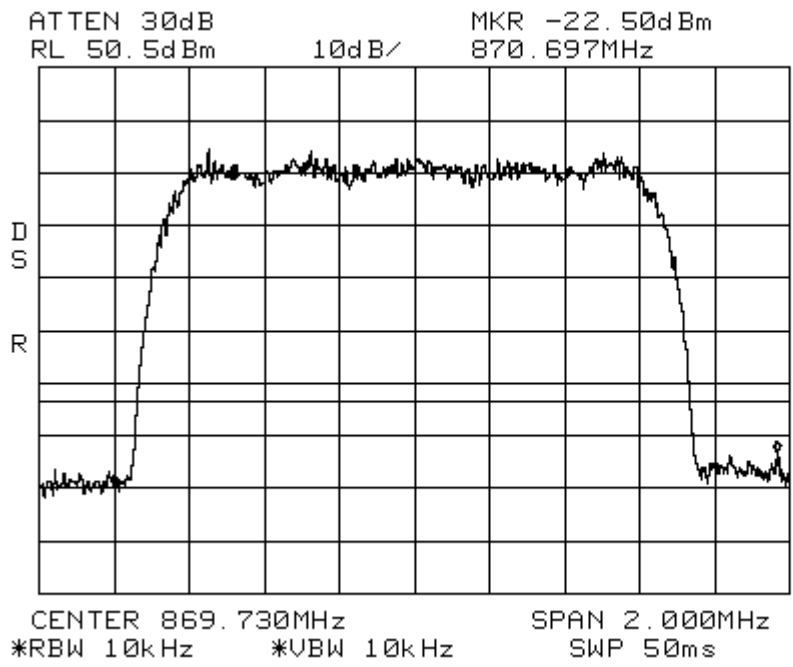

Band_Edge CDMA CELLULAR 40W
Center: 893.19 MHz Span: 2 MHz RBW: 10 kHz VBW: 10 kHz

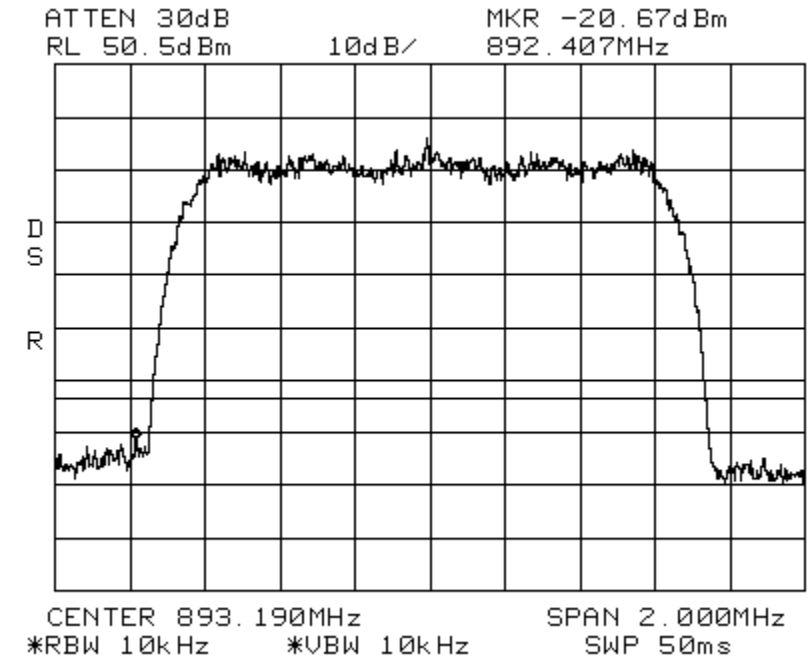

Band_Edge EDGE CELLULAR 40W
Center: 869.2 MHz Span: 500 kHz RBW: 3 kHz VBW: 10 kHz

ATTEN 30dB MKR -15.50dBm
RL 50.5dBm 10dB/ 868.9783MHz

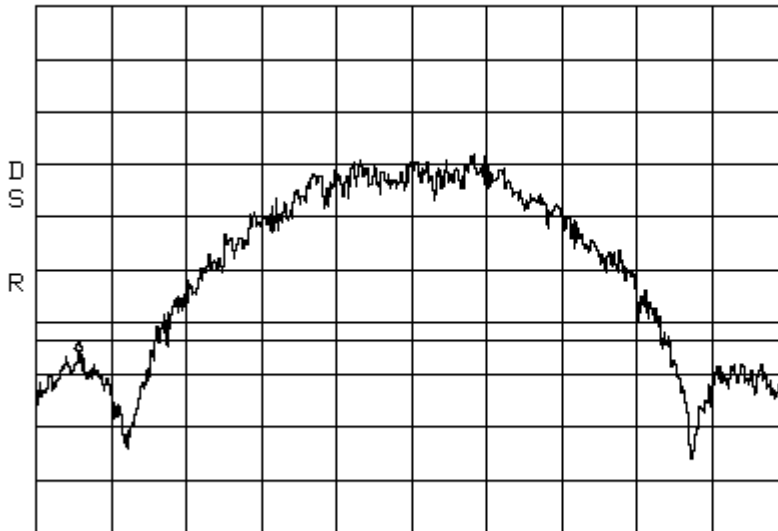

CENTER 869.2000MHz SPAN 500.0kHz
*RBW 3.0kHz *VBW 10kHz SWP 140ms

Band_Edge EDGE CELLULAR 40W
Center: 893.8 MHz Span: 500 kHz RBW: 3 kHz VBW: 10 kHz

ATTEN 30dB MKR -13.67dBm
RL 50.5dBm 10dB/ 893.5808MHz

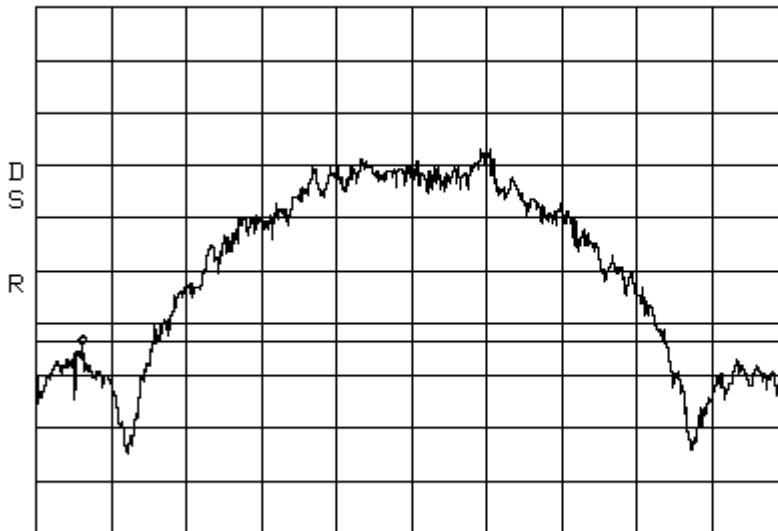

CENTER 893.8000MHz SPAN 500.0kHz
*RBW 3.0kHz *VBW 10kHz SWP 140ms

Band_Edge GSM CELLULAR 40W
Center: 869.2 MHz Span: 500 kHz RBW: 3 kHz VBW: 10 kHz

ATTEN 30dB MKR -14.33dBm
RL 50.5dBm 10dB/ 869.0192MHz

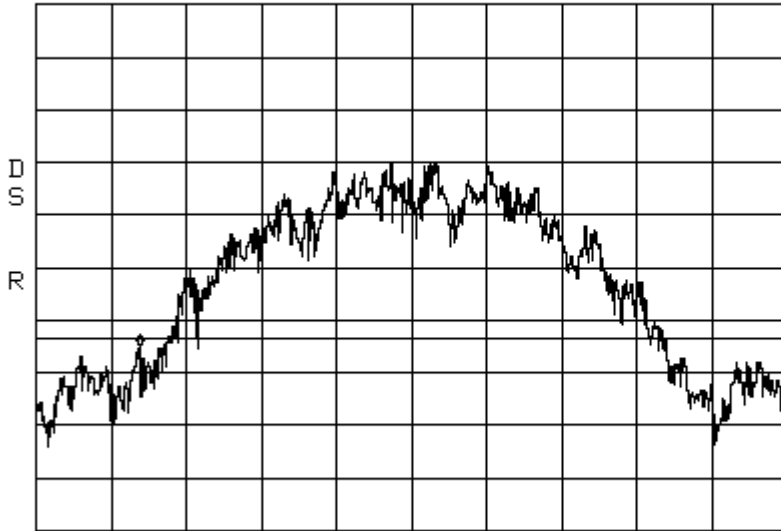

CENTER 869.2000MHz SPAN 500.0kHz
*RBW 3.0kHz *VBW 10kHz SWP 140ms

Band_Edge GSM CELLULAR 40W
Center: 893.8 MHz Span: 500 kHz RBW: 3 kHz VBW: 10 kHz

ATTEN 30dB MKR -14.50dBm
RL 50.5dBm 10dB/ 893.6192MHz

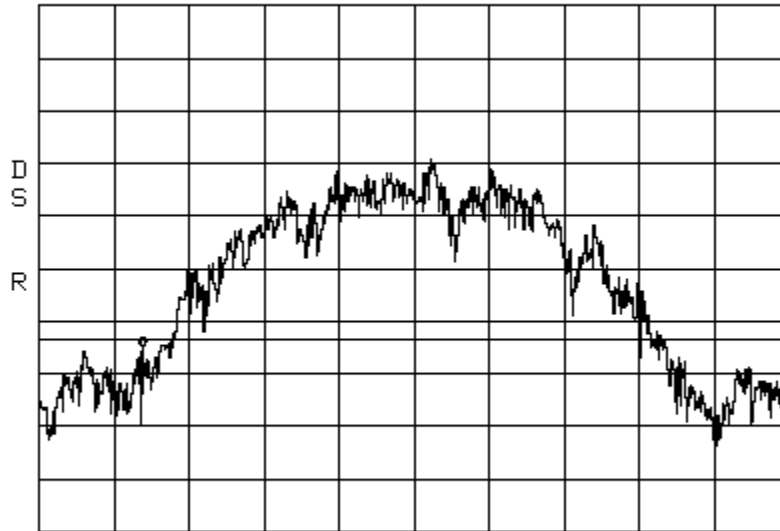

CENTER 893.8000MHz SPAN 500.0kHz
*RBW 3.0kHz *VBW 10kHz SWP 140ms

Band_Edge LTE 1.4 MHz Channel Bandwidth CELLULAR 40W
Center: 869.7MHz Span: 2 MHz RBW: 3 kHz VBW: 10 kHz

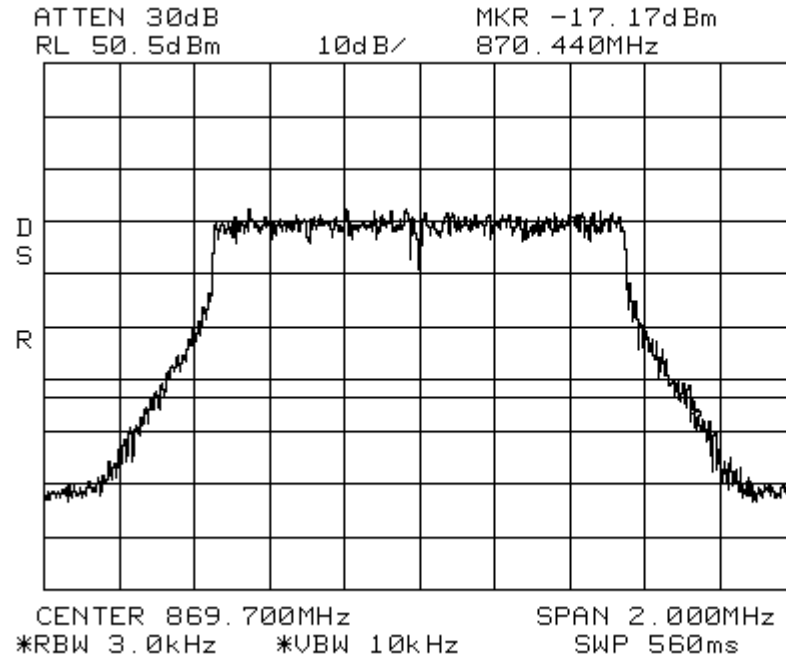

Band_Edge LTE 1.4 MHz Channel Bandwidth CELLULAR 40W
Center: 893.3MHz Span: 2 MHz RBW: 3 kHz VBW: 10 kHz

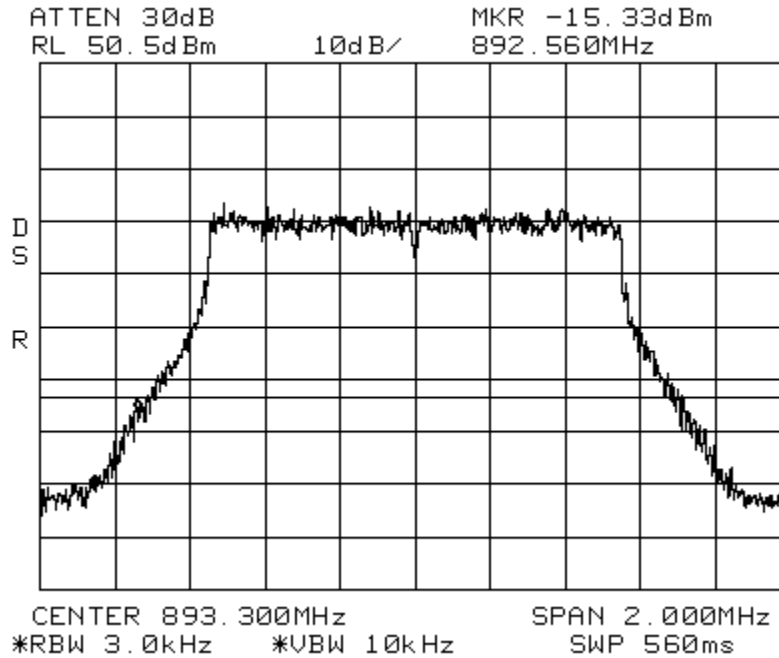

Band_Edge LTE 5 MHz Channel Bandwidth CELLULAR 40W
Center: 871.5MHz Span: 7 MHz RBW: 30 kHz VBW: 100 kHz

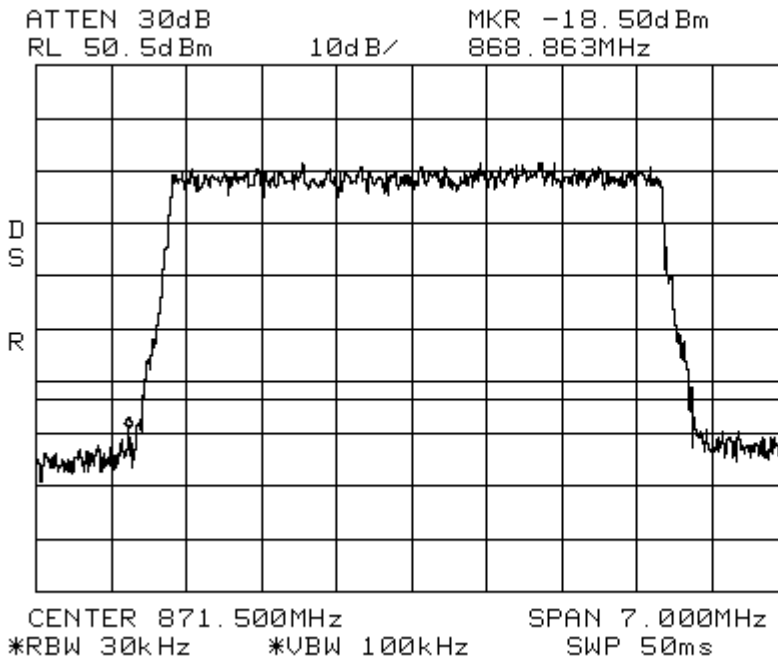

Band_Edge LTE 5 MHz Channel Bandwidth CELLULAR 40W
Center: 891.5MHz Span: 7 MHz RBW: 30 kHz VBW: 100 kHz

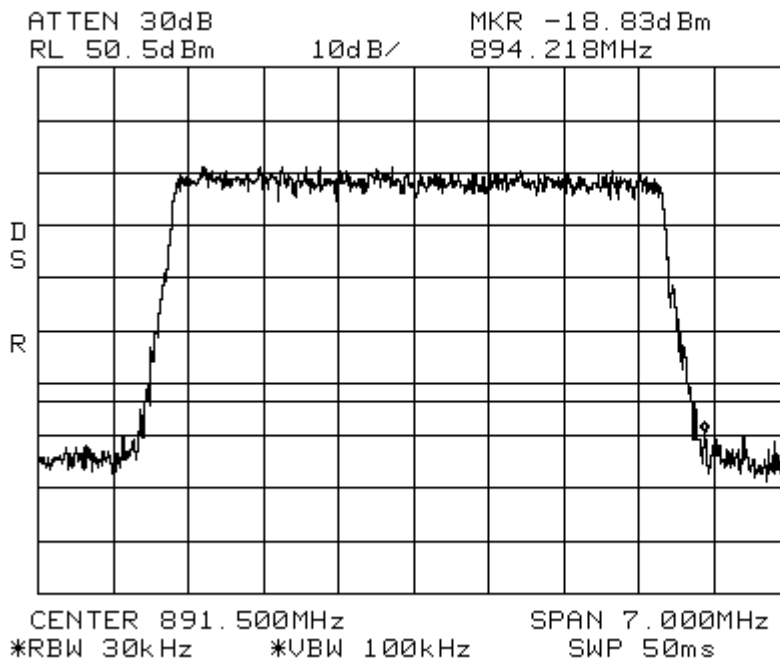

Band_Edge LTE 10 MHz Channel Bandwidth CELLULAR 40W
Center: 874MHz Span: 15 MHz RBW: 30 kHz VBW: 100 kHz

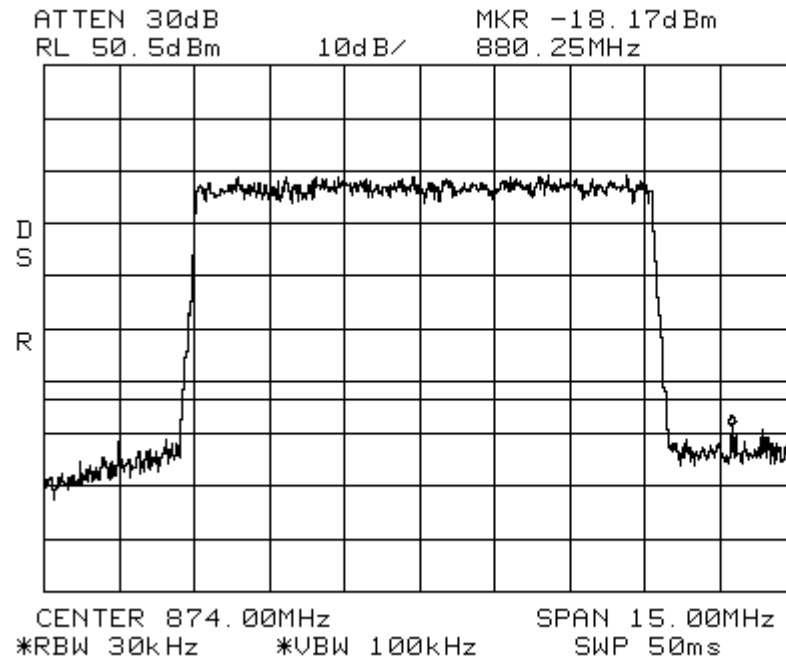

Band_Edge LTE 10 MHz Channel Bandwidth CELLULAR 40W
Center: 889MHz Span: 15 MHz RBW: 30 kHz VBW: 100 kHz

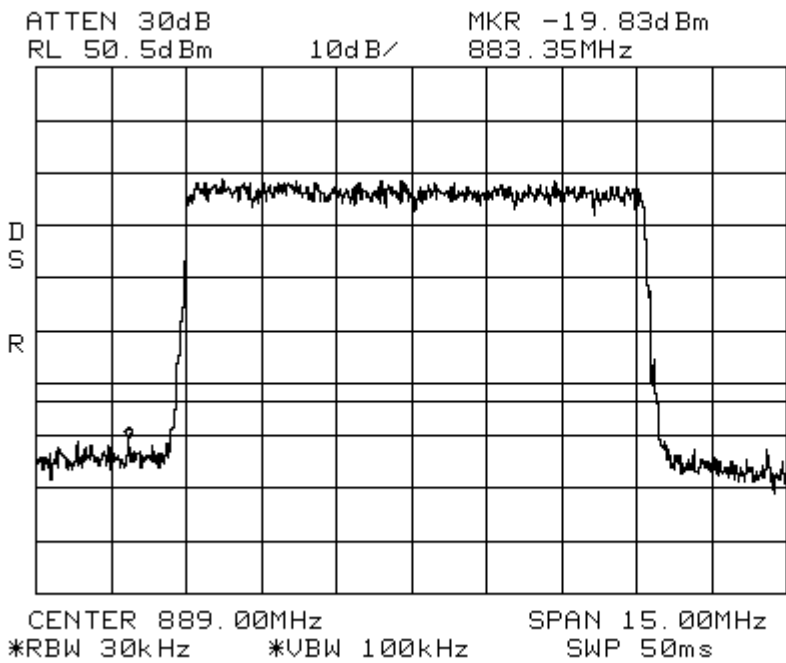

Band_Edge LTE 15 MHz Channel Bandwidth CELLULAR 40W
Center: 876.5 MHz Span: 17 MHz RBW: 30 kHz VBW: 100 kHz

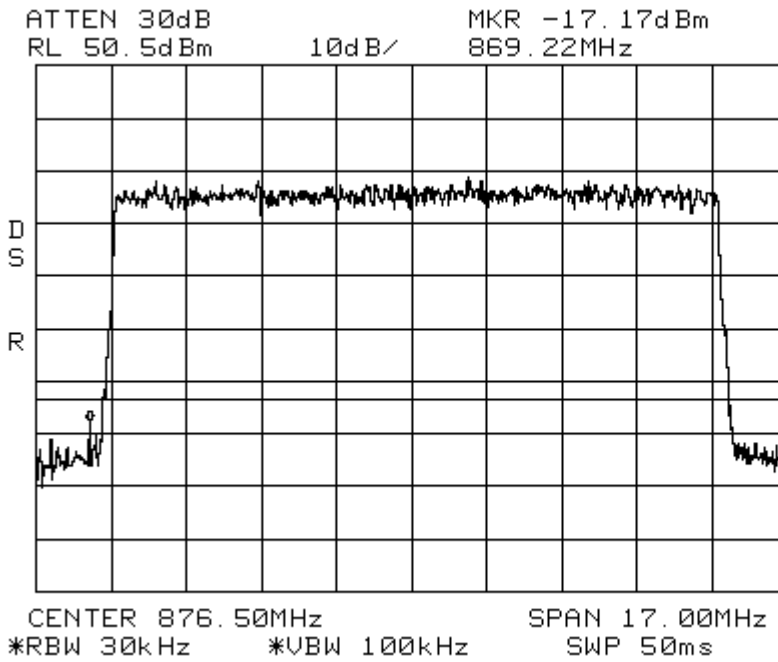

Band_Edge LTE 15 MHz Channel Bandwidth CELLULAR 40W
Center: 886.5 MHz Span: 17 MHz RBW: 30 kHz VBW: 100 kHz

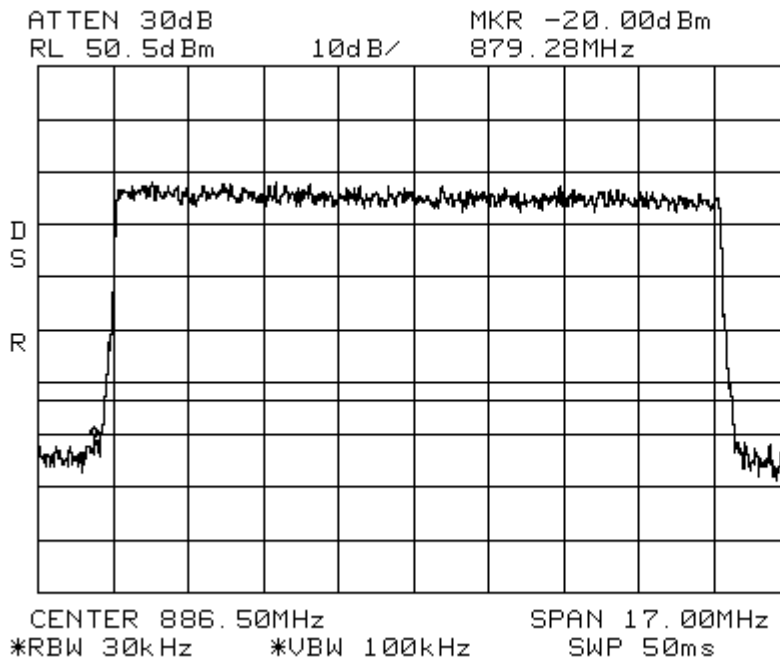

Band_Edge LTE 20 MHz Channel Bandwidth CELLULAR 40W
Center: 879 MHz Span: 22 MHz RBW: 30 kHz VBW: 100 kHz

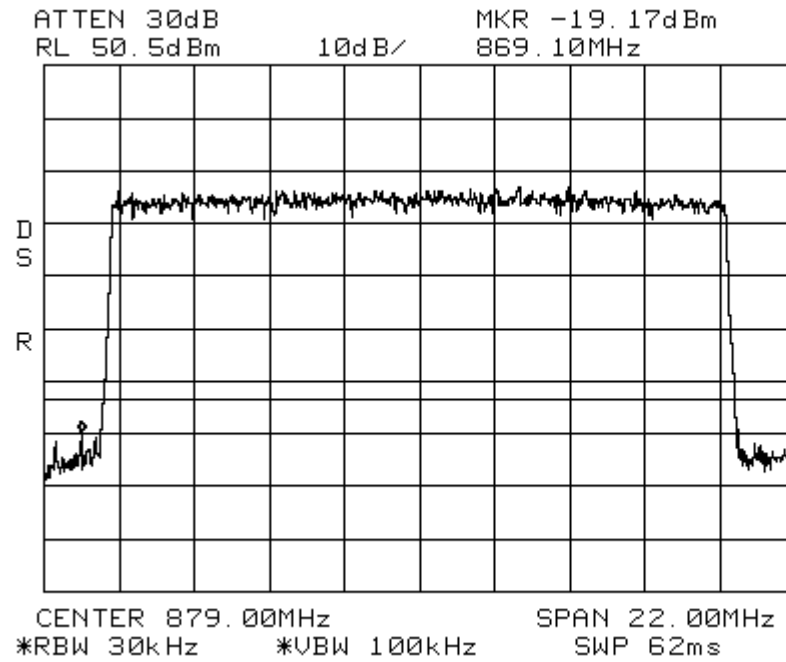

Band_Edge LTE 20 MHz Channel Bandwidth CELLULAR 40W
Center: 884 MHz Span: 22 MHz RBW: 30 kHz VBW: 100 kHz

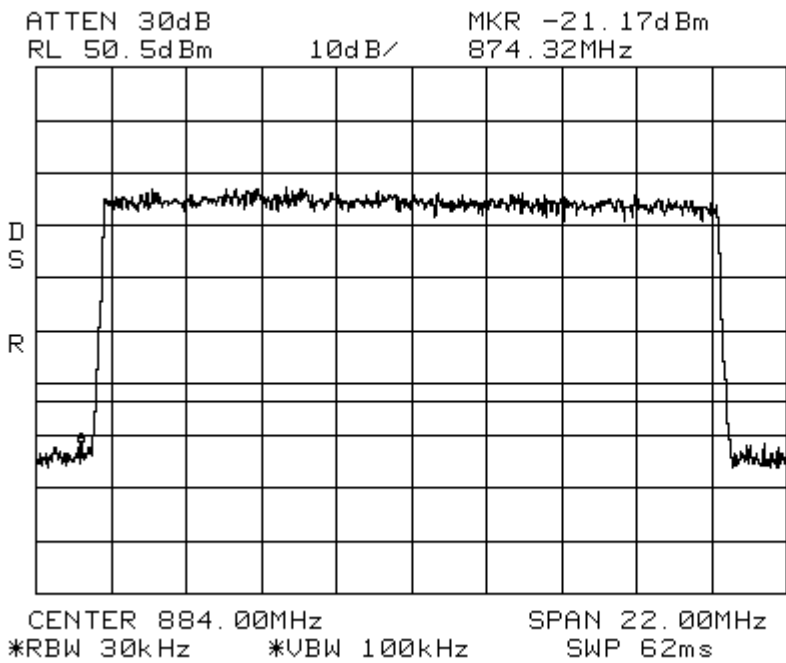

Band_Edge WCDMA CELLULAR 40W
Center: 871.6 MHz Span: 5.5 MHz RBW: 10 kHz VBW: 10 kHz
ATTEN 30dB MKR -25.67dBm
RL 50.5dBm 10dB/ 869.162MHz

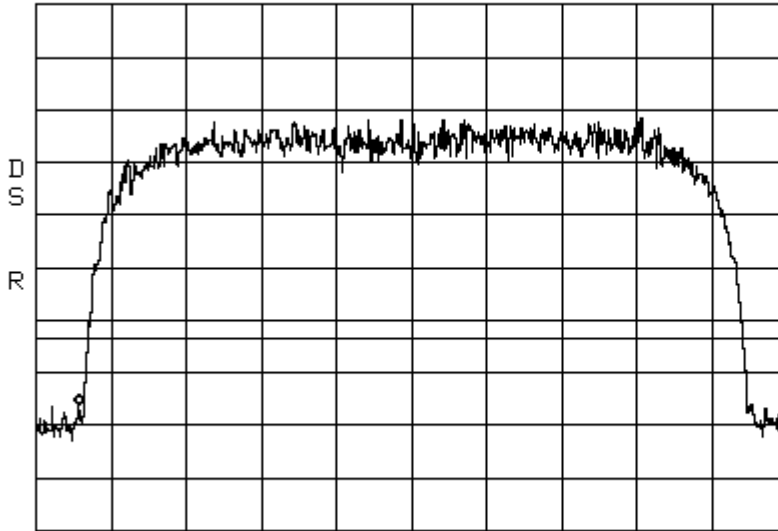

CENTER 871.600MHz SPAN 5.500MHz
*RBW 10kHz *VBW 10kHz SWP 140ms

Band_Edge WCDMA CELLULAR 40W
Center: 891.4 MHz Span: 5.5 MHz RBW: 10 kHz VBW: 10 kHz

ATTEN 30dB MKR -23.50dBm
RL 50.5dBm 10dB/ 888.943MHz

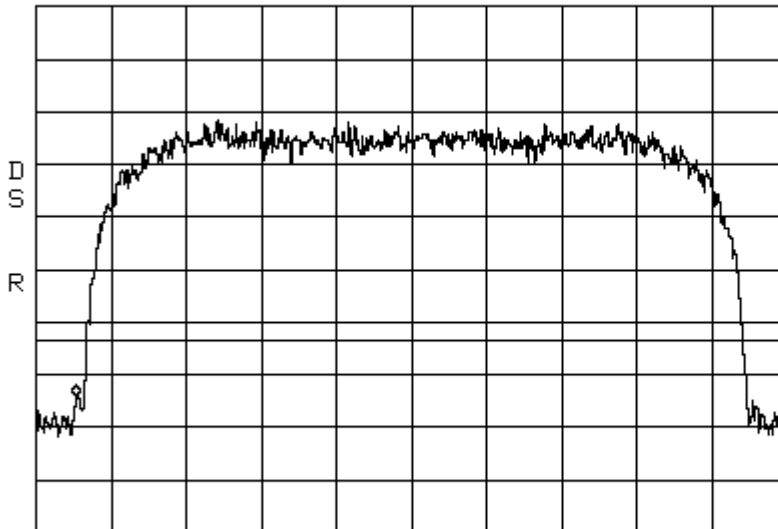

CENTER 891.400MHz SPAN 5.500MHz
*RBW 10kHz *VBW 10kHz SWP 140ms

7.2 Conducted Output Power Test

[Table of Contents: Section 1.0](#)

[Back to Conducted Output Power: Section 5.1.1](#)

*Note: The EUT is a fixed repeater and not a base station.

This measurement was made as a direct conducted emission measurement. The output from the EUT antenna connector was connected to the power meter. The carrier output, below, was conducted using a single GSM, EDGE, CDMA, W-CDMA, LTE 1.4MHz BW, LTE 3MHz BW, LTE 5 MHz BW, LTE 10MHz BW, LTE 15MHz BW, and LTE 20MHz BW signal.

A signal was used at the low, mid and high parts of the selected band. The power meter level was offset by 30.5 dB to compensate for cable loss and attenuator between the EUT and the power meter.

<u>GSM</u>	<u>42.36 Watts</u>
Carrier Frequency	Carrier Output
869.2 MHz	46.01 dBm
881.5 MHz	46.27 dBm
893.8 MHz	46.05 dBm

<u>EDGE</u>	<u>45.81 Watts</u>
Carrier Frequency	Carrier Output
869.2 MHz	46.10 dBm
881.5 MHz	46.61 dBm
893.8 MHz	46.25 dBm

<u>CDMA</u>	<u>52.23 Watts</u>
Carrier Frequency	Carrier Output
869.8 MHz	46.76 dBm
881.5 MHz	47.18 dBm
893.2 MHz	46.83 dBm

<u>W-CDMA</u>	<u>50.93 Watts</u>
Carrier Frequency	Carrier Output
871.6 MHz	46.83 dBm
881.5 MHz	47.07 dBm
891.4 MHz	46.87 dBm

<u>1.4 LTE</u>	<u>50.35 Watts</u>
Carrier Frequency	Carrier Output
869.7 MHz	46.70 dBm
881.5 MHz	47.02 dBm
893.3 MHz	46.89 dBm

<u>3 LTE</u>	<u>53.82 Watts</u>
Carrier Frequency	Carrier Output
870.5 MHz	47.04 dBm
881.5 MHz	47.31dBm
892.5 MHz	47.06 dBm

<u>5 LTE</u>	<u>52.72 Watts</u>
Carrier Frequency	Carrier Output
871.5 MHz	47.01 dBm
881.5MHz	47.22dBm
891.5 MHz	47.11 dBm

<u>10LTE</u>	<u>54.32 Watts</u>
Carrier Frequency	Carrier Output
874 MHz	47.20 dBm
881.5 MHz	47.35 dBm
889 MHz	47.25dBm

<u>15 LTE</u>	<u>54.2 Watts</u>
Carrier Frequency	Carrier Output
876.5 MHz	47.27 dBm
881.5 MHz	47.34 dBm
886.5 MHz	47.28 dBm

<u>20 LTE</u>	<u>53.70 Watts</u>
Carrier Frequency	Carrier Output
879 MHz	47.28 dBm
881.5 MHz	47.30 dBm
884 MHz	47.27 dBm

7.3 Frequency Stability Test

[Table of Contents: Section 1.0](#)

[Back to Frequency Stability: Section 5.1.1](#)

HOST	REMOTE			
Input Voltage	Input Voltage	Carrier Frequency	Measured Frequency	Meets Requirements?
21 VDC	100 VAC	869.200 MHz	869.200 MHz	Yes
48 VDC	170 VAC	869.200 MHz	869.200 MHz	Yes
60 VDC	240 VAC	869.200 MHz	869.200 MHz	Yes
21 VDC	100 VAC	881.500 MHz	881.500 MHz	Yes
48 VDC	170 VAC	881.500 MHz	881.500 MHz	Yes
60 VDC	240 VAC	881.500 MHz	881.500 MHz	Yes
21 VDC	100 VAC	893.800 MHz	893.800 MHz	Yes
48 VDC	170 VAC	893.800 MHz	893.800 MHz	Yes
60 VDC	240 VAC	893.800 MHz	893.800 MHz	Yes
Temperature		Carrier Frequency	Measured Frequency	Meets Requirements?
-30 Deg. C		869.200 MHz	869.200 MHz	Yes
-20 Deg. C		869.200 MHz	869.200 MHz	Yes
-10 Deg. C		869.200 MHz	869.200 MHz	Yes
0 Deg. C		869.200 MHz	869.200 MHz	Yes
10 Deg. C		869.200 MHz	869.200 MHz	Yes
20 Deg. C		869.200 MHz	869.200 MHz	Yes
30 Deg. C		869.200 MHz	869.200 MHz	Yes
40 Deg. C		869.200 MHz	869.200 MHz	Yes
50 Deg. C		869.200 MHz	869.200 MHz	Yes
-30 Deg. C		881.500 MHz	881.500 MHz	Yes
-20 Deg. C		881.500 MHz	881.500 MHz	Yes
-10 Deg. C		881.500 MHz	881.500 MHz	Yes
0 Deg. C		881.500 MHz	881.500 MHz	Yes
10 Deg. C		881.500 MHz	881.500 MHz	Yes
20 Deg. C		881.500 MHz	881.500 MHz	Yes
30 Deg. C		881.500 MHz	881.500 MHz	Yes
40 Deg. C		881.500 MHz	881.500 MHz	Yes
50 Deg. C		881.500 MHz	881.500 MHz	Yes
-30 Deg. C		893.800 MHz	893.800 MHz	Yes
-20 Deg. C		893.800 MHz	893.800 MHz	Yes
-10 Deg. C		893.800 MHz	893.800 MHz	Yes
0 Deg. C		893.800 MHz	893.800 MHz	Yes
10 Deg. C		893.800 MHz	893.800 MHz	Yes
20 Deg. C		893.800 MHz	893.800 MHz	Yes
30 Deg. C		893.800 MHz	893.800 MHz	Yes
40 Deg. C		893.800 MHz	893.800 MHz	Yes
50 Deg. C		893.800 MHz	893.800 MHz	Yes

7.4 Intermodulation Test

[Table of Contents: Section 1.0](#)

[Back to Emission Limits: Section 5.1.3](#)

The inter-modulation products test was performed for the EUT. One test was performed with the modulation type. 2 signals input to the EUT at lower end channels, and 1 signal input to the EUT at upper end channel. The modulation types tested were GSM, EDGE, CDMA, W-CDMA, LTE 1.4MHz BW, LTE 3MHz BW, LTE 5 MHz BW, and LTE 10MHz BW. An investigation was made from 30 MHz to the 10th Harmonic of the highest fundamental frequency (~10 GHz). The following plots show the results.

Results:

(See Plots)

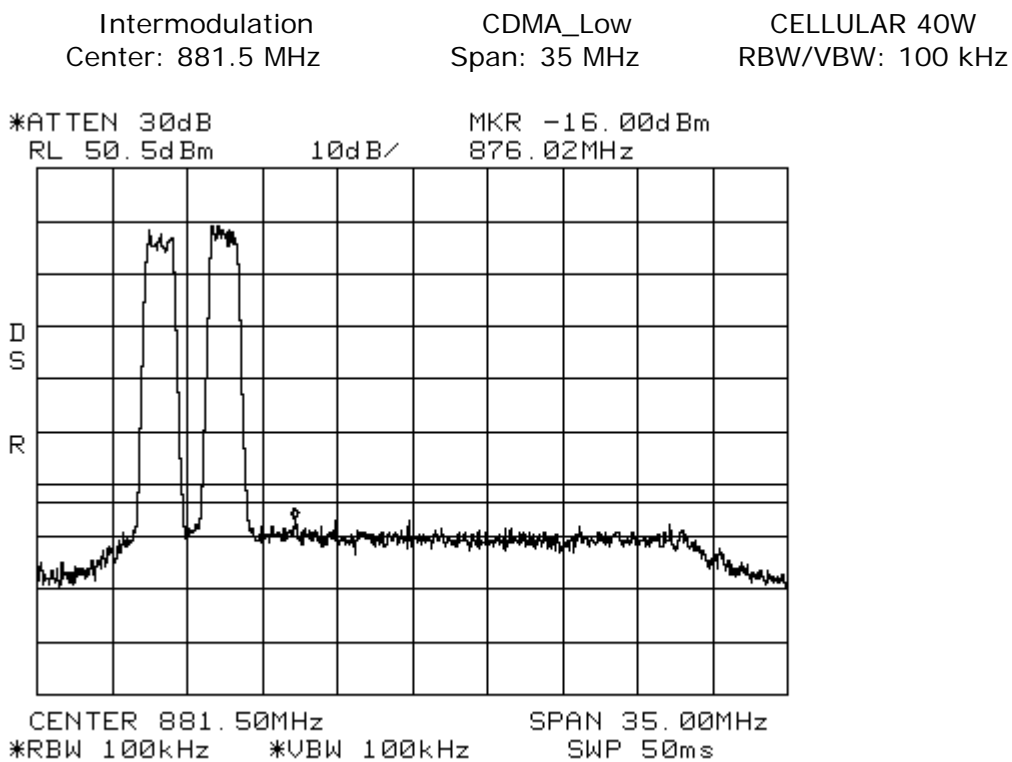

Intermodulation
Span: 30 MHz to 1 GHz

CDMA_Low
RBW/VBW: 300 kHz

CELLULAR 40W

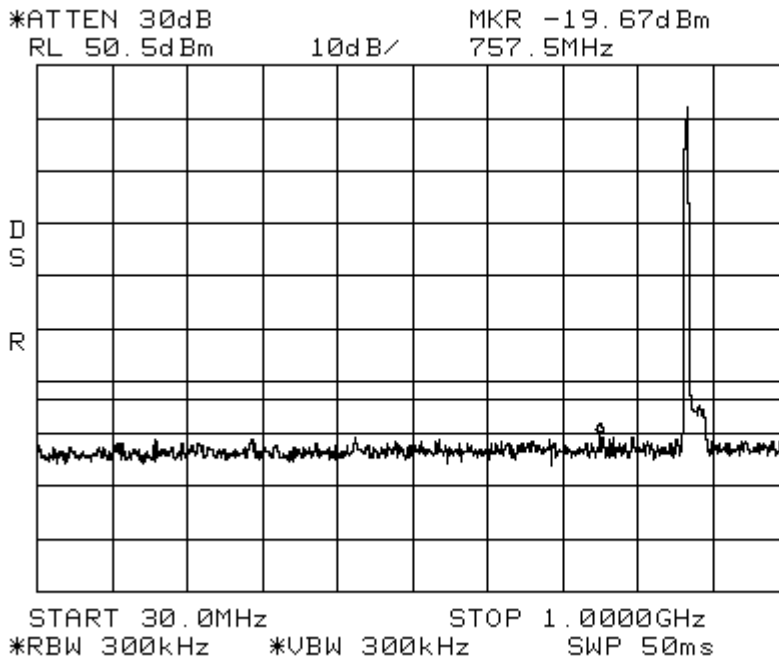

Intermodulation CDMA_Low CELLULAR 40W
Span: 1 GHz to 10 GHz RBW/VBW: 1 MHz

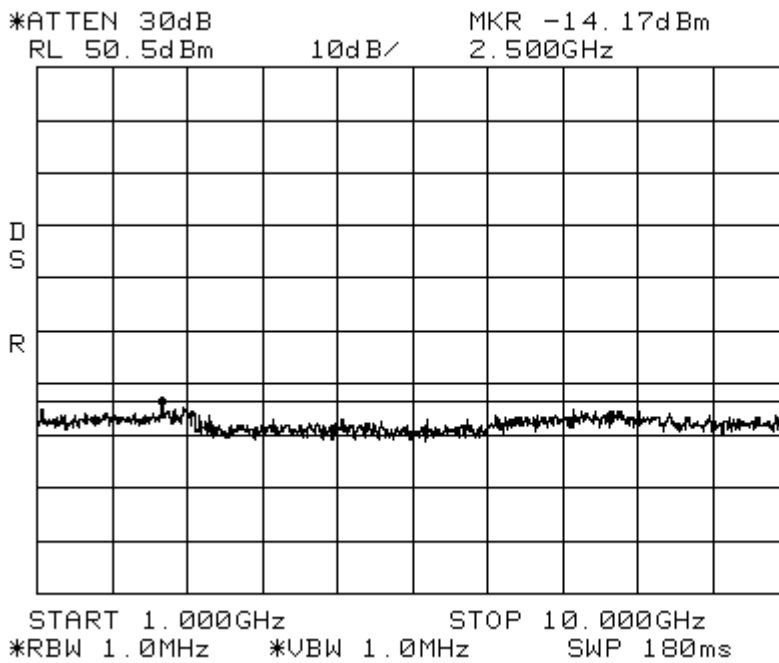

Intermodulation
Center: 881.5 MHz

CDMA_High
Span: 35 MHz

CELLULAR 40W
RBW/VBW: 100 kHz

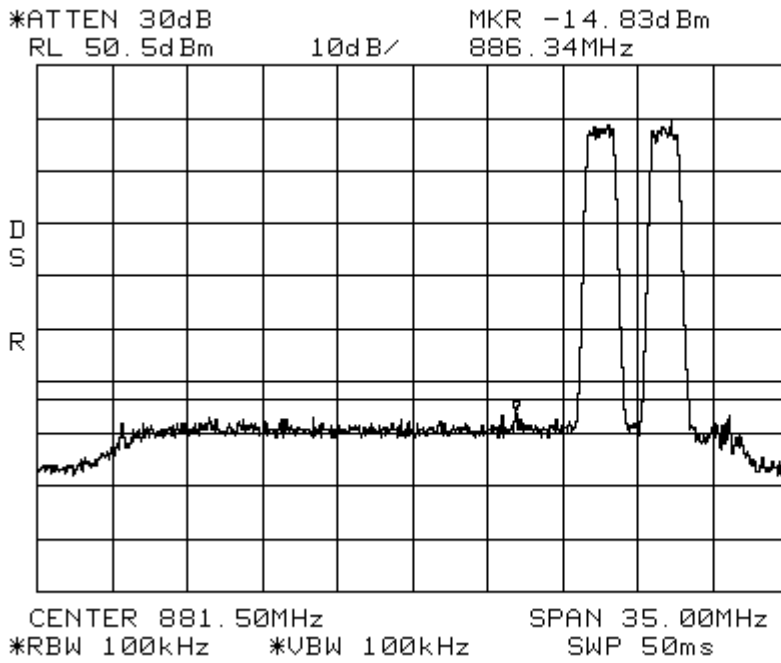

Intermodulation
Span: 30 MHz to 1 GHz

CDMA_High

CELLULAR 40W
RBW/VBW: 300 kHz

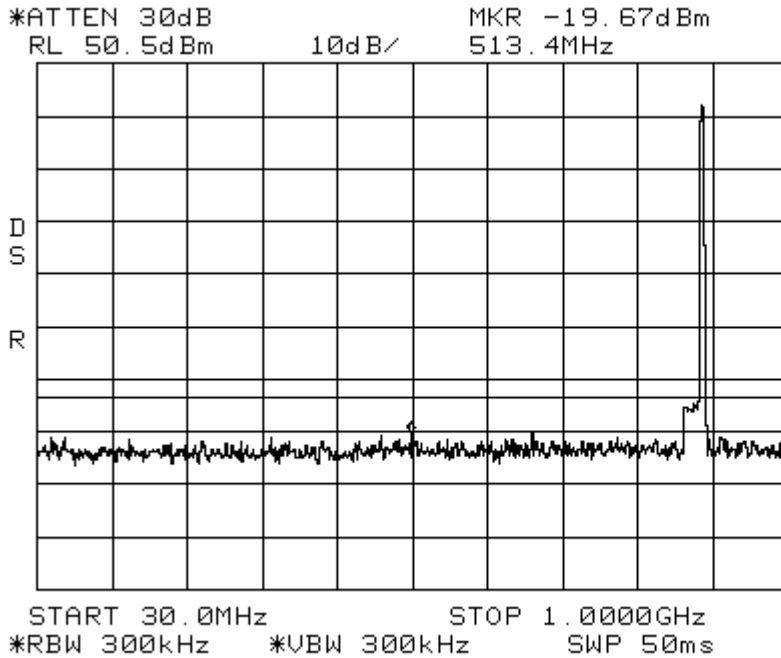

Intermodulation CDMA_High CELLULAR 40W
Span: 1 GHz to 10 GHz RBW/VBW: 1 MHz

*ATTEN 30dB MKR -14.17dBm
RL 50.5dBm 10dB/ 2.665GHz

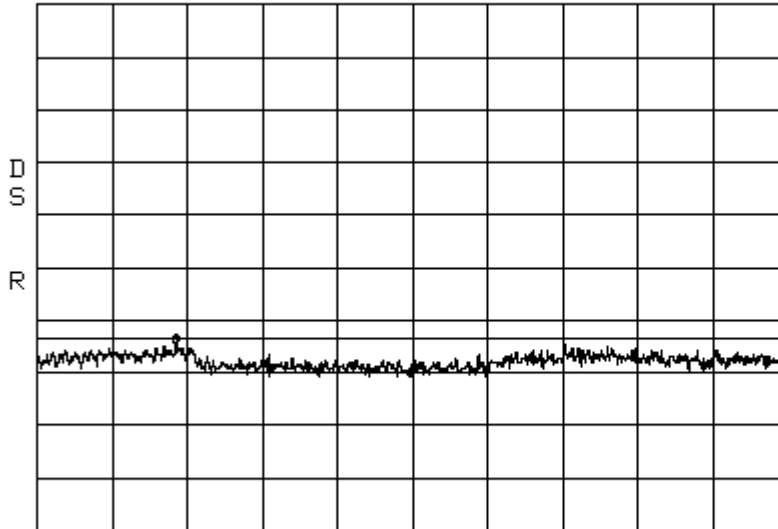

START 1.000GHz STOP 10.000GHz
*RBW 1.0MHz *VBW 1.0MHz SWP 180ms

Intermodulation CDMA_Apart CELLULAR 40W
Center: 881.5 MHz Span: 75 MHz RBW/VBW: 100 kHz

*ATTEN 30dB MKR -23.50dBm
RL 50.5dBm 10dB/ 914.00MHz

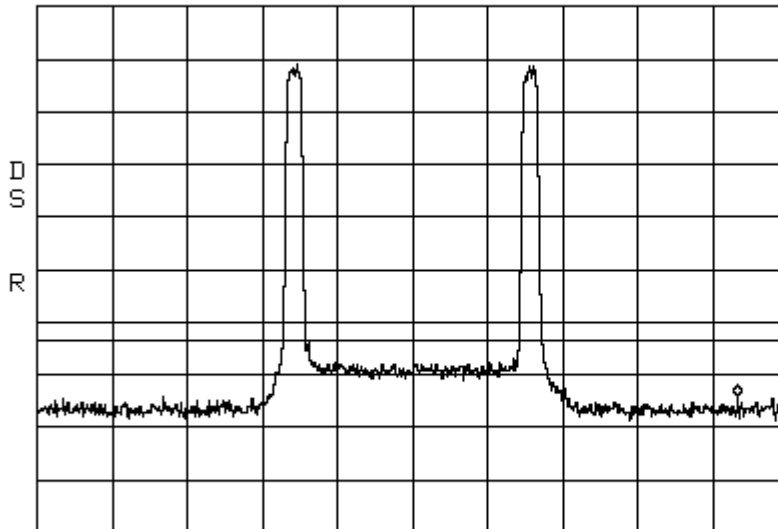

CENTER 881.50MHz SPAN 75.00MHz
*RBW 100kHz *VBW 100kHz SWP 50ms

Intermodulation CDMA_Apart CELLULAR 40W
Span: 30 MHz to 1 GHz RBW/VBW: 300 kHz

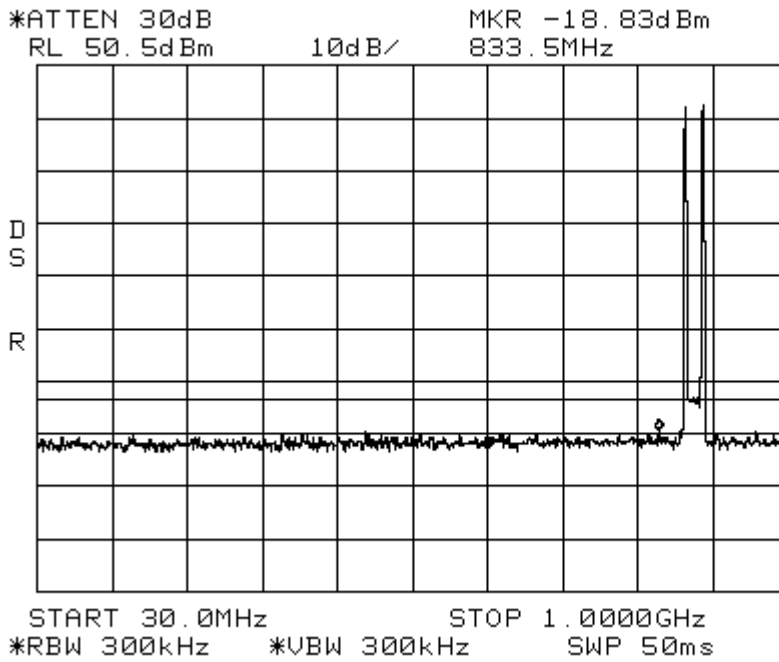

Intermodulation CDMA_Apart CELLULAR 40W
Span: 1 GHz to 10 GHz RBW/VBW: 1 MHz

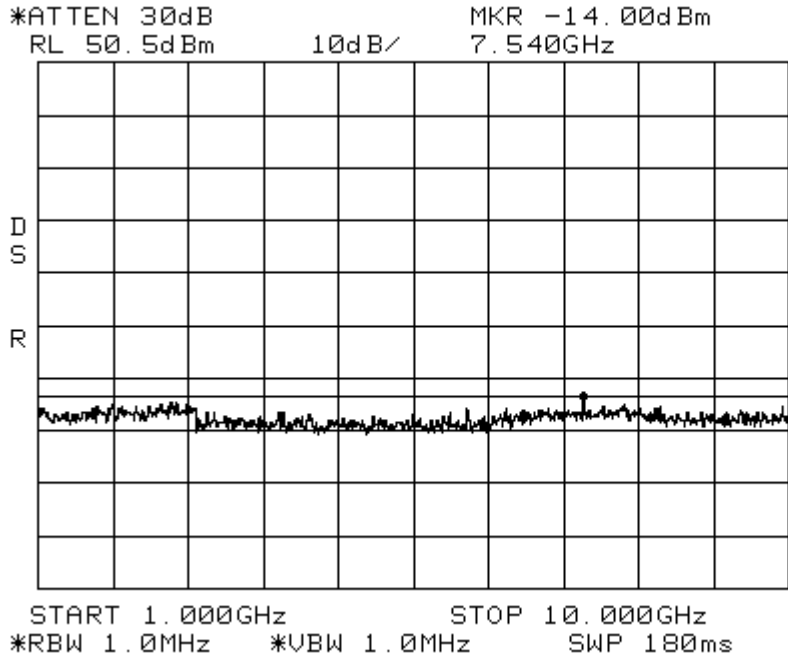

Intermodulation
Center: 881.5 MHz

EDGE_Low
Span: 35 MHz

CELLULAR 40W
RBW/VBW: 100 kHz

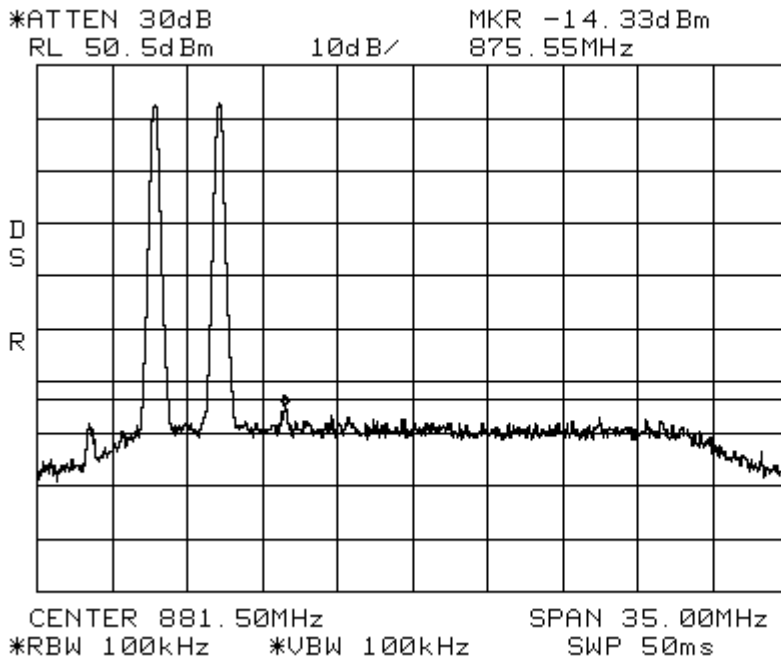

Intermodulation
Span: 30 MHz to 1 GHz

EDGE_Low

CELLULAR 40W
RBW/VBW: 300 kHz

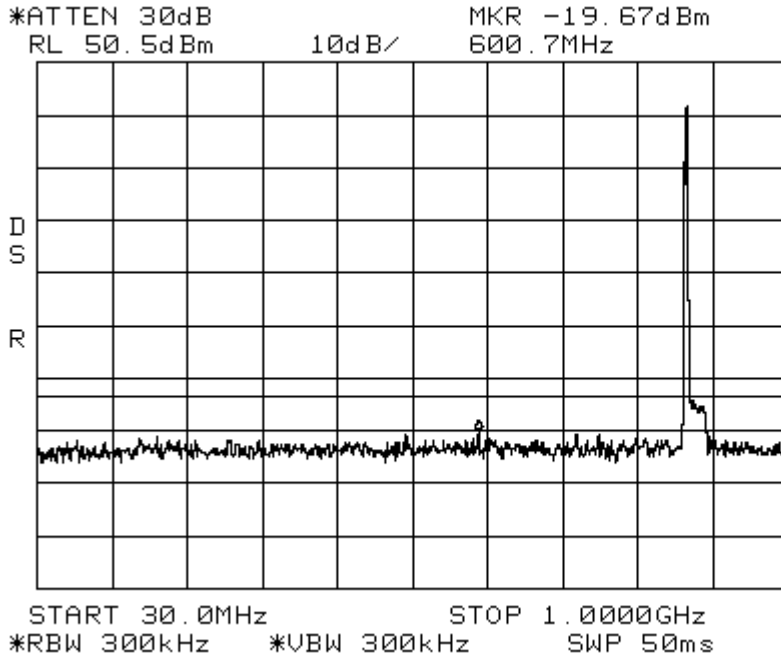

Intermodulation EDGE_Low CELLULAR 40W
Span: 1 GHz to 10 GHz RBW/VBW: 1 MHz

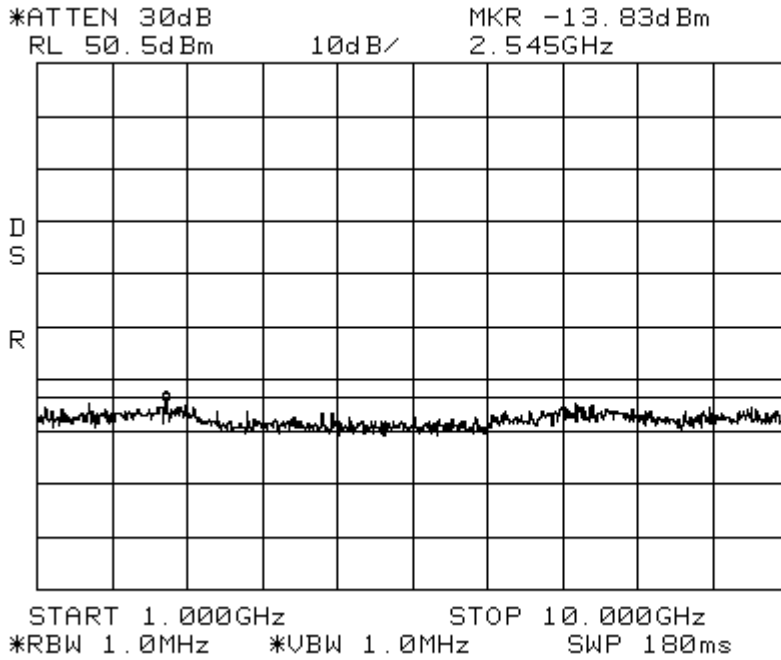

Intermodulation EDGE_High CELLULAR 40W
Center: 881.5 MHz Span: 35 MHz RBW/VBW: 100 kHz

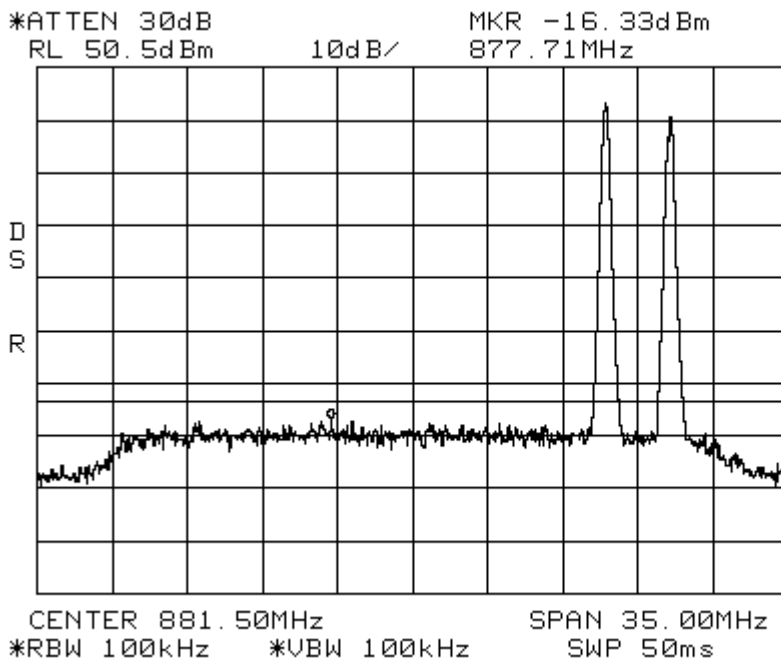

Intermodulation EDGE_High CELLULAR 40W
Span: 30 MHz to 1 GHz RBW/VBW: 300 kHz

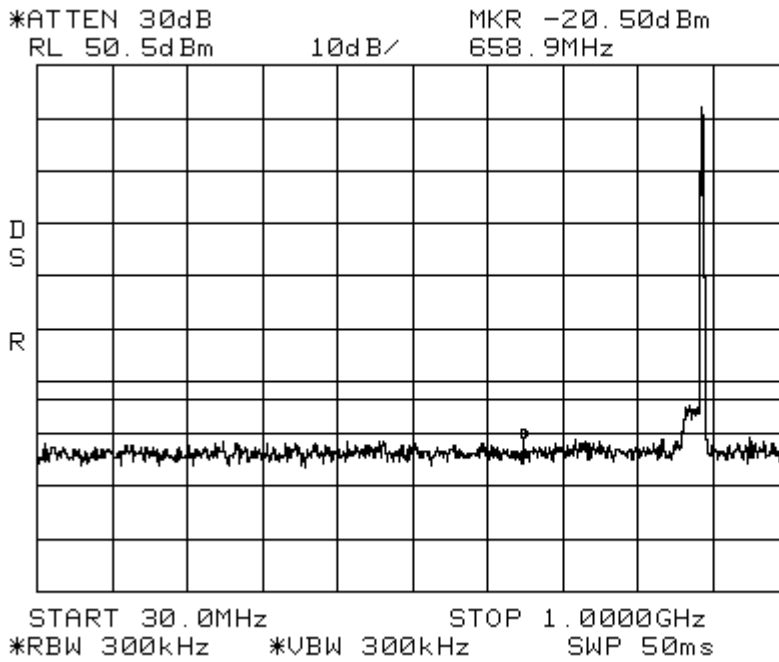

Intermodulation EDGE_High CELLULAR 40W
Span: 1 GHz to 10 GHz RBW/VBW: 1 MHz

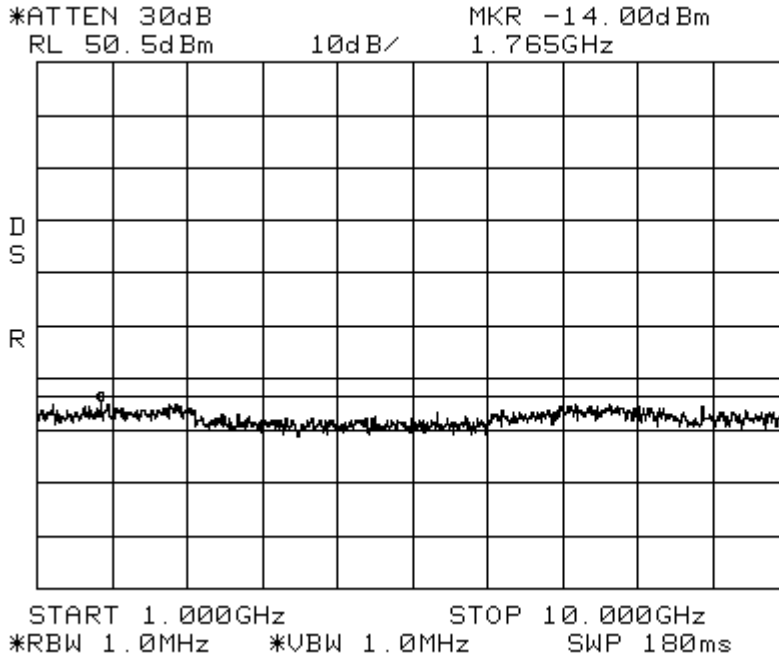

Intermodulation EDGE_Apart CELLULAR 40W
 Center: 881.5 MHz Span: 75 MHz RBW/VBW: 100 kHz
 *ATTEN 30dB MKR -23.50dBm
 RL 50.5dBm 10dB/ 855.50MHz

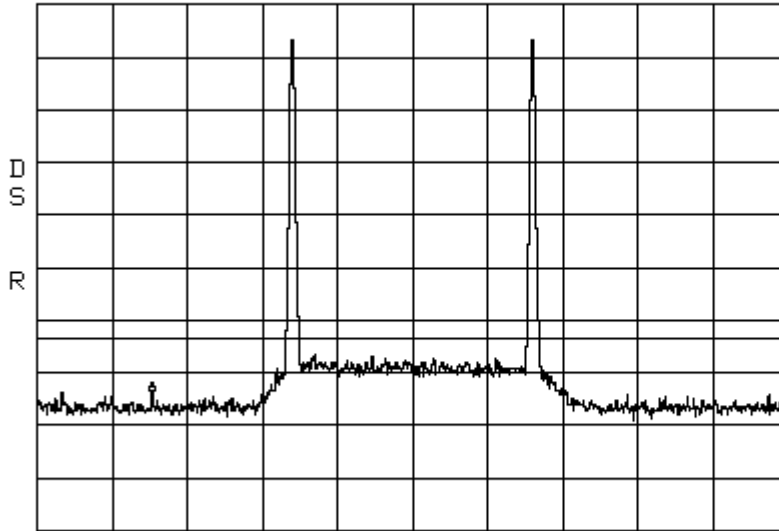

CENTER 881.50MHz SPAN 75.00MHz
 *RBW 100kHz *VBW 100kHz SWP 50ms

Intermodulation EDGE_Apart CELLULAR 40W
 Span: 30 MHz to 1 GHz RBW/VBW: 300 kHz

*ATTEN 30dB MKR -18.83dBm
 RL 50.5dBm 10dB/ 723.6MHz

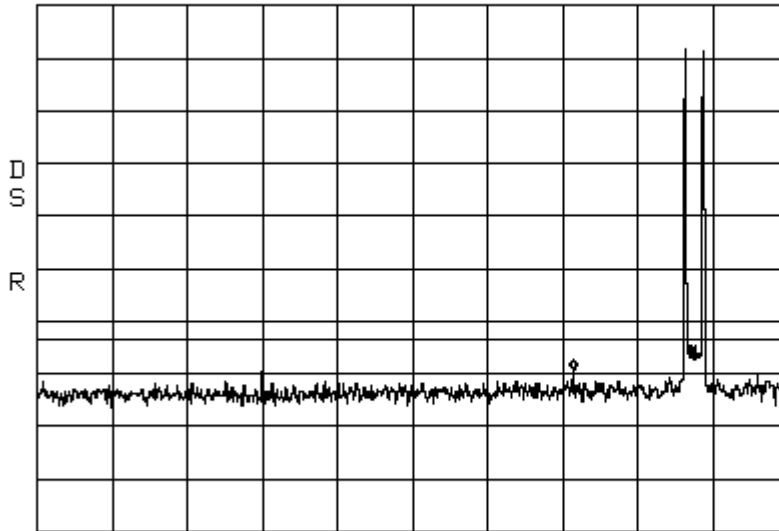

START 30.0MHz STOP 1.0000GHz
 *RBW 300kHz *VBW 300kHz SWP 50ms

Intermodulation EDGE_Apart CELLULAR 40W
Span: 1 GHz to 10 GHz RBW/VBW: 1 MHz

*ATTEN 30dB MKR -14.00dBm
RL 50.5dBm 10dB/ 7.330GHz

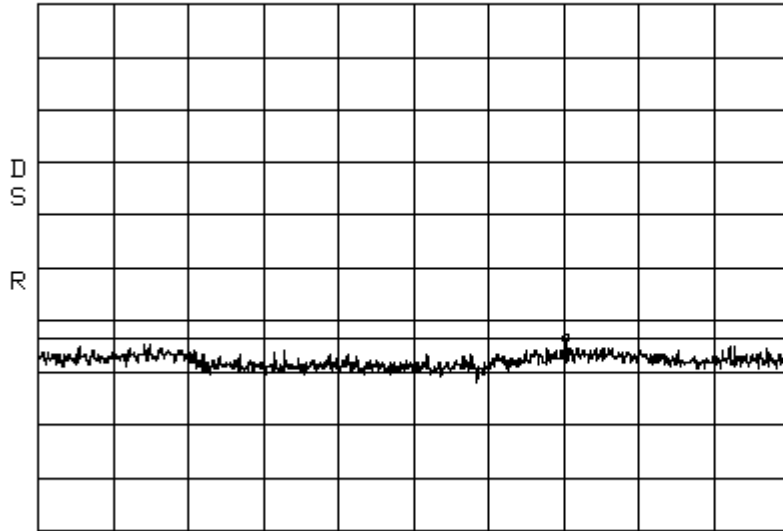

START 1.000GHz STOP 10.000GHz
*RBW 1.0MHz *VBW 1.0MHz SWP 180ms

Intermodulation GSM_Low CELLULAR 40W
Center: 881.5 MHz Span: 35 MHz RBW/VBW: 100 kHz

*ATTEN 30dB MKR -15.83dBm
RL 50.5dBm 10dB/ 878.58MHz

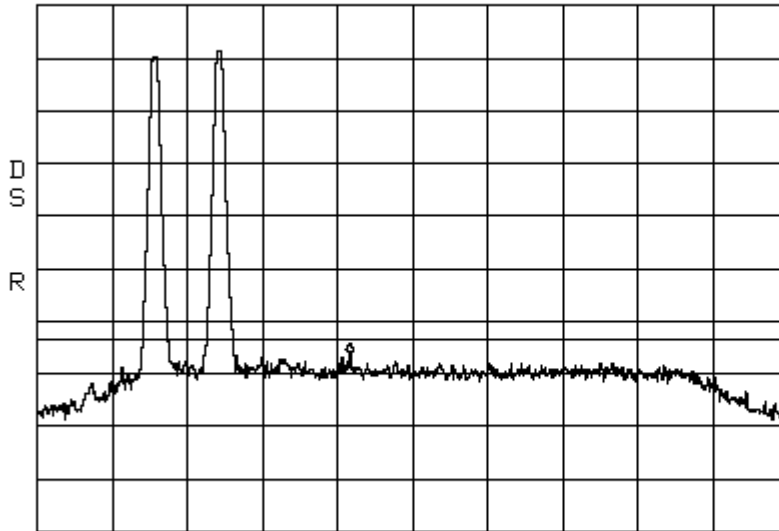

CENTER 881.50MHz SPAN 35.00MHz
*RBW 100kHz *VBW 100kHz SWP 50ms

Intermodulation GSM_Low CELLULAR 40W
Span: 30 MHz to 1 GHz RBW/VBW: 300 kHz

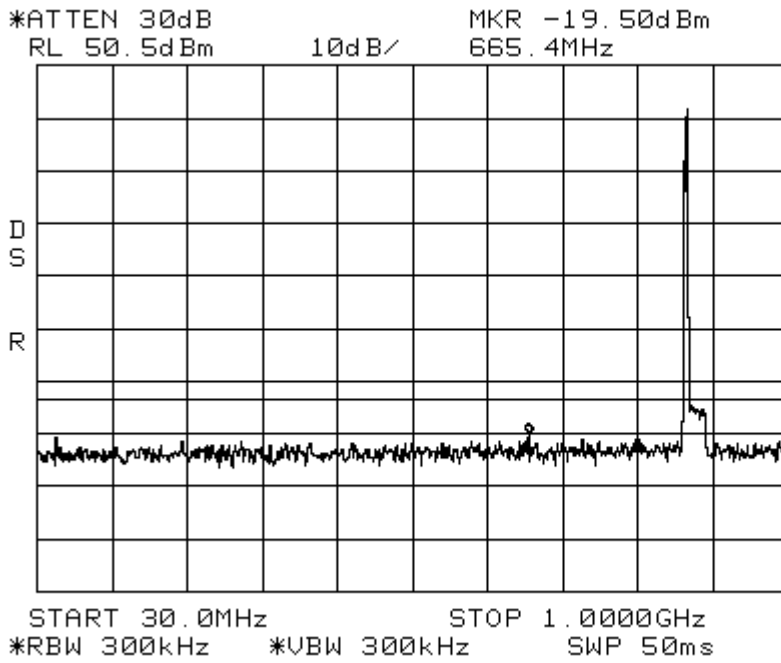

Intermodulation GSM_Low CELLULAR 40W
Span: 1 GHz to 10 GHz RBW/VBW: 1 MHz

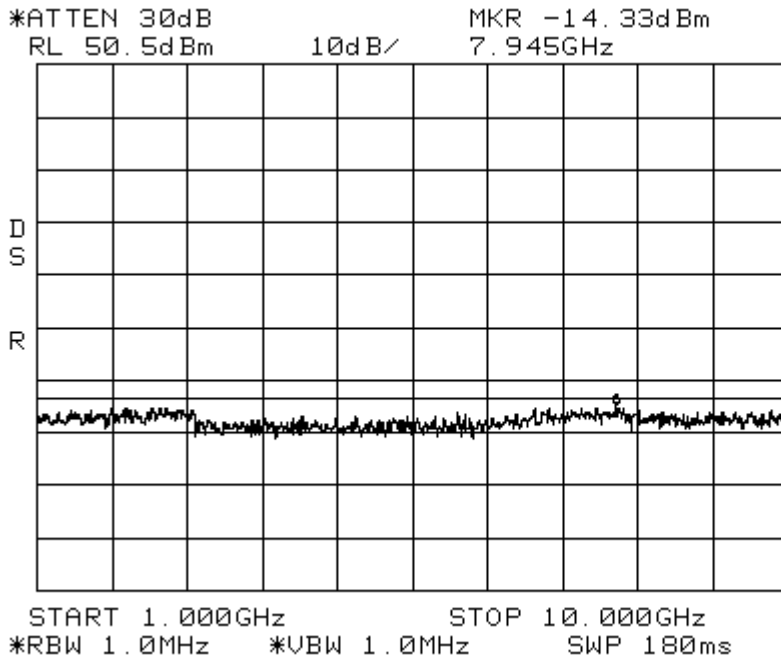

Intermodulation
Center: 881.5 MHz

GSM_High
Span: 35 MHz

CELLULAR 40W
RBW/VBW: 100 kHz

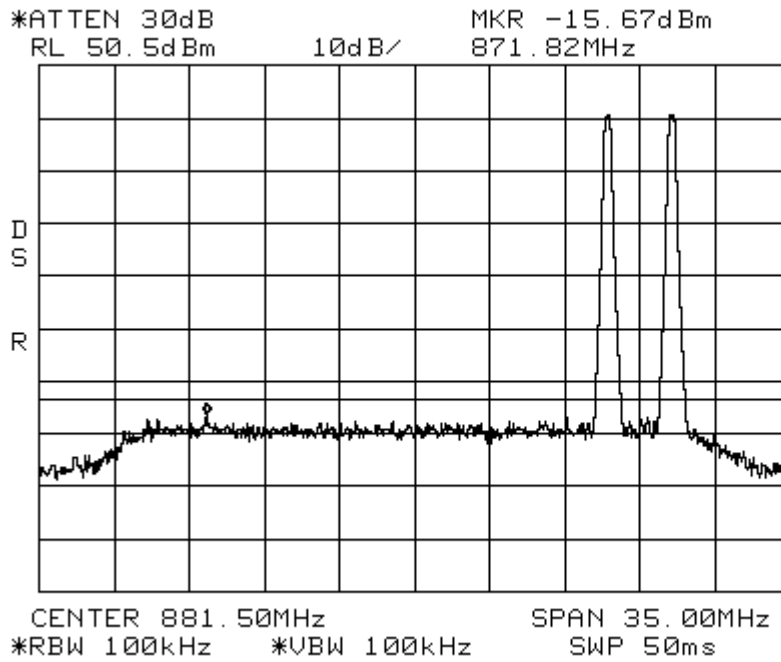

Intermodulation
Span: 30 MHz to 1 GHz

GSM_High

CELLULAR 40W
RBW/VBW: 300 kHz

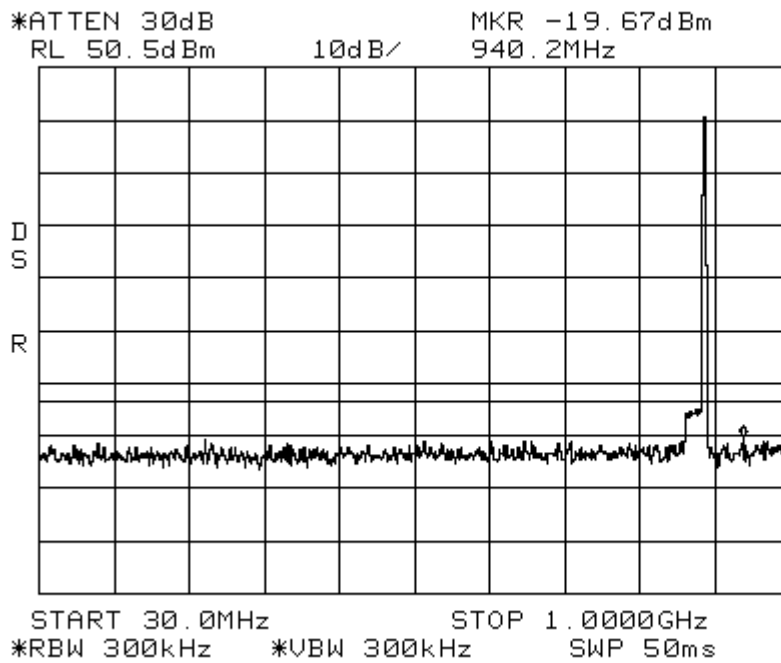

Intermodulation GSM_High CELLULAR 40W
Span: 1 GHz to 10 GHz RBW/VBW: 1 MHz

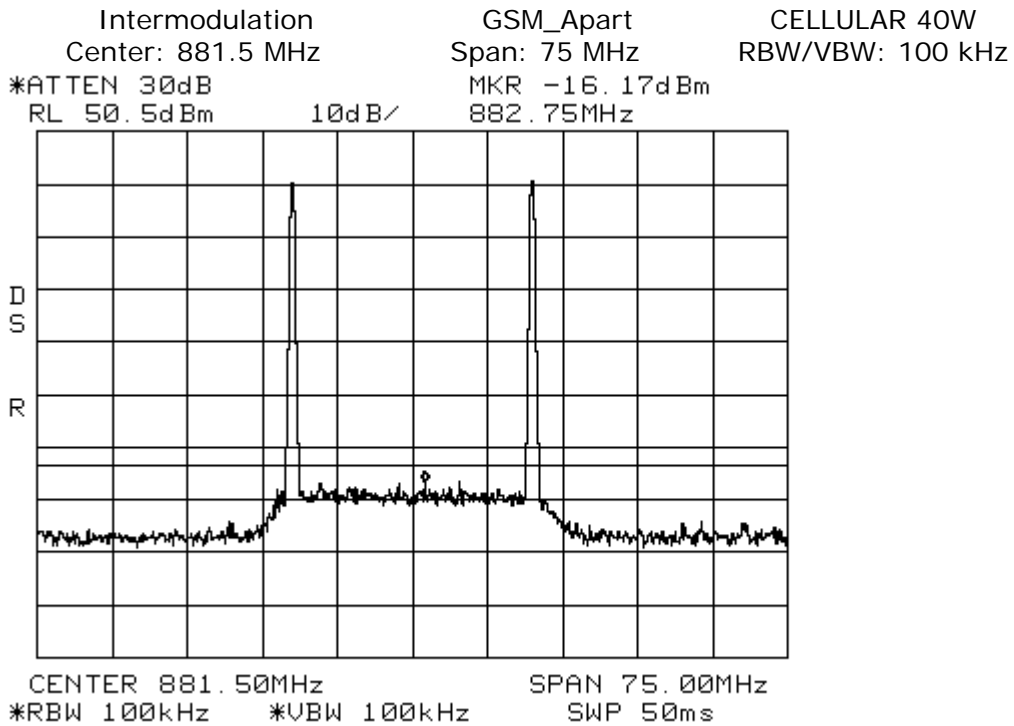
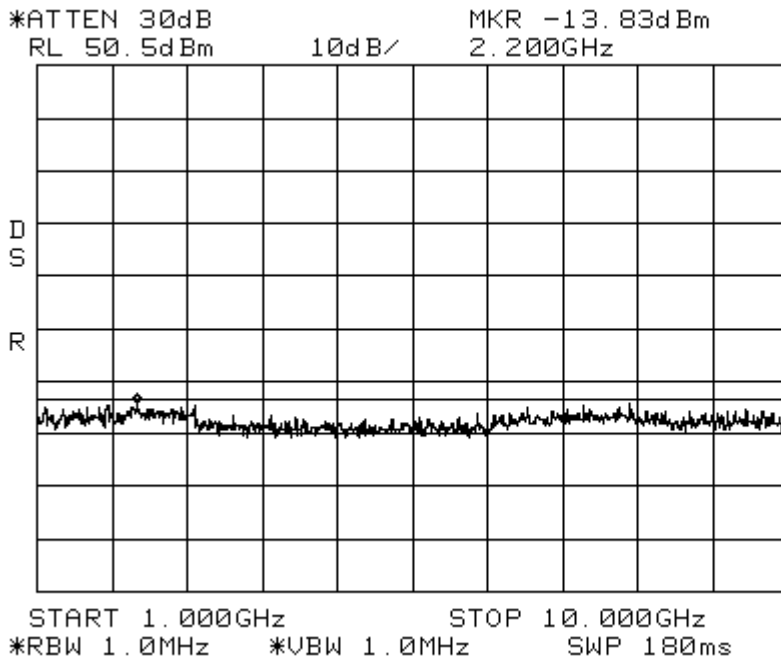

Intermodulation GSM_Apart CELLULAR 40W
Span: 30 MHz to 1 GHz RBW/VBW: 300 kHz

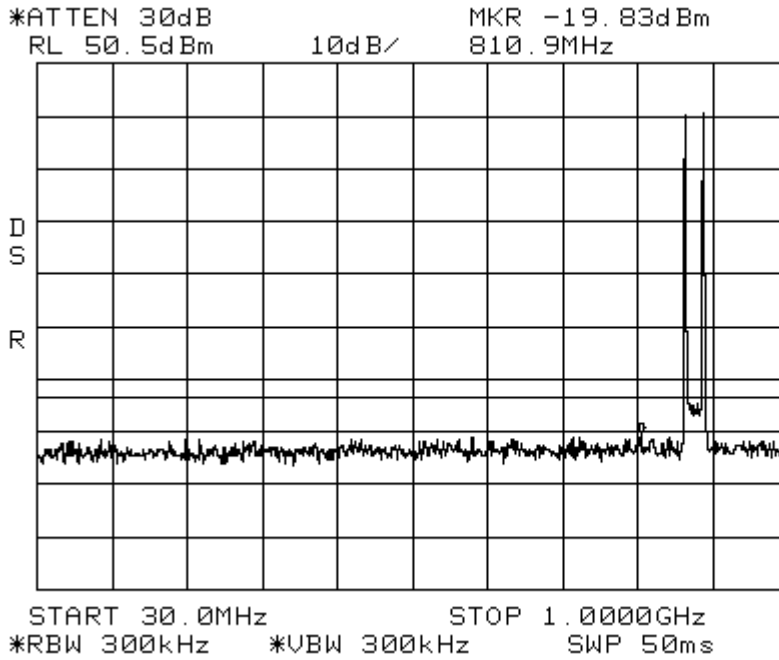

Intermodulation GSM_Apart CELLULAR 40W
Span: 1 GHz to 10 GHz RBW/VBW: 1 MHz

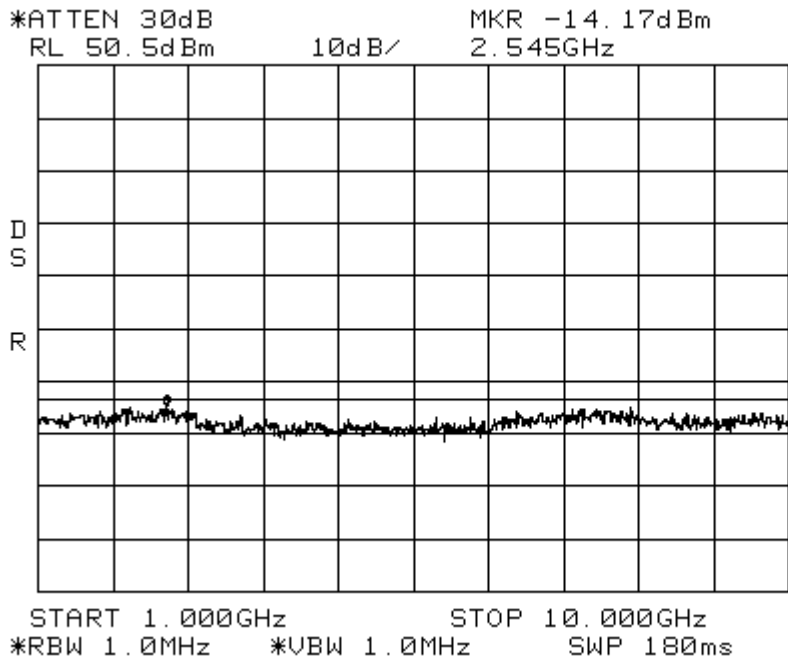

Intermodulation LTE 1.4 MHz Channel Bandwidth_Low CELLULAR 40W
Center: 881.5 MHz Span: 35 MHz RBW/VBW: 100 kHz

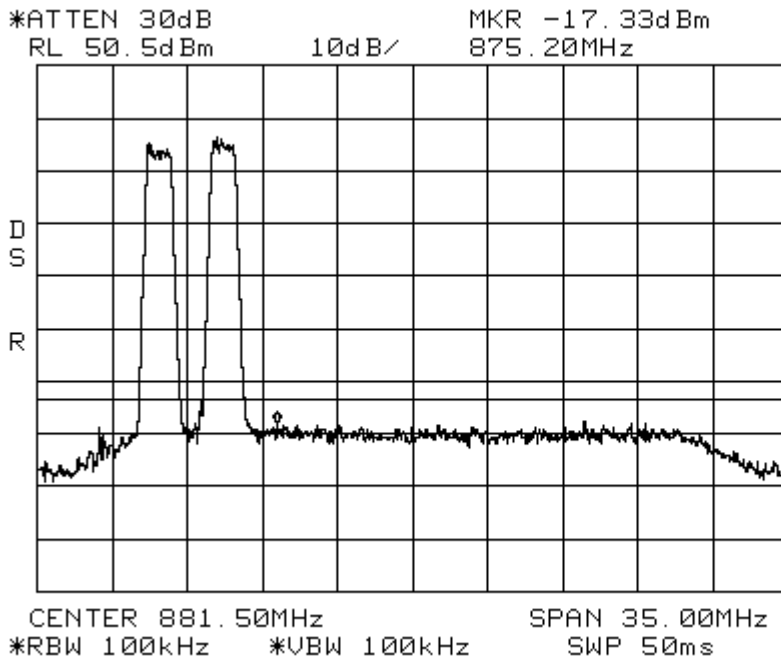

Intermodulation LTE 1.4 MHz Channel Bandwidth_Low CELLULAR 40W
Span: 30 MHz to 1 GHz RBW/VBW: 300 kHz

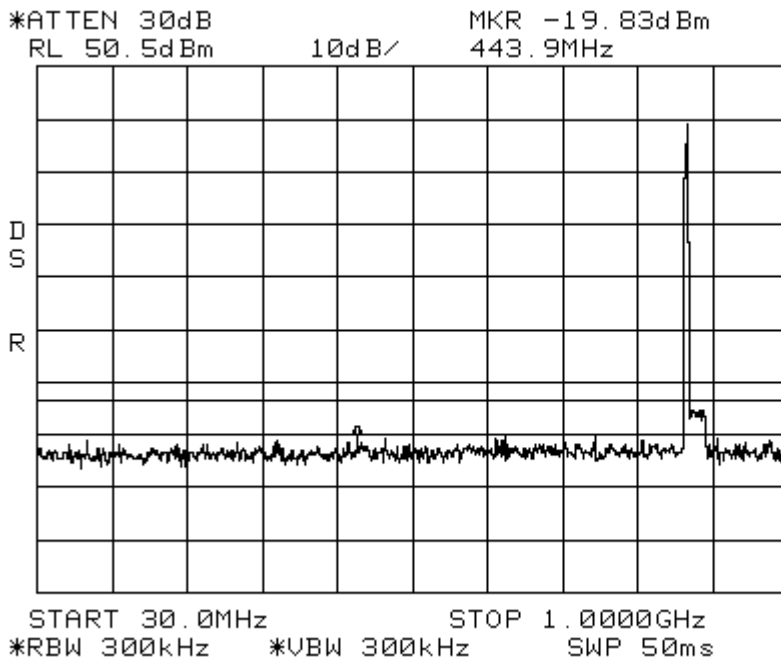

Intermodulation LTE 1.4 MHz Channel Bandwidth _Low CELLULAR 40W
Span: 1 GHz to 10 GHz RBW/VBW: 1 MHz

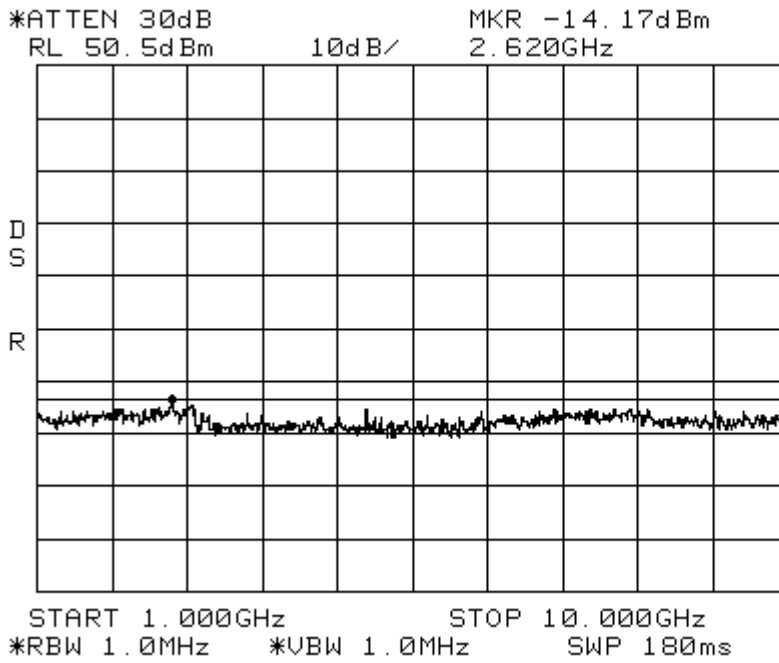

Intermodulation LTE 1.4 MHz Channel Bandwidth _High CELLULAR 40W
Center: 751 MHz Span: 35 MHz RBW/VBW: 100 kHz

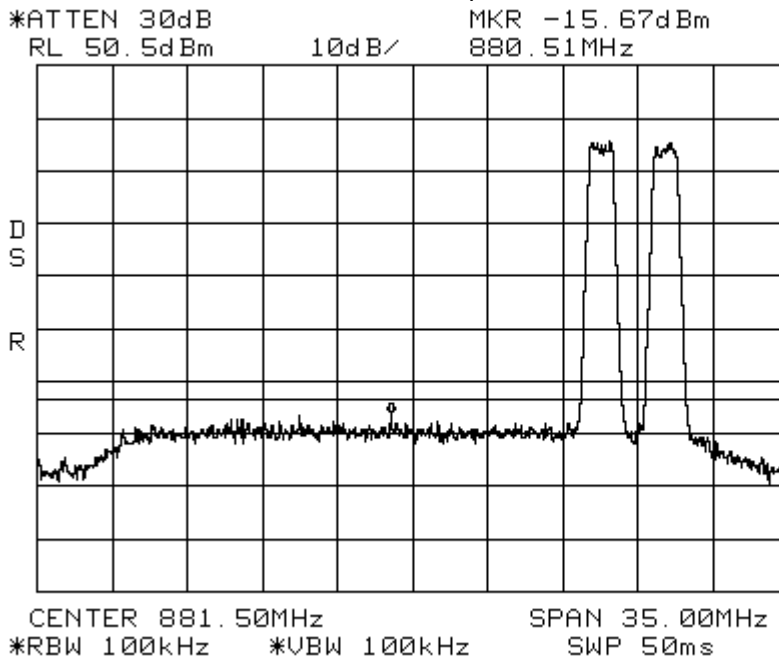

Intermodulation LTE 1.4 MHz Channel Bandwidth _High CELLULAR 40W
Span: 30 MHz to 1 GHz RBW/VBW: 300 kHz

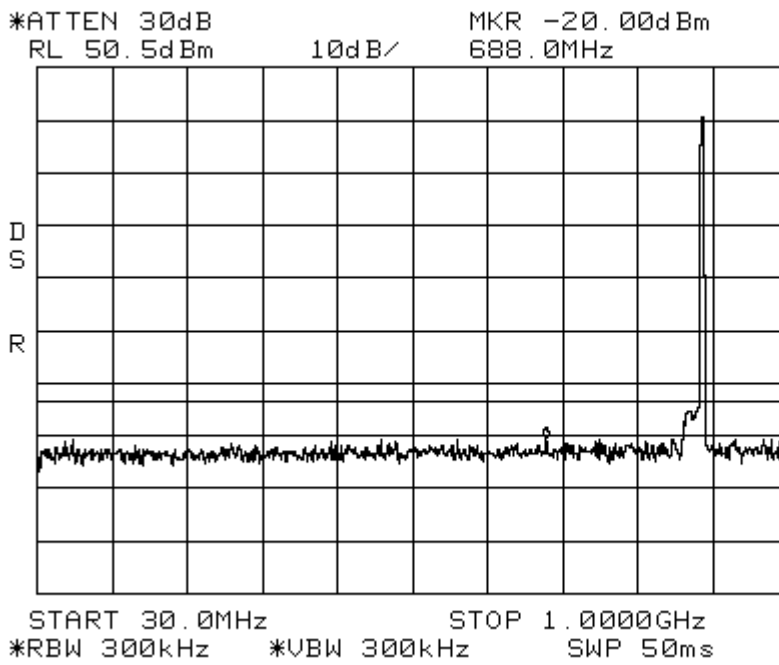

Intermodulation LTE 1.4 MHz Channel Bandwidth _High CELLULAR 40W
Span: 1 GHz to 10 GHz RBW/VBW: 1 MHz

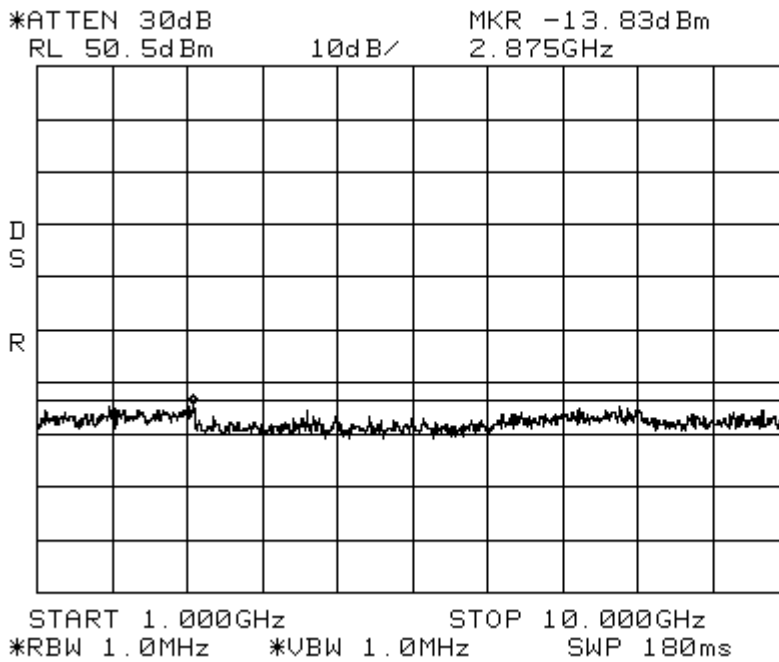

Intermodulation LTE 1.4 MHz Channel Bandwidth _Apart CELLULAR 40W
Center: 751 MHz Span: 70 MHz RBW/VBW: 100 kHz

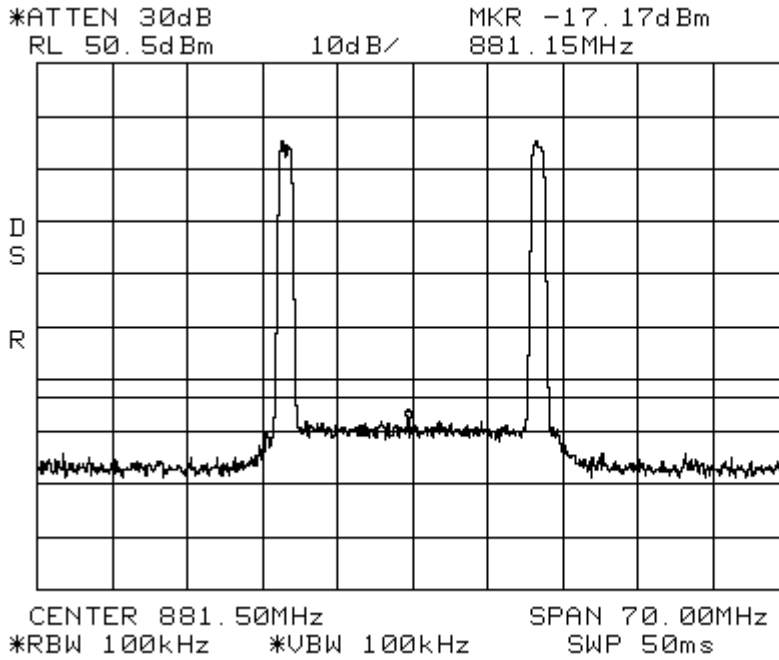

Intermodulation LTE 1.4 MHz Channel Bandwidth _Apart CELLULAR 40W
Span: 30 MHz to 1 GHz RBW/VBW: 300 kHz

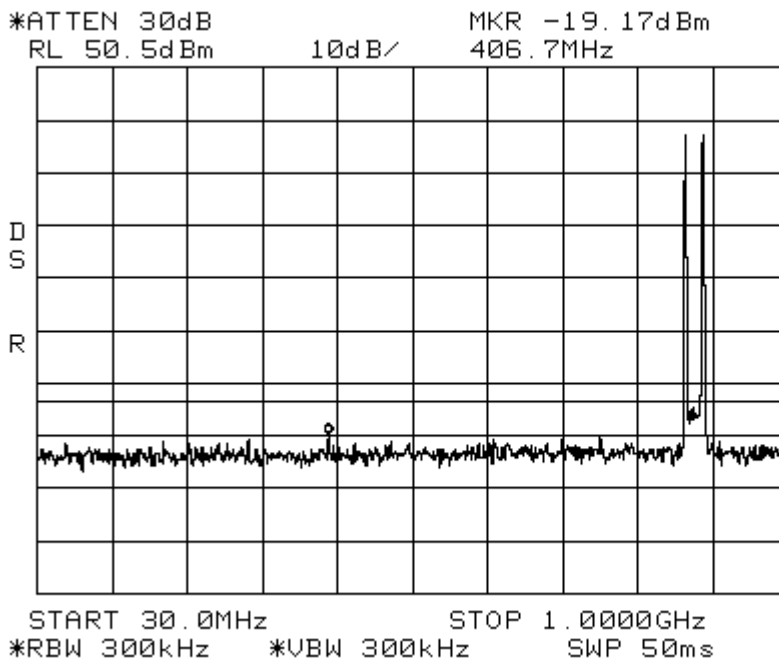

Intermodulation LTE 1.4 MHz Channel Bandwidth _Apart CELLULAR 40W
Span: 1 GHz to 10 GHz RBW/VBW: 1 MHz

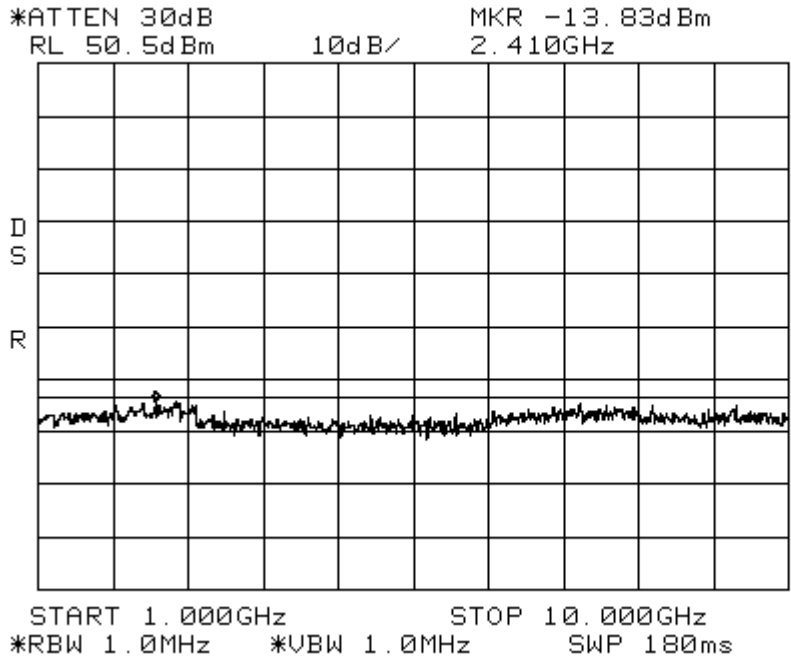

Intermodulation LTE 3 MHz Channel Bandwidth_Low CELLULAR 40W
Center: 881.5 MHz Span: 35 MHz RBW/VBW: 100 kHz

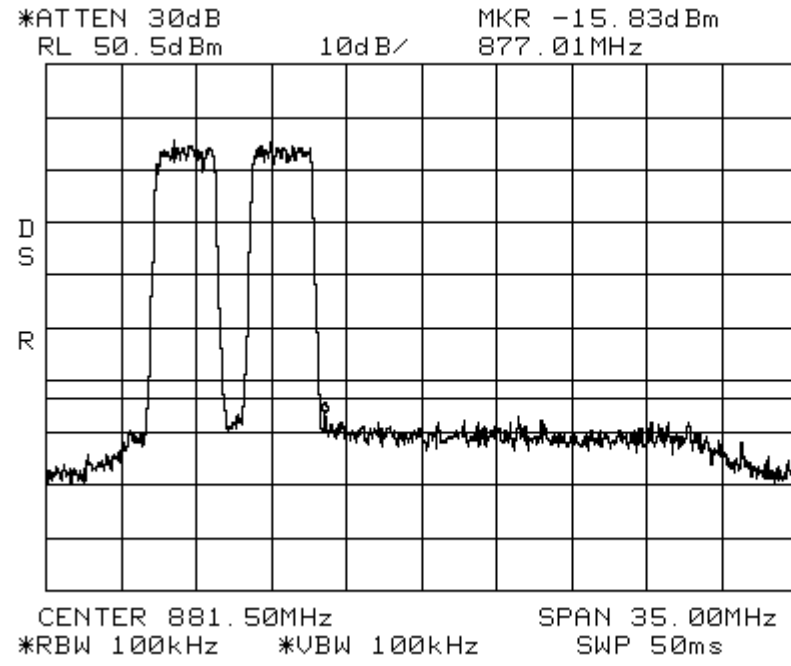

Intermodulation LTE 3 MHz Channel Bandwidth _Low CELLULAR 40W
Span: 30 MHz to 1 GHz RBW/VBW: 300 kHz

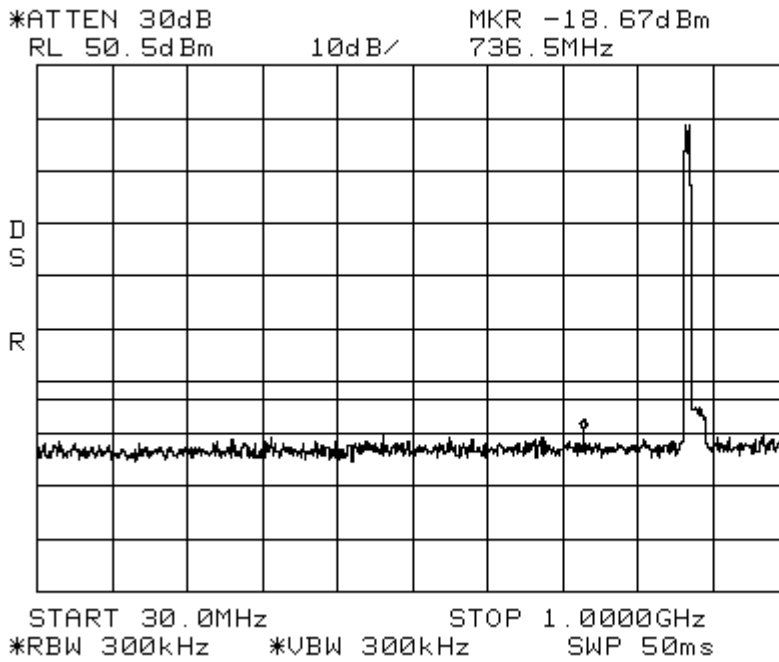

Intermodulation LTE 3 MHz Channel Bandwidth _Low CELLULAR 40W
Span: 1 GHz to 10 GHz RBW/VBW: 1 MHz

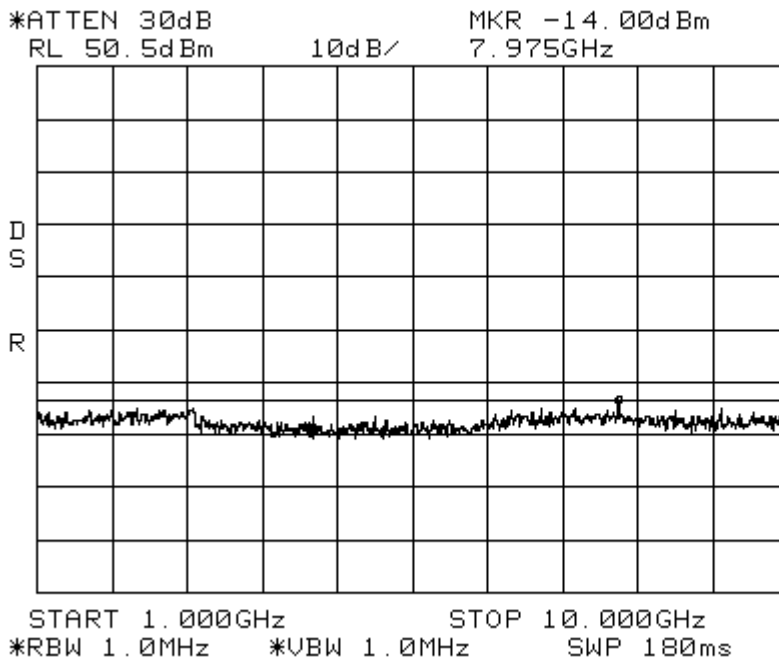

Intermodulation LTE 3 MHz Channel Bandwidth _High CELLULAR 40W
Center: 881.5 MHz Span: 35 MHz RBW/VBW: 100 kHz

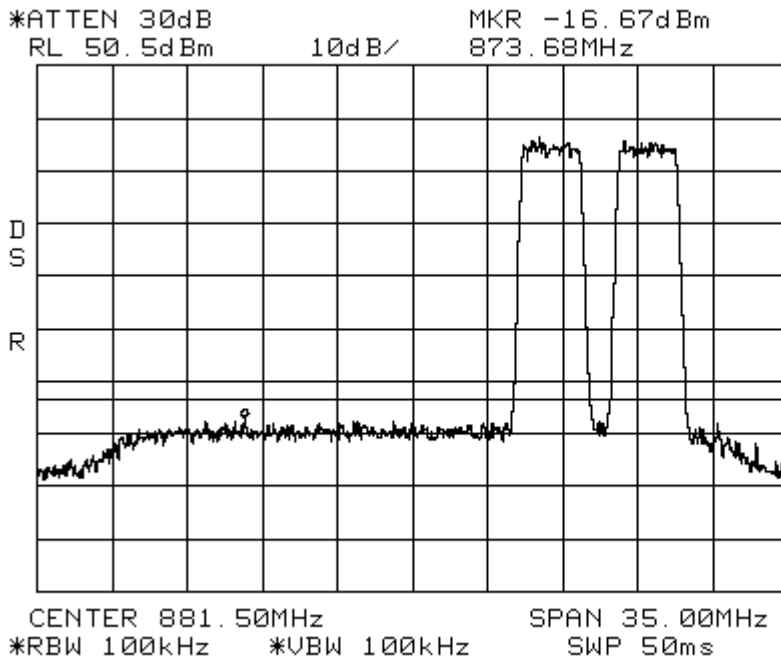

Intermodulation LTE 3 MHz Channel Bandwidth _High CELLULAR 40W
Span: 30 MHz to 1 GHz RBW/VBW: 300 kHz

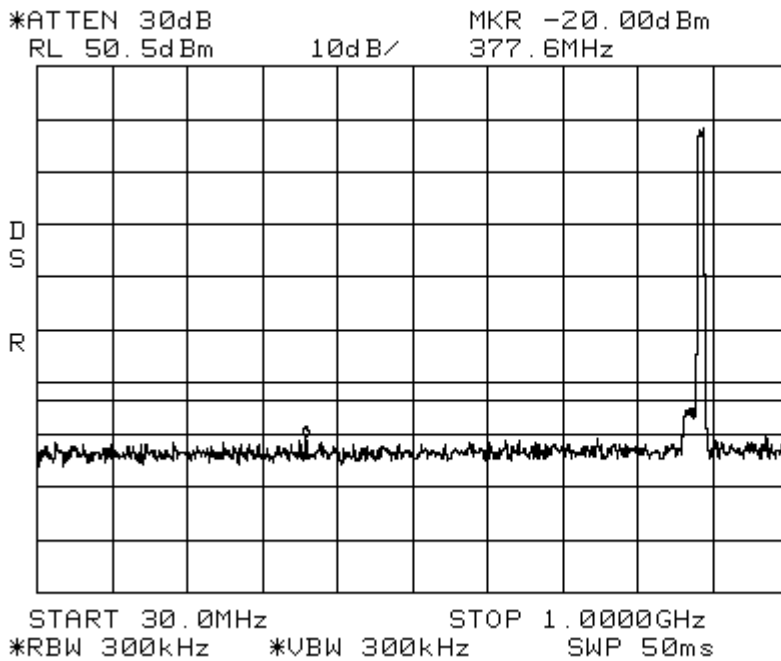

Intermodulation

LTE 3 MHz Channel Bandwidth _High
Span: 1 GHz to 10 GHz

CELLULAR 40W

RBW/VBW: 1 MHz

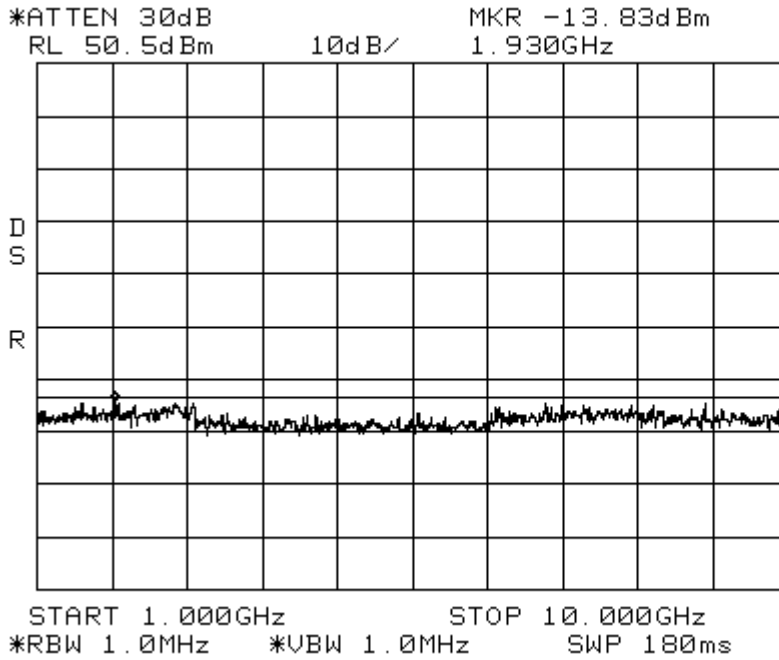

Intermodulation

LTE 3 MHz Channel Bandwidth _Apart
Center: 881.5 MHz Span: 70 MHz

CELLULAR 40W

RBW/VBW: 100 kHz

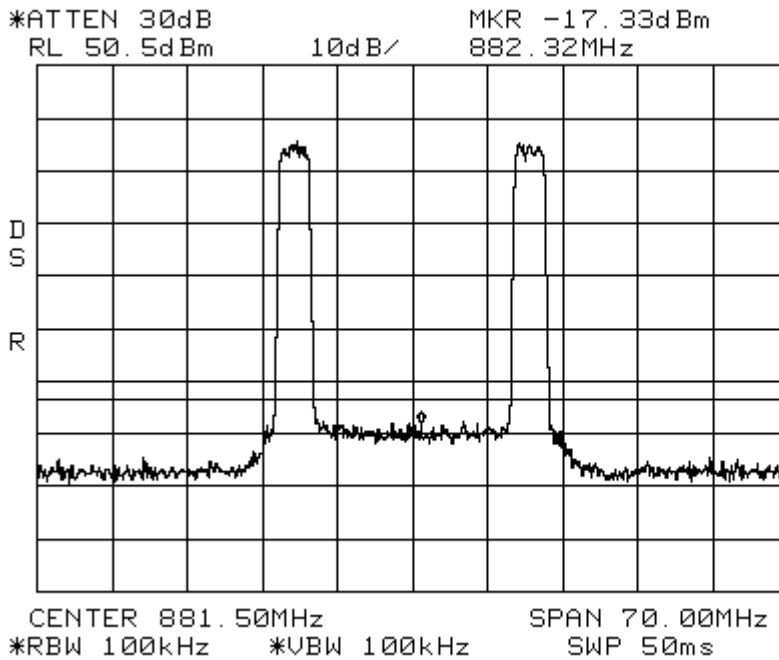

Intermodulation LTE 3 MHz Channel Bandwidth _Apart CELLULAR 40W
Span: 30 MHz to 1 GHz RBW/VBW: 300 kHz

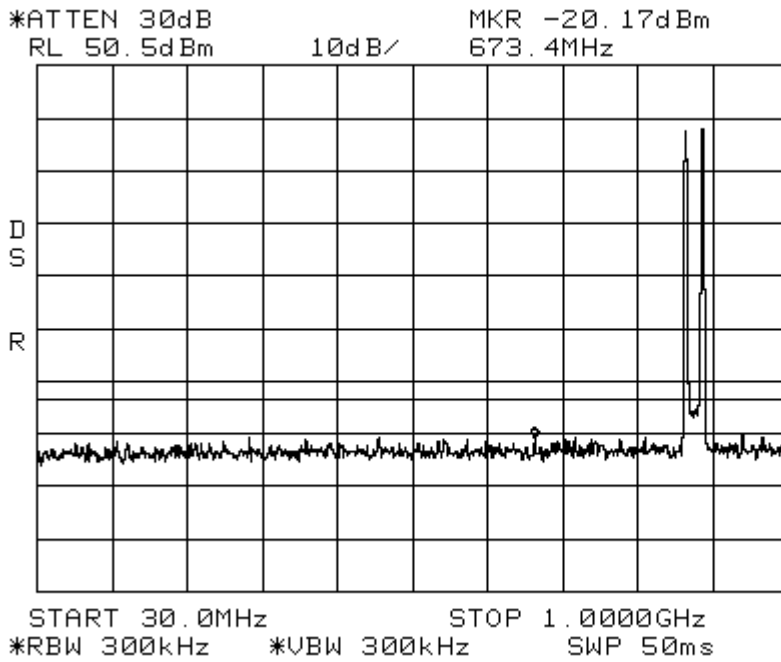

Intermodulation LTE 3 MHz Channel Bandwidth _Apart CELLULAR 40W
Span: 1 GHz to 10 GHz RBW/VBW: 1 MHz

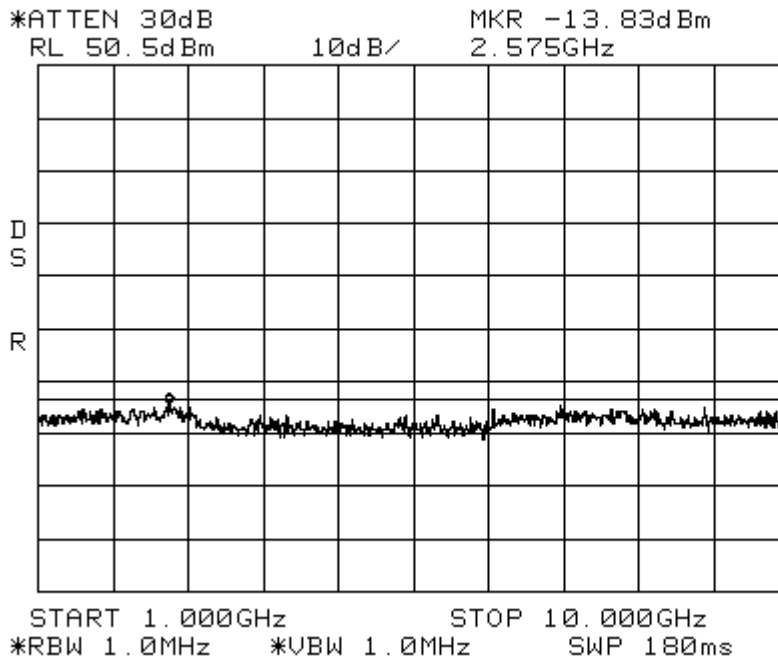

Intermodulation LTE 5 MHz Channel Bandwidth_Low CELLULAR 40W
Center: 881.5 MHz Span: 35 MHz RBW/VBW: 100 kHz

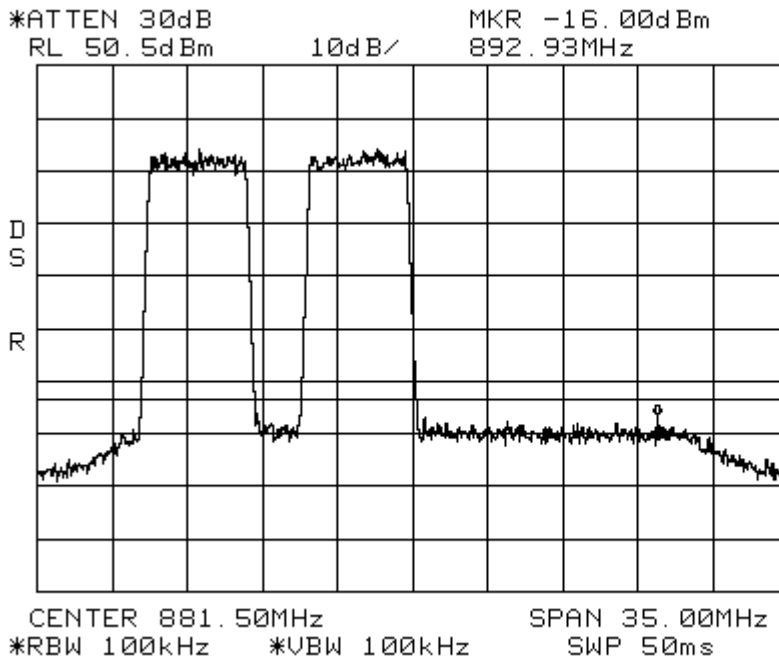

Intermodulation LTE 5 MHz Channel Bandwidth_Low CELLULAR 40W
Span: 30 MHz to 1 GHz RBW/VBW: 300 kHz

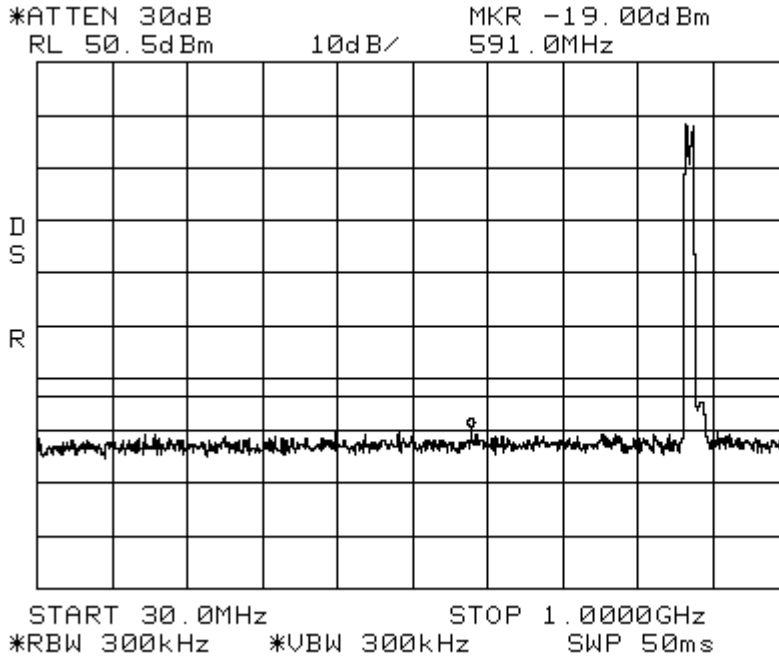

Intermodulation LTE 5 MHz Channel Bandwidth _Apart CELLULAR 40W
Center: 881.5 MHz Span: 70 MHz RBW/VBW: 100 kHz

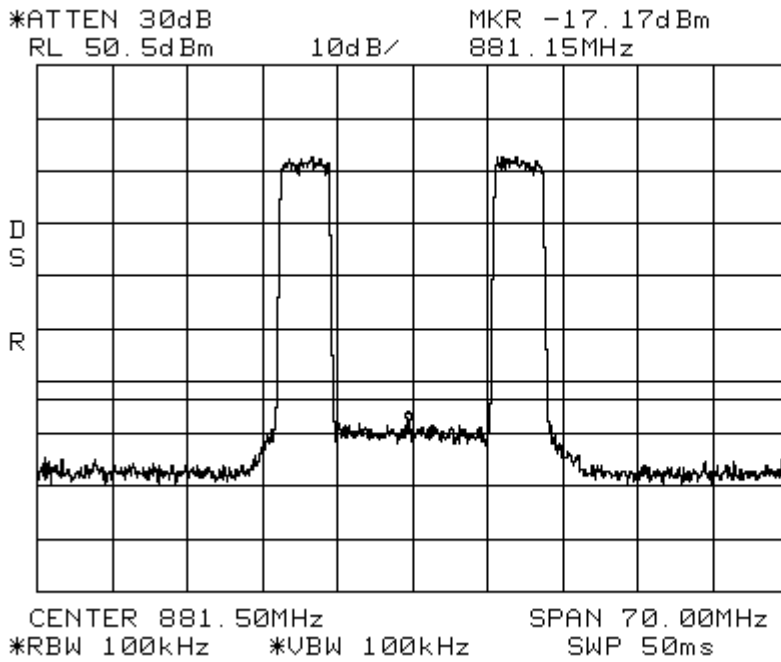

Intermodulation LTE 5 MHz Channel Bandwidth _Apart CELLULAR 40W
Span: 30 MHz to 1 GHz RBW/VBW: 300 kHz

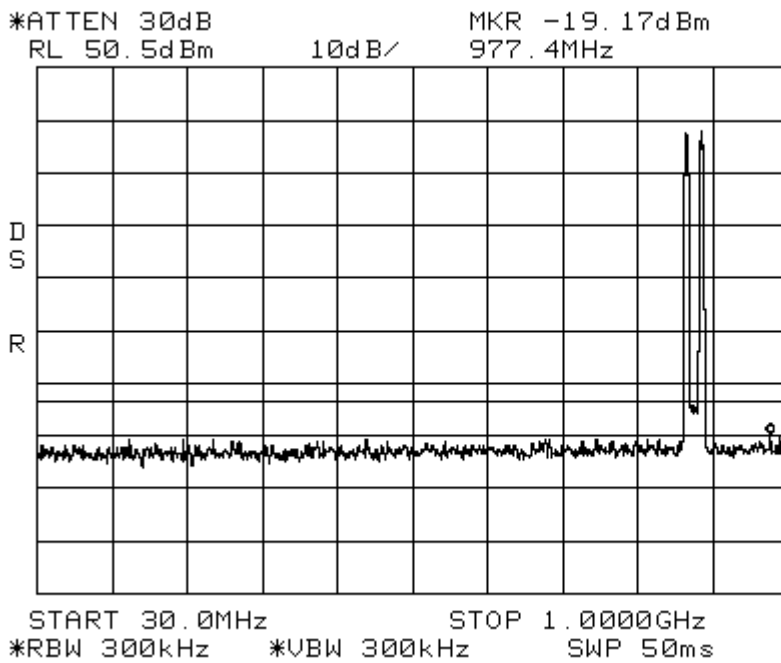

Intermodulation LTE 5 MHz Channel Bandwidth_Apart CELLULAR 40W
Span: 1 GHz to 10 GHz RBW/VBW: 1 MHz

*ATTEN 30dB MKR -13.83dBm
RL 50.5dBm 10dB/ 2.020GHz

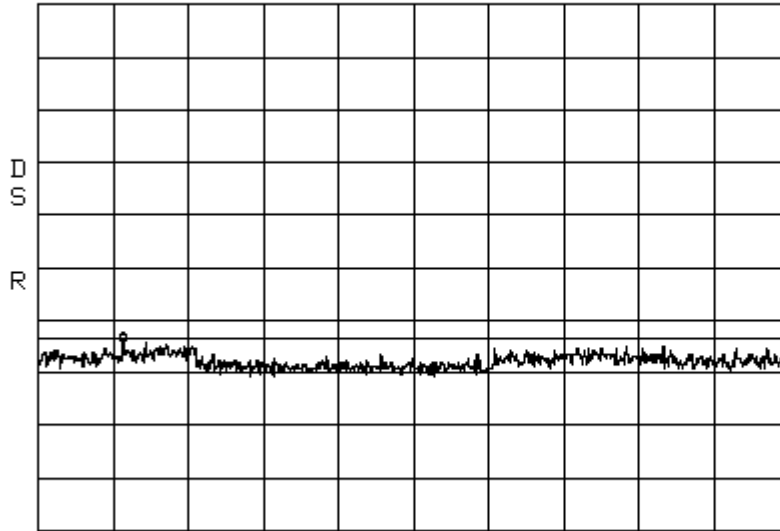

START 1.000GHz STOP 10.000GHz
*RBW 1.0MHz *VBW 1.0MHz SWP 180ms

Intermodulation LTE 10 MHz Channel Bandwidth_Low CELLULAR 40W
Center: 881.5 MHz Span: 70 MHz RBW/VBW: 100 kHz

*ATTEN 30dB MKR -17.00dBm
RL 50.5dBm 10dB/ 880.22MHz

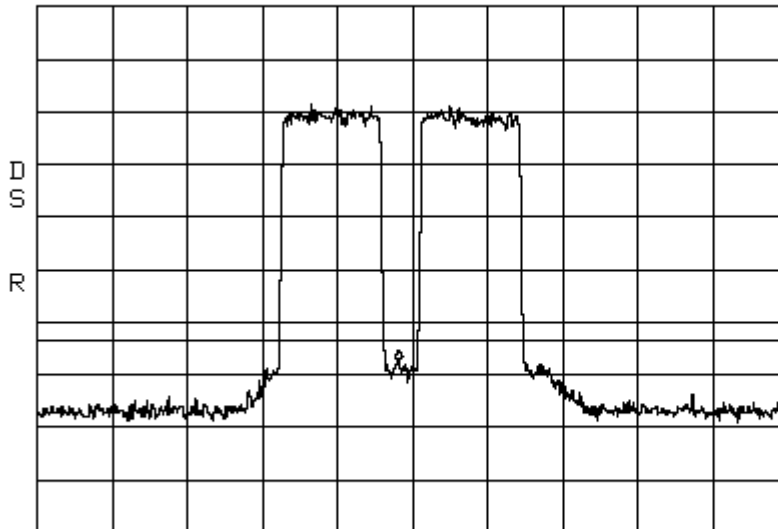

CENTER 881.50MHz SPAN 70.00MHz
*RBW 100kHz *VBW 100kHz SWP 50ms

Intermodulation LTE 10 MHz Channel Bandwidth _Low CELLULAR 40W
Span: 30 MHz to 1 GHz RBW/VBW: 300 kHz

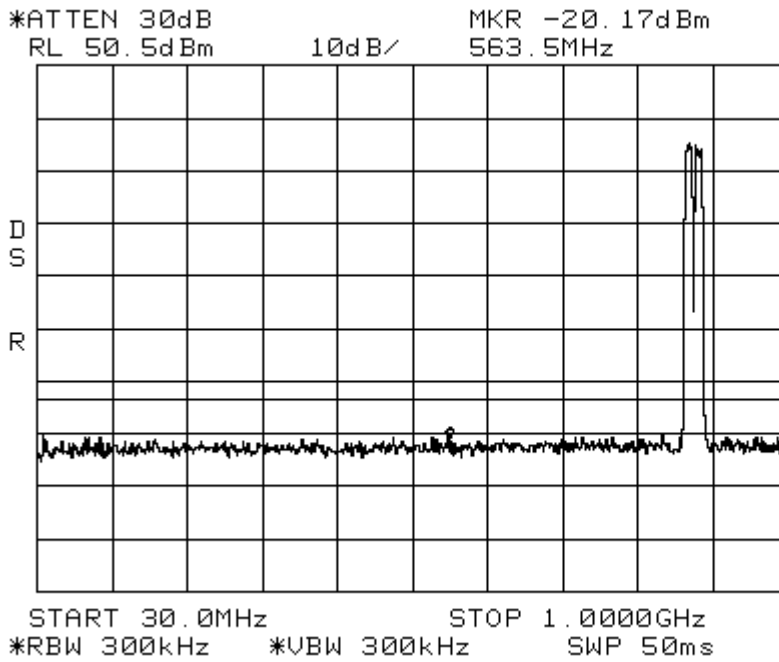

Intermodulation LTE 10 MHz Channel Bandwidth _Low CELLULAR 40W
Span: 1 GHz to 10GHz RBW/VBW: 1 MHz

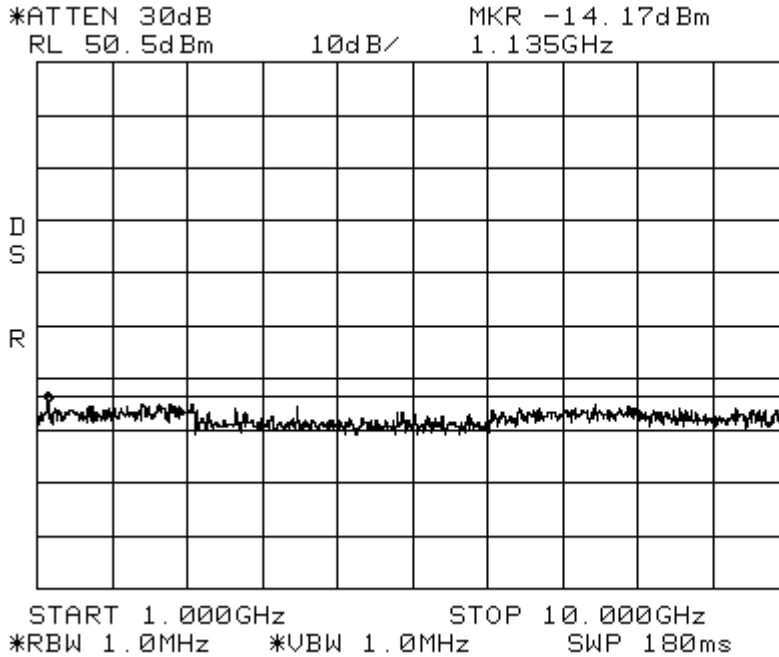

Intermodulation LTE 10 MHz Channel Bandwidth _High CELLULAR 40W
Center: 881.5 MHz Span: 70 MHz RBW/VBW: 100 kHz

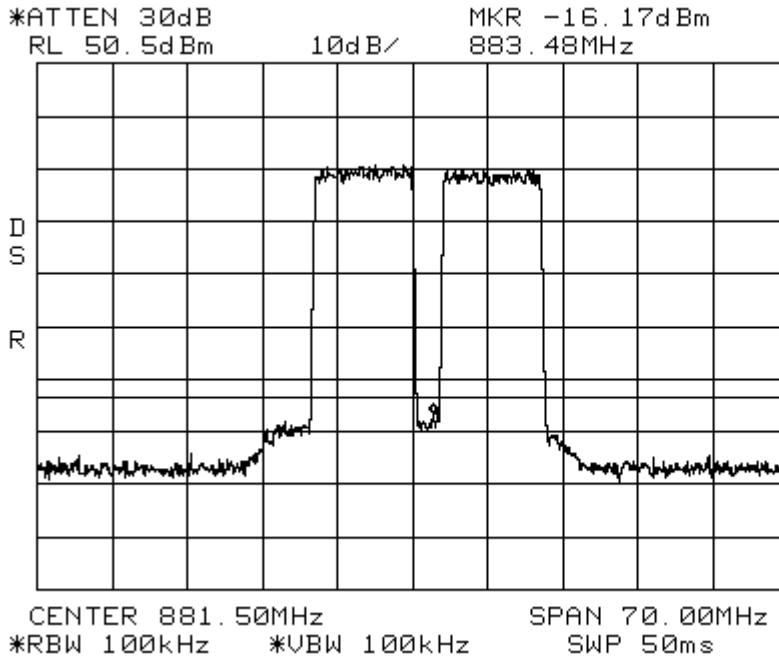

Intermodulation LTE 10 MHz Channel Bandwidth _High CELLULAR 40W
Span: 30 MHz to 1 GHz RBW/VBW: 300 kHz

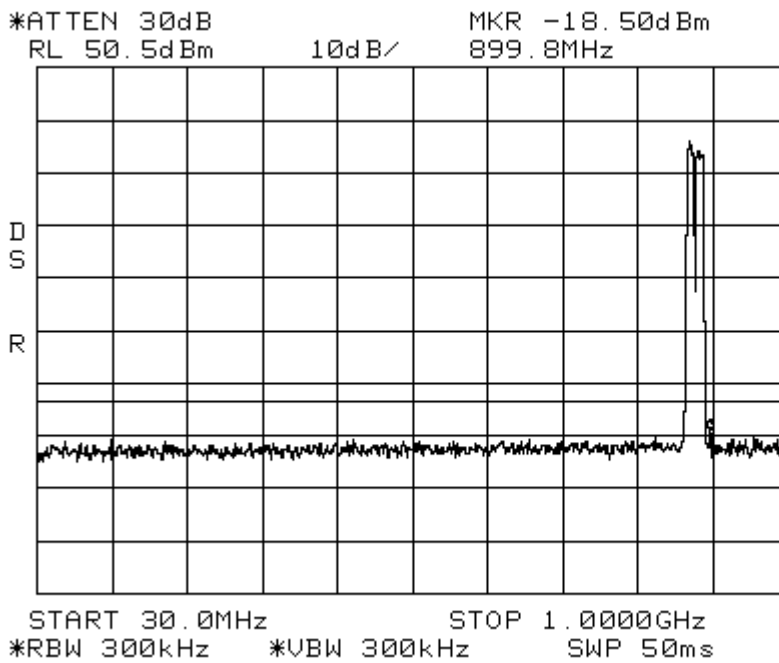

Intermodulation LTE 10 MHz Channel Bandwidth _High CELLULAR 40W
Span: 1 GHz to 10 GHz RBW/VBW: 1 MHz

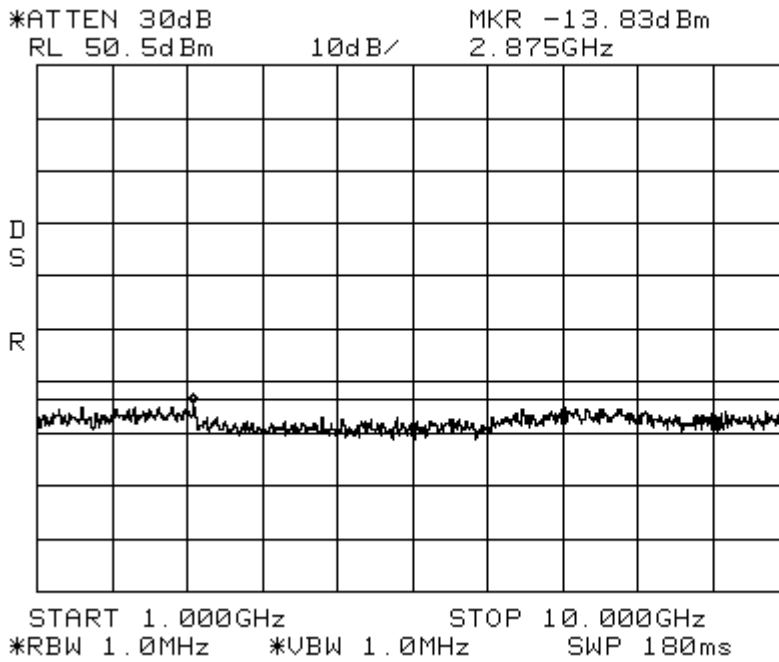

Intermodulation LTE 10 MHz Channel Bandwidth _Apart CELLULAR 40W
Center: 881.5 MHz Span: 175 MHz RBW/VBW: 100 kHz

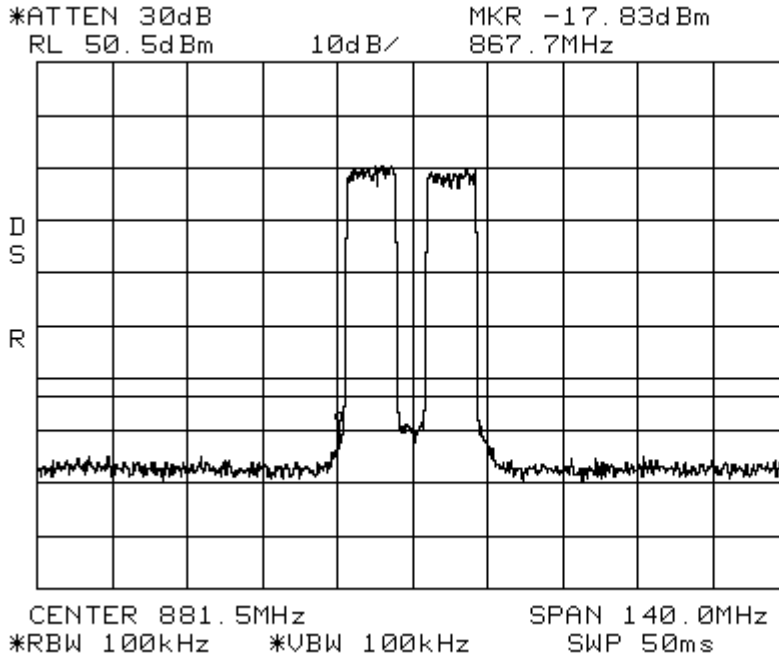

Intermodulation LTE 10 MHz Channel Bandwidth _Apart CELLULAR 40W
Span: 30 MHz to 1 GHz RBW/VBW: 300 kHz

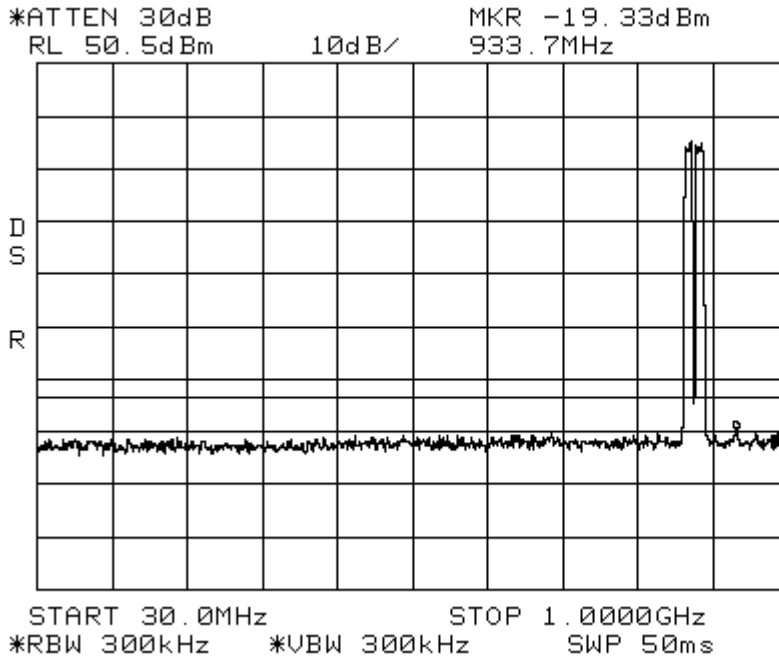

Intermodulation LTE 10 MHz Channel Bandwidth _Apart CELLULAR 40W
Span: 1 GHz to 10 GHz RBW/VBW: 1 MHz

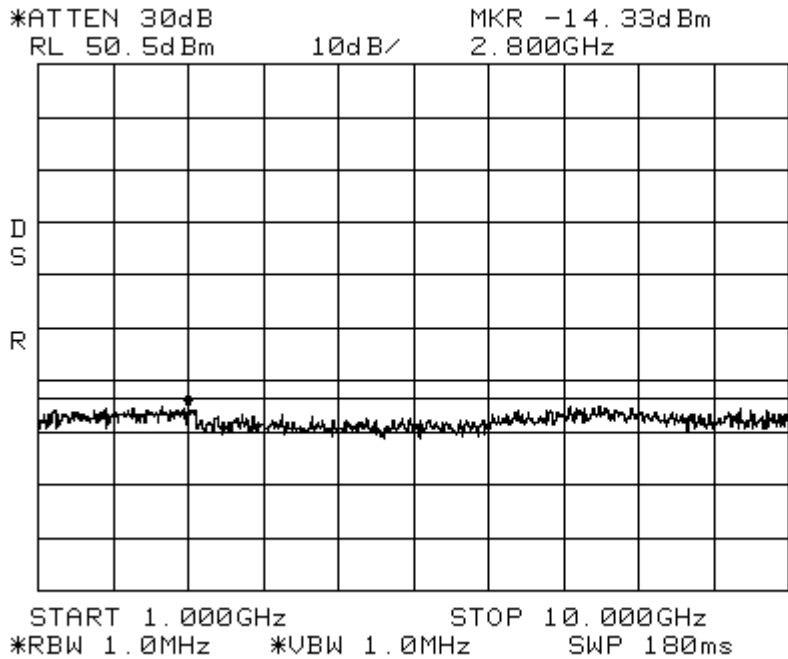

Intermodulation WCDMA_Low CELLULAR 40W
 Center: 881.5 MHz Span: 35 MHz RBW/VBW: 100 kHz
 *ATTEN 30dB MKR -16.17dBm
 RL 50.5dBm 10dB/ 881.44MHz

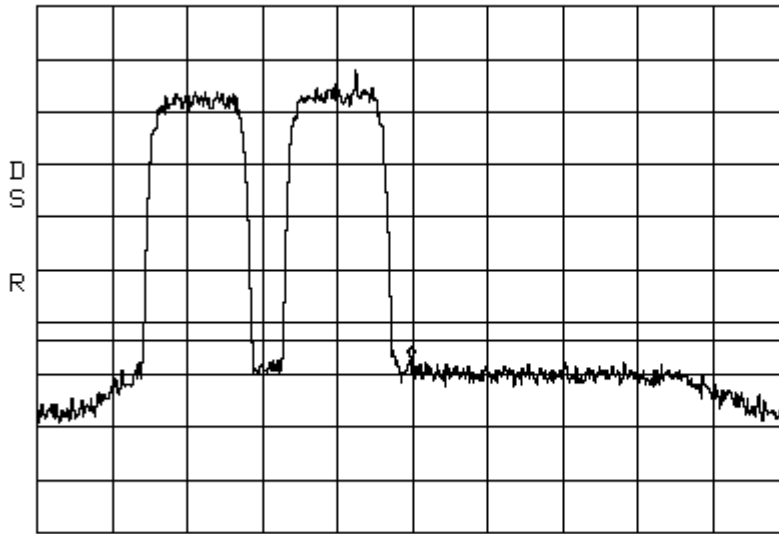

CENTER 881.50MHz SPAN 35.00MHz
 *RBW 100kHz *VBW 100kHz SWP 50ms

Intermodulation WCDMA_Low CELLULAR 40W
 Span: 30 MHz to 1 GHz RBW/VBW: 300 kHz

*ATTEN 30dB MKR -18.67dBm
 RL 50.5dBm 10dB/ 996.8MHz

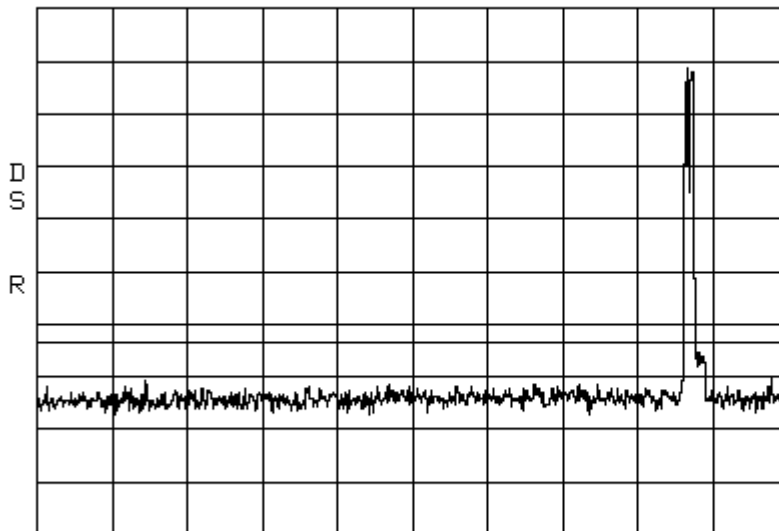

START 30.0MHz STOP 1.0000GHz
 *RBW 300kHz *VBW 300kHz SWP 50ms

Intermodulation WCDMA_Low CELLULAR 40W
Span: 1 GHz to 10 GHz RBW/VBW: 1 MHz

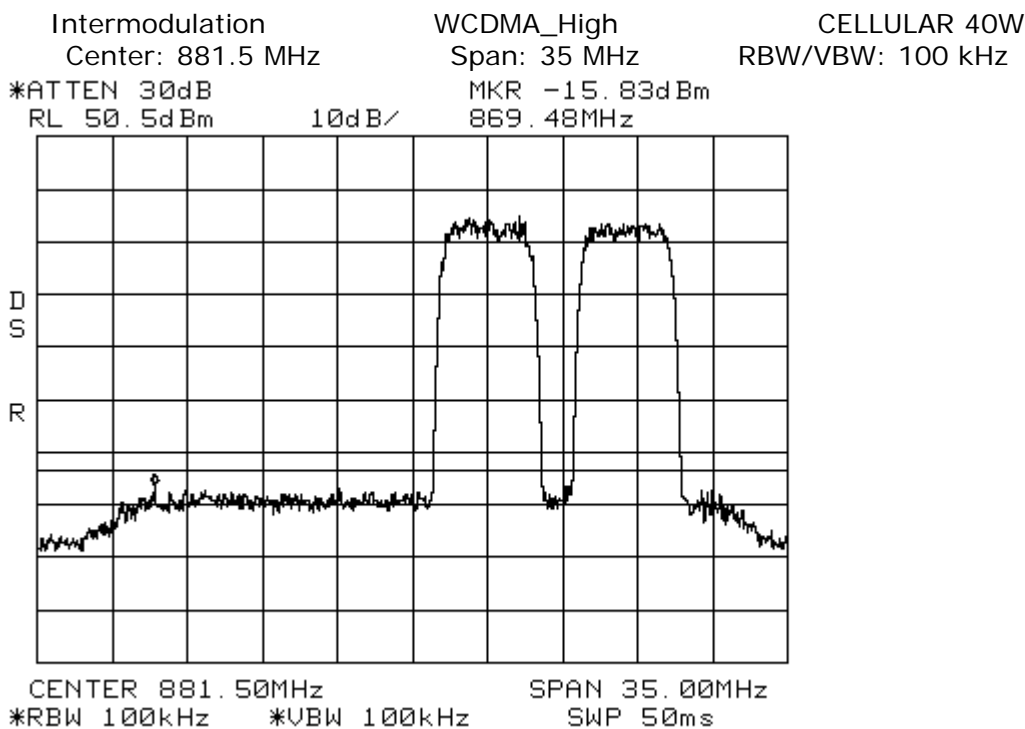
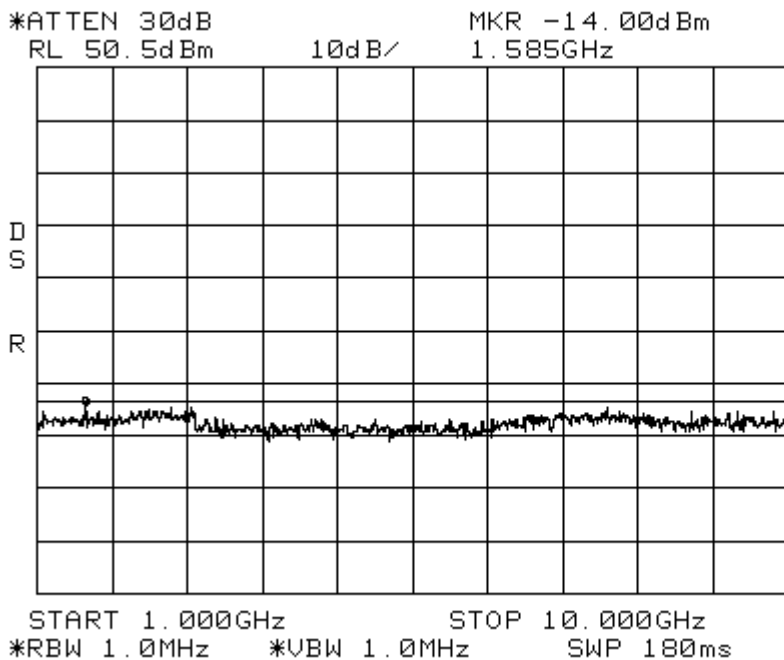

Intermodulation WCDMA_High CELLULAR 40W
Span: 30 MHz to 1 GHz RBW/VBW: 300 kHz

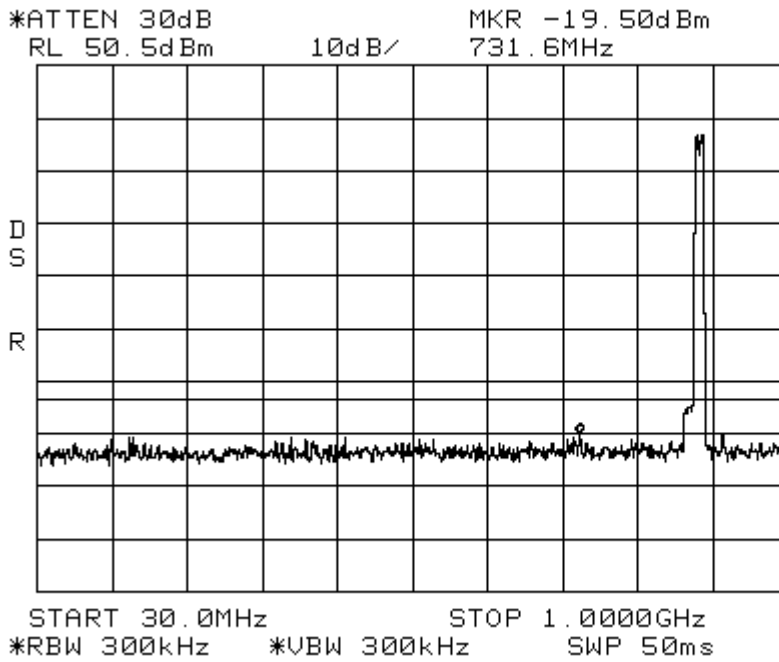

Intermodulation WCDMA_High CELLULAR 40W
Span: 1 GHz to 10 GHz RBW/VBW: 1 MHz

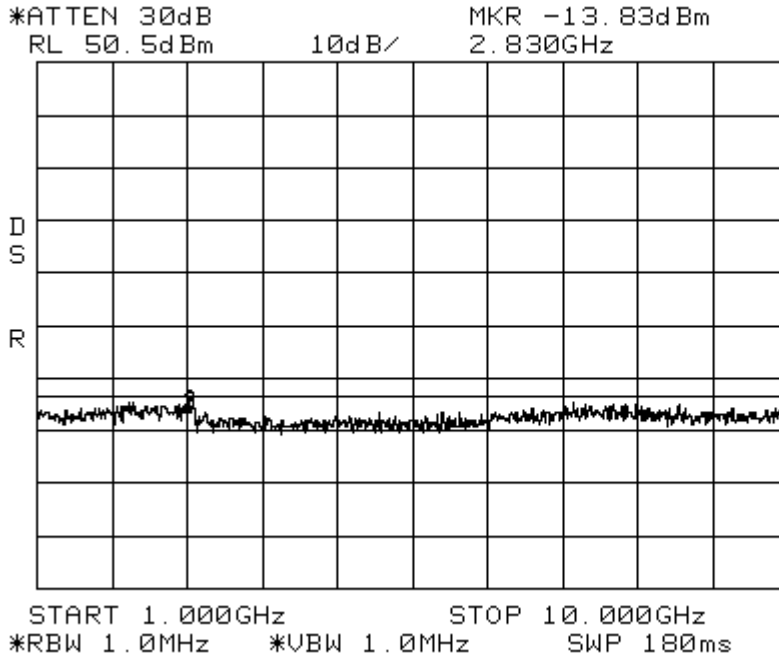

Intermodulation WCDMA_Apart CELLULAR 40W
 Center: 881.5 MHz Span: 75 MHz RBW/VBW: 100 kHz
 *ATTEN 30dB MKR -16.67dBm
 RL 50.5dBm 10dB/ 879.25MHz

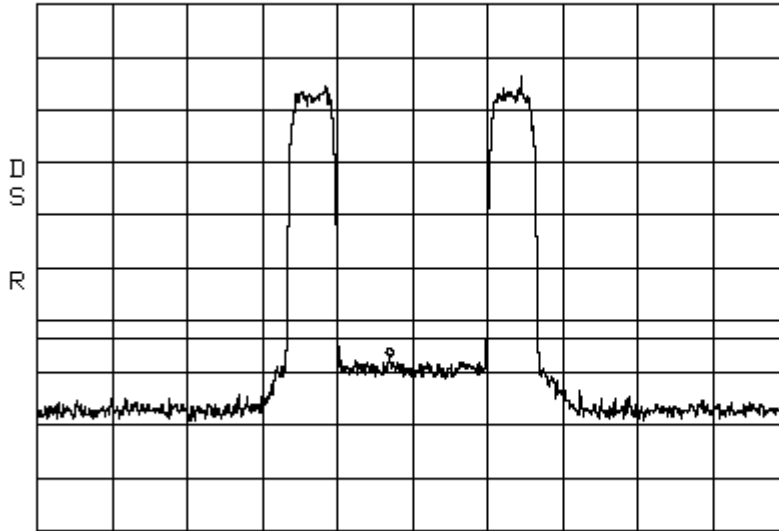

CENTER 881.50MHz SPAN 75.00MHz
 *RBW 100kHz *VBW 100kHz SWP 50ms

Intermodulation WCDMA_Apart CELLULAR 40W
 Span: 30 MHz to 1 GHz RBW/VBW: 300 kHz
 *ATTEN 30dB MKR -20.00dBm
 RL 50.5dBm 10dB/ 840.0MHz

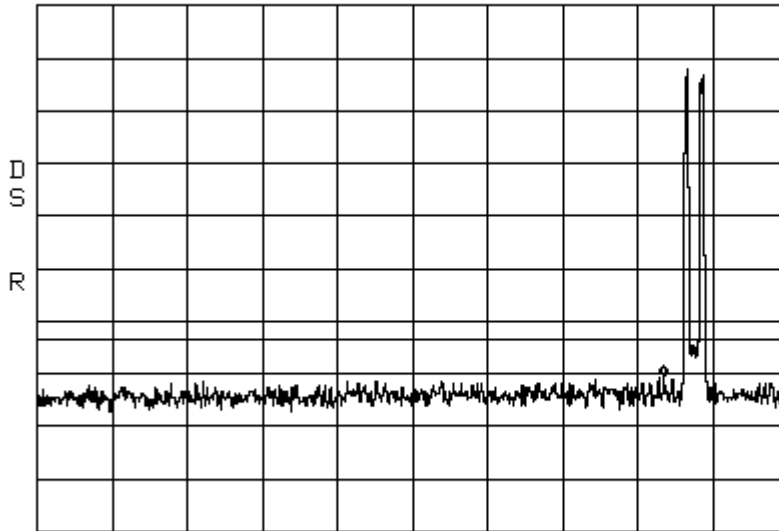

START 30.0MHz STOP 1.0000GHz
 *RBW 300kHz *VBW 300kHz SWP 50ms

Intermodulation

WCDMA_Apart

CELLULAR 40W

Span: 1 GHz to 10 GHz

RBW/VBW: 1 MHz

*ATTEN 30dB

MKR -14.00dBm

RL 50.5dBm

10dB/

7.450GHz

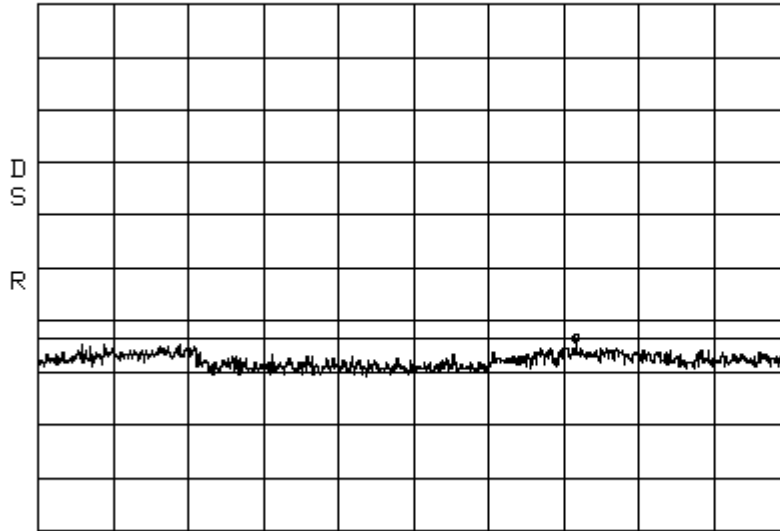

START 1.000GHz

STOP 10.000GHz

*RBW 1.0MHz

*VBW 1.0MHz

SWP 180ms

7.5 Occupied Bandwidth Modulation Test

[Table of Contents: Section 1.0](#)

[Back to Emission Limits: Section 5.1.3](#)

An output Occupied Bandwidth test was done with modulation types: GSM, EDGE, CDMA, W-CDMA, LTE 1.4MHz BW, LTE 3MHz BW, LTE 5 MHz BW, LTE 10MHz BW, LTE 15MHz BW, and LTE 20MHz BW. The purpose was to determine the amount of occupied bandwidth for the different types of modulation schemes produced by the EUT. The following plots show output signals.

The resolution bandwidth is reduced to 1% of the estimated emission bandwidth and the video bandwidth is set to 3 times the resolution bandwidth. The markers are moved to the -20 dB points (from the previously established center frequency level) on either side of center frequency.

Results:

Pass (see plots)

Occupied Bandwidth EDGE_Signal_In CELLULAR 40W
Span: 350 kHz RBW: 3 kHz VBW: 10 kHz

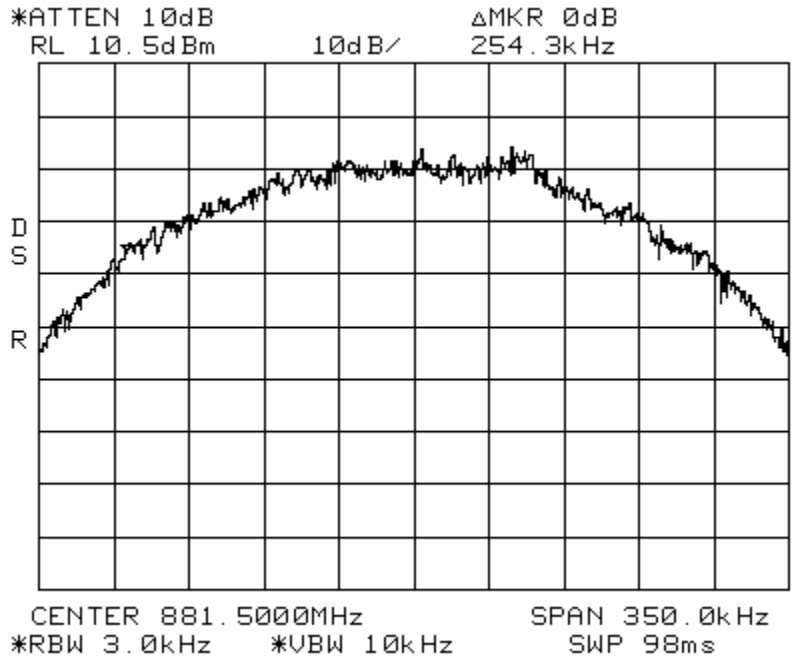

Occupied Bandwidth EDGE_Signal_Out CELLULAR 40W
Span: 350 kHz RBW: 3 kHz VBW: 10 kHz

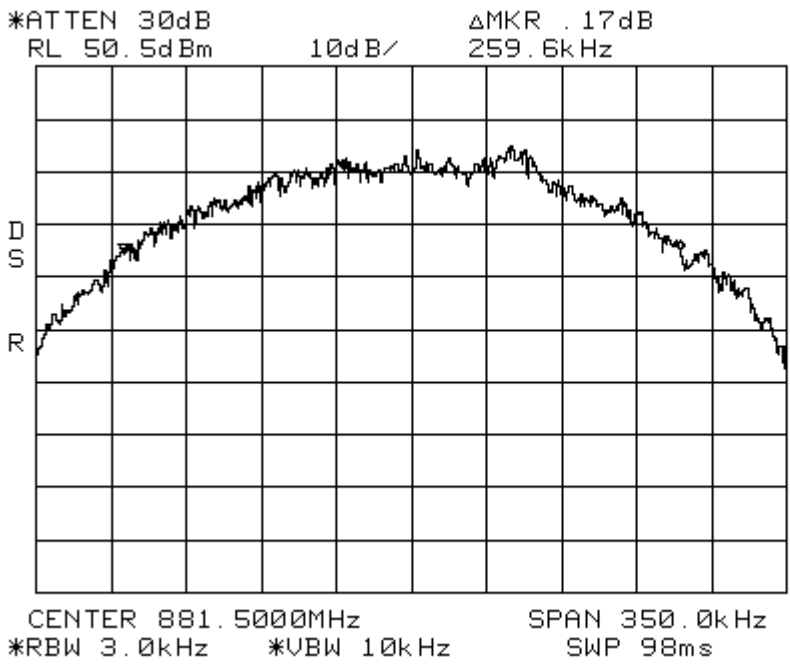

Occupied Bandwidth
Span: 350 kHz

GSM_Signal_In
RBW: 3 kHz VBW: 10 kHz

CELLULAR 40W

*ATTEN 10dB
RL 10.5dBm 10dB/ Δ MKR 0dB
266.6kHz

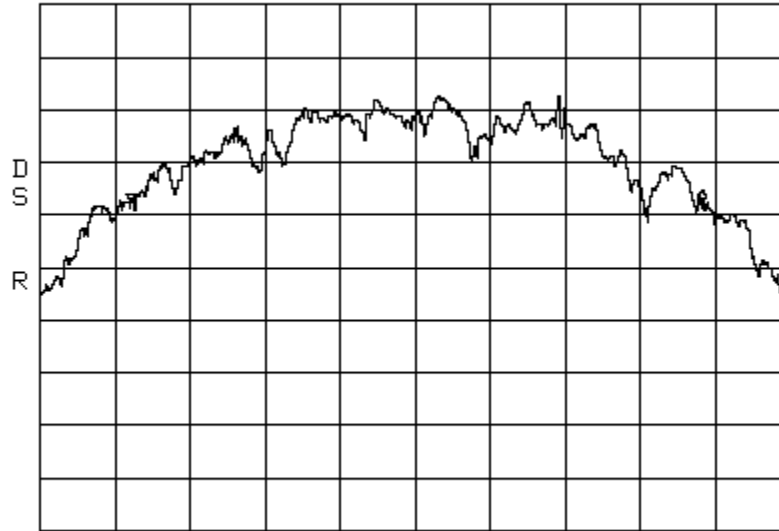

CENTER 881.5000MHz SPAN 350.0kHz
*RBW 3.0kHz *VBW 10kHz SWP 98ms

Occupied Bandwidth
Span: 350 kHz

GSM_Signal_Out
RBW: 3 kHz VBW: 10 kHz

CELLULAR 40W

*ATTEN 30dB
RL 50.5dBm 10dB/ Δ MKR .50dB
266.0kHz

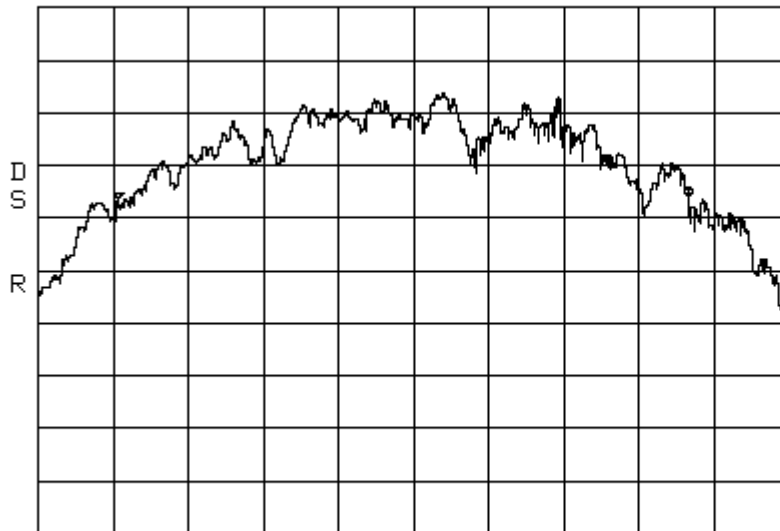

CENTER 881.5000MHz SPAN 350.0kHz
*RBW 3.0kHz *VBW 10kHz SWP 98ms

Occupied Bandwidth

LTE 10 MHz Channel Bandwidth_Signal_In
Span: 10 MHz RBW: 30 kHz VBW: 100 kHz

CELLULAR 40W

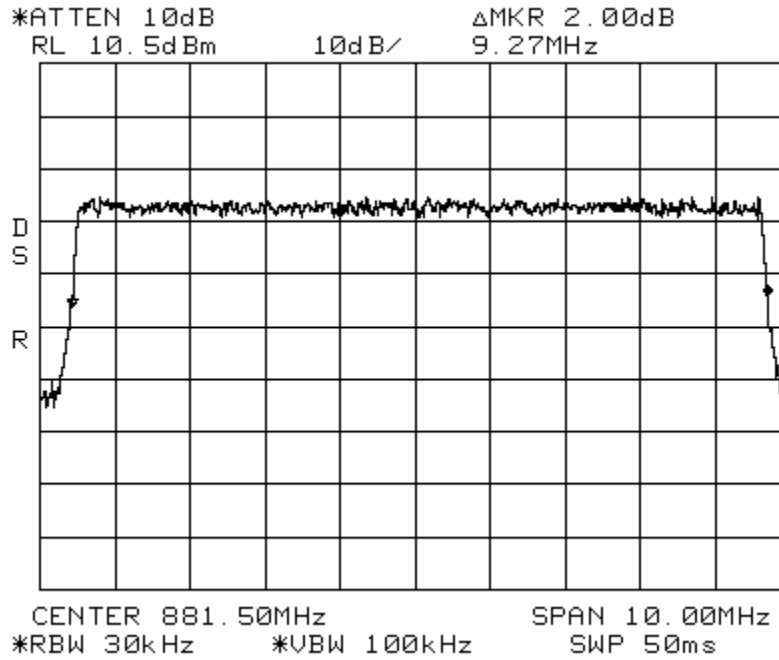

Occupied Bandwidth

LTE 10 MHz Channel Bandwidth_Signal_Out
Span: 10 MHz RBW: 30 kHz VBW: 100 kHz

CELLULAR 40W

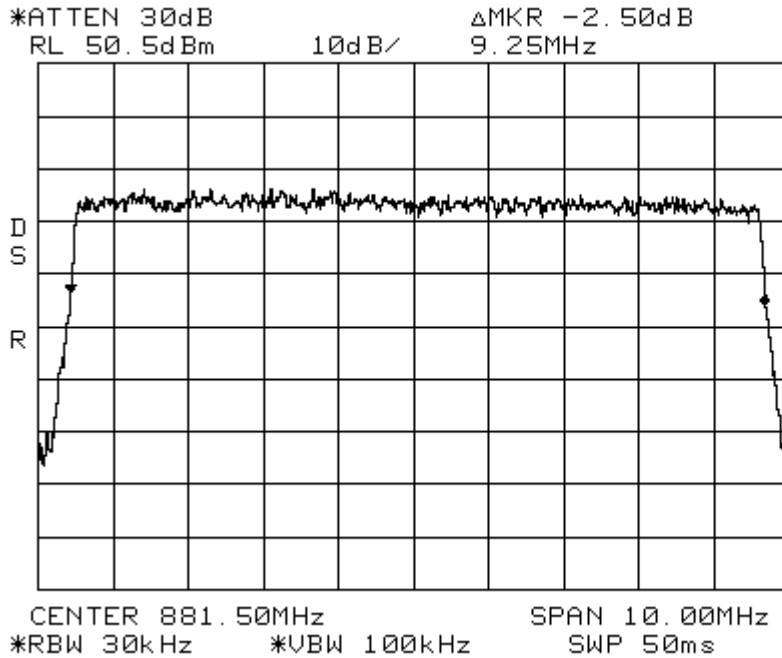

Occupied Bandwidth

LTE 15 MHz Channel Bandwidth_Signal_In
Span: 15 MHz RBW: 30 kHz VBW: 100 kHz

CELLULAR 40W

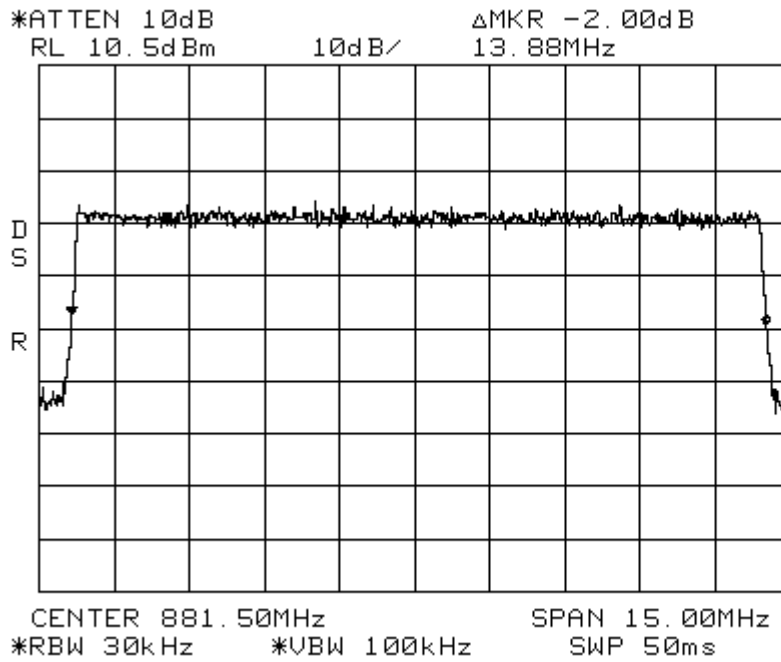

Occupied Bandwidth

LTE 15 MHz Channel Bandwidth_Signal_Out
Span: 15 MHz RBW: 30 kHz VBW: 100 kHz

CELLULAR 40W

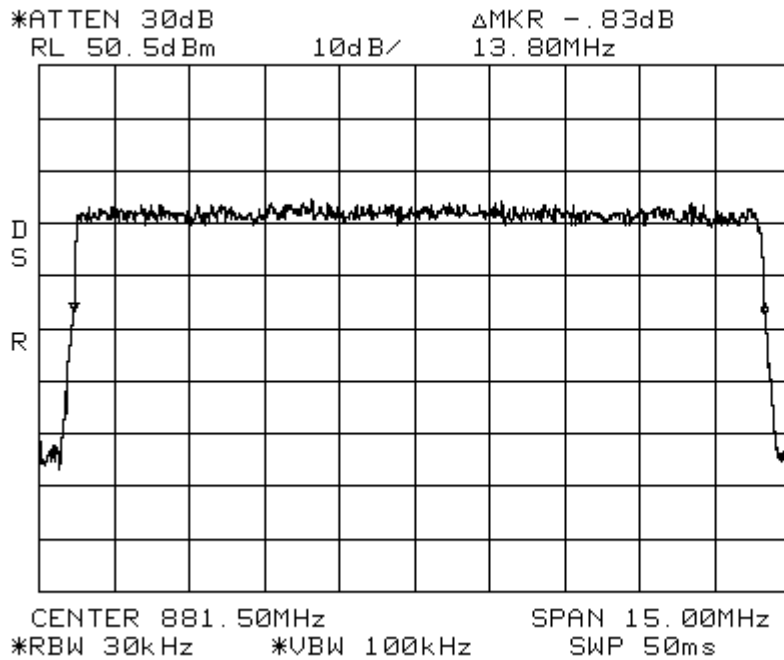

8.0

APPENDIX B

Measurement Protocol

[Table of Contents: Section 1.0](#)

[Back to Emission Limits: Section 5.1.3](#)

Measurement Protocol

Environmental conditions of the lab, (ADC)

Temperature: 24° C

Relative Humidity: 35 %

Atmospheric Pressure: 100.2 kPa

Test Methodology:

Emission testing is performed according to the procedures in ANSI C63.4-2003.

Measurement Uncertainty

The test system for conducted emissions is defined as the signal generator(s), the power meter, the spectrum analyzer and the coaxial cable. The equipment comprising the test systems is calibrated prior to testing the EUT.

Justification

The Equipment Under Test (EUT) is configured in a typical user arrangement in accordance with the manufacturer's instructions. A cable is connected to each available port and either terminated with a peripheral into its characteristic impedance or left un-terminated. When appropriate, the cables are manually manipulated with respect to each other to obtain maximum emissions from the unit.

Radiated Emissions

The final level, in dBuV/m, equals the reading from the spectrum analyzer (Level dBuV), adding the antenna correction factor and cable loss factor (Factor dB) to it, and subtracting the preamp gain (and duty cycle correction factor, if applicable). This result then has the limit subtracted from it to provide the Delta, which gives the tabular data as shown in the data sheets in Appendix B.

Example:

FREQ (MHz)	LEVEL (dBuV)	CABLE/ANT/PREAMP (dB) (dB/m) (dB)	FINAL (dBuV/m)	POL/HGT/AZ (m) (deg)	DELTA1
60.80	42.5Qp +	1.2 + 10.9 - 25.5 =	29.1	V 1.0 0.0	-10.9

Substitution Method

A cabinet (or enclosure) radiated emission scan was also made, at Intertek, with the EUT's antenna replaced with a termination to demonstrate case radiation compliance to the -13 dBm requirement. Radiated emissions from the EUT are measured in the frequency range of 30 to 20,000 MHz using a spectrum analyzer and appropriate broadband linearly polarized antennas. Table top equipment is placed on a 1.0 X 1.5 meter non-conducting table 80 centimeters above the ground plane. Floor standing equipment is placed directly on the turntable/ground plane. Interface cables that are closer than 40 centimeters to the ground plane are bundled in the center in a serpentine fashion so they are at least 40 centimeters from the ground plane. Cables to simulators/testers (if used in this test) are routed through the center of the table and to a screen room located outside the test area. The antenna is positioned 3 meters horizontally from the EUT. To locate maximum emissions from the test sample the antenna is varied in height from 1 to 4 meters, measurement scans are made with both horizontal and vertical antenna polarizations and the EUT are rotated 360 degrees. The field strength levels were measured per ANSI C63.4. The EUT is then replaced with a tuned dipole antenna (below 1GHz) or horn antenna (above 1 GHz). The substitute antenna was placed in the same polarization as the test antenna. A signal generator was used to generate a signal level that matched the highest level measured from the EUT. The signal generator level minus the cable loss from the signal generator to the substitute antenna plus the substitute antenna gain equals the spurious power level.

Test Equipment

All measurement instrumentation is traceable to the National Institute of Standards and Technology and is calibrated according to internal procedure.

Radiated Emissions Test Data

[Table of Contents: Section 1.0](#)

Document Name: *100124687MIN-001.pdf*

Test Engineer: Uri Spector

Date: 8 June, 2010

Test Procedure:

Test measurements were made in accordance with ANSI C63.4-2003, Standard Methods of Measurement of Radio Noise Emissions from Low-Voltage Electrical and Electronics Equipment in the Range of 9 kHz to 40 GHz.

Test Site Location:

The test site is a 3 meter Semi-Anechoic Chamber, constructed by Panashield™ Inc. and located inside the building at 7250 Hudson Blvd. Suite 100, Oakdale, MN 55128.

Test Site Description:

The 3 meter Semi-Anechoic Chamber is constructed of Panabolt™ modular RF shielding and self-supported with structural steel designed for the local seismic zone rating. The chamber has the nominal size of 20' wide x 29' long x 18' high. All walls and ceiling of the chamber are treated with FFG-1000 Ferrite Grid absorber which was developed specifically to meet international requirements for EMC anechoic chambers for emissions and immunity measurements. To meet high frequency testing white HY-35 hybrid absorber is mounted on the ferrites in specular regions of the chamber.

The chamber has a 2 meter diameter ANSI test volume area and meets the requirements of ANSI C63.4 (1992), EN55022, and FCC Part 15 standards for testing at a 3 meter path length.

FCC Registration Number: 0007355381

IC Registration Number: 4359A