

440BX CUSTOMER REFERENCE DESIGN

TITLE PAGE

TITLE	PAGE	COMPONENT	PLACEMENT	PAGE
COVER SHEET	1	CPU SLOT1	JP8	2, 3
KLAMATH	2 - 3	Clock Generator	U8, U12	4
CLK SYNTHESIZER	4	74HC74	U9	19
PAC(82443BX)	5, 6	82443BX	U7	5, 6
DIMM1, 2	9, 10	PI5C16212A	U1, U2, U5 U7, U8, U12	7, 8
DIMM3, 4	11, 12			
KEYB / MOUSE	23	PIIX4	U16	13, 14
PIIX4	13, 14	74ALS14	U21	19
AGP CONN.	15	74LVC14	U21	19
PCI CONN.	16, 17	7407	U10	15, 19
ISA CONN.	18	74HC10	U18	19
PANEL	19	29EE00	U25	20
IDE CONN.	20	SC1182CS	U2	22
USB / FLASH BIOS	21	74LV244	U13	23
KEYBOARD/MOUSE	23	SMC672	U17	28
DC TO DC CONVERTER	22	74ALS32	U18, U24	20, 28
CPU FREQUENCY RATE	23	75C185	U14, U15	29
CHIP GTL TERM.	24	LM75	U4	30
PCI/AGP PULLUPS	25	LM78	U11	30
ISA/PAC DECOUP	26			
VREF PAGE	27			
SMC I/O CHIP	28			
SERIAL/FLOPPY	29			
TEMPERATURE SENSOR	30			

LINK
 129.5SCH
 130.5SCH
 131.5SCH
 132.5SCH
 133.5SCH
 134.5SCH
 135.5SCH
 136.5SCH
 137.5SCH
 138.5SCH
 139.5SCH
 140.5SCH
 141.5SCH
 142.5SCH
 143.5SCH
 144.5SCH
 145.5SCH
 146.5SCH
 147.5SCH
 148.5SCH
 149.5SCH
 150.5SCH
 151.5SCH
 152.5SCH
 153.5SCH
 154.5SCH
 155.5SCH
 156.5SCH
 157.5SCH
 158.5SCH
 159.5SCH
 160.5SCH
 161.5SCH
 162.5SCH
 163.5SCH
 164.5SCH
 165.5SCH
 166.5SCH
 167.5SCH
 168.5SCH
 169.5SCH
 170.5SCH
 171.5SCH
 172.5SCH
 173.5SCH
 174.5SCH
 175.5SCH
 176.5SCH
 177.5SCH
 178.5SCH
 179.5SCH
 180.5SCH
 181.5SCH
 182.5SCH
 183.5SCH
 184.5SCH
 185.5SCH
 186.5SCH
 187.5SCH
 188.5SCH
 189.5SCH
 190.5SCH
 191.5SCH
 192.5SCH
 193.5SCH
 194.5SCH
 195.5SCH
 196.5SCH
 197.5SCH
 198.5SCH
 199.5SCH
 200.5SCH

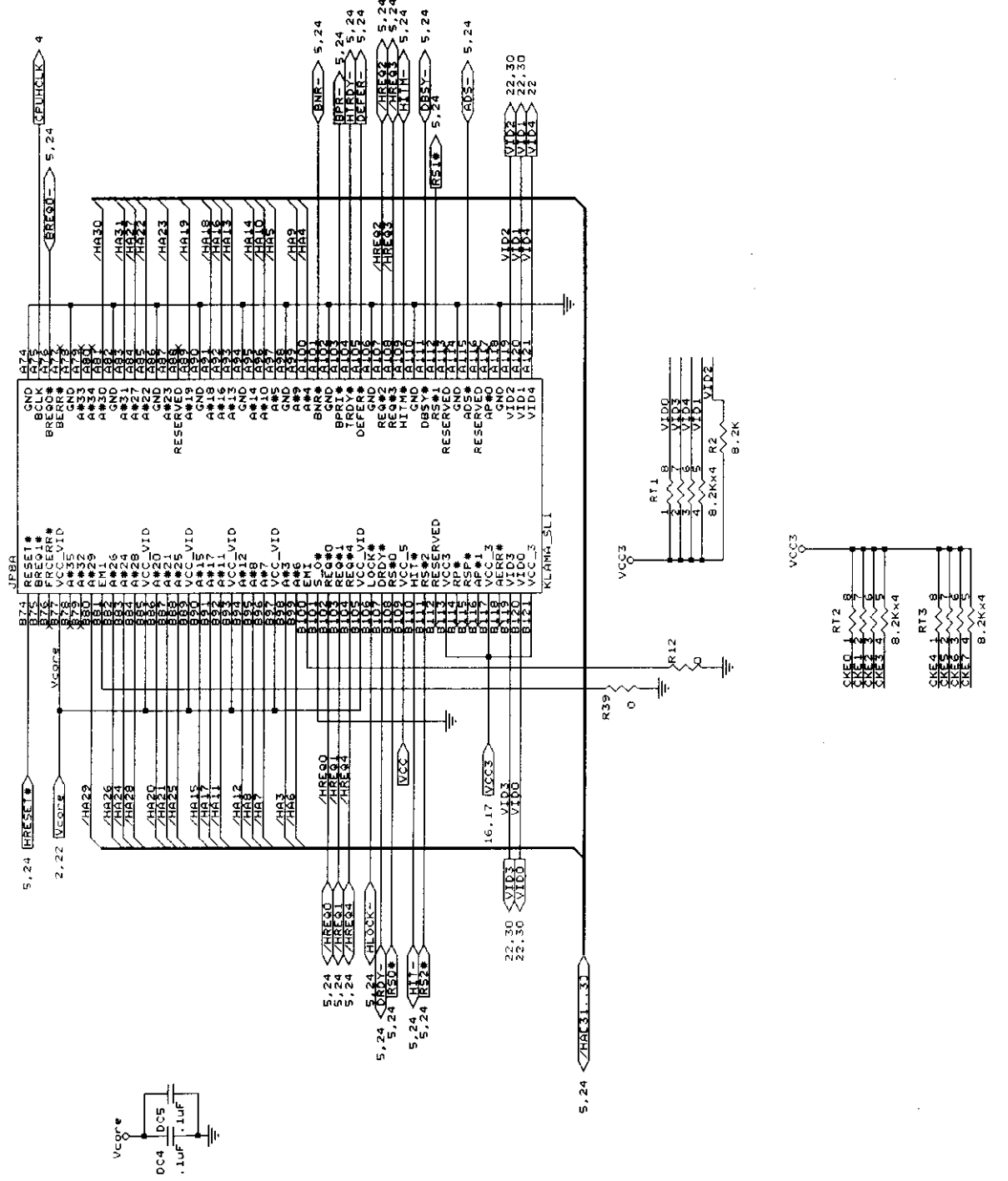

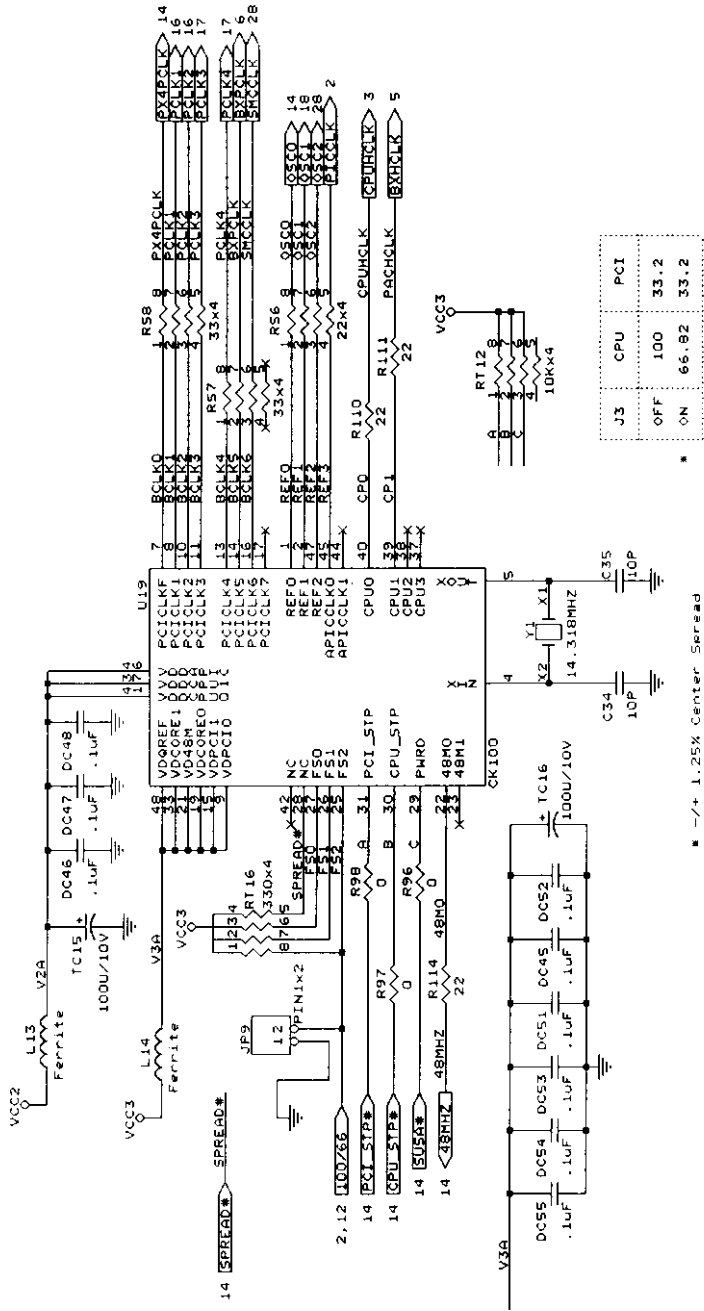

J3	CPU	PCI
OFF	100	33.2
ON	66.92	33.2

* -/+ 1.25% Center Spread

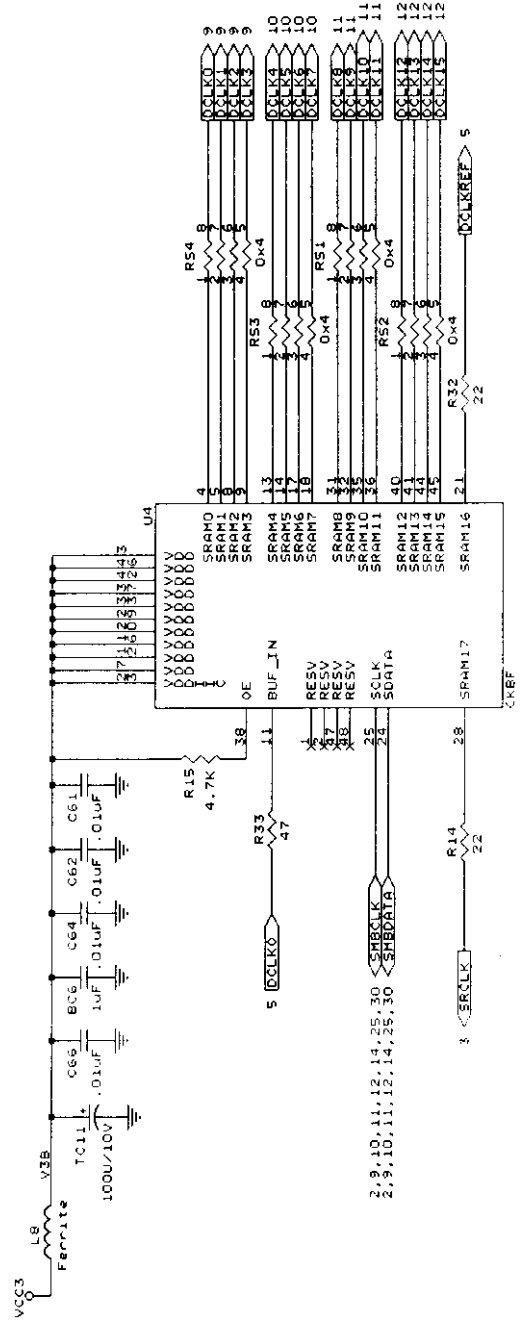

82443BX

492 BGA

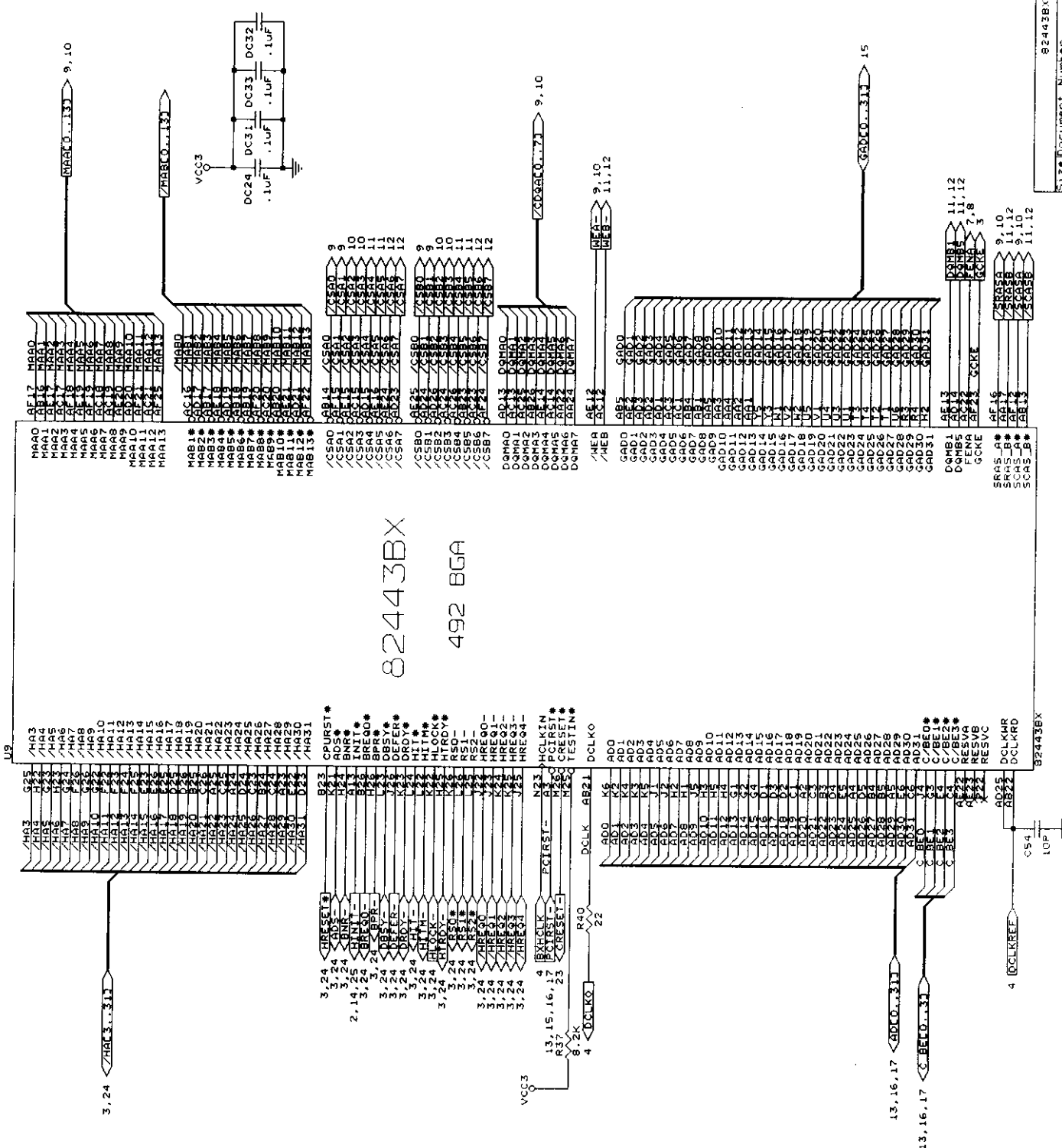

HA0 HA1 HA2 HA3 HA4 HA5 HA6 HA7 HA8 HA9 HA10 HA11 HA12 HA13 HA14 HA15 HA16 HA17 HA18 HA19 HA20 HA21 HA22 HA23 HA24 HA25 HA26 HA27 HA28 HA29 HA30 HA31
 DA0 DA1 DA2 DA3 DA4 DA5 DA6 DA7 DA8 DA9 DA10 DA11 DA12 DA13 DA14 DA15 DA16 DA17 DA18 DA19 DA20 DA21 DA22 DA23 DA24 DA25 DA26 DA27 DA28 DA29 DA30 DA31
 RES# INIT# DBS# DEF# DRDY# HLD# HLOCK# HTRDY# RD# WR# FCS# FCS2# FCS3# HREQ# HRES#
 CLK#
 VCC3 VCC4
 GAD0 GAD1 GAD2 GAD3 GAD4 GAD5 GAD6 GAD7 GAD8 GAD9 GAD10 GAD11 GAD12 GAD13 GAD14 GAD15 GAD16 GAD17 GAD18 GAD19 GAD20 GAD21 GAD22 GAD23 GAD24 GAD25 GAD26 GAD27 GAD28 GAD29 GAD30 GAD31
 GDB0 GDB1 GDB2 GDB3 GDB4 GDB5 GDB6 GDB7 GDB8 GDB9 GDB10 GDB11 GDB12 GDB13 GDB14 GDB15 GDB16 GDB17 GDB18 GDB19 GDB20 GDB21 GDB22 GDB23 GDB24 GDB25 GDB26 GDB27 GDB28 GDB29 GDB30 GDB31
 GDBI# GDBE# GDBF# GDBG# GDBH# GDBI# GDBJ# GDBK# GDBL# GDBM# GDBN# GDBO# GDBP# GDBQ# GDBR# GDBS# GDBT# GDBU# GDBV# GDBW# GDBX# GDBY# GDBZ#
 VCC3 VCC4
 GND

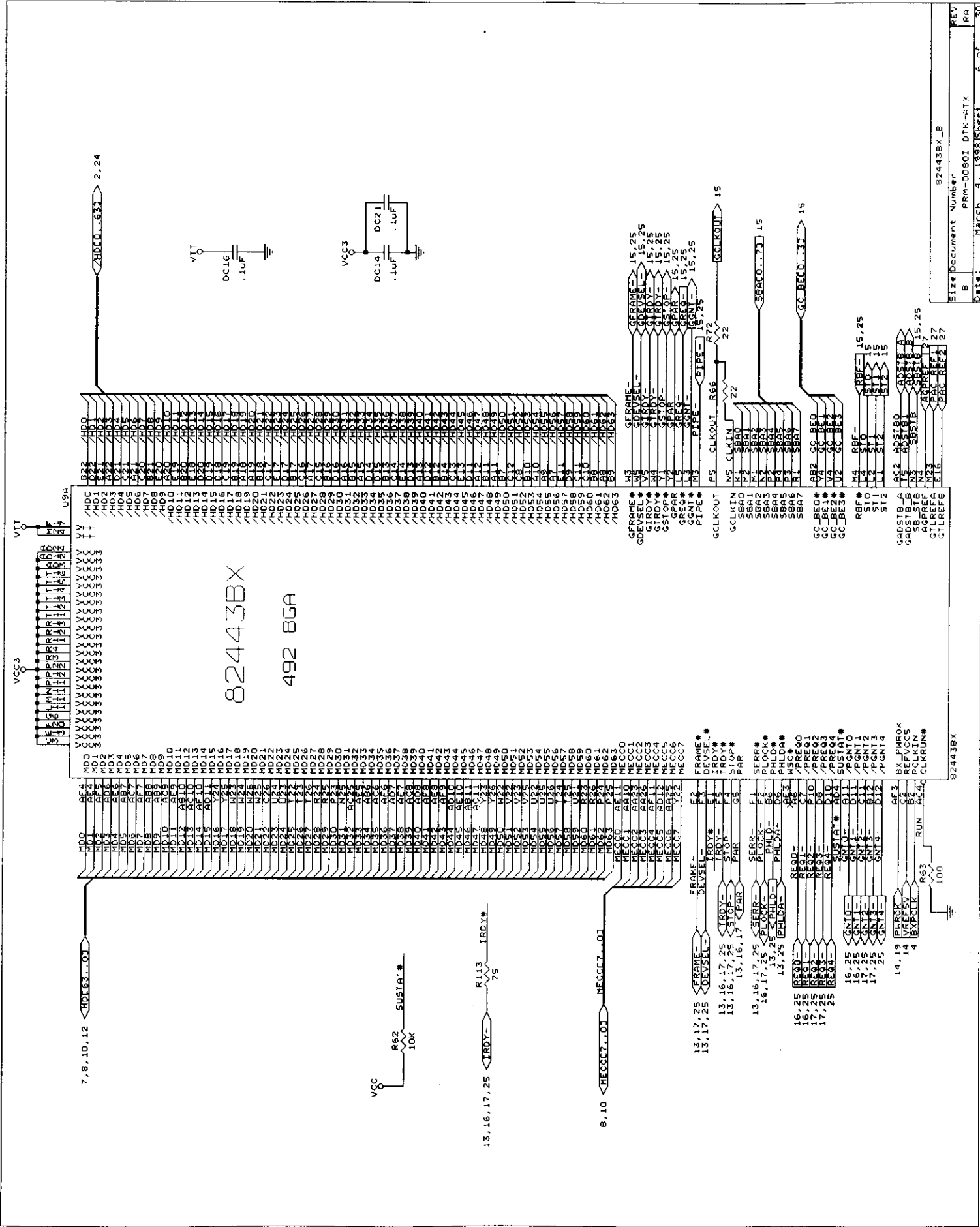

82443BX
492 BGA

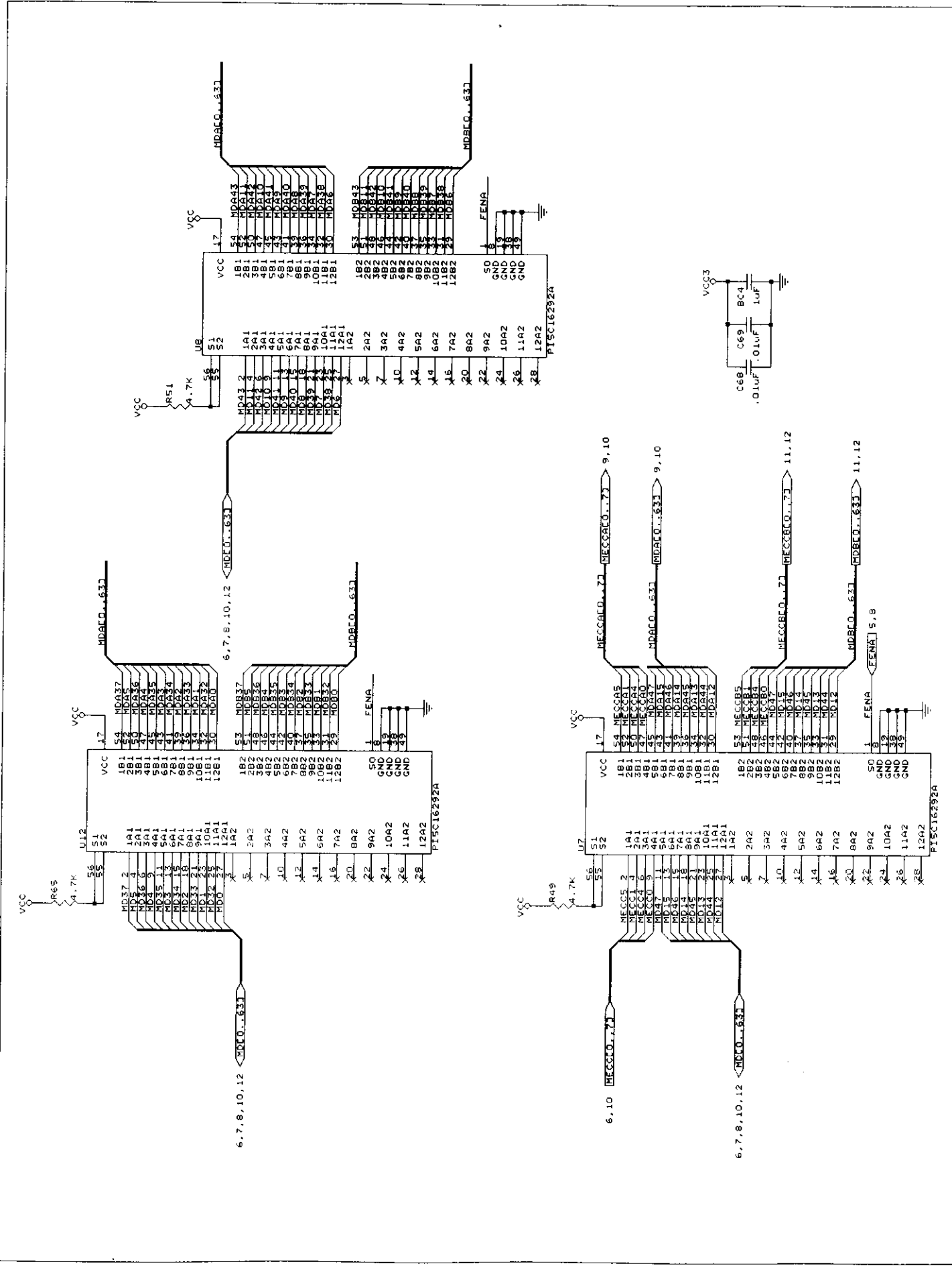

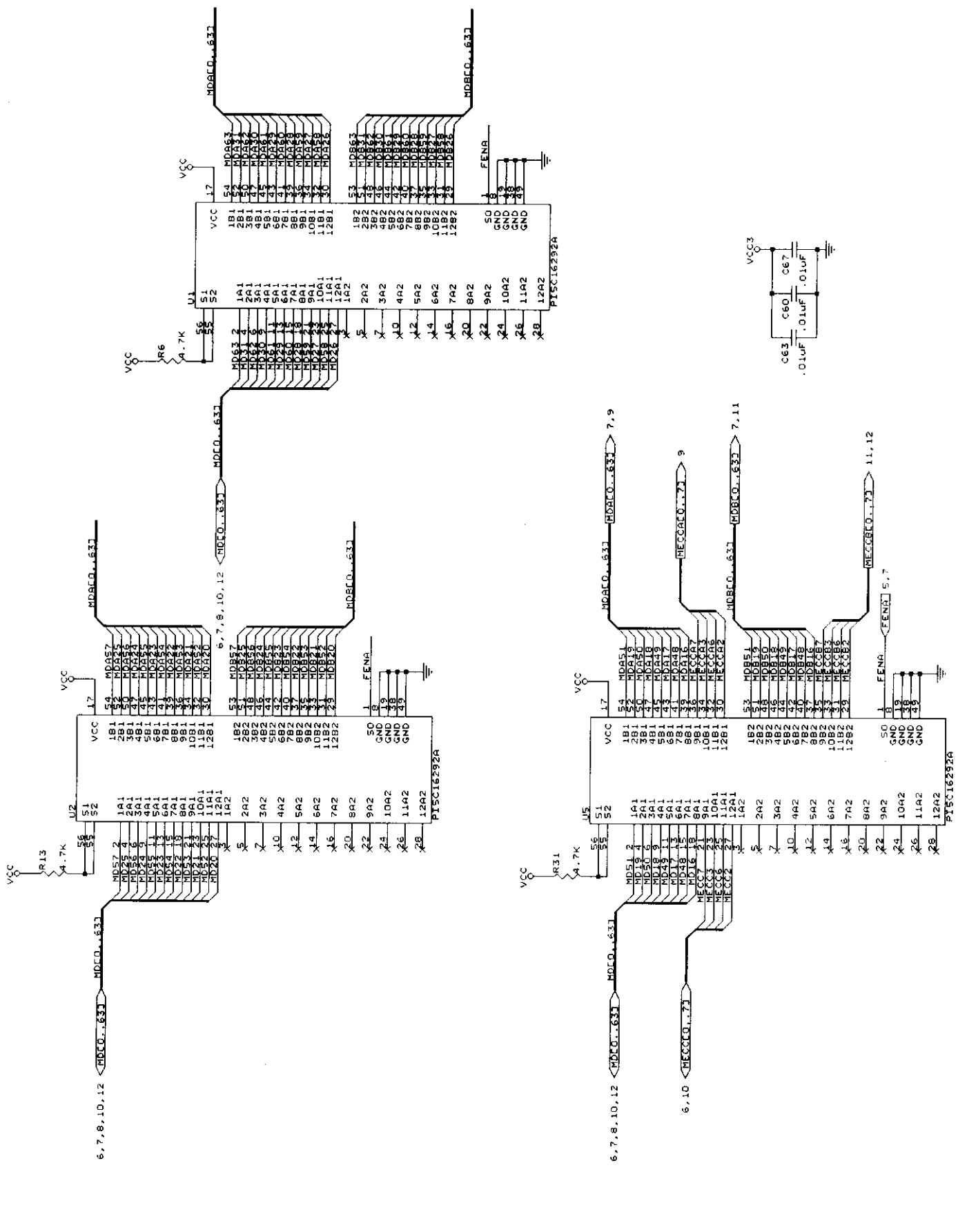

DIMM CONNECTOR Ø

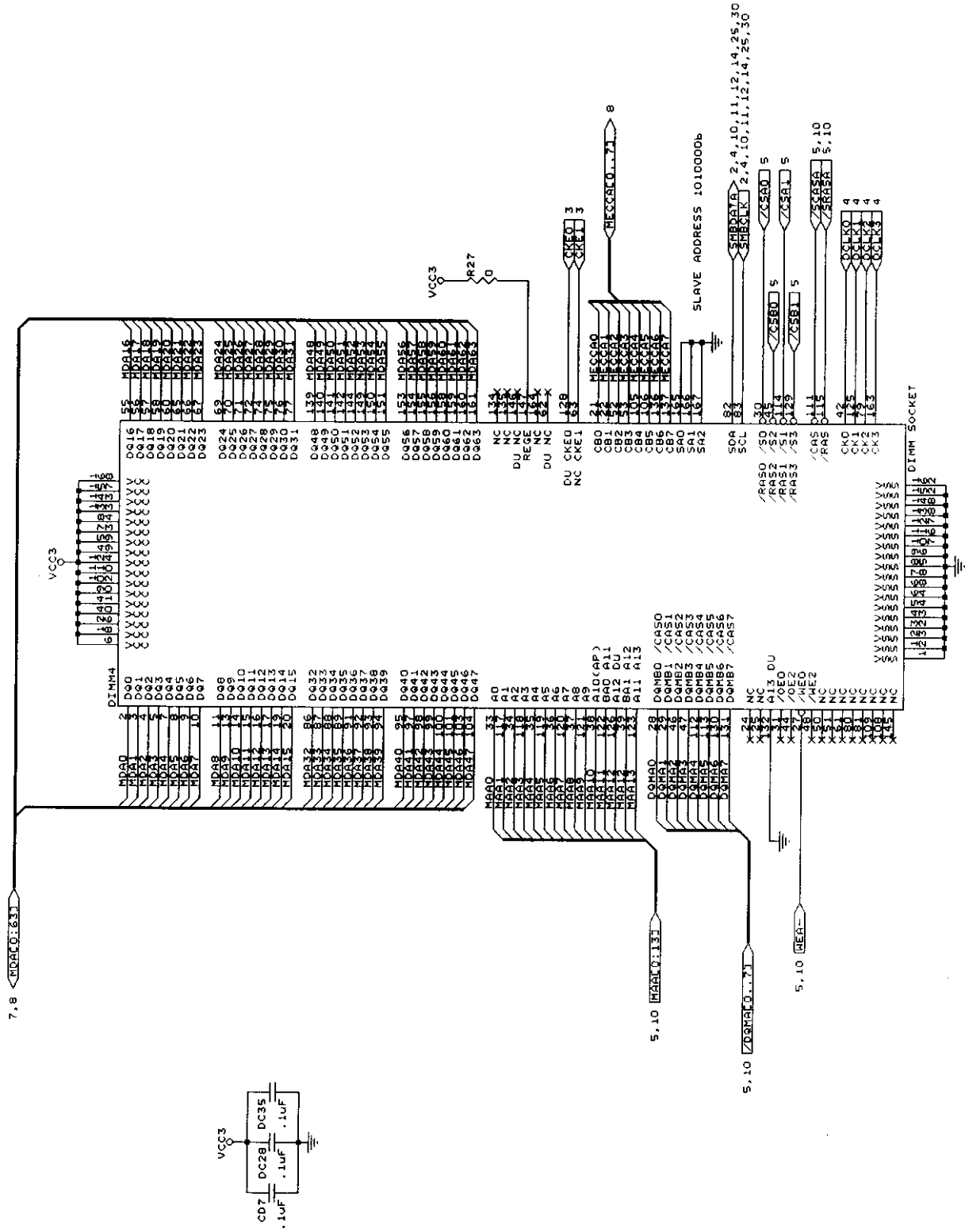

DIMM CONNECTOR 1

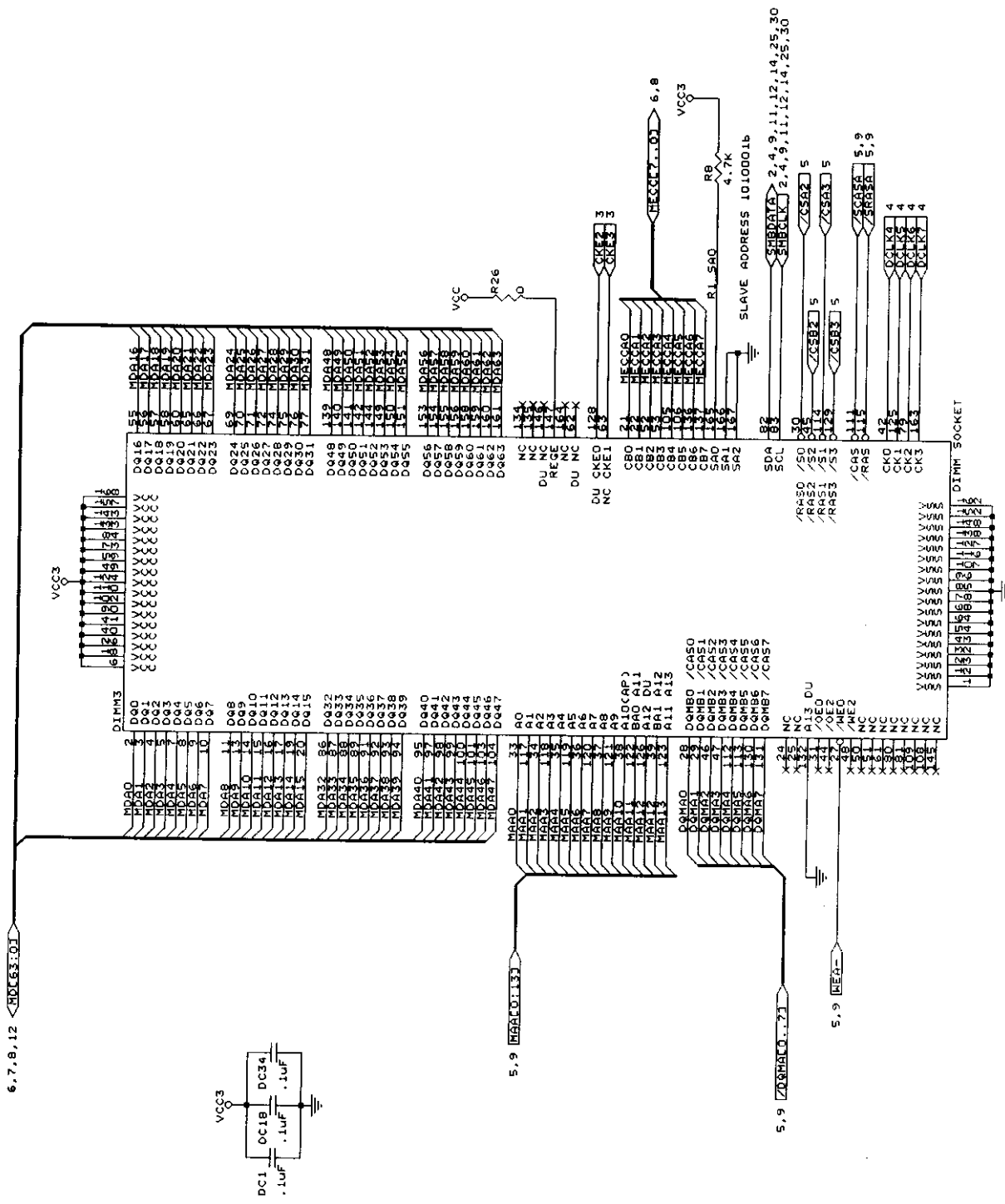

DIMM CONNECTOR 2

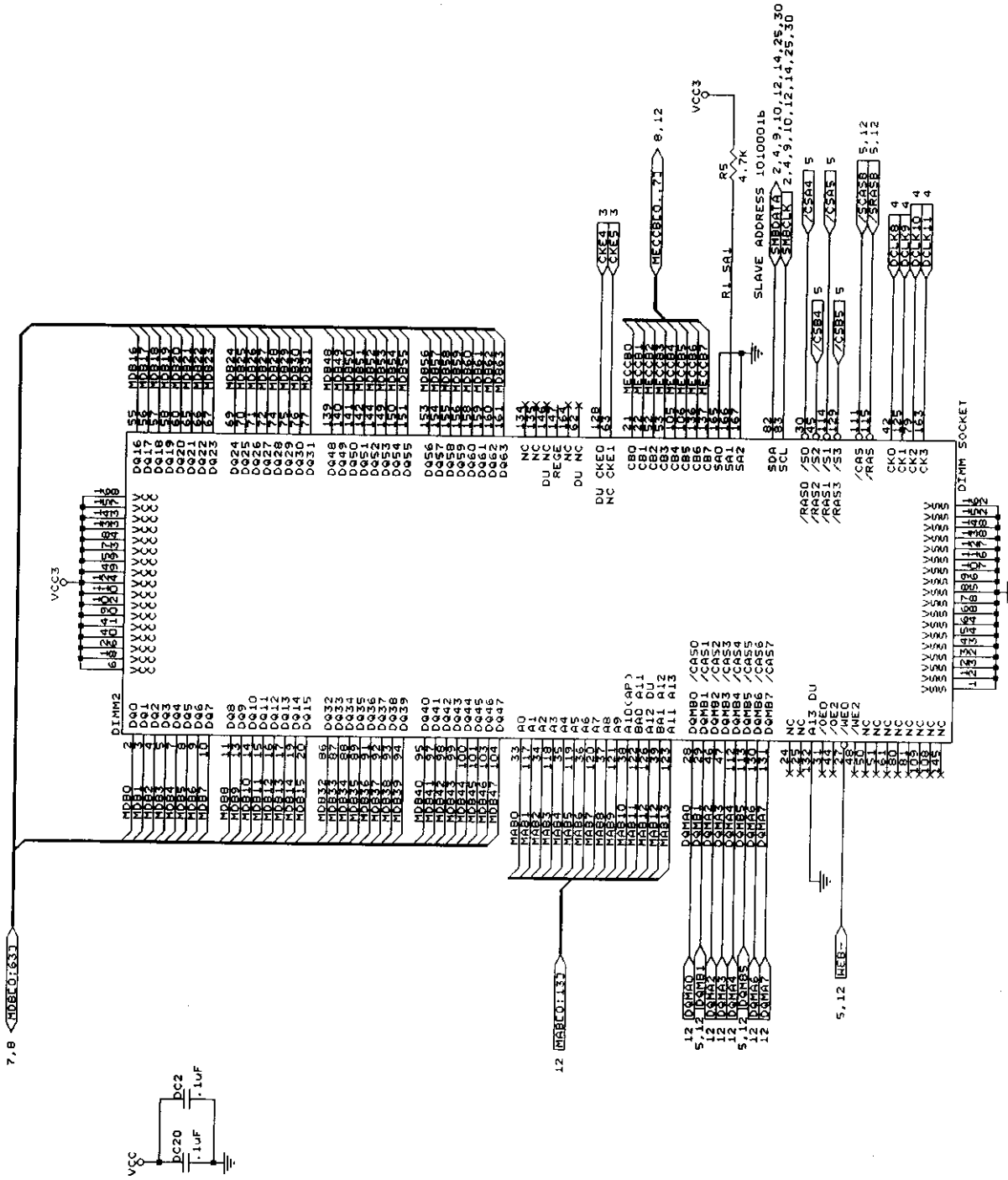

DIMM CONNECTOR 3

6,7,8,10 MPK63103

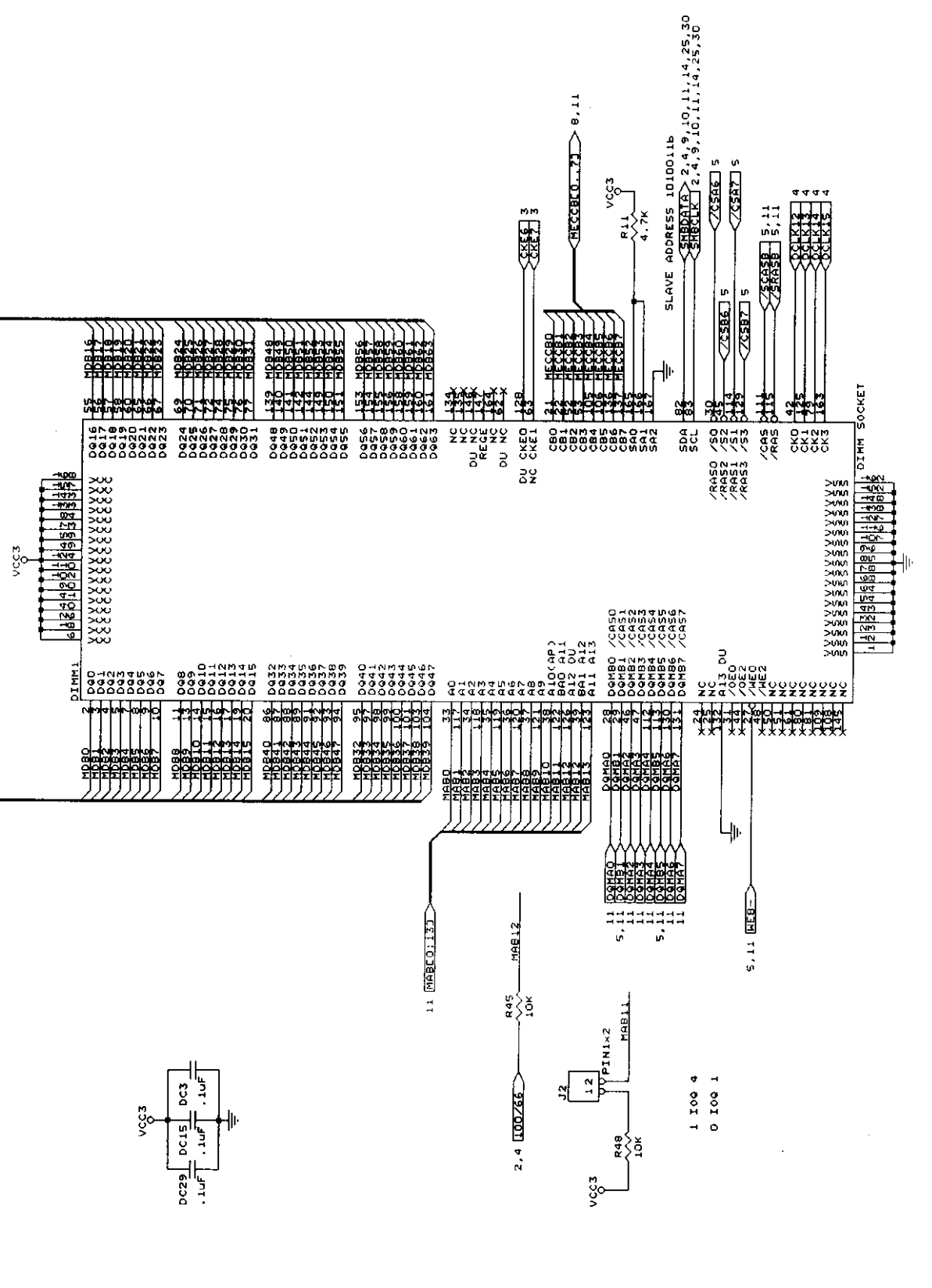

4th DIMM SOCKET (BANK3)
Size Document Number
B PRM-00801 DTK-ATX RA
Date: APR 21, 1998 Sheet 12 of 30

5, 16, 17 <DDE31..03> DDE31..03 20

5, 16, 17 <DDE31..03> DDE31..03 20

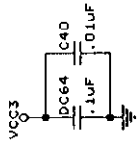

6, 16, 17, 25 <IRDY* > R113 IRDY* 33

5, 16, 17 <C.BE0..33> C.BE0..33 20

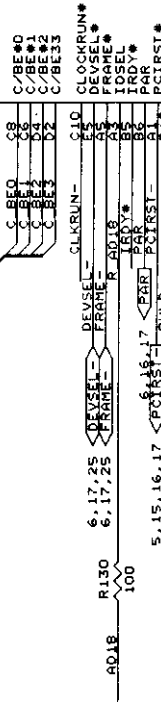

PIIX4

18, 21, 26, 28, 30 <SAC0..193> SAC0..193 20

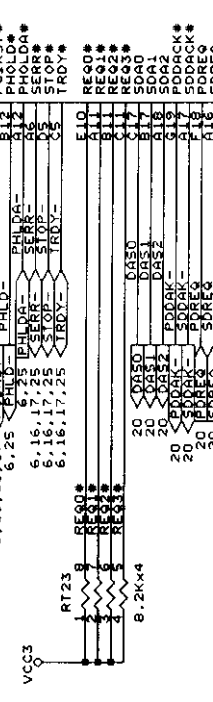

18, 21, 26, 28, 30 <SAC0..193> SAC0..193 20

18, 21, 26, 28, 30 <SAC0..193> SAC0..193 20

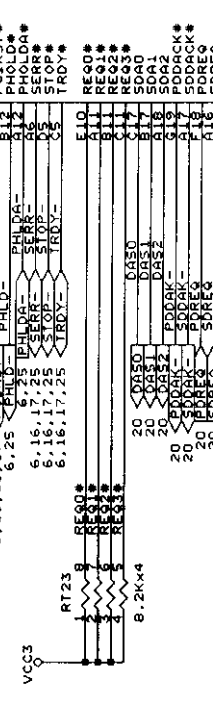

18, 26 <LAC23..179> LAC23..179 20

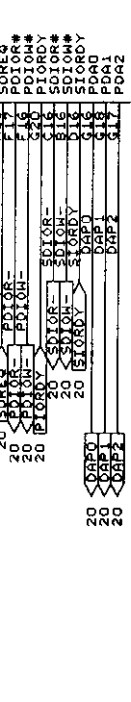

18, 26 <LAC23..179> LAC23..179 20

18, 26 <LAC23..179> LAC23..179 20

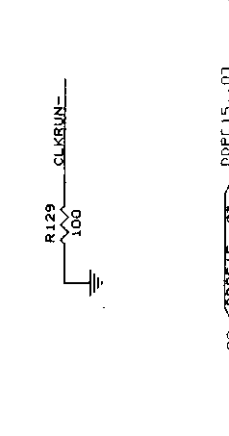
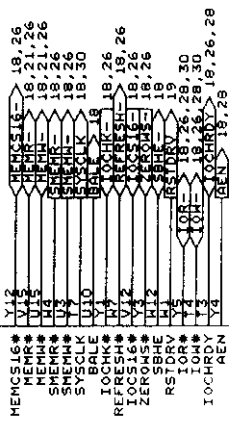

20 <DDE31..03> DDE31..03 20

8237 IEB

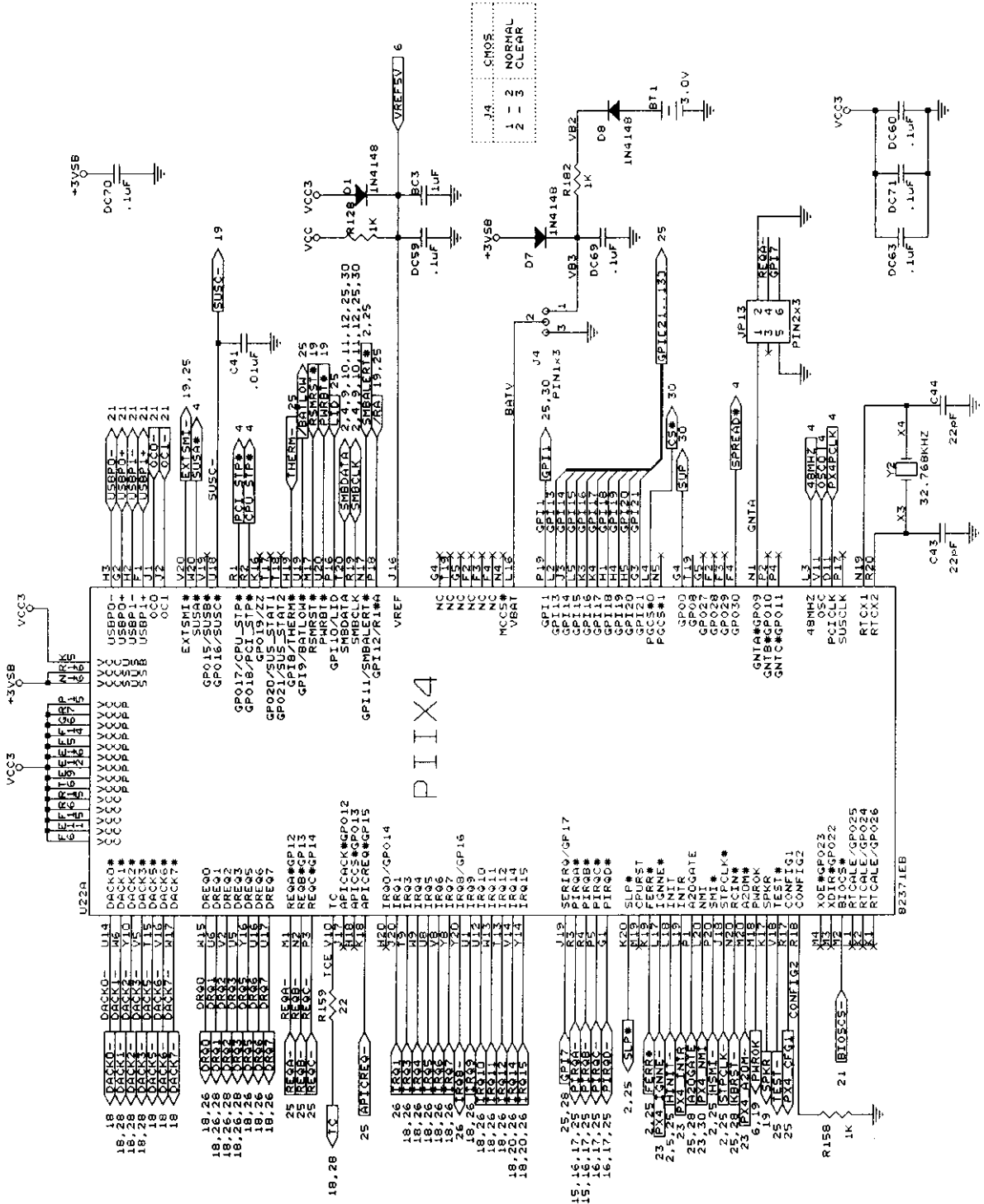

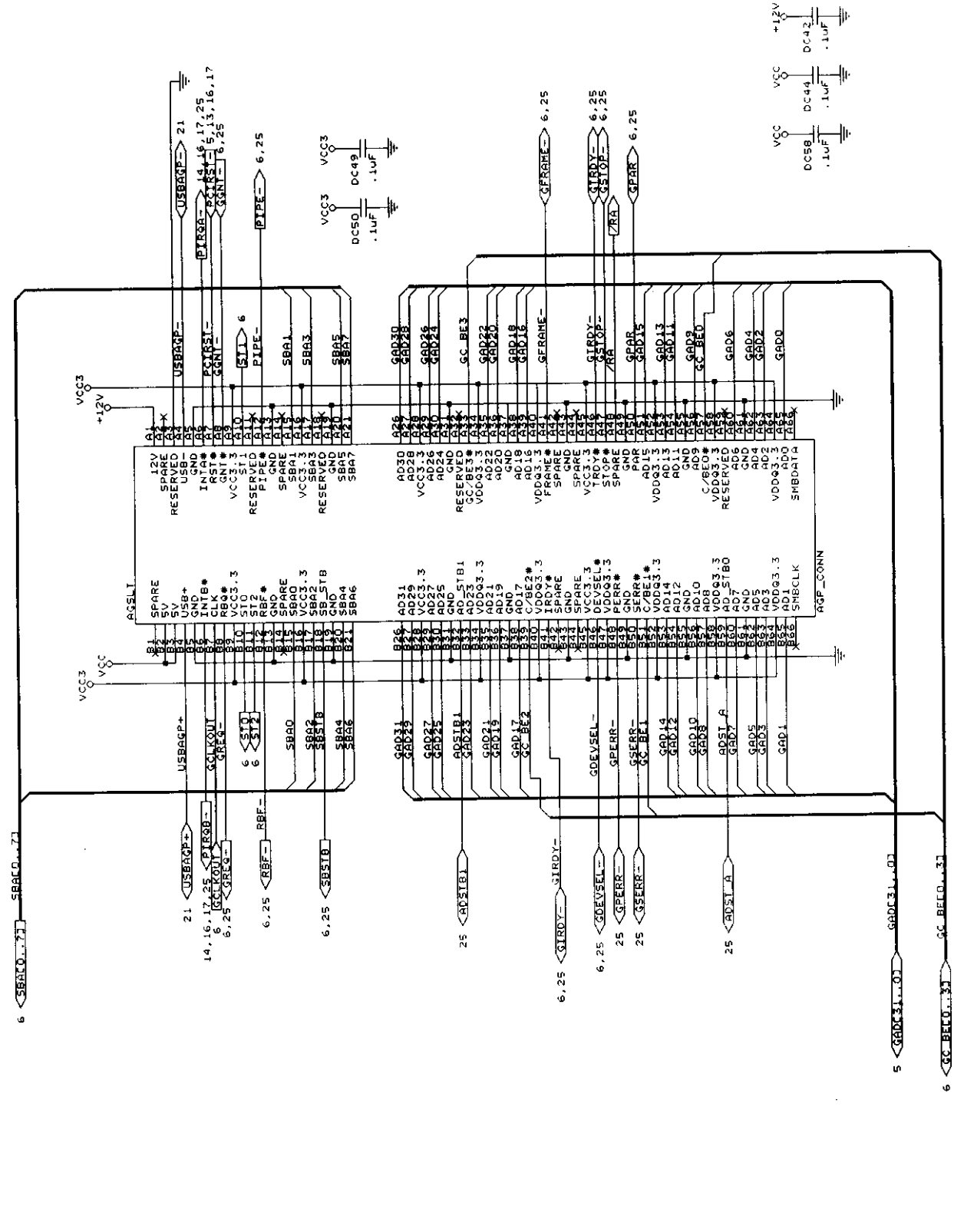

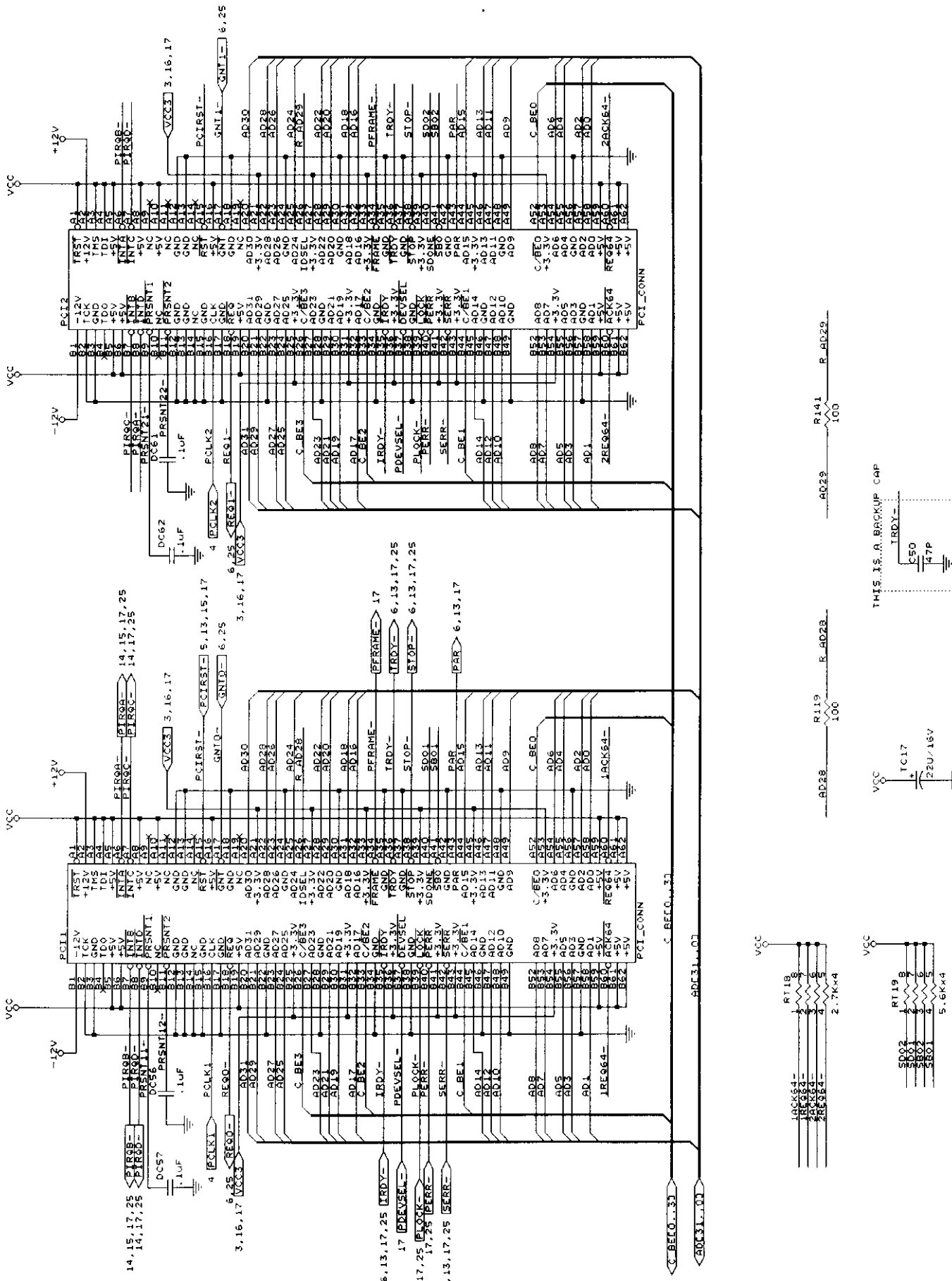

THIS IS A BACKUP CAP
 IRDY-
 C50
 47P

DO NOT REPRODUCE
PCI CONNECTORS
3 AND 4

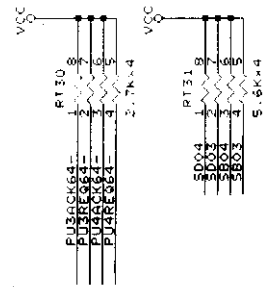
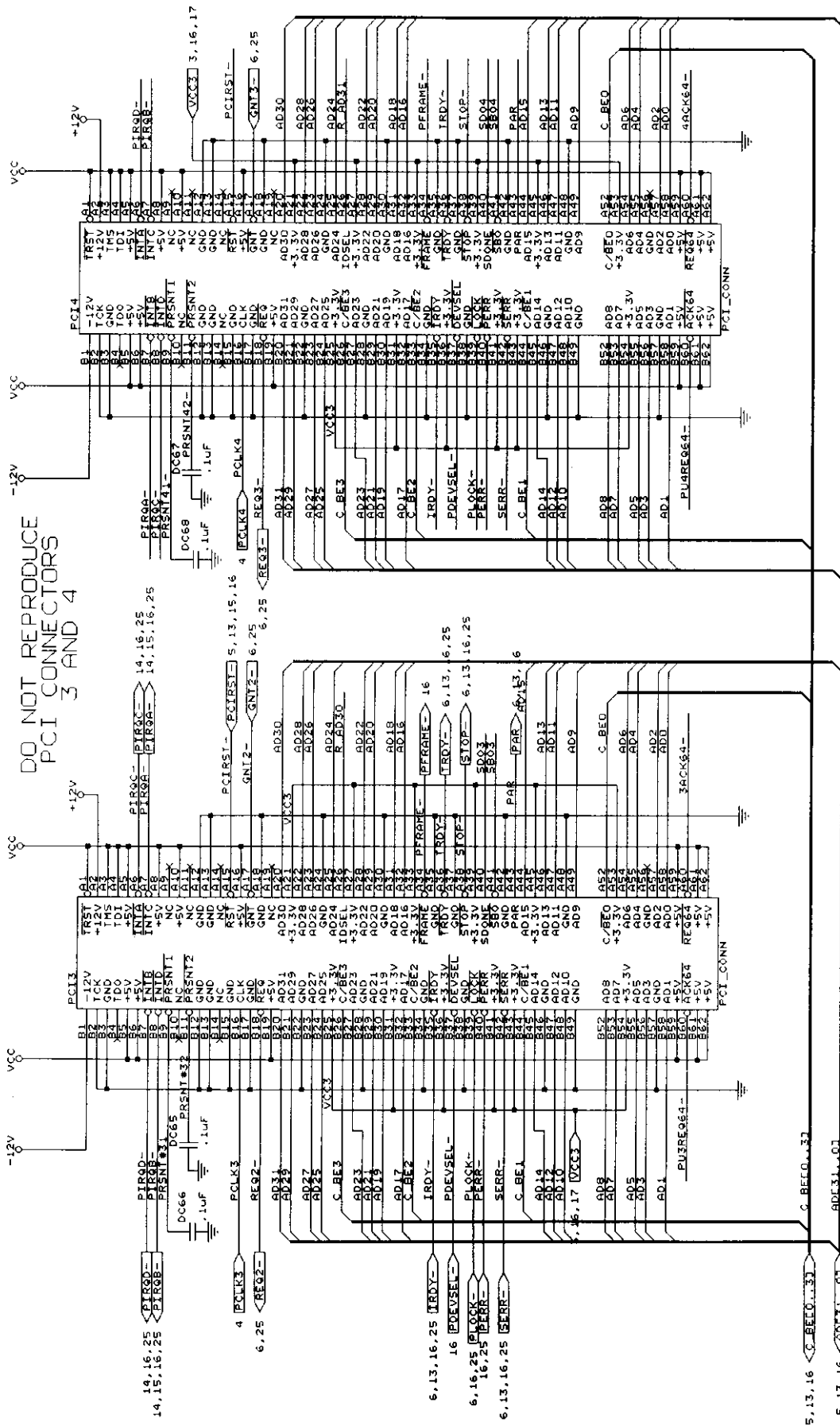

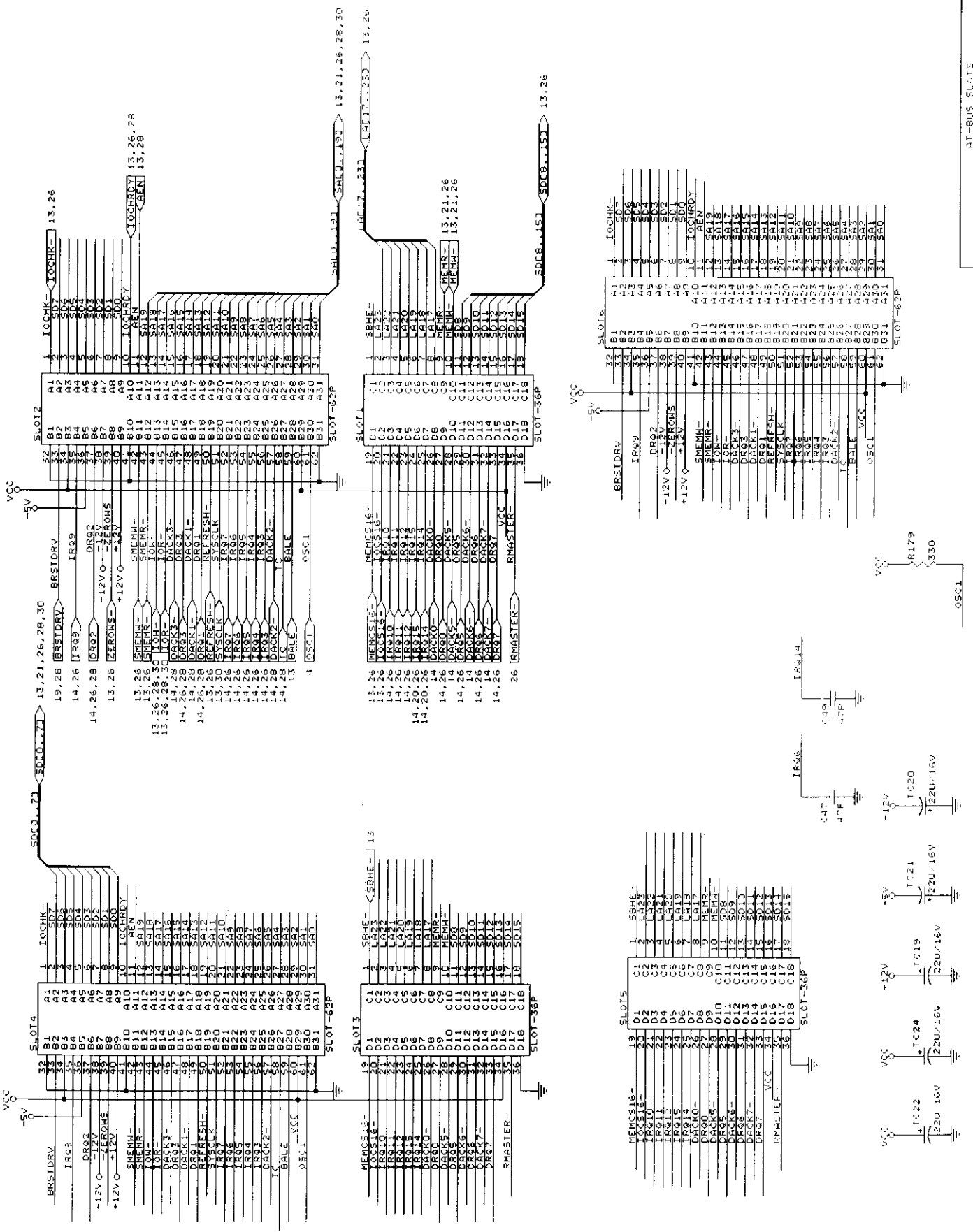

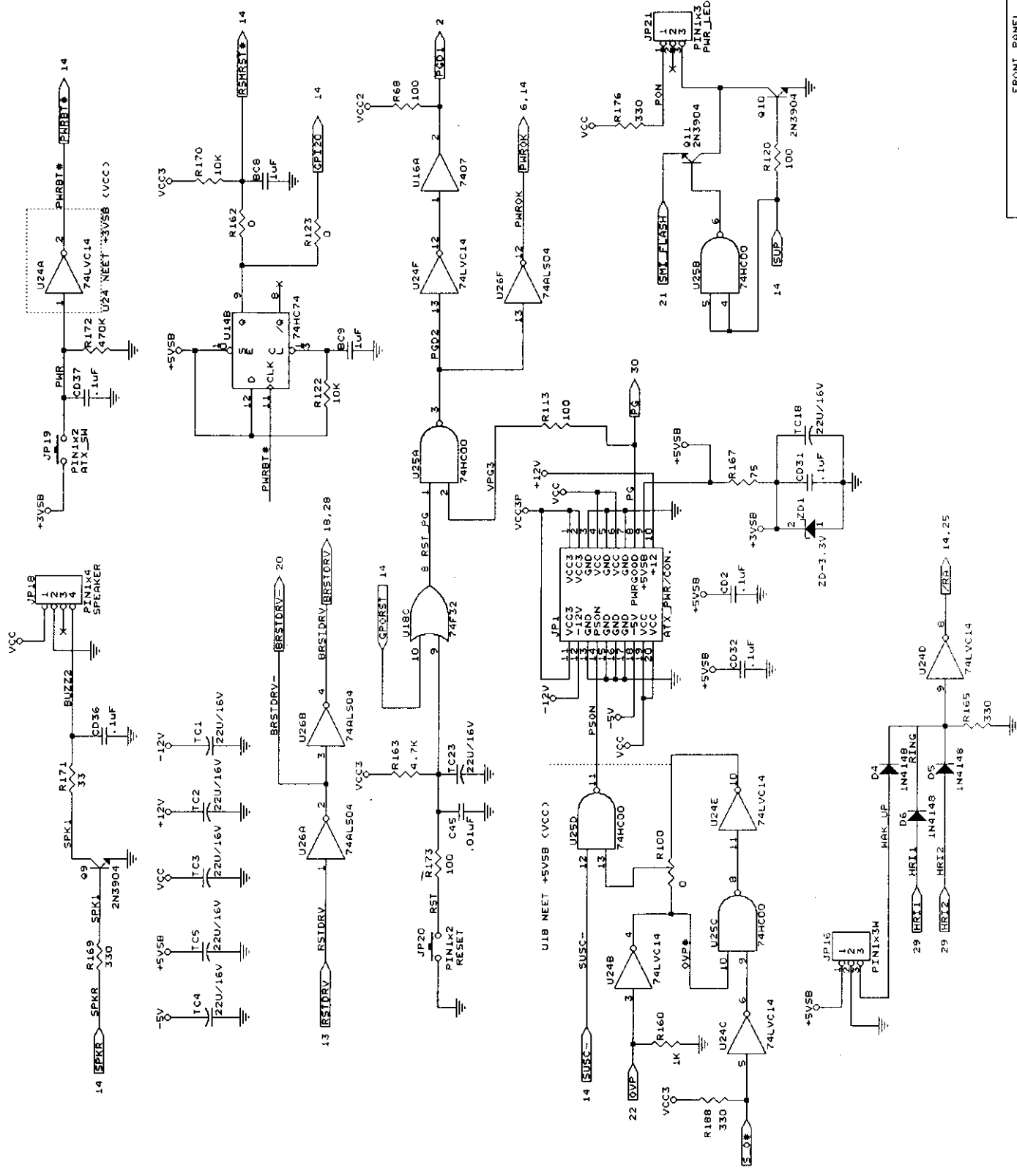

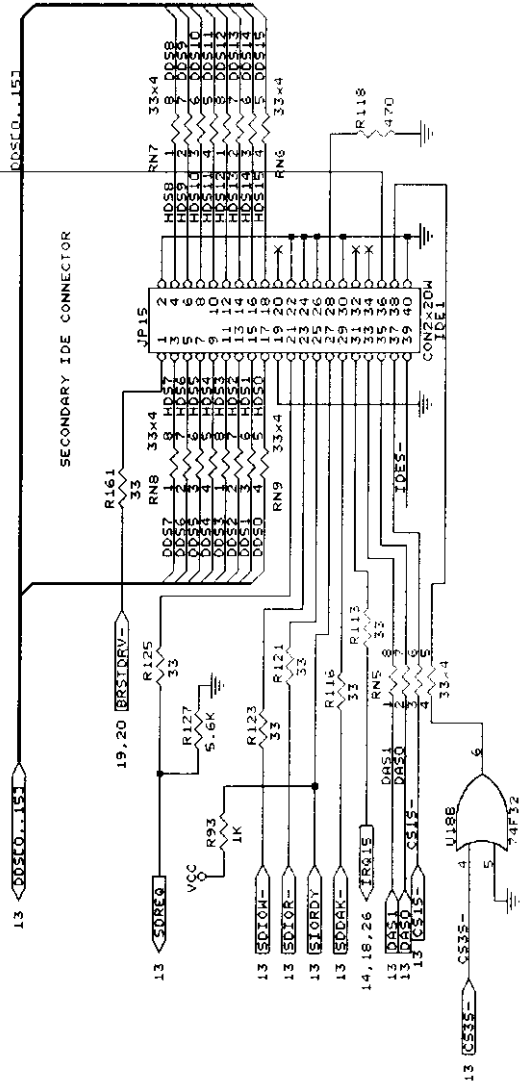
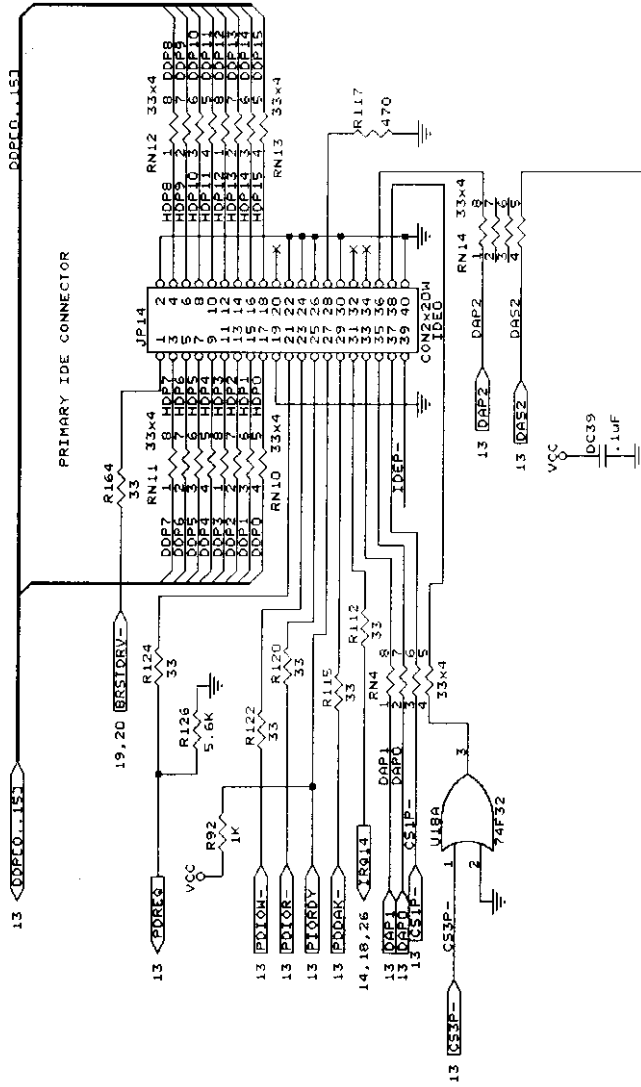
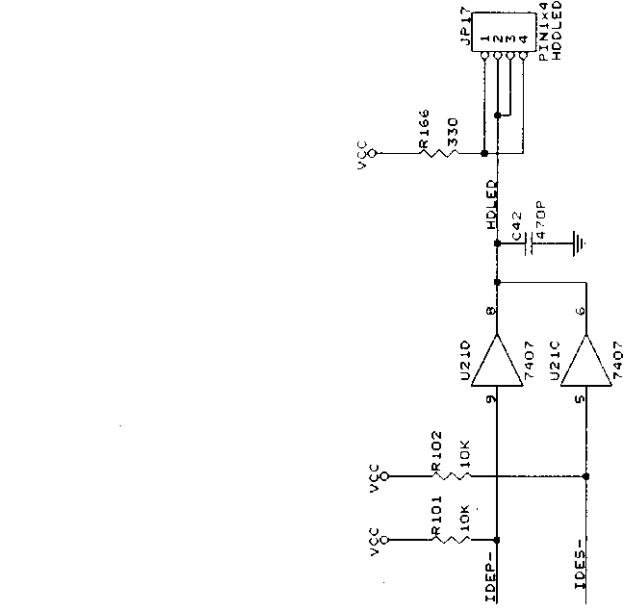

IDE CONNECTORS

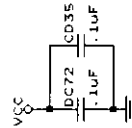
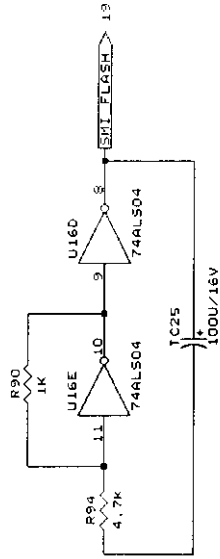
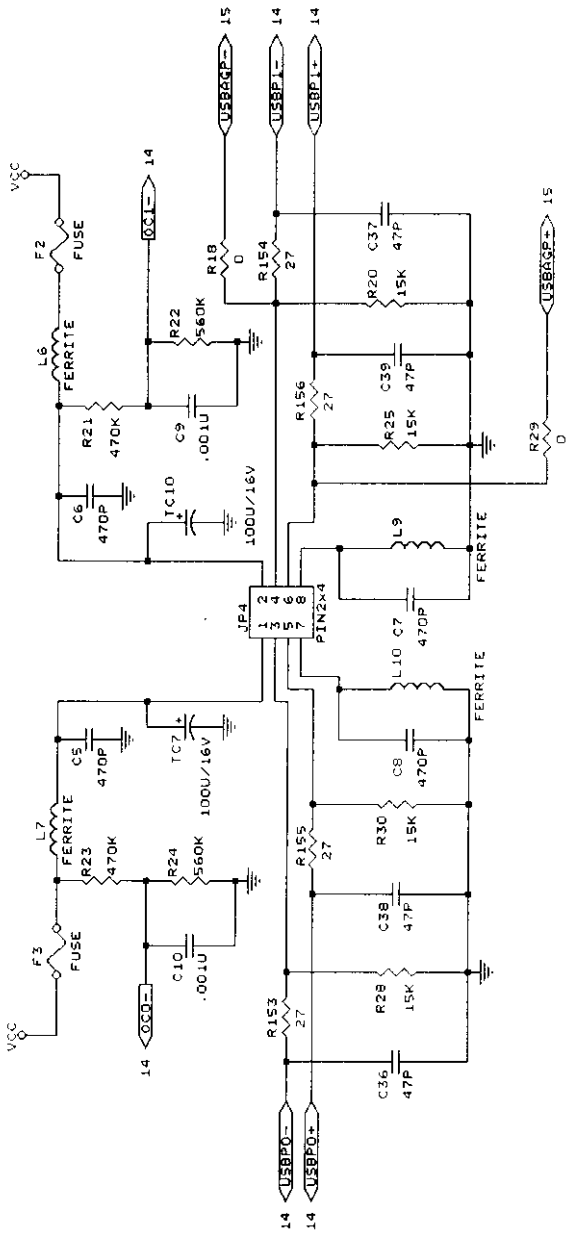

MODE	J6
SST, Winbond	1-2
Intel, MXIC	2-3

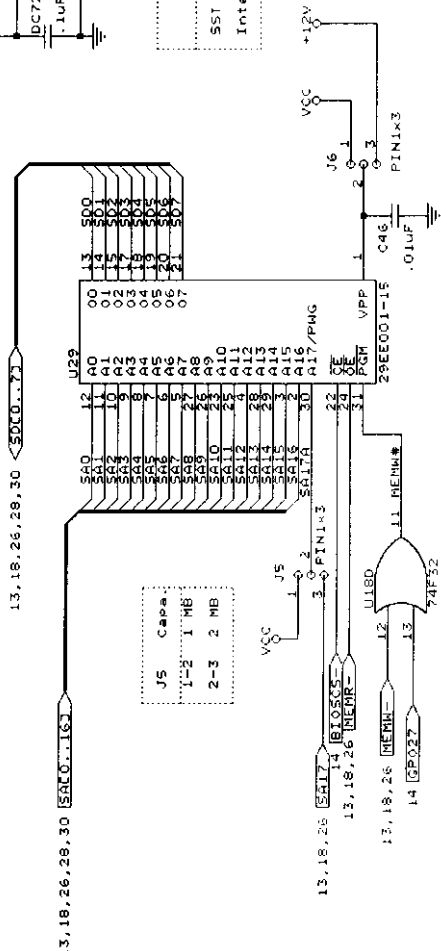

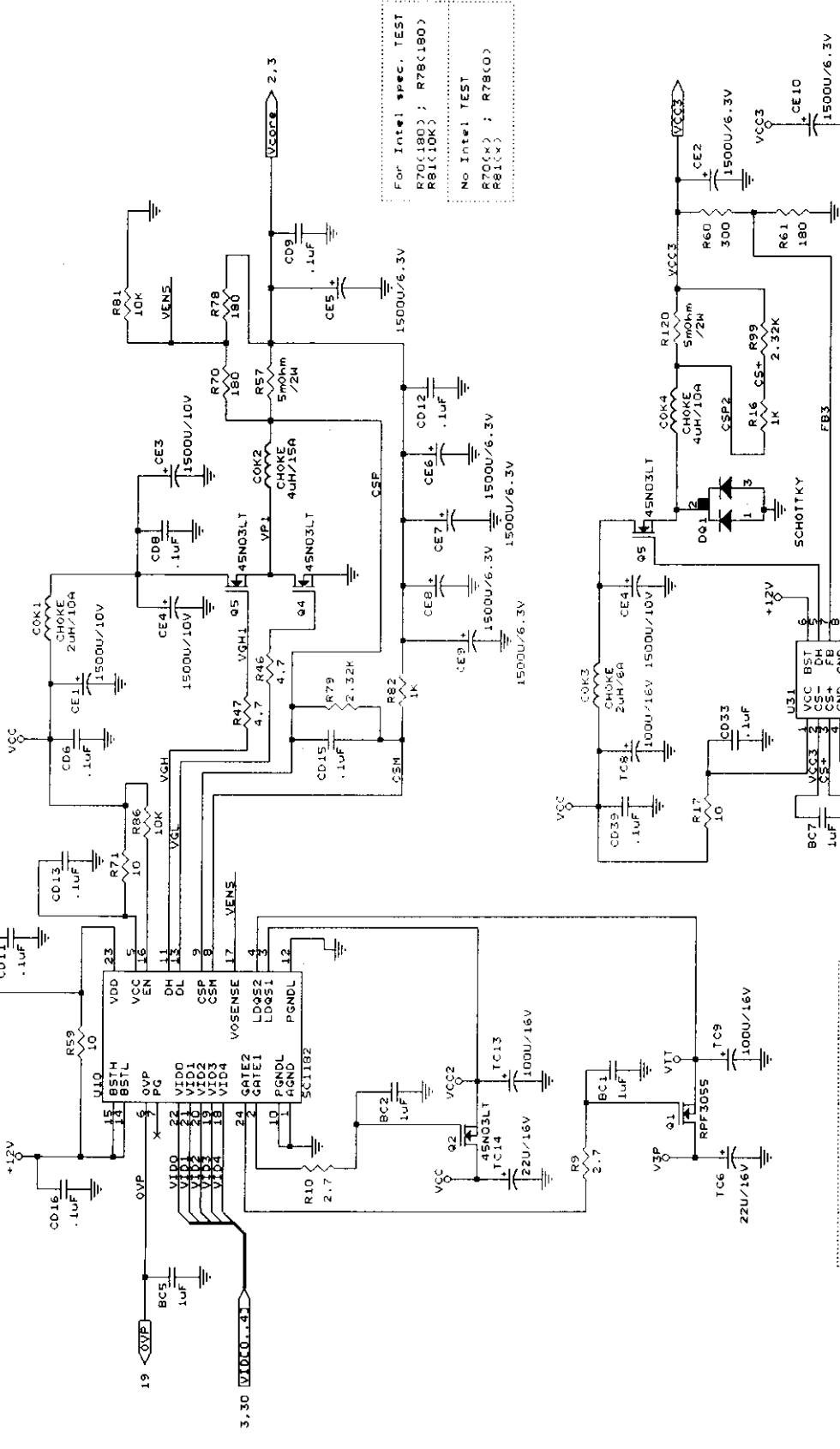

For Intel spec. TEST
 R70(180) ; R78(180)
 R81(10K)
 No Intel TEST
 R70(*) ; R78(0)
 R81(*)

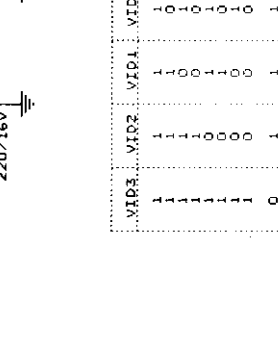
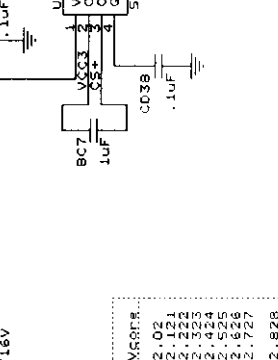

VID0	VID1	VID2	VID3	VID4	VID0	VID1	VID2	VID3	VID4
0	0	0	0	0	0	0	0	0	0
1	1	1	1	1	1	1	1	1	1
0	0	0	0	0	0	0	0	0	0
1	1	1	1	1	1	1	1	1	1
0	0	0	0	0	0	0	0	0	0
1	1	1	1	1	1	1	1	1	1
0	0	0	0	0	0	0	0	0	0
1	1	1	1	1	1	1	1	1	1
0	0	0	0	0	0	0	0	0	0
1	1	1	1	1	1	1	1	1	1
0	0	0	0	0	0	0	0	0	0
1	1	1	1	1	1	1	1	1	1
0	0	0	0	0	0	0	0	0	0
1	1	1	1	1	1	1	1	1	1
0	0	0	0	0	0	0	0	0	0
1	1	1	1	1	1	1	1	1	1
0	0	0	0	0	0	0	0	0	0
1	1	1	1	1	1	1	1	1	1
0	0	0	0	0	0	0	0	0	0
1	1	1	1	1	1	1	1	1	1
0	0	0	0	0	0	0	0	0	0
1	1	1	1	1	1	1	1	1	1
0	0	0	0	0	0	0	0	0	0
1	1	1	1	1	1	1	1	1	1
0	0	0	0	0	0	0	0	0	0
1	1	1	1	1	1	1	1	1	1
0	0	0	0	0	0	0	0	0	0
1	1	1	1	1	1	1	1	1	1

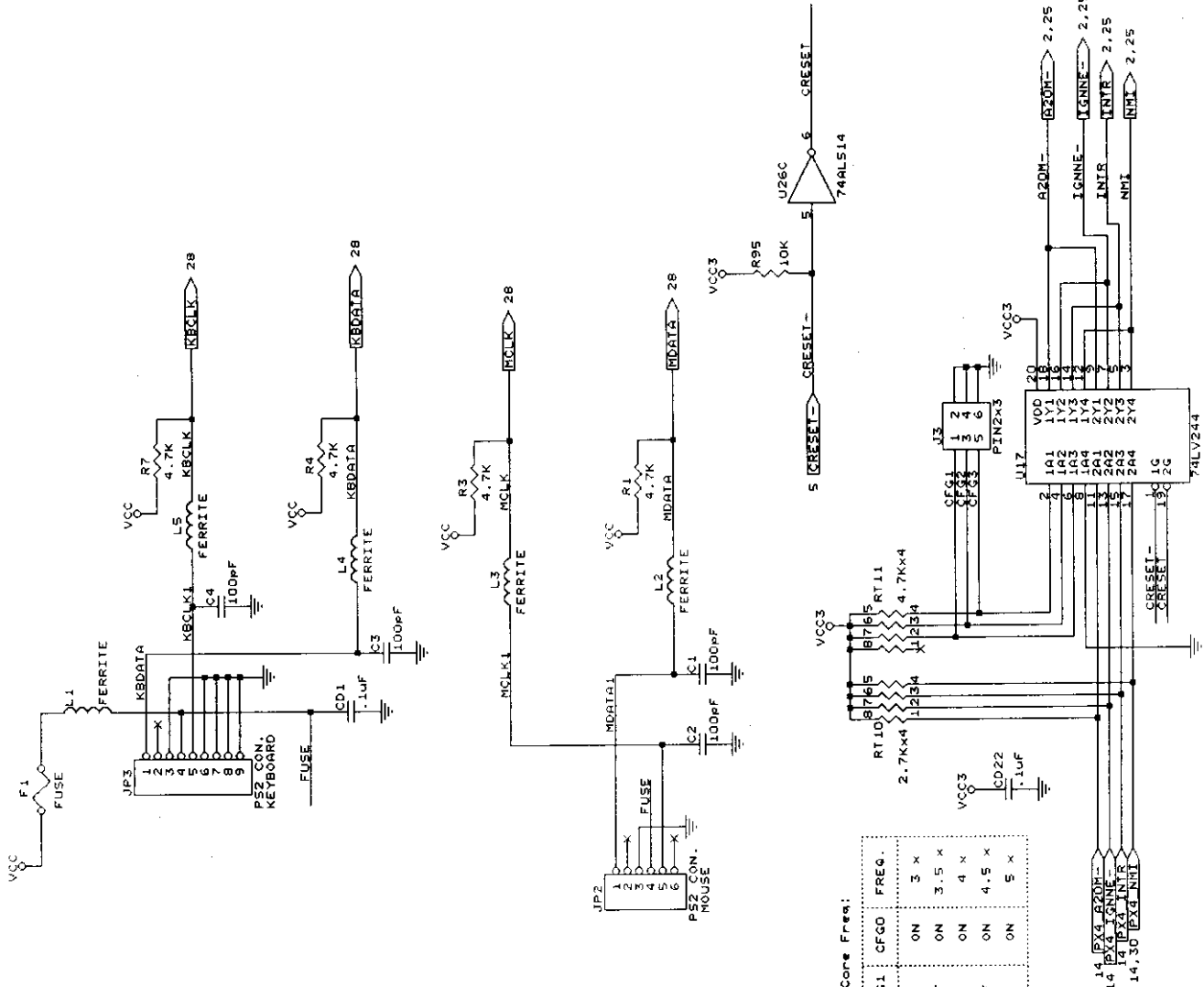

Processor Core Freq:

CFG3	CFG2	CFG1	CFG0	FREQ.
ON	OFF	ON	ON	3 x
ON	OFF	OFF	ON	3.5 x
OFF	ON	ON	ON	4 x
OFF	ON	OFF	ON	4.5 x
OFF	OFF	ON	ON	5 x

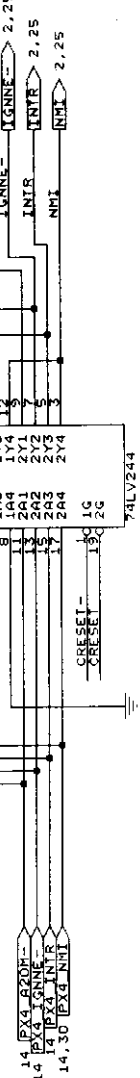

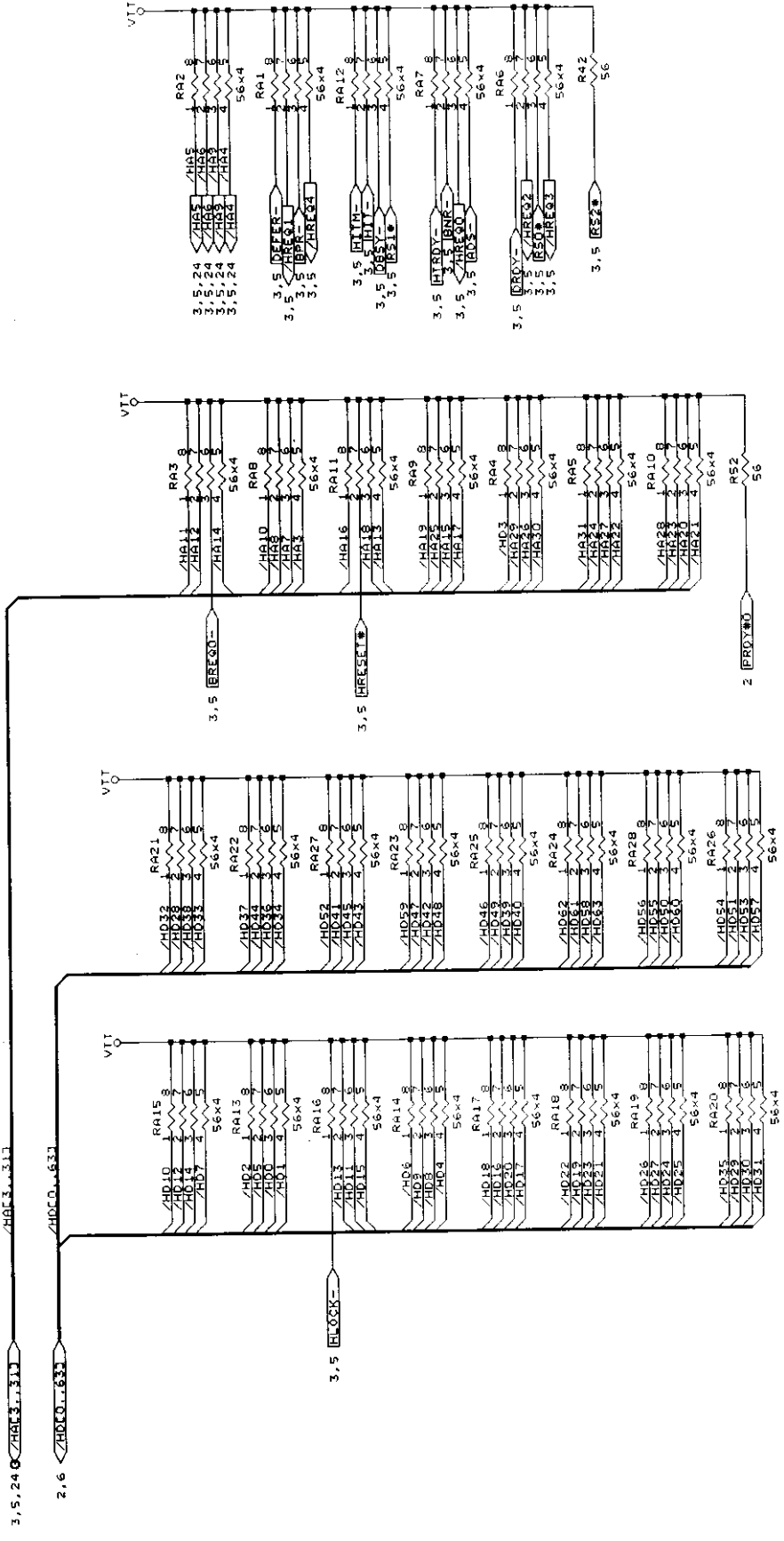

NOTE : VTT = TERMINATION VOLTAGE

TERMINATION VOLTAGE DECOUPLING

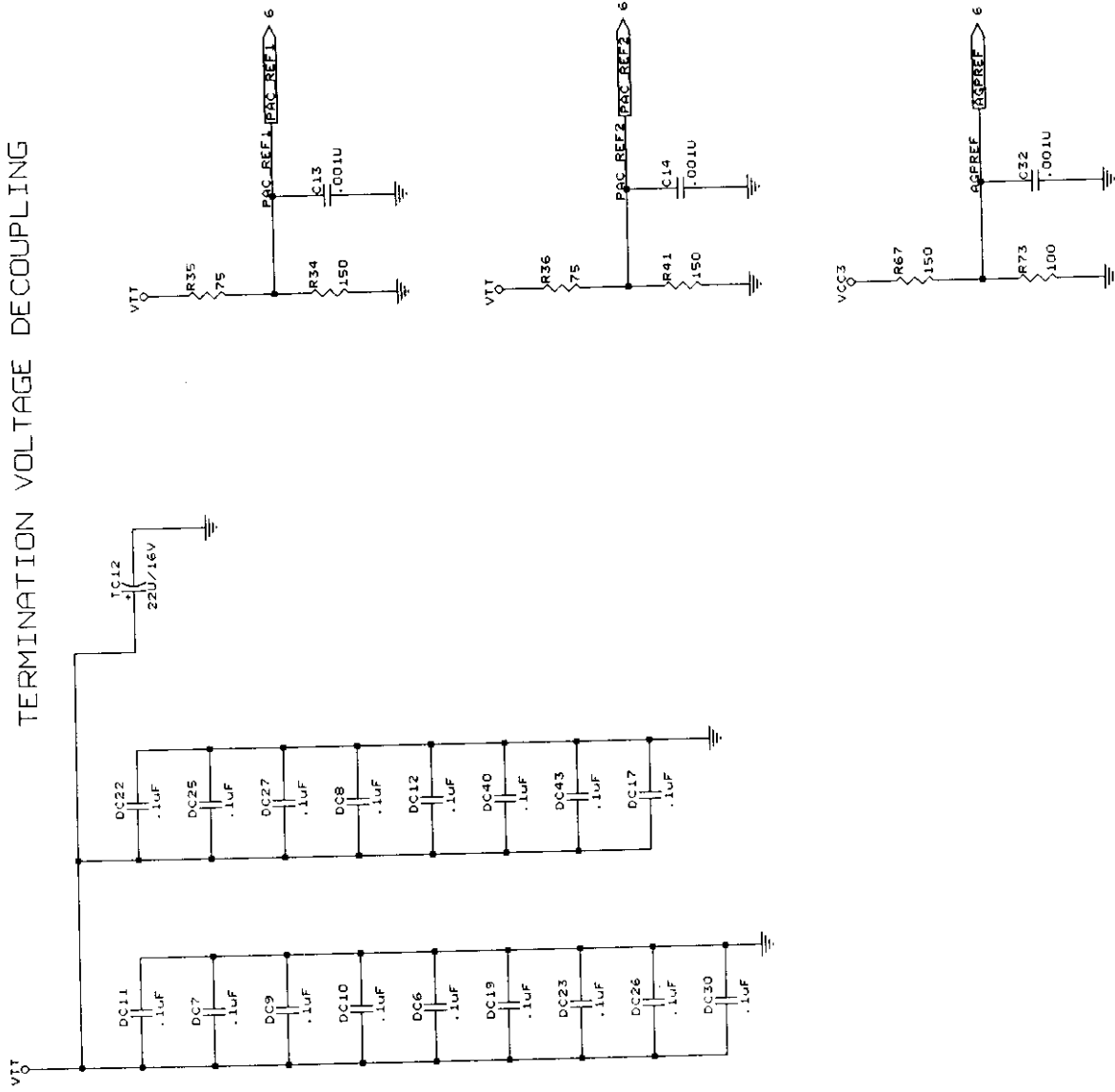

ISA BUS RESISTORS

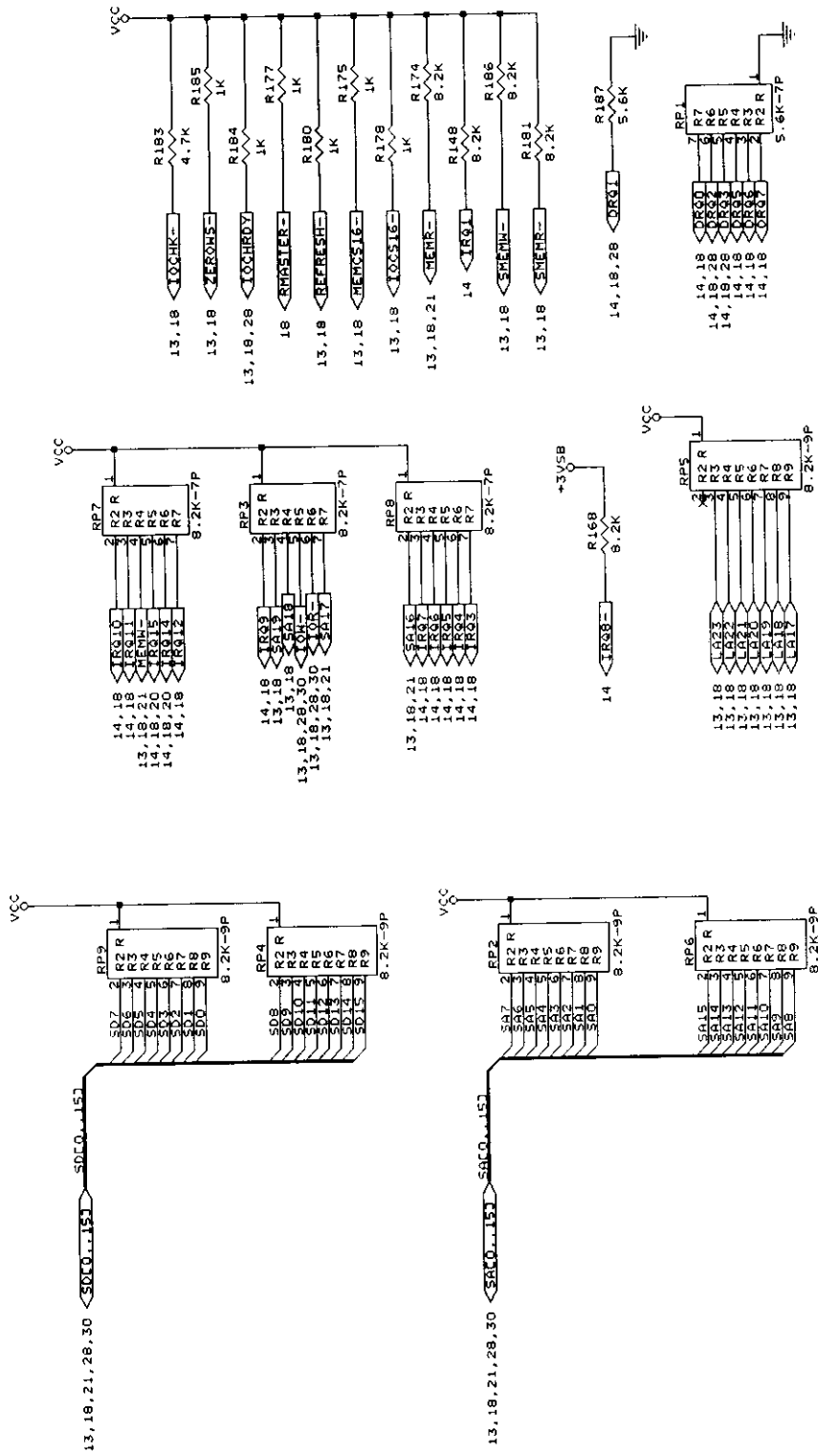

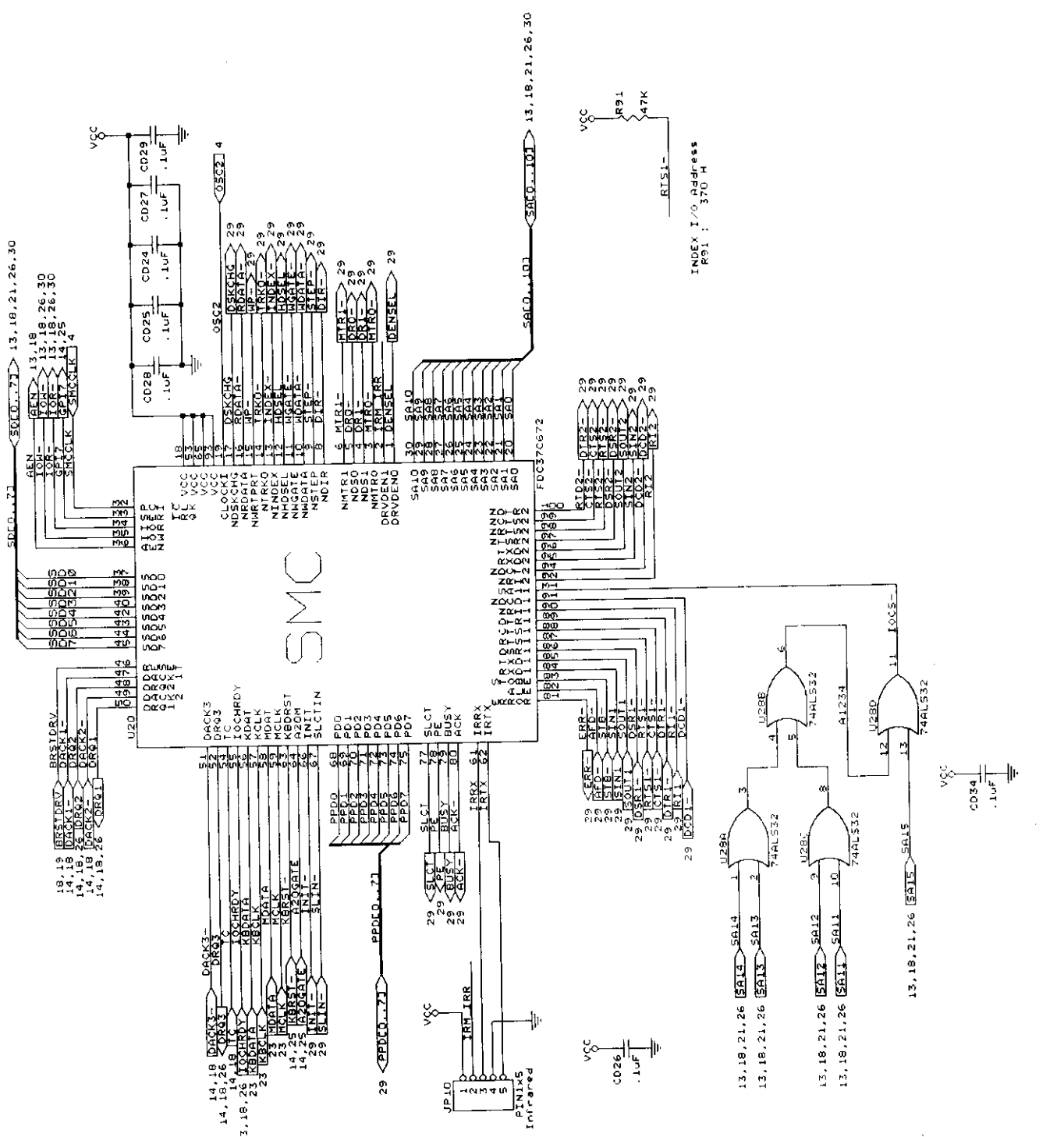

INDEX I/O Address
 R91: 370 M

VCC
 C034
 .1uF

In order to minimize the crosstalk in ECP mode, the termination circuits shown below are recommended. Place all termination circuits close to the connector to avoid EMI

