

3G4010/LE4010

3G (HSPA) Cellular Alarm Communicator

LTE Wireless Alarm Communicator

INSTALLATION MANUAL



Warning: This manual contains information on limitations regarding product use and function and information on the limitations as to liability of the manufacturer. The entire manual should be carefully read.

Contents

Section 1: Safety Information	3
Section 2: Introduction	4
2.1 Features	4
2.1.1 Technical Specifications	5
2.2 Identification of Parts	7
2.2.1 Description	7
Section 3: Installing the 3G4010/LE4010	9
3.1 C24 Communications Enrollment	9
Section 4: Connecting the 3G4010/LE4010	11
Section 5: Status LEDs	12
5.1 Operating Modes	12
5.1.1 Normal Mode	12
5.1.2 Service Mode	12
Section 6: Operating Principles	14
6.1 Simulated Landline Mode	14
6.2 Panel Transmission Monitoring (PTM)	14
6.3 Cellular Communications Sequence	14
6.4 Inputs	15
6.5 Outputs	15
6.5.1 Activating the Outputs	15
6.6 Reporting Codes	16
6.7 Swinger Shutdown	16
6.8 Hardware Default	17
6.9 Communicator Reset/Update	17
6.10 Low Power Radio Shutdown	18
6.11 SMS Command and Control	18
6.11.1 Arming/Disarming the Security Panel	18
6.11.2 Remote Control of PGM	18
6.12 Phone Number Call Direction	19
6.13 C24 Communications Remote Programming	20
Section 7: Troubleshooting Guide	21
7.1 LE4010 IM Wiring Diagrams	25

Section 1: Safety Information

IMPORTANT

The equipment is fixed, wall-mounted and shall be installed in the position specified in these instructions (see Figure 1: Parts). The equipment enclosure must be fully assembled and closed, with all the necessary screws/tabs and secured to a wall before operation. Internal wiring must be routed in a manner that prevents:

- Excessive strain on wire and on terminal connections
- Loosening of terminal; connections
- Damage of conductor insulation

WARNING: Never install this equipment during a lightning storm!

Instruct the end-user to:

- Not attempt to service this product. Opening or removing covers may expose the user to dangerous voltages or other risks. Any servicing shall be referred to trained service persons only.
- Use authorized accessories only with this equipment.

Do not dispose of the battery in fire or water. Disposing of the battery in a fire will cause rupture and explosion.

Do not dispose of the waste battery as unsorted municipal waste. Consult your local regulations and /or laws regarding recycling with regard to this lead-acid battery. Doing so will help protect the environment. Some of the materials that are found within the battery could become toxic if not disposed of properly and may affect the environment.

All circuits are classified for UL installations as Power Limited/Class II Power Limited except for the battery leads which are not power limited. Do not route any wiring over circuit boards. Maintain at least 1" (25.4mm) separation. A minimum 1/4" (6.4mm) of separation must be maintained at all points between Power Limited wiring and all other non-Power Limited wiring. Route wires as indicated above.

This equipment, 3G4010/LE4010, is fixed and shall be installed by Service Persons only (Service Person is defined as a person having the appropriate technical training and experience necessary to be aware of hazards to which that person may be exposed in performing a task, and of measures available to minimize the risks to that person or other persons). It shall be installed and used within an environment that provides the pollution degree max 2, over voltages category II, in non-hazardous, indoor locations only. This manual shall be used with the Installation Manual of the relevant alarm control panel. All instructions specified within that manual must be observed.

The performance of the 3G4010/LE4010 depends greatly on cellular network coverage. Therefore, it should not be mounted without first performing placement tests to determine the best location for reception (minimum of one green LED ON). Optional antenna kits – LTE-8ANT, LTE-15ANT, LTE-25ANT, LTE-50ANT (8ft/2.4m, 15ft/4.6m, 25ft/7.6m or 50ft/15.2m) – are available.

Section 2: Introduction

This manual covers two communicator models, the 3G4010 and the LE4010. They are referred to throughout this manual as 3G4010/LE4010 unless otherwise indicated.

Both models send alarm system information to a Sur-Gard System I-IP, II, III, IV or 5 receiver. The 3G4010 uses the 3G (HSPA) or 2G (GPRS) cellular network. The LE4010 uses the LTE or 3G wireless network. The 3G4010/LE4010 can be used with UL/ULC Listed compatible control units, as indicated in the manufacturer's installation instructions.

Note: These communicators are designed to work with the Contact ID communication format as described in the SIA DC-05 standard and the SIA DC-03 standard for 300 baud. Before completing the field installation of the alarm monitoring system please ensure communication with the supervising central station is successful by sending several events and getting confirmation that they have been received.

2.1 Features

- Dual-band UMTS/HSPA; Penta-Band LTE (LE4010); Quad-Band GSM/EDGE Radio
- Advanced Carrier Selection
- Bi-color Wireless Signal Strength Indicator
- 3G (HSPA) / 2G (GPRS) ; LTE or 3G (LE4010) Internet communication with Sur-Gard SG-System I-IP / II / III / IV / 5
- Compatible with 4-digit or 10-digit Contact ID communication format as described in SIA DC-05 Standard and the SIA DC-03 standard for 300 baud. Example of suitable compatible alarm panels: DSC Models PC1864, PC1832, PC1616, PC4020. For LE4010, the following alarm panels are also compatible: HS2128, HS2064, HS2032, HS2016
- Panel Transmission Monitoring for up to four phone numbers
- Simulates landline
- Switches automatically to the 3G (HSPA) or 2G (GPRS) / LTE or 3G (LE4010) network in the event of landline trouble (e.g., line down)
- Four Programmable (NO/NC/SEOL) Inputs
- 12V 1.2Ah battery (optional, not included)
- Case Tamper Output
- Landline overvoltage protection
- Four Programmable Outputs
- DLS support for status, firmware updates and remote debug enable
- Remote Firmware Upgrade
- Remote Diagnostics
- Panel Format Detection
- SMS Command and Control
- Phone number call direction
- Easy enrollment with C24 Communications via web or mobile interface

2.1.1 Technical Specifications

The input voltage to the 3G4010/LE4010 can be drawn from the UL/ULC Listed control panel or provided by an external UL/ULC Listed power supply rated for the application (external power-limited source).

Note: The power supply must be Class 2, Power Limited. For residential applications a suitable power adaptor is model DSC ADP1310(W)-NAU or DSC ADP1320-NAU (for USA) and model DSC ADP1310(W)-NA (for Canada).

Table 4-1 Ratings

Power Supply Ratings	
Input Voltage:	9-14Vdc (use separately listed control panel or power supply) or 13.8Vdc (use DSC ADP1310 (W)-NAx or ADP1320-NAx power adapter)
Current Consumption	
Average Current (standby with PSTN connected):	40mA*
Average Current (standby without PSTN connected):	55mA*
Transmission Current (no battery):	225mA*
* Plus any current drawn from the 3G4010/LE4010 AUX+ terminal	
Working Voltage Range	
With Battery:	11-14Vdc
Without Battery:	9-14Vdc
Battery Type:	sealed, rechargeable type, rated 12V/1.2Ah (for 24hr standby time)
Battery charging voltage:	13.75Vdc
Battery charge current limit:	360mA
NOTE: Battery must be replaced every 3-5 years.	
NOTE: When using the battery, use DSC ADP 1310-NAU(W) or ADP 1320-NAU power adapter	
Operating frequency - 2G (GSM/GPRS/EDGE):	850/1900MHz
Operating frequency - 3G (UMTS/HSPA):	850/1900MHz
For LE4010 operating frequencies, see table below.	
Antenna gain:	2.0dBi
Environmental Specifications	
Operating temperature:	0°C-49°C (32°F-120°F)
Humidity:	93%RH Maximum (non-condensing)
Mechanical Specifications	

Dimensions (metal enclosure, painted):	138mm x 224mm x 55mm / 5.4" x 8.8" x 2.2"
Weight (without battery):	900g / 3.2oz
Simulated Telco Loop specifications (TIP/RING)	
On-Hook Voltage:	12Vdc
Off-Hook Voltage (Maximum):	22Vdc
Loop Current :	25mA
Loop Resistance :	600 Ohms
Alternate construction	
Dimensions (enclosure for 3G4010/LE4010):	138mm x 257mm x 55mm / 5.4" x 8.8" x 2.2"
Weight (alternate construction enclosure without battery):	1300g / 2.8lbs

Table 4-2 LE4010 Operating Frequencies

Band	Transmit Band (Tx)	Receive Band (Rx)
LTE B2	1850 - 1910 MHz	1930 - 1990 MHz
LTE B4	1710 - 1755 MHz	2110 - 2155 MHz
LTE B5	824 - 849 MHz	869 - 894 MHz
LTE B12	698 - 716 MHz	728 - 746 MHz
LTE B13	777 - 787 MHz	746 - 756 MHz
UMTS B2	1850 - 1910 MHz	1930 - 1990 MHz
UMTS B5	824 - 840 MHz	869 - 894 MHz

2.2 Identification of Parts

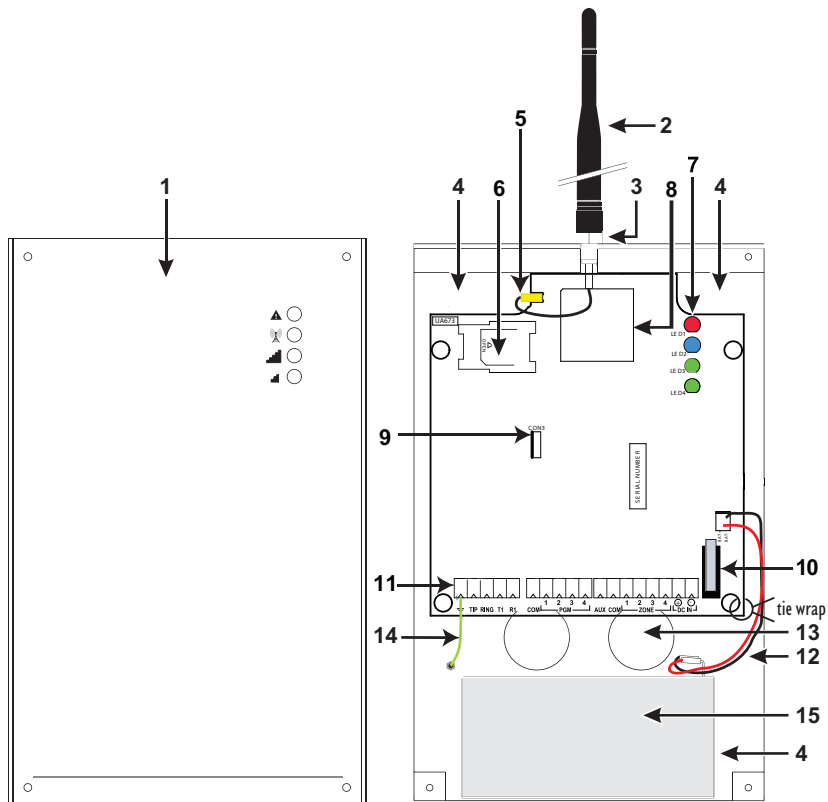

	Part
1	Metal Casing
2	3G/LTE Antenna
3	Antenna Mounting Hardware
4	Anchor Screw Holes (3mm)
5	Antenna Connector
6	SIM Card Holder
7	Status LEDs (Table Section 5: : Status LEDs)
8	3G (HSPA) Radio Module (3G4010); LTE Radio Module (LE4010)

	Part
9	PC-Link Connector
10	Tamper Switch
11	Terminal Blocks
12	Battery Leads
13	Cable Entry
14	Earth Ground Wire
15	12V/1.2Ah Battery (not included)

2.2.1 Description

This 3G4010/LE4010 manages transmissions to a central station and can simulate the landline in the event of trouble (e.g., landline down) or even substitute the landline completely in areas where the 3G or 2G cellular service is provided and a landline is not available.

The 3G4010/LE4010 has the capability of communicating alarm signals via the 3G or 2G data network. This capability ensures a fast, reliable path to central stations equipped with a Sur-Gard System I-IP / II / III / IV / 5 receiver. By connecting a 3G4010/LE4010 to a control panel's standard PSTN interface, telephone-based

Contact ID or SIA signals are decoded and seamlessly routed through the LTE, 3G or 2G network to any of the compatible receiver options.

The performance of the 3G4010/LE4010 depends greatly on cellular network coverage. Therefore, it should not be mounted without first performing placement tests to determine the best location for reception (minimum of one green LED ON). Optional antenna kits – LTE-8ANT (8ft/2.4m), LTE-15ANT (15ft/4.6m), LTE-25ANT (25ft/7.6m) and LTE-50ANT (50ft/15.2m) – are available.

For UL Residential Fire and Burglary installations, the 3G4010/LE4010 is listed as a sole means of communication or as a back up when used in conjunction with a POTS line (dialer).

For UL Commercial Burglary installations, the 3G4010/LE4010 is listed as a sole means of communication (supervision window of 200s required at monitoring station) or as a back-up when used in conjunction with a POTS line (dialer). The 3G4010/LE4010 shall be powered from any compatible listed control unit or compatible listed power supply that complies with the ratings specified on page 1. The power supply shall be listed for burglary applications and provide a minimum of 4 hours standby power capabilities. An example of a suitable listed compatible control unit is the DSC Model HS2128 with an AUX output rated 11.1 - 12.6VDC. An example of a suitable Listed power supply is DSC Model HSM2204 with an AUX output rated 11.6 - 12.6VDC.

For ULC Commercial Fire Monitoring Installations the 3G4010/LE4010 can be used in the following configurations:

1. Active communication system with 180 seconds supervision (Heartbeat sent to signal receiving centre every 90 sec.).
2. Passive communication system in conjunction with a another communication path (e.g. DACT) (there is no heartbeat sent in this configuration, only periodic test transmission). Alarm signals must be sent simultaneously over both communication paths (Cellular and DACT). Every 24 hours, a test transmission must be sent to the signal receiving centre over each communication path. Each communication path shall be monitored for integrity (DACT shall have line monitoring enabled and 3G4010/LE4010 shall have cellular connection supervision enabled).

For ULC Commercial Burglary Monitoring Installations the 3G4010/LE4010 can be used in the following configurations:

1. Active communication system with 180 seconds supervision and heartbeat sent to signal receiving centre every 90 sec.
2. Passive communication system line security P1 (single communication channel) or line security P2 (used as backup in conjunction with another communication path (e.g. DACT)). There is no heartbeat sent in this configuration, only periodic test transmissions. Every 24 hours, a test transmission must be sent to the signal receiving centre over each communication path. Each communication path shall be monitored for integrity (DACT shall have line monitoring enabled and 3G4010/LE4010 shall have cellular connection supervision enabled). For Level P2 the working communication path shall report the failure of the other channel within 240s.

For ULC Residential Fire and Burglary installations the 3G4010/LE4010 is listed as a sole means communication or as a back up when used in conjunction with a POTS line (dialer).

Section 3: Installing the 3G4010/LE4010

3.1 C24 Communications Enrollment

The 3G4010/LE4010 requires enrollment with C24 Communications to operate. For more information, please visit www.connect24.com, contact C24 Communications customer service at 1-888-251-7458 (US) / 1-888-955-5583 (Canada) or contact the central station to inquire if they are a C24 Communications Master Reseller. **Note:** Enrollment with C24 Communications should be performed before turning on the 3G4010/LE4010 unit. Before inserting or removing the SIM card, please ensure the unit is turned off.

Step 1 - Initialize the 3G4010/LE4010 with C24 Communications

The 3G4010/LE4010 can be initialized with C24 Communications by:

web - www.connect24.com

mobile - m.connect24.com

To complete enrollment, a C24 profile, installer ID/PIN (or web credentials) and the 20-digit SIM number are required.





Note: The SIM activation process with the cellular carrier typically takes between five and ten minutes to complete.

Step 2 - Determine the Best Signal Location

1. Detach the front cover by removing the four screws.
2. Apply power (DC and/or battery). The 3G4010/LE4010 is now in Placement Test mode.

Step 2a – SIM Card Is Activated.





The red LED is on solid, the blue LED is off and the signal strength LEDs display the average signal strength. In this state, the 3G4010/LE4010 is registered to the network.

 Red	 Blue	 Yellow/Green (Top)	 Yellow/Green (Bottom)
ON	OFF	-	-

If the signal strength is too low (bottom signal LED off or flashing), the 3G4010/LE4010 will proceed to **Step 3**: scan for, and attach to, carriers with sufficient signal strength. If the 3G4010/LE4010 is connected to a carrier with sufficient signal strength (minimum of bottom signal strength LED on solid), it proceeds to **Step 4**.

Step 2b – SIM Card Is Not Activated





The red LED flashes, the blue LED is off and the signal strength LEDs display the average signal strength.

 Red	 Blue	 Yellow/Green (Top)	 Yellow/Green (Bottom)
FLASHING	OFF	-	-

In this state, the 3G4010/LE4010 is unable to register to the network because it is inactive. The signal strength indicated is from **any** nearby cell tower (including cellular towers belonging to non-roaming partners) and does **not** necessarily reflect the signal strength of the intended network. The 3G4010/LE4010 remains in this state until the SIM is activated. Once the SIM is activated, the 3G4010/LE4010 proceeds to **Step 2a**.

Step 3 – Carrier Scanning Due To Insufficient Signal Strength





The 3G4010/LE4010 scans the surrounding network and connects to the carrier to provide a signal strength of at least 7 CSQ. While this action is being performed, all four LEDs activate to show a scanning sequence in progress. The LEDs cycle from top to bottom and then bottom to top until the 3G4010/LE4010 connects to a carrier with a signal strength above 7 CSQ (minimum of bottom signal strength LED on solid).

 Red	 Blue	 Yellow/Green (Top)	 Yellow/Green (Bottom)
FLASH ON	OFF	OFF	OFF
OFF	FLASH ON	OFF	OFF
OFF	OFF	FLASH ON	OFF
OFF	OFF	OFF	FLASH ON
OFF	OFF	FLASH ON	OFF
OFF	FLASH ON	OFF	OFF
FLASH ON	OFF	OFF	OFF

Once this is completed, the 3G4010/LE4010 proceeds to **Step 4**.

Step 4 - Acquire C24 Communications Programming





The red LED is on solid and the blue LED flashes. The flashing blue LED indicates that the 3G4010/LE4010 has requested programming from C24 Communications and is waiting for a response.

 Red	 Blue	 Yellow/Green (Top)	 Yellow/Green (Bottom)
ON	FLASHING	-	-





Once remote programming is completed, the blue LED switches to solid and the 3G4010/LE4010 proceeds to **Step 5**.

Step 5 – Receiver Initialization





The red and blue LED's are both on solid and the signal strength LEDs are off.

 Red	 Blue	 Yellow/Green (Top)	 Yellow/Green (Bottom)
ON	ON	OFF	OFF





When the 3G4010/LE4010 sends a request to communicate with the central station, the top signal strength LED begins flashing.

 Red	 Blue	 Yellow/Green (Top)	 Yellow/Green (Bottom)
ON	ON	FLASHING	OFF





When the central station communicates back to the 3G4010/LE4010, the top signal strength LED turns on solid.

 Red	 Blue	 Yellow/Green (Top)	 Yellow/Green (Bottom)
ON	ON	ON	OFF

When the 3G4010/LE4010 sends a request to communicate to the next central station, the bottom signal strength LED begins flashing...

 Red	 Blue	 Yellow/Green (Top)	 Yellow/Green (Bottom)
ON	ON	ON	FLASHING

...and turns on solid when it receives a communication back from the central station.

 Red	 Blue	 Yellow/Green (Top)	 Yellow/Green (Bottom)
ON	ON	ON	ON

If at least one of the central stations does not respond back to the communicator, the signal strength LED corresponding to that central station turns off. Once the initialization sequence is complete, the 3G4010/LE4010 switches to steady state operation.

Step 6 - Mount the 3G4010/LE4010

1. Power down the 3G4010/LE4010 by removing the DC power source and battery leads.
2. Using the cabinet, mark the four screw locations. Drill the anchor screw holes.

Note: Check for cable conduits and water pipes before drilling.

3. Using anchor screws (not provided), mount the cabinet to the wall.
4. Run the cables through the cable entry [13] or through the cabinet knockouts.
5. Complete the connections on the terminal blocks [11].

Note: Ensure that power and Telco circuit connections are made only after the cabinet has been secured to the building or structure, and has been connected to the protective earth ground. Descriptions of the terminals can be found in the 'Connecting the 3G4010/LE4010' section.

6. Reattach the front cover [1] securely to the cabinet.

Note: Please refer to the end of this manual for wiring diagrams.

Section 4: Connecting the 3G4010/LE4010

⏚ (1) Earth Ground - This terminal must be connected to the Mains Earth, in order to comply with the Telecommunications Network Safety Standards (Overvoltage Protection Requirements).

TIP (2) / RNG (3) External Telephone Line - These terminals must be connected directly to the incoming telephone line.

T1 (4) / R1 (5) Internal Telephone Line - These terminals must be connected to the TIP and RING of the control panel.

COM (6,12) Common - This terminal is connected internally to Power Ground.

PGM1 (7), PGM2 (8), PGM3 (9), PGM4 (10) Programmable Open-collector Outputs - These outputs can be activated by programmed events. Refer to 'Activating the Outputs' for details. The maximum current sink of each output must not exceed 50mA.

AUX+ (11) Auxiliary Output - 9 to 14VDC Output, 500mA PTC Protected.

Note: Electrical current drawn from this terminal is drawn directly from the power supply. This must be added to the 3G4010/LE4010 current when determining the total draw on the host panel or power supply.

Z1-Z4 (13-14-15-16) Programmable Inputs - These terminals can be set up to trigger events. Refer to 'Inputs' for details.

DC IN ⊕ (17), ⊖ (18) Device Power Supply - These terminals must be connected to a rated power supply. If the primary supply does not include a backup battery, connect the battery leads (red and black wires, [12] in Figure 1) to a 12V, 1.2 Ah battery.





Section 5: Status LEDs

5.1 Operating Modes

The 3G4010/LE4010 features two distinct operating modes: Normal Mode and Service Mode. The unit is in Normal Mode when the cover is on (tamper is in a restored state). The unit is in Service Mode when the cover is off (a cover tamper is present).

5.1.1 Normal Mode

The 3G4010/LE4010 has four status LEDs. The following table describes the status LEDs when the communicator is in normal operating mode.

Red 	<p>This LED indicates trouble conditions.</p> <p>On (solid): Trouble Requiring Service</p> <p>1 Flash: Wireless Network Trouble</p> <p>2 Flashes: Battery Trouble</p> <p>3 Flashes: Input Power Trouble</p>
Blue 	<p>This LED indicates cellular radio activity. When on (solid), a phone line trouble condition exists. This LED turns on when the interface switches to the wireless network (due to a landline trouble condition). This LED also flashes once when the 3G4010/LE4010 transmits a signal and twice when it receives a kiss-off from the central station.</p> <p>Note: If the 3G4010/LE4010 is programmed to be the primary communicator, the blue LED remains off, but still flashes during the signal transmission as described above.</p>
Yellow/Green (Top) 	<p>This LED indicates signal strength and network technology. If the 3G4010/LE4010 is operating over a 2G channel (3G channel for LE4010), the LED is YELLOW. If the 3G4010/LE4010 is operating over a 3G channel (LTE channel for), the LED is GREEN. When this LED is On, the reception is optimal. This LED switches On only when the bottom LED is on.</p>
Yellow/Green (Bottom) 	<p>This LED indicates signal strength and network technology. If the 3G4010/LE4010 is operating in over a 2G channel (3G channel for LE4010), the LED is YELLOW. If the 3G4010/LE4010 is operating over a 3G channel (LTE channel for LE4010), the LED is GREEN.</p> <p>If this LED is Off and the Red LED is On, the Wireless Network service is unavailable (NO SERVICE). This LED flashes when the Wireless Network reception is poor. If this LED is on, the 3G4010/LE4010 is able to communicate with the 3G (HSPA) or 2G (GPRS) or LTE (LE4010) network.</p>

5.1.2 Service Mode

To view detailed trouble information on the status LEDs, the 3G4010/LE4010 must be placed in Service Mode by removing the front cover. When in Service Mode, the status LEDs indicate the trouble condition as follows.

Number of Flashes		Trouble Type
RED	BLUE	
1	OFF	Wireless network trouble - unable to connect to cellular network
2	OFF	Battery trouble - battery with low voltage output
3	OFF	Input power trouble
1	Flashing	Insufficient signal strength - poor location

2	Flashing	C24 suppressed trouble
3	Flashing	C24 communication configuration trouble
1	ON	Radio/SIM trouble - radio or SIM unresponsive
2	ON	Receiver not available trouble
3	ON	Supervision trouble
4	ON	Cover tamper is open
OFF	-	No trouble

Section 6: Operating Principles

6.1 Simulated Landline Mode

The simulated landline provides the alarm control panel (with dialer interface) with a backup line in the event of PSTN line trouble.

Note: The 3G4010/LE4010 must be programmed as a backup communicator for Simulated Landline mode to operate.

If the voltage on the landline terminals (TIP/RNG) drops below 2.8V for a period of between 10 and 45 seconds - depending on the alarm control panel connected to the T1/R1 terminals- the 3G4010/LE4010 switches the connected telephone device to the cellular network. After waiting between 30 and 40 seconds, it checks the landline for one of the following:

- If the landline has been restored, the 3G4010/LE4010 switches the connected device back to the landline, OR
- If the landline is still down, the 3G4010/LE4010 continues the simulation until the landline is restored. The 3G4010/LE4010 will not switch during ongoing calls.

Note: When the landline is down, the 3G4010/LE4010 provides a dial tone to any device connected to T1 and R1, including any telephones on the premises. The phones on the premises are not, however, able to dial out over the 3G4010/LE4010.

6.2 Panel Transmission Monitoring (PTM)

The 3G4010/LE4010 can also monitor the panel's attempt to communicate with the central station. If it determines that the panel is having difficulty, it switches the line to the cellular network. This feature is only active when the 3G4010/LE4010 is configured as a backup communicator. This feature is in addition to the regular line voltage detection.

The 3G4010/LE4010 monitors the phone line for four consecutive failed attempts within a 12-minute window. A failed attempt is assumed to have occurred when a line seizure takes place during dialing (either the alarm panel or the customer telephone), but no 1400Hz tone (Contact ID kiss-off) or 2025Hz tone (SIA kiss-off) is sent from the receiver.

Once the conditions for a failed attempt are met, the 3G4010/LE4010 connects the panel to the cellular network to communicate the events. When the 3G4010/LE4010 switches the line it stays in this mode until the panel hangs up. On the next event the 3G4010/LE4010 restarts the error detection sequence before switching. The 3G4010/LE4010 performs this sequence on any phone number that is detected on the line. Specific central station phone numbers can be programmed into the 3G4010/LE4010 if desired. Up to four, 20-digit numbers can be added to your profile at Connect 24. If programmed, the 3G4010/LE4010 only looks for a Contact ID or SIA kiss-off after these numbers are dialed. A Telephone Line Monitoring trouble (PGM output activation and/or reporting code if applicable) is also activated and/or transmitted when the PTM is activated. A restoral is sent at the end of the call.

6.3 Cellular Communications Sequence

When an alarm is triggered:

- The control panel goes off-hook.
- The 3G4010/LE4010 asserts a dial tone.
- The control panel dials the number of the central station. Ensure that the alarm panel inserts a minimum one second pause, or has Dial Tone Search enabled before dialing the number.
- The 3G4010/LE4010 detects the DTMF dialing and stops dial tone.

Note: The 3G4010/LE4010 is unable to decode pulse dialing.

If the panel is programmed for Contact ID format:

- The 3G4010/LE4010 sends the required Contact ID dual-tone handshake to the panel.
- After receiving the handshake, the control panel transmits an alarm message in Contact ID format.
- The 3G4010/LE4010 decodes and transforms the Contact ID digits into an IP packet and sends it to the central station receiver over the cellular network.
- The central station receiver acknowledges the alarm and sends a command to the 3G4010/LE4010 to generate the corresponding 1400Hz Kiss-off signal for a minimum of 800 milliseconds.

After the 3G4010/LE4010 generates a Kiss-off signal, it sends the next alarm or, if no further alarms need to be sent, the control panel goes on-hook.

If the panel is programmed for SIA (300 baud) format:

- The 3G4010/LE4010 sends the required SIA handshake to the panel.
- After receiving the handshake, the control panel transmits an alarm message in the SIA format.
- The 3G4010/LE4010 decodes and transforms the SIA events into an IP packet that it sends to the central station receiver over the cellular network.
- The central station's receiver acknowledges the alarm and sends a command to the 3G4010/LE4010 to generate the corresponding 2025Hz kiss-off signal for a minimum of one second.
- After the 3G4010/LE4010 generates a kiss-off signal, it sends the next alarm or, if no further alarms need to be sent, the control panel goes on hook.

Note: The 3G4010/LE4010 automatically adjusts the order of the handshakes based on the last format the control panel used to transmit an event.

6.4 Inputs

The 3G4010/LE4010 has four inputs that can be used to trigger specific communications. These events transmit using the Contact ID or SIA format with Inputs 1-4 reporting as [991] to [994] respectively.

Default settings are:

INPUT 1 - FIRE

INPUT 3 - BURGLARY

INPUT 2 - PANIC ALARM

INPUT 4 - SYSTEM TROUBLE

Inputs can be configured as follows:

Normally Open - input activates when a short condition is detected between the terminal and COM

Normally Closed - input activates when an open condition is detected between the terminal and COM

Single End of Line - input activates when a short or open condition is detected between the terminal and COM and restores when a 5.6Kohm resistor is detected between the terminal and COM.

Note: These inputs are programmable to communicate using either the Contact ID or SIA format.

Note: For UL/ULC installations, connections between alarm panel outputs and 3G4010/LE4010 inputs must be run in protective mechanical conduits. To reduce interference with the antenna, do not connect metal conduit to the knock-outs in the top of the cabinet.

6.5 Outputs

The 3G4010/LE4010 has four programmable outputs to activate in response to the associated events. Refer to the 3G4010/LE4010 Wiring Diagram at the back of this manual.

6.5.1 Activating the Outputs

The 3G4010/LE4010 has four open collector outputs capable of a maximum of 50mA. Internal events on the 3G4010/LE4010 can trigger the outputs to turn on an LED or activate an input on the host panel. The default settings are as follows.

OUTPUT 1: Landline Trouble - Output is normally high and switches to ground when the telephone line is down.

OUTPUT 2: Cellular Module or Network Trouble - Output is normally high and switches to ground when the 3G4010/LE4010 cannot communicate with the network.

OUTPUT 3: Power Supply or Battery Trouble - Output is normally high and switches to ground when a problem with the power source is detected.

OUTPUT 4: General Module Trouble - Output is normally low and switches to high when a Cellular Network Trouble, Power Supply/Battery Trouble, and/or a Failure to Communicate (FTC) trouble is detected.

Note: PGM4 must be connected to the control panel as shown in Figure 4 (Residential applications) or Figures 8-9 (Commercial applications). Program the control panel input Zone/Point as 24hr 'Supervisory' with keypad-only notification when activated. Output 4 on the 3G4010/LE4010 must be set as 'Active High'.

Note: Once an output has been activated automatically, it will not restore until all the causes of activation are cleared.

6.6 Reporting Codes

3G4010/LE4010 Reporting Codes	CID	SIA	Programmable	Comments
Zone 1 Activation	E11A 991	FA 991	YES	Delayed 24 Hour Fire *
Zone 1 Restoral	R11A 991	FH 991	YES	Delayed 24 Hour Fire Restore *
Zone 2 Activation	E12A 992	PA 992	YES	Panic Alarm *
Zone 2 Restoral	R12A 992	PH 992	YES	Panic Alarm Restore*
Zone 3 Activation	E13A 993	BA 993	YES	Burglary *
Zone 3 Restoral	R13A 993	BH 993	YES	Burglary Restore *
Zone 4 Activation	E3AA 994	YX 994	YES	System Trouble *
Zone 4 Restoral	R3AA 994	YZ 994	YES	System Trouble Restore *
PSTN Line Down	E351 000	LT 000	FIXED	Telco 1 Fault
PSTN Line Restoral	R351 000	LR 000	FIXED	Telco 1 Fault Restore
Input Loss	E337 000	YP 000	FIXED	Power Supply Trouble
Input Restoral	R337 000	YQ 000	FIXED	Power Supply Trouble Restore
Low Battery Alert	E338 000	YT 000	FIXED	Transmitter Battery Trouble
Low Battery Restoral	R338 000	YR 000	FIXED	Transmitter Battery Restore
Periodic Test	E603 XXX	RP XXX	FIXED	Test Transmission <Receiver Path>
Periodic Test with Trouble	E608 XXX	RY XXX	FIXED	Test Transmission <Receiver Path>
Radio Activation	R552 000	RS 000	FIXED	Remote Programming Successful
Internal Buffer Full	E624 000	JL 000	FIXED	
FTC Restoral	R354 000	YK 000	FIXED	Communications Restored
Firmware Update Successful	R901 000	LS 000	FIXED	
Firmware Update Fail	E902 000	LU 000	FIXED	
Firmware Update Begin	E901 000	LB 000	FIXED	
System Tamper	E145 000	ES 000	FIXED	Expansion Module Tamper
System Tamper Restore	R145 000	EJ 000	FIXED	Expansion Module Tamper Restore

* C24 Communications default value

6.7 Swinger Shutdown

To prevent "runaway" signals to the central station, the 3G4010/LE4010 is equipped with Swinger Shutdown which limits certain trouble events to a maximum of four reports every 24 hours. The condition restores and the counter resets at midnight. Swinger Shutdown applies to the following trouble conditions:

- System Tamper/Restore
- Low Battery Trouble/Restore
- TLM Trouble/Restore
- Input Power Trouble/Restore
- FTC Restore

6.8 Hardware Default

A hardware default updates the unit with the latest configuration from C24 Communications if:

- The device was originally programmed incorrectly.
- The unit was installed at a different location and then relocated to a new site.
- A SIM card is being swapped.

To perform a hardware default, follow these steps:





1. Power down the unit (remove primary DC power and remove the backup battery) and remove all connections to Zone1, Zone 2, PGM1 and PGM.
2. Connect a wire between Z2 (terminal 14) and PGM2 (terminal 8) or Z1 (terminal 13) and PGM1 (terminal 7).
3. Power up the radio by connecting the battery (if present) first and then primary DC power.
4. Wait for 20 seconds and then completely power down the unit.
5. Disconnect the wire between the Zone and PGM terminals.

Note: Failure to perform hardware default will result in the unit transmitting with the previously programmed configuration.



6.9 Communicator Reset/Update

The firmware of the device can be updated over Cellular or PC-Link:

- When the firmware update begins, all LED are ON.

 RED	 BLUE	 Yellow/Green (Top)	 Yellow/Green (Bottom)
ON	ON	ON	ON

- During the firmware update process the LEDs are cycled individually in a chaser pattern. (different from the Advanced Carrier Selection pattern).

 RED	 BLUE	 Yellow/Green (Top)	 Yellow/Green (Bottom)
FLASH ON	OFF	OFF	OFF
OFF	FLASH ON	OFF	OFF
OFF	OFF	FLASH ON	OFF
OFF	OFF	OFF	FLASH ON
FLASH ON	OFF	OFF	OFF
OFF	FLASH ON	OFF	OFF
OFF	OFF	FLASH ON	OFF
OFF	OFF	OFF	FLASH ON

- After a successful update, the unit automatically restarts.

Note: Several resets take place during a single Firmware update session.

Note: The unit re-requests programming after a firmware update; the version number is updated and viewable via C24 Communications.

Note: Unit must not be powered down during a Firmware update.

Note: Unit does not process remote firmware update requests if any of the following troubles is present. If the trouble occurs after the unit has processed the firmware update request, the firmware update is not interrupted.

- Input Power Trouble
- Low Battery Trouble

6.10 Low Power Radio Shutdown

When the battery voltage reaches the low battery threshold of 10.5V, the unit turns off the radio to prevent unnecessary network registrations. In this state, the unit does not communicate any events.

Radio shutdown is indicated by the LEDs as follows:

- Red LED indicates low battery trouble.
- Two green LEDs blinking on/off together indicates the radio is not ready.

This LED sequence is displayed until the low battery voltage is restored and the radio is enabled again.

6.11 SMS Command and Control

The user can remotely arm/disarm their security panel and control PGM outputs via SMS commands.

6.11.1 Arming/Disarming the Security Panel

1. Program a PGM output to Remote Arming in C24 Communications.
2. Ensure this PGM output is connected to a relay to the security panel zone.
3. Set up the zone on the security panel as momentary or maintained arming.
 - If the security panel uses momentary key switching, configure the communicator PGM with a time field of 05. In this configuration, both arm and disarm generate the pulse.
 - If the security Panel uses maintained key arming, configure the communicator PGM with a time field of 00.
4. Optionally, the panel arm state can be configured for the communicator to detect by setting a panel PGM output to reflect panel arm state and having a relay connected to a communicator zone configured to follow panel arm state.

6.11.2 Remote Control of PGM

1. Set up one or more PGM outputs to Remote Control PGM configuration. A PGM can be latched or timed:
 - setting the PGM timer to 00 causes it to be latched. The PGM will not turn off unless the turn off command is received.
 - setting the PGM timer to a value between 1 and 255 seconds causes it to be timed. The PGM activates for the programmed duration.
2. Via C24 Communications, program the phone number and access code used for SMS command and control.
 - Up to 6 different phone numbers can be programmed to perform SMS command and control.
 - The password can be 4 to 8 alphanumeric characters and is not case sensitive.

The SMS command and control can be sent in the following format:

For arming/disarming the Security Panel

Arm <access code>, example Arm 12345678

For activating/deactivating a specific PGM

Activate <PGM #> <access code>, Activate 1 12345678

The following SMS command and control operations are available:

Arming

Language	Command Label (must not be case sensitive)
English	Arm
French	Armement
Spanish	Armado

Disarming

Language	Command Label (must not be case sensitive)
English	Disarm
French	Desarmement
Spanish	Desarmado

Activate PGM

Language	Command Label (must not be case sensitive)
English	Activate
French	Activation
Spanish	Activar

Deactivate PGM

Language	Command Label (must not be case sensitive)
English	Deactivate
French	Desactivation
Spanish	Desactivar

Status Request

Language	Command Label (must not be case sensitive)
English	Status Request
French	Etat Demandé
Spanish	Petición de Estado

Invalid command is sent when no zones are programmed to read security arm status.

Help

Language	Command Label (must not be case sensitive)
English	Help
French	Aide
Spanish	Ayuda

Help displays all available commands for the selected language.

6.12 Phone Number Call Direction

The user has the ability to program the PTM phone numbers to receiver group 1 or receiver 2.

The number programmed in the communicator must also be programmed as the panel phone number. When the communicator detects the phone number, it communicates to the receivers of the corresponding group.

Note: If no PTM phone number is programmed, all panel calls go to Receiver Group 1.

6.13 C24 Communications Remote Programming

The inputs, outputs, and other features of the 3G4010/LE4010 can be remotely programmed through the C24 Communications website for fast and convenient installation using the Internet.

Note: This programming option has not been investigated by UL.

Section 7: Troubleshooting Guide

Powering up the 3G4010/LE4010 – When powering up the 3G4010/LE4010, always connect the battery (if used) first before connecting primary DC power from the control panel or transformer.

Wiring Primary – R-1/T-1 of 3G4010/LE4010 to RING/TIP of control panel, DC power from control panel or DC transformer to DC input, backup battery.

Wiring Backup – Incoming line to RING/TIP on 3G4010/LE4010, R-1/T-1 of 3G4010/LE4010 to RING/TIP of control panel, R-1/T-1 of control panel to house phones, DC power from control panel or DC transformer to DC input, backup battery.

Testing Communications – When the 3G4010/LE4010 transmits a signal for the control panel, or for an internal transmission, the BLUE light flashes once when the signal is transmitted and twice when it receives a kiss-off.

SIM – The SIM should be activated at least 24 hours prior to installation. The 3G4010/LE4010 will show signal strength with an inactive SIM; However, it will display the signal strength of any available wireless network. The SIM must be active to ensure the signal strength displayed is that of the wireless network provider for which the SIM belongs to.

Panel Programming – The control panel should be programmed to communicate Contact ID or SIA exactly the same way it would be programmed to communicate Contact ID or SIA over the telephone line.

Green/Yellow LED Status	What it means:	CSQ Values	Signal Strength Status
Both Signal Strength LEDs ON	Excellent Signal Strength	14+	<ul style="list-style-type: none"> Unit can be installed in the current mounting location.
Top LED FLASHING with bottom LED ON	Excellent Signal Strength	11-13	<ul style="list-style-type: none"> Unit can be installed in the current mounting location.
Bottom LED ON	Good Signal Strength	7-10	<ul style="list-style-type: none"> Unit can be installed in the current mounting location.
Bottom LED FLASHING	Poor Signal Strength	5-6 (no trouble) 1-4 (with trouble)	<ul style="list-style-type: none"> Ensure the antenna cable is plugged securely into the radio connector. If the SIM is active, connect a battery to the unit and test various locations for good/excellent signal strength. Connect an antenna extension kit (LTE-8ANT, LTE-15ANT, LTE-25ANT, LTE-50ANT).
Both LEDs OFF	No Signal Strength	0	<ul style="list-style-type: none"> If the red LED is also FLASHING, refer to the RED LED chart. Verify SIM card is activated. Ensure the antenna cable is plugged securely into the radio connector. If the SIM is active, connect a battery to the unit and test various locations for good/excellent signal strength. Connect an antenna extension kit (LTE-8ANT, LTE-15ANT, LTE-25ANT, LTE-50ANT).
Both LEDs Flashing ON/OFF together	Signal Strength is invalid	N/A	Radio is in process of network registration.
Both LEDs Alternating	Radio Reset Sequence	N/A	Radio is performing a Reset. If the issue persists, please verify the SIM card is inserted correctly.

# of Flashes		Trouble Type	Trouble Notes
Red	Blue		
On	On	No Signal Strength	<ul style="list-style-type: none"> • Verify SIM card is activated. • Ensure the antenna cable is plugged securely into the radio connector. • If the SIM is active, connect a battery to the unit and test various locations for good/excellent signal strength. • Connect an antenna extension kit (LTE-8ANT, LTE-15ANT, LTE-25ANT, LTE-50ANT).
1	Off	Wireless Network Trouble	<ul style="list-style-type: none"> • Ensure the SIM card has been activated. • The antenna cable should be plugged securely into the radio connector. • Ensure there is good signal strength (at least one green light ON). • Verify the installation area is not experiencing a network outage.
2	Off	Battery Trouble	<ul style="list-style-type: none"> • If a battery is not used in the installation, ensure that the "Internal Battery Connected" is not selected in C24 Communications. • If a battery is used in the installation, verify the battery is connected properly • Measure the battery under load and verify it is charged to at least 12.5VDC. If not, wait at least 1 hour for the battery to charge. • Remove the battery and measure the voltage; the voltage should be at least 12VDC. • Verify the input DC supply is rated at 13.8VDC @ 180mA minimum. • Replace battery
3	Off	Input Power Trouble	<ul style="list-style-type: none"> • Ensure the power source connected to the 3G4010/LE4010 is providing 13.8VDC @ 180mA.
1	Flash	Insufficient Signal Strength	<ul style="list-style-type: none"> • Ensure the antenna cable is plugged securely into the radio connector. • If the SIM is active, connect a battery to the unit and test various locations for good/excellent signal strength. • Connect an antenna extension kit (LTE-8ANT, LTE-15ANT, LTE-25ANT, LTE-50ANT)
2	Flash	Not Used	
3	Flash	C24 Communications Configurations Trouble	<ul style="list-style-type: none"> • Ensure the SIM card is activated and correctly initialized through C24 Communications.
1	On	Radio/SIM Trouble	<ul style="list-style-type: none"> • Ensure the SIM Card is inserted correctly and firmly. • Ensure the antenna cable is plugged securely into the radio connector.
2	On	Receiver Not Available Trouble	<ul style="list-style-type: none"> • Contact the monitoring station to verify that the 3G4010/LE4010 programming is correct (port, IP address, DNIS). • Contact your central station to verify they are not experiencing any receiver issues.
3	On	Supervision Trouble	<ul style="list-style-type: none"> • Contact your central station to verify they are not experiencing any receiver issues.
4	On	Tamper Trouble	<ul style="list-style-type: none"> • Ensure the front cover is secured and the case tamper is closed.

The Red light will flash to indicate various trouble conditions outlined previously. If multiple trouble conditions are present, the red light will flash according to the highest priority trouble. For example, if both a 3G4010/LE4010 wireless network trouble (one flash) and a low battery trouble (two flashes) are present; the red light will flash one time. Once the 3G4010/LE4010 wireless network trouble condition is corrected, the red light will then begin flashing two times.

General Troubles With Your System	
The control panel is displaying a telephone line trouble condition	<ul style="list-style-type: none"> • Ensure T1 and R1 of the 3G4010/LE4010 are wired to the TIP and RING terminals of the control panel. • If the 3G4010/LE4010 is being used as the primary communicator, the blue light will always be OFF. • If the 3G4010/LE4010 red light is FLASHING, refer to the troubleshooting chart in this guide.
The control panel displays a communication trouble condition	<ul style="list-style-type: none"> • Ensure the panel is programmed for Contact ID or SIA. • Ensure the control panel does not indicate a TLM trouble condition. • If the 3G4010/LE4010 red light is FLASHING refer to the troubleshooting chart in this guide.
No signals are received at the central station but no trouble condition is displayed	<ul style="list-style-type: none"> • Ensure the control panel has a central station phone number programmed. • Ensure the control panel has the correct account number programmed. • Verify the reporting codes are programmed or the auto Contact ID option is enabled. • Ensure the control panel communicator is enabled. • Connect a handset to T1 and R1 of the 3G4010/LE4010 in monitor mode to verify the control panel is trying to communicate.
Not receiving internal signals generated directly from the 3G4010/LE4010	<ul style="list-style-type: none"> • Ensure the 3G4010/LE4010 was initialized with the correct account number. This can be checked by logging into the C24 Communications website. • Ensure that no trouble conditions are present on the 3G4010/LE4010.
The phone line is seized when the 3G4010/LE4010 is connected	<ul style="list-style-type: none"> • Verify correct phone line wiring. • Ensure the Ringer Equivalency Number (REN) is not being exceeded on the line.

General Information	
Removing/Connecting the antenna	<ul style="list-style-type: none"> • To remove the antenna from the 3G4010/LE4010, place your thumb on the end of the connector at the modem, then place a screwdriver between the modem and connector. Gently turn the screwdriver away to 'pop' out the connector from the modem. • To install the antenna, firmly push the connector into the modem until it 'snaps' into place.
Enrolling a 3G4010/LE4010	<ul style="list-style-type: none"> • The 3G4010/LE4010 can be enrolled by going through the GVRU voice prompt, and completing the activation of the SIM card, and the initialization of the 3G4010/LE4010. • The 3G4010/LE4010 can also be enrolled using the C24 Communications website (www.connect24.com) or the C24 Communications mobile site (m.connect24.com).
SIM card activation period	<ul style="list-style-type: none"> • A SIM card can take up to 24 hours to be activated by the provider. However, it typically takes less than an hour for the SIM card to be activated.
Checking SIM status	<ul style="list-style-type: none"> • Go to www.connect24.com and login. A search can be performed for a specific account and its current status • SIM status can also be checked through the GVRU.
Critical Shutdown on 3G4010/LE4010 backup battery (with no DC input applied)	<ul style="list-style-type: none"> • If the 3G4010/LE4010 backup battery is used and is below 10.5VDC, the unit will go into critical shutdown. • The critical shutdown state will be displayed by the red light flashing followed by the blue and two green lights flashing. • The lights will continue to flash in this sequence until the battery is charged above 12.4VDC.

Swinger Shutdown for 3G4010/LE4010 Troubles	<ul style="list-style-type: none">• Trouble events can send a maximum of 4 troubles and restorals per day.• Swinger Shutdown only affects signal transmissions, not the functionality of the 3G4010/LE4010 lights or PGM outputs.• Swinger shutdown is reset at midnight or upon a full power cycle of the 3G4010/LE4010.
--	---

Test this product at least once a year.

7.1 LE4010 IM Wiring Diagrams

Figure 10-1 Wiring Diagram

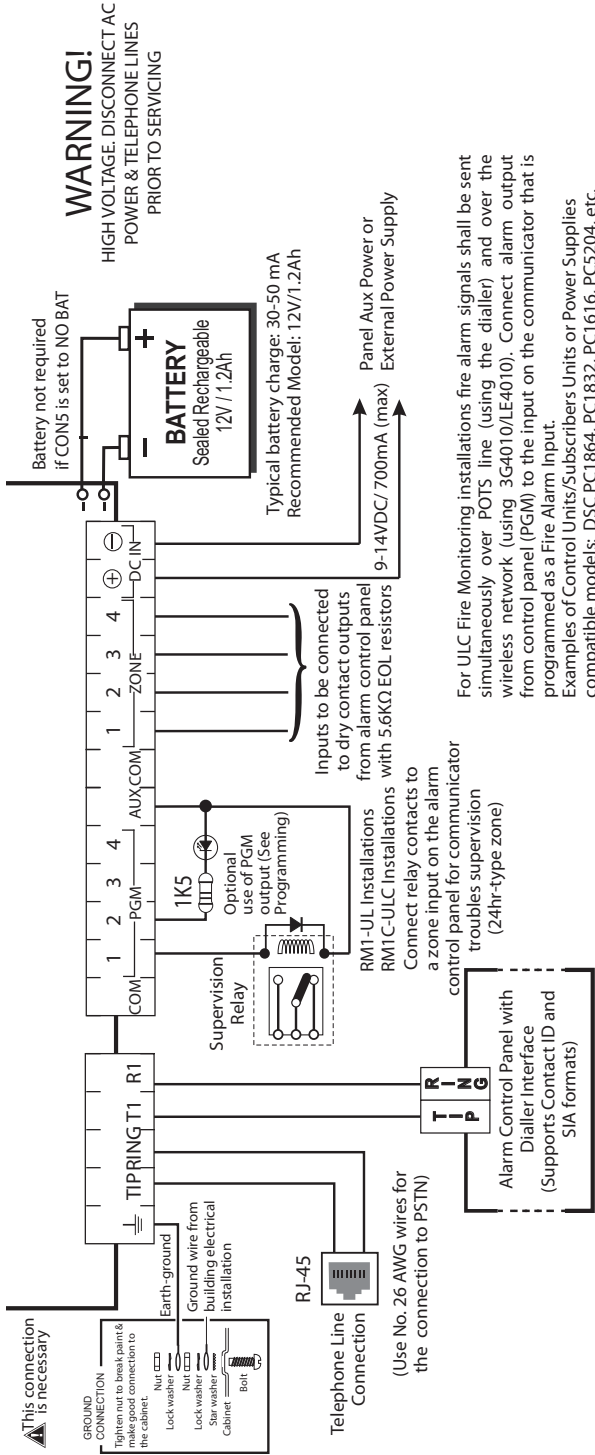

WARNING: Incorrect connections may result in PTC failure or improper operation. Inspect wiring and ensure connections are correct before turning on. All circuits are classified for UL installations as Power Limited/Class II Power Limited except for the battery leads which are not Power Limited. Do not route any wiring over circuit boards. Maintain at least 1" (25.4mm) separation. A minimum 1/4" (6.4mm) separation must be maintained at all points between Power Limited wiring and all other Non-Power Limited wiring. Route wires as indicated in the diagram.

For UL Installations, the system shall be installed in accordance with chapter 2 of the ANSI/NFPA 72 and ANSI/NFPA 70. Recommended locations and wiring methods shall be in accordance with the National Electrical Code, ANSI/NFPA 70, the Standard for Installation and Classification of Burglar and Holdup Alarm Systems, UL 681, and the Standard for Central-Station Alarm Services, UL 827.

For ULC Installations, the recommended locations and wiring methods shall be in accordance with CSA C22.1, Canadian Electrical Code, Part I, Safety Standard for Electrical Installations; CAN/ULC-S302, Installation and Classification of Burglar Alarm Systems for Financial and Commercial Premises, Safes and Vaults; and CAN/ULC-S301, Standard for Central and Monitoring Station Burglar Alarm Systems and the Standard for the Installation of Residential Fire Warning Systems, CAN/ULC-S540. Do not install the equipment in places where the signal strength does not meet the minimum recommended signal strength level. Do not run zone inputs and T1/R1 wiring along AC wires or other circuits with high frequency signals in order to reduce possibility of interference and false alarms.

Figure 10-2 Telephone Connection

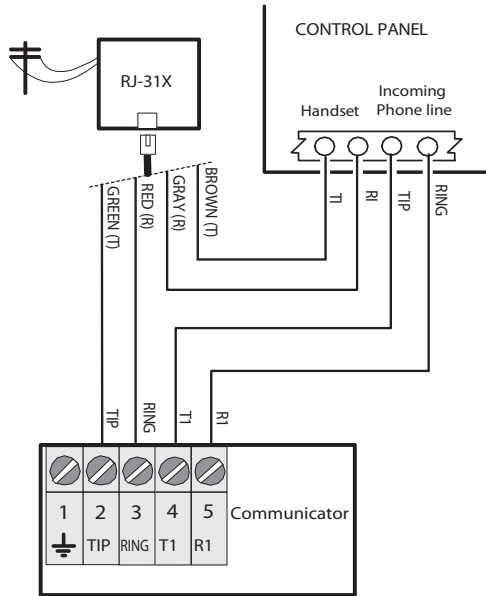
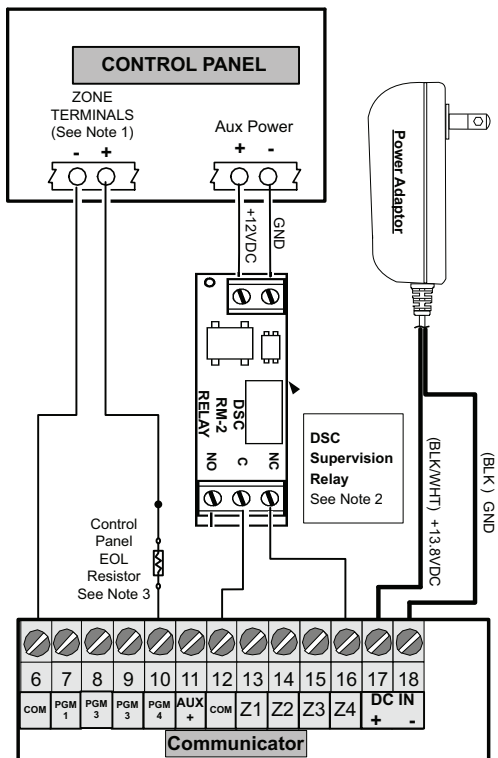

Figure 10-3 Power Supply and Supervision Wiring Diagram



Notes:

1. Program the zone/point as “Supervisory” type with keypad-only announcement when in alarm. Do NOT use a zone/point that is normally used for 2-wire smoke detectors.
2. The power supervision relay (RM-2) is only used when the 3G4010/LE4010 is not powered by the control panel. The relay is not required since a loss of input power will generate a signal to the CMC.
3. Output 4 on the 3G4010/LE4010 must be set as “Active High” (default).
4. This equipment has no mains on/off switch. The plug of the direct plug-in power supply is intended to serve as the disconnecting method if the equipment must be quickly disconnected. Ensure that access to the mains plug and associated mains socket/outlet is never obstructed.

The following wiring diagrams are examples of ULC Listed Fire Monitoring Installation connections.

Figure 10-4 Wiring Diagram for Fire Alarm Control Unit (with dialler) and Cellular Transmitter (Passive Communication System)

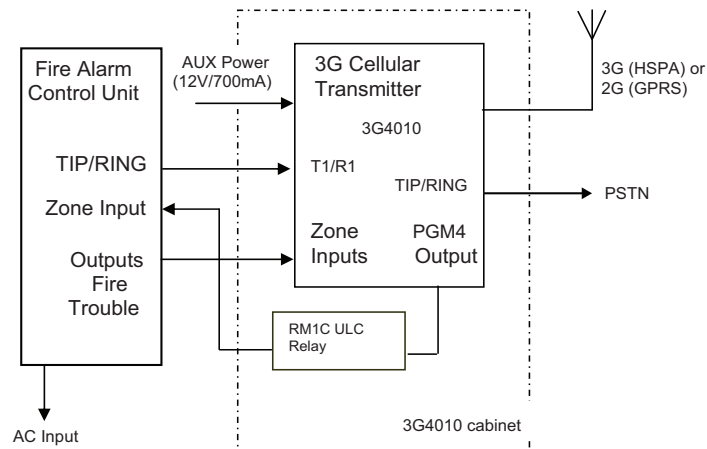

Notes:

- Power for the 3G4010/LE4010 shall be provided from the Fire Alarm Control Unit or separately listed power supply rated for the application (12V/700mA).
- All wiring connections must be run in a protective conduit.
- For local supervision of the wireless transmitter, connect PGM output from 3G4010/LE4010 to one zone input on the Fire Alarm Control Unit.
- Dry Contact Trouble output from ULC Listed Fire Alarm Control Unit must be connected to zone input on the 3G4010/LE4010 for supervision of Tip/Ring connection.
- Fire Alarms must be sent over both communication channels. Fire output from Fire Alarm Control Unit must be connected to input 1 on the 3G4010/LE4010.
- 24 hour Test Transmission must be enabled on the dialler and on the 3G4010/LE4010.

Figure 10-5 DSC Subscribers' Unit Fire and Cellular Transmitter Mounted in the Same Room

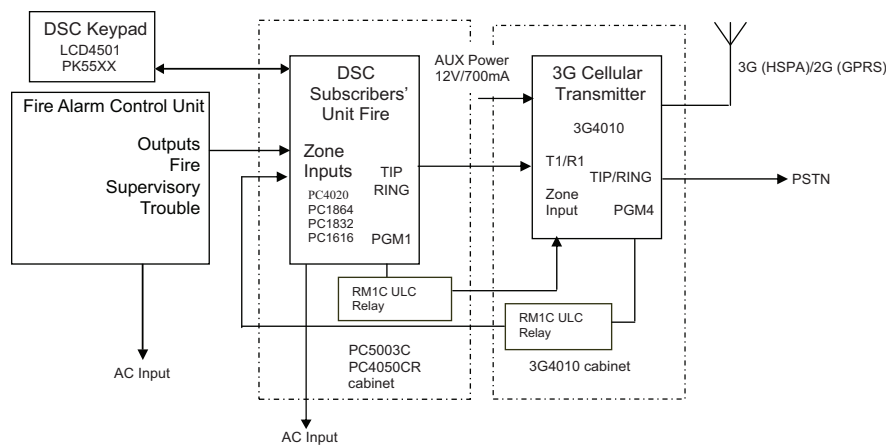

Notes:

- Power for 3G4010/LE4010 must be provided from Fire Alarm Control Unit or separately listed power supply rated for the application (12V/700mA).
- All wiring connections must be run in a protective conduit.
- Phone Line Monitoring (TLM) must be enabled.
- Phone Line trouble is indicated by the Blue LED on the 3G4010/LE4010.

- Connect PGM4 output from the 3G4010/LE4010 (Trouble Conditions) to a zone input on the Subscriber Unit for supervision of the GSM Transmitter.
- 24hour Test Transmission over phone line (PSTN) and 3G4010/LE4010 must be enabled.
- Fire Alarm must be sent over both communication channels.
- On the Subscribers' Unit, program PGM1 for PC1616/PC1832/PC1864 as System Event (Section [009] as type 10; Section [501] Fire Event option 2 ON). An alternate option is to program PGM1 as Zone Follower (Section [009] = 29) and assign Fire Zone to PGM1 in Section [551]. Ensure Bit 3 is on in [501]. In this case, a restored fire alarm condition does not require the DSC control panel to be reset. For PC4020, program PGM1 as type 49 Steady Fire ([00070049]).
- Dry contact outputs from ULC Listed Fire Alarm Control Unit must be connected to zone inputs on the ULC Listed DSC subscribers' Unit Fire.
- Refer to detailed diagrams.

Figure 10-6 DSC Subscribers' Unit Fire and 3G Cellular Transmitter Mounted Remotely
Alternate Wiring Diagram for DSC Subscribers' Unit Fire and Cellular Transmitter Passive Communication System - Using Phone Line Supervision Relay

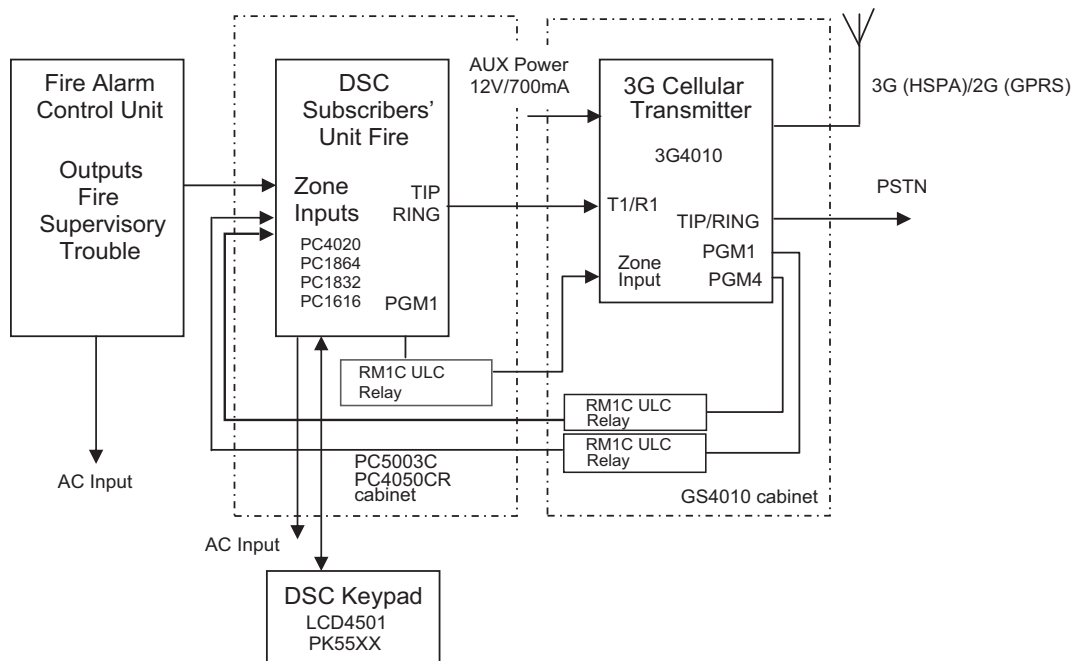

PLEASE NOTE THAT EITHER RM1C ULC OR RM2 RELAYS CAN BE USED FOR ULC INSTALLATIONS

Notes:

- Connect PGM output from the 3G4010/LE4010 (Phone Line Trouble) to a zone input on the subscriber unit for supervision of the phone line voltage.
- When the 3G4010/LE4010 is installed remotely from the DSC Control Panel, the Phone Line Trouble condition must be monitored at the keypad using an additional RM1C relay.

Figure 10-7 Connection Details for Cellular Network Supervision Relay and Redundant Fire Alarm Transmission

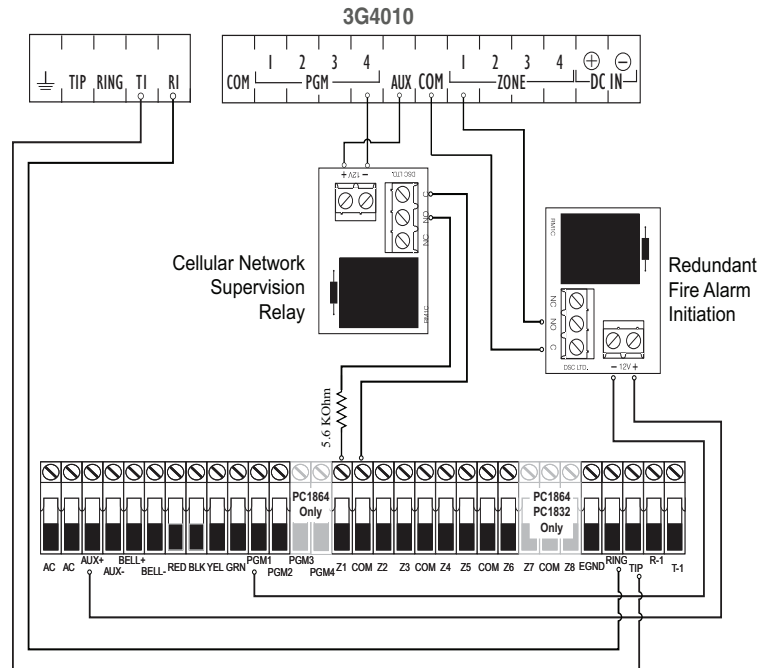

Note: Use EOL resistor in series with N.O. contacts of the relay connected to PGM4.

Figure 10-8 Connection Details for Cellular Network Supervision Relay and Redundant Fire Alarm Transmission

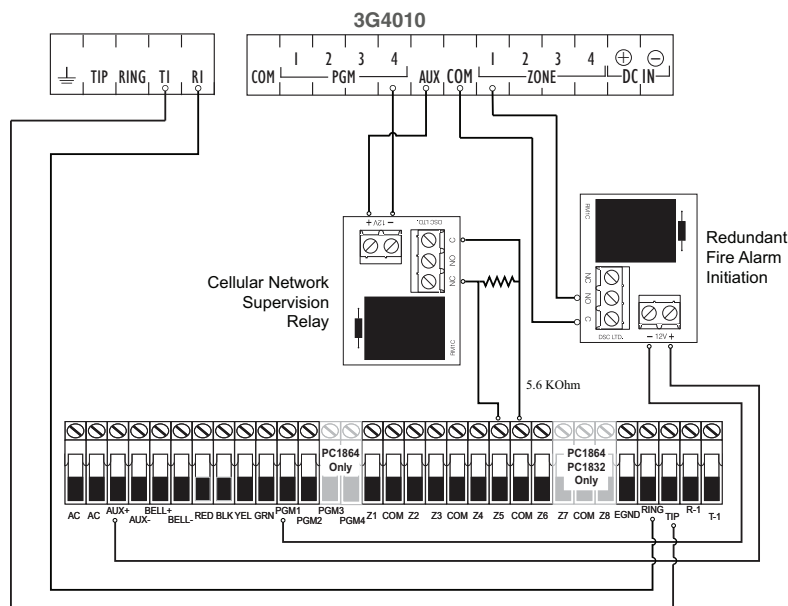

Note: Use EOL resistor in parallel with N.O. contacts of the relay connected to PGM4.

Figure 10-9 Connection Details for GSM Supervision Relay, Phone Line Supervision and Redundant Fire Alarm Transmission

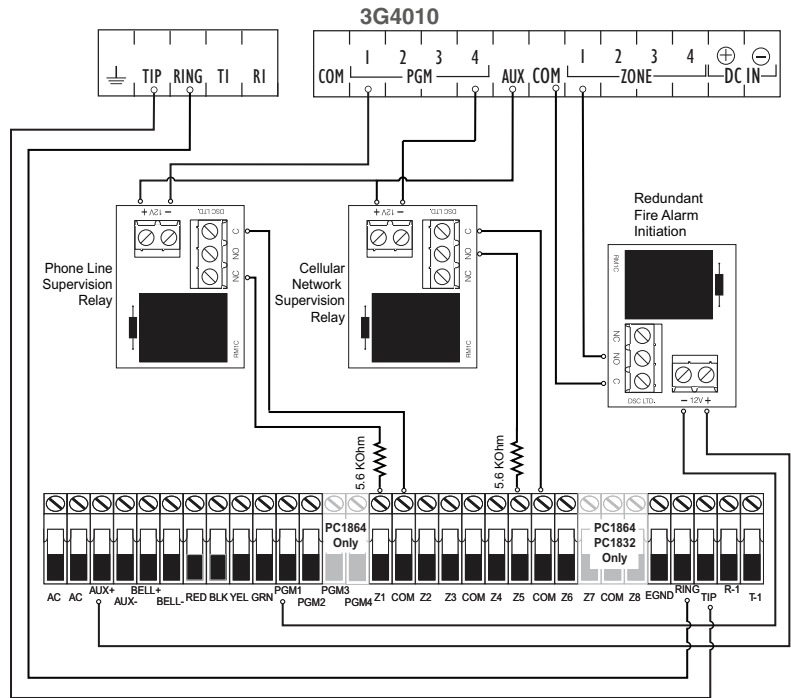

Note: Use EOL resistor in series with N.O. contacts of the relay connected to PGM4.

Figure 10-10 Connection Details for Cellular Network Supervision Relay, Phone Line Supervision Relay and Redundant Fire Alarm Transmission

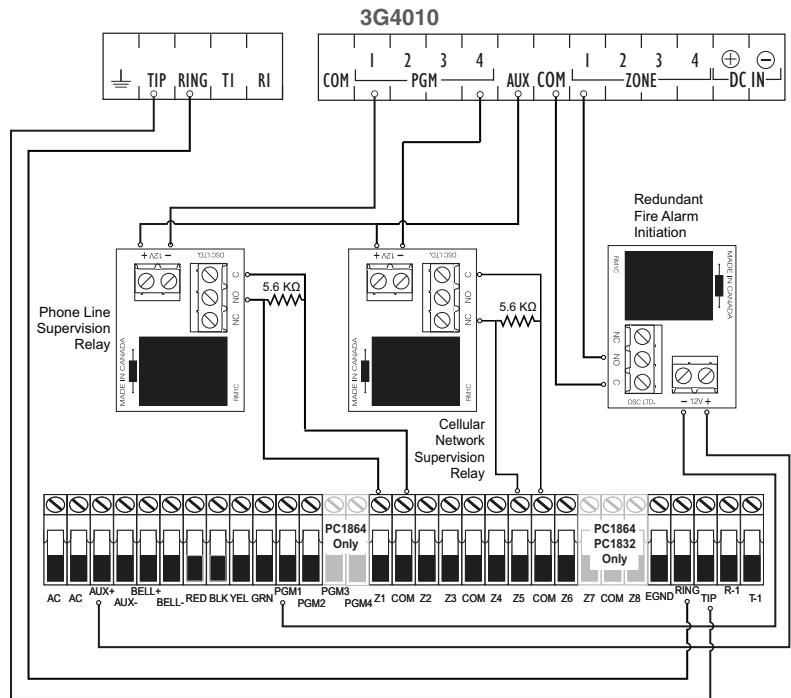

Note: Use EOL resistor in parallel with N.O. contacts of the relay connected to PGM4.

EULA

IMPORTANT - READ CAREFULLY: DSC Software purchased with or without Products and Components is copyrighted and is purchased under the following license terms:

This End-User License Agreement (“EULA”) is a legal agreement between You (the company, individual or entity who acquired the Software and any related Hardware) and Digital Security Controls, a division of Tyco Safety Products Canada Ltd. (“DSC”), the manufacturer of the integrated security systems and the developer of the software and any related products or components (“HARDWARE”) which You acquired.

If the DSC software product (“SOFTWARE PRODUCT” or “SOFTWARE”) is intended to be accompanied by HARDWARE, and is NOT accompanied by new HARDWARE, You may not use, copy or install the SOFTWARE PRODUCT. The SOFTWARE PRODUCT includes computer software, and may include associated media, printed materials, and “online” or electronic documentation.

Any software provided along with the SOFTWARE PRODUCT that is associated with a separate end-user license agreement is licensed to You under the terms of that license agreement.

By installing, copying, downloading, storing, accessing or otherwise using the SOFTWARE PRODUCT, You agree unconditionally to be bound by the terms of this EULA, even if this EULA is deemed to be a modification of any previous arrangement or contract. If You do not agree to the terms of this EULA, DSC is unwilling to license the SOFTWARE PRODUCT to You, and You have no right to use it.

SOFTWARE PRODUCT LICENSE

The SOFTWARE PRODUCT is protected by copyright laws and international copyright treaties, as well as other intellectual property laws and treaties. The SOFTWARE PRODUCT is licensed, not sold.

1. GRANT OF LICENSE This EULA grants You the following rights:

Software Installation and Use - For each license You acquire, You may have only one copy of the SOFTWARE PRODUCT installed.

Storage/Network Use - The SOFTWARE PRODUCT may not be installed, accessed, displayed, run, shared or used concurrently on or from different computers, including a workstation, terminal or other digital electronic device (“Device”). In other words, if You have several workstations, You will have to acquire a license for each workstation where the SOFTWARE will be used.

Backup Copy - You may make back-up copies of the SOFTWARE PRODUCT, but You may only have one copy per license installed at any given time. You may use the back-up copy solely for archival purposes. Except as expressly provided in this EULA, You may not otherwise make copies of the SOFTWARE PRODUCT, including the printed materials accompanying the SOFTWARE.

2. DESCRIPTION OF OTHER RIGHTS AND LIMITATIONS

Limitations on Reverse Engineering, Decompilation and Disassembly - You may not reverse engineer, decompile, or disassemble the SOFTWARE PRODUCT, except and only to the extent that such activity is expressly permitted by applicable law notwithstanding this limitation. You may not make any changes or modifications to the Software, without the written permission of an officer of DSC. You may not remove any proprietary notices, marks or labels from the Software Product. You shall institute reasonable measures to ensure compliance with the terms and conditions of this EULA.

Separation of Components - The SOFTWARE PRODUCT is licensed as a single product. Its component parts may not be separated for use on more than one HARDWARE unit.

Single INTEGRATED PRODUCT - If You acquired this SOFTWARE with HARDWARE, then the SOFTWARE PRODUCT is licensed with the HARDWARE as a single integrated product. In this case, the SOFTWARE PRODUCT may only be used with the HARDWARE as set forth in this EULA.

Rental - You may not rent, lease or lend the SOFTWARE PRODUCT. You may not make it available to others or post it on a server or web site.

Software Product Transfer - You may transfer all of Your rights under this EULA only as part of a permanent sale or transfer of the HARDWARE, provided You retain no copies, You transfer all of the SOFTWARE PRODUCT (including all component parts, the media and printed materials, any upgrades and this EULA), and provided the recipient agrees to the terms of this EULA. If the SOFTWARE PRODUCT is an upgrade, any transfer must also include all prior versions of the SOFTWARE PRODUCT.

Termination - Without prejudice to any other rights, DSC may terminate this EULA if You fail to comply with the terms and conditions of this EULA. In such event, You must destroy all copies of the SOFTWARE PRODUCT and all of its component parts.

Trademarks - This EULA does not grant You any rights in connection with any trademarks or service marks of DSC or its suppliers.

3. COPYRIGHT

All title and intellectual property rights in and to the SOFTWARE PRODUCT (including but not limited to any images, photographs, and text incorporated into the SOFTWARE PRODUCT), the accompanying printed materials, and any copies of the SOFTWARE PRODUCT, are owned by DSC or its suppliers. You may not copy the printed materials accompanying the SOFTWARE PRODUCT. All title and intellectual property rights in and to the content which may be accessed through use of the SOFTWARE PRODUCT are the property of the respective content owner and may be protected by applicable copyright or other intellectual property laws and treaties. This EULA grants You no rights to use such content. All rights not expressly granted under this EULA are reserved by DSC and its suppliers.

EXPORT RESTRICTIONS - You agree that You will not export or re-export the SOFTWARE PRODUCT to any country, person, or entity subject to Canadian export restrictions.

CHOICE OF LAW - This Software License Agreement is governed by the laws of the Province of Ontario, Canada.

ARBITRATION - All disputes arising in connection with this Agreement shall be determined by final and binding arbitration in accordance with the Arbitration Act, and the parties agree to be bound by the arbitrator’s decision. The place of arbitration shall be Toronto, Canada, and the language of the arbitration shall be English.

LIMITED WARRANTY

NO WARRANTY - DSC PROVIDES THE SOFTWARE “AS IS” WITHOUT WARRANTY. DSC DOES NOT WARRANT THAT THE SOFTWARE WILL MEET YOUR REQUIREMENTS OR THAT OPERATION OF THE SOFTWARE WILL BE UNINTERRUPTED OR ERROR-FREE.

CHANGES IN OPERATING ENVIRONMENT - DSC shall not be responsible for problems caused by changes in the operating characteristics of the HARDWARE, or for problems in the interaction of the SOFTWARE PRODUCT with non-DSC-SOFTWARE or HARDWARE PRODUCTS.

LIMITATION OF LIABILITY; WARRANTY REFLECTS ALLOCATION OF RISK - IN ANY EVENT, IF ANY STATUTE IMPLIES WARRANTIES OR CONDITIONS NOT STATED IN THIS LICENSE AGREEMENT, DSC’S ENTIRE LIABILITY UNDER ANY PROVISION OF THIS LICENSE AGREEMENT SHALL BE LIMITED TO THE GREATER OF THE AMOUNT ACTUALLY PAID BY YOU TO LICENSE THE SOFTWARE PRODUCT AND FIVE CANADIAN DOLLARS (CAD\$5.00). BECAUSE SOME JURISDICTIONS DO NOT ALLOW THE EXCLUSION OR LIMITATION OF LIABILITY FOR CONSEQUENTIAL OR INCIDENTAL DAMAGES, THE ABOVE LIMITATION MAY NOT APPLY TO YOU.

DISCLAIMER OF WARRANTIES - THIS WARRANTY CONTAINS THE ENTIRE WARRANTY AND SHALL BE IN LIEU OF ANY AND ALL OTHER WARRANTIES, WHETHER EXPRESSED OR IMPLIED (INCLUDING ALL IMPLIED WARRANTIES OF MERCHANTABILITY OR FITNESS FOR A PARTICULAR PURPOSE) AND OF ALL OTHER OBLIGATIONS OR LIABILITIES ON THE PART OF DSC. DSC MAKES NO OTHER WARRANTIES. DSC NEITHER ASSUMES NOR AUTHORIZES ANY OTHER PERSON PURPORTING TO ACT ON ITS BEHALF TO MODIFY OR TO CHANGE THIS WARRANTY, NOR TO ASSUME FOR IT ANY OTHER WARRANTY OR LIABILITY CONCERNING THIS SOFTWARE PRODUCT.

EXCLUSIVE REMEDY AND LIMITATION OF WARRANTY - UNDER NO CIRCUMSTANCES SHALL DSC BE LIABLE FOR ANY SPECIAL, INCIDENTAL, CONSEQUENTIAL OR INDIRECT DAMAGES BASED UPON BREACH OF WARRANTY, BREACH OF CONTRACT, NEGLIGENCE, STRICT LIABILITY, OR ANY OTHER LEGAL THEORY. SUCH DAMAGES INCLUDE, BUT ARE NOT LIMITED TO, LOSS OF PROFITS, LOSS OF THE SOFTWARE PRODUCT OR ANY ASSOCIATED EQUIPMENT, COST OF CAPITAL, COST OF SUBSTITUTE OR REPLACEMENT EQUIPMENT, FACILITIES OR SERVICES, DOWN TIME, PURCHASERS TIME, THE CLAIMS OF THIRD PARTIES, INCLUDING CUSTOMERS, AND INJURY TO PROPERTY.

DSC recommends that the entire system be completely tested on a regular basis. However, despite frequent testing, and due to, but not limited to, criminal tampering or electrical disruption, it is possible for this SOFTWARE PRODUCT to fail to perform as expected.

Regulatory Information

Modification Statement

Digital Security Controls has not approved any changes or modifications to this device by the user. Any changes or modifications could void the user's authority to operate the equipment.

Digital Security Controls n'approuve aucune modification apportée à l'appareil par l'utilisateur, quelle qu'en soit la nature. Tout changement ou modification peuvent annuler le droit d'utilisation de l'appareil par l'utilisateur.

Interference Statement

This device complies with Part 15 of the FCC Rules and ISED Canada licence-exempt RSS standard(s). Operation is subject to the following two conditions: (1) this device may not cause interference, and (2) this device must accept any interference, including interference that may cause undesired operation of the device.

Le présent appareil est conforme aux CNR d'ISED Canada applicables aux appareils radio exempts de licence. L'exploitation est autorisée aux deux conditions suivantes : (1) l'appareil ne doit pas produire de brouillage, et (2) l'utilisateur de l'appareil doit accepter tout brouillage radioélectrique subi, même si le brouillage est susceptible d'en compromettre le fonctionnement.

Wireless Notice

This equipment complies with FCC and IC radiation exposure limits set forth for an uncontrolled environment. The antenna should be installed and operated with minimum distance of 20 cm between the radiator and your body. This transmitter must not be co-located or operating in conjunction with any other antenna or transmitter. Cet appareil est conforme aux limites d'exposition aux rayonnements de la IC pour un environnement non contrôlé. L'antenne doit être installée de façon à garder une distance minimale de 20 centimètres entre la source de rayonnements et votre corps. L'émetteur ne doit pas être colocalisé ni fonctionner conjointement avec à autre antenne ou autre émetteur.

Antenna gain must be below/Gain de l'antenne doit être ci-dessous:

Frequency Band/Bande de fréquence	3G4010; 3G4010CF	LE4010; LE4010CF
GSM 850 / FDD V	6.21 dBi	6.21 dBi
PCS 1900 / FDD II	3.76 dBi	3.76 dB
LTEB2	—	2.76 dBi
LTEB4	—	2.82 dBi
LTEB5/B12/B13	—	2.45 dBi

FCC Class B Digital Device Notice

This equipment has been tested and found to comply with the limits for a Class B digital device, pursuant to part 15 of the FCC Rules. These limits are designed to provide reasonable protection against harmful interference in a residential installation. This equipment generates uses and can radiate radio frequency energy and, if not installed and used in accordance with the instructions, may cause harmful interference to radio communications. However, there is no guarantee that interference will not occur in a particular installation. If this equipment does cause harmful interference to radio or television reception, which can be determined by turning the equipment off and on, the user is encouraged to try to correct the interference by one or more of the following measures:

- Reorient or relocate the receiving antenna.
- Increase the separation between the equipment and receiver.
- Connect the equipment into an outlet on a circuit different from that to which the receiver is connected.
- Consult the dealer or an experienced radio/TV technician for help.

3G4010:

FCC ID: F53173G4010

3G4010 Product Identifier US: F5317M000A3G4010

LE4010:

FCC ID: F5317LE4010

LE4010 Product Identifier US: F5317M000ALE4010

REN: 0.0B

USOC Jack: RJ-31X

WARNING: To satisfy FCC RF exposure requirements for mobile transmitting devices, a separation distance of 20cm or more must be maintained between the antenna of this device and persons during device operation.

Telephone Connection Requirements

A plug and jack used to connect this equipment to the premises wiring and telephone network must comply with the applicable FCC Part 68 rules and requirements adopted by the ACTA. A compliant telephone cord and modular plug is provided with this product. It is designed to be connected to a compatible modular jack that is also compliant. See installation instructions for details.

Ringer Equivalence Number (REN)

The REN is used to determine the number of devices that may be connected to a telephone line. Excessive RENs on a telephone line may result in the devices not ringing in response to an incoming call.

In most but not all areas, the sum of RENs should not exceed five (5.0). To be certain of the number of devices that may be connected to a line, as determined by the total RENs, contact the local Telephone Company. For products approved after July 23, 2001, the REN for this product is part of the product identifier that has the format. US: AAAEQ##TXXXX. The digits represented by ## are the REN without a decimal point (e.g., 03 is a REN of 0.3). For earlier products, the REN is separately shown on the label.

Incidence of Harm

If this equipment 3G4010/LE4010 causes harm to the telephone network, the telephone company will notify you in advance that temporary discontinuance of service may be required. But if advance notice is not practical, the Telephone Company will notify the customer as soon as possible. Also, you will be advised of your right to file a complaint with the FCC if you believe it is necessary.

Changes in Telephone Company Equipment or Facilities

The Telephone Company may make changes in its facilities, equipment, operations or procedures that could affect the operation of the equipment. If this happens the Telephone Company will provide advance notice in order for you to make necessary modifications to maintain uninterrupted service.

Equipment Maintenance Facility

If trouble is experienced with this equipment for repair or warranty information, please contact the facility indicated below. If the equipment is causing harm to the telephone network, the Telephone Company may request that you disconnect the equipment until the problem is solved. This equipment is of a type that is not intended to be repaired by the end user.

DSC c/o APL Logistics, 2600 West Pointe Dr., Lithia Springs, GA 30122

Additional Information

Connection to party line service is subject to state tariffs. Contact the state public utility commission, public service commission or corporation commission for information. Alarm dialling equipment must be able to seize the telephone line and place a call in an emergency situation. It must be able to do this even if other equipment (telephone, answering system, computer modem, etc.) already has the telephone line in use. To do so, alarm dialling equipment must be connected to a properly installed RJ-31X jack that is electrically in series with and ahead of all other equipment attached to the same telephone line. Proper installation is depicted in the figure below. If you have any questions concerning these instructions, you should consult your telephone company or a qualified installer about installing the RJ-31X jack and alarm dialling equipment for you.

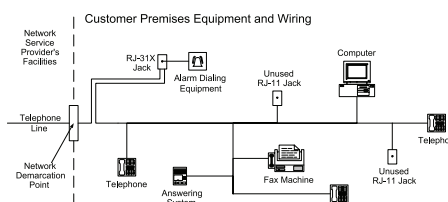

Industry Canada Compliance Statement

This Equipment meets the applicable Industrial, Scientific and Economic Development (ISED) Terminal Equipment Technical Specifications. This is confirmed by the registration number. The abbreviation, IC, before the registration number signifies that registration was performed based on a Declaration of Conformity indicating that ISED Canada technical specifications were met. It does not imply that that ISED Canada approved the equipment. The Ringer Equivalence Number (REN) for this terminal equipment is 0.0. The REN assigned to each terminal equipment provides an indication of the maximum number of terminals allowed to be connected to a telephone interface. The termination on an interface may consist of any combination of devices subject only to the requirement that the sum of the Ringer Equivalence Numbers of all devices does not exceed 5.

IC:160A-3G4010

IC:160A-LE4010

Cet équipement est conforme aux spécifications techniques applicables aux équipements terminaux d'ISED Canada. Ceci est confirmé par le numéro d'enregistrement. L'abréviation IC précédant le numéro d'enregistrement signifie que l'enregistrement a été effectué sur la base de la Déclaration de conformité indiquant que le produit est conforme aux spécifications techniques d'ISED Canada. Ceci n'implique pas que le produit ait été approuvé par Industrie Canada.

Le nombre équivalent de sonneries (REN) de cet appareil terminal est 0.0. Le REN attribué à chaque équipement terminal fournit une indication sur le nombre maximum de terminaux pouvant être connectés sur une interface téléphonique. La terminaison sur une interface peut constituer en n'importe quelle combinaison d'appareils, à la condition seulement que la somme des Nombres équivalents de sonneries de tous les appareils ne soit pas supérieure à 5.

This Class B digital apparatus meets all requirements of the Canadian interference-causing equipment regulations. Cet appareil numérique de la Classe B respecte toutes les exigences de règlement sur le matériel brouilleur du Canada.

CAN ICES-3 (B) / NMB-3 (B)

The term "IC:" before the radio certification number only signifies that ISED Canada technical specifications were met.

NIST Validation of encryption algorithm AES128 certificate No. xxxx

Warranty

Digital Security Controls warrants the original purchaser that for a period of twelve months from the date of purchase, the product shall be free of defects in materials and workmanship under normal use. During the warranty period, Digital Security Controls shall, at its option, repair or replace any defective product upon return of the product to its factory, at no charge for labour and materials. Any replacement and/or repaired parts are warranted for the remainder of the original warranty or ninety (90) days, whichever is longer. The original purchaser must promptly notify Digital Security Controls in writing that there is defect in material or workmanship, such written notice to be received in all events prior to expiration of the warranty period. There is absolutely no warranty on software and all software products are sold as a user license under the terms of the software license agreement included with the product. The Customer assumes all responsibility for the proper selection, installation, operation and maintenance of any products purchased from DSC. Custom products are only warranted to the extent that they do not function upon delivery. In such cases, DSC can replace or credit at its option.

International Warranty

The warranty for international customers is the same as for any customer within Canada and the United States, with the exception that Digital Security Controls shall not be responsible for any customs fees, taxes, or VAT that may be due.

Warranty Procedure

To obtain service under this warranty, please return the item(s) in question to the point of purchase. All authorized distributors and dealers have a warranty program. Anyone returning goods to Digital Security Controls must first obtain an authorization number. Digital Security Controls will not accept any shipment whatsoever for which prior authorization has not been obtained.

Conditions to Void Warranty

This warranty applies only to defects in parts and workmanship relating to normal use. It does not cover:

- damage incurred in shipping or handling;
- damage caused by disaster such as fire, flood, wind, earthquake or lightning;

- damage due to causes beyond the control of Digital Security Controls such as excessive voltage, mechanical shock or water damage;
- damage caused by unauthorized attachment, alterations, modifications or foreign objects;
- damage caused by peripherals (unless such peripherals were supplied by Digital Security Controls);
- defects caused by failure to provide a suitable installation environment for the products;
- damage caused by use of the products for purposes other than those for which it was designed;
- damage from improper maintenance;
- damage arising out of any other abuse, mishandling or improper application of the products.

Items Not Covered by Warranty

In addition to the items which void the Warranty, the following items shall not be covered by Warranty: (i) freight cost to the repair centre; (ii) products which are not identified with DSC's product label and lot number or serial number; (iii) products disassembled or repaired in such a manner as to adversely affect performance or prevent adequate inspection or testing to verify any warranty claim. Access cards or tags returned for replacement under warranty will be credited or replaced at DSC's option. Products not covered by this warranty, or otherwise out of warranty due to age, misuse, or damage shall be evaluated, and a repair estimate shall be provided. No repair work will be performed until a valid purchase order is received from the Customer and a Return Merchandise Authorisation number (RMA) is issued by DSC's Customer Service.

Digital Security Controls's liability for failure to repair the product under this warranty after a reasonable number of attempts will be limited to a replacement of the product, as the exclusive remedy for breach of warranty. Under no circumstances shall Digital Security Controls be liable for any special, incidental, or consequential damages based upon breach of warranty, breach of contract, negligence, strict liability, or any other legal theory. Such damages include, but are not limited to, loss of profits, loss of the product or any associated equipment, cost of capital, cost of substitute or replacement equipment, facilities or services, down time, purchaser's time, the claims of third parties, including customers, and injury to property. The laws of some jurisdictions limit or do not allow the disclaimer of consequential damages. If the laws of such a jurisdiction apply to any claim by or against DSC, the limitations and disclaimers contained here shall be to the greatest extent permitted by law. Some states do not allow the exclusion or limitation of incidental or consequential damages, so that the above may not apply to you.

Disclaimer of Warranties

This warranty contains the entire warranty and shall be in lieu of any and all other warranties, whether expressed or implied (including all implied warranties of merchantability or fitness for a particular purpose) And of all other obligations or liabilities on the part of Digital Security Controls Digital Security Controls neither assumes responsibility for, nor authorizes any other person purporting to act on its behalf to modify or to change this warranty, nor to assume for it any other warranty or liability concerning this product.

This disclaimer of warranties and limited warranty are governed by the laws of the province of Ontario, Canada.

Digital Security Controls recommends that the entire system be completely tested on a regular basis. However, despite frequent testing, and due to, but not limited to, criminal tampering or electrical disruption, it is possible for this product to fail to perform as expected.

Installer's Lockout

Any products returned to DSC which have the Installer's Lockout option enabled and exhibit no other problems will be subject to a service charge.

Out of Warranty Repairs

Digital Security Controls will at its option repair or replace out-of-warranty products which are returned to its factory according to the following conditions. Anyone returning goods to Digital Security Controls must first obtain an authorization number. Digital Security Controls will not accept any shipment whatsoever for which prior authorization has not been obtained.

Products which Digital Security Controls determines to be repairable will be repaired and returned. A set fee which Digital Security Controls has predetermined and which may be revised from time to time, will be charged for each unit repaired. Products which Digital Security Controls determines not to be repairable will be replaced by the nearest equivalent product available at that time. The current market price of the replacement product will be charged for each replacement unit.

© 2017 Tyco Security Products. All Rights Reserved.
Tech Support: 1-800-387-3630 (Canada & U.S.) or 905-760-3000
www.dsc.com

The trademarks, logos, and service marks displayed on this document are registered in the United States [or other countries]. Any misuse of the trademarks is strictly prohibited and Tyco will aggressively enforce its intellectual property rights to the fullest extent of the law, including pursuit of criminal prosecution wherever necessary. All trademarks not owned by Tyco are the property of their respective owners, and are used with permission or allowed under applicable laws. Product offerings and specifications are subject to change without notice. Actual products may vary from photos. Not all products include all features. Availability varies by region; contact your sales representative.

DSC

From Tyco Security Products



29010097R001