

Test report

309365-7TRFWL

Date of issue: July 5, 2016

Applicant:

Digital Security Controls a div. of Tyco Safety Products Canada Ltd.

Product:

Self-Contained Wireless Security System

Model:

WS900-19

FCC ID:

F5316WS90019

IC Registration number:

160A-WS90019

Specifications:

- ◆ **FCC 47 CFR Part 15 Subpart C, §15.209**
Radiated emission limits; general requirements.
- ◆ **RSS-GEN, Issue 4, November 2015, Section 8.9**
Transmitter Emission Limits for Licence-Exempt Radio Apparatus

Test location

Company name	Nemko Canada Inc.
Address	303 River Road
City	Ottawa
Province	Ontario
Postal code	K1V 1H2
Country	Canada
Telephone	+1 613 737 9680
Facsimile	+1 613 737 9691
Toll free	+1 800 563 6336
Website	www.nemko.com
Site number	FCC: 176392; IC: 2040A-4 (3 m semi anechoic chamber)

Tested by	David Duchesne, Senior EMC/Wireless Specialist
Reviewed by	Kevin Rose, Wireless/EMC Specialist
Review date	July 5, 2016
Reviewer signature	

Limits of responsibility

Note that the results contained in this report relate only to the items tested and were obtained in the period between the date of initial receipt of samples and the date of issue of the report.

This test report has been completed in accordance with the requirements of ISO/IEC 17025. All results contain in this report are within Nemko Canada's ISO/IEC 17025 accreditation.

Copyright notification

Nemko Canada Inc. authorizes the applicant to reproduce this report provided it is reproduced in its entirety and for use by the company's employees only. Any use which a third party makes of this report, or any reliance on or decisions to be made based on it, are the responsibility of such third parties.

Nemko Canada Inc. accepts no responsibility for damages, if any, suffered by any third party as a result of decisions made or actions based on this report.

© Nemko Canada Inc.

Table of contents

Table of contents	3
Section 1. Report summary	4
1.1 Applicant and manufacturer	4
1.2 Test specifications	4
1.3 Test methods	4
1.4 Statement of compliance	4
1.5 Exclusions	4
1.6 Test report revision history	4
Section 2. Summary of test results	5
2.1 FCC Part 15 Subpart test results	5
2.2 IC RSS-GEN, Issue 4, test results	5
Section 3. Equipment under test (EUT) details	6
3.1 Sample information	6
3.2 EUT information	6
3.3 Technical information	6
3.4 Product description and theory of operation	7
3.5 EUT exercise details	7
3.6 EUT setup diagram	7
Section 4. Engineering considerations	8
4.1 Modifications incorporated in the EUT	8
4.2 Technical judgment	8
4.3 Deviations from laboratory tests procedures	8
Section 5. Test conditions	9
5.1 Atmospheric conditions	9
5.2 Power supply range	9
Section 6. Measurement uncertainty	10
6.1 Uncertainty of measurement	10
Section 7. Test equipment	11
7.1 Test equipment list	11
Section 8. Testing data	12
8.1 Radiated spurious emissions	12
Section 9. Block diagrams of test set-ups	19
9.1 Radiated emissions set-up for frequencies below 1 GHz	19
9.2 Radiated emissions set-up for frequencies above 1 GHz	19

Section 1. Report summary

1.1 Applicant and manufacturer

Company name	Digital Security Controls a div. of Tyco Safety Products Ltd.
Address	3301 Langstaff Road, Concord, ON, Canada, L4K 4L2

1.2 Test specifications

FCC 47 CFR Part 15 Subpart C, §15.209	Radiated emission limits; general requirements.
RSS-GEN, Issue 4, November 2015, Section 8.9	Transmitter Emission Limits for Licence-Exempt Radio Apparatus

1.3 Test methods

ANSI C63.10 v2013	American National Standard of Procedures for Compliance Testing of Unlicensed Wireless Devices
-------------------	--

1.4 Statement of compliance

In the configuration tested, the EUT was found compliant.

Testing was completed against all relevant requirements of the test standard. Results obtained indicate that the product under test complies in full with the requirements tested. The test results relate only to the items tested.

See "Summary of test results" for full details.

1.5 Exclusions

None

1.6 Test report revision history

Revision #	Details of changes made to test report
TRF	Original report issued

Section 2. Summary of test results

2.1 FCC Part 15 Subpart test results

Table 2.1-1: FCC 47 CFR Part 15 Subpart C, §15.209, test results

Part	Test description	Verdict
§15.209 (a)	Emissions from an intentional radiator	Pass ¹

Notes: ¹The EUT was verified for compliance with multiple transmitters enabled.

2.2 IC RSS-GEN, Issue 4, test results

Table 2.2-1: RSS-GEN, Issue 4, November 2015, Section 8.9, test results

Section	Test description	Verdict
8.9	Transmitter Emission Limits for Licence-Exempt Radio Apparatus	Pass ¹

Notes: ¹The EUT was verified for compliance with multiple transmitters enabled.

Section 3. Equipment under test (EUT) details

3.1 Sample information

Receipt date	May 24, 2016
Nemko sample ID number	133-002708

3.2 EUT information

Product name	Self-Contained Wireless Security System
Model	WS900-29
Serial number	None

3.3 Technical information

All used IC test site(s) Reg. number	2040A-4
WIFI Transmitter	
Frequency band (MHz)	2400–2483.5
Frequency Min (MHz)	2412 (for 802.11b, 802.11g and 802.11n HT20) 2422 (for 802.11n HT40)
Frequency Max (MHz)	2462 (for 802.11b, 802.11g and 802.11n HT20) 2452 (for 802.11n HT40)
Type of modulation	802.11b/g/n HT20 and HT40
Power G Transmitter	
Frequency band (MHz)	902–928
Frequency Min (MHz)	912.750
Frequency Max (MHz)	919.106
Type of modulation	FHSS - FSK

3.4 Product description and theory of operation

The Wireless alarm system has support for 128 wireless zones. It monitors the wireless initiating devices and activates the integrated siren when an alarm occurs and also provides communication of the alarm event over the integrated Wi-Fi interface. The control unit is also capable to communicate with Z-Wave compatible home automation devices. The security portion can be armed and disarmed via the integrated keypad. Trouble/alarm/signal strength status is indicated on the front panel using LED's.

3.5 EUT exercise details

EUT was connected to a laptop via Ethernet connector. A putty application was running on the computer that controlled the transmitter parameters. Client provided a modified sample with a direct connection to the antenna port for conducted measurements at the antenna ports.

3.6 EUT setup diagram

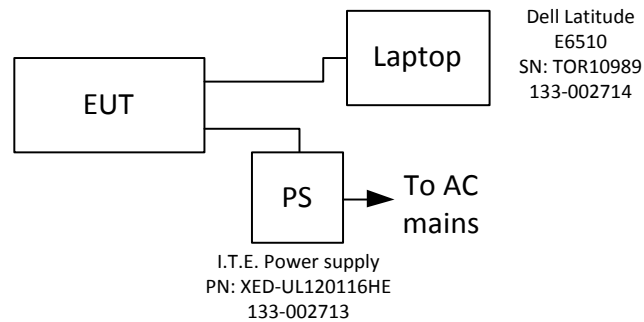

Figure 3.6-1: Setup diagram

Section 4. Engineering considerations

4.1 Modifications incorporated in the EUT

There were no modifications performed to the EUT during this assessment.

4.2 Technical judgment

None

4.3 Deviations from laboratory tests procedures

No deviations were made from laboratory procedures.

Section 5. Test conditions

5.1 Atmospheric conditions

Temperature	15–30 °C
Relative humidity	20–75 %
Air pressure	860–1060 mbar

When it is impracticable to carry out tests under these conditions, a note to this effect stating the ambient temperature and relative humidity during the tests shall be recorded and stated.

5.2 Power supply range

The normal test voltage for equipment to be connected to the mains shall be the nominal mains voltage. For the purpose of the present document, the nominal voltage shall be the declared voltage, or any of the declared voltages $\pm 5\%$, for which the equipment was designed.

Section 6. Measurement uncertainty

6.1 Uncertainty of measurement

Measurement uncertainty budgets for the tests are detailed below. Measurement uncertainty calculations assume a coverage factor of $K = 2$ with 95% certainty.

Test name	Measurement uncertainty, dB
Radiated spurious emissions	3.78

Section 7. Test equipment

7.1 Test equipment list

Table 7.1-1: Equipment list

Equipment	Manufacturer	Model no.	Asset no.	Cal cycle	Next cal.
Receiver/spectrum analyzer	Rohde & Schwarz	ESU 26	FA002043	1 year	Jan. 07/17
AC Power source	California Instruments	3001i	FA001021	1 year	Aug. 27/16
LISN	Rohde & Schwarz	ENV216	FA002023	1 year	Mar. 08/17
3 m EMI test chamber	TDK	SAC-3	FA002047	1 year	Dec. 01/16
Bilog antenna (20–3000 MHz)	Sunol	JB3	FA002108	1 year	Apr. 28/17
Horn antenna (1–18 GHz)	EMCO	3115	FA000825	1 year	Apr. 26/17
Horn antenna 18–40 GHz	EMCO	3116	FA001847	1 year	Apr.15/17
Pre-amplifier (1–18 GHz)	JCA	JCA118-503	FA002091	1 year	April 26/17
Pre-amplifier (18–26 GHz)	Narda	BBS-1826N612	FA001550	—	VOU
Spectrum analyzer	Rohde & Schwarz	FSP	FA001920	1 year	Aug. 20/16
Notch filter 2400–2483 MHz	Microwave Circuits	2400–2483 MHz	FA001940	—	VOU

Notes: None

Table 7.1-2: test software

Test description	Manufacturer of Software	Details
Radiated emissions – Ottawa	Rhode & Schwarz	EMC32, Software for EMC Measurements, Version 9.26.01

Notes: None

Section 8. Testing data

8.1 Radiated spurious emissions

8.1.1 Definitions and limits

FCC §15.209 (a):

Except as provided elsewhere in this subpart, the emissions from an intentional radiator shall not exceed the field strength levels specified in the following **Table 8.4 – 1**:

RSS-GEN, Section 8.9:

Except when the requirements applicable to a given device state otherwise, emissions from licence - exempt transmitters shall comply with the field strength limits shown in **Table 8.4 – 1**. Additionally, the level of any transmitter emission shall not exceed the level of the transmitter's fundamental emission.

Table 8.1-1: FCC §15.209 and RSS-Gen – Radiated emission limits

Frequency, MHz	Field strength of emissions		Measurement distance, m
	µV/m	dBµV/m	
0.009–0.490	2400/F	$67.6 - 20 \times \log_{10}(F)$	300
0.490–1.705	24000/F	$87.6 - 20 \times \log_{10}(F)$	30
1.705–30.0	30	29.5	30
30–88	100	40.0	3
88–216	150	43.5	3
216–960	200	46.0	3
above 960	500	54.0	3

Notes: In the emission table above, the tighter limit applies at the band edges.
 For frequencies above 1 GHz the limit on peak RF emissions is 20 dB above the maximum permitted average emission limit applicable to the equipment under test

8.1.2 Test summary

Verdict	Pass				
Test date	June 2, 2016	Test engineer	David Duchesne		
Temperature	21 °C	Relative humidity	75 %	Air pressure	1015. mbar

8.1.3 Notes

- The spectrum was searched from 30 MHz to the 25 GHz. No emissions were discovered above 18 GHz.
- EUT was set to transmit with 100 % duty cycle.
- Test mode: All transmitters transmitting at the same time (Wi-Fi (Mid channel) and Power G (Low channel))

8.1.4 Setup details

EUT setup configuration	Table top
Test facility	3 m Semi anechoic chamber
Measuring distance	3 m
Antenna height variation	1–4 m
Turn table position	0–360°

Receiver/spectrum analyzer settings for frequencies below 1 GHz:

Resolution bandwidth	120 kHz
Video bandwidth	300 kHz
Detector mode	<ul style="list-style-type: none"> – Peak (Preview measurement) – Quasi-peak (Final measurement)
Trace mode	Max Hold
Measurement time	<ul style="list-style-type: none"> – 100 ms (Peak preview measurement) – 160 ms (Quasi-peak final measurement)

Receiver/spectrum analyzer settings for frequencies above 1 GHz:

Resolution bandwidth	1 MHz
Video bandwidth	3 MHz
Detector mode	<ul style="list-style-type: none"> Peak (Preview measurement) Peak and CAverage (Final measurement)
Trace mode	Max Hold
Measurement time	<ul style="list-style-type: none"> – 100 ms (Peak preview measurement) – 100 ms (Peak and CAverage final measurement)

8.1.5 Test data

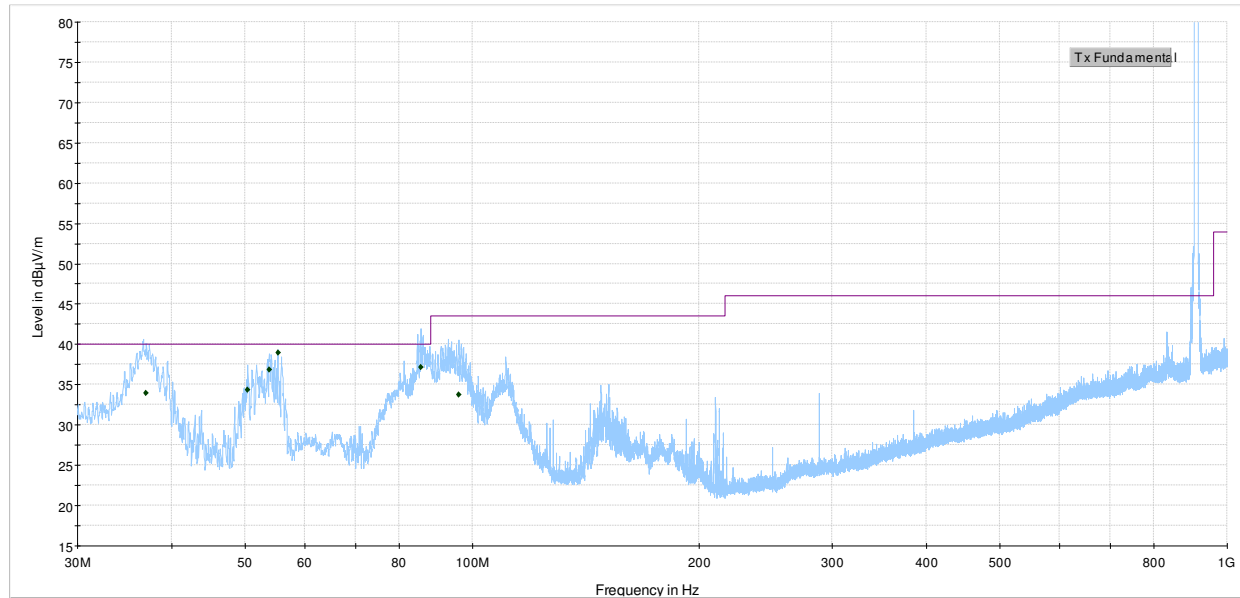

Vertical and Horizontal
 Preview Peak Detector
 FCC Part 15 and ICES - Class B 3m Q-Peak Limit
 Final Q-Peak Detector

The spectral plot is a summation of a vertical and horizontal scan. The spectral scan has been corrected with the associated transducer factors (i.e. antenna factors, cable loss, amplifier gains, and attenuators).

Figure 8.1-1: Radiated spurious emissions spectral plot – 30 to 1000 MHz

Table 8.1-2: Radiated disturbance (Quasi-Peak) results

Frequency (MHz)	Quasi-Peak field strength ¹ and ⁴ (dBµV/m)	3 m Quasi-Peak limit ³ (dBµV/m)	Margin (dB)	Measurement time (ms)	Bandwidth (kHz)	Antenna height (cm)	Pol. (V/H)	Turn table position (°)	Correction factor ² (dB)
36.96	33.94	40.00	6.06	160	120	107.1	V	311.0	18.40
50.43	34.31	40.00	5.69	160	120	123.2	V	54.0	9.80
53.82	36.85	40.00	3.15	160	120	113.4	V	188.0	9.00
55.29	38.93	40.00	1.07	160	120	122.6	V	356.0	8.90
85.50	37.15	40.00	2.85	160	120	109.3	V	30.0	9.30
96.00	33.71	43.50	9.79	160	120	103.2	V	328.0	10.80

Notes:
¹ Field strength (dBµV/m) = receiver/spectrum analyzer value (dBµV) + correction factor (dB)
² Correction factor = antenna factor ACF (dB) + cable loss (dB)
³ An inverse proportionality factor of 20 dB per decade (20 log (10/3) = 10.5 dB) has been used to normalize the specification limit to a measurement distance of 3 meters to determine compliance.
⁴ The maximum measured value observed over a period of 15 seconds was recorded.

Sample calculation: 38.93 dBµV/m (field strength) = 30.03 dBµV (receiver reading) + 8.90 dB (Correction factor)

8.1.5 Test data, continued

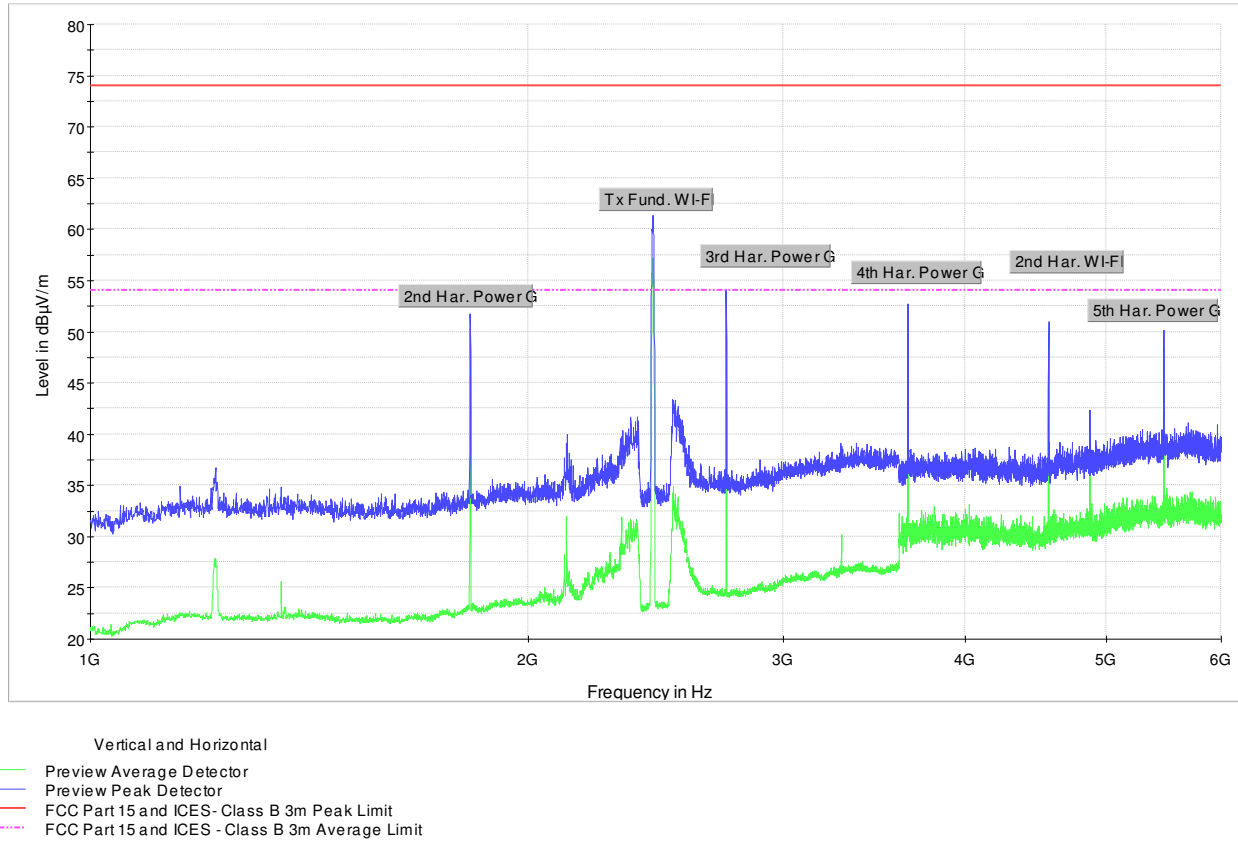

The spectral plot is a summation of a vertical and horizontal scan. The spectral scan has been corrected with the associated transducer factors (i.e. antenna factors, cable loss, amplifier gains, and attenuators).

Figure 8.1-2: Radiated spurious emissions spectral plot – 1 to 6 GHz

8.1.5 Test data, continued

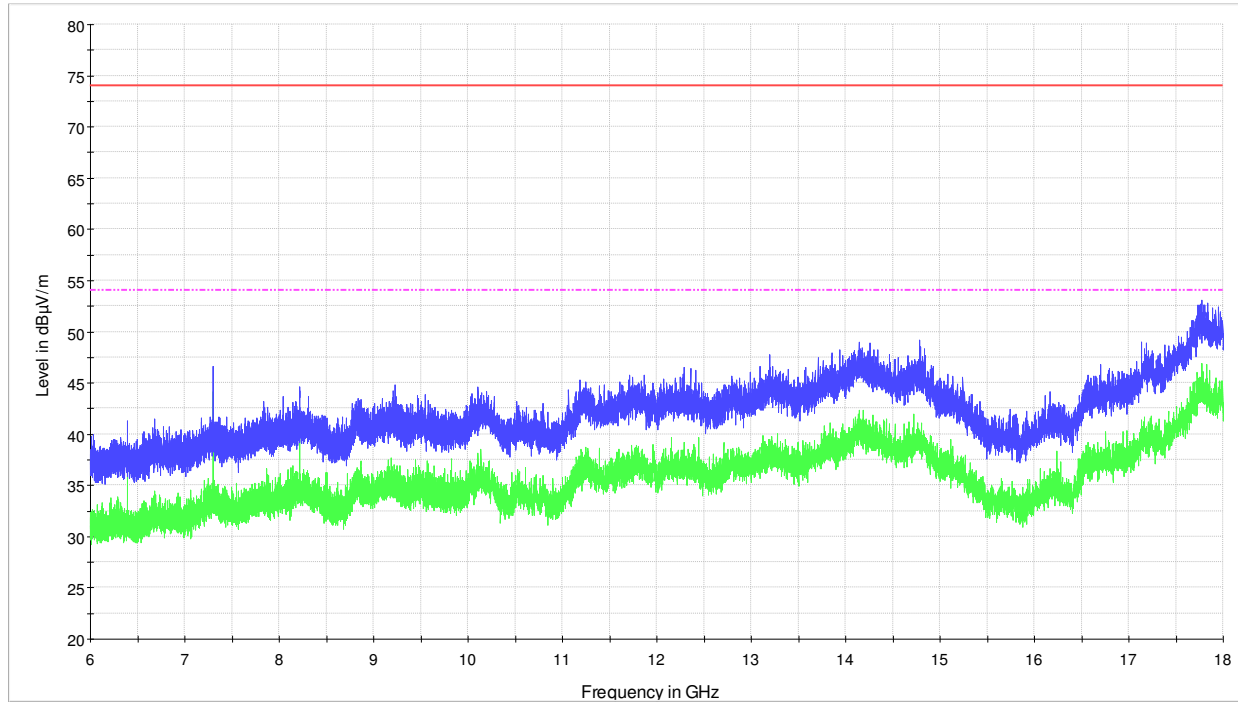

- Vertical and Horizontal
- Preview Average Detector
 - Preview Peak Detector
 - FCC Part 15 and ICES- Class B 3m Peak Limit
 - FCC Part 15 and ICES - Class B 3m Average Limit

The spectral plot is a summation of a vertical and horizontal scan. The spectral scan has been corrected with the associated transducer factors (i.e. antenna factors, cable loss, amplifier gains, and attenuators).

Figure 8.1-3: Radiated spurious emissions spectral plot – 6 to 18 GHz

8.1.5 Setup photos



Figure 8.1-1: Radiated spurious (out-of-band) emissions setup photo – 30 to 1000 MHz

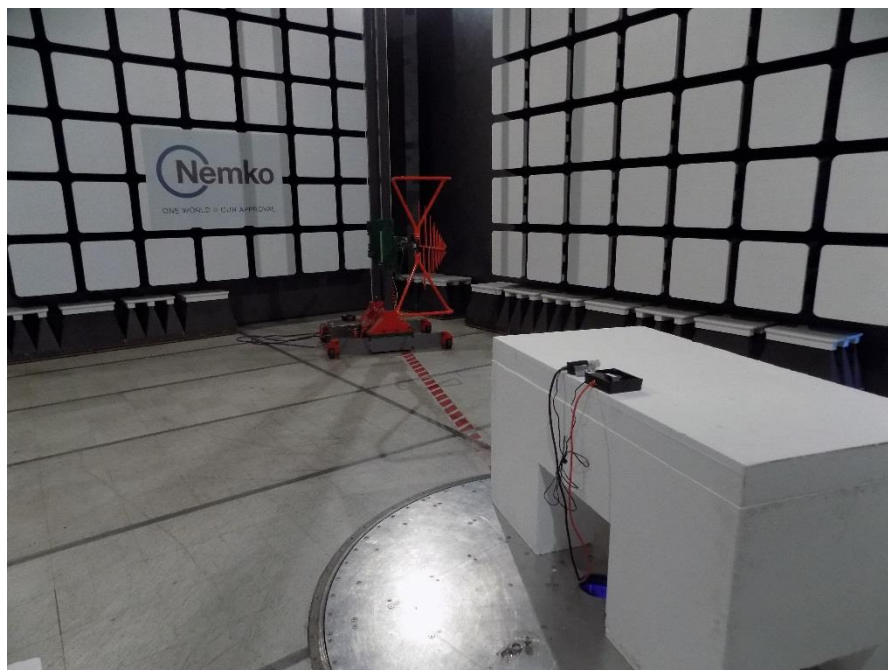

Figure 8.1-2: Radiated spurious (out-of-band) emissions setup photo – 30 to 1000 MHz

8.1.6 Setup photos, continued

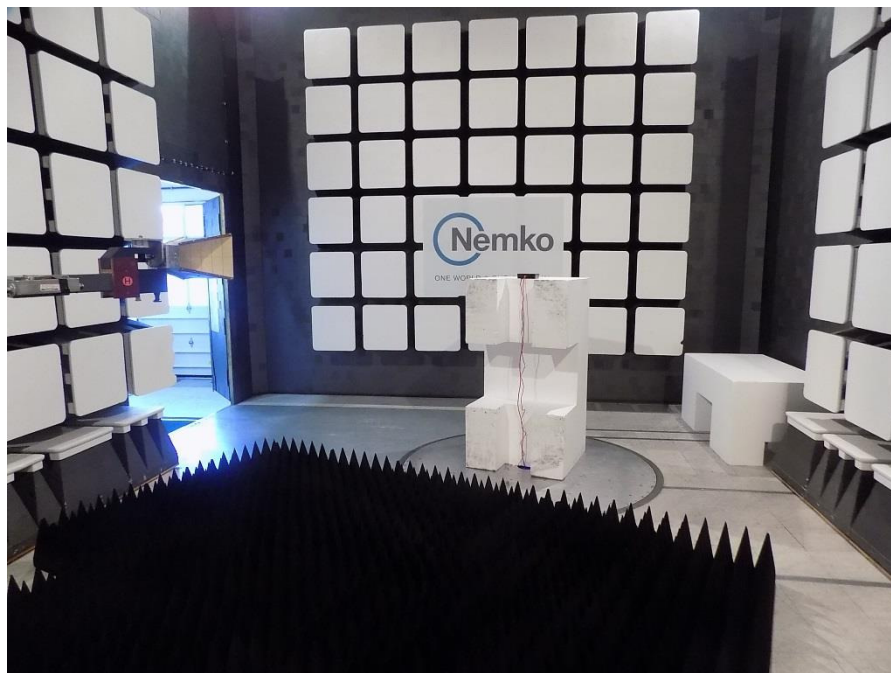

Figure 8.1-3: Radiated spurious (out-of-band) emissions setup photo – above 1 GHz

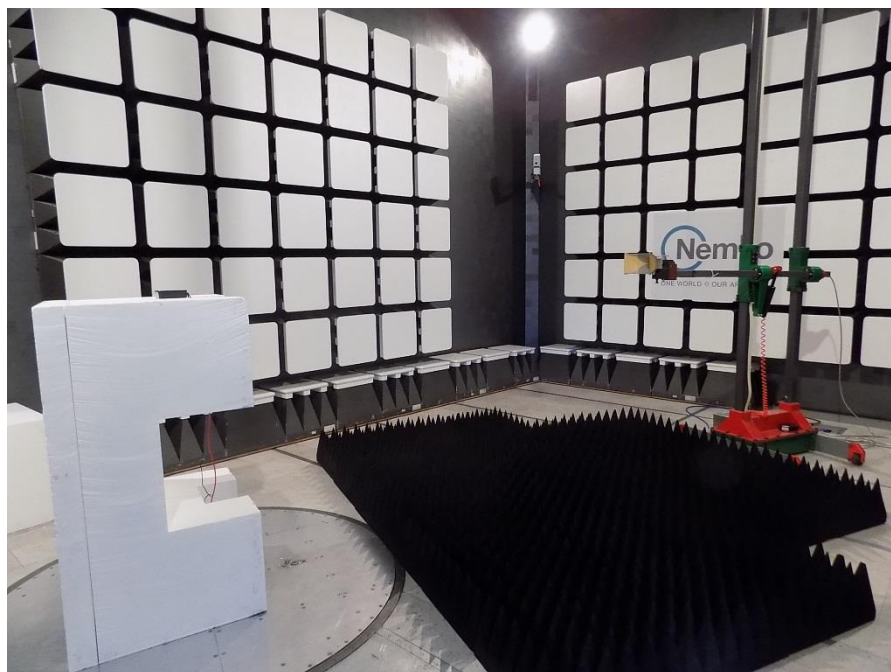
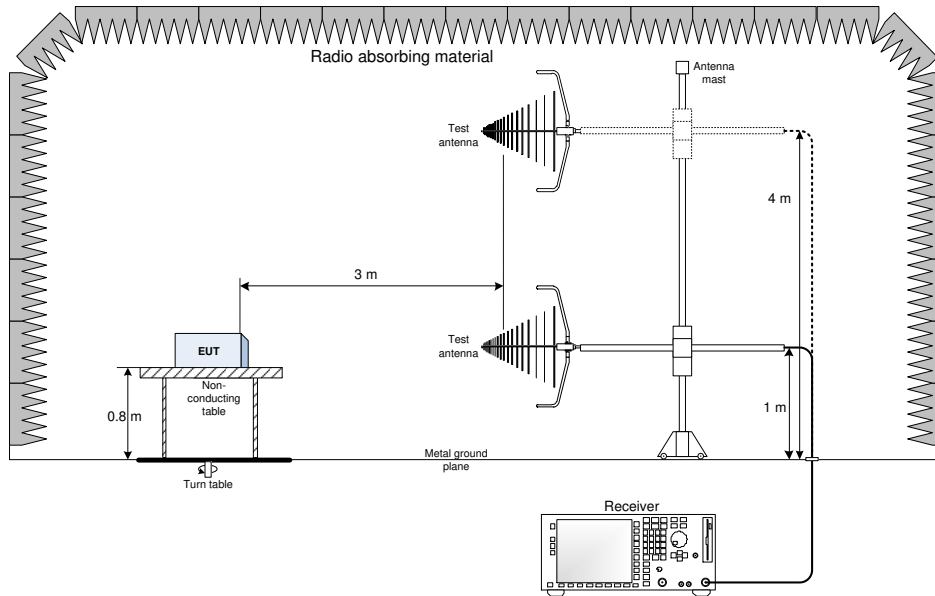

Figure 8.1-4: Radiated spurious (out-of-band) emissions setup photo – above 1 GHz

Section 9. Block diagrams of test set-ups

9.1 Radiated emissions set-up for frequencies below 1 GHz



9.2 Radiated emissions set-up for frequencies above 1 GHz

