



**FCC 47 CFR PART 22 SUBPART H AND PART 24 SUBPART E
&
INDUSTRY CANADA RSS-132 & RSS-133**

TEST REPORT

For

2G,3G wireless module

Model: UE910-NAR, UE910-NAD

Trade Name: Telit

Issued to

**TELIT COMMUNICATIONS S.P.A.
Via Stazione di Prosecco 5/b, 34010 SGONICO, TRIESTE - ITALY**

Issued by

**Compliance Certification Services Inc.
No.11, Wugong 6th Rd., Wugu Dist.,
New Taipei City 24891, Taiwan. (R.O.C.)
<http://www.ccsrf.com>
service@ccsrf.com
Issued Date: March 25, 2013**



Note: This report shall not be reproduced except in full, without the written approval of Compliance Certification Services Inc. This document may be altered or revised by Compliance Certification Services Inc. personnel only, and shall be noted in the revision section of the document.



Revision History

Rev.	Issue Date	Revisions	Effect Page	Revised By
00	March 25, 2013	Initial Issue	ALL	Angel Cheng



TABLE OF CONTENTS

1. TEST RESULT CERTIFICATION.....	4
2. EUT DESCRIPTION	5
3. TEST METHODOLOGY	6
3.1 EUT CONFIGURATION	6
3.2 EUT EXERCISE	6
3.3 GENERAL TEST PROCEDURES	6
3.4 DESCRIPTION OF TEST MODES	7
4. INSTRUMENT CALIBRATION.....	8
4.1 MEASURING INSTRUMENT CALIBRATION	8
4.2 MEASUREMENT EQUIPMENT USED	9
4.3 MEASUREMENT UNCERTAINTY	10
5. FACILITIES AND ACCREDITATIONS	11
5.1 FACILITIES	11
5.2 EQUIPMENT	11
5.3 TABLE OF ACCREDITATIONS AND LISTINGS	12
6. SETUP OF EQUIPMENT UNDER TEST	13
6.1 SETUP CONFIGURATION OF EUT	13
6.2 SUPPORT EQUIPMENT.....	13
7. FCC PART 22 & 24 REQUIREMENTS	14
7.1 99% BANDWIDTH	14
7.2 PEAK POWER.....	25
7.1 AVERAGE POWER.....	27
7.2 ERP & EIRP MEASUREMENT.....	29
7.3 OCCUPIED BANDWIDTH MEASUREMENT	33
7.4 OUT OF BAND EMISSION AT ANTENNA TERMINALS	44
7.5 FIELD STRENGTH OF SPURIOUS RADIATION MEASUREMENT	62
7.6 FREQUENCY STABILITY V.S. TEMPERATURE MEASUREMENT.....	100
7.7 FREQUENCY STABILITY V.S. VOLTAGE MEASUREMENT.....	104



1. TEST RESULT CERTIFICATION

Applicant: TELIT COMMUNICATIONS S.P.A.
Via Stazione di Prosecco 5/b, 34010 SGONICO,
TRIESTE - ITALY

Equipment Under Test: 2G,3G wireless module

Trade Name: Telit

Model Number: UE910-NAR, UE910-NAD

Date of Test: March 11 ~ 23, 2013

APPLICABLE STANDARDS	
STANDARD	TEST RESULT
FCC 47 CFR PART 22 SUBPART H AND PART 24 SUBPART E & IC RSS-132 Issue 2: September 2005 and IC RSS-133 Issue 5: February 2009	No non-compliance noted

We hereby certify that:

The above equipment was tested by Compliance Certification Services Inc. The test data, data evaluation, test procedures, and equipment configurations shown in this report were made in accordance with the procedures given in TIA/EIA-603-C: 2004 and the energy emitted by the sample EUT tested as described in this report is in compliance with conducted and radiated emission limits of FCC Rule FCC PART 22 Subpart H and PART 24 Subpart E.

The test results of this report relate only to the tested sample identified in this report.

Approved by:

Reviewed by:

Miller Lee
Section Manager
Compliance Certification Services Inc.

Gina Lo
Section Manager
Compliance Certification Services Inc.



2. EUT DESCRIPTION

Product	2G,3G wireless module
Trade Name	Telit
Model Number	UE910-NAR, UE910-NAD
Model Discrepancy	UE910-NAR - includes a voice codec UE910-NAD - not voice codec
Received Date	February 25, 2013
Power Supply	Power from Power Supply (DC 3.8 V)
Frequency Range	GPRS / EDGE: 850: 824.2 ~ 848.8 MHz GPRS / EDGE: 1900: 1850.2 ~ 1909.8 MHz WCDMA Band II: 1852.4 ~ 1907.6 MHz WCDMA Band V: 826.4 ~ 846.6MHz
Transmit Power (ERP & EIRP Power)	GPRS 850: 21.00 dBm GPRS 1900: 26.57 dBm EDGE 850: 20.99 dBm EDGE 1900: 26.59 dBm WCDMA Band II: 14.48 dBm WCDMA Band V: 20.61 dBm
Cellular Phone Protocol	GPRS: GMSK EDGE: 8PSK WCDMA: Quadrature Phase Shift Keying (QPSK) with Root-raised cosine pulse shaping filters (roll off = 0.22)
Type of Emission	GPRS 850: 248KGXW--- GPRS 1900: 246KGXW--- EDGE 850: 248KG7W--- EDGE 1900: 247KG7W--- WCDMA Band II: 4M20F9W--- WCDMA Band V: 4M21F9W---
Antenna Gain	Gain: 2.14 dBi
Antenna Type	1/4 l Mobile Antenna

Remark:

1. The sample selected for test was engineering sample that approximated to production product and was provided by manufacturer.
2. This submittal(s) (test report) is intended for FCC ID: RI7UE910NA filing to comply with Part 22 and Part 24 of the FCC 47 CFR Rules.
3. This submittal(s) (test report) is intended for IC ID: 5131A-UE910NA filing to comply with RSS-132 and RSS-133.



3. TEST METHODOLOGY

Both conducted and radiated testing were performed according to the procedures document on chapter 13 of ANSI C63.4: 2009, TIA/EIA-603-C: 2004 and FCC CFR 47, Part 2 and Part 22 Subpart H & Part 24 Subpart E.

The tests documented in this report were performed in accordance with IC RSS-132, SPSR503, RSS-133, SPSR510 and ANSI C63.4 and TIA/EIA-603-C.

3.1 EUT CONFIGURATION

The EUT configuration for testing is installed on RF field strength measurement to meet the Commissions requirement and operating in a manner that intends to maximize its emission characteristics in a continuous normal application.

3.2 EUT EXERCISE

The EUT was operated in the engineering mode to fix the TX frequency that was for the purpose of the measurements.

3.3 GENERAL TEST PROCEDURES

Conducted Emissions

The EUT is placed on the turntable, which is 0.8 m above ground plane. According to the requirements in Section 13.1.4.1 of ANSI C63.4: 2009. Conducted emissions from the EUT measured in the frequency range between 0.15 MHz and 30MHz using CISPR Quasi-peak and average detector modes.

Radiated Emissions

The EUT is placed on a turn table, which is 0.8 m above ground plane. The turntable shall rotate 360 degrees to determine the position of maximum emission level. EUT is set 3m away from the receiving antenna, which varied from 1m to 4m to find out the highest emission. And also, each emission was to be maximized by changing the polarization of receiving antenna both horizontal and vertical. In order to find out the maximum emissions, exploratory radiated emission measurements were made according to the requirements in Section 13.1.4.1 of ANSI C63.4: 2009.



3.4 DESCRIPTION OF TEST MODES

The EUT (model: UE910-NAR) had been tested under operating condition.

EUT staying in continuous transmitting mode was programmed.

GPRS / EDGE 850:

Channel Low (CH128), Channel Mid (CH190) and Channel High (CH251) were chosen for full testing.

GPRS / EDGE 1900:

Channel Low (CH512), Channel Mid (CH661) and Channel High (CH810) were chosen for full testing.

WCDMA Band II:

Channel Low (CH9262), Channel Mid (CH9400) and Channel High (CH9538) were chosen for full testing.

WCDMA Band V:

Channel Low (CH4132), Channel Mid (CH4182) and Channel High (CH4233) were chosen for full testing.

After verification, all tests were carried out with the worst case test modes as shown below except radiated spurious emission below 1GHz and power line conducted emissions below 30MHz, which worst case was in normal link mode only.



4. INSTRUMENT CALIBRATION

4.1 MEASURING INSTRUMENT CALIBRATION

The measuring equipment, which was utilized in performing the tests documented herein, has been calibrated in accordance with the manufacturer's recommendations for utilizing calibration equipment, which is traceable to recognized national standards.



4.2 MEASUREMENT EQUIPMENT USED

Equipment Used for Emissions Measurement

Remark: Each piece of equipment is scheduled for calibration once a year and Loop Antenna is scheduled for calibration once three years.

Conducted Emissions Test Site				
Name of Equipment	Manufacturer	Model	Serial Number	Calibration Due
Spectrum Analyzer	Agilent	E4446A	MY43360131	03/21/2013
Power Meter	Anritsu	ML2495A	1012009	06/05/2013
Power Sensor	Anritsu	MA2411A	0917072	06/05/2013
Temp. / Humidity Chamber	Terchy	MHG-150LF	930619	10/18/2013

Wugu 966 Chamber A				
Name of Equipment	Manufacturer	Model	Serial Number	Calibration Due
Spectrum Analyzer	Agilent	E4446A	US42510268	11/14/2013
EMI Test Receiver	R&S	ESCI	100064	02/28/2014
Pre-Amplifier	Mini-Circuits	ZFL-1000LN	SF350700823	01/12/2014
Pre-Amplifier	MITEQ	AFS44-00102650-42-10P-44	1415367	11/19/2013
Bilog Antenna	Sunol Sciences	JB3	A030105	10/02/2013
Bilog Antenna	Sunol Sciences	JB3	A030205	10/02/2013
Horn Antenna	EMCO	3117	00055165	02/13/2014
Horn Antenna	EMCO	3117	00055167	01/28/2014
Horn Antenna	EMCO	3116	00026370	10/11/2013
Loop Antenna	EMCO	6502	8905/2356	06/10/2013
Turn Table	CCS	CC-T-1F	N/A	N.C.R
Antenna Tower	CCS	CC-A-1F	N/A	N.C.R
Controller	CCS	CC-C-1F	N/A	N.C.R
Site NSA	CCS	N/A	N/A	12/22/2013
Test S/W	EZ-EMC (CCS-3A1RE)			



4.3 MEASUREMENT UNCERTAINTY

PARAMETER	UNCERTAINTY
3M Semi Anechoic Chamber / 30M~200M	+/- 4.0138
3M Semi Anechoic Chamber / 200M~1000M	+/- 3.9483
3M Semi Anechoic Chamber / 1G~8G	+/- 2.5975
3M Semi Anechoic Chamber / 8G~18G	+/- 2.6112
3M Semi Anechoic Chamber / 18G~26G	+/- 2.7389
3M Semi Anechoic Chamber / 26G~40G	+/- 2.9683

Remark: This uncertainty represents an expanded uncertainty expressed at approximately the 95% confidence level using a coverage factor of $k=2$.



5. FACILITIES AND ACCREDITATIONS

5.1 FACILITIES

No.199, Chunghsen Road, Hsintien City, Taipei Hsien, Taiwan, R.O.C.

Tel: 886-2-2217-0894 / Fax: 886-2-2217-1029

No.11, Wugong 6th Rd., Wugu Dist., New Taipei City 24891, Taiwan. (R.O.C.)

Tel: 886-2-2299-9720 / Fax: 886-2-2298-4045

No.81-1, Lane 210, Bade 2nd Rd., Lujhu Township, Taoyuan County 33841, TAIWAN, R.O.C.

Tel: 886-3-324-0332 / Fax: 886-3-324-5235

The sites are constructed in conformance with the requirements of ANSI C63.7, ANSI C63.4 and CISPR Publication 22.

5.2 EQUIPMENT

Radiated emissions are measured with one or more of the following types of linearly polarized antennas: tuned dipole, biconical, log periodic, bi-log, and/or ridged waveguide, horn. Spectrum analyzers with pre-selectors and quasi-peak detectors are used to perform radiated measurements.



Conducted emissions are measured with Line Impedance Stabilization Networks and EMI Test Receivers.

Calibrated wideband preamplifiers, coaxial cables, and coaxial attenuators are also used for making measurements.

All receiving equipment conforms to CISPR Publication 16-1, "Radio Interference Measuring Apparatus and Measurement Methods."



5.3 TABLE OF ACCREDITATIONS AND LISTINGS

Country	Agency	Scope of Accreditation	Logo
USA	FCC	3M Semi Anechoic Chamber (FCC MRA: TW1039) to perform FCC Part 15 measurements	 FCC MRA: TW1039
Taiwan	TAF	LP0002, RTTE01, FCC Method-47 CFR Part 15 Subpart C, D, E, RSS-210, RSS-310 IDA TS SRD, AS/NZS 4268, AS/NZS 4771, TS 12.1 & 12.2, ETSI EN 300 440-1, ETSI EN 300 440-2, ETSI EN 300 328, ETSI EN 300 220-1, ETSI EN 300 220-2, ETSI EN 301 893, ETSI EN 301 489-1/3/7/17 FCC OET Bulletin 65 + Supplement C, EN 50360, EN 50361, EN 50371, RSS 102, EN 50383, EN 50385, EN 50392, IEC 62209, CNS 14958-1, CNS 14959 FCC Method -47 CFR Part 15 Subpart B IEC / EN 61000-3-2, IEC / EN 61000-3-3, IEC / EN 61000-4-2/3/4/5/6/8/11	
Canada	Industry Canada	3M Semi Anechoic Chamber (IC 2324G-1 / IC 2324G-2) to perform	 IC 2324G-1 IC 2324G-2

* No part of this report may be used to claim or imply product endorsement by A2LA or any agency of the US Government.



6. SETUP OF EQUIPMENT UNDER TEST

6.1 SETUP CONFIGURATION OF EUT

See test photographs attached in Appendix I for the actual connections between EUT and support equipment.

6.2 SUPPORT EQUIPMENT

No.	Device Type	Brand	Model	FCC ID	Series No.	Data Cable	Power Cord
	N/A						

Remark:

1. All the equipment/cables were placed in the worst-case configuration to maximize the emission during the test.
2. Grounding was established in accordance with the manufacturer's requirements and conditions for the intended use.



7. FCC PART 22 & 24 REQUIREMENTS

7.199% BANDWIDTH

LIMIT

None; for reporting purposes only.

Test Configuration

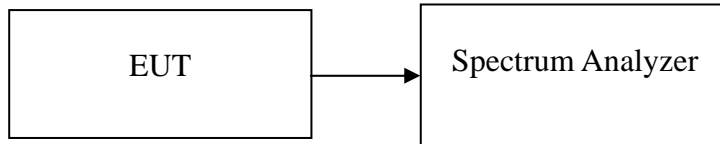

TEST PROCEDURE

The transmitter output is connected to the spectrum analyzer. The RBW is set to 1% to 3% of the 99 % bandwidth. The VBW is set to 3 times the RBW. The sweep time is coupled.

TEST RESULTS

No non-compliance noted.



Test Data

Test Mode	CH	Frequency (MHz)	99% Bandwidth (kHz)
GPRS 850 (Class 12)	128	824.200	246.3208
	190	836.400	248.2368
	251	848.800	245.8998
EDGE 850 (Class 12)	128	824.200	248.2761
	190	836.570	248.8313
	251	848.800	247.1795
GPRS 1900 (Class 12)	512	1850.210	243.2782
	661	1880.000	246.3155
	810	1909.823	245.1765
EDGE 1900 (Class 12)	512	1850.173	243.6382
	661	1880.000	247.9991
	810	1909.800	247.2545

Test Mode	CH	Frequency (MHz)	99% Bandwidth (MHz)
WCDMA (Band II)	9262	1852.40	4.1896
	9400	1880.00	4.2000
	9538	1907.60	4.2012
WCDMA (Band V)	4132	826.40	4.2005
	4182	836.40	4.1824
	4233	846.60	4.2163



Test Plot

GPRS 850 (CH Low)

Agilent 09:32:05 Mar 23, 2013

R T

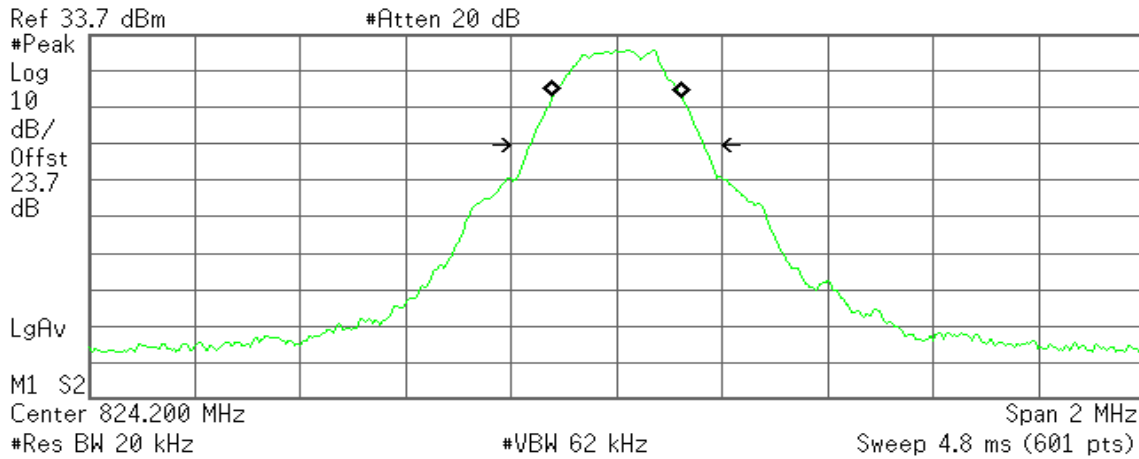

Occupied Bandwidth
246.3208 kHz

Occ BW % Pwr 99.00 %
x dB -26.00 dB

Transmit Freq Error 1.028 kHz
x dB Bandwidth 330.472 kHz

GPRS 850 (CH Mid)

Agilent 09:34:22 Mar 23, 2013

R T

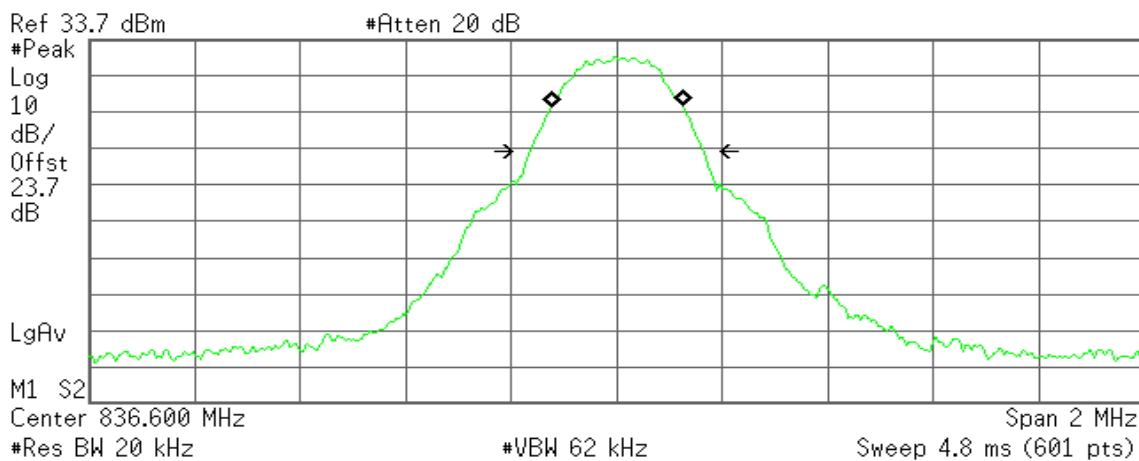

Occupied Bandwidth
248.2368 kHz

Occ BW % Pwr 99.00 %
x dB -26.00 dB

Transmit Freq Error 1.020 kHz
x dB Bandwidth 329.144 kHz



GPRS 850(CH High)

Agilent 09:35:21 Mar 23, 2013

R T

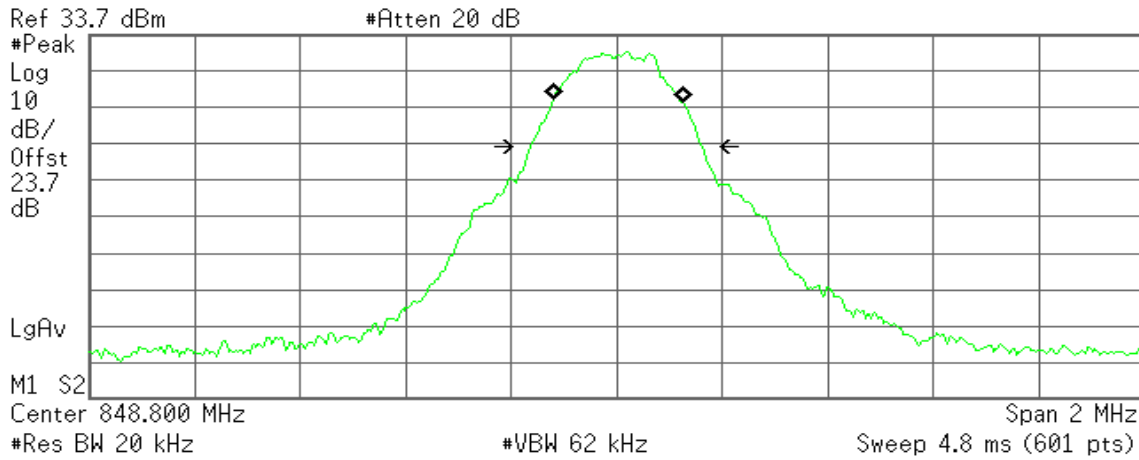

Occupied Bandwidth
245.8998 kHz

Occ BW % Pwr 99.00 %
x dB -26.00 dB

Transmit Freq Error 2.271 kHz
x dB Bandwidth 326.548 kHz

GPRS 1900 (CH Low)

Agilent 09:41:32 Mar 23, 2013

R T

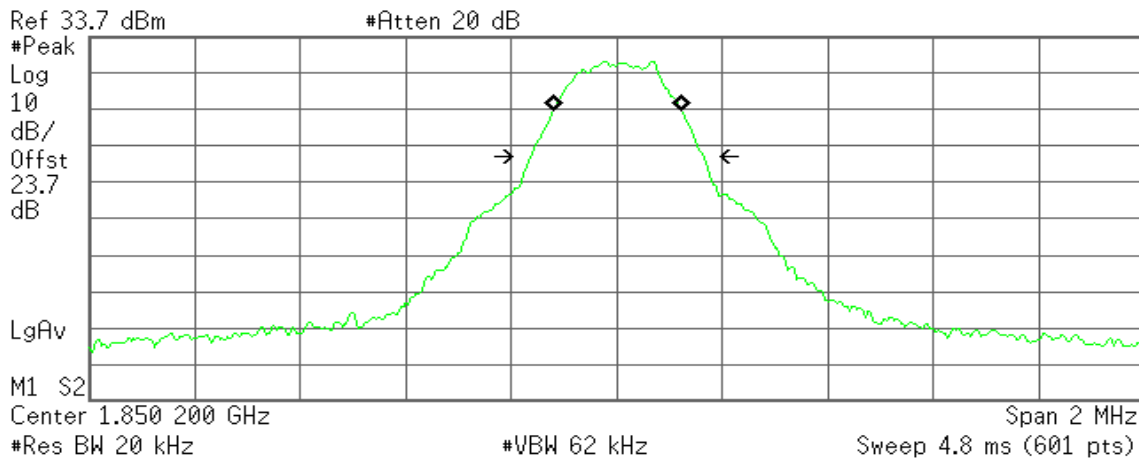

Occupied Bandwidth
243.2782 kHz

Occ BW % Pwr 99.00 %
x dB -26.00 dB

Transmit Freq Error 1.604 kHz
x dB Bandwidth 327.069 kHz



GPRS 1900 (CH Mid)

Agilent 09:42:02 Mar 23, 2013

R T

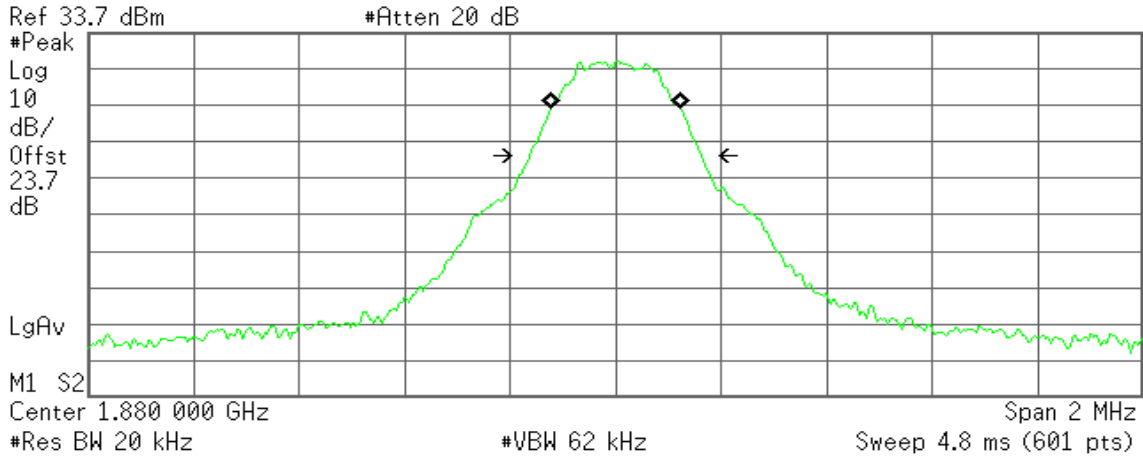

Occupied Bandwidth
246.3155 kHz

Occ BW % Pwr 99.00 %
x dB -26.00 dB

Transmit Freq Error 334.016 Hz
x dB Bandwidth 326.242 kHz

GPRS 1900 (CH High)

Agilent 09:43:19 Mar 23, 2013

R T

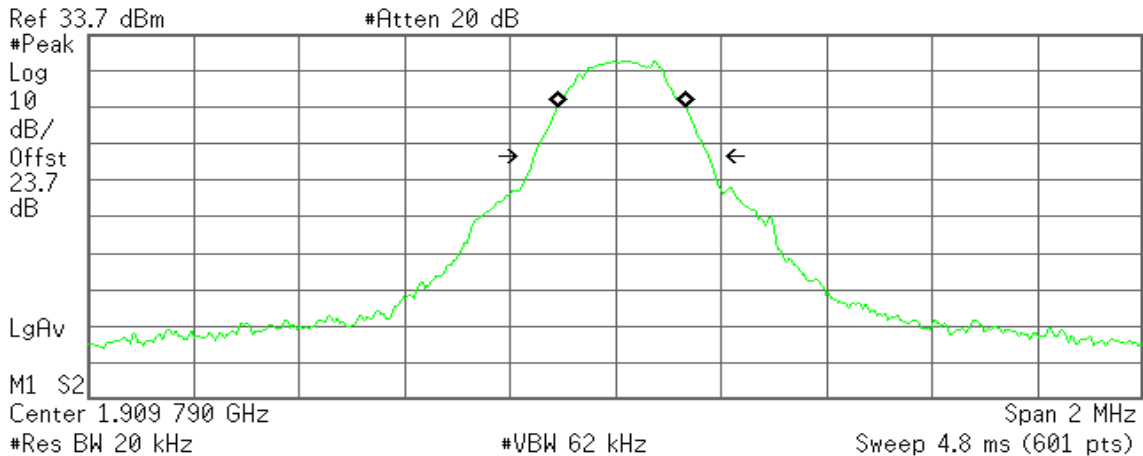

Occupied Bandwidth
245.1765 kHz

Occ BW % Pwr 99.00 %
x dB -26.00 dB

Transmit Freq Error 11.025 kHz
x dB Bandwidth 330.658 kHz



EDGE 850 (CH Low)

Agilent 09:33:11 Mar 23, 2013

R T

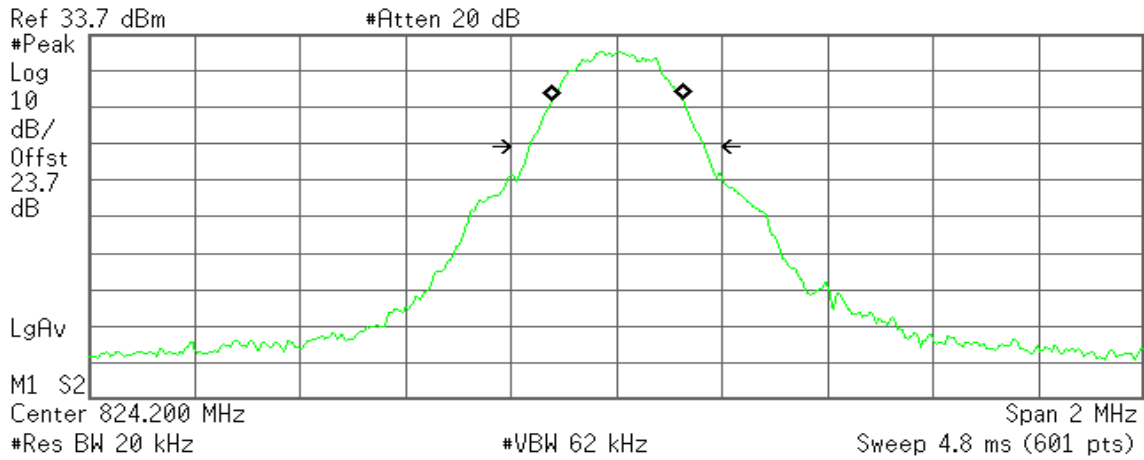

Occupied Bandwidth
248.2761 kHz

Occ BW % Pwr 99.00 %
x dB -26.00 dB

Transmit Freq Error 920.240 Hz
x dB Bandwidth 331.147 kHz

EDGE 850 (CH Mid)

Agilent 09:33:53 Mar 23, 2013

R T

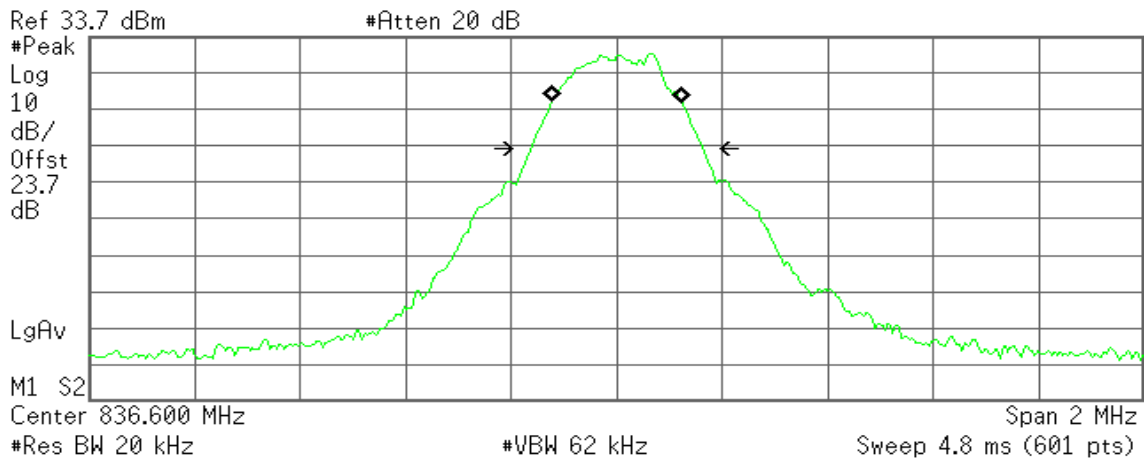

Occupied Bandwidth
248.8313 kHz

Occ BW % Pwr 99.00 %
x dB -26.00 dB

Transmit Freq Error 373.783 Hz
x dB Bandwidth 325.633 kHz



EDGE 850 (CH High)

Agilent 09:35:34 Mar 23, 2013

R T

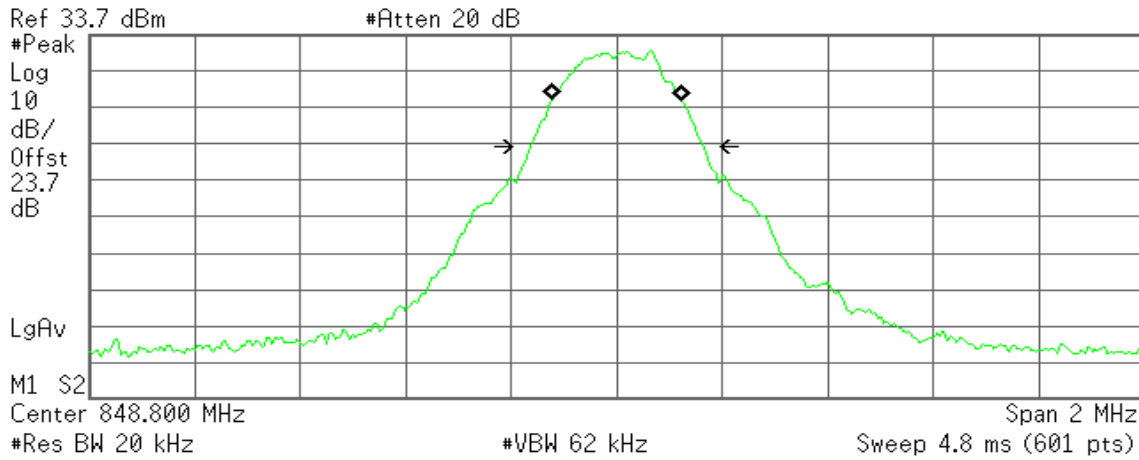

Occupied Bandwidth
247.1795 kHz

Occ BW % Pwr 99.00 %
x dB -26.00 dB

Transmit Freq Error 1.148 kHz
x dB Bandwidth 327.875 kHz

EDGE 1900 (CH Low)

Agilent 09:41:21 Mar 23, 2013

R T

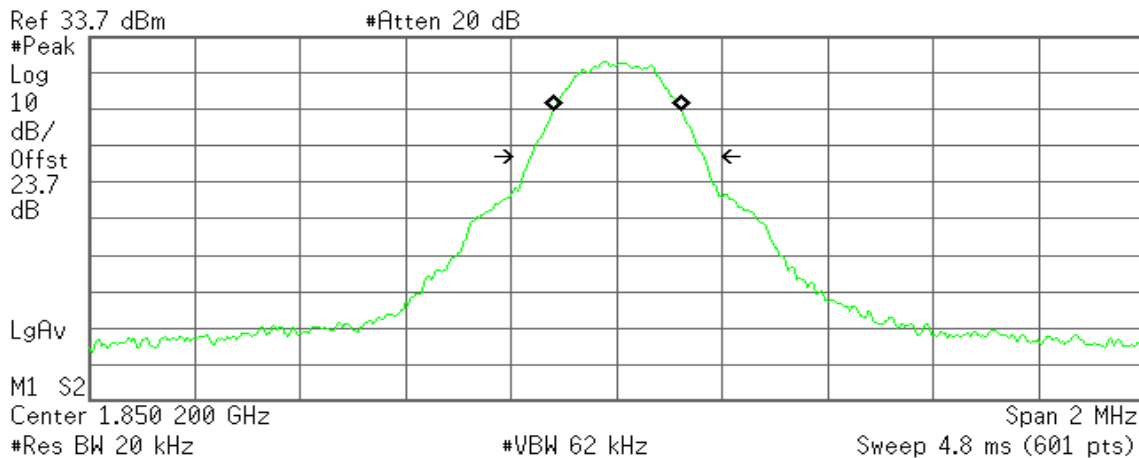

Occupied Bandwidth
243.6382 kHz

Occ BW % Pwr 99.00 %
x dB -26.00 dB

Transmit Freq Error 1.292 kHz
x dB Bandwidth 328.554 kHz



EDGE 1900 (CH Mid)

Agilent 09:42:22 Mar 23, 2013

R T

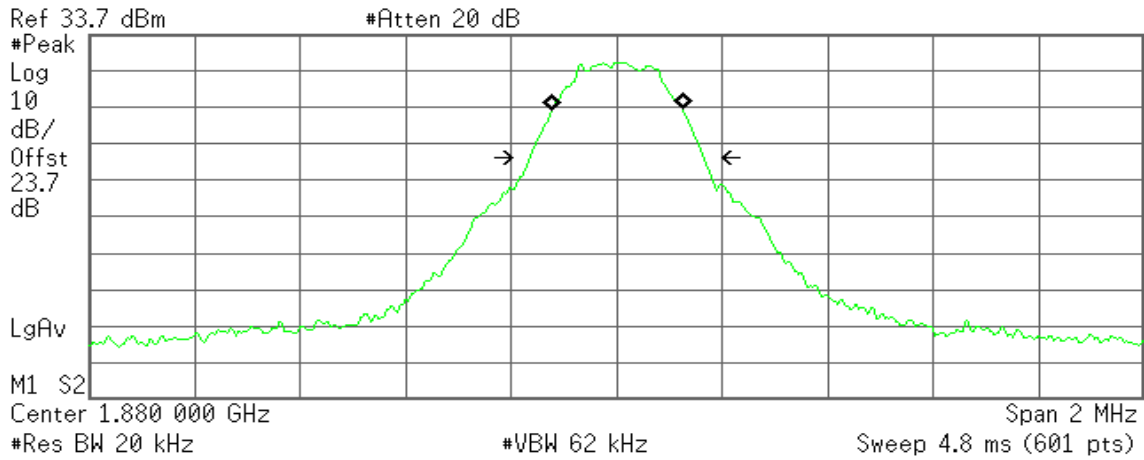

Occupied Bandwidth
247.9991 kHz

Occ BW % Pwr 99.00 %
x dB -26.00 dB

Transmit Freq Error 1.270 kHz
x dB Bandwidth 330.436 kHz

EDGE 1900 (CH High)

Agilent 09:43:05 Mar 23, 2013

R T

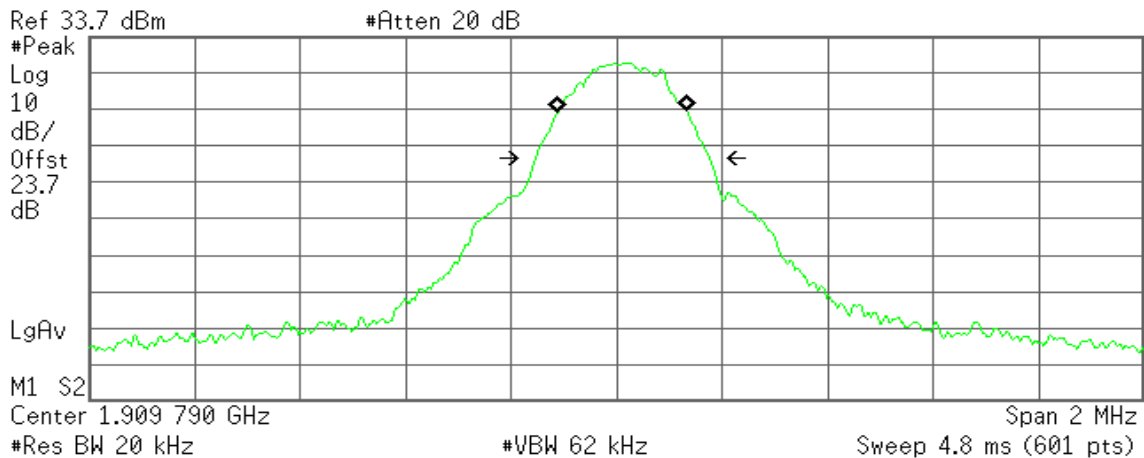

Occupied Bandwidth
247.2545 kHz

Occ BW % Pwr 99.00 %
x dB -26.00 dB

Transmit Freq Error 10.810 kHz
x dB Bandwidth 329.860 kHz



WCDMA Band II (CH Low)

Agilent 15:50:23 Mar 23, 2013

R T

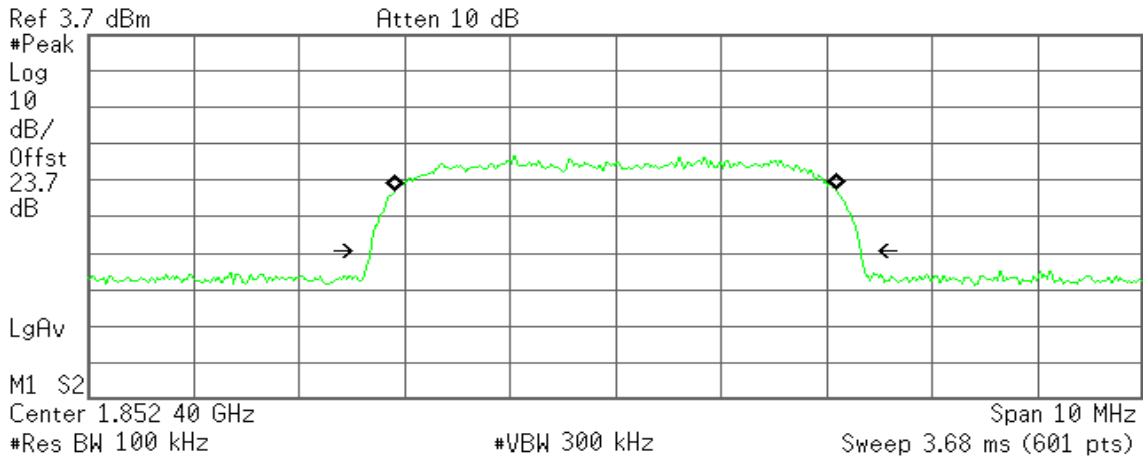

Occupied Bandwidth
4.1896 MHz

Occ BW % Pwr 99.00 %
x dB -26.00 dB

Transmit Freq Error -760.705 Hz
x dB Bandwidth 4.655 MHz

WCDMA Band II (CH Mid)

Agilent 15:51:37 Mar 23, 2013

R T

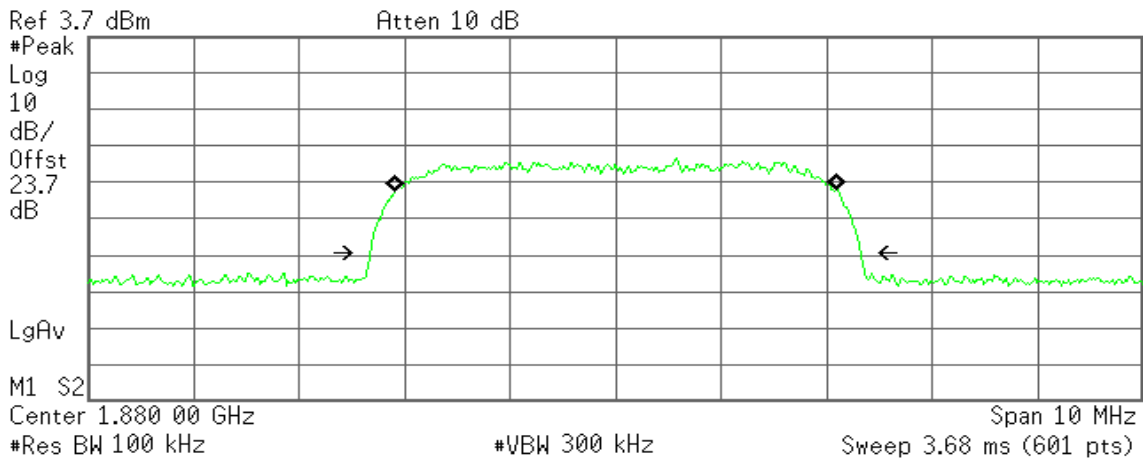

Occupied Bandwidth
4.2000 MHz

Occ BW % Pwr 99.00 %
x dB -26.00 dB

Transmit Freq Error 1.571 kHz
x dB Bandwidth 4.659 MHz



WCDMA Band II (CH High)

Agilent 15:56:29 Mar 23, 2013

R T

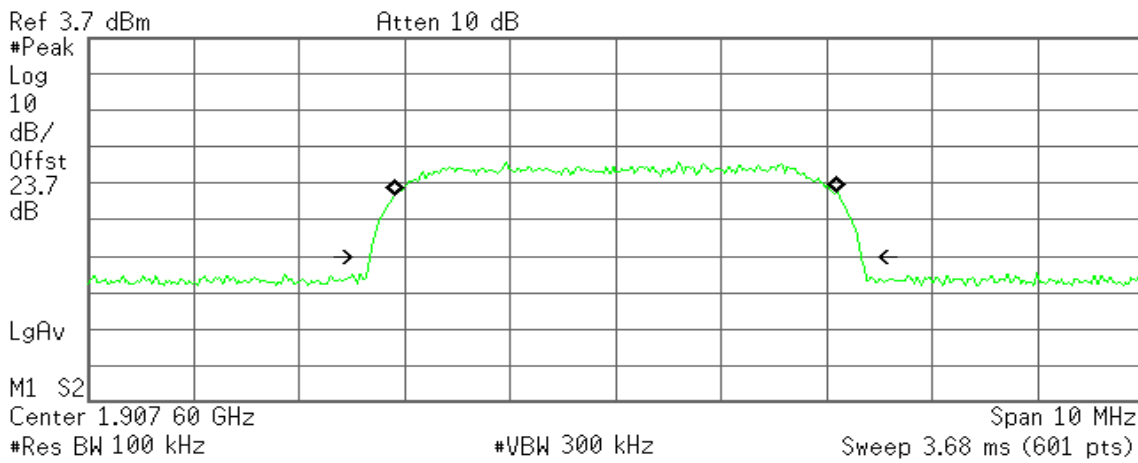

Occupied Bandwidth
4.2012 MHz

Occ BW % Pwr 99.00 %
x dB -26.00 dB

Transmit Freq Error 5.691 kHz
x dB Bandwidth 4.663 MHz

WCDMA Band V (CH Low)

Agilent 15:58:07 Mar 23, 2013

R T

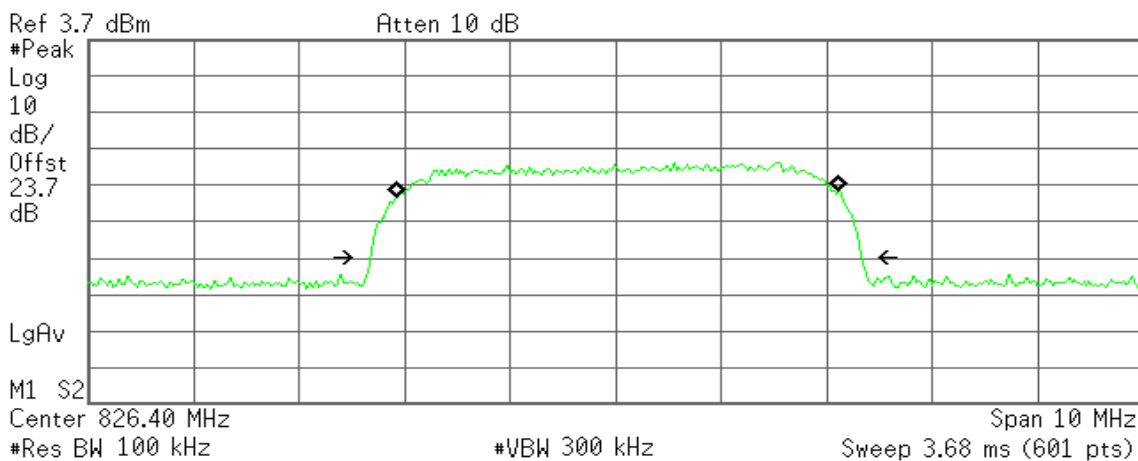

Occupied Bandwidth
4.2005 MHz

Occ BW % Pwr 99.00 %
x dB -26.00 dB

Transmit Freq Error 22.845 kHz
x dB Bandwidth 4.667 MHz



WCDMA Band V (CH Mid)

Agilent 16:01:01 Mar 23, 2013

R T

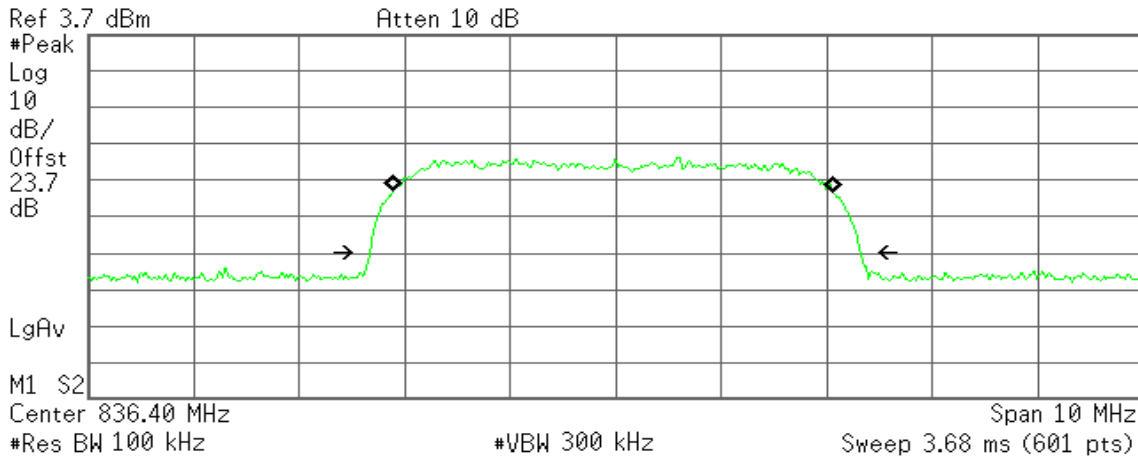

Occupied Bandwidth
4.1824 MHz

Occ BW % Pwr 99.00 %
x dB -26.00 dB

Transmit Freq Error -20.414 kHz
x dB Bandwidth 4.659 MHz

WCDMA Band V (CH High)

Agilent 16:01:39 Mar 23, 2013

R T

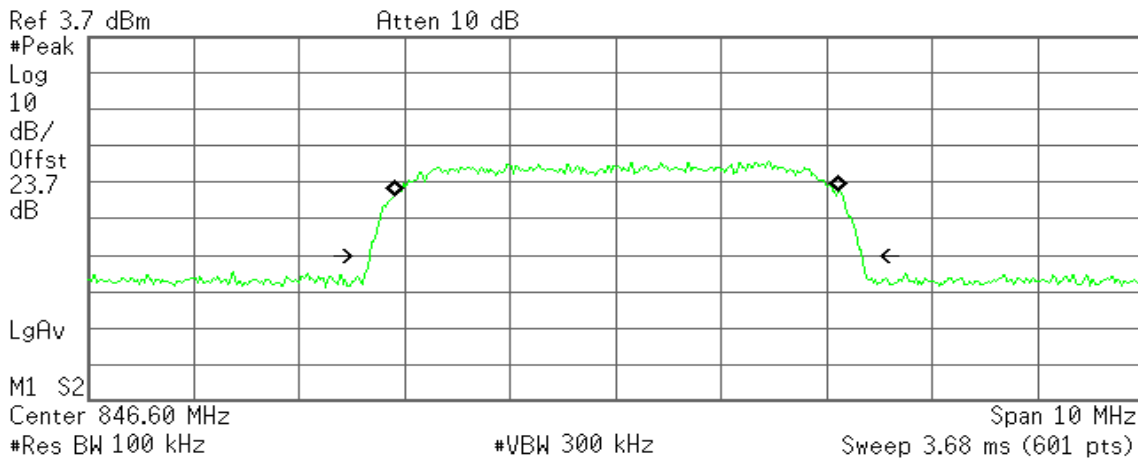

Occupied Bandwidth
4.2163 MHz

Occ BW % Pwr 99.00 %
x dB -26.00 dB

Transmit Freq Error 8.782 kHz
x dB Bandwidth 4.678 MHz



7.2 PEAK POWER

LIMIT

According to FCC §2.1046.

Test Configuration

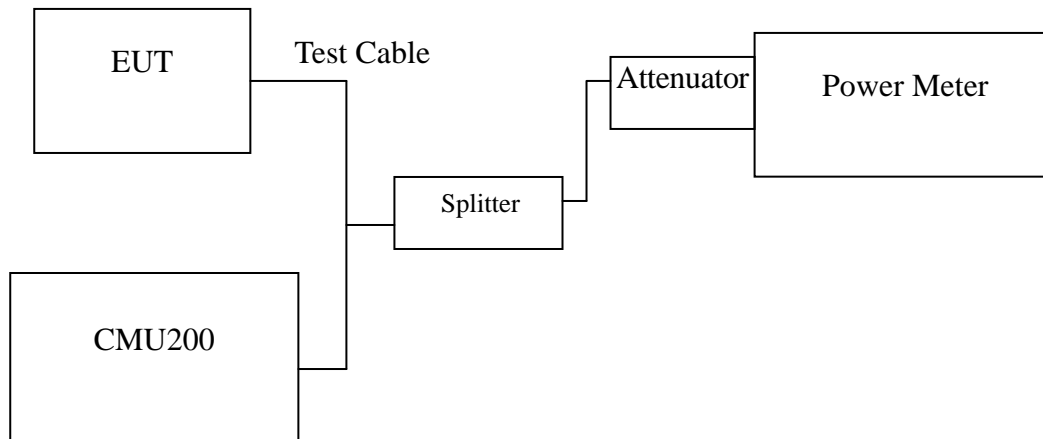

Remark: Measurement setup for testing on Antenna connector

TEST PROCEDURE

The transmitter output was connected to a calibrated attenuator, the other end of which was connected to a power meter. Transmitter output was read off the power meter in dBm. The power output at the transmitter antenna port was determined by adding the value of the attenuator to the power meter reading.

TEST RESULTS

No non-compliance noted.



Test Data

Test Mode	CH	Frequency (MHz)	Peak Power (dBm)	Output Power W
GPRS 850	128	824.20	32.70	1.86209
	190	836.60	32.70	1.86209
	251	848.80	32.80	1.90546
EDGE 850	128	824.20	29.30	0.85114
	190	836.60	29.30	0.85114
	251	848.80	29.10	0.81283

Test Mode	CH	Frequency (MHz)	Peak Power (dBm)	Output Power W
GPRS 1900	512	1850.20	29.30	0.85114
	661	1880.00	29.20	0.83176
	810	1909.80	29.20	0.83176
EDGE 1900	512	1850.20	27.70	0.58884
	661	1880.00	27.80	0.60256
	810	1909.80	27.90	0.61660

Test Mode	CH	Frequency (MHz)	Peak Power (dBm)	Output Power W
WCDMA (BAND II)	9262	1852.40	26.71	0.46881
	9400	1880.00	26.49	0.44566
	9538	1907.60	26.58	0.45499
WCDMA (BAND V)	4132	826.40	27.77	0.59841
	4182	836.40	28.20	0.66069
	4233	846.60	28.19	0.65917

Remark: The value of factor includes both the loss of cable and external attenuator



7.1 AVERAGE POWER

LIMIT

For reporting purposes only.

Test Configuration

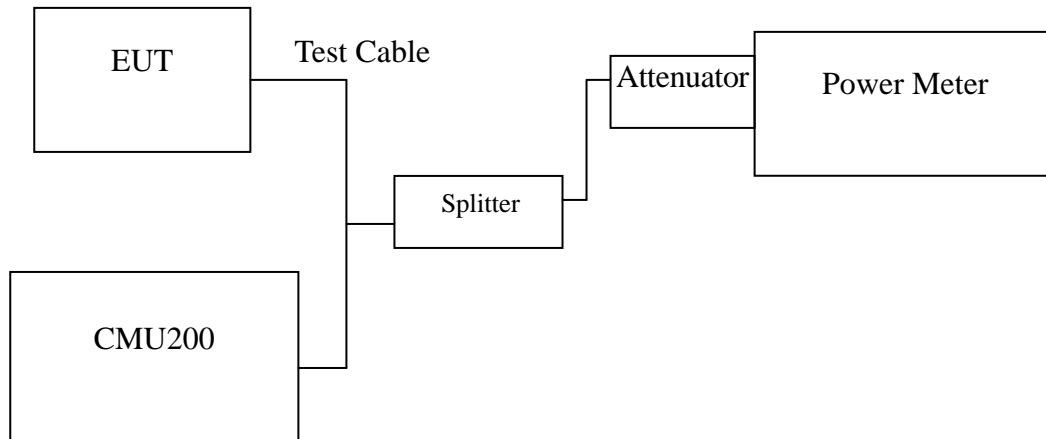

Remark: Measurement setup for testing on Antenna connector

TEST PROCEDURE

The transmitter output was connected to a calibrated attenuator, the other end of which was connected to a power meter. Transmitter output was read off the power meter in dBm. The power output at the transmitter antenna port was determined by adding the value of the attenuator to the power meter reading.

TEST RESULTS

No non-compliance noted.



Test Data

Test Mode	CH	Frequency (MHz)	AVG Power (dBm)	Output Power W
GPRS 850	128	824.20	29.69	0.93104
	190	836.60	29.69	0.93104
	251	848.80	29.79	0.95273
EDGE 850	128	824.20	26.29	0.42557
	190	836.60	26.29	0.42557
	251	848.80	26.09	0.40642

Test Mode	CH	Frequency (MHz)	AVG Power (dBm)	Output Power W
GPRS 1900	512	1850.20	23.28	0.21278
	661	1880.00	23.18	0.20794
	810	1909.80	23.18	0.20794
EDGE 1900	512	1850.20	21.68	0.14721
	661	1880.00	21.78	0.15064
	810	1909.80	21.88	0.15415

Test Mode	CH	Frequency (MHz)	AVG Power (dBm)	Output Power W
WCDMA (BAND II)	9262	1852.40	23.70	0.23442
	9400	1880.00	23.66	0.23227
	9538	1907.60	23.68	0.23335
WCDMA (BAND V)	4132	826.40	24.40	0.27542
	4182	836.40	24.47	0.27990
	4233	846.60	24.45	0.27861

Remark: The value of factor includes both the loss of cable and external attenuator



7.2 ERP & EIRP MEASUREMENT

LIMIT

According to FCC §2.1046

FCC 22.913(b): The Effective Radiated Power (ERP) of mobile transmitters must not exceed 7 Watts.

RSS-132 § 4.4 The maximum (ERP) shall be 6.3 Watts for mobile stations.

FCC 24.232(b): The equivalent Isotropic Radiated Power (EIRP) must not exceed 2 Watts.

RSS133 § 6.4: Mobile stations and hand-held portables are limited to 2 watts maximum (EIRP).

Test Configuration

Below 1 GHz

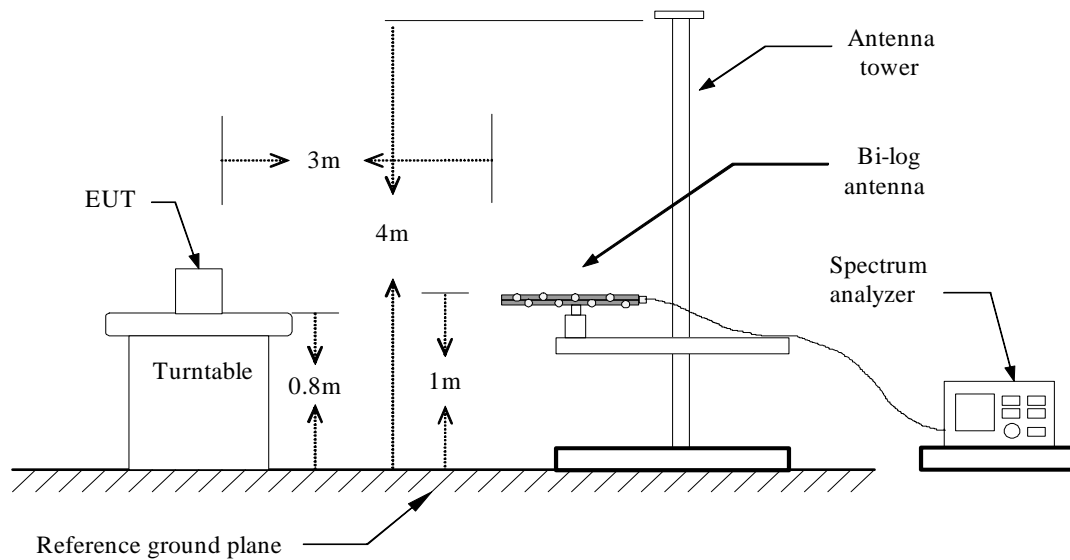

Above 1 GHz

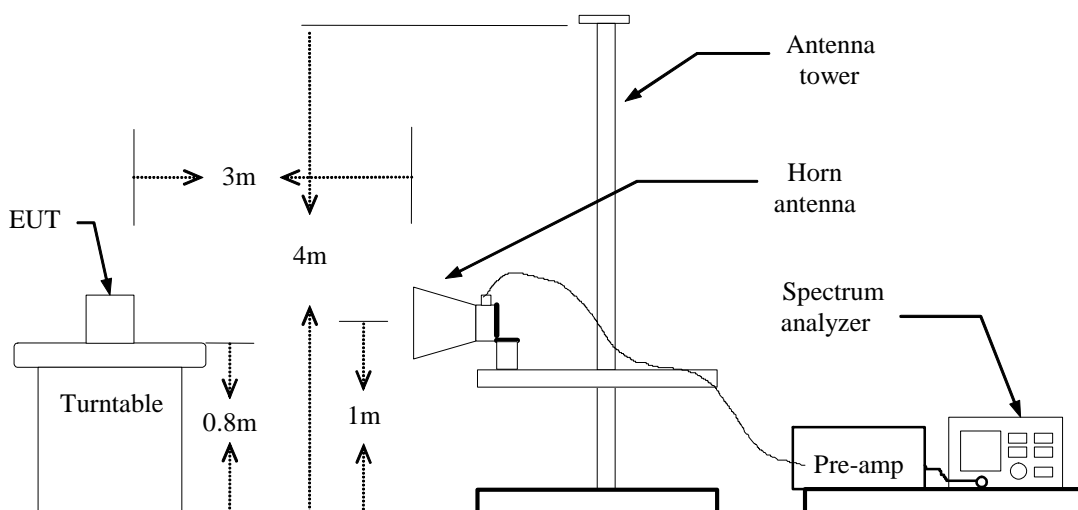



For Substituted Method Test Set-UP

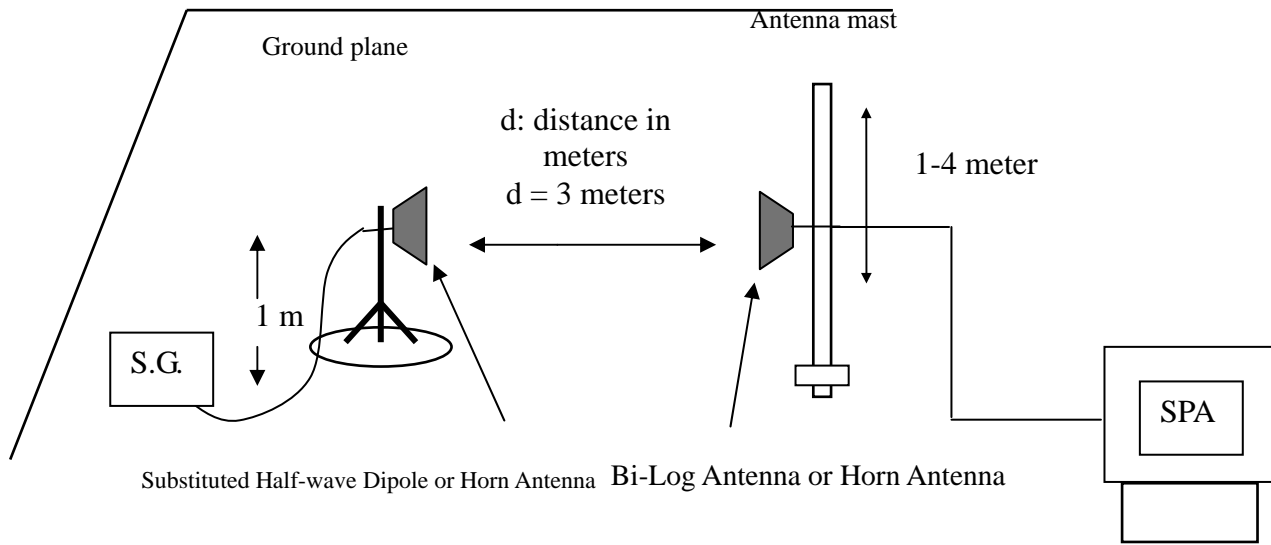

TEST PROCEDURE

The EUT was placed on a non-conductive turntable using a non-conductive support. The radiated emission at the fundamental frequency was measured at 3 m with a test antenna and EMI spectrum analyzer.

During the measurement of the EUT, the resolution bandwidth was set to 3MHz and the average bandwidth was set to 3MHz. The highest emission was recorded with the rotation of the turntable and the lowering of the test antenna. The reading was recorded and the field strength (E in dBuV/m) was calculated.

ERP in frequency band 824-849MHz, and EIRP in frequency band 1851.25 –1910MHz were measured using a substitution method. The EUT was replaced by half-wave dipole (824-849MHz) or horn antenna (1851.25-1910MHz) connected to a signal generator. The spectrum analyzer reading was recorded and ERP/EIRP was calculated as follows:

$$\text{ERP} = \text{S.G. output (dBm)} + \text{Antenna Gain (dBi)} - \text{Cable (dB)} - 2.15$$

$$\text{EIRP} = \text{S.G. output (dBm)} + \text{Antenna Gain (dBi)} - \text{Cable (dB)}$$

TEST RESULTS

No non-compliance noted.

**GPRS 850 TEST DATA**

Channel	Frequency (MHz)	Antenna Pol.	S.G. (dBm)	Cable loss (dB)	Ant.Gain (dBi)	Emission level (dBm)	Limit (dBm)	Margin (dB)
128	824.20	V	16.68	3.39	6.24	19.53	38.45	-18.92
	824.20	H	18.07	3.39	6.24	20.92	38.45	-17.53
190	836.60	V	17.82	3.4	6.36	20.78	38.45	-17.67
	836.60	H	17.94	3.4	6.36	20.90	38.45	-17.55
251	848.80	V	17.89	3.4	6.4	20.89	38.45	-17.56
	848.80	H	18	3.4	6.4	*21.00	38.45	-17.45

GPRS 1900 TEST DATA

Channel	Frequency (MHz)	Antenna Pol.	S.G. (dBm)	Cable loss (dB)	Ant.Gain (dBi)	Emission level (dBm)	Limit (dBm)	Margin (dB)
512	1850.20	V	21.41	5.37	5.67	21.71	33.00	-11.29
	1850.20	H	24.64	5.37	5.67	24.94	33.00	-8.06
661	1880.00	V	20.92	5.42	5.62	21.12	33.00	-11.88
	1880.00	H	26.21	5.42	5.62	26.41	33.00	-6.59
810	1909.80	V	23.44	5.48	5.56	23.52	33.00	-9.48
	1909.80	H	26.49	5.48	5.56	*26.57	33.00	-6.43

EDGE 850 Test Data

Channel	Frequency (MHz)	Antenna Pol.	S.G. (dBm)	Cable loss (dB)	Ant.Gain (dBi)	Emission level (dBm)	Limit (dBm)	Margin (dB)
128	824.20	V	16.64	3.39	6.24	19.49	38.45	-18.96
	824.20	H	18.07	3.39	6.24	20.92	38.45	-17.53
190	836.60	V	17.64	3.4	6.37	20.61	38.45	-17.84
	836.60	H	17.92	3.4	6.36	20.88	38.45	-17.57
251	848.80	V	17.89	3.4	6.4	20.89	38.45	-17.56
	848.80	H	17.99	3.4	6.4	*20.99	38.45	-17.46

EDGE 1900 Test Data

Channel	Frequency (MHz)	Antenna Pol.	S.G. (dBm)	Cable loss (dB)	Ant.Gain (dBi)	Emission level (dBm)	Limit (dBm)	Margin (dB)
512	1850.20	V	21.43	5.37	5.67	21.73	33.00	-11.27
	1850.20	H	24.65	5.37	5.67	24.95	33.00	-8.05
661	1880.00	V	21.41	5.42	5.62	21.61	33.00	-11.39
	1880.00	H	26.17	5.42	5.62	26.37	33.00	-6.63
810	1909.80	V	23.43	5.48	5.56	23.51	33.00	-9.49
	1909.80	H	26.51	5.48	5.56	*26.59	33.00	-6.41



WCDMA Test Data (BAND II)

Channel	Frequency (MHz)	Antenna Pol.	S.G. (dBm)	Cable loss (dB)	Ant.Gain (dBi)	Emission level (dBm)	Limit (dBm)	Margin (dB)
9262	1852.40	V	15.21	5.37	5.67	15.51	33.00	-17.49
	1852.40	H	13.93	5.37	5.67	14.23	33.00	-18.77
9400	1880.00	V	12.23	5.42	5.61	12.42	33.00	-20.58
	1880.00	H	13.36	5.42	5.61	13.55	33.00	-19.45
9538	1907.60	V	15.64	5.47	5.57	15.74	33.00	-17.26
	1907.60	H	14.38	5.47	5.57	*14.48	33.00	-18.52

WCDMA Test Data (BAND V)

Channel	Frequency (MHz)	Antenna Pol.	S.G. (dBm)	Cable loss (dB)	Ant.Gain (dBi)	Emission level (dBm)	Limit (dBm)	Margin (dB)
4132	826.40	V	16.51	3.39	6.27	19.39	38.45	-19.06
	826.40	H	17.73	3.39	6.27	*20.61	38.45	-17.84
4182	836.40	V	15.41	3.4	6.35	18.36	38.45	-20.09
	836.40	H	17.3	3.4	6.35	20.25	38.45	-18.20
4233	846.60	V	14.72	3.4	6.4	17.72	38.45	-20.73
	846.60	H	16.1	3.4	6.4	19.10	38.45	-19.35



7.3 OCCUPIED BANDWIDTH MEASUREMENT

LIMIT

According to §FCC 2.1049.

Test Configuration

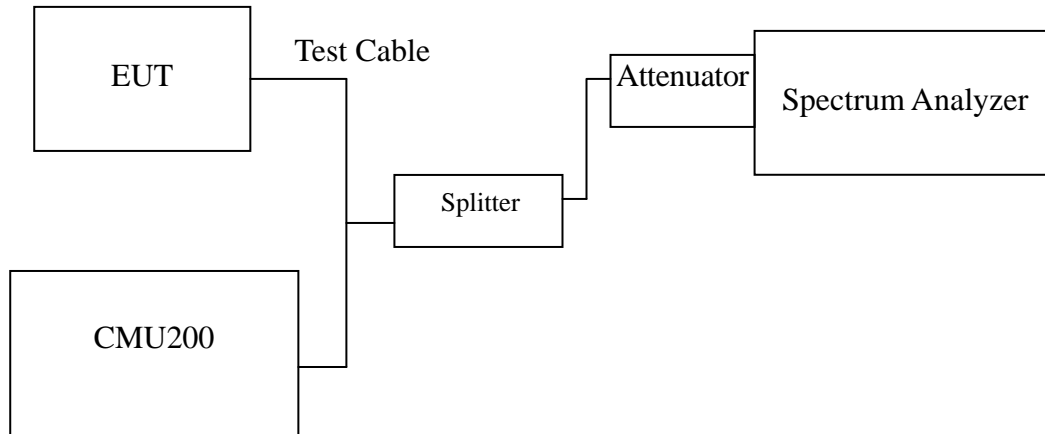

Remark: Measurement setup for testing on Antenna connector

TEST PROCEDURE

The EUT's output RF connector was connected with a short cable to the spectrum analyzer, RBW was set to about 1% of emission BW, VBW is set to 3 times the RBW, -26dBc display line was placed on the screen (or 99% bandwidth), the occupied bandwidth is the delta frequency between the two points where the display line intersects the signal trace.

TEST RESULTS

No non-compliance noted



Test Data

Test Mode	CH	Frequency (MHz)	99% Bandwidth (kHz)
GPRS 850	128	824.20	246.9473
	190	836.60	242.2995
	251	848.80	245.7376
EDGE 850	128	824.20	243.8002
	190	836.60	247.2487
	251	848.80	246.0641

Test Mode	CH	Frequency (MHz)	99% Bandwidth (kHz)
GPRS 1900	512	1850.20	239.7753
	661	1880.00	243.4224
	810	1909.80	242.1958
EDGE 1900	512	1850.20	242.7806
	661	1880.00	241.6970
	810	1909.80	247.6306

Test Mode	CH	Frequency (MHz)	99% Bandwidth (MHz)
WCDMA (Band II)	9262	1852.40	4.1806
	9400	1880.00	4.2129
	9538	1907.60	4.1872
WCDMA (Band V)	4132	826.40	4.1836
	4182	836.40	4.1909
	4233	846.60	4.2086



Test Plot

GPRS 850 (CH Low)

Agilent 10:07:09 Mar 11, 2013

R T

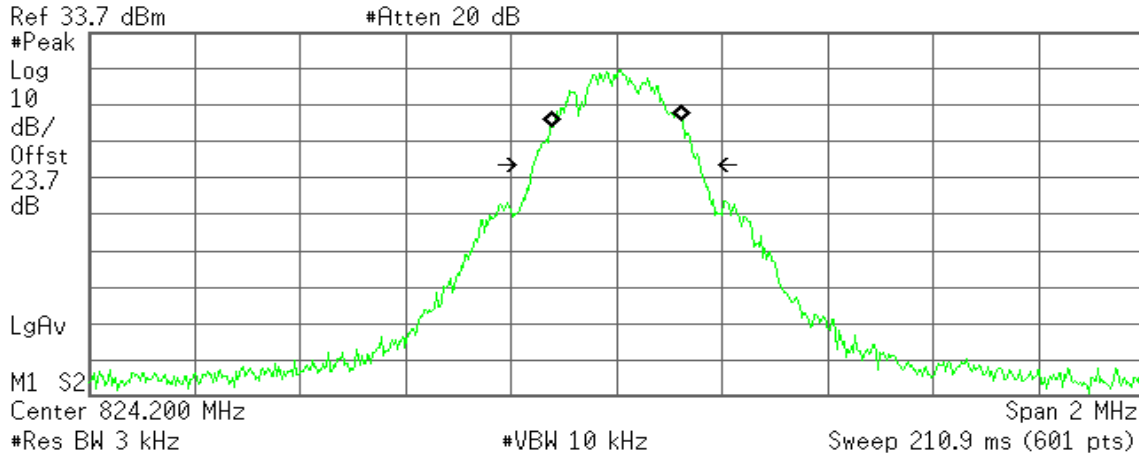

Occupied Bandwidth
246.9473 kHz

Occ BW % Pwr 99.00 %
x dB -26.00 dB

Transmit Freq Error 1.503 kHz
x dB Bandwidth 316.625 kHz

GPRS 850 (CH Mid)

Agilent 10:06:35 Mar 11, 2013

R T

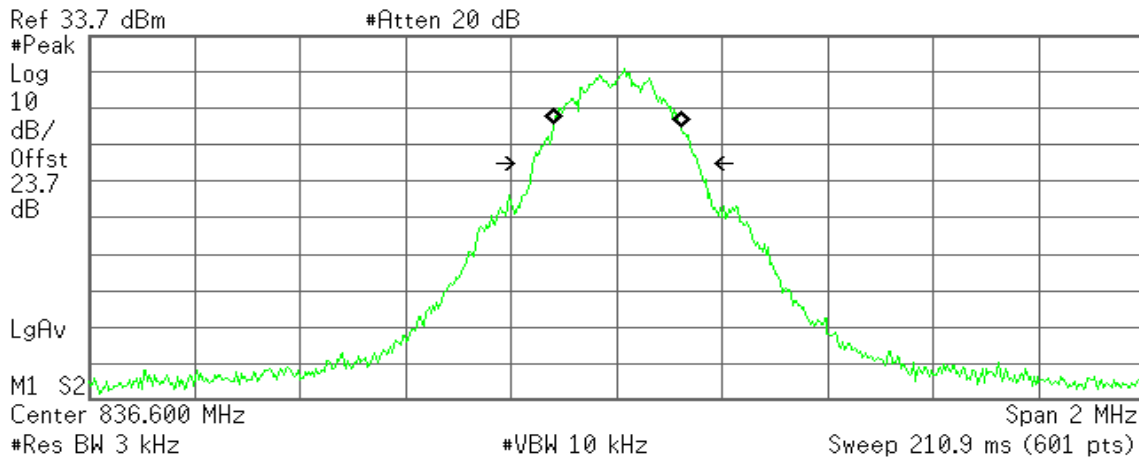

Occupied Bandwidth
242.2995 kHz

Occ BW % Pwr 99.00 %
x dB -26.00 dB

Transmit Freq Error 1.211 kHz
x dB Bandwidth 313.981 kHz



GPRS 850(CH High)

Agilent 10:05:37 Mar 11, 2013

R T

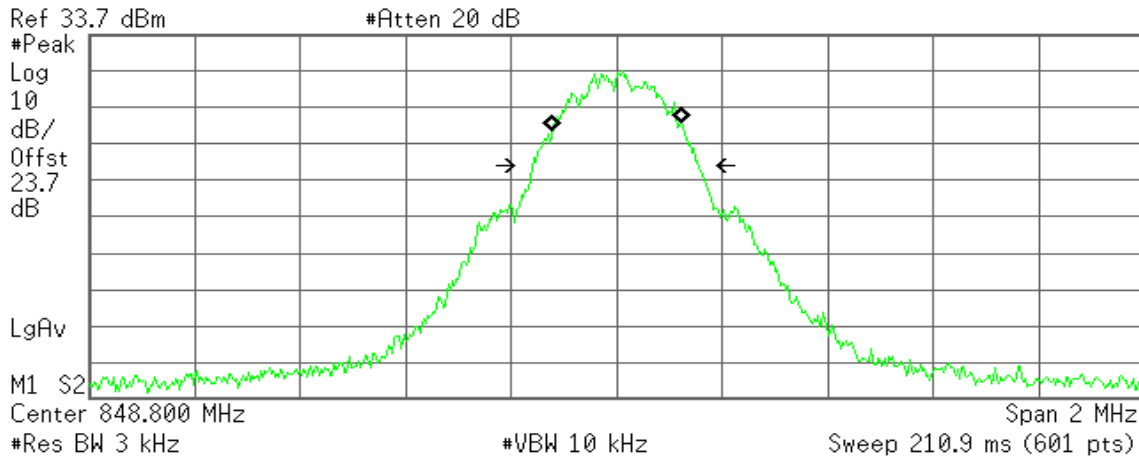

Occupied Bandwidth
245.7376 kHz

Occ BW % Pwr 99.00 %
x dB -26.00 dB

Transmit Freq Error 1.199 kHz
x dB Bandwidth 315.237 kHz

GPRS 1900 (CH Low)

Agilent 10:46:47 Mar 11, 2013

R T

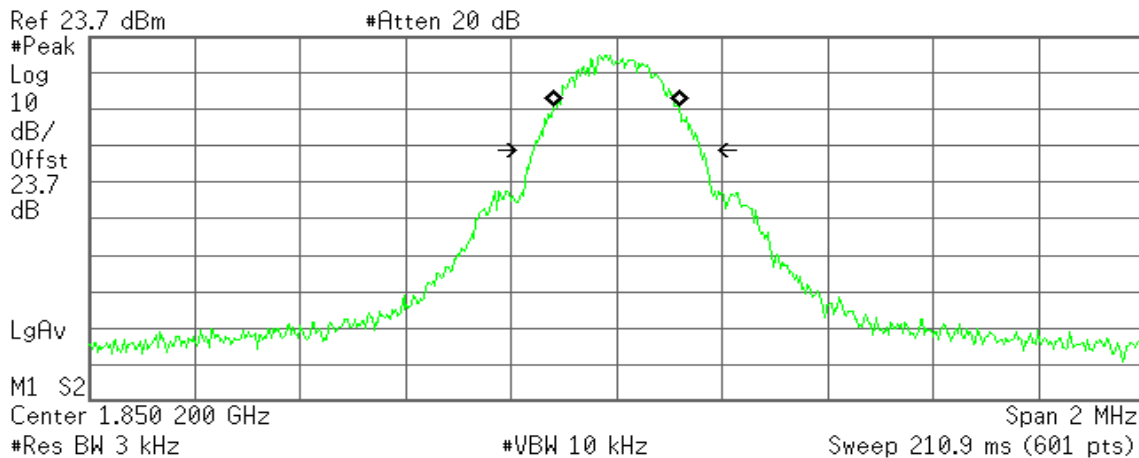

Occupied Bandwidth
239.7753 kHz

Occ BW % Pwr 99.00 %
x dB -26.00 dB

Transmit Freq Error -230.076 Hz
x dB Bandwidth 316.490 kHz



GPRS 1900 (CH Mid)

Agilent 10:47:40 Mar 11, 2013

R T

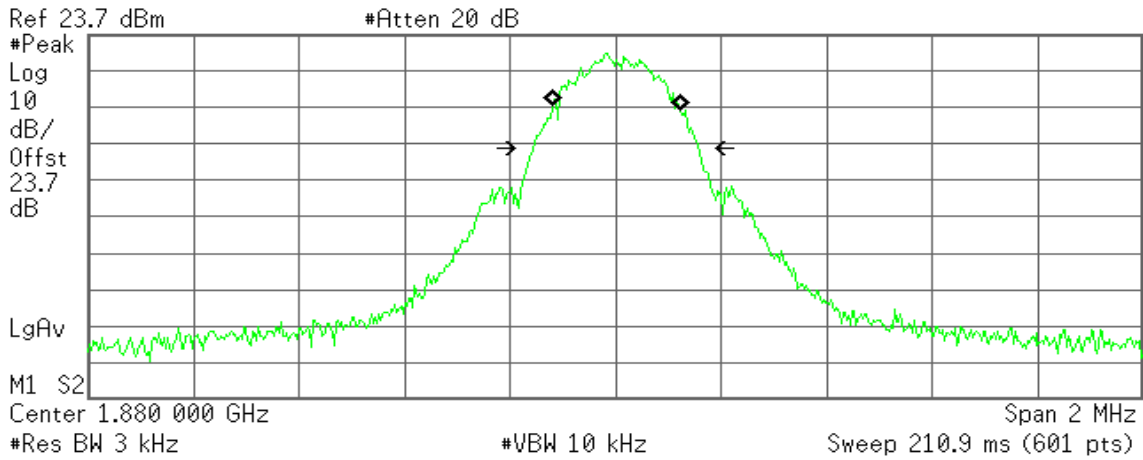

Occupied Bandwidth
243.4224 kHz

Occ BW % Pwr 99.00 %
x dB -26.00 dB

Transmit Freq Error 2.009 kHz
x dB Bandwidth 314.604 kHz

GPRS 1900 (CH High)

Agilent 11:07:16 Mar 11, 2013

R T

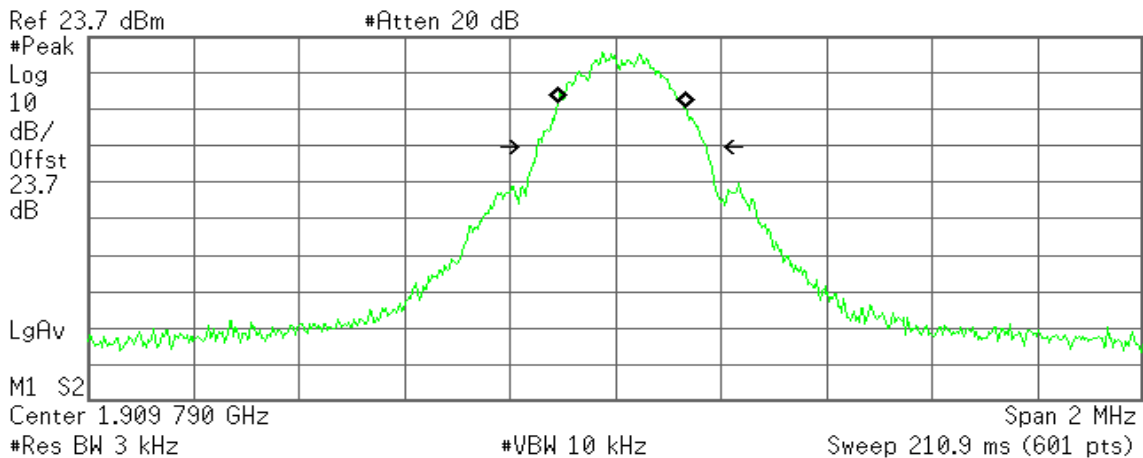

Occupied Bandwidth
242.1958 kHz

Occ BW % Pwr 99.00 %
x dB -26.00 dB

Transmit Freq Error 11.809 kHz
x dB Bandwidth 320.886 kHz



EDGE 850 (CH Low)

Agilent 10:37:50 Mar 11, 2013

R T

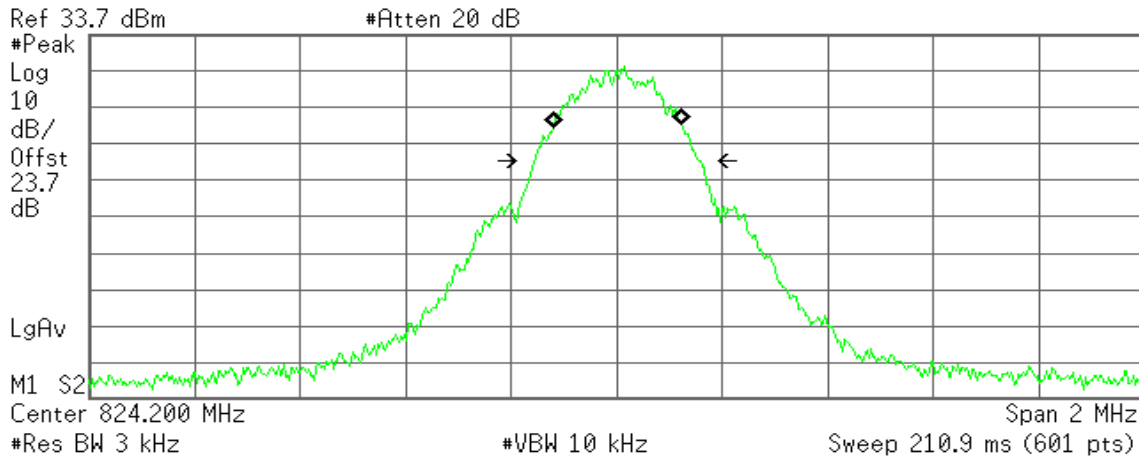

Occupied Bandwidth
243.8002 kHz

Occ BW % Pwr 99.00 %
x dB -26.00 dB

Transmit Freq Error 1.556 kHz
x dB Bandwidth 317.444 kHz

EDGE 850 (CH Mid)

Agilent 10:38:29 Mar 11, 2013

R T

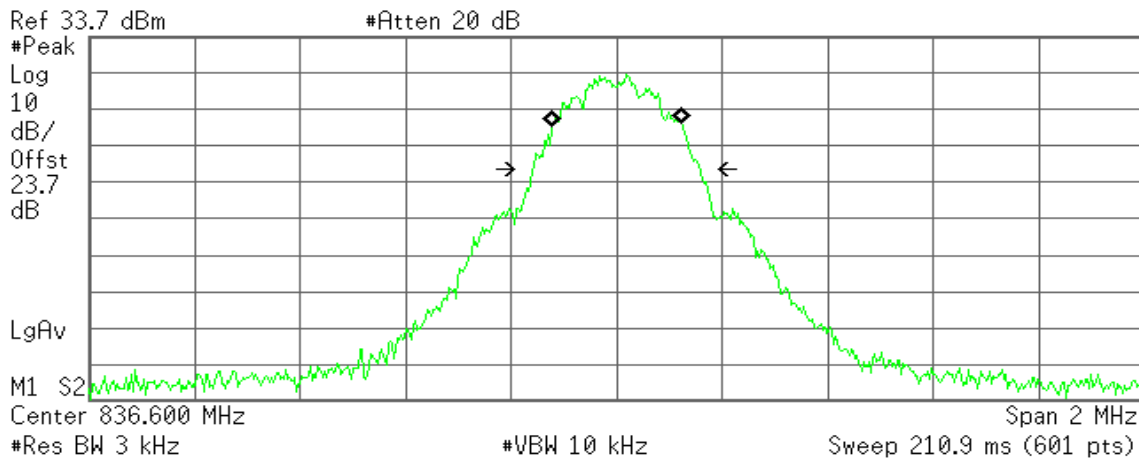

Occupied Bandwidth
247.2487 kHz

Occ BW % Pwr 99.00 %
x dB -26.00 dB

Transmit Freq Error 1.216 kHz
x dB Bandwidth 317.601 kHz



EDGE 850 (CH High)

Agilent 10:39:18 Mar 11, 2013

R T

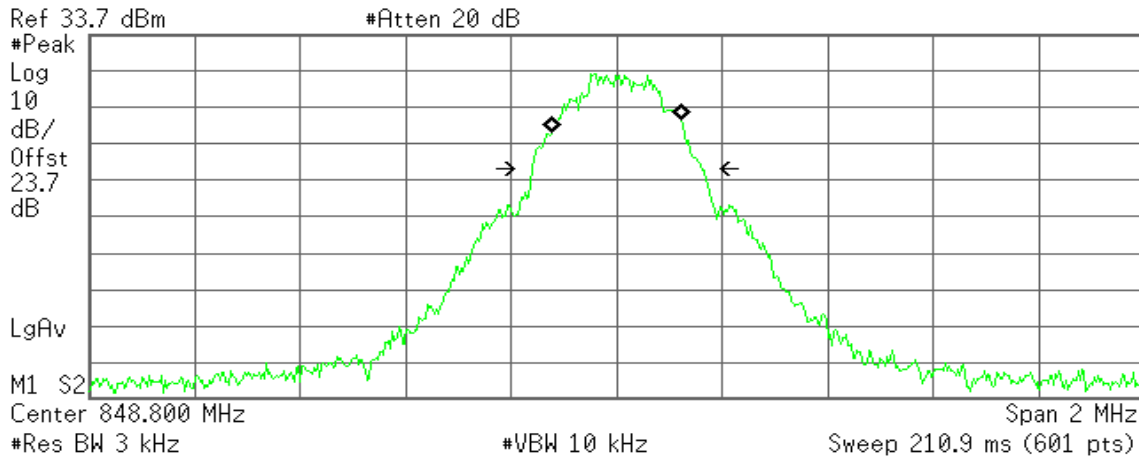

Occupied Bandwidth
246.0641 kHz

Occ BW % Pwr 99.00 %
x dB -26.00 dB

Transmit Freq Error 217.179 Hz
x dB Bandwidth 323.012 kHz

EDGE 1900 (CH Low)

Agilent 10:46:00 Mar 11, 2013

R T

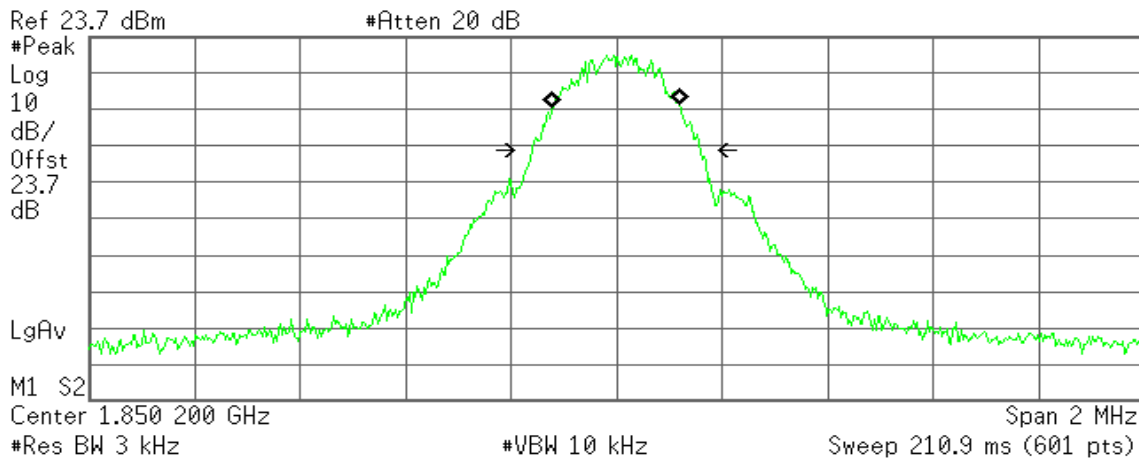

Occupied Bandwidth
242.7806 kHz

Occ BW % Pwr 99.00 %
x dB -26.00 dB

Transmit Freq Error -662.881 Hz
x dB Bandwidth 320.491 kHz



EDGE 1900 (CH Mid)

Agilent 10:48:16 Mar 11, 2013

R T

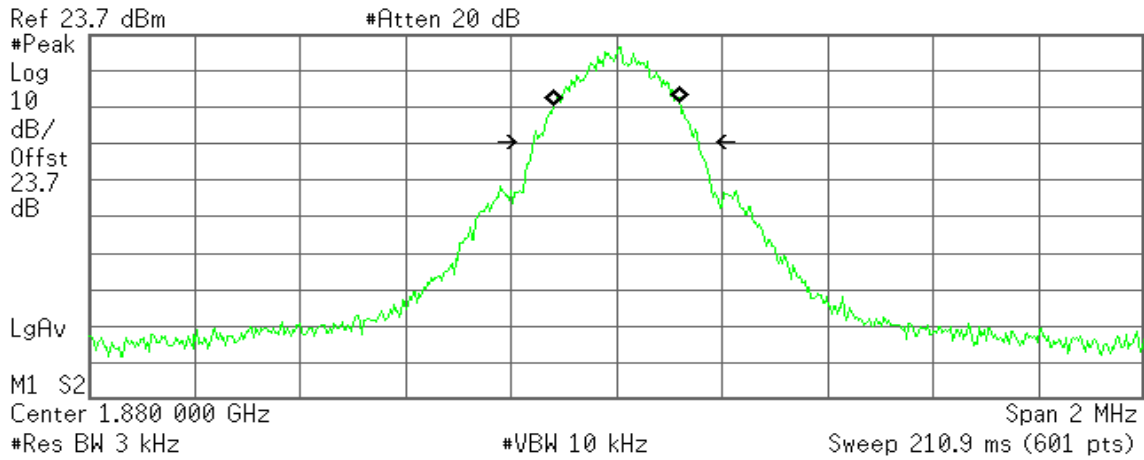

Occupied Bandwidth
241.6970 kHz

Occ BW % Pwr 99.00 %
x dB -26.00 dB

Transmit Freq Error 306.993 Hz
x dB Bandwidth 313.503 kHz

EDGE 1900 (CH High)

Agilent 11:06:02 Mar 11, 2013

R T

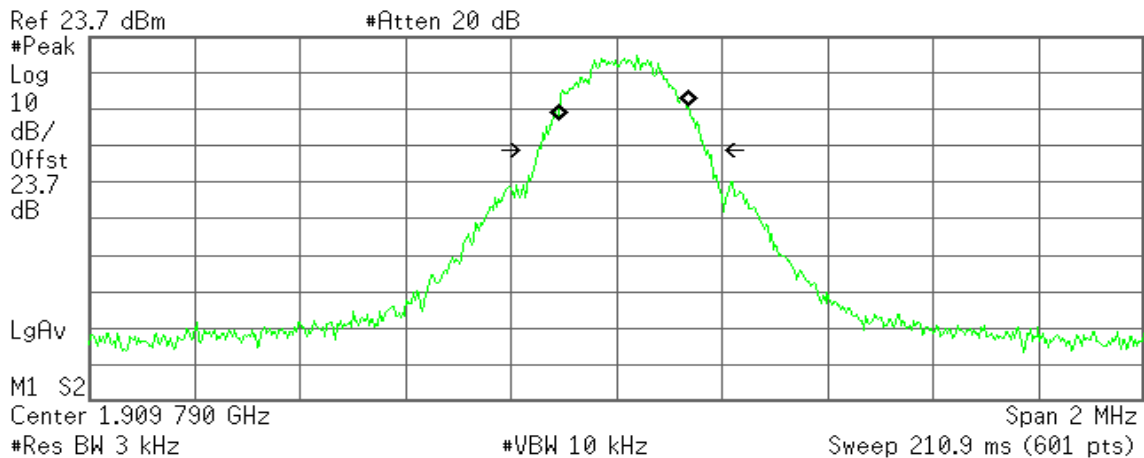

Occupied Bandwidth
247.6306 kHz

Occ BW % Pwr 99.00 %
x dB -26.00 dB

Transmit Freq Error 12.290 kHz
x dB Bandwidth 322.485 kHz



WCDMA Band II (CH Low)

Agilent 15:49:26 Mar 11, 2013

R T

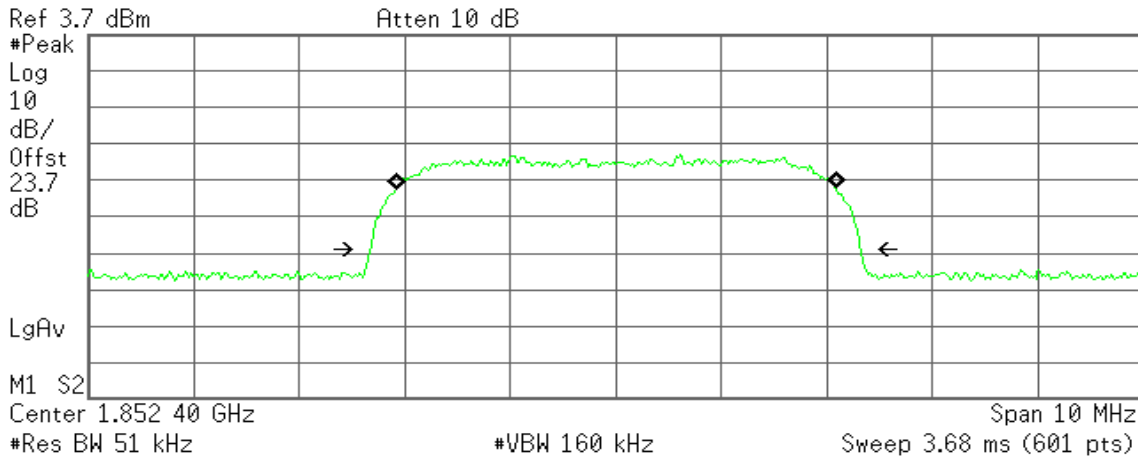

Occupied Bandwidth
4.1806 MHz

Occ BW % Pwr 99.00 %
x dB -26.00 dB

Transmit Freq Error 1.886 kHz
x dB Bandwidth 4.660 MHz

WCDMA Band II (CH Mid)

Agilent 15:52:18 Mar 11, 2013

R T

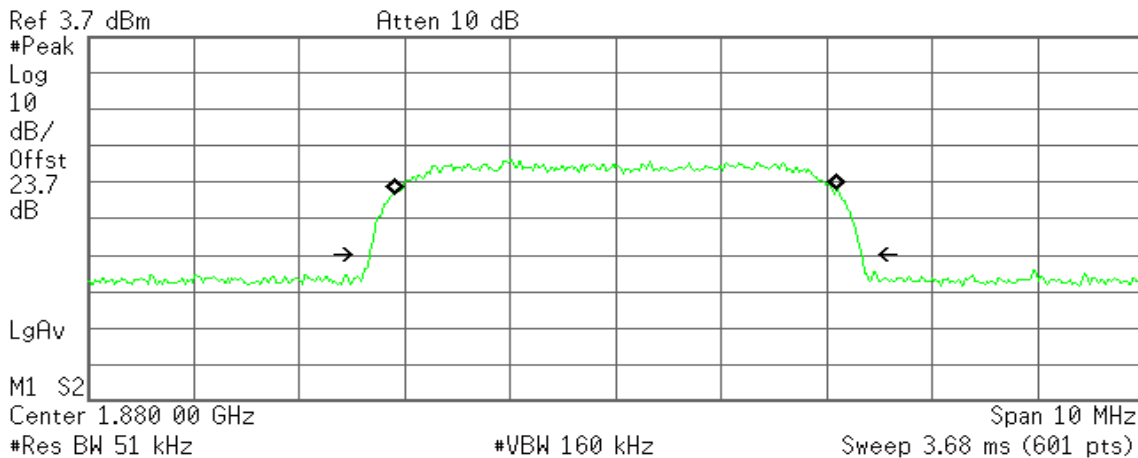

Occupied Bandwidth
4.2129 MHz

Occ BW % Pwr 99.00 %
x dB -26.00 dB

Transmit Freq Error 938.165 Hz
x dB Bandwidth 4.677 MHz



WCDMA Band II (CH High)

Agilent 15:55:45 Mar 11, 2013

R T

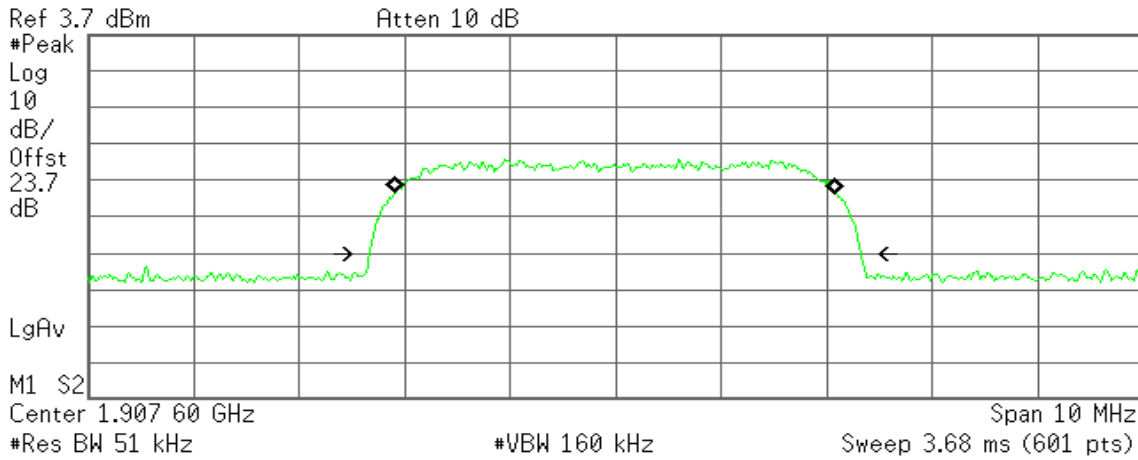

Occupied Bandwidth
4.1872 MHz

Occ BW % Pwr 99.00 %
x dB -26.00 dB

Transmit Freq Error -3.292 kHz
x dB Bandwidth 4.671 MHz

WCDMA Band V (CH Low)

Agilent 15:59:00 Mar 11, 2013

R T

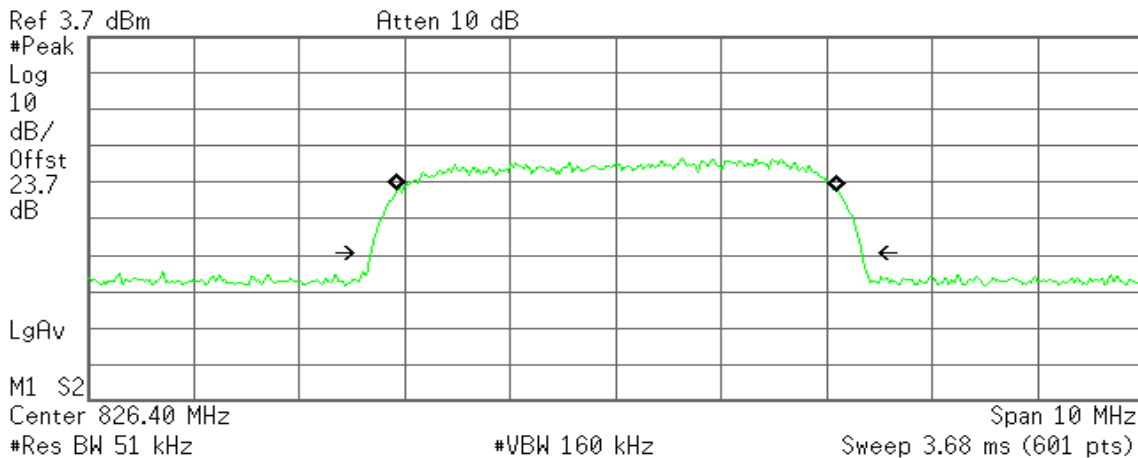

Occupied Bandwidth
4.1836 MHz

Occ BW % Pwr 99.00 %
x dB -26.00 dB

Transmit Freq Error 14.986 kHz
x dB Bandwidth 4.663 MHz



WCDMA Band V (CH Mid)

Agilent 16:00:29 Mar 11, 2013

R T

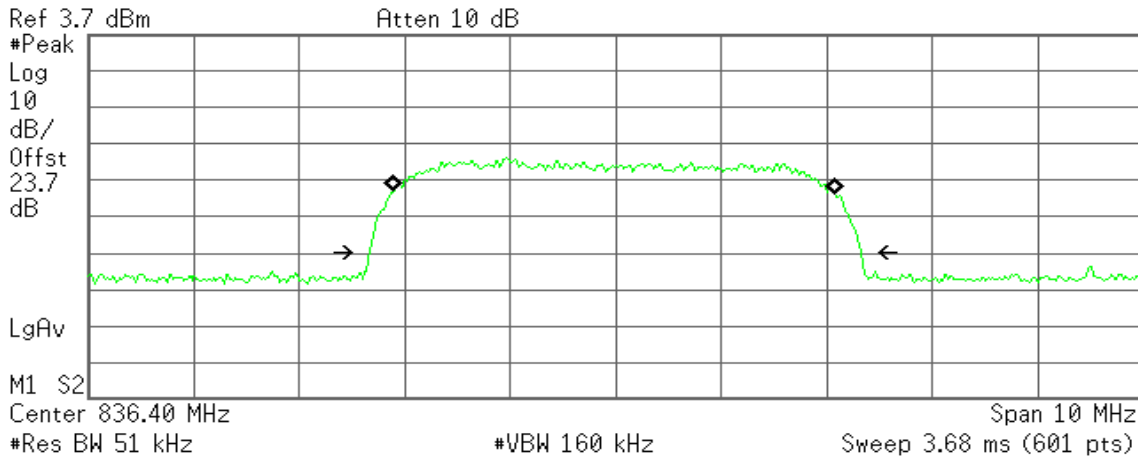

Occupied Bandwidth
4.1909 MHz

Occ BW % Pwr 99.00 %
x dB -26.00 dB

Transmit Freq Error -16.294 kHz
x dB Bandwidth 4.673 MHz

WCDMA Band V (CH High)

Agilent 16:02:09 Mar 11, 2013

R T

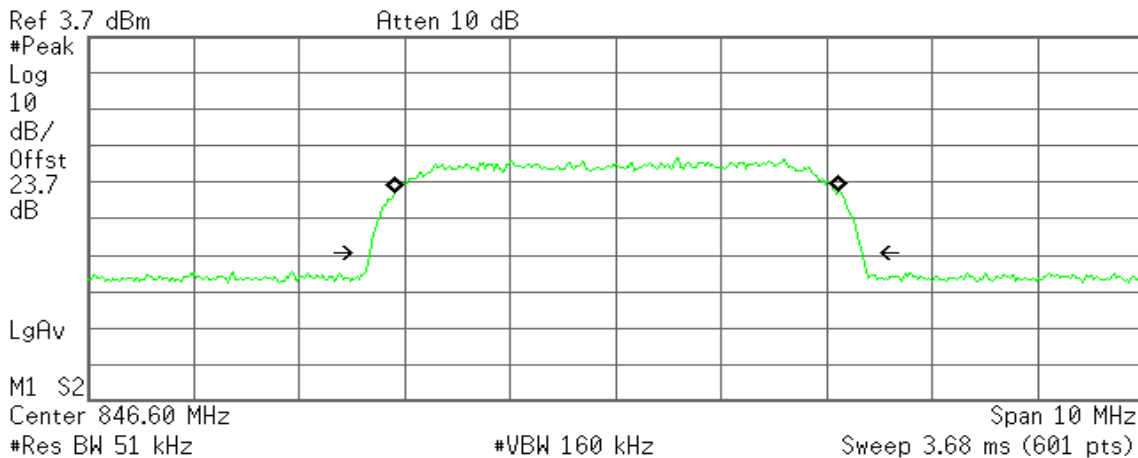

Occupied Bandwidth
4.2086 MHz

Occ BW % Pwr 99.00 %
x dB -26.00 dB

Transmit Freq Error 8.271 kHz
x dB Bandwidth 4.678 MHz



7.4 OUT OF BAND EMISSION AT ANTENNA TERMINALS

LIMIT

According to FCC §2.1051, FCC §22.917, FCC §24.238(a). RSS-132 (4.5.2), RSS-133 (6.6).

Out of Band Emissions: The mean power of emission must be attenuated below the mean power of the non-modulated carrier (P) on any frequency twice or more than twice the fundamental frequency by at least $43 + 10 \log P$ dB.

Mobile Emissions in Base Frequency Range: The mean power of any emissions appearing in the base station frequency range from cellular mobile transmitters operated must be attenuated to a level not exceed -80 dBm at the transmit antenna connector.

Band Edge Requirements: In the 1MHz bands immediately outside and adjacent to the frequency block, a resolution bandwidth of at least 1% of the emission bandwidth of the fundamental emission of the transmitter may be employed to measure the Out of band Emission

Test Configuration

Out of band emission at antenna terminals:

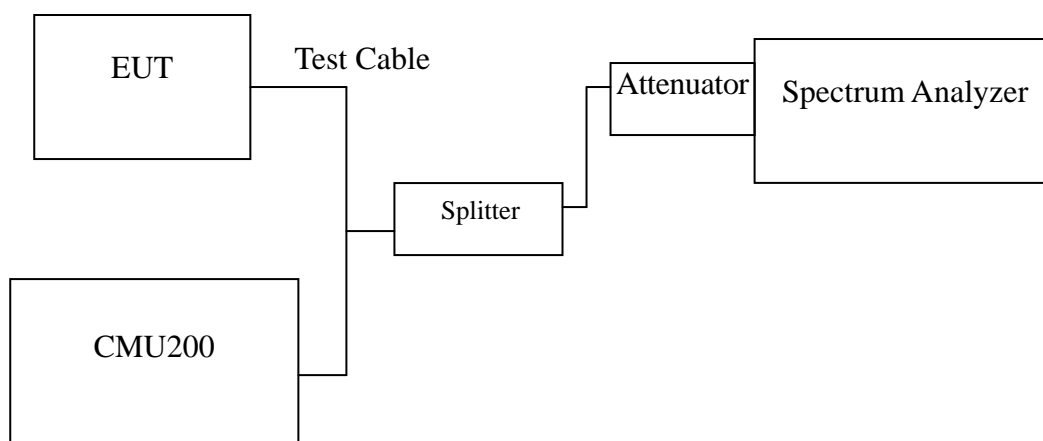

TEST PROCEDURE

The RF output of the transceiver was connected to a spectrum analyzer through appropriate attenuation. The resolution bandwidth of the spectrum analyzer was set at 1MHz, sufficient scans were taken to show the out of band Emissions if any up to 10th harmonic.

For the out of band: Set the RBW, VBW = 1MHz, Start=30MHz, Stop= 10 th harmonic. Limit = -13 dBm

Band Edge Requirements (824 MHz and 849 MHz /1850MHz and 1910MHz): In the 1 MHz bands immediately outside and adjacent to the frequency block, a resolution bandwidth of at least 1 percent of the emission bandwidth of the fundamental emission of the transmitter may be employed to measure the out of band Emissions. Limit, -13 dBm.

TEST RESULTS

No non-compliance noted.



Test Data

Mode	CH	Location	Description
GPRS 850	128	Figure 7-1	Conducted spurious emissions, 30MHz - 20GHz
	190	Figure 7-2	Conducted spurious emissions, 30MHz - 20GHz
	251	Figure 7-3	Conducted spurious emissions, 30MHz - 20GHz

Mode	CH	Location	Description
GPRS 1900	512	Figure 8-1	Conducted spurious emissions, 30MHz - 20GHz
	661	Figure 8-2	Conducted spurious emissions, 30MHz - 20GHz
	810	Figure 8-3	Conducted spurious emissions, 30MHz - 20GHz

Mode	CH	Location	Description
GPRS 850	128	Figure 9-1	Band Edge emissions
	251	Figure 9-2	Band Edge emissions

Mode	CH	Location	Description
GPRS 1900	512	Figure 10-1	Band Edge emissions
	810	Figure 10-2	Band Edge emissions



Mode	CH	Location	Description
EDGE 850	128	Figure 11-1	Conducted spurious emissions, 30MHz - 20GHz
	190	Figure 11-2	Conducted spurious emissions, 30MHz - 20GHz
	251	Figure 11-3	Conducted spurious emissions, 30MHz - 20GHz
EDGE 1900	512	Figure 12-1	Conducted spurious emissions, 30MHz - 20GHz
	661	Figure 12-2	Conducted spurious emissions, 30MHz - 20GHz
	810	Figure 12-3	Conducted spurious emissions, 30MHz - 20GHz

Mode	CH	Location	Description
EDGE 850	128	Figure 13-1	Band Edge emissions
	251	Figure 13-2	Band Edge emissions
EDGE 1900	512	Figure 14-1	Band Edge emissions
	810	Figure 14-2	Band Edge emissions

Mode	CH	Location	Description
WCDMA (Band II)	9262	Figure 15-1	Conducted spurious emissions, 30MHz - 20GHz
	9400	Figure 15-2	Conducted spurious emissions, 30MHz - 20GHz
	9538	Figure 15-3	Conducted spurious emissions, 30MHz - 20GHz
WCDMA (Band V)	4132	Figure 16-1	Conducted spurious emissions, 30MHz - 20GHz
	4182	Figure 16-2	Conducted spurious emissions, 30MHz - 20GHz
	4233	Figure 16-3	Conducted spurious emissions, 30MHz - 20GHz

Mode	CH	Location	Description
WCDMA (Band II)	9262	Figure 17-1	Band Edge emissions
	9538	Figure 17-2	Band Edge emissions
WCDMA (Band V)	4132	Figure 18-1	Band Edge emissions
	4233	Figure 18-2	Band Edge emissions



Test Plot

GPRS 850

Figure 7-1: Out of Band emission at antenna terminals – GPRS CH Low

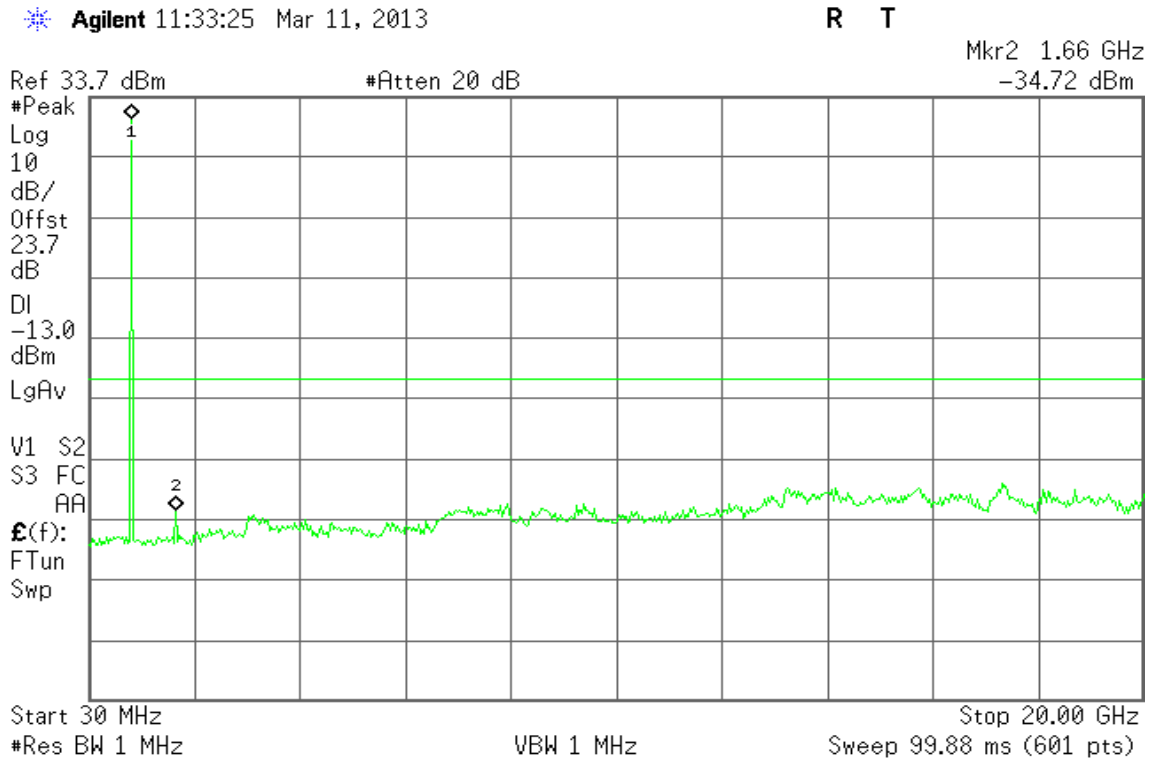

Figure 7-2: Out of Band emission at antenna terminals – GPRS CH Mid

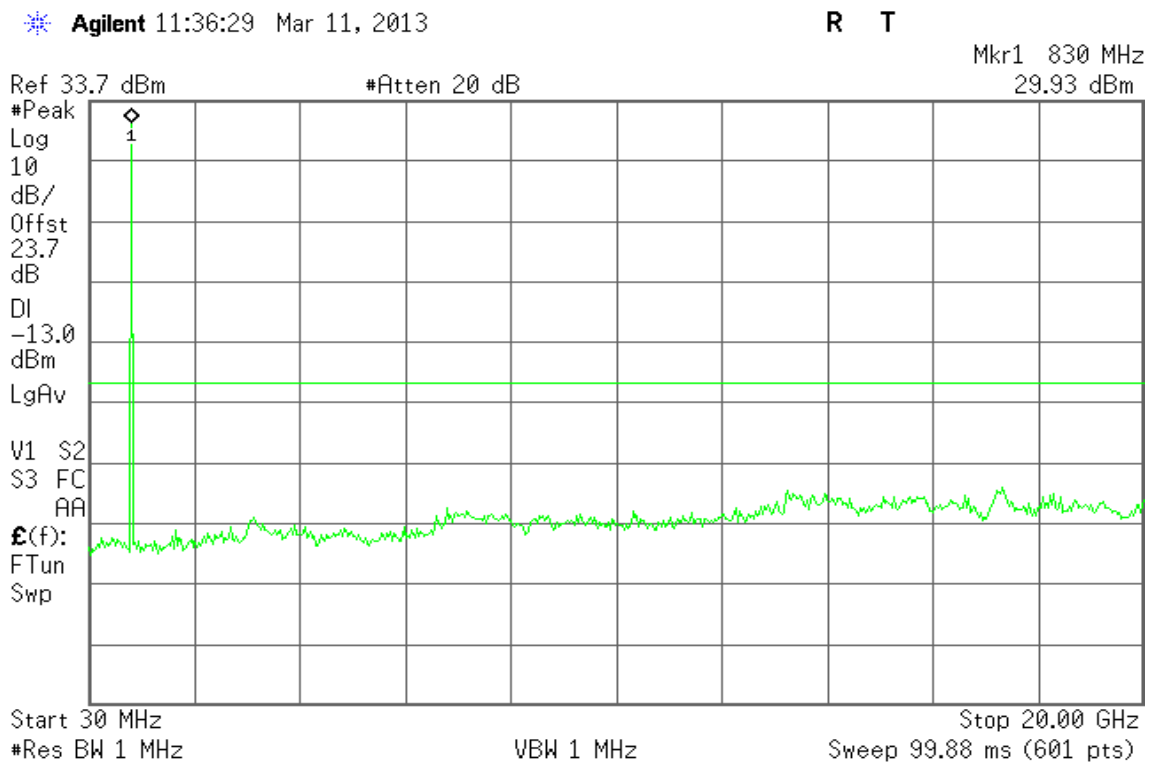
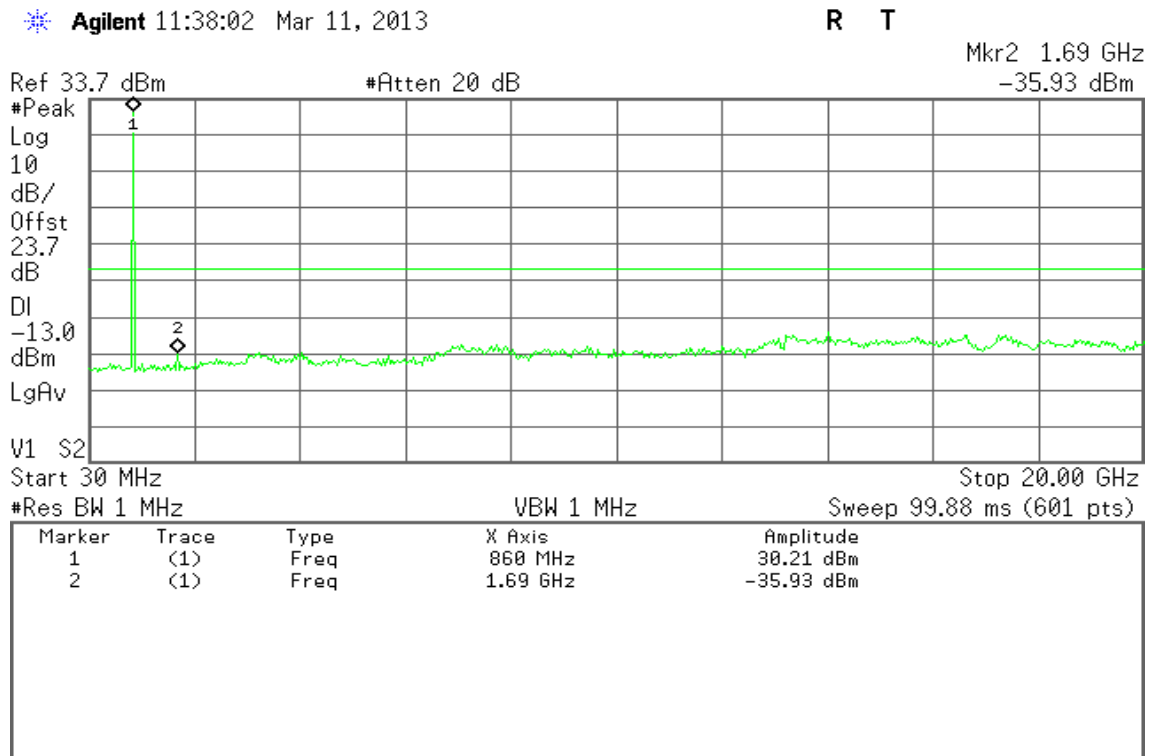



Figure 7-3: Out of Band emission at antenna terminals – GPRS CH High



GPRS 1900

Figure 8-1: Out of Band emission at antenna terminals – GSM CH Low

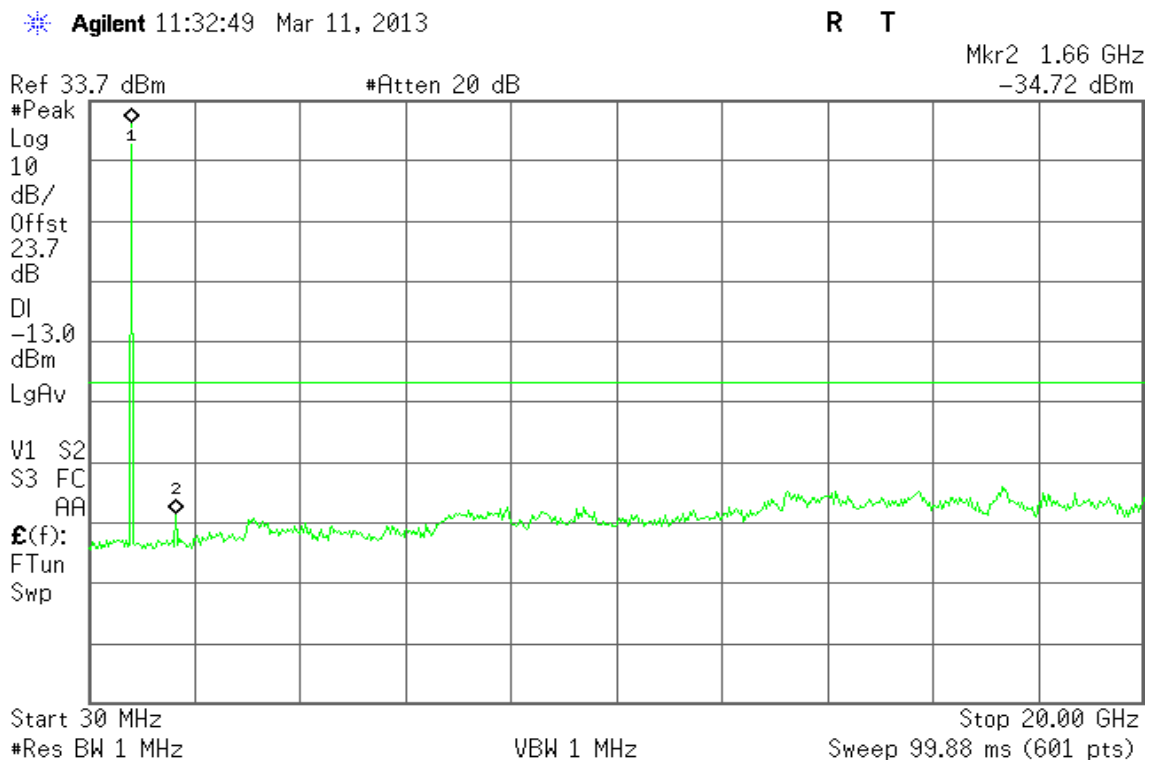



Figure 8-2: Out of Band emission at antenna terminals – GSM CH Mid

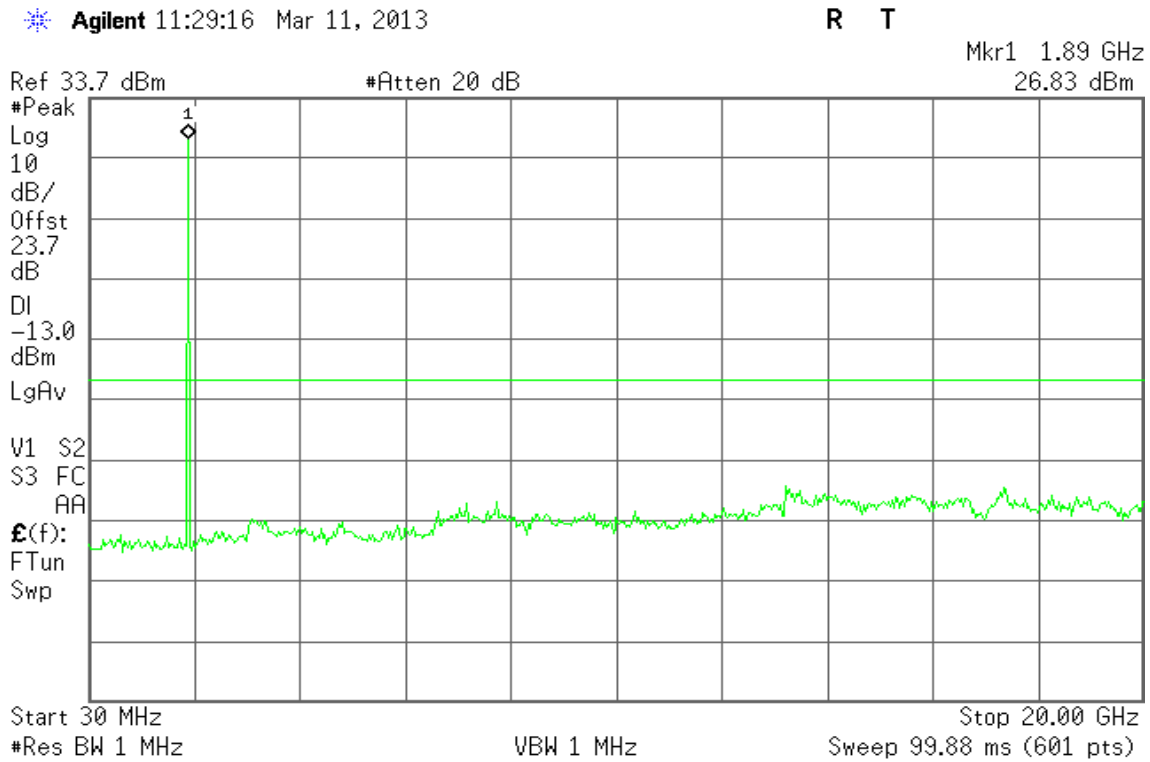
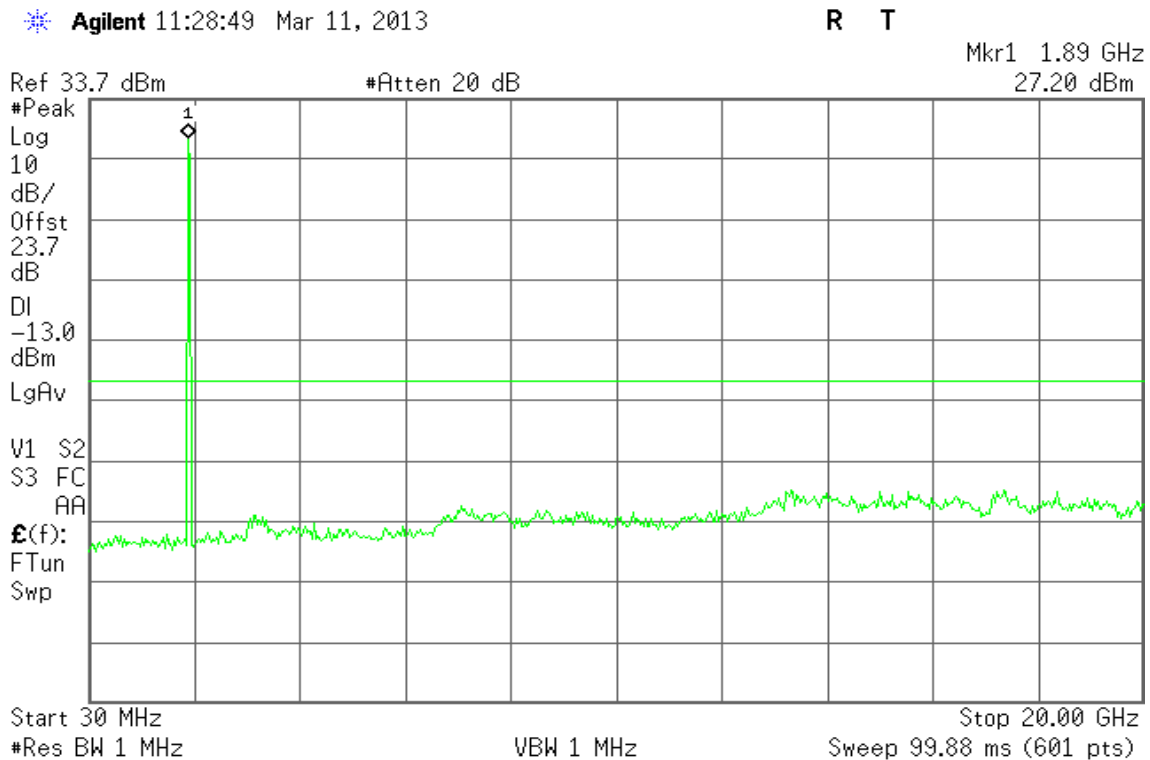

Figure 8-3: Out of Band emission at antenna terminals – GSM CH High





GPRS 850

Figure 9-1: Band Edge emissions – GPRS CH Low

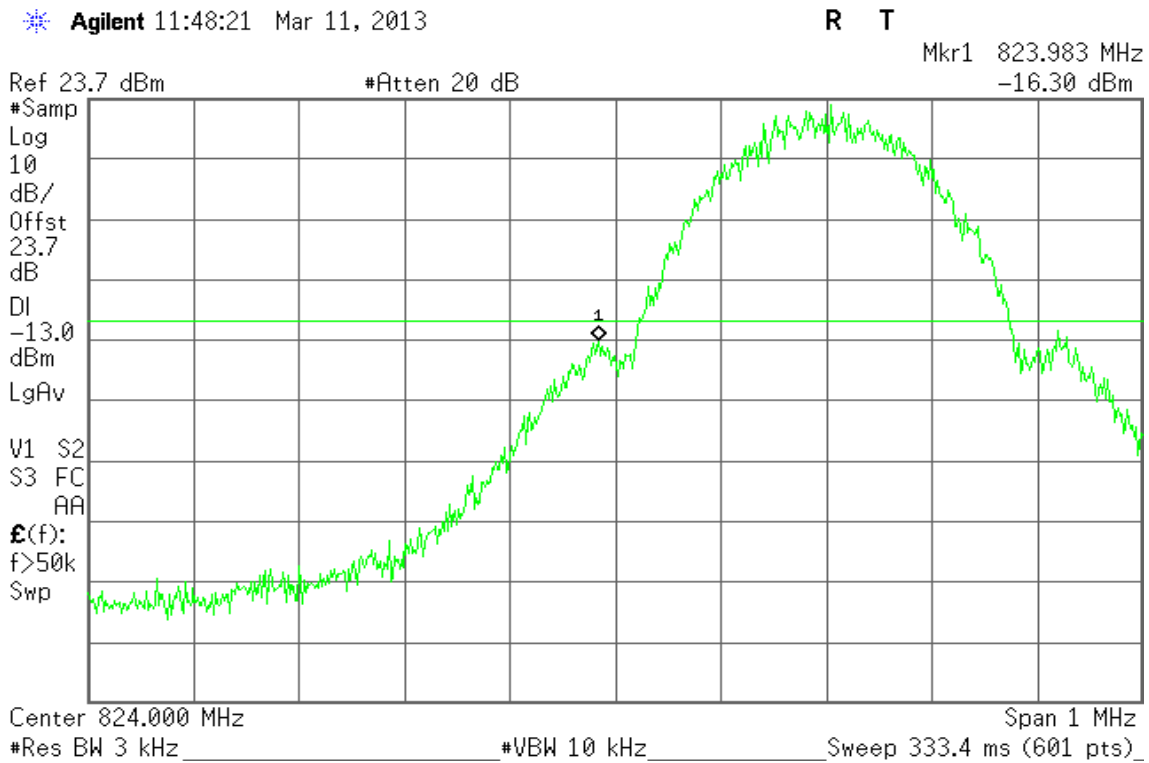
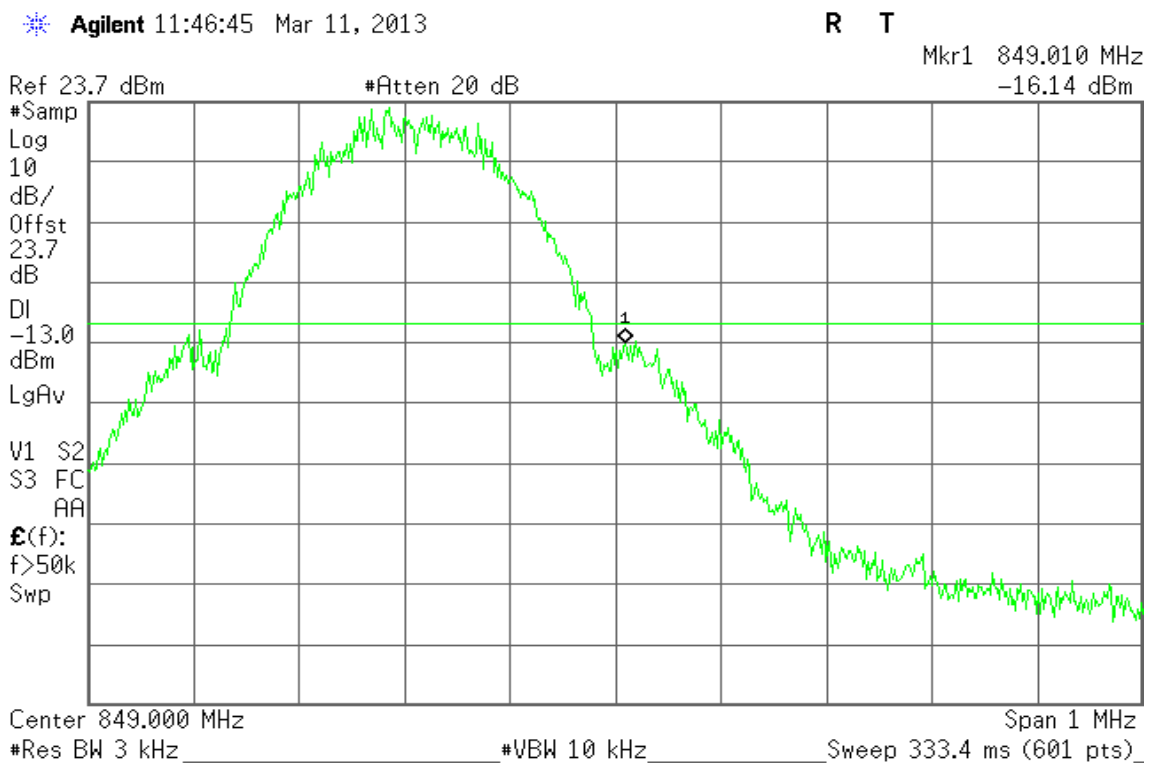

Figure 9-2: Band Edge emissions –GPRS CH High





GPRS 1900

Figure 10-1: Band Edge emissions – GPRS CH Low

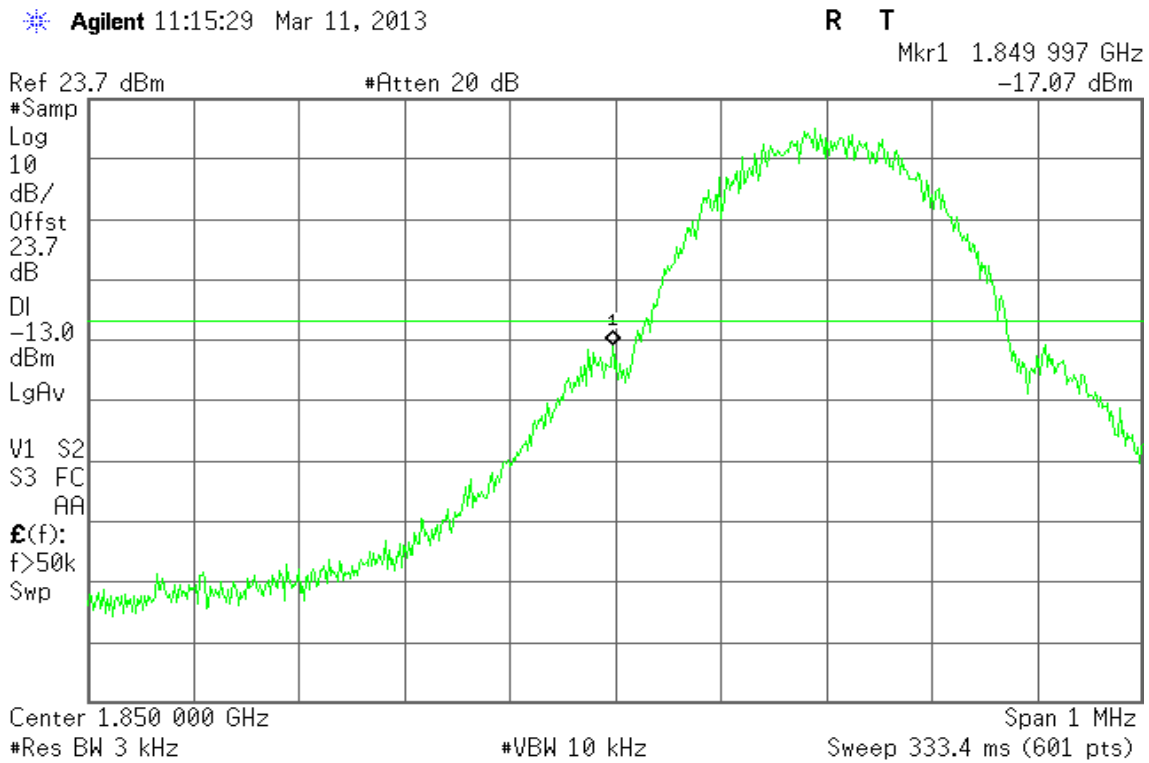
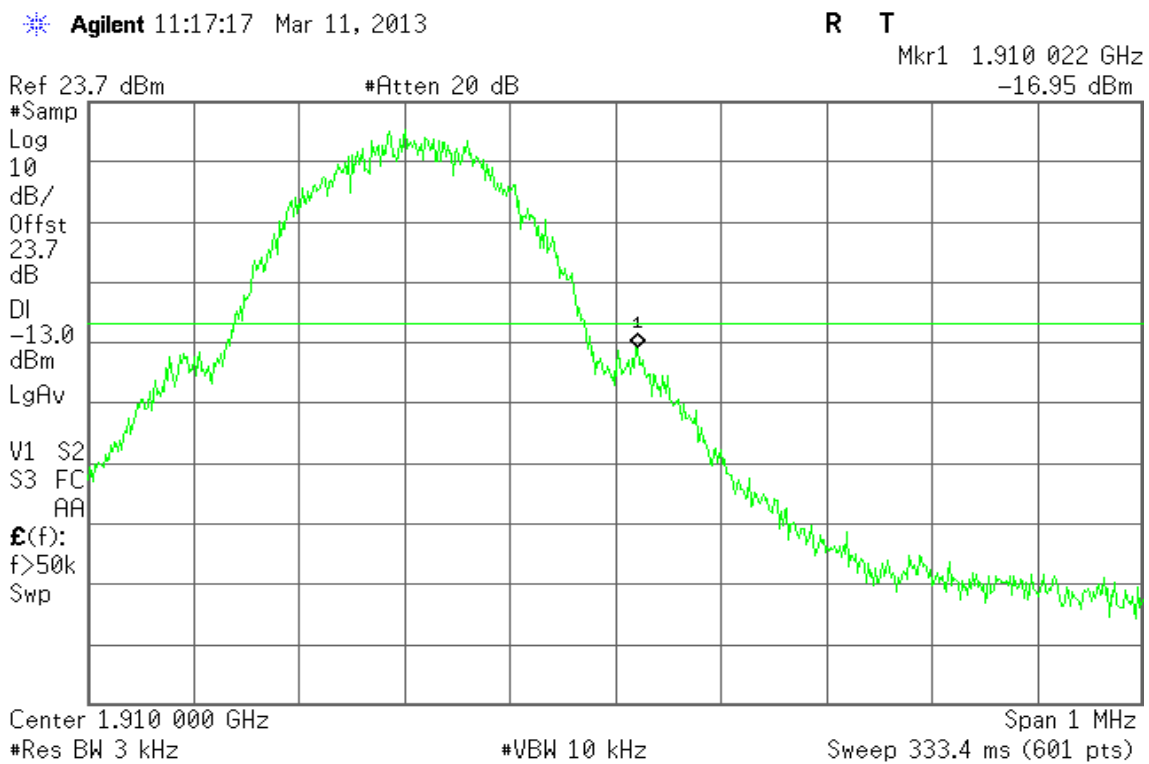

Figure 10-2: Band Edge emissions – GPRS CH High





EDGE 850

Figure 11-1: Out of Band emission at antenna terminals –EDGE CH Low

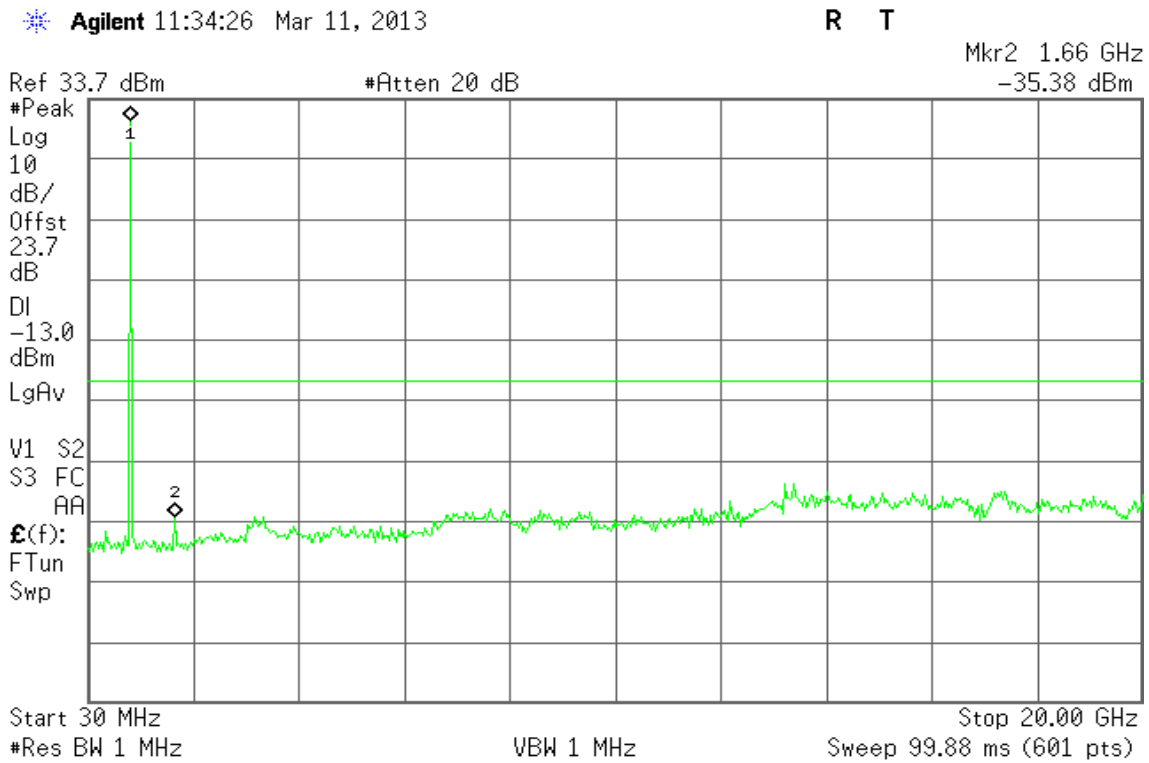

Figure 11-2: Out of Band emission at antenna terminals –EDGE CH Mid

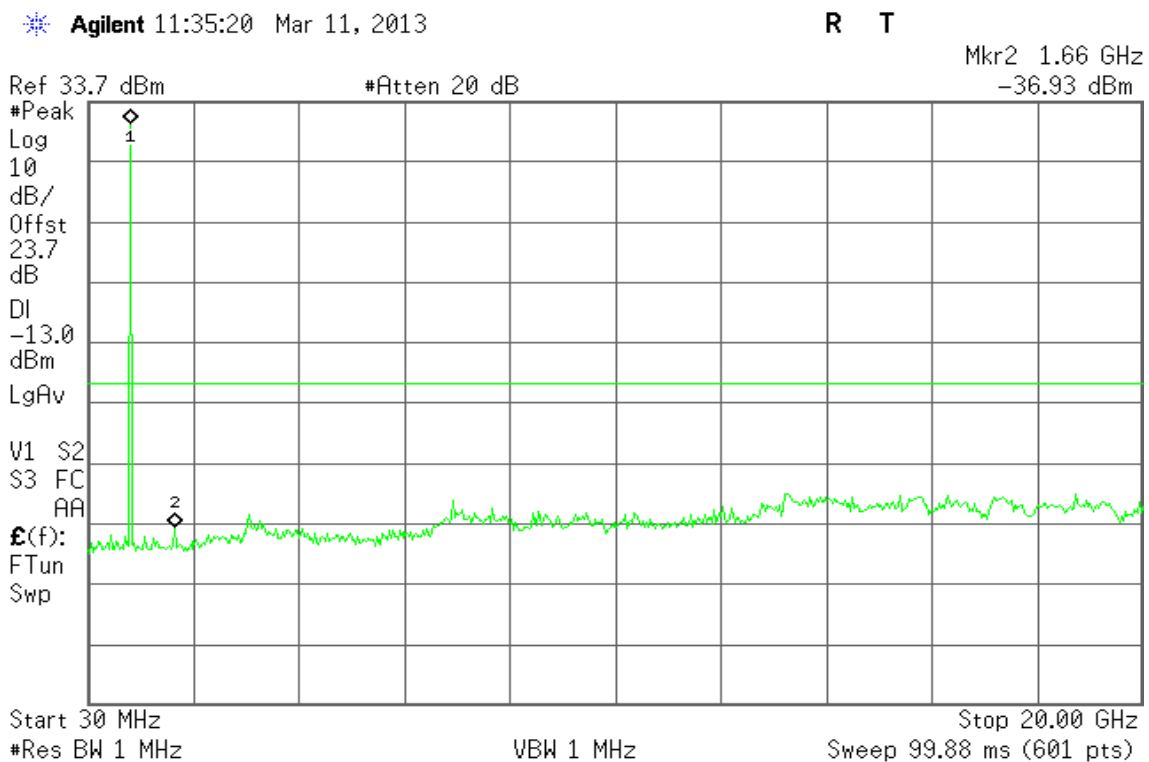
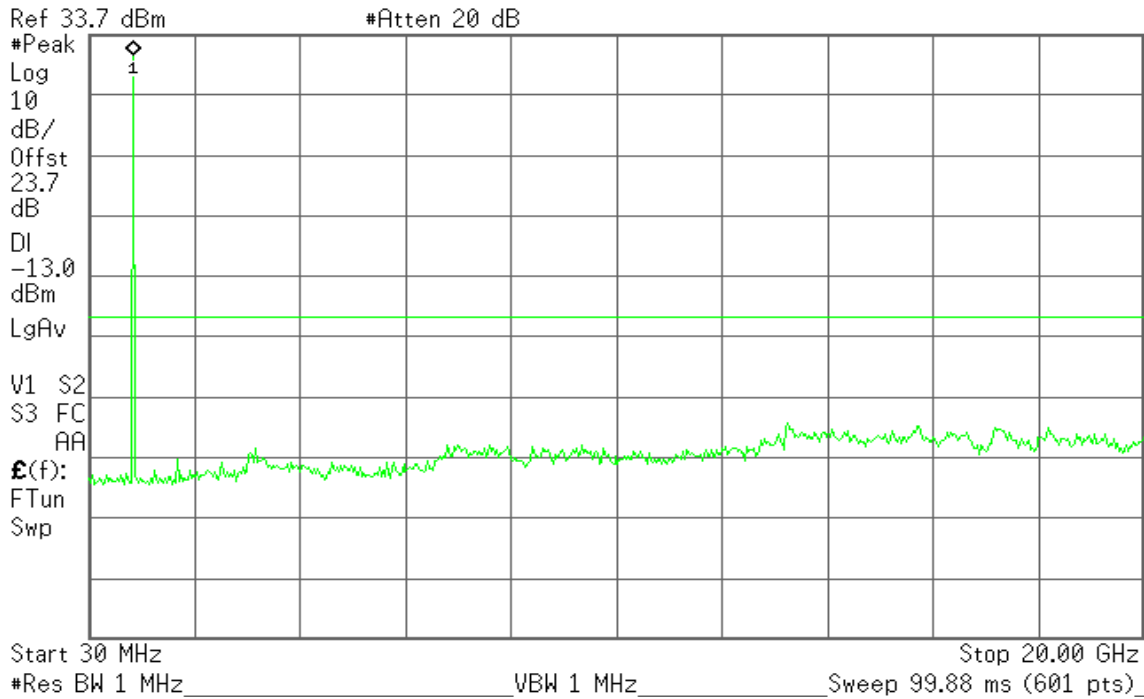



Figure 11-3: Out of Band emission at antenna terminals –EDGE CH High

Agilent 11:39:50 Mar 11, 2013

R T



EDGE 1900

Figure 12-1: Out of Band emission at antenna terminals –EDGE CH Low

Agilent 11:26:42 Mar 11, 2013

R T

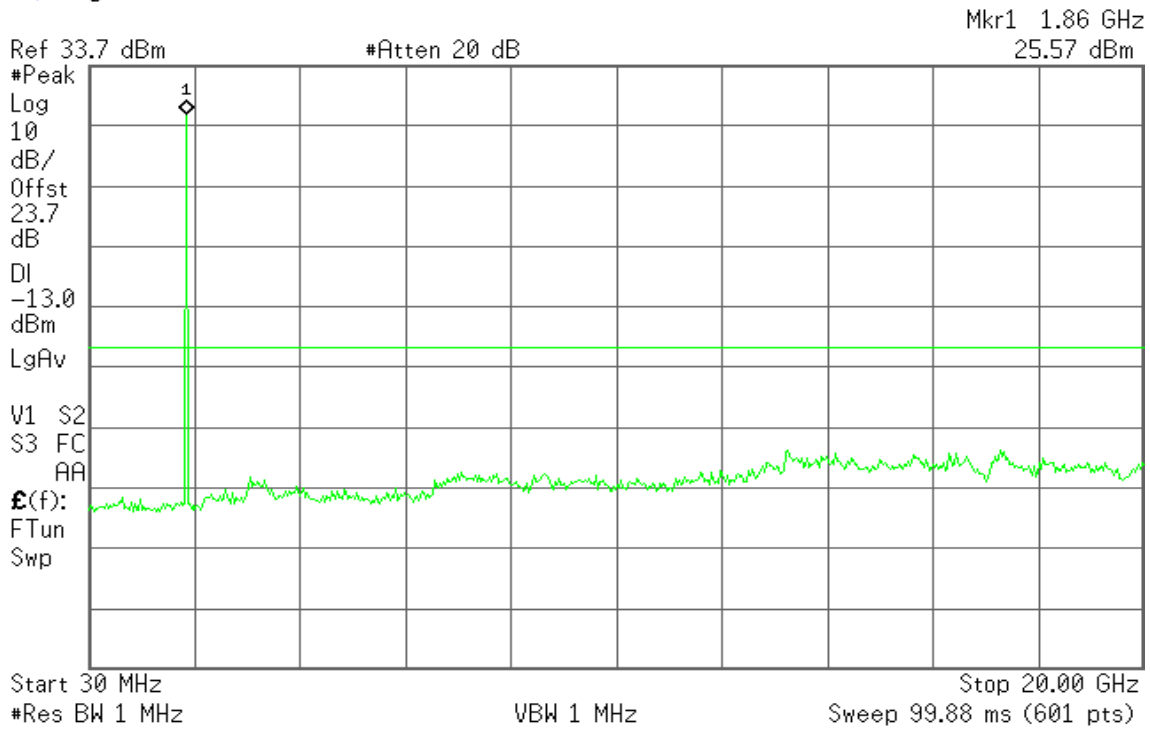



Figure 12-2: Out of Band emission at antenna terminals –EDGE CH Mid

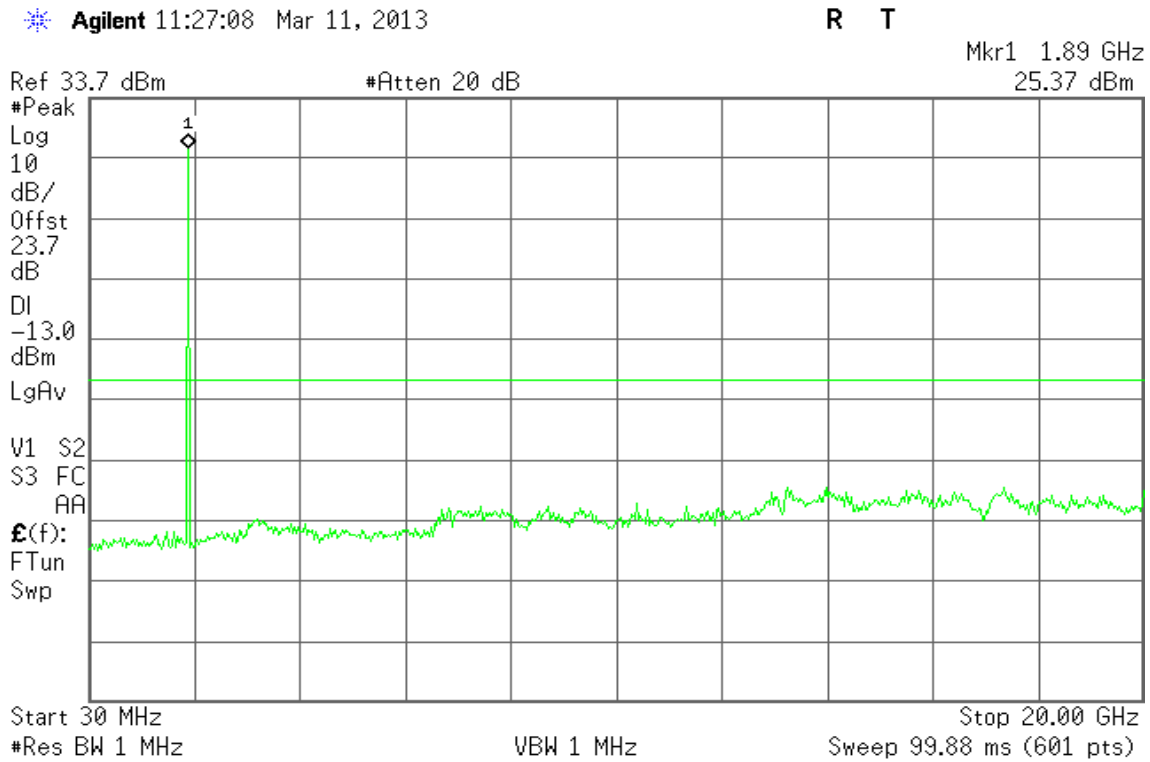
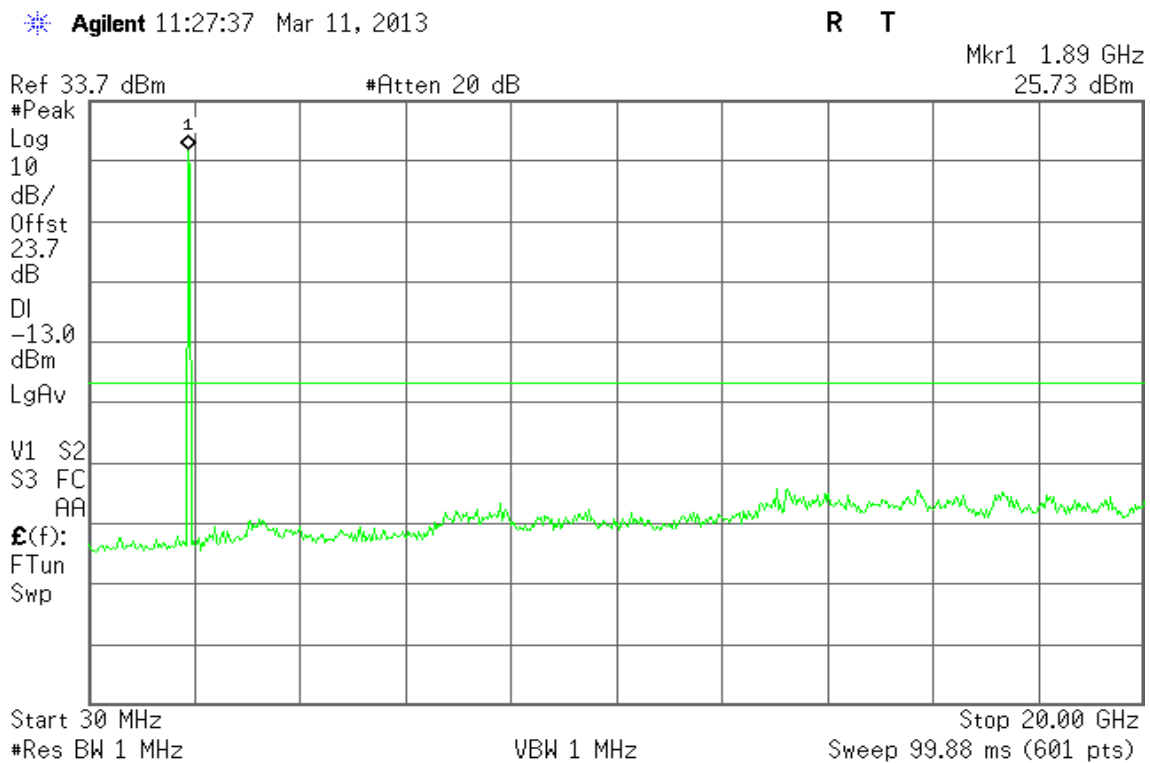

Figure 12-3: Out of Band emission at antenna terminals –EDGE CH High





EDGE 850

Figure 13-1: Band Edge emissions – EDGE CH Low

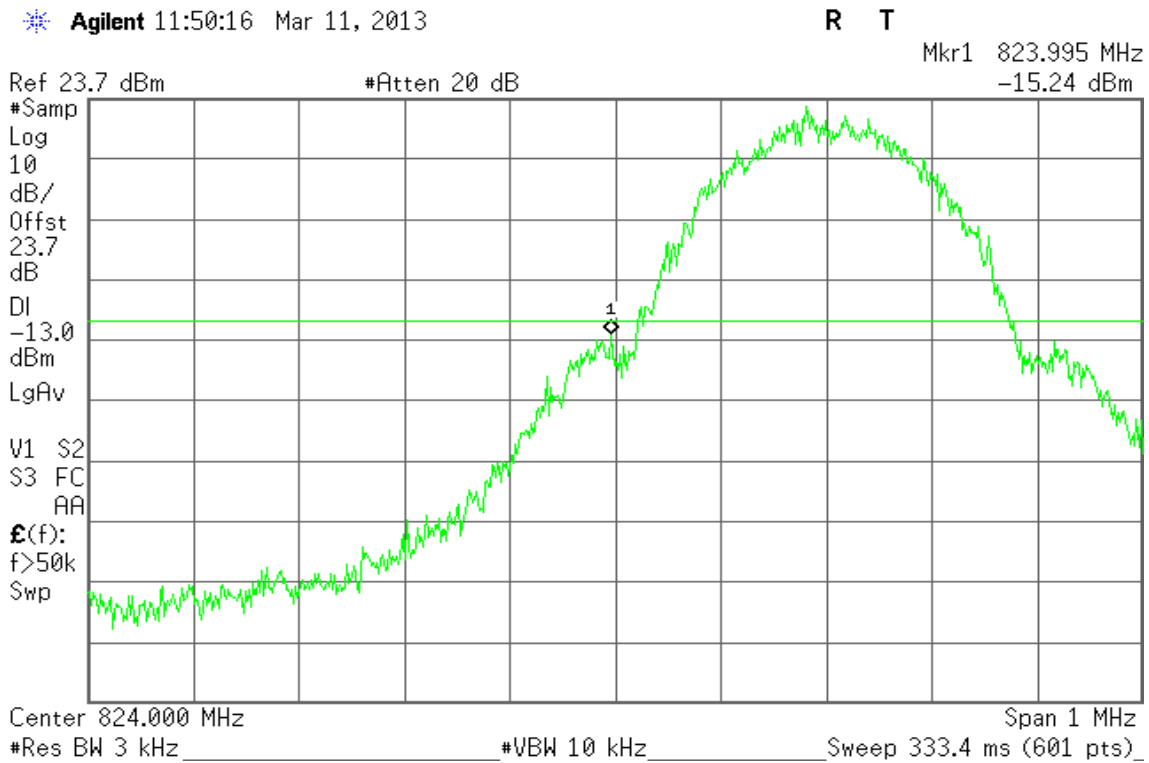
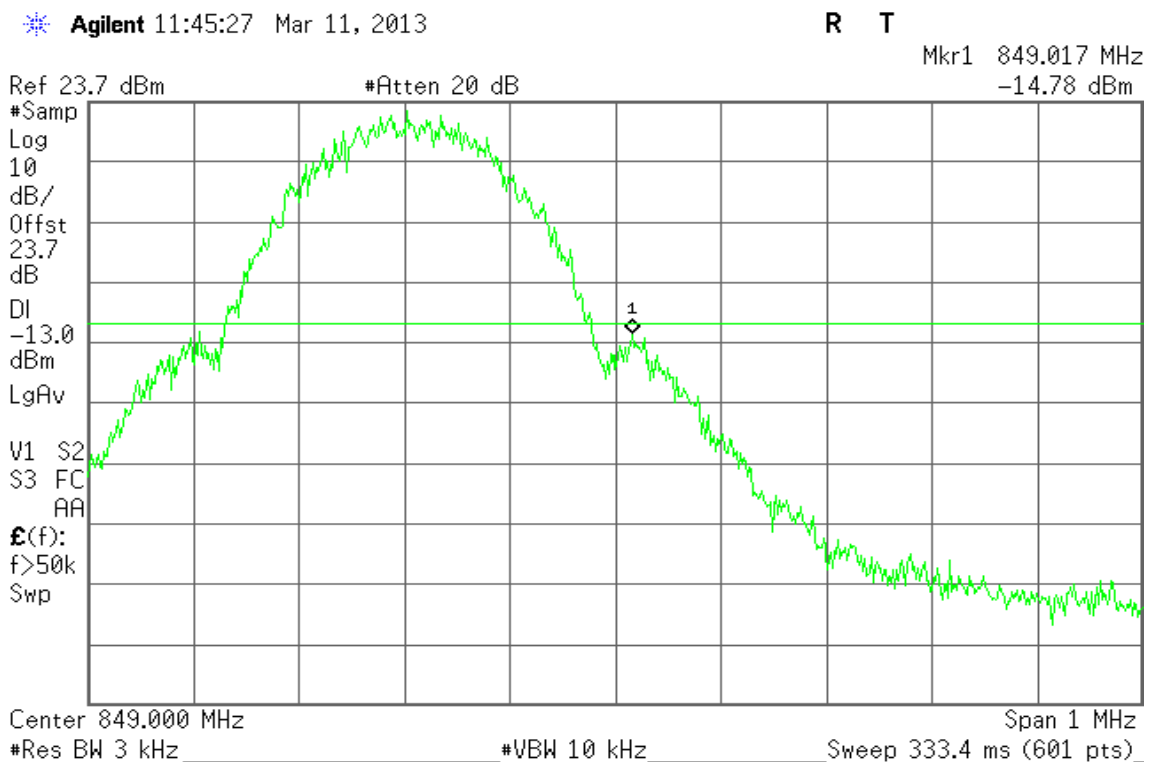

Figure 13-2: Band Edge emissions – EDGE CH High





EDGE 1900

Figure 14-1: Band Edge emissions – EDGE CH Low

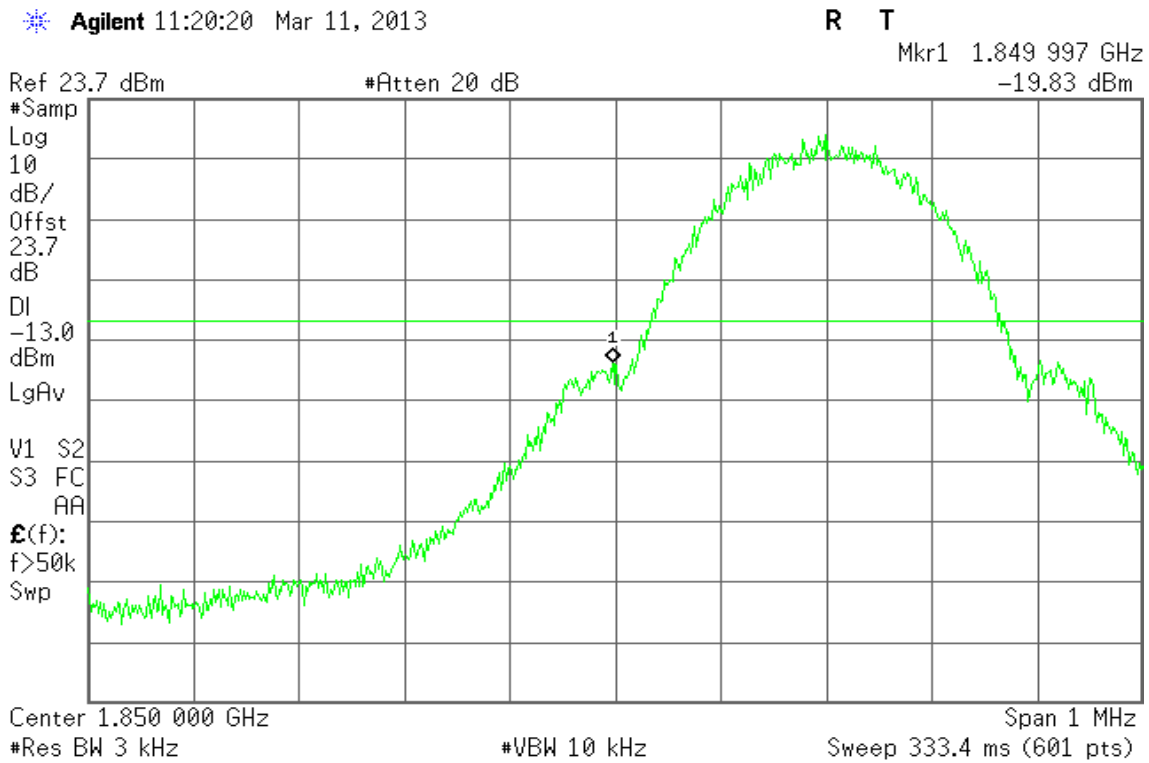
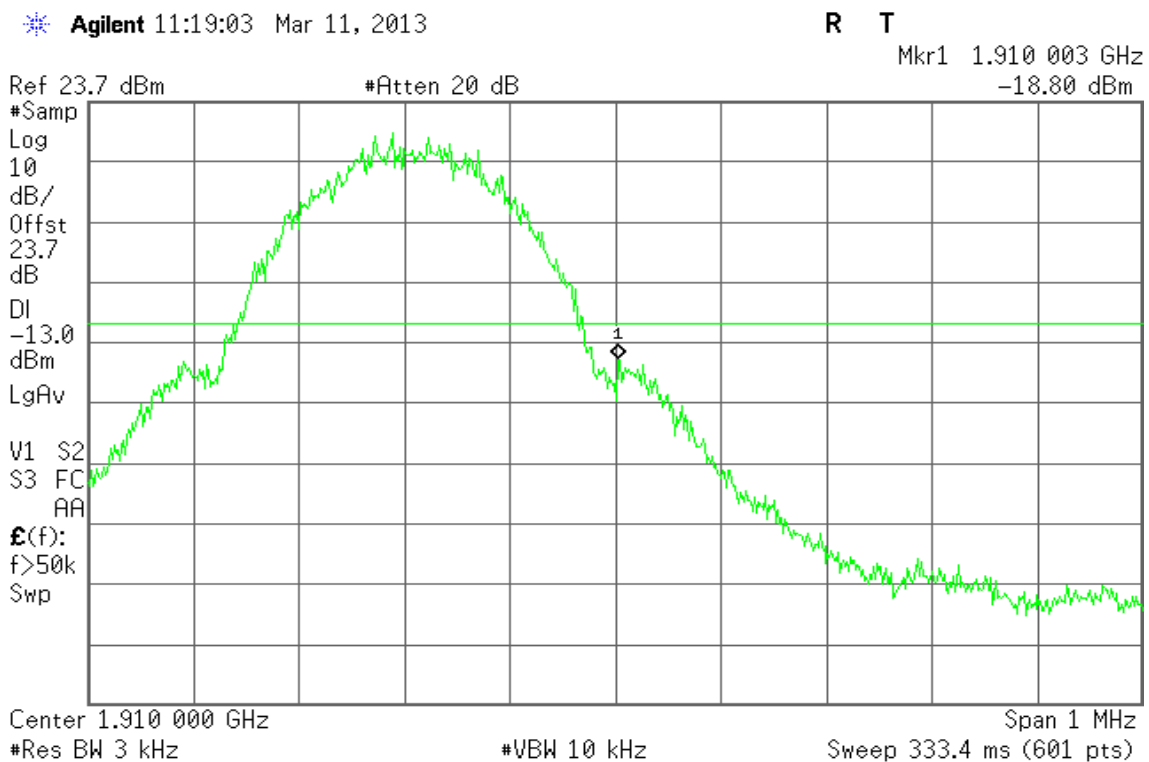

Figure 14-2: Band Edge emissions – EDGE CH High





WCDMA Band II

Figure 15-1: Out of Band emission at antenna terminals – WCDMA CH Low

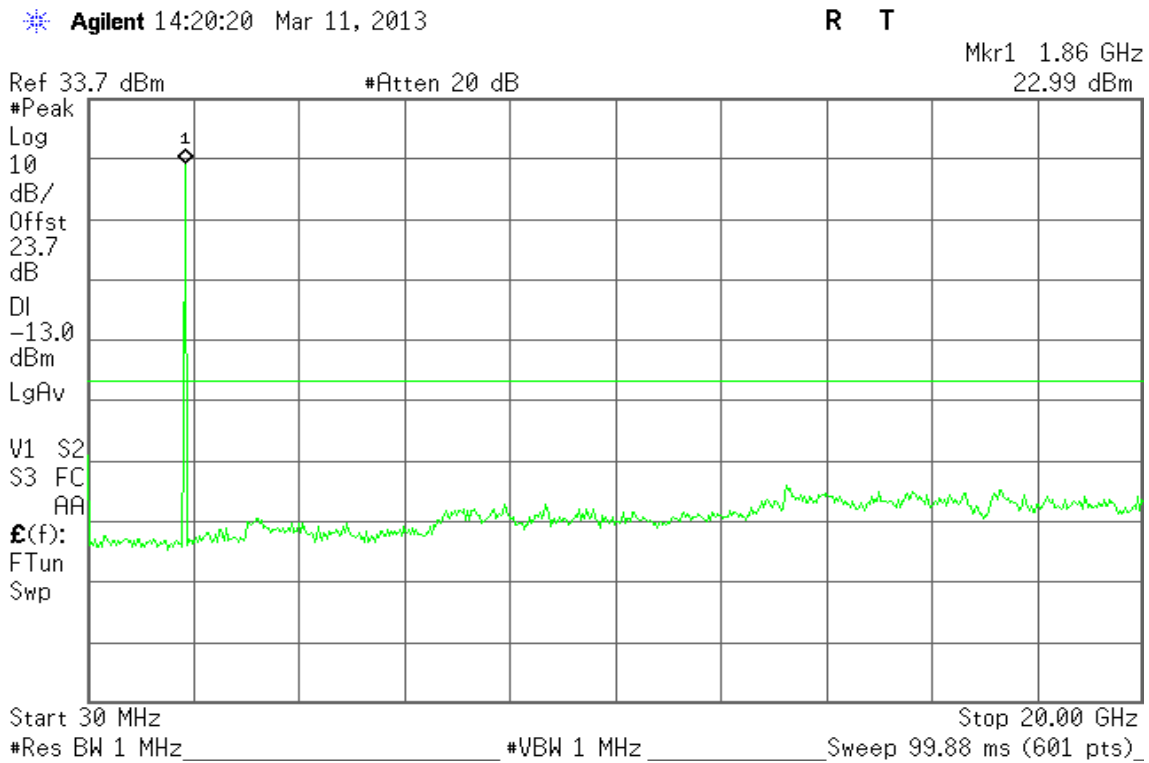

Figure 15-2: Out of Band emission at antenna terminals – WCDMA CH Mid

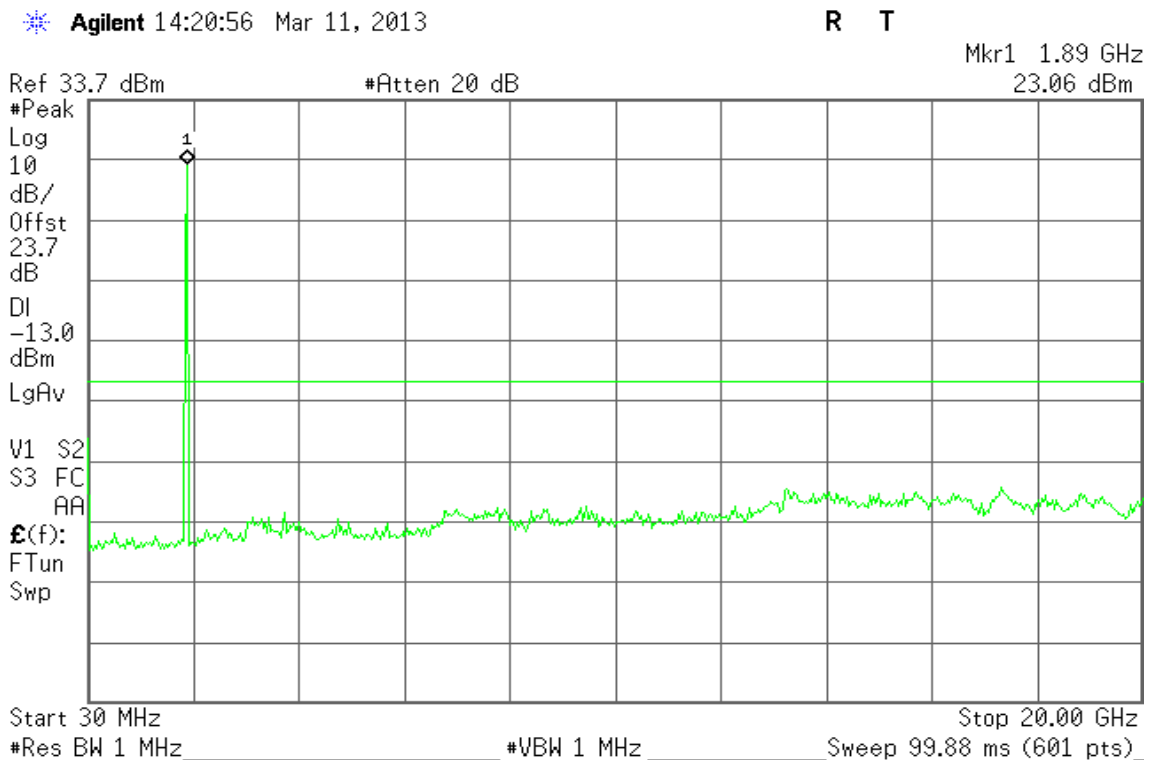
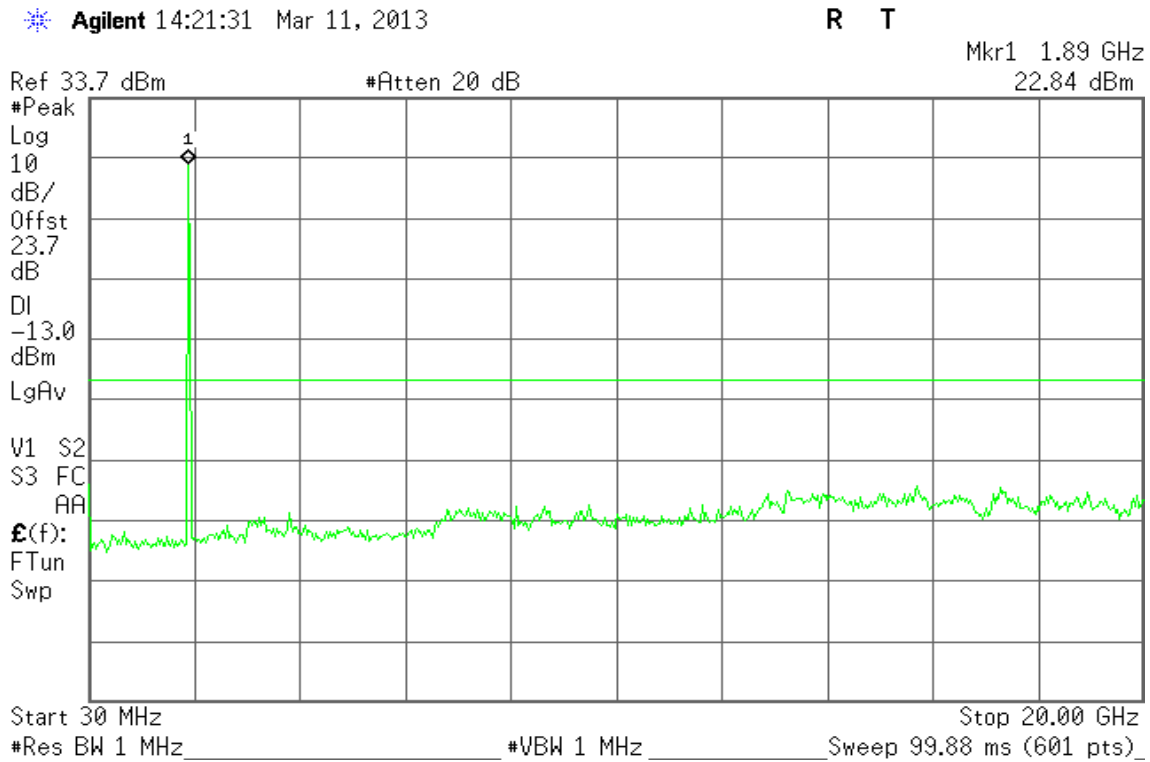



Figure 15-3: Out of Band emission at antenna terminals – WCDMA CH High



WCDMA Band V

Figure 16-1: Out of Band emission at antenna terminals – WCDMA CH Low

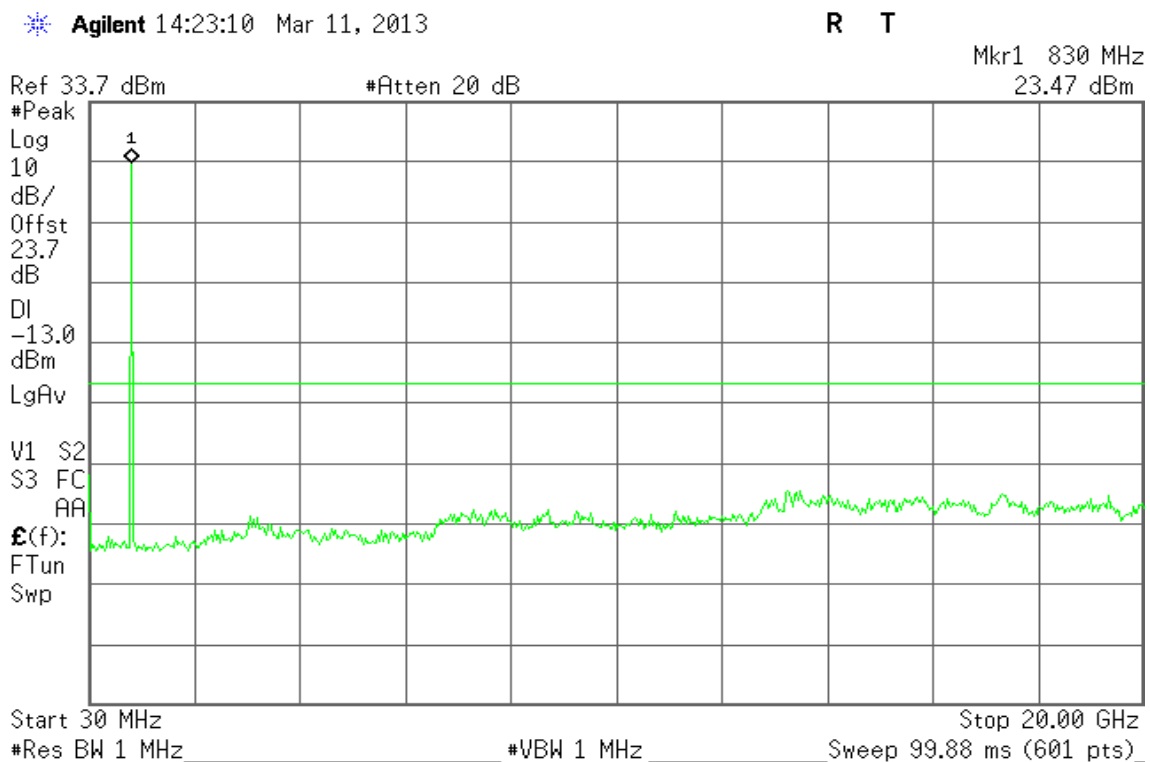



Figure 16-2: Out of Band emission at antenna terminals – WCDMA CH Mid

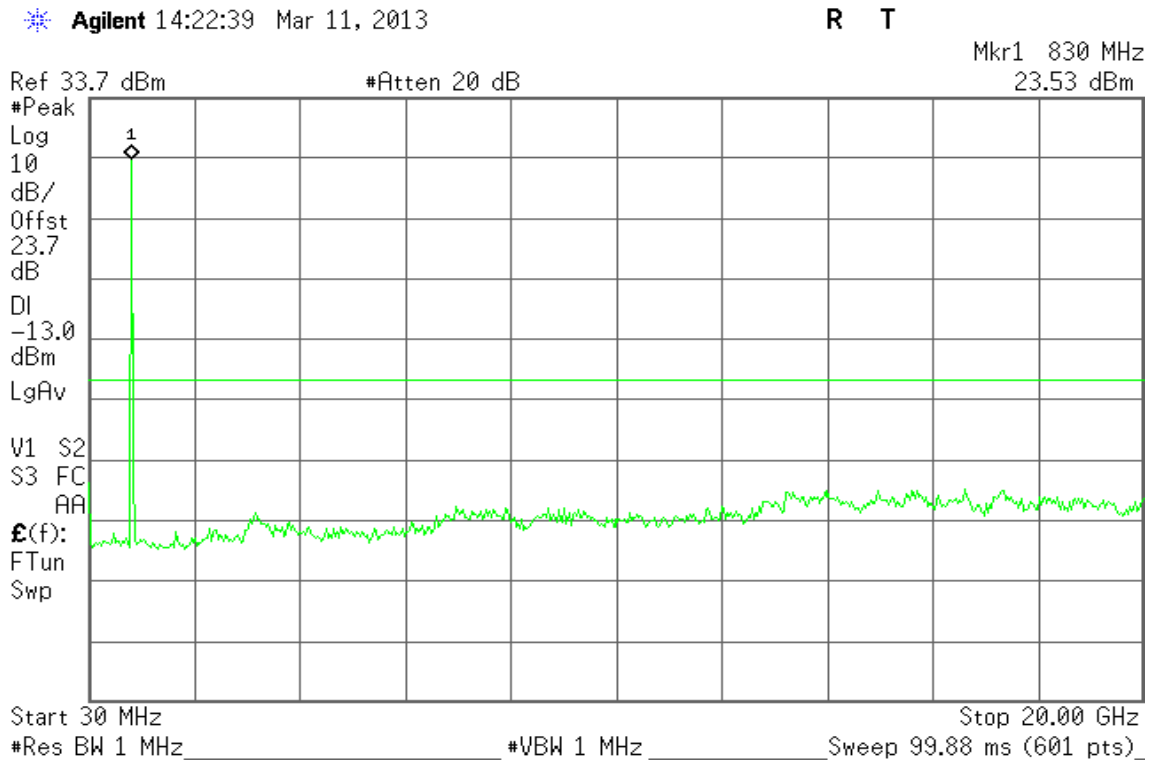
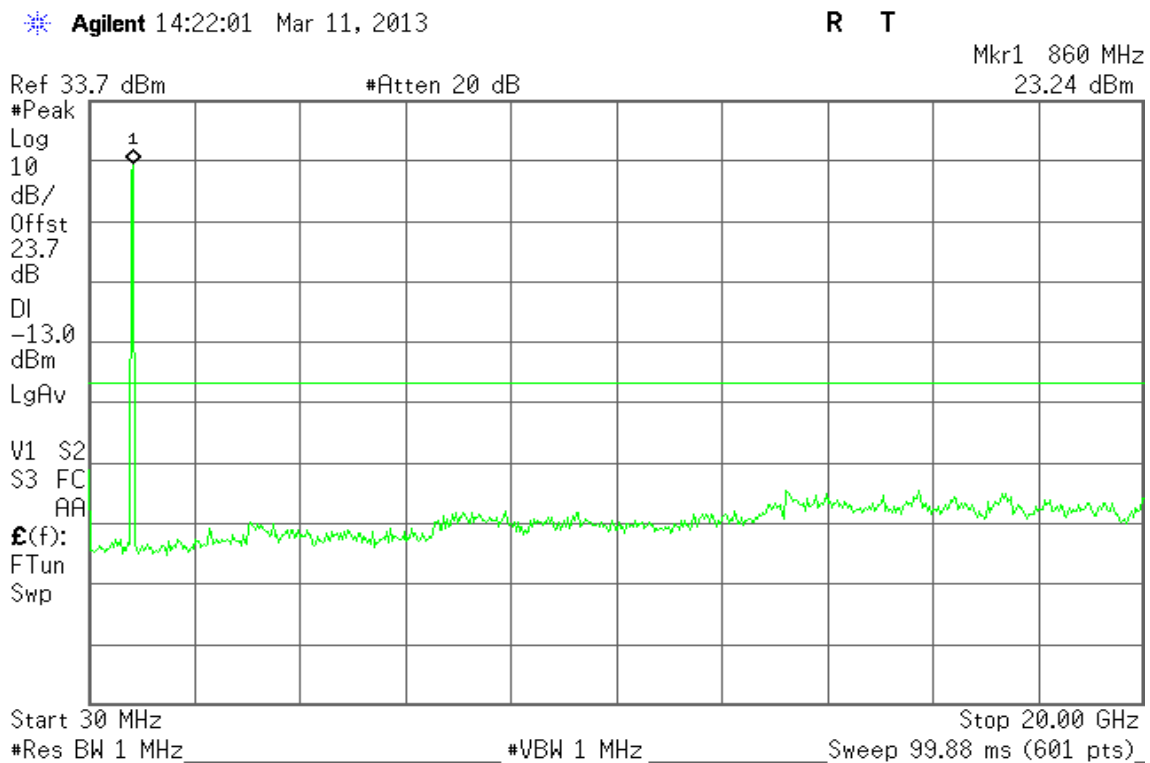

Figure 16-3: Out of Band emission at antenna terminals – WCDMA CH High





WCDMA Band II

Figure 17-1: Band Edge emissions – WCDMA CH Low

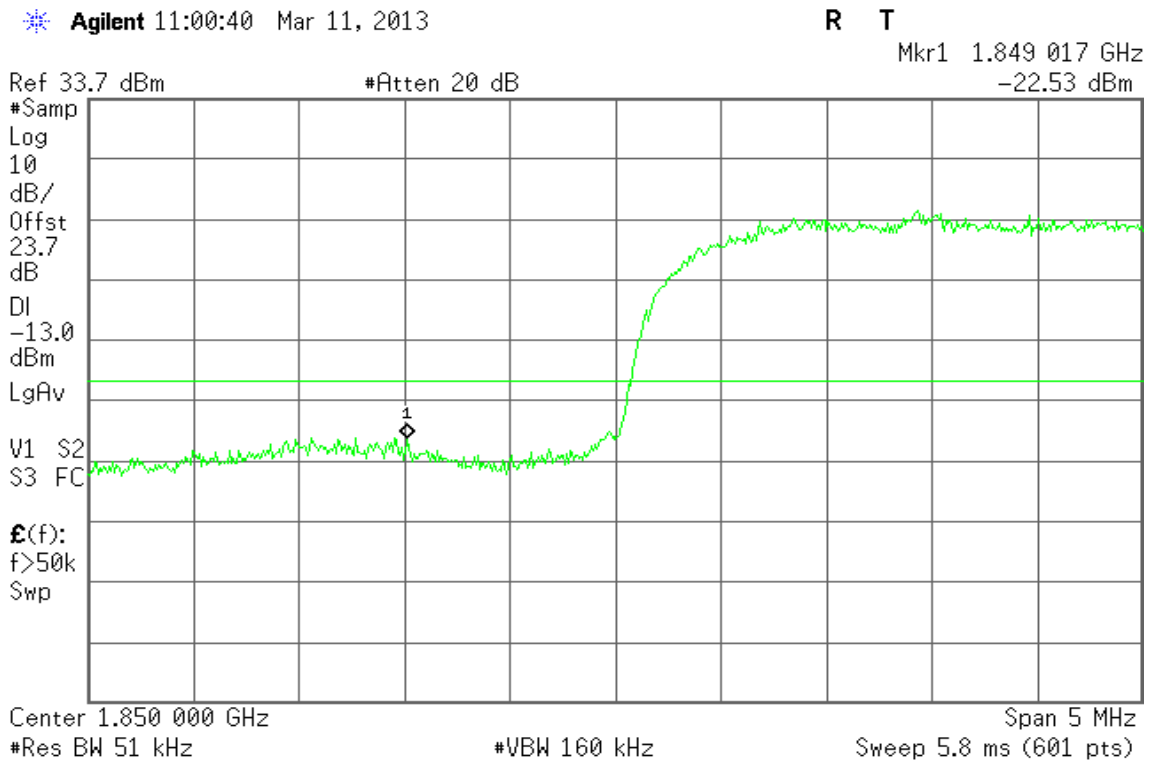
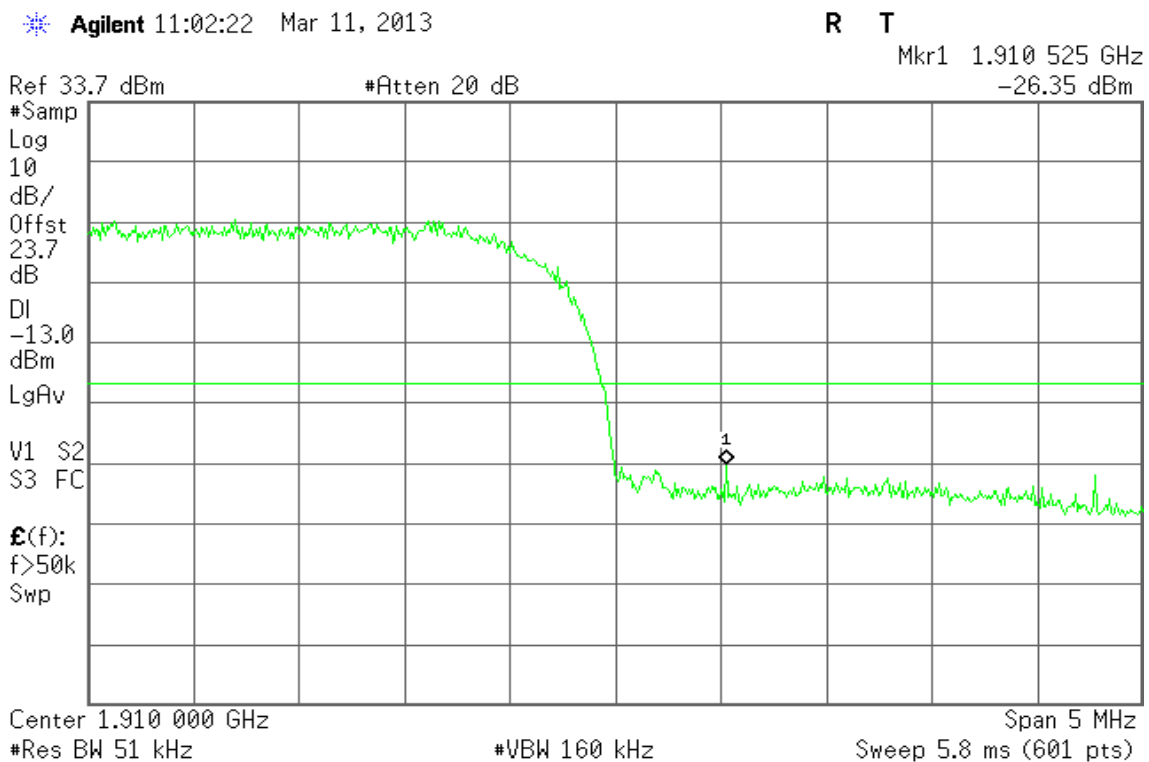

Figure 17-2: Band Edge emissions –WCDMA CH High





WCDMA Band V

Figure 18-1: Band Edge emissions –WCDMA CH Low

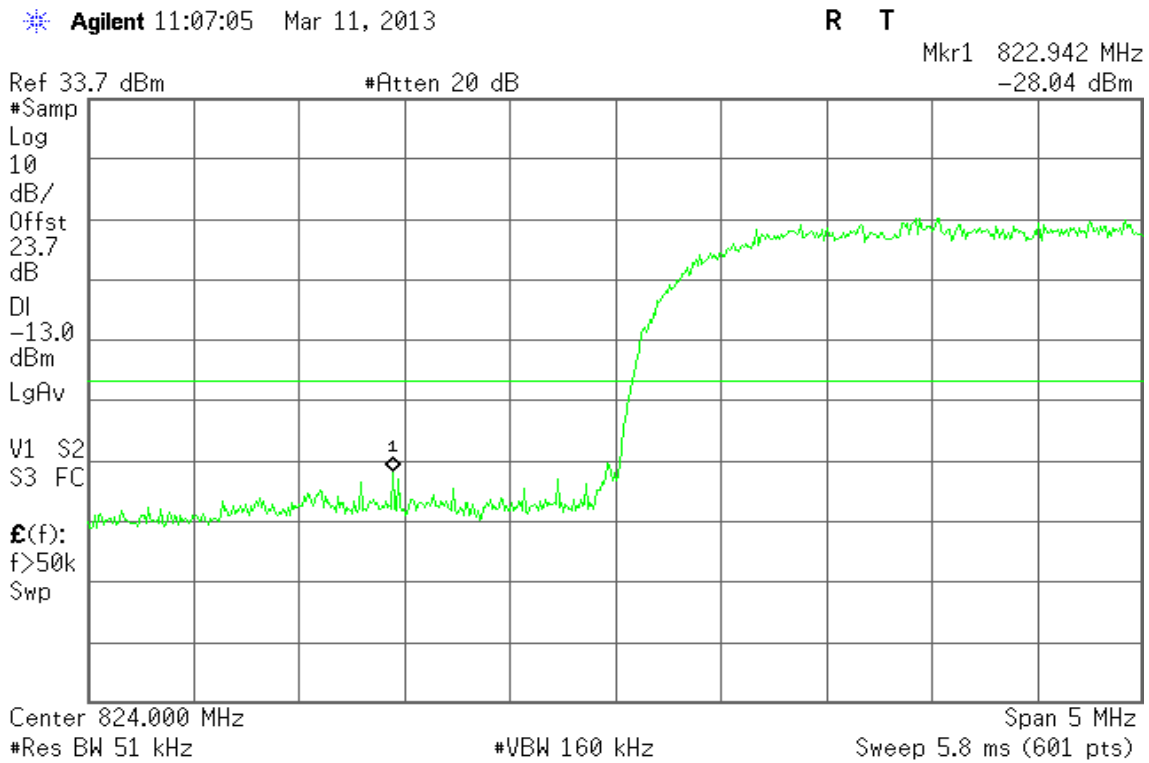
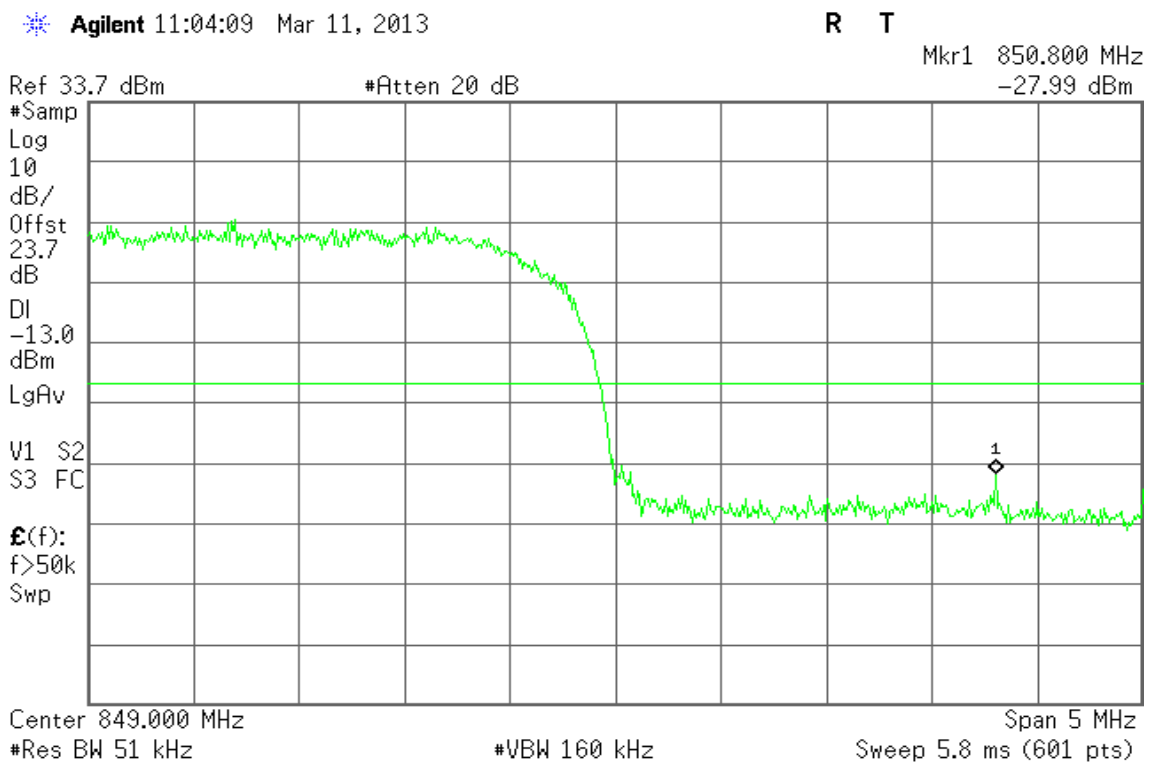

Figure 18-2: Band Edge emissions –WCDMA CH High





7.5 FIELD STRENGTH OF SPURIOUS RADIATION MEASUREMENT

LIMIT

According to FCC §2.1053, RSS-132 (4.6) & RSS-133 (6.5).

Test Configuration

Below 1 GHz

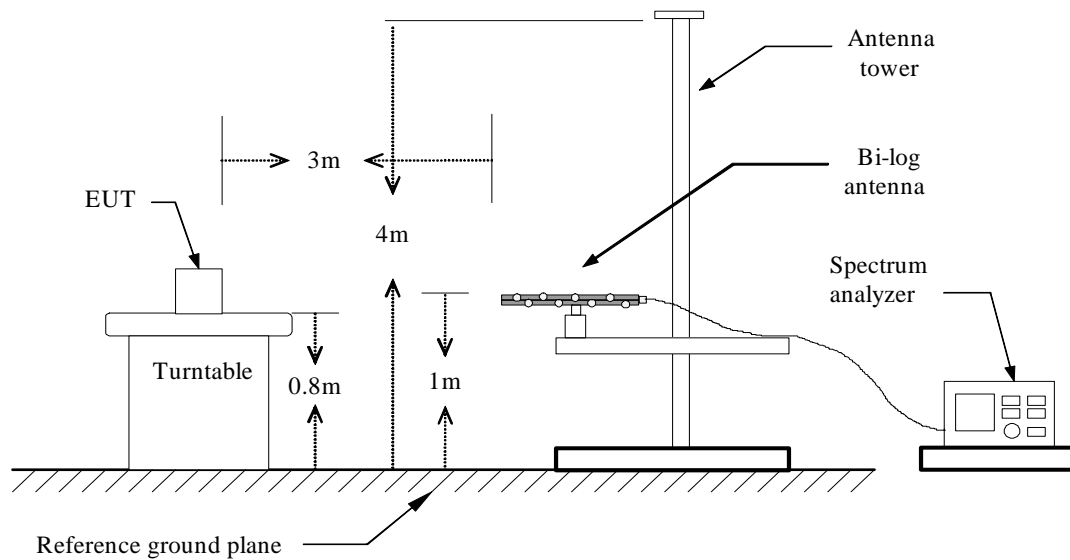

Above 1 GHz

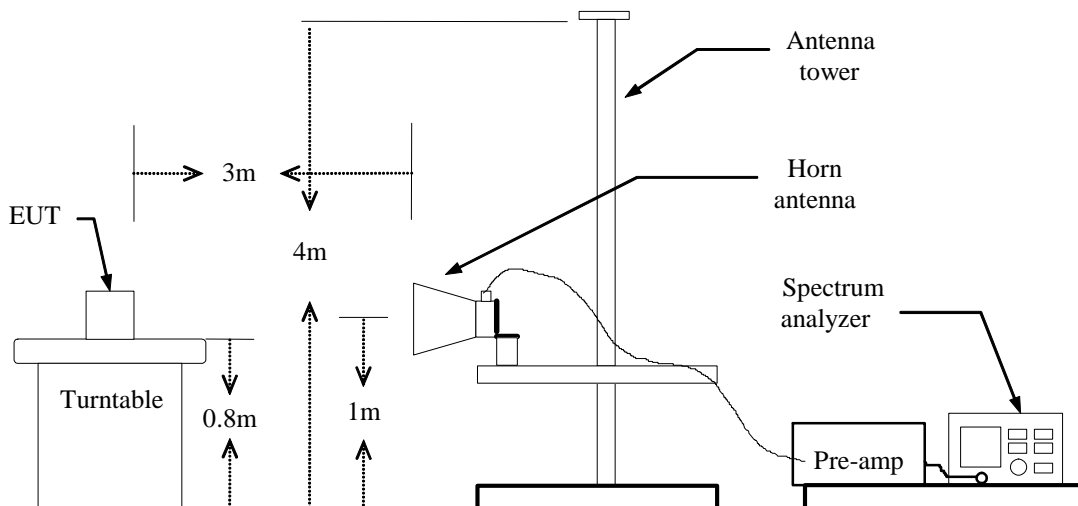



Substituted Method Test Set-up

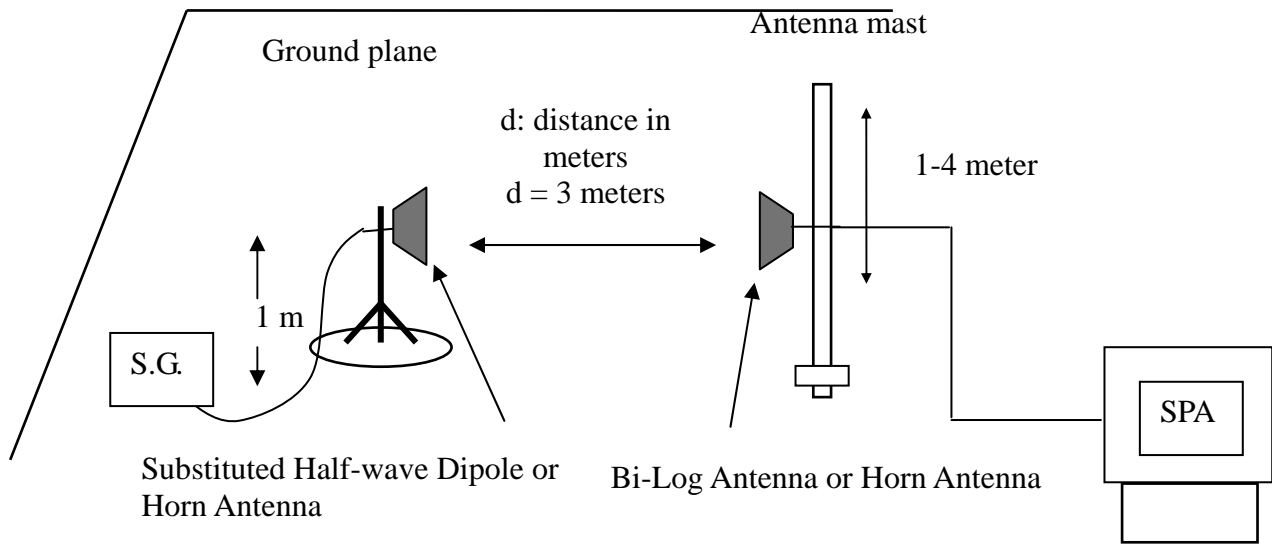

TEST PROCEDURE

The EUT was placed on a non-conductive, the measurement antenna was placed at a distance of 3 meters from the EUT. During the tests, the antenna height and the EUT azimuth were varied in order to identify the maximum level of emissions from the EUT. This maximization process was repeated with the EUT positioned in each of its three orthogonal orientations.

The frequency range up to tenth harmonic was investigated for each of three fundamental frequency (low, middle and high channels). Once spurious emission were identified, the power of the emission was determined using the substitution method.

The spurious emissions attenuation was calculated as the difference between radiated power at the fundamental frequency and the spurious emissions frequency.

$$\text{ERP} = \text{S.G. output (dBm)} + \text{Antenna Gain (dBd)} - \text{Cable (dB)}$$

$$\text{EIRP} = \text{S.G. output (dBm)} + \text{Antenna Gain (dBi)} - \text{Cable (dB)}$$

TEST RESULTS

Refer to the attached tabular data sheets.



Radiated Spurious Emission Measurement Result / Below 1GHz

Operation Mode: GPRS 850 / TX / CH 128

Test Date: March 12, 2013

Temperature: 25°C

Tested by: David Shu

Humidity: 55 % RH

Polarity: Ver. / Hor.

Frequency (MHz)	S.G. (dBm)	Cable loss (dB)	Ant.Gain (dBi)	Emission level (dBm)	Limit (dBm)	Margin (dB)	Antenna Polarization (V/H)
95.9600	-62.83	1.13	0.26	-63.70	-13.00	-50.70	V
126.0300	-68.29	1.32	-1.69	-71.30	-13.00	-58.30	V
226.9100	-80.36	1.79	5.37	-76.78	-13.00	-63.78	V
354.9500	-79.89	2.25	5.75	-76.39	-13.00	-63.39	V
439.3400	-79.92	2.53	5.9	-76.55	-13.00	-63.55	V
617.8200	-80.43	2.94	6.14	-77.23	-13.00	-64.23	V
60.0700	-53.96	0.88	-2.19	-57.03	-13.00	-44.03	H
111.4800	-56.17	1.22	-1.76	-59.15	-13.00	-46.15	H
204.6000	-70.52	1.65	4.2	-67.97	-13.00	-54.97	H
346.2200	-70.86	2.21	5.8	-67.27	-13.00	-54.27	H
472.3200	-73.03	2.62	5.72	-69.93	-13.00	-56.93	H
529.5500	-75.64	2.75	6	-72.39	-13.00	-59.39	H

Remark:

1. *The emission behaviour belongs to narrowband spurious emission.*
2. *Measurements above show only up to 6 maximum emissions noted, or would be lesser; with " N/A " remark, if no specific emissions from the EUT are recorded (ie: margin > 20dB from the applicable limit) and considered that's already beyond the background noise floor.*



Operation Mode: GPRS 850 / TX / CH 190

Test Date: March 12, 2013

Temperature: 25°C

Tested by: David Shu

Humidity: 55 % RH

Polarity: Ver. / Hor.

Frequency (MHz)	S.G. (dBm)	Cable loss (dB)	Ant.Gain (dBi)	Emission level (dBm)	Limit (dBm)	Margin (dB)	Antenna Polarization (V/H)
95.9600	-61.33	1.13	0.26	-62.20	-13.00	-49.20	V
183.2600	-75.17	1.61	3.73	-73.05	-13.00	-60.05	V
346.2200	-79.27	2.21	5.8	-75.68	-13.00	-62.68	V
450.9800	-79.04	2.59	5.74	-75.89	-13.00	-62.89	V
529.5500	-81.48	2.75	6	-78.23	-13.00	-65.23	V
612.9700	-81.92	2.94	6.23	-78.63	-13.00	-65.63	V
60.0700	-53.59	0.88	-2.19	-56.66	-13.00	-43.66	H
111.4800	-54.83	1.22	-1.76	-57.81	-13.00	-44.81	H
216.2400	-72.79	1.74	5.36	-69.17	-13.00	-56.17	H
345.2500	-71.04	2.2	5.8	-67.44	-13.00	-54.44	H
402.4800	-71.31	2.41	5.97	-67.75	-13.00	-54.75	H
516.9400	-73.74	2.7	6.07	-70.37	-13.00	-57.37	H

Remark:

1. *The emission behaviour belongs to narrowband spurious emission.*
2. *Measurements above show only up to 6 maximum emissions noted, or would be lesser, with " N/A " remark, if no specific emissions from the EUT are recorded (ie: margin>20dB from the applicable limit) and considered that's already beyond the background noise floor.*



Operation Mode: GPRS 850 / TX / CH 251

Test Date: March 12, 2013

Temperature: 25°C

Tested by: David Shu

Humidity: 55 % RH

Polarity: Ver. / Hor.

Frequency (MHz)	S.G. (dBm)	Cable loss (dB)	Ant.Gain (dBi)	Emission level (dBm)	Limit (dBm)	Margin (dB)	Antenna Polarization (V/H)
95.9600	-60.43	1.13	0.26	-61.30	-13.00	-48.30	V
182.2900	-72.98	1.61	3.7	-70.89	-13.00	-57.89	V
203.6300	-75.33	1.65	3.94	-73.04	-13.00	-60.04	V
354.9500	-77.36	2.25	5.75	-73.86	-13.00	-60.86	V
448.0700	-78.55	2.58	5.74	-75.39	-13.00	-62.39	V
585.8100	-81.54	2.89	6.11	-78.32	-13.00	-65.32	V
60.0700	-49.53	0.88	-2.19	-52.60	-13.00	-39.60	H
111.4800	-51.99	1.22	-1.76	-54.97	-13.00	-41.97	H
161.9200	-63.8	1.5	1.61	-63.69	-13.00	-50.69	H
390.8400	-68.3	2.32	6	-64.62	-13.00	-51.62	H
516.9400	-70.44	2.7	6.07	-67.07	-13.00	-54.07	H
584.8400	-74.14	2.89	6.1	-70.93	-13.00	-57.93	H

Remark:

1. *The emission behaviour belongs to narrowband spurious emission.*
2. *Measurements above show only up to 6 maximum emissions noted, or would be lesser, with “ N/A ” remark, if no specific emissions from the EUT are recorded (ie: margin>20dB from the applicable limit) and considered that's already beyond the background noise floor.*



Operation Mode: GPRS 1900 / TX / CH 512

Test Date: March 12, 2013

Temperature: 25°C

Tested by: David Shu

Humidity: 55 % RH

Polarity: Ver. / Hor.

Frequency (MHz)	S.G. (dBm)	Cable loss (dB)	Ant.Gain (dBi)	Emission level (dBm)	Limit (dBm)	Margin (dB)	Antenna Polarization (V/H)
74.6200	-70.67	1	-1.11	-72.78	-13.00	-59.78	V
174.5300	-75.15	1.59	3	-73.74	-13.00	-60.74	V
224.9700	-80.41	1.78	5.36	-76.83	-13.00	-63.83	V
364.6500	-80.28	2.28	5.75	-76.81	-13.00	-63.81	V
441.2800	-79.22	2.54	5.87	-75.89	-13.00	-62.89	V
480.0800	-81.41	2.64	5.54	-78.51	-13.00	-65.51	V
102.7500	-68.13	1.16	-0.76	-70.05	-13.00	-57.05	H
173.5600	-72.09	1.58	2.9	-70.77	-13.00	-57.77	H
256.0100	-81.19	1.88	5.63	-77.44	-13.00	-64.44	H
364.6500	-74.4	2.28	5.75	-70.93	-13.00	-57.93	H
441.2800	-73.69	2.54	5.87	-70.36	-13.00	-57.36	H
480.0800	-73.55	2.64	5.54	-70.65	-13.00	-57.65	H

Remark:

1. *Measuring frequencies from 1 GHz to the 10th harmonic of highest fundamental frequency.*
2. *Measurements above show only up to 6 maximum emissions noted, or would be lesser, with " N/A " remark, if no specific emissions from the EUT are recorded (ie: margin > 20dB from the applicable limit) and considered that's already beyond the background noise floor.*



Operation Mode: GPRS 1900 / TX / CH 661

Test Date: March 12, 2013

Temperature: 25°C

Tested by: David Shu

Humidity: 55 % RH

Polarity: Ver. / Hor.

Frequency (MHz)	S.G. (dBm)	Cable loss (dB)	Ant.Gain (dBi)	Emission level (dBm)	Limit (dBm)	Margin (dB)	Antenna Polarization (V/H)
75.5900	-71.29	1.01	-0.94	-73.24	-13.00	-60.24	V
189.0800	-77.66	1.62	3.96	-75.32	-13.00	-62.32	V
336.5200	-78.18	2.17	5.76	-74.59	-13.00	-61.59	V
362.7100	-77.47	2.28	5.73	-74.02	-13.00	-61.02	V
441.2800	-80.14	2.54	5.87	-76.81	-13.00	-63.81	V
480.0800	-80.42	2.64	5.54	-77.52	-13.00	-64.52	V
75.5900	-70.28	1.01	-0.94	-72.23	-13.00	-59.23	H
119.2400	-69.05	1.27	-2.07	-72.39	-13.00	-59.39	H
172.5900	-73.1	1.58	2.8	-71.88	-13.00	-58.88	H
364.6500	-74.79	2.28	5.75	-71.32	-13.00	-58.32	H
441.2800	-74.1	2.54	5.87	-70.77	-13.00	-57.77	H
480.0800	-74.81	2.64	5.54	-71.91	-13.00	-58.91	H

Remark:

1. *Measuring frequencies from 1 GHz to the 10th harmonic of highest fundamental frequency.*
2. *Measurements above show only up to 6 maximum emissions noted, or would be lesser, with " N/A " remark, if no specific emissions from the EUT are recorded (ie: margin > 20dB from the applicable limit) and considered that's already beyond the background noise floor.*



Operation Mode: GPRS 1900 / TX / CH 810

Test Date: March 12, 2013

Temperature: 25°C

Tested by: David Shu

Humidity: 55 % RH

Polarity: Ver. / Hor.

Frequency (MHz)	S.G. (dBm)	Cable loss (dB)	Ant.Gain (dBi)	Emission level (dBm)	Limit (dBm)	Margin (dB)	Antenna Polarization (V/H)
75.5900	-72.26	1.01	-0.94	-74.21	-13.00	-61.21	V
183.2600	-77.41	1.61	3.73	-75.29	-13.00	-62.29	V
257.9500	-84.84	1.89	5.61	-81.12	-13.00	-68.12	V
364.6500	-81.98	2.28	5.75	-78.51	-13.00	-65.51	V
441.2800	-82.11	2.54	5.87	-78.78	-13.00	-65.78	V
480.0800	-82.46	2.64	5.54	-79.56	-13.00	-66.56	V
75.5900	-71.49	1.01	-0.94	-73.44	-13.00	-60.44	H
121.1800	-67.19	1.28	-2	-70.47	-13.00	-57.47	H
174.5300	-73.32	1.59	3	-71.91	-13.00	-58.91	H
259.8900	-80.87	1.91	5.59	-77.19	-13.00	-64.19	H
364.6500	-76.08	2.28	5.75	-72.61	-13.00	-59.61	H
441.2800	-75.35	2.54	5.87	-72.02	-13.00	-59.02	H

Remark:

1. *Measuring frequencies from 1 GHz to the 10th harmonic of highest fundamental frequency.*
2. *Measurements above show only up to 6 maximum emissions noted, or would be lesser, with " N/A " remark, if no specific emissions from the EUT are recorded (ie: margin > 20dB from the applicable limit) and considered that's already beyond the background noise floor.*



Operation Mode: EDGE 850 / TX / CH 128

Test Date: March 12, 2013

Temperature: 25°C

Tested by: David Shu

Humidity: 50 % RH

Polarity: Ver. / Hor.

Frequency (MHz)	S.G. (dBm)	Cable loss (dB)	Ant.Gain (dBi)	Emission level (dBm)	Limit (dBm)	Margin (dB)	Antenna Polarization (V/H)
95.9600	-62.35	1.13	0.26	-63.22	-13.00	-50.22	V
180.3500	-75.63	1.61	3.62	-73.62	-13.00	-60.62	V
303.5400	-83.62	2.11	5.67	-80.06	-13.00	-67.06	V
402.4800	-82.11	2.41	5.97	-78.55	-13.00	-65.55	V
455.8300	-80.31	2.6	5.82	-77.09	-13.00	-64.09	V
565.4400	-83.09	2.86	6.04	-79.91	-13.00	-66.91	V
60.0700	-53.58	0.88	-2.19	-56.65	-13.00	-43.65	H
107.6000	-56.7	1.19	-1.39	-59.28	-13.00	-46.28	H
204.6000	-70.67	1.65	4.2	-68.12	-13.00	-55.12	H
319.0600	-74.62	2.17	5.71	-71.08	-13.00	-58.08	H
390.8400	-71.77	2.32	6	-68.09	-13.00	-55.09	H
516.9400	-74.59	2.7	6.07	-71.22	-13.00	-58.22	H

Remark:

1. *Measuring frequencies from 1 GHz to the 10th harmonic of highest fundamental frequency.*
2. *Measurements above show only up to 6 maximum emissions noted, or would be lesser, with “ N/A ” remark, if no specific emissions from the EUT are recorded (ie: margin>20dB from the applicable limit) and considered that's already beyond the background noise floor.*



Operation Mode: EDGE 850 / TX / CH 190

Test Date: March 12, 2013

Temperature: 25°C

Tested by: David Shu

Humidity: 50 % RH

Polarity: Ver. / Hor.

Frequency (MHz)	S.G. (dBm)	Cable loss (dB)	Ant.Gain (dBi)	Emission level (dBm)	Limit (dBm)	Margin (dB)	Antenna Polarization (V/H)
95.9600	-61.9	1.13	0.26	-62.77	-13.00	-49.77	V
179.3800	-74.52	1.61	3.52	-72.61	-13.00	-59.61	V
321.9700	-82.64	2.18	5.7	-79.12	-13.00	-66.12	V
448.0700	-78.23	2.58	5.74	-75.07	-13.00	-62.07	V
524.7000	-82.37	2.73	6.05	-79.05	-13.00	-66.05	V
625.5800	-81.46	2.96	6.16	-78.26	-13.00	-65.26	V
60.0700	-52.76	0.88	-2.19	-55.83	-13.00	-42.83	H
111.4800	-56.51	1.22	-1.76	-59.49	-13.00	-46.49	H
161.9200	-66.97	1.5	1.61	-66.86	-13.00	-53.86	H
346.2200	-72.02	2.21	5.8	-68.43	-13.00	-55.43	H
452.9200	-74.18	2.59	5.77	-71.00	-13.00	-58.00	H
516.9400	-74.82	2.7	6.07	-71.45	-13.00	-58.45	H

Remark:

1. *Measuring frequencies from 1 GHz to the 10th harmonic of highest fundamental frequency.*
2. *Measurements above show only up to 6 maximum emissions noted, or would be lesser, with " N/A " remark, if no specific emissions from the EUT are recorded (ie: margin > 20dB from the applicable limit) and considered that's already beyond the background noise floor.*



Operation Mode: EDGE 850 / TX / CH 251

Test Date: March 12, 2013

Temperature: 25°C

Tested by: David Shu

Humidity: 50 % RH

Polarity: Ver. / Hor.

Frequency (MHz)	S.G. (dBm)	Cable loss (dB)	Ant.Gain (dBi)	Emission level (dBm)	Limit (dBm)	Margin (dB)	Antenna Polarization (V/H)
74.6200	-71.47	1	-1.11	-73.58	-13.00	-60.58	V
186.1700	-76.72	1.62	3.85	-74.49	-13.00	-61.49	V
223.0300	-79.68	1.77	5.35	-76.10	-13.00	-63.10	V
364.6500	-79.98	2.28	5.75	-76.51	-13.00	-63.51	V
441.2800	-78.77	2.54	5.87	-75.44	-13.00	-62.44	V
480.0800	-80.98	2.64	5.54	-78.08	-13.00	-65.08	V
122.1500	-69.2	1.29	-1.93	-72.42	-13.00	-59.42	H
174.5300	-72.92	1.59	3	-71.51	-13.00	-58.51	H
364.6500	-74.72	2.28	5.75	-71.25	-13.00	-58.25	H
441.2800	-73.19	2.54	5.87	-69.86	-13.00	-56.86	H
480.0800	-74.22	2.64	5.54	-71.32	-13.00	-58.32	H
537.3100	-78.67	2.77	6.22	-75.22	-13.00	-62.22	H

Remark:

1. *Measuring frequencies from 1 GHz to the 10th harmonic of highest fundamental frequency.*
2. *Measurements above show only up to 6 maximum emissions noted, or would be lesser, with " N/A " remark, if no specific emissions from the EUT are recorded (ie: margin > 20dB from the applicable limit) and considered that's already beyond the background noise floor.*



Operation Mode: EDGE 1900 / TX / CH 512

Test Date: March 12, 2013

Temperature: 25°C

Tested by: David Shu

Humidity: 50 % RH

Polarity: Ver. / Hor.

Frequency (MHz)	S.G. (dBm)	Cable loss (dB)	Ant.Gain (dBi)	Emission level (dBm)	Limit (dBm)	Margin (dB)	Antenna Polarization (V/H)
74.6200	-71.47	1	-1.11	-73.58	-13.00	-60.58	V
186.1700	-76.72	1.62	3.85	-74.49	-13.00	-61.49	V
223.0300	-79.68	1.77	5.35	-76.10	-13.00	-63.10	V
364.6500	-79.98	2.28	5.75	-76.51	-13.00	-63.51	V
441.2800	-78.77	2.54	5.87	-75.44	-13.00	-62.44	V
480.0800	-80.98	2.64	5.54	-78.08	-13.00	-65.08	V
122.1500	-69.2	1.29	-1.93	-72.42	-13.00	-59.42	H
174.5300	-72.92	1.59	3	-71.51	-13.00	-58.51	H
364.6500	-74.72	2.28	5.75	-71.25	-13.00	-58.25	H
441.2800	-73.19	2.54	5.87	-69.86	-13.00	-56.86	H
480.0800	-74.22	2.64	5.54	-71.32	-13.00	-58.32	H
537.3100	-78.67	2.77	6.22	-75.22	-13.00	-62.22	H

Remark:

1. *Measuring frequencies from 1 GHz to the 10th harmonic of highest fundamental frequency.*
2. *Measurements above show only up to 6 maximum emissions noted, or would be lesser, with " N/A " remark, if no specific emissions from the EUT are recorded (ie: margin > 20dB from the applicable limit) and considered that's already beyond the background noise floor.*



Operation Mode: EDGE 1900 / TX / CH 661

Test Date: March 12, 2013

Temperature: 25°C

Tested by: David Shu

Humidity: 50 % RH

Polarity: Ver. / Hor.

Frequency (MHz)	S.G. (dBm)	Cable loss (dB)	Ant.Gain (dBi)	Emission level (dBm)	Limit (dBm)	Margin (dB)	Antenna Polarization (V/H)
76.5600	-72.72	1.01	-0.77	-74.50	-13.00	-61.50	V
180.3500	-76.23	1.61	3.62	-74.22	-13.00	-61.22	V
248.2500	-84.09	1.83	5.61	-80.31	-13.00	-67.31	V
337.4900	-78.33	2.17	5.77	-74.73	-13.00	-61.73	V
441.2800	-79.55	2.54	5.87	-76.22	-13.00	-63.22	V
480.0800	-80.12	2.64	5.54	-77.22	-13.00	-64.22	V
120.2100	-68.94	1.27	-2.06	-72.27	-13.00	-59.27	H
172.5900	-73.32	1.58	2.8	-72.10	-13.00	-59.10	H
364.6500	-73.48	2.28	5.75	-70.01	-13.00	-57.01	H
441.2800	-74.19	2.54	5.87	-70.86	-13.00	-57.86	H
480.0800	-74.3	2.64	5.54	-71.40	-13.00	-58.40	H
499.4800	-77.85	2.7	5.89	-74.66	-13.00	-61.66	H

Remark:

1. *Measuring frequencies from 1 GHz to the 10th harmonic of highest fundamental frequency.*
2. *Measurements above show only up to 6 maximum emissions noted, or would be lesser, with " N/A " remark, if no specific emissions from the EUT are recorded (ie: margin > 20dB from the applicable limit) and considered that's already beyond the background noise floor.*



Operation Mode: EDGE 1900 / TX / CH 810

Test Date: March 12, 2013

Temperature: 25°C

Tested by: David Shu

Humidity: 50 % RH

Polarity: Ver. / Hor.

Frequency (MHz)	S.G. (dBm)	Cable loss (dB)	Ant.Gain (dBi)	Emission level (dBm)	Limit (dBm)	Margin (dB)	Antenna Polarization (V/H)
74.6200	-72.07	1	-1.11	-74.18	-13.00	-61.18	V
119.2400	-77.72	1.27	-2.07	-81.06	-13.00	-68.06	V
184.2300	-77.21	1.61	3.77	-75.05	-13.00	-62.05	V
224.0000	-82.82	1.78	5.35	-79.25	-13.00	-66.25	V
364.6500	-82.88	2.28	5.75	-79.41	-13.00	-66.41	V
441.2800	-81.69	2.54	5.87	-78.36	-13.00	-65.36	V
74.6200	-69.93	1	-1.11	-72.04	-13.00	-59.04	H
120.2100	-67.9	1.27	-2.06	-71.23	-13.00	-58.23	H
173.5600	-74.44	1.58	2.9	-73.12	-13.00	-60.12	H
364.6500	-75.38	2.28	5.75	-71.91	-13.00	-58.91	H
441.2800	-74.63	2.54	5.87	-71.30	-13.00	-58.30	H
480.0800	-76.54	2.64	5.54	-73.64	-13.00	-60.64	H

Remark:

1. *Measuring frequencies from 1 GHz to the 10th harmonic of highest fundamental frequency.*
2. *Measurements above show only up to 6 maximum emissions noted, or would be lesser, with " N/A " remark, if no specific emissions from the EUT are recorded (ie: margin > 20dB from the applicable limit) and considered that's already beyond the background noise floor.*



Operation Mode: WCDMA Band II / TX / CH 9262

Test Date: March 12, 2013

Temperature: 25°C

Tested by: David Shu

Humidity: 50 % RH

Polarity: Ver. / Hor.

Frequency (MHz)	S.G. (dBm)	Cable loss (dB)	Ant.Gain (dBi)	Emission level (dBm)	Limit (dBm)	Margin (dB)	Antenna Polarization (V/H)
71.7100	-54.55	0.97	-1.61	-57.13	-13.00	-44.13	V
101.7800	-57.71	1.16	-0.64	-59.51	-13.00	-46.51	V
216.2400	-77.08	1.74	5.36	-73.46	-13.00	-60.46	V
354.9500	-77.69	2.25	5.75	-74.19	-13.00	-61.19	V
448.0700	-81.25	2.58	5.74	-78.09	-13.00	-65.09	V
697.3600	-79.35	3.11	6.42	-76.04	-13.00	-63.04	V
71.7100	-46.11	0.97	-1.61	-48.69	-13.00	-35.69	H
95.9600	-53.46	1.13	0.26	-54.33	-13.00	-41.33	H
319.0600	-75.82	2.17	5.71	-72.28	-13.00	-59.28	H
369.5000	-73.21	2.3	5.8	-69.71	-13.00	-56.71	H
516.9400	-73.73	2.7	6.07	-70.36	-13.00	-57.36	H
745.8600	-74.3	3.2	6.1	-71.40	-13.00	-58.40	H

Remark:

1. *Measuring frequencies from 1 GHz to the 10th harmonic of highest fundamental frequency.*
2. *Measurements above show only up to 6 maximum emissions noted, or would be lesser, with " N/A " remark, if no specific emissions from the EUT are recorded (ie: margin > 20dB from the applicable limit) and considered that's already beyond the background noise floor.*



Operation Mode: WCDMA Band II / TX / CH 9400

Test Date: March 12, 2013

Temperature: 25°C

Tested by: David Shu

Humidity: 50 % RH

Polarity: Ver. / Hor.

Frequency (MHz)	S.G. (dBm)	Cable loss (dB)	Ant.Gain (dBi)	Emission level (dBm)	Limit (dBm)	Margin (dB)	Antenna Polarization (V/H)
71.7100	-56.19	0.97	-1.61	-58.77	-13.00	-45.77	V
138.6400	-64.49	1.39	-0.38	-66.26	-13.00	-53.26	V
215.2700	-76.8	1.73	5.37	-73.16	-13.00	-60.16	V
354.9500	-77.55	2.25	5.75	-74.05	-13.00	-61.05	V
623.6400	-80.51	2.95	6.14	-77.32	-13.00	-64.32	V
697.3600	-80.05	3.11	6.42	-76.74	-13.00	-63.74	V
71.7100	-45.54	0.97	-1.61	-48.12	-13.00	-35.12	H
95.9600	-52.55	1.13	0.26	-53.42	-13.00	-40.42	H
138.6400	-65.78	1.39	-0.38	-67.55	-13.00	-54.55	H
345.2500	-72.58	2.2	5.8	-68.98	-13.00	-55.98	H
516.9400	-73.51	2.7	6.07	-70.14	-13.00	-57.14	H
757.5000	-74.24	3.22	6.25	-71.21	-13.00	-58.21	H

Remark:

1. *Measuring frequencies from 1 GHz to the 10th harmonic of highest fundamental frequency.*
2. *Measurements above show only up to 6 maximum emissions noted, or would be lesser, with " N/A " remark, if no specific emissions from the EUT are recorded (ie: margin > 20dB from the applicable limit) and considered that's already beyond the background noise floor.*



Operation Mode: WCDMA Band II / TX / CH 9538

Test Date: March 12, 2013

Temperature: 25°C

Tested by: David Shu

Humidity: 50 % RH

Polarity: Ver. / Hor.

Frequency (MHz)	S.G. (dBm)	Cable loss (dB)	Ant.Gain (dBi)	Emission level (dBm)	Limit (dBm)	Margin (dB)	Antenna Polarization (V/H)
71.7100	-51.6	0.97	-1.61	-54.18	-13.00	-41.18	V
102.7500	-59.01	1.16	-0.76	-60.93	-13.00	-47.93	V
138.6400	-65.64	1.39	-0.38	-67.41	-13.00	-54.41	V
354.9500	-78.2	2.25	5.75	-74.70	-13.00	-61.70	V
623.6400	-80.5	2.95	6.14	-77.31	-13.00	-64.31	V
757.5000	-78.26	3.22	6.25	-75.23	-13.00	-62.23	V
71.7100	-45.63	0.97	-1.61	-48.21	-13.00	-35.21	H
95.9600	-51.85	1.13	0.26	-52.72	-13.00	-39.72	H
144.4600	-66.51	1.41	0.17	-67.75	-13.00	-54.75	H
369.5000	-72.05	2.3	5.8	-68.55	-13.00	-55.55	H
516.9400	-74.22	2.7	6.07	-70.85	-13.00	-57.85	H
757.5000	-74.22	3.22	6.25	-71.19	-13.00	-58.19	H

Remark:

1. *Measuring frequencies from 1 GHz to the 10th harmonic of highest fundamental frequency.*
2. *Measurements above show only up to 6 maximum emissions noted, or would be lesser, with " N/A " remark, if no specific emissions from the EUT are recorded (ie: margin > 20dB from the applicable limit) and considered that's already beyond the background noise floor.*



Operation Mode: WCDMA Band V / TX / CH 4132

Test Date: March 12, 2013

Temperature: 25°C

Tested by: David Shu

Humidity: 50 % RH

Polarity: Ver. / Hor.

Frequency (MHz)	S.G. (dBm)	Cable loss (dB)	Ant.Gain (dBi)	Emission level (dBm)	Limit (dBm)	Margin (dB)	Antenna Polarization (V/H)
71.7100	-50.46	0.97	-1.61	-53.04	-13.00	-40.04	V
95.9600	-58.5	1.13	0.26	-59.37	-13.00	-46.37	V
180.3500	-73.09	1.61	3.62	-71.08	-13.00	-58.08	V
354.9500	-77.21	2.25	5.75	-73.71	-13.00	-60.71	V
623.6400	-81.02	2.95	6.14	-77.83	-13.00	-64.83	V
828.3100	-75.47	3.39	6.28	-72.58	-13.00	-59.58	V
71.7100	-44.42	0.97	-1.61	-47.00	-13.00	-34.00	H
95.9600	-51.12	1.13	0.26	-51.99	-13.00	-38.99	H
144.4600	-65.08	1.41	0.17	-66.32	-13.00	-53.32	H
369.5000	-71.96	2.3	5.8	-68.46	-13.00	-55.46	H
529.5500	-74.14	2.75	6	-70.89	-13.00	-57.89	H
826.3700	-69.64	3.39	6.26	-66.77	-13.00	-53.77	H

Remark:

1. *Measuring frequencies from 1 GHz to the 10th harmonic of highest fundamental frequency.*
2. *Measurements above show only up to 6 maximum emissions noted, or would be lesser, with " N/A " remark, if no specific emissions from the EUT are recorded (ie: margin > 20dB from the applicable limit) and considered that's already beyond the background noise floor.*



Operation Mode: WCDMA Band V / TX / CH 4182

Test Date: March 12, 2013

Temperature: 25°C

Tested by: David Shu

Humidity: 50 % RH

Polarity: Ver. / Hor.

Frequency (MHz)	S.G. (dBm)	Cable loss (dB)	Ant.Gain (dBi)	Emission level (dBm)	Limit (dBm)	Margin (dB)	Antenna Polarization (V/H)
71.7100	-53.79	0.97	-1.61	-56.37	-13.00	-43.37	V
216.2400	-76.88	1.74	5.36	-73.26	-13.00	-60.26	V
354.9500	-76.89	2.25	5.75	-73.39	-13.00	-60.39	V
439.3400	-80.17	2.53	5.9	-76.80	-13.00	-63.80	V
610.0600	-81.35	2.94	6.29	-78.00	-13.00	-65.00	V
835.1000	-78.97	3.4	6.35	-76.02	-13.00	-63.02	V
71.7100	-44.3	0.97	-1.61	-46.88	-13.00	-33.88	H
95.9600	-50.66	1.13	0.26	-51.53	-13.00	-38.53	H
144.4600	-64.69	1.41	0.17	-65.93	-13.00	-52.93	H
346.2200	-71.27	2.21	5.8	-67.68	-13.00	-54.68	H
516.9400	-72.13	2.7	6.07	-68.76	-13.00	-55.76	H
565.4400	-74.92	2.86	6.04	-71.74	-13.00	-58.74	H

Remark:

1. *Measuring frequencies from 1 GHz to the 10th harmonic of highest fundamental frequency.*
2. *Measurements above show only up to 6 maximum emissions noted, or would be lesser, with " N/A " remark, if no specific emissions from the EUT are recorded (ie: margin > 20dB from the applicable limit) and considered that's already beyond the background noise floor.*



Operation Mode: WCDMA Band V / TX / CH 4233

Test Date: March 12, 2013

Temperature: 25°C

Tested by: David Shu

Humidity: 50 % RH

Polarity: Ver. / Hor.

Frequency (MHz)	S.G. (dBm)	Cable loss (dB)	Ant.Gain (dBi)	Emission level (dBm)	Limit (dBm)	Margin (dB)	Antenna Polarization (V/H)
71.7100	-49.21	0.97	-1.61	-51.79	-13.00	-38.79	V
101.7800	-56.09	1.16	-0.64	-57.89	-13.00	-44.89	V
354.9500	-76.31	2.25	5.75	-72.81	-13.00	-59.81	V
448.0700	-79.25	2.58	5.74	-76.09	-13.00	-63.09	V
623.6400	-79.74	2.95	6.14	-76.55	-13.00	-63.55	V
848.6800	-76.3	3.4	6.4	-73.30	-13.00	-60.30	V
71.7100	-41.75	0.97	-1.61	-44.33	-13.00	-31.33	H
95.9600	-48.56	1.13	0.26	-49.43	-13.00	-36.43	H
346.2200	-68.12	2.21	5.8	-64.53	-13.00	-51.53	H
516.9400	-69.68	2.7	6.07	-66.31	-13.00	-53.31	H
625.5800	-73.09	2.96	6.16	-69.89	-13.00	-56.89	H
847.7100	-69.67	3.4	6.4	-66.67	-13.00	-53.67	H

Remark:

1. *Measuring frequencies from 1 GHz to the 10th harmonic of highest fundamental frequency.*
2. *Measurements above show only up to 6 maximum emissions noted, or would be lesser, with " N/A " remark, if no specific emissions from the EUT are recorded (ie: margin > 20dB from the applicable limit) and considered that's already beyond the background noise floor.*



Above 1GHz

Operation Mode: GPRS 850 / TX / CH 128

Test Date: March 12, 2013

Temperature: 25°C

Tested by: David Shu

Humidity: 55 % RH

Polarity: Ver. / Hor.

Frequency (MHz)	S.G. (dBm)	Cable loss (dB)	Ant.Gain (dBi)	Emission level (dBm)	Limit (dBm)	Margin (dB)	Antenna Polarization (V/H)
1651.000	-48.21	5.05	6.03	-47.23	-13.00	-34.23	V
4122.000	-49.27	8.47	9.5	-48.24	-13.00	-35.24	V
N/A							
2547.000	-41.39	6.42	6.22	-41.59	-13.00	-28.59	H
4241.000	-43.21	8.54	9.59	-42.16	-13.00	-29.16	H
N/A							

Remark:

- 1. The emission behaviour belongs to narrowband spurious emission.*
- 2. Measurements above show only up to 6 maximum emissions noted, or would be lesser; with " N/A " remark, if no specific emissions from the EUT are recorded (ie: margin > 20dB from the applicable limit) and considered that's already beyond the background noise floor.*



Operation Mode: GPRS 850 / TX / CH 190

Test Date: March 12, 2013

Temperature: 25°C

Tested by: David Shu

Humidity: 55 % RH

Polarity: Ver. / Hor.

Frequency (MHz)	S.G. (dBm)	Cable loss (dB)	Ant.Gain (dBi)	Emission level (dBm)	Limit (dBm)	Margin (dB)	Antenna Polarization (V/H)
1672.000	-46.31	5.07	5.99	-45.39	-13.00	-32.39	V
4185.000	-43.07	8.49	9.55	-42.01	-13.00	-29.01	V
N/A							
1651.000	-48.26	5.05	6.03	-47.28	-13.00	-34.28	H
4122.000	-46.76	8.47	9.5	-45.73	-13.00	-32.73	H
6593.000	-44.91	11.22	11.41	-44.72	-13.00	-31.72	H
N/A							

Remark:

1. *The emission behaviour belongs to narrowband spurious emission.*
2. *Measurements above show only up to 6 maximum emissions noted, or would be lesser, with " N/A " remark, if no specific emissions from the EUT are recorded (ie: margin>20dB from the applicable limit) and considered that's already beyond the background noise floor.*



Operation Mode: GPRS 850 / TX / CH 251

Test Date: March 12, 2013

Temperature: 25°C

Tested by: David Shu

Humidity: 55 % RH

Polarity: Ver. / Hor.

Frequency (MHz)	S.G. (dBm)	Cable loss (dB)	Ant.Gain (dBi)	Emission level (dBm)	Limit (dBm)	Margin (dB)	Antenna Polarization (V/H)
4241.000	-48.28	8.54	9.59	-47.23	-13.00	-34.23	V
5095.000	-49.15	9.45	10.64	-47.96	-13.00	-34.96	V
N/A							
2512.000	-44.84	6.37	6.13	-45.08	-13.00	-32.08	H
4185.000	-40.69	8.49	9.55	-39.63	-13.00	-26.63	H
N/A							

Remark:

- 1. The emission behaviour belongs to narrowband spurious emission.*
- 2. Measurements above show only up to 6 maximum emissions noted, or would be lesser, with " N/A " remark, if no specific emissions from the EUT are recorded (ie: margin>20dB from the applicable limit) and considered that's already beyond the background noise floor.*



Operation Mode: GPRS 1900 / TX / CH 512

Test Date: March 12, 2013

Temperature: 25°C

Tested by: David Shu

Humidity: 55 % RH

Polarity: Ver. / Hor.

Frequency (MHz)	S.G. (dBm)	Cable loss (dB)	Ant.Gain (dBi)	Emission level (dBm)	Limit (dBm)	Margin (dB)	Antenna Polarization (V/H)
3702.000	-46.6	8.2	9.1	-45.70	-13.00	-32.70	V
5550.000	-45.15	10.06	10.81	-44.40	-13.00	-31.40	V
N/A							
3702.000	-48.95	8.2	9.1	-48.05	-13.00	-35.05	H
5550.000	-46	10.06	10.81	-45.25	-13.00	-32.25	H
N/A							

Remark:

1. *Measuring frequencies from 1 GHz to the 10th harmonic of highest fundamental frequency.*
2. *Measurements above show only up to 6 maximum emissions noted, or would be lesser, with " N/A " remark, if no specific emissions from the EUT are recorded (ie: margin > 20dB from the applicable limit) and considered that's already beyond the background noise floor.*



Operation Mode: GPRS 1900 / TX / CH 661

Test Date: March 12, 2013

Temperature: 25°C

Tested by: David Shu

Humidity: 55 % RH

Polarity: Ver. / Hor.

Frequency (MHz)	S.G. (dBm)	Cable loss (dB)	Ant.Gain (dBi)	Emission level (dBm)	Limit (dBm)	Margin (dB)	Antenna Polarization (V/H)
3758.000	-51.34	8.23	9.16	-50.41	-13.00	-37.41	V
5984.000	-52.09	10.76	10.9	-51.95	-13.00	-38.95	V
N/A							
3758.000	-51.51	8.23	9.16	-50.58	-13.00	-37.58	H
5641.000	-50.78	10.18	10.83	-50.13	-13.00	-37.13	H
N/A							

Remark:

1. *Measuring frequencies from 1 GHz to the 10th harmonic of highest fundamental frequency.*
2. *Measurements above show only up to 6 maximum emissions noted, or would be lesser, with " N/A " remark, if no specific emissions from the EUT are recorded (ie: margin > 20dB from the applicable limit) and considered that's already beyond the background noise floor.*



Operation Mode: GPRS 1900 / TX / CH 810

Test Date: March 12, 2013

Temperature: 25°C

Tested by: David Shu

Humidity: 55 % RH

Polarity: Ver. / Hor.

Frequency (MHz)	S.G. (dBm)	Cable loss (dB)	Ant.Gain (dBi)	Emission level (dBm)	Limit (dBm)	Margin (dB)	Antenna Polarization (V/H)
3933.000	-52.65	8.38	9.33	-51.70	-13.00	-38.70	V
6957.000	-46.93	11.54	11.85	-46.62	-13.00	-33.62	V
N/A							
4325.000	-51.44	8.61	9.66	-50.39	-13.00	-37.39	H
5732.000	-49.83	10.24	10.85	-49.22	-13.00	-36.22	H
N/A							

Remark:

1. *Measuring frequencies from 1 GHz to the 10th harmonic of highest fundamental frequency.*
2. *Measurements above show only up to 6 maximum emissions noted, or would be lesser, with " N/A " remark, if no specific emissions from the EUT are recorded (ie: margin > 20dB from the applicable limit) and considered that's already beyond the background noise floor.*



Operation Mode: EDGE 850 / TX / CH 128

Test Date: March 12, 2013

Temperature: 25°C

Tested by: David Shu

Humidity: 50 % RH

Polarity: Ver. / Hor.

Frequency (MHz)	S.G. (dBm)	Cable loss (dB)	Ant.Gain (dBi)	Emission level (dBm)	Limit (dBm)	Margin (dB)	Antenna Polarization (V/H)
1749.000	-47.07	5.2	5.85	-46.42	-13.00	-33.42	V
3296.000	-48.05	7.45	8.29	-47.21	-13.00	-34.21	V
7419.000	-43.14	12.12	12.57	-42.69	-13.00	-29.69	V
N/A							
1651.000	-47.82	5.05	6.03	-46.84	-13.00	-33.84	H
4122.000	-47.83	8.47	9.5	-46.80	-13.00	-33.80	H
N/A							

Remark:

1. *Measuring frequencies from 1 GHz to the 10th harmonic of highest fundamental frequency.*
2. *Measurements above show only up to 6 maximum emissions noted, or would be lesser, with " N/A " remark, if no specific emissions from the EUT are recorded (ie: margin>20dB from the applicable limit) and considered that's already beyond the background noise floor.*



Operation Mode: EDGE 850 / TX / CH 190

Test Date: March 12, 2013

Temperature: 25°C

Tested by: David Shu

Humidity: 50 % RH

Polarity: Ver. / Hor.

Frequency (MHz)	S.G. (dBm)	Cable loss (dB)	Ant.Gain (dBi)	Emission level (dBm)	Limit (dBm)	Margin (dB)	Antenna Polarization (V/H)
2512.000	-46.65	6.37	6.13	-46.89	-13.00	-33.89	V
4185.000	-41.06	8.49	9.55	-40.00	-13.00	-27.00	V
N/A							
1672.000	-46.82	5.07	5.99	-45.90	-13.00	-32.90	H
4185.000	-45.29	8.49	9.55	-44.23	-13.00	-31.23	H
N/A							

Remark:

1. *Measuring frequencies from 1 GHz to the 10th harmonic of highest fundamental frequency.*
2. *Measurements above show only up to 6 maximum emissions noted, or would be lesser, with " N/A " remark, if no specific emissions from the EUT are recorded (ie: margin > 20dB from the applicable limit) and considered that's already beyond the background noise floor.*



Operation Mode: EDGE 850 / TX / CH 251

Test Date: March 12, 2013

Temperature: 25°C

Tested by: David Shu

Humidity: 50 % RH

Polarity: Ver. / Hor.

Frequency (MHz)	S.G. (dBm)	Cable loss (dB)	Ant.Gain (dBi)	Emission level (dBm)	Limit (dBm)	Margin (dB)	Antenna Polarization (V/H)
2547.000	-41.82	6.42	6.22	-42.02	-13.00	-29.02	V
4241.000	-43.85	8.54	9.59	-42.80	-13.00	-29.80	V
N/A							
4241.000	-48.04	8.54	9.59	-46.99	-13.00	-33.99	H
5095.000	-51.05	9.45	10.64	-49.86	-13.00	-36.86	H
N/A							

Remark:

1. Measuring frequencies from 1 GHz to the 10th harmonic of highest fundamental frequency.
2. Measurements above show only up to 6 maximum emissions noted, or would be lesser, with " N/A " remark, if no specific emissions from the EUT are recorded (ie: margin > 20dB from the applicable limit) and considered that's already beyond the background noise floor.



Operation Mode: EDGE 1900 / TX / CH 512

Test Date: March 12, 2013

Temperature: 25°C

Tested by: David Shu

Humidity: 50 % RH

Polarity: Ver. / Hor.

Frequency (MHz)	S.G. (dBm)	Cable loss (dB)	Ant.Gain (dBi)	Emission level (dBm)	Limit (dBm)	Margin (dB)	Antenna Polarization (V/H)
3702.000	-48.66	8.2	9.1	-47.76	-13.00	-34.76	V
5550.000	-46.28	10.06	10.81	-45.53	-13.00	-32.53	V
N/A							
3702.000	-44.17	8.2	9.1	-43.27	-13.00	-30.27	H
5550.000	-44.1	10.06	10.81	-43.35	-13.00	-30.35	H
N/A							

Remark:

1. *Measuring frequencies from 1 GHz to the 10th harmonic of highest fundamental frequency.*
2. *Measurements above show only up to 6 maximum emissions noted, or would be lesser, with " N/A " remark, if no specific emissions from the EUT are recorded (ie: margin > 20dB from the applicable limit) and considered that's already beyond the background noise floor.*



Operation Mode: EDGE 1900 / TX / CH 661

Test Date: March 12, 2013

Temperature: 25°C

Tested by: David Shu

Humidity: 50 % RH

Polarity: Ver. / Hor.

Frequency (MHz)	S.G. (dBm)	Cable loss (dB)	Ant.Gain (dBi)	Emission level (dBm)	Limit (dBm)	Margin (dB)	Antenna Polarization (V/H)
3758.000	-52.95	8.23	9.16	-52.02	-13.00	-39.02	V
5641.000	-51.98	10.18	10.83	-51.33	-13.00	-38.33	V
N/A							
3758.000	-51.51	8.23	9.16	-50.18	-13.00	-37.18	H
5641.000	-50.78	10.18	10.83	-49.10	-13.00	-36.10	H
N/A							

Remark:

1. *Measuring frequencies from 1 GHz to the 10th harmonic of highest fundamental frequency.*
2. *Measurements above show only up to 6 maximum emissions noted, or would be lesser, with " N/A " remark, if no specific emissions from the EUT are recorded (ie: margin > 20dB from the applicable limit) and considered that's already beyond the background noise floor.*



Operation Mode: EDGE 1900 / TX / CH 810

Test Date: March 12, 2013

Temperature: 25°C

Tested by: David Shu

Humidity: 50 % RH

Polarity: Ver. / Hor.

Frequency (MHz)	S.G. (dBm)	Cable loss (dB)	Ant.Gain (dBi)	Emission level (dBm)	Limit (dBm)	Margin (dB)	Antenna Polarization (V/H)
4003.000	-53.28	8.35	9.4	-52.23	-13.00	-39.23	V
6096.000	-50.95	10.63	10.98	-50.60	-13.00	-37.60	V
N/A							
3821.000	-52.59	8.29	9.22	-51.66	-13.00	-38.66	H
7370.000	-43.57	12.07	12.49	-43.15	-13.00	-30.15	H
N/A							

Remark:

1. Measuring frequencies from 1 GHz to the 10th harmonic of highest fundamental frequency.
2. Measurements above show only up to 6 maximum emissions noted, or would be lesser, with " N/A " remark, if no specific emissions from the EUT are recorded (ie: margin > 20dB from the applicable limit) and considered that's already beyond the background noise floor.



Operation Mode: WCDMA Band II / TX / CH 9262

Test Date: March 12, 2013

Temperature: 25°C

Tested by: David Shu

Humidity: 50 % RH

Polarity: Ver. / Hor.

Frequency (MHz)	S.G. (dBm)	Cable loss (dB)	Ant.Gain (dBi)	Emission level (dBm)	Limit (dBm)	Margin (dB)	Antenna Polarization (V/H)
3702.000	-47.83	8.2	9.1	-46.93	-13.00	-33.93	V
5564.000	-41.13	10.1	10.81	-40.42	-13.00	-27.42	V
N/A							
3702.000	-52.08	8.2	9.1	-51.18	-13.00	-38.18	H
5557.000	-48.39	10.08	10.81	-47.66	-13.00	-34.66	H
N/A							

Remark:

1. *Measuring frequencies from 1 GHz to the 10th harmonic of highest fundamental frequency.*
2. *Measurements above show only up to 6 maximum emissions noted, or would be lesser, with " N/A " remark, if no specific emissions from the EUT are recorded (ie: margin > 20dB from the applicable limit) and considered that's already beyond the background noise floor.*



Operation Mode: WCDMA Band II / TX / CH 9400

Test Date: March 12, 2013

Temperature: 25°C

Tested by: David Shu

Humidity: 50 % RH

Polarity: Ver. / Hor.

Frequency (MHz)	S.G. (dBm)	Cable loss (dB)	Ant.Gain (dBi)	Emission level (dBm)	Limit (dBm)	Margin (dB)	Antenna Polarization (V/H)
3758.000	-44.91	8.23	9.16	-43.98	-13.00	-30.98	V
5634.000	-47.05	10.18	10.83	-46.40	-13.00	-33.40	V
N/A							
3758.000	-48.2	8.23	9.16	-47.27	-13.00	-34.27	H
5634.000	-51.83	10.18	10.83	-51.18	-13.00	-38.18	H
N/A							

Remark:

1. *Measuring frequencies from 1 GHz to the 10th harmonic of highest fundamental frequency.*
2. *Measurements above show only up to 6 maximum emissions noted, or would be lesser, with " N/A " remark, if no specific emissions from the EUT are recorded (ie: margin > 20dB from the applicable limit) and considered that's already beyond the background noise floor.*



Operation Mode: WCDMA Band II / TX / CH 9538

Test Date: March 12, 2013

Temperature: 25°C

Tested by: David Shu

Humidity: 50 % RH

Polarity: Ver. / Hor.

Frequency (MHz)	S.G. (dBm)	Cable loss (dB)	Ant.Gain (dBi)	Emission level (dBm)	Limit (dBm)	Margin (dB)	Antenna Polarization (V/H)
3814.000	-41.29	8.28	9.21	-40.36	-13.00	-27.36	V
5718.000	-44.72	10.21	10.84	-44.09	-13.00	-31.09	V
N/A							
3814.000	-47.36	8.28	9.21	-46.43	-13.00	-33.43	H
6138.000	-50.09	10.85	11.01	-49.93	-13.00	-36.93	H
N/A							

Remark:

1. *Measuring frequencies from 1 GHz to the 10th harmonic of highest fundamental frequency.*
2. *Measurements above show only up to 6 maximum emissions noted, or would be lesser, with “ N/A ” remark, if no specific emissions from the EUT are recorded (ie: margin > 20dB from the applicable limit) and considered that's already beyond the background noise floor.*



Operation Mode: WCDMA Band V / TX / CH 4132

Test Date: March 12, 2013

Temperature: 25°C

Tested by: David Shu

Humidity: 50 % RH

Polarity: Ver. / Hor.

Frequency (MHz)	S.G. (dBm)	Cable loss (dB)	Ant.Gain (dBi)	Emission level (dBm)	Limit (dBm)	Margin (dB)	Antenna Polarization (V/H)
1651.000	-50.37	5.05	6.03	-49.39	-13.00	-36.39	V
4906.000	-55.35	9.27	10.45	-54.17	-13.00	-41.17	V
N/A							
1658.000	-49.37	5.06	6.02	-48.41	-13.00	-35.41	H
5179.000	-54.88	9.54	10.67	-53.75	-13.00	-40.75	H
N/A							

Remark:

1. *Measuring frequencies from 1 GHz to the 10th harmonic of highest fundamental frequency.*
2. *Measurements above show only up to 6 maximum emissions noted, or would be lesser, with " N/A " remark, if no specific emissions from the EUT are recorded (ie: margin > 20dB from the applicable limit) and considered that's already beyond the background noise floor.*



Operation Mode: WCDMA Band V / TX / CH 4182

Test Date: March 12, 2013

Temperature: 25°C

Tested by: David Shu

Humidity: 50 % RH

Polarity: Ver. / Hor.

Frequency (MHz)	S.G. (dBm)	Cable loss (dB)	Ant.Gain (dBi)	Emission level (dBm)	Limit (dBm)	Margin (dB)	Antenna Polarization (V/H)
1672.000	-49.82	5.07	5.99	-48.90	-13.00	-35.90	V
4738.000	-55.24	9.2	10.18	-54.26	-13.00	-41.26	V
N/A							
1672.000	-47.71	5.07	5.99	-46.79	-13.00	-33.79	H
5102.000	-54.43	9.45	10.64	-53.24	-13.00	-40.24	H
N/A							

Remark:

1. Measuring frequencies from 1 GHz to the 10th harmonic of highest fundamental frequency.
2. Measurements above show only up to 6 maximum emissions noted, or would be lesser, with " N/A " remark, if no specific emissions from the EUT are recorded (ie: margin > 20dB from the applicable limit) and considered that's already beyond the background noise floor.



Operation Mode: WCDMA Band V / TX / CH 4233

Test Date: March 12, 2013

Temperature: 25°C

Tested by: David Shu

Humidity: 50 % RH

Polarity: Ver. / Hor.

Frequency (MHz)	S.G. (dBm)	Cable loss (dB)	Ant.Gain (dBi)	Emission level (dBm)	Limit (dBm)	Margin (dB)	Antenna Polarization (V/H)
1693.000	-48.71	5.1	5.95	-47.86	-13.00	-34.86	V
5109.000	-55.92	9.46	10.64	-54.74	-13.00	-41.74	V
N/A							
1693.000	-48.11	5.1	5.95	-47.26	-13.00	-34.26	H
4612.000	-54.21	9.13	9.98	-53.36	-13.00	-40.36	H
N/A							

Remark:

1. *Measuring frequencies from 1 GHz to the 10th harmonic of highest fundamental frequency.*
2. *Measurements above show only up to 6 maximum emissions noted, or would be lesser, with " N/A " remark, if no specific emissions from the EUT are recorded (ie: margin > 20dB from the applicable limit) and considered that's already beyond the background noise floor.*



7.6 FREQUENCY STABILITY V.S. TEMPERATURE MEASUREMENT

LIMIT

According to FCC §2.1055, FCC §24.235, RSS-132 (4.3) & RSS-133 (6.3).

Frequency Tolerance: 2.5 ppm

Test Configuration

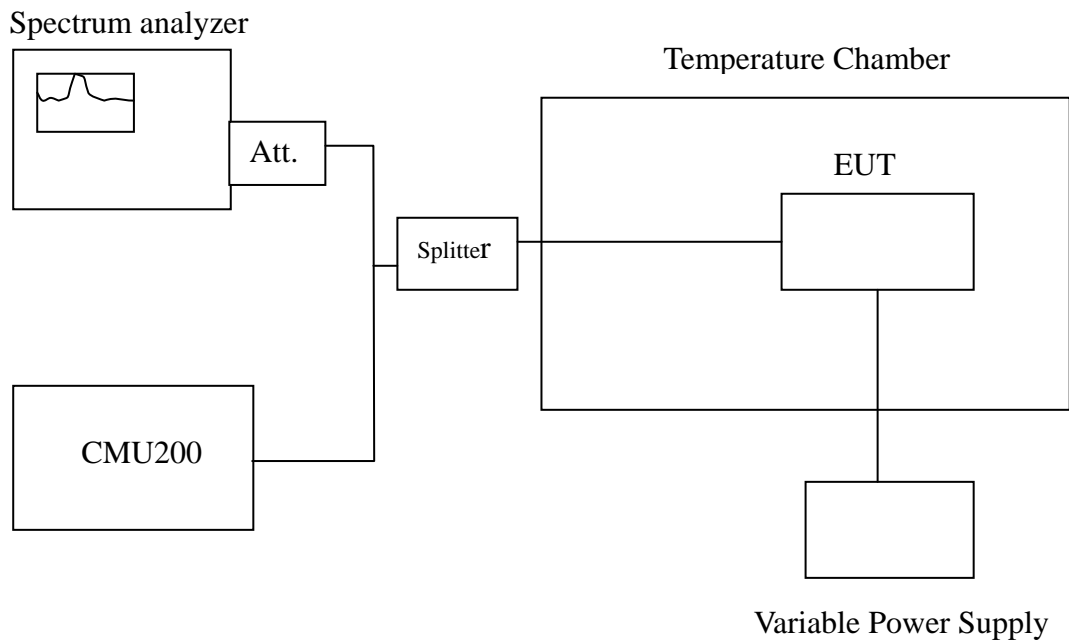

Remark: Measurement setup for testing on Antenna connector



TEST PROCEDURE

The equipment under test was connected to an external AC or DC power supply and input rated voltage. RF output was connected to a frequency counter or spectrum analyzer via feed through attenuators. The EUT was placed inside the temperature chamber. Set the spectrum analyzer RBW low enough to obtain the desired frequency resolution and measure EUT 20°C operating frequency as reference frequency. Turn EUT off and set the chamber temperature to -30°C. After the temperature stabilized for approximately 30 minutes recorded the frequency. Repeat step measure with 10°C increased per stage until the highest temperature of +50°C reached.

TEST RESULTS

No non-compliance noted.

Reference Frequency: GPRS Mid Channel 836.6 MHz @ 20°C				
Limit: +/- 2.5 ppm = 2090 Hz				
Power Supply Vdc	Environment Temperature (°C)	Frequency (Hz)	Delta (Hz)	Limit (Hz)
3.7	50	836599999	-4	2090
	40	836599998	-5	
	30	836599995	-8	
	20	836600003	0	
	10	836599997	-6	
	0	836599994	-9	
	-10	836599993	-10	
	-20	836599997	-6	
	-30	836599996	-7	

Reference Frequency: GPRS Mid Channel 1880 MHz @ 20°C				
Limit: ± 2.5 ppm = 4700 Hz				
Power Supply Vdc	Environment Temperature (°C)	Frequency (Hz)	Delta (Hz)	Limit (Hz)
3.7	50	1879999997	-9	4700
	40	1879999998	-8	
	30	1879999995	-11	
	20	1880000006	0	
	10	1879999992	-14	
	0	1880000004	-2	
	-10	1879999995	-11	
	-20	1879999998	-8	
	-30	1879999997	-9	



Reference Frequency: EDGE Mid Channel 836.6 MHz @ 20°C				
Limit: +/- 2.5 ppm = 2090 Hz				
Power Supply Vdc	Environment Temperature (°C)	Frequency (Hz)	Delta (Hz)	Limit (Hz)
3.7	50	83599998	-7	2090
	40	83599993	-12	
	30	83599983	-22	
	20	83600005	0	
	10	83599991	-14	
	0	83599995	-10	
	-10	83599994	-11	
	-20	83599993	-12	
	-30	83599999	-6	

Reference Frequency: EDGE Mid Channel 1880 MHz @ 20°C				
Limit: ± 2.5 ppm = 4700 Hz				
Power Supply Vdc	Environment Temperature (°C)	Frequency (Hz)	Delta (Hz)	Limit (Hz)
3.7	50	1879999998	-7	4700
	40	1879999997	-8	
	30	1879999996	-9	
	20	1880000005	0	
	10	1879999992	-13	
	0	1879999990	-15	
	-10	1879999996	-9	
	-20	1879999994	-11	
	-30	1879999999	-6	



Reference Frequency: WCDMA Band II Mid Channel 1880 MHz @ 20°C				
Limit: ± 2.5 ppm = 4700 Hz				
Power Supply Vdc	Environment Temperature (°C)	Frequency (Hz)	Delta (Hz)	Limit (Hz)
3.7	50	1879999996	-11	4700
	40	1880000003	-4	
	30	1879999998	-9	
	20	1880000007	0	
	10	1879999995	-12	
	0	1879999997	-10	
	-10	1879999995	-12	
	-20	1879999993	-14	
	-30	1880000006	-1	

Reference Frequency: WCDMA Band V Mid Channel 836.6 MHz @ 20°C				
Limit: ± 2.5 ppm = 2090 Hz				
Power Supply Vdc	Environment Temperature (°C)	Frequency (Hz)	Delta (Hz)	Limit (Hz)
3.7	50	836399997	3	2090
	40	836399996	2	
	30	836399998	4	
	20	836399994	0	
	10	836399995	1	
	0	836399996	2	
	-10	836399993	-1	
	-20	836400003	9	
	-30	836400005	11	



7.7 FREQUENCY STABILITY V.S. VOLTAGE MEASUREMENT

LIMIT

According to FCC §2.1055, FCC §22.355, .FCC §24.235,

Frequency Tolerance: 2.5 ppm.

According to RSS-132 (4.3) & RSS-133 (6.3).

The carrier frequency shall not depart from the reference frequency in excess of ± 2.5 ppm for mobile stations and ± 1.0 ppm for base stations.

Test Configuration

Spectrum analyzer

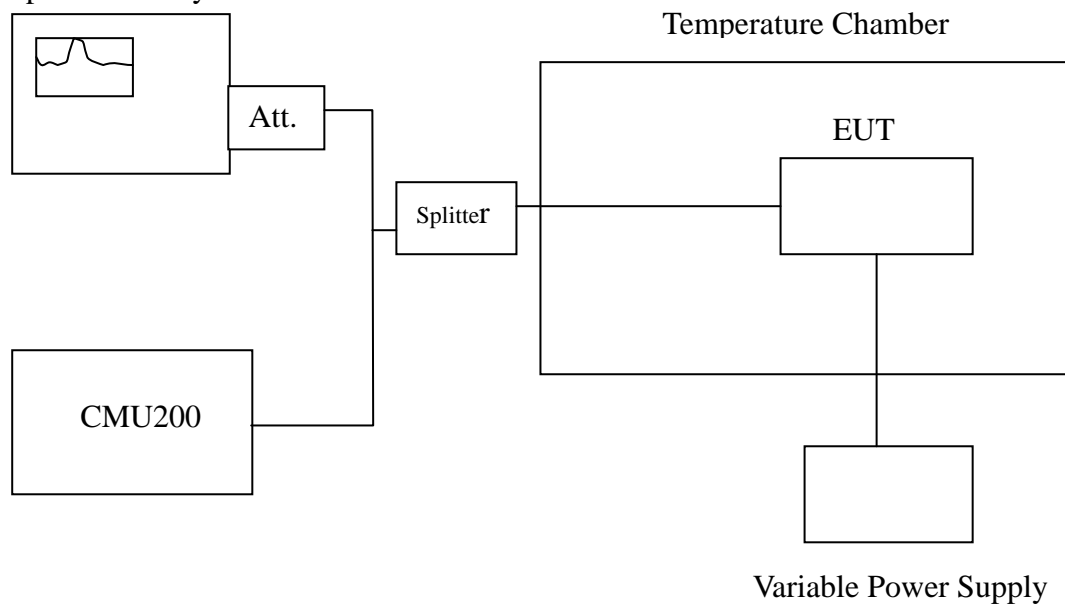

Remark: Measurement setup for testing on Antenna connector.



TEST PROCEDURE

Set chamber temperature to 20°C. Use a variable AC power supply / DC power source to power the EUT and set the voltage to rated voltage. Set the spectrum analyzer RBW low enough to obtain the desired frequency resolution and recorded the frequency.

Reduce the input voltage to specify extreme voltage variation ($\pm 15\%$) and endpoint, record the maximum frequency change.

TEST RESULTS

No non-compliance noted.

Reference Frequency: GPRS Mid Channel 836.6 MHz @ 20°C				
Limit: ± 2.5 ppm = 2090Hz				
Power Supply Vdc	Environment Temperature (°C)	Frequency (Hz)	Delta (Hz)	Limit (Hz)
4.255	20	836600002	-1	2090
3.7		836600003	0	
3.145		836600004	1	
2.9END		836599975	-28	

Reference Frequency: GPRS Mid Channel 1880 MHz @ 20°C				
Limit: ± 2.5 ppm = 4700 Hz				
Power Supply Vdc	Environment Temperature (°C)	Frequency (Hz)	Delta (Hz)	Limit (Hz)
4.255	20	1880000002	-4	4700
3.7		1880000006	0	
3.145		1880000005	-1	
2.9END		1880000069	63	



Reference Frequency: EDGE Mid Channel 836.6 MHz @ 20°C				
Limit: ± 2.5 ppm = 2090Hz				
Power Supply Vdc	Environment Temperature (°C)	Frequency (Hz)	Delta (Hz)	Limit (Hz)
4.255	20	83600001	-4	2090
3.7		83600005	0	
3.145		83600008	3	
2.9END		83600007	-1	

Reference Frequency: EDGE Mid Channel 1880 MHz @ 20°C				
Limit: ± 2.5 ppm = 4700 Hz				
Power Supply Vdc	Environment Temperature (°C)	Frequency (Hz)	Delta (Hz)	Limit (Hz)
4.255	20	1880000002	-3	4700
3.7		1880000005	0	
3.145		1880000006	1	
2.9END		1880000004	-1	



Reference Frequency: WCDMA Band II Mid Channel 1880 MHz @ 20°C				
Limit: ± 2.5 ppm = 4700 Hz				
Power Supply Vdc	Environment Temperature (°C)	Frequency (Hz)	Delta (Hz)	Limit (Hz)
4.255	20	1880000003	-4	4700
3.7		1880000007	0	
3.145		1879999989	-18	
2.9End		1880000059	52	

Reference Frequency: WCDMA Band V Mid Channel 836.6 MHz @ 20°C				
Limit: ± 2.5 ppm = 2090Hz				
Power Supply Vdc	Environment Temperature (°C)	Frequency (Hz)	Delta (Hz)	Limit (Hz)
4.255	20	836400005	11	2090
3.7		836399994	0	
3.145		836400003	9	
2.9End		836400073	79	