



A Tyco International Company

Digital Security Controls
3301 Langstaff Road
Concord, Ontario Canada L4K 4L2
Tele: 905 760 3000
Toll Free: 888 888 7838
Fax: 905-760-3020

1800xxxxR001
PG9939 Keyfob
FCC/IC Label
March 1, 2013

Colour: Pantone Process Black

Material: **CLEAR** Durable Semi-gloss
Self-adhesive Material - on a roll

Lamination: Top gloss finish lamination
(e.g. 1F9, or equivalent)

Adhesive: Permanent adhesive backed with
protective liner (e.g. 60# Semigloss Tire-III / 40#
Liner Code: B37, or equivalent)

Cutting: Tolerance +/- 0.010"

Dashed line indicates cutting - will not print

NOTES:

1. All items must be RoHS compliant.
2. Markings on label must be PERMANENT.
3. Indelible Ink.
4. Conductive inks may not be used.
5. Non-conductive label adhesive shall be used ONLY.



Label shown 300% of actual size

Label
P/N 1800xxxx

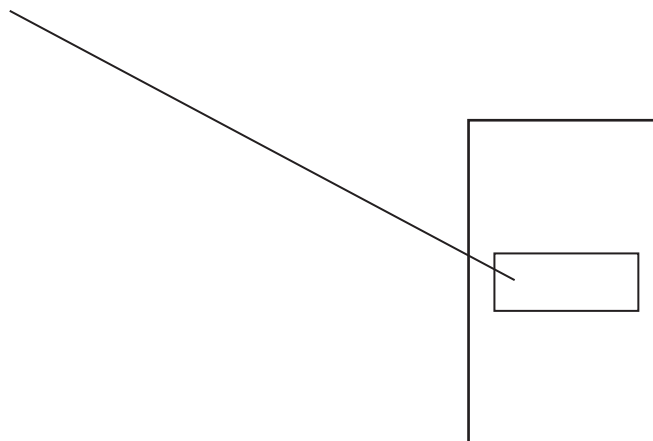

The label is located on the rear side of the enclosure