

TEST REPORT

ACCORDING TO: FCC parts 22, 24 and part 15 subpart B

FOR:

Motorola Israel Ltd.

QuadBand GSM/GPRS module

Model:G24-L

This report is in conformity with ISO/ IEC 17025. The "A2LA Accredited" symbol endorsement applies only to the tests and calibrations that are listed in the scope of Hermon Laboratories accreditation. The test results relate only to the items tested. This test report shall not be reproduced in any form except in full with the written approval of Hermon Laboratories Ltd.

Table of contents

1	Applicant information	3
2	Equipment under test attributes	3
3	Manufacturer information	3
4	Test details	3
5	Tests summary	4
6	EUT description	5
6.1	General information	5
6.2	Support and test equipment	5
6.3	Operating frequencies	5
6.4	Changes made in the EUT	5
6.5	Test configuration	6
6.6	Transmitter characteristics	7
7	Transmitter tests according to 47CFR part 22 requirements	8
7.1	Peak output power	8
7.2	Occupied bandwidth test	11
7.3	Spurious emissions at RF antenna connector test	16
7.4	Field strength of spurious emissions	33
7.5	Frequency stability test	60
8	Transmitter tests according to 47CFR part 24 requirements	63
8.1	Peak output power	63
8.2	Occupied bandwidth test	66
8.3	Spurious emissions at RF antenna connector test	71
8.4	Field strength of spurious emissions	91
8.5	Frequency stability test	119
9	Emissions tests according to FCC 47CFR part 15 subpart B requirements	124
9.1	Conducted emissions	124
9.2	Radiated emission measurements	128
9.3	Spurious emissions at RF antenna connector	135
10	APPENDIX A Test equipment and ancillaries used for tests	137
11	APPENDIX B Measurement uncertainties	138
12	APPENDIX C Test laboratory description	139
13	APPENDIX D Specification references	139
14	APPENDIX E Test equipment correction factors	140
15	APPENDIX F Abbreviations and acronyms	150

1 Applicant information

Client name: Motorola Israel Ltd.
Address: 3 Kremenetski street, P.O.B. 25016, 67899 Tel Aviv, Israel
Telephone: +972 3565 8888
Fax: +972 3565 9968
E-mail: buh002@motorola.com
Contact name: Mr. Udi Hadar

2 Equipment under test attributes

Product name: QuadBand GSM/GPRS module
Model(s): G24-L
Serial number: 356452010000571
Receipt date: 5/31/2007

3 Manufacturer information

Client name: Motorola Israel Ltd.
Address: 3 Kremenetski street, P.O.B. 25016, 67899 Tel Aviv, Israel
Telephone: +972 3565 8888
Fax: +972 3565 9968
E-mail: buh002@motorola.com
Contact name: Mr. Udi Hadar



4 Test details

Project ID: 17967
Location: Hermon Laboratories Ltd. P.O.Box 23, Binyamina 30500, Israel
Test started: 5/31/2007
Test completed: 7/11/2007
Test specification(s): FCC 47 CFR parts 22, 24:2006, part 15:2006 subpart B, §§15.107, 15.109

5 Tests summary

Test	Status
Transmitter characteristics	
Sections 22.913, 24.232, RF output power	Pass
Sections 24.238(b), 2.1049, Occupied bandwidth	Pass
Sections 22.917, 24.238, Spurious emissions at antenna terminal	Pass
Sections 22.917, 24.238, Emissions at band edges	Pass
Sections 22.917, 24.238, Radiated spurious emissions	Pass
Sections 22.355, 24.235, Frequency stability	Pass
Unintentional emissions	
Section 15.107, Conducted emission at AC power port	Pass
Section 15.109, Radiated emission	Pass
Section 15.111, Spurious emissions at RF antenna connector	Pass

Testing was completed against all relevant requirements of the test standard. Results obtained indicate that the product under test complies in full with the requirements tested.
The test results relate only to the items tested. Pass/ fail decision was based on nominal values.

	Name and Title	Date	Signature
Tested by:	Mr. A. Lane, test engineer	July 11, 2007	
Reviewed by:	Mrs. M. Cherniavsky, certification engineer	July 19, 2007	
Approved by:	Mr. M. Nikishin, EMC group leader	July 20, 2007	

6 EUT description

6.1 General information

The EUT is a QuadBand GSM/GPRS module, powered by DC power supply. Throughout the testing the EUT was installed into an evaluation board.

6.2 Support and test equipment

Description	Manufacturer	Model number	Serial number
Evaluation board	Motorola	FCN554OC	8488899V01-P3
RF splitter	Omni Spectra	2090-6204-00	2011
Laptop	IBM	23737FU	Z30C3
Base station (universal radio communication tester)	Rohde&Schwarz	CMU2000	104515
AC/DC adapter	Motorola	FMP5202A	0534610-0838738-B-R

6.3 Operating frequencies

Source	Frequency, MHz		
Cell 850	824.2	836.4	848.8
PCS 1900	1850.2	1880	1909.8

6.4 Changes made in the EUT

No changes were implemented.

6.5 Test configuration

6.5.1 EUT configuration for transmitter testing

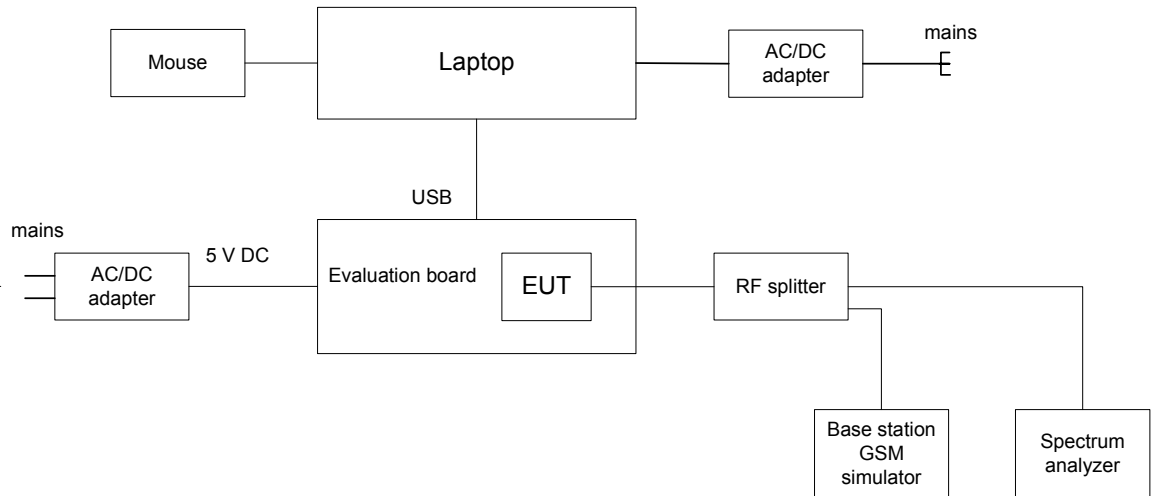

6.5.2 EUT configuration for unintentional emissions testing

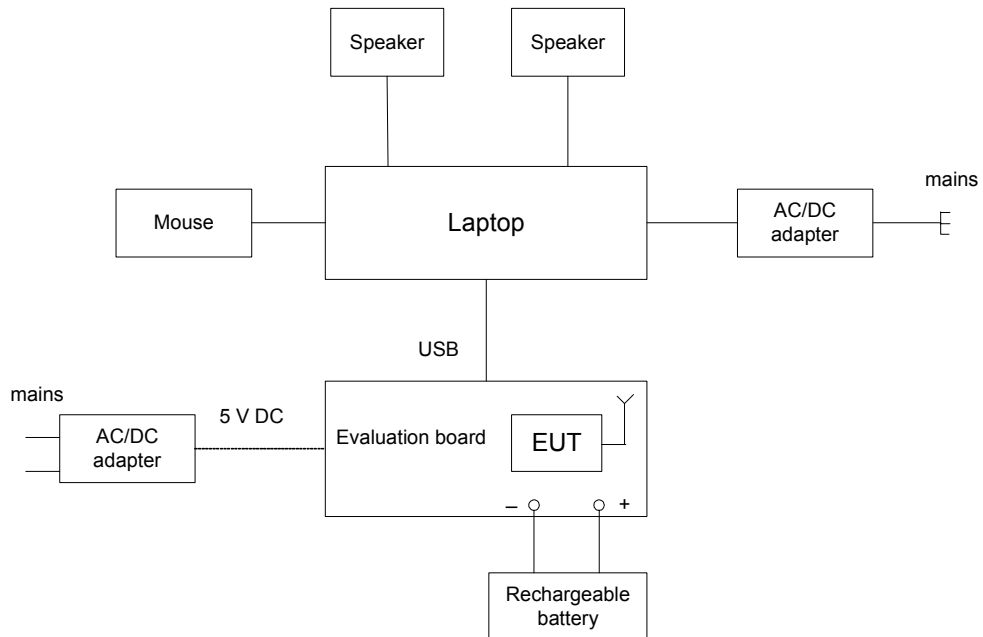

6.6 Transmitter characteristics

Type of equipment						
X	Stand-alone (Equipment with or without its own control provisions)					
	Combined equipment (Equipment where the radio part is fully integrated within another type of equipment)					
	Plug-in card (Equipment intended for a variety of host systems)					
Intended use		Condition of use				
	fixed	Always at a distance more than 2 m from all people				
	mobile	Always at a distance more than 20 cm from all people				
X	portable	May operate at a distance closer than 20 cm to human body				
Assigned frequency range		824 – 849 MHz/1850 – 1910 MHz				
Operating frequency range		824.2 – 848.8 MHz/1850.2 – 1909.8 MHz				
RF channel spacing		200 kHz				
Maximum rated output power		At transmitter 50 Ω RF output connector		800 – 33.5 dBm 1900 –30.5 dBm		
		Effective radiated power (for equipment with no RF connector)				
Is transmitter output power variable?		No				
		continuous variable				
		X	Yes	stepped variable with stepsize	0.5 dB	
				minimum RF power	0 dBm	
		maximum RF power		800 – 33.5 dBm 1900 –30.5 dBm		
Antenna connection						
unique coupling	X	standard connector	integral	with temporary RF connector without temporary RF connector		
Transmitter 99% power bandwidth		200 kHz				
Transmitter aggregate data rate/s		270 kbps				
Transmitter aggregate symbol (baud) rate/s		NA				
Type of modulation		GMSK				
Maximum transmitter duty cycle in normal use		12.5 %	Tx ON time	0.577 msec	Period	4.6 msec
Transmitter duty cycle supplied for test		12.5 %	Tx ON time	0.577 msec	Period	4.6 msec
Transmitter power source						
X	AC	Nominal rated voltage	120 V	Frequency	60 Hz	
Common power source for transmitter and receiver			X	yes	no	

Test specification:		Section 22.913, Peak output power	
Test procedure:		FCC part 22, Section 22.913	
Test mode:	Compliance	Verdict:	PASS
Date:	6/25/2007		
Temperature: 27°C	Air Pressure: 1010 hPa	Relative Humidity: 40 %	Power Supply: 5 VDC
Remarks:			

7 Transmitter tests according to 47CFR part 22 requirements

7.1 Peak output power

7.1.1 General

This test was performed to measure the peak output power at RF antenna connector. Specification test limits are given in Table 7.1.1.

Table 7.1.1 Peak output power limits

Assigned frequency range, MHz	Maximum peak output power	
	W	dBm
824 – 849	7.0	38.45

7.1.2 Test procedure

7.1.2.1 The EUT was set up as shown in Figure 7.1.1, energized and its proper operation was checked.

7.1.2.2 The EUT was adjusted to produce maximum available to the end user RF output power.

7.1.2.3 The peak output power was measured with spectrum analyzer as provided in Table 7.1.2 and associated plots.

Figure 7.1.1 Peak output power test setup



Photograph 7.1.2 Peak output power test setup



Test specification:	Section 22.913, Peak output power		
Test procedure:	FCC part 22, Section 22.913		
Test mode:	Compliance	Verdict:	PASS
Date:	6/25/2007		
Temperature: 27°C	Air Pressure: 1010 hPa	Relative Humidity: 40 %	Power Supply: 5 VDC
Remarks:			

Table 7.1.2 Peak output power test results

OPERATING FREQUENCY RANGE: 824-849 MHz
 DETECTOR USED: Peak
 RESOLUTION BANDWIDTH: 1 MHz
 VIDEO BANDWIDTH: 3 MHz
 MODULATION: GMSK
 MODULATING SIGNAL: PRBS
 BIT RATE: 270 kbps
 TRANSMITTER OUTPUT POWER SETTINGS: Maximum

Carrier frequency, MHz	Spectrum analyzer reading, dBm	External attenuation, dB	Cable loss, dB	RF output power, dBm	Limit, dBm	Margin, dB	Verdict
824.2	33.58	Included	Included	33.58	38.5	-4.92	Pass
836.6	33.47	Included	Included	33.47	38.5	-5.03	Pass
848.8	33.11	Included	Included	33.11	38.5	-5.39	Pass

Reference numbers of test equipment used

HL 2910	HL 2912	HL 3001	HL 3178	HL 3182			
---------	---------	---------	---------	---------	--	--	--

Full description is given in Appendix A.

Plot 7.1.1 Peak output power test results at low frequency

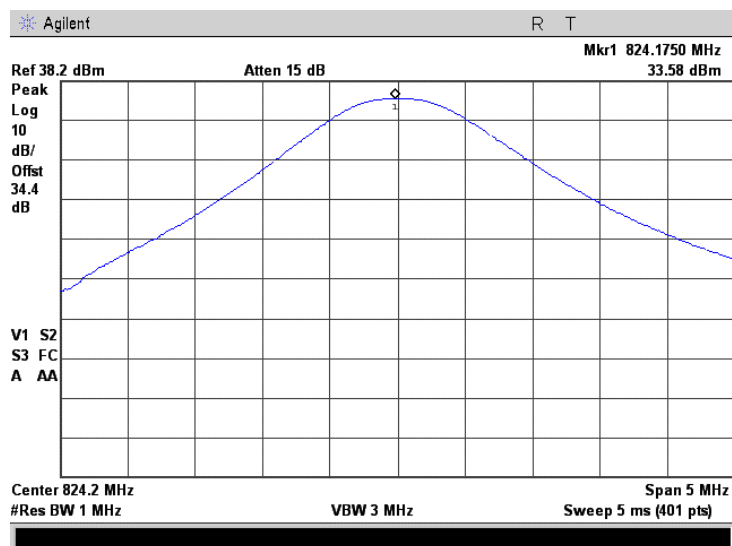

Test specification:	Section 22.913, Peak output power		
Test procedure:	FCC part 22, Section 22.913		
Test mode:	Compliance	Verdict:	PASS
Date:	6/25/2007		
Temperature: 27°C	Air Pressure: 1010 hPa	Relative Humidity: 40 %	Power Supply: 5 VDC
Remarks:			

Plot 7.1.2 Peak output power test results at mid frequency

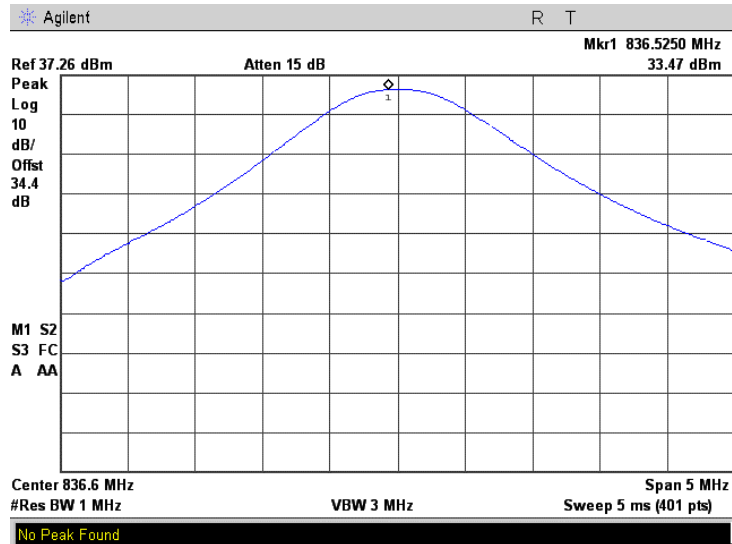

Plot 7.1.3 Peak output power test results at high frequency

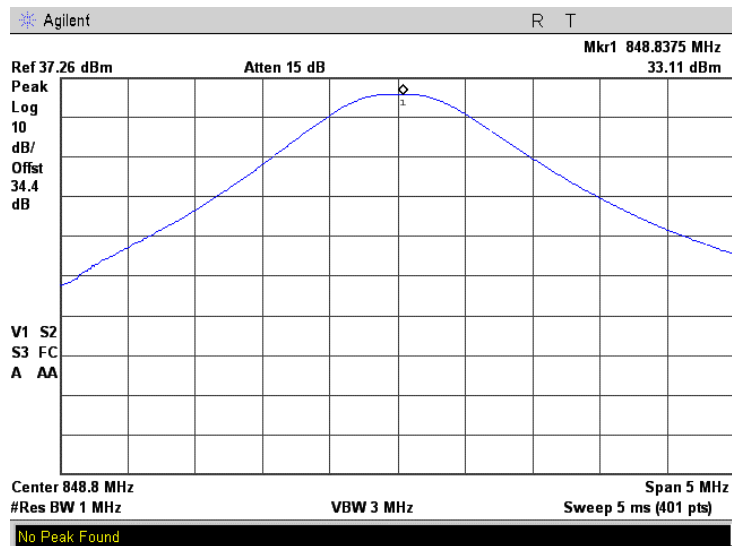

Test specification: Section 2.1049, Occupied bandwidth			
Test procedure: FCC part 2, Section 2.1049			
Test mode: Compliance	Verdict: PASS		
Date: 6/25/2007			
Temperature: 27°C	Air Pressure: 1010 hPa	Relative Humidity: 40 %	Power Supply: 5 VDC
Remarks:			

7.2 Occupied bandwidth test

7.2.1 General

This test was performed to measure transmitter occupied bandwidth. Specification test limits are given in Table 7.2.1.

Table 7.2.1 Occupied bandwidth limits

Assigned frequency, MHz	Modulation envelope reference points*, dBc
824 - 849	26

* - Modulation envelope reference points are provided in terms of attenuation below the unmodulated carrier.

7.2.2 Test procedure

7.2.2.1 The EUT was set up as shown in Figure 7.2.1, energized and its proper operation was checked.

7.2.2.2 The EUT was set to transmit the unmodulated carrier and the reference peak power level was measured.

7.2.2.3 The EUT was set to transmit the normally modulated carrier.

7.2.2.4 The transmitter occupied bandwidth was measured with spectrum analyzer as a frequency delta between the reference points on modulation envelope and the results provided in Table 7.2.2 and the associated plots.

Figure 7.2.1 Occupied bandwidth test setup

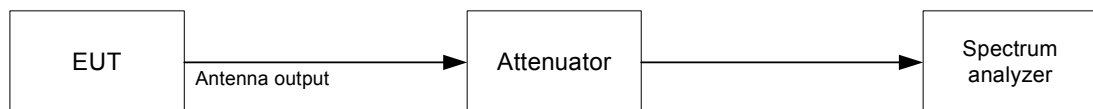

Photograph 7.2.2 Occupied bandwidth test setup



Test specification: Section 2.1049, Occupied bandwidth	
Test procedure:	FCC part 2, Section 2.1049
Test mode:	Compliance
Date:	6/25/2007
Temperature: 27°C	Air Pressure: 1010 hPa
Remarks:	
Verdict: PASS	
Relative Humidity: 40 %	
Power Supply: 5 VDC	

Table 7.2.2 Occupied bandwidth test results

DETECTOR USED: Peak hold
 RESOLUTION BANDWIDTH: 3 kHz
 VIDEO BANDWIDTH: 10 kHz
 MODULATION ENVELOPE REFERENCE POINTS: 26 dBc
 MODULATION: GMSK
 MODULATING SIGNAL: PRBS
 BIT RATE: 270 kbps

Carrier frequency, MHz	Occupied bandwidth, kHz
824.2	267.5
836.6	287.5
848.8	267.5

Reference numbers of test equipment used

HL 2910	HL 2912	HL 3001	HL 3178	HL 3182		
---------	---------	---------	---------	---------	--	--

Full description is given in Appendix A.

Test specification:	Section 2.1049, Occupied bandwidth		
Test procedure:	FCC part 2, Section 2.1049		
Test mode:	Compliance	Verdict:	PASS
Date:	6/25/2007		
Temperature: 27°C	Air Pressure: 1010 hPa	Relative Humidity: 40 %	Power Supply: 5 VDC
Remarks:			

Plot 7.2.1 Occupied bandwidth test result at low frequency, reference level

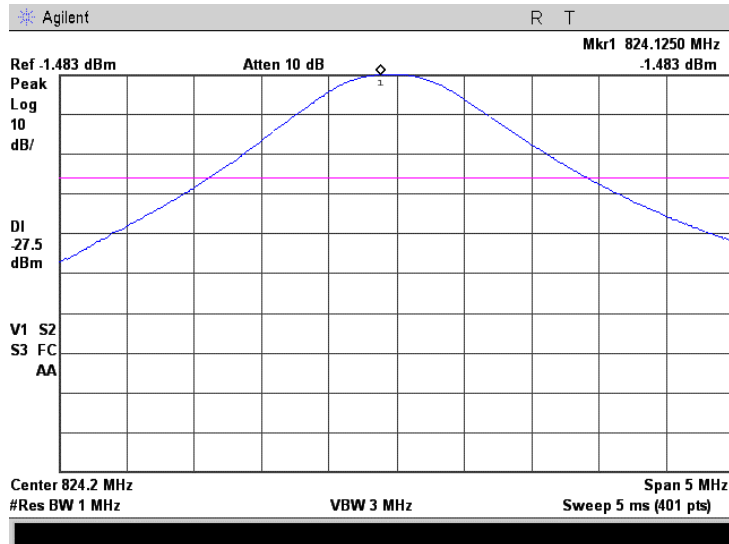

Plot 7.2.2 Occupied bandwidth test result at low frequency



Test specification:	Section 2.1049, Occupied bandwidth		
Test procedure:	FCC part 2, Section 2.1049		
Test mode:	Compliance	Verdict:	PASS
Date:	6/25/2007		
Temperature: 27°C	Air Pressure: 1010 hPa	Relative Humidity: 40 %	Power Supply: 5 VDC
Remarks:			

Plot 7.2.3 Occupied bandwidth test result at mid frequency, reference level

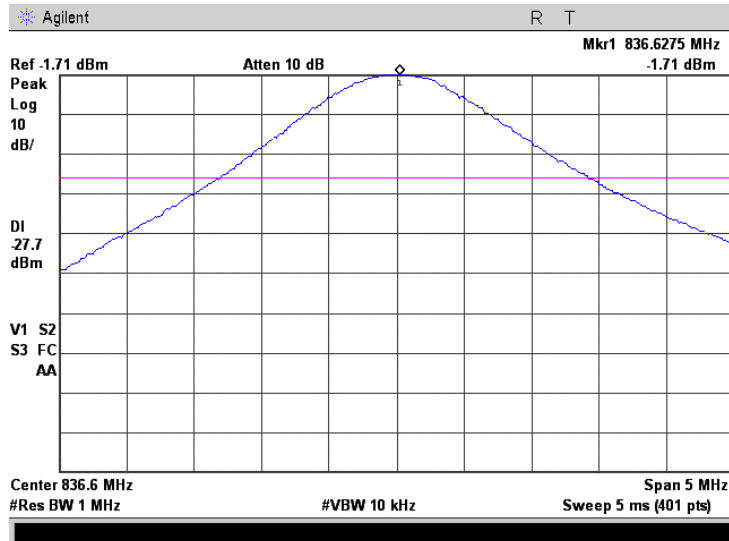

Plot 7.2.4 Occupied bandwidth test result at mid frequency

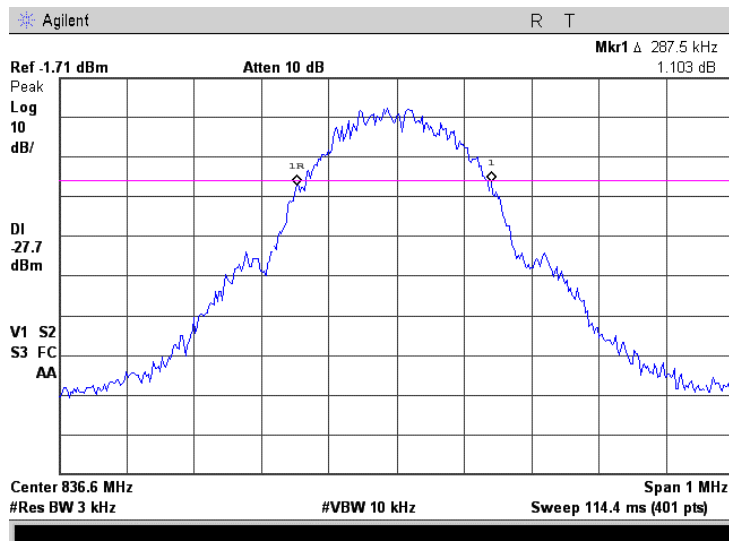

Test specification:	Section 2.1049, Occupied bandwidth		
Test procedure:	FCC part 2, Section 2.1049		
Test mode:	Compliance	Verdict:	PASS
Date:	6/25/2007		
Temperature: 27°C	Air Pressure: 1010 hPa	Relative Humidity: 40 %	Power Supply: 5 VDC
Remarks:			

Plot 7.2.5 Occupied bandwidth test result at high frequency, reference level

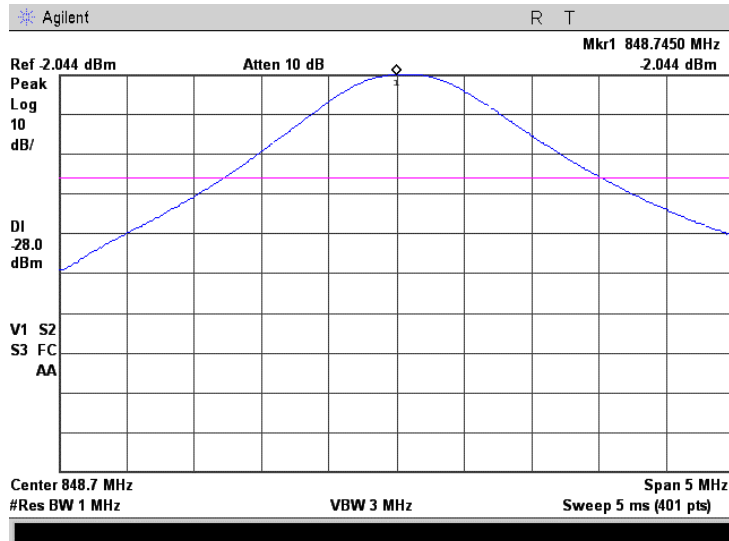

Plot 7.2.6 Occupied bandwidth test result at high frequency

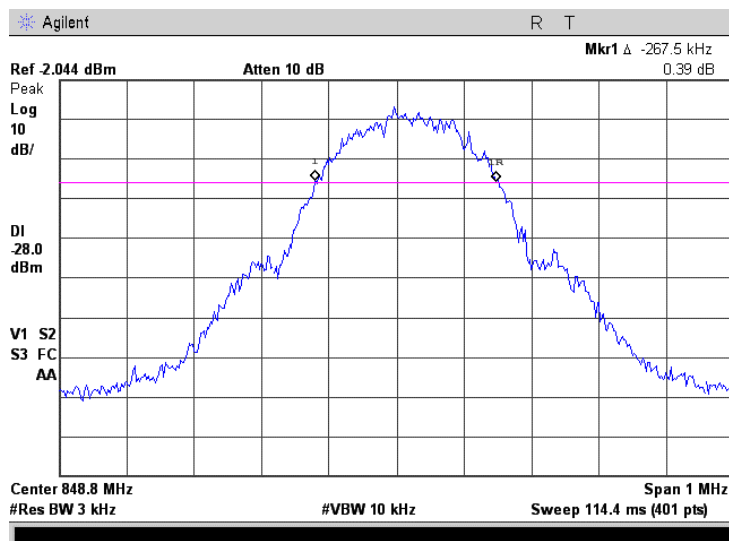

Test specification:	Section 22.917, Spurious emission at antenna terminal		
Test procedure:	FCC part 22, Section 22.917		
Test mode:	Compliance	Verdict:	PASS
Date:	6/25/2007		
Temperature: 27°C	Air Pressure: 1010 hPa	Relative Humidity: 40 %	Power Supply: 5 VDC
Remarks:			

7.3 Spurious emissions at RF antenna connector test

7.3.1 General

This test was performed to measure spurious emissions at RF antenna connector. Specification test limits are given in Table 7.3.1.

Table 7.3.1 Spurious emission limits

Frequency, MHz	Attenuation below carrier, dBc	ERP of spurious, dBm
0.009 – 10 th harmonic*	43+10logP*	-13.0

- spurious emission limits do not apply to the in band emission within ± 250 % of the authorized bandwidth from the carrier; investigated in course of emission mask testing

7.3.2 Test procedure

7.3.2.1 The EUT was set up as shown in Figure 7.3.1, energized and its proper operation was checked.

7.3.2.2 The EUT was adjusted to produce maximum available for end user RF output power.

7.3.2.3 The spurious emission was measured with spectrum analyzer as provided in Table 7.3.2 and associated plots.

Figure 7.3.1 Spurious emission test setup



Photograph 7.3.2 Spurious emission test setup



Test specification:		Section 22.917, Spurious emission at antenna terminal			
Test procedure:		FCC part 22, Section 22.917			
Test mode:	Compliance	Verdict:		PASS	
Date:	6/25/2007				
Temperature: 27°C	Air Pressure: 1010 hPa	Relative Humidity: 40 %	Power Supply: 5 VDC		
Remarks:					

Table 7.3.2 Spurious emission test results

ASSIGNED FREQUENCY RANGE: 824-849 MHz
 INVESTIGATED FREQUENCY RANGE: 0.009-10000 MHz
 DETECTOR USED: Peak
 VIDEO BANDWIDTH: ≥ Resolution bandwidth
 MODULATION: GMSK
 MODULATING SIGNAL: PRBS
 BIT RATE: 270 kbps
 TRANSMITTER OUTPUT POWER SETTINGS: Maximum
 TRANSMITTER OUTPUT POWER: 33.58 dBm at low frequency
 33.47 dBm at mid frequency
 33.11 dBm at high frequency

Frequency, MHz	SA reading, dBm	Attenuator, dB	Cable loss, dB	RBW, kHz	Spurious emission, dBm	Attenuation below carrier, dBc	Limit, dBc	Margin, dB*	Verdict
Low carrier frequency									
823.97	-13.79	Included	Included	3.0	-13.79	47.37	46.58	0.79	Pass
1648.50	-30.18	Included	Included	1000.0	-30.18	63.76	46.58	17.18	Pass
2472.60	-31.28	Included	Included	1000.0	-31.28	64.86	46.58	18.28	Pass
Mid carrier frequency									
1673.16	-31.46	Included	Included	1000.0	-31.46	-64.93	46.47	18.46	Pass
2510.00	-31.82	Included	Included	1000.0	-31.82	-65.29	46.47	18.82	Pass
High carrier frequency									
849.02	-14.05	Included	Included	3.0	-14.05	-47.16	46.11	1.05	Pass
1697.58	-31.11	Included	Included	1000.0	-31.11	-64.22	46.11	18.11	Pass
2546.20	-34.21	Included	Included	1000.0	-34.21	-67.32	46.11	21.21	Pass

*- Margin = Spurious emission – specification limit.

Reference numbers of test equipment used

HL 2011	HL 2909	HL 2910	HL 2912	HL 3178	HL 3182	
---------	---------	---------	---------	---------	---------	--

Full description is given in Appendix A.

Test specification:		Section 22.917, Spurious emission at antenna terminal	
Test procedure:		FCC part 22, Section 22.917	
Test mode:	Compliance	Verdict:	PASS
Date:	6/25/2007		
Temperature: 27°C	Air Pressure: 1010 hPa	Relative Humidity: 40 %	Power Supply: 5 VDC
Remarks:			

Plot 7.3.1 Spurious emission measurements in 9 - 150 kHz range at low carrier frequency

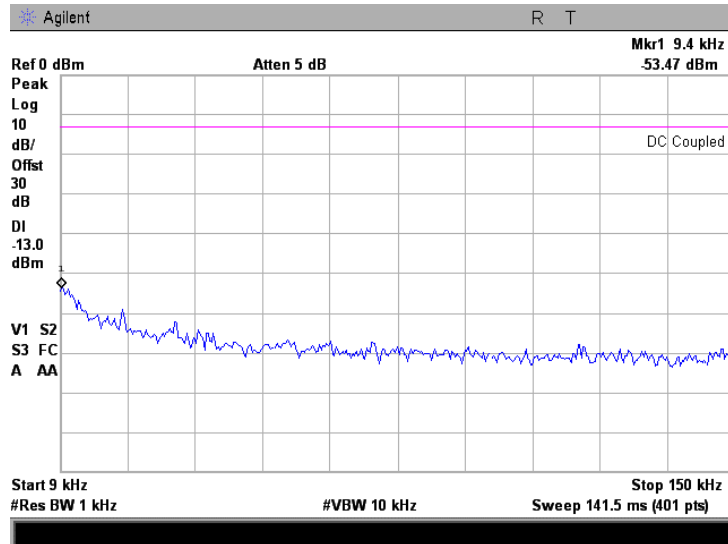

Plot 7.3.2 Spurious emission measurements in 9 - 150 kHz range at mid carrier frequency

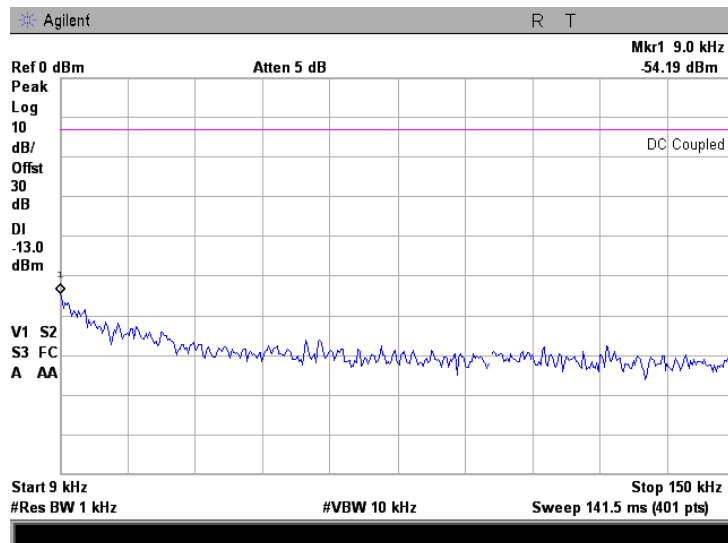

Test specification:	Section 22.917, Spurious emission at antenna terminal		
Test procedure:	FCC part 22, Section 22.917		
Test mode:	Compliance	Verdict:	PASS
Date:	6/25/2007		
Temperature: 27°C	Air Pressure: 1010 hPa	Relative Humidity: 40 %	Power Supply: 5 VDC
Remarks:			

Plot 7.3.3 Spurious emission measurements in 9 - 150 kHz range at high carrier frequency

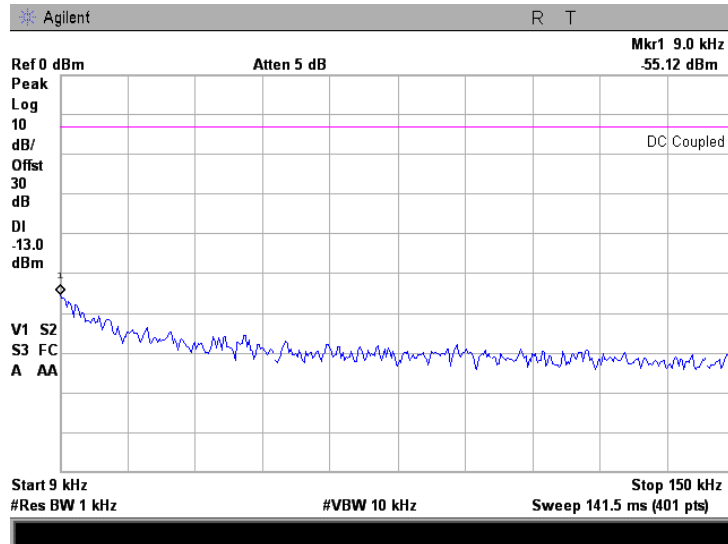

Plot 7.3.4 Spurious emission measurements in 0.15 - 30.0 MHz range at low carrier frequency

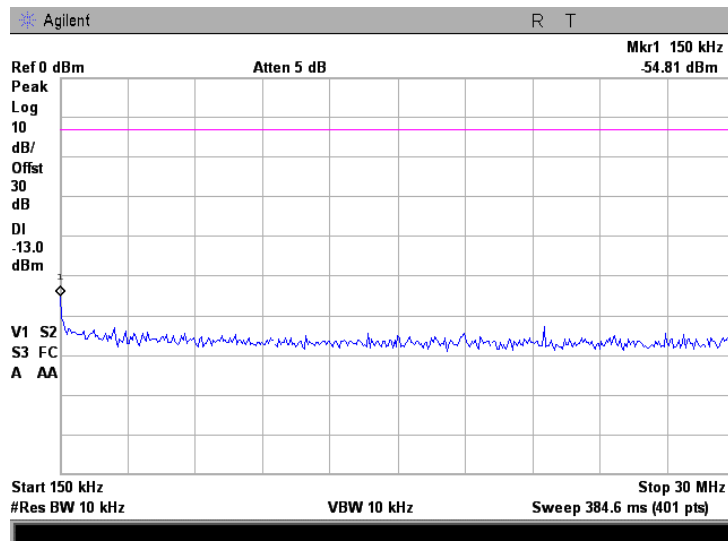

Test specification:	Section 22.917, Spurious emission at antenna terminal		
Test procedure:	FCC part 22, Section 22.917		
Test mode:	Compliance	Verdict:	PASS
Date:	6/25/2007		
Temperature: 27°C	Air Pressure: 1010 hPa	Relative Humidity: 40 %	Power Supply: 5 VDC
Remarks:			

Plot 7.3.5 Spurious emission measurements in 0.15 - 30.0 MHz range at mid carrier frequency

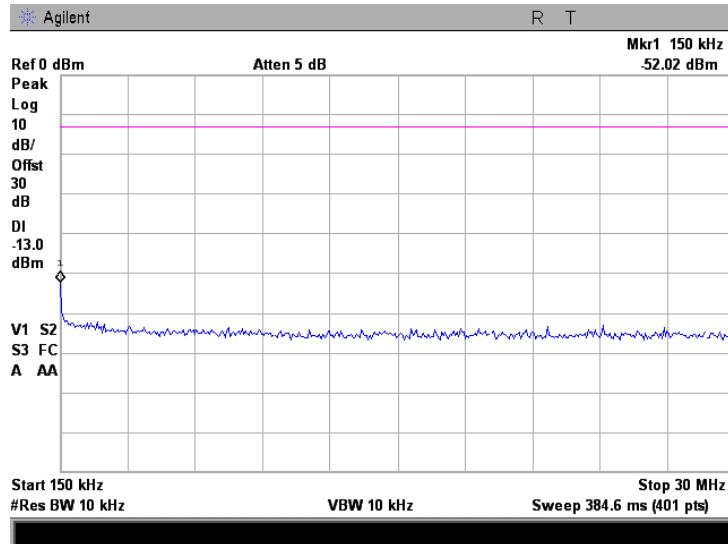

Plot 7.3.6 Spurious emission measurements in 0.15 - 30.0 MHz range at high carrier frequency

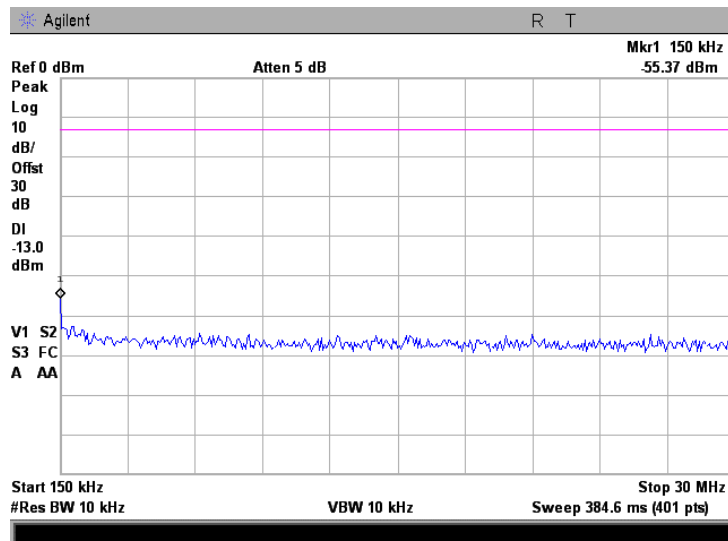

Test specification: Section 22.917, Spurious emission at antenna terminal			
Test procedure: FCC part 22, Section 22.917			
Test mode: Compliance	Verdict: PASS		
Date: 6/25/2007			
Temperature: 27°C	Air Pressure: 1010 hPa	Relative Humidity: 40 %	Power Supply: 5 VDC
Remarks:			

Plot 7.3.7 Spurious emission measurements in 30.0 - 500 MHz range at low carrier frequency

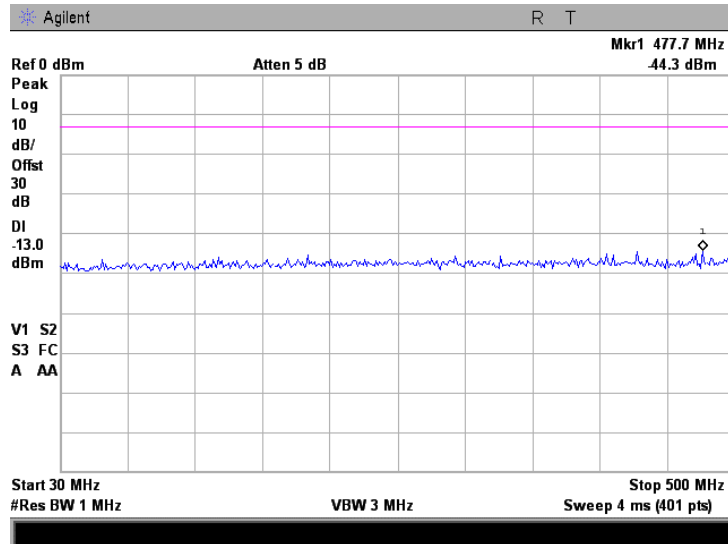

Plot 7.3.8 Spurious emission measurements in 30.0 - 500 MHz range at mid carrier frequency

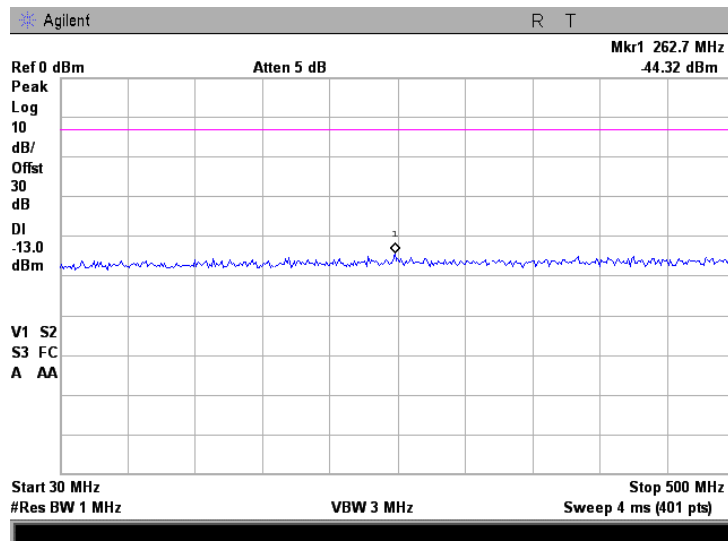

Test specification:	Section 22.917, Spurious emission at antenna terminal		
Test procedure:	FCC part 22, Section 22.917		
Test mode:	Compliance	Verdict:	PASS
Date:	6/25/2007		
Temperature: 27°C	Air Pressure: 1010 hPa	Relative Humidity: 40 %	Power Supply: 5 VDC
Remarks:			

Plot 7.3.9 Spurious emission measurements in 30.0 - 500 MHz range at high carrier frequency

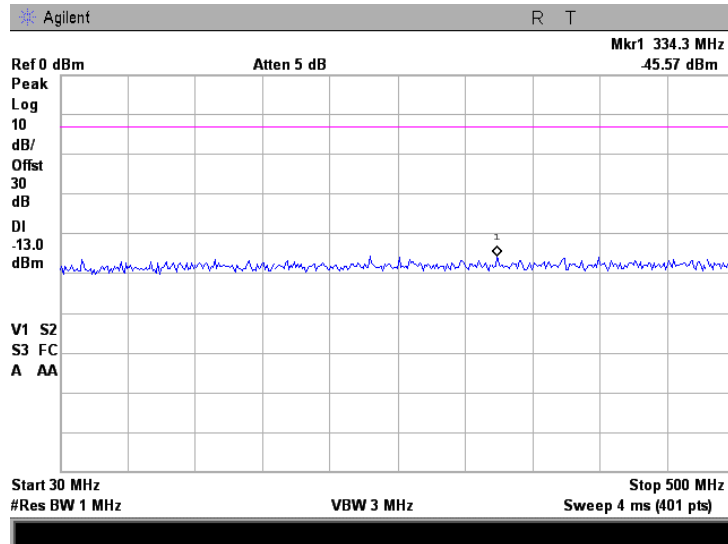

Plot 7.3.10 Spurious emission measurements in 500.0 – 823.0 MHz range at low carrier frequency

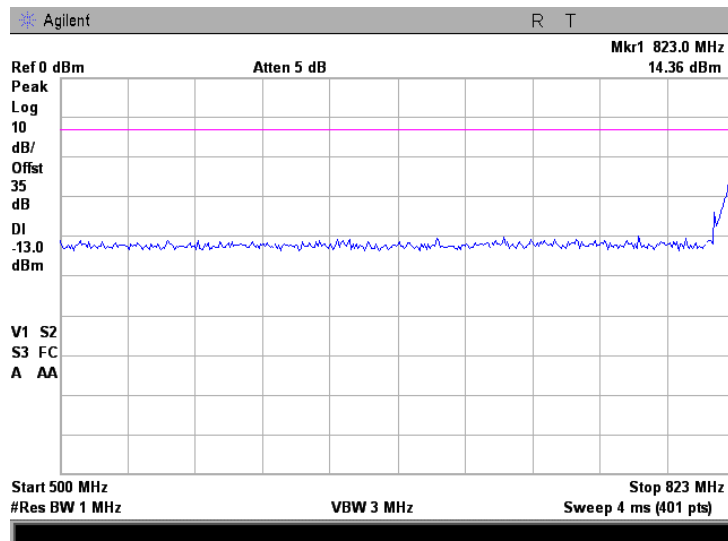

Test specification:		Section 22.917, Spurious emission at antenna terminal	
Test procedure:		FCC part 22, Section 22.917	
Test mode:	Compliance	Verdict:	PASS
Date:	6/25/2007		
Temperature: 27°C	Air Pressure: 1010 hPa	Relative Humidity: 40 %	Power Supply: 5 VDC
Remarks:			

Plot 7.3.11 Spurious emission measurements in 823.0 – 824.0 MHz range at low carrier frequency

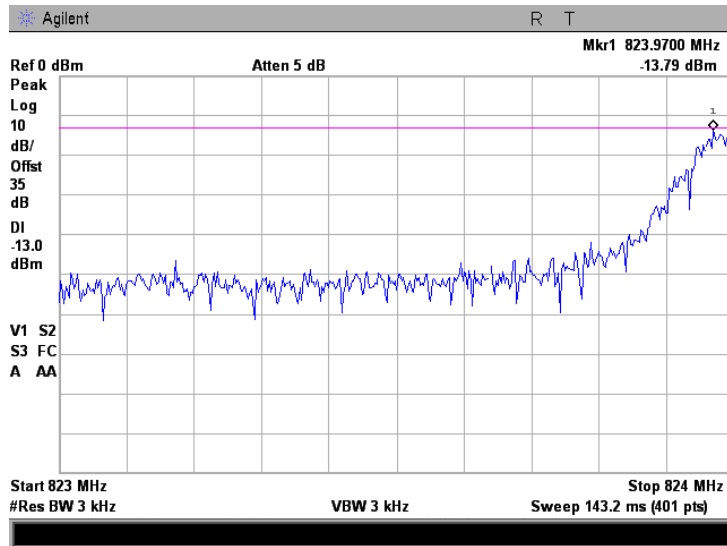

Plot 7.3.12 Spurious emission measurements in 500.0 - 824 MHz range at mid carrier frequency

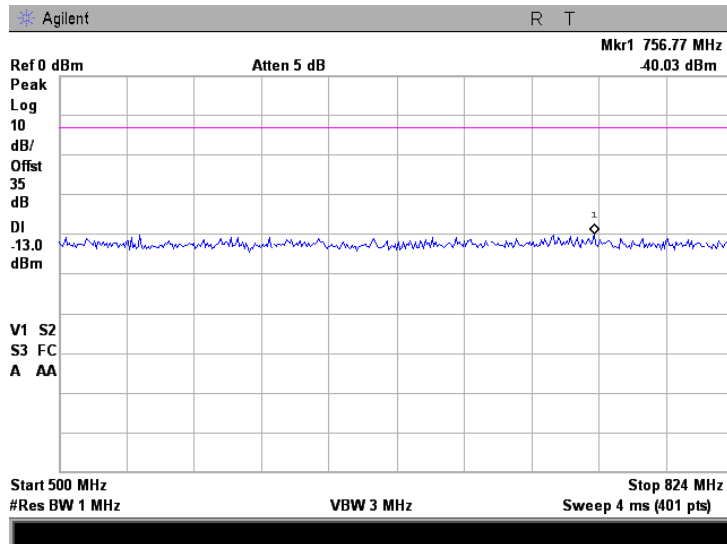

Test specification:	Section 22.917, Spurious emission at antenna terminal		
Test procedure:	FCC part 22, Section 22.917		
Test mode:	Compliance	Verdict:	PASS
Date:	6/25/2007		
Temperature: 27°C	Air Pressure: 1010 hPa	Relative Humidity: 40 %	Power Supply: 5 VDC
Remarks:			

Plot 7.3.13 Spurious emission measurements in 500.0 - 824 MHz range at high carrier frequency

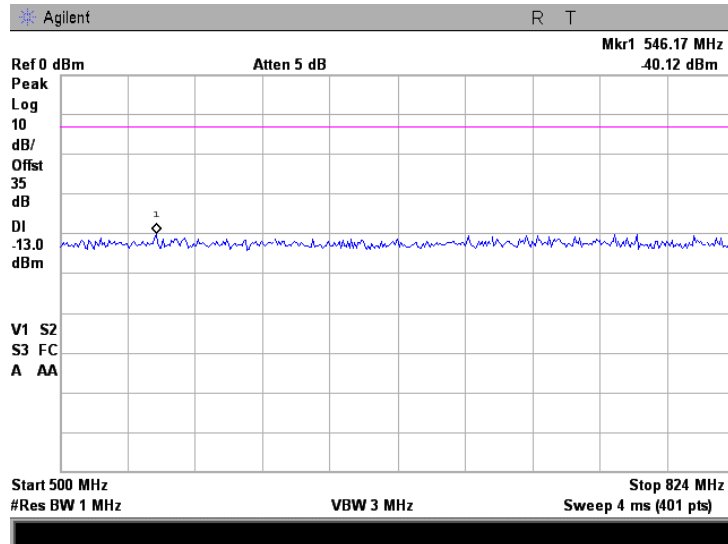

Plot 7.3.14 Spurious emission measurements in 849 -10000 MHz range at low carrier frequency

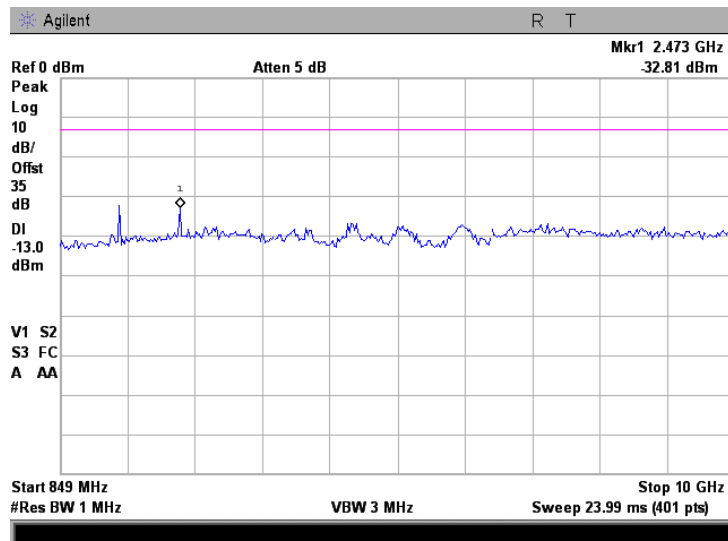

Test specification:		Section 22.917, Spurious emission at antenna terminal	
Test procedure:		FCC part 22, Section 22.917	
Test mode:	Compliance	Verdict:	PASS
Date:	6/25/2007		
Temperature: 27°C	Air Pressure: 1010 hPa	Relative Humidity: 40 %	Power Supply: 5 VDC
Remarks:			

Plot 7.3.15 Spurious emission measurements in 849 – 10000 MHz range at mid carrier frequency

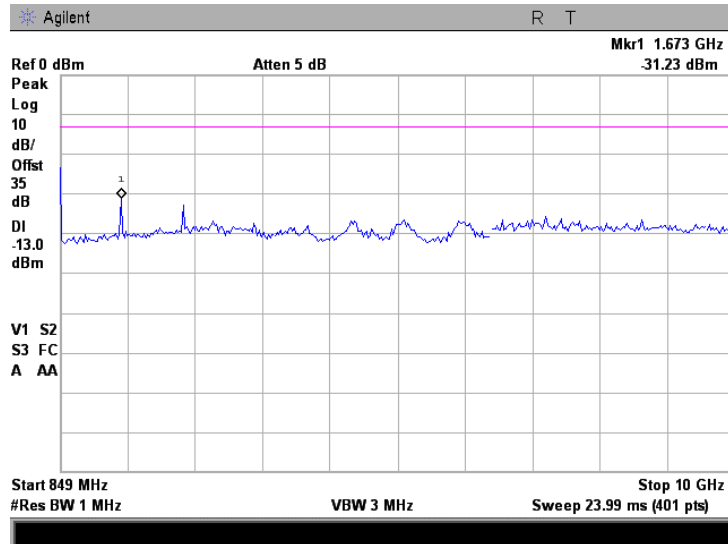

Plot 7.3.16 Spurious emission measurements in 849 – 850 MHz range at high carrier frequency

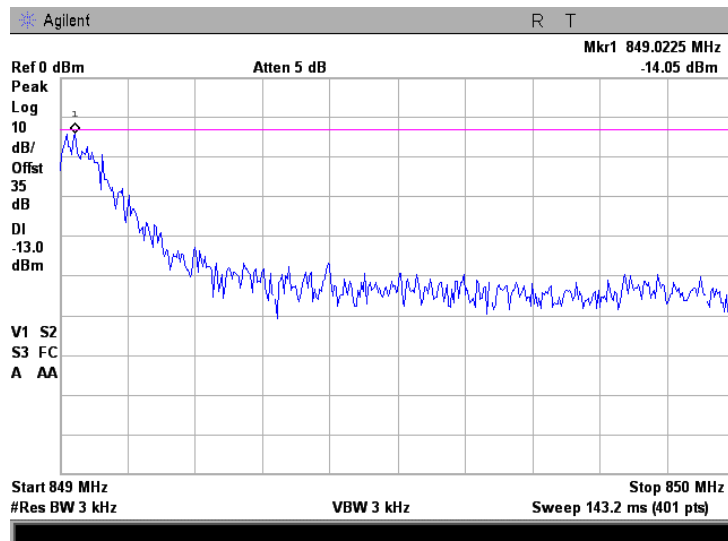

Test specification:	Section 22.917, Spurious emission at antenna terminal		
Test procedure:	FCC part 22, Section 22.917		
Test mode:	Compliance	Verdict:	PASS
Date:	6/25/2007		
Temperature: 27°C	Air Pressure: 1010 hPa	Relative Humidity: 40 %	Power Supply: 5 VDC
Remarks:			

Plot 7.3.17 Spurious emission measurements in 850 - 10000MHz range at high carrier frequency

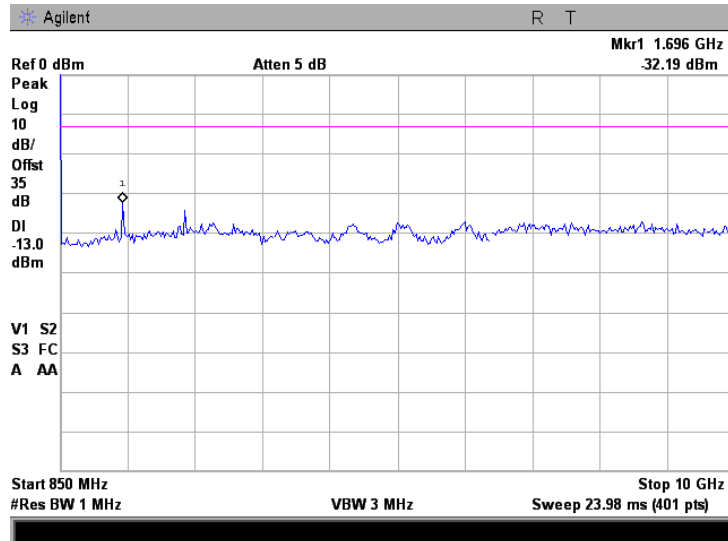

Test specification:	Section 22.917, Spurious emission at antenna terminal		
Test procedure:	FCC part 22, Section 22.917		
Test mode:	Compliance	Verdict:	PASS
Date:	6/25/2007		
Temperature: 27°C	Air Pressure: 1010 hPa	Relative Humidity: 40 %	Power Supply: 5 VDC
Remarks:			

Plot 7.3.18 Conducted spurious emission measurements at the 2nd harmonic of low carrier frequency

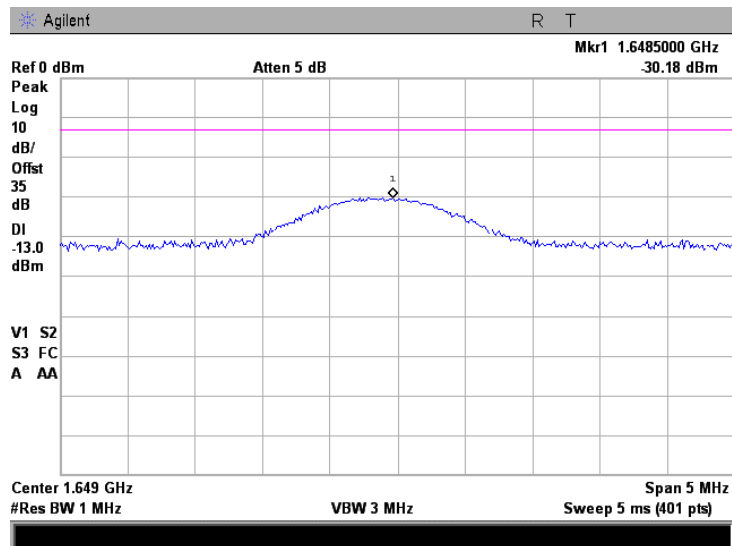

Plot 7.3.19 Conducted spurious emission measurements at the 2nd harmonic of mid carrier frequency

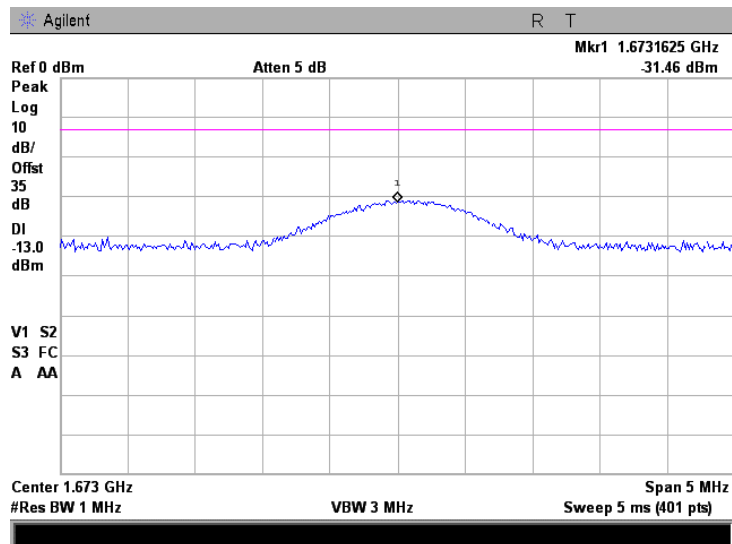

Test specification:	Section 22.917, Spurious emission at antenna terminal		
Test procedure:	FCC part 22, Section 22.917		
Test mode:	Compliance	Verdict:	PASS
Date:	6/25/2007		
Temperature: 27°C	Air Pressure: 1010 hPa	Relative Humidity: 40 %	Power Supply: 5 VDC
Remarks:			

Plot 7.3.20 Conducted spurious emission measurements at the 2nd harmonic of high carrier frequency

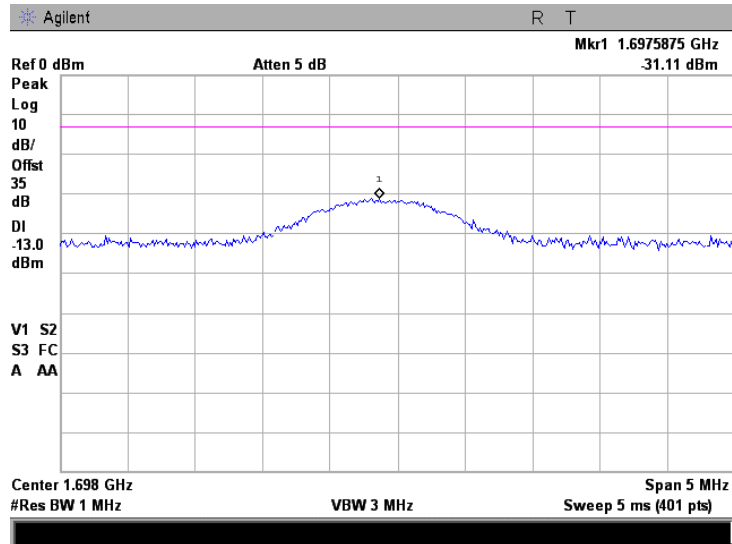

Plot 7.3.21 Conducted spurious emission measurements at the 3rd harmonic of low carrier frequency

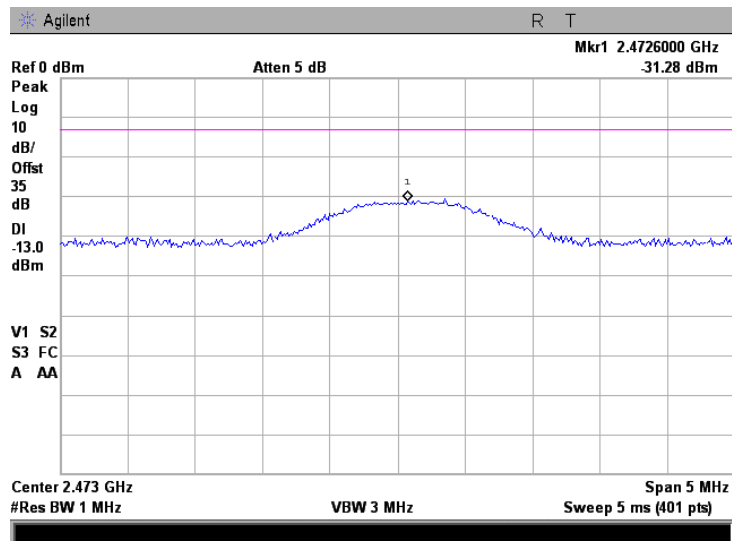

Test specification:		Section 22.917, Spurious emission at antenna terminal	
Test procedure:		FCC part 22, Section 22.917	
Test mode:	Compliance	Verdict:	PASS
Date:	6/25/2007		
Temperature: 27°C	Air Pressure: 1010 hPa	Relative Humidity: 40 %	Power Supply: 5 VDC
Remarks:			

Plot 7.3.22 Conducted spurious emission measurements at the 3rd harmonic of mid carrier frequency

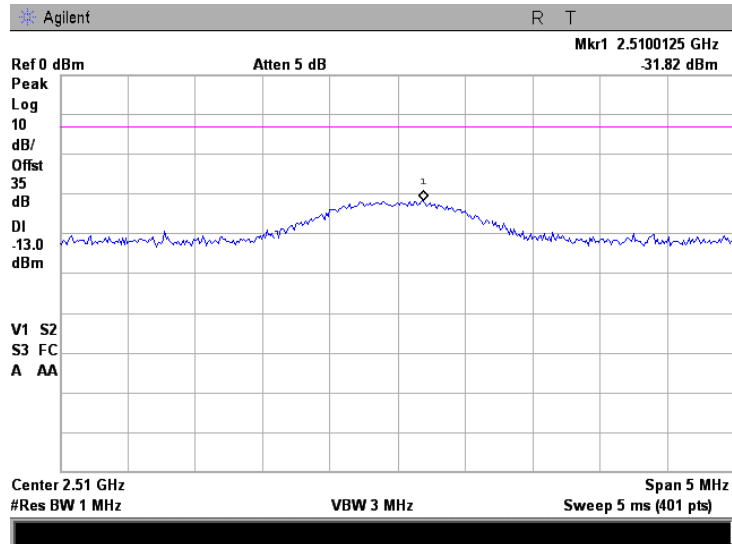

Plot 7.3.23 Conducted spurious emission measurements at the 3rd harmonic of high carrier frequency

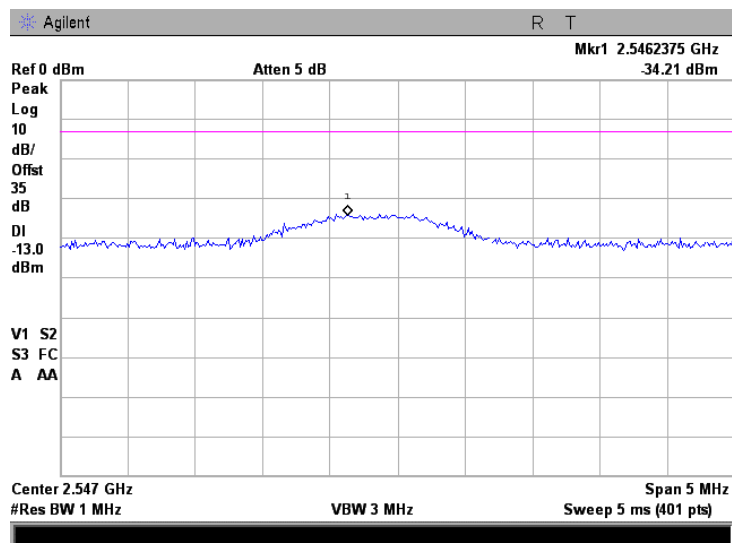

Test specification:	Section 22.917, Spurious emission at antenna terminal		
Test procedure:	FCC part 22, Section 22.917		
Test mode:	Compliance	Verdict:	PASS
Date:	6/25/2007		
Temperature: 27°C	Air Pressure: 1010 hPa	Relative Humidity: 40 %	Power Supply: 5 VDC
Remarks:			

Plot 7.3.24 Conducted spurious emission measurements at the 4th harmonic of low carrier frequency

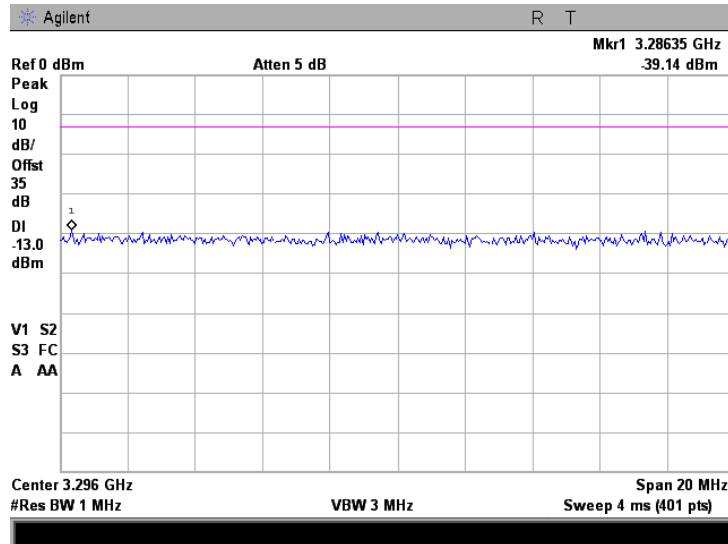

Plot 7.3.25 Conducted spurious emission measurements at the 4th harmonic of mid carrier frequency

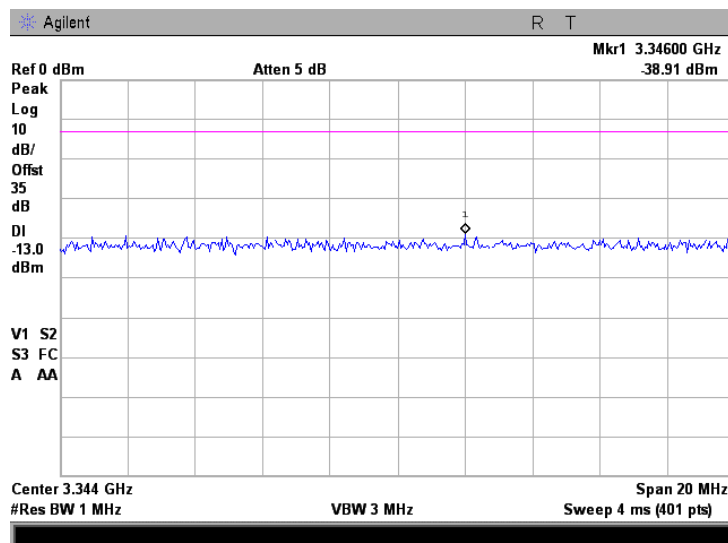

Test specification:	Section 22.917, Spurious emission at antenna terminal		
Test procedure:	FCC part 22, Section 22.917		
Test mode:	Compliance	Verdict:	PASS
Date:	6/25/2007		
Temperature: 27°C	Air Pressure: 1010 hPa	Relative Humidity: 40 %	Power Supply: 5 VDC
Remarks:			

Plot 7.3.26 Conducted spurious emission measurements at the 4th harmonic of high carrier frequency

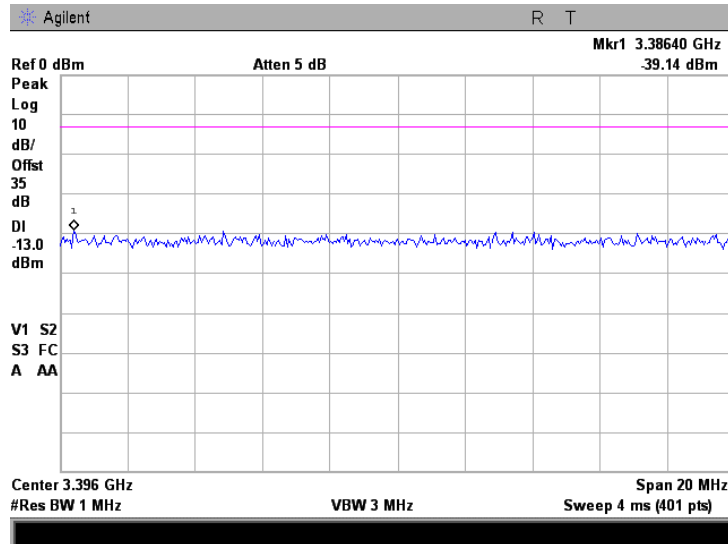

Plot 7.3.27 Conducted spurious emission measurements at the 5th harmonic of low carrier frequency

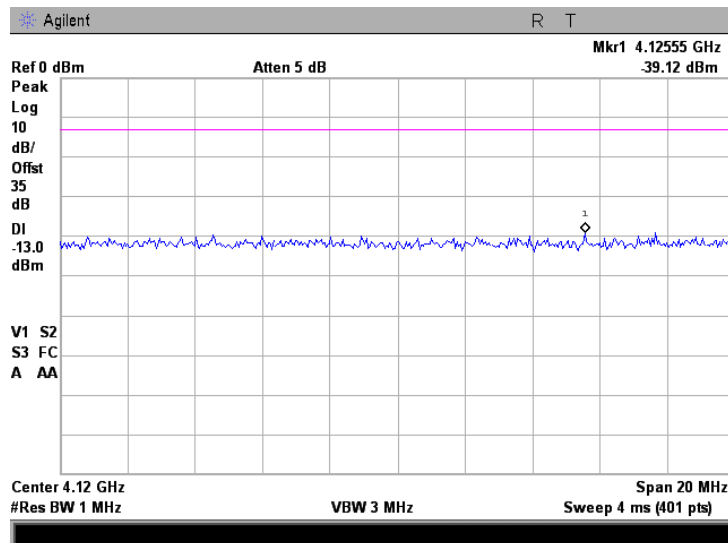

Test specification:	Section 22.917, Spurious emission at antenna terminal		
Test procedure:	FCC part 22, Section 22.917		
Test mode:	Compliance	Verdict:	PASS
Date:	6/25/2007		
Temperature: 27°C	Air Pressure: 1010 hPa	Relative Humidity: 40 %	Power Supply: 5 VDC
Remarks:			

Plot 7.3.28 Conducted spurious emission measurements at the 5th harmonic of mid carrier frequency

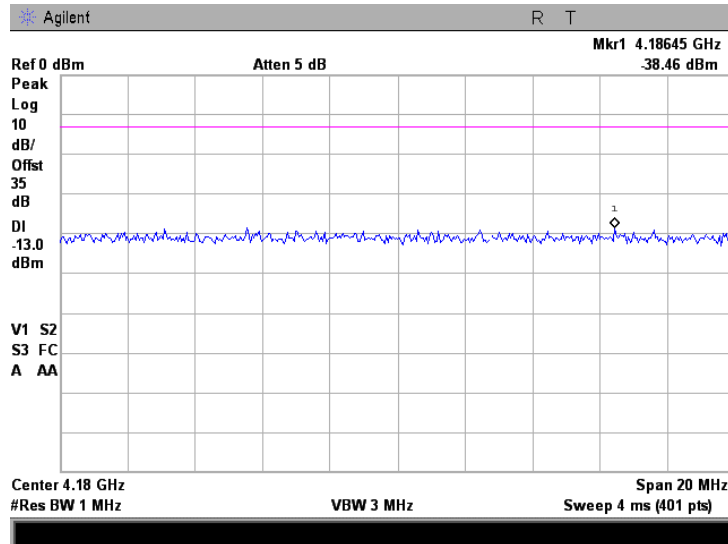

Plot 7.3.29 Conducted spurious emission measurements at the 5th harmonic of high carrier frequency

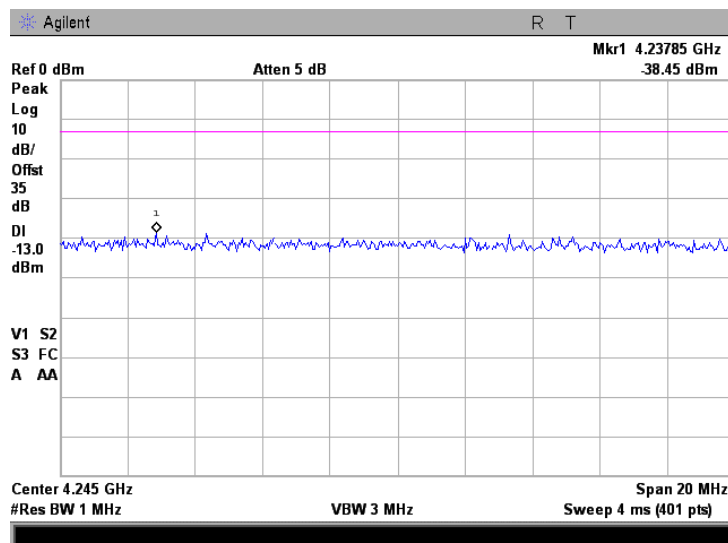

Test specification:	Section 22.917, Radiated spurious emissions		
Test procedure:	FCC part 22, Section 22.917		
Test mode:	Compliance	Verdict:	PASS
Date:	6/25/2007		
Temperature: 27°C	Air Pressure: 1010 hPa	Relative Humidity: 40 %	Power Supply: 5 VDC
Remarks:			

7.4 Field strength of spurious emissions

7.4.1 General

This test was performed to measure field strength of spurious emissions from the EUT. Specification test limit is given in Table 7.4.1.

Table 7.4.1 Radiated spurious emissions limits

Frequency, MHz	Attenuation below carrier dBc	ERP of spurious, dBm	Equivalent field strength limit @ 3m, dB(μ V/m)**
0.009 – 10 th harmonic	43+10logP*	-13	84.4

* - P is transmitter output power in Watts.

** - Equivalent field strength limit was calculated from maximum allowed ERP of spurious as follows:
 $E = \sqrt{30 \times P \times 1.64} / r$, where P is ERP in Watts, 1.64 is numeric gain of ideal dipole and r is antenna to EUT distance in meters.

7.4.2 Test procedure for spurious emission field strength measurements in 9 kHz to 30 MHz band

7.4.2.1 The EUT was set up as shown in Figure 7.4.1, energized and the performance check was conducted.

7.4.2.2 The specified frequency range was investigated with antenna connected to spectrum analyzer/ EMI receiver. To find maximum radiation the turntable was rotated 360° and the measuring antenna was rotated around its vertical axis.

7.4.2.3 The worst test results (the lowest margins) were recorded and shown in the associated plots.

7.4.3 Test procedure for spurious emission field strength measurements above 30 MHz

7.4.3.1 The EUT was set up as shown in Figure 7.4.2, energized and the performance check was conducted.

7.4.3.2 The specified frequency range was investigated with antenna connected to spectrum analyzer/ EMI receiver. To find maximum radiation the turntable was rotated 360°, the measuring antenna height was changed from 1 to 4 m, its polarization was switched from vertical to horizontal.

7.4.3.3 The worst test results (the lowest margins) were recorded and shown in the associated plots.

Test specification:	Section 22.917, Radiated spurious emissions		
Test procedure:	FCC part 22, Section 22.917		
Test mode:	Compliance	Verdict:	PASS
Date:	6/25/2007		
Temperature: 27°C	Air Pressure: 1010 hPa	Relative Humidity: 40 %	Power Supply: 5 VDC
Remarks:			

Figure 7.4.1 Setup for spurious emission field strength measurements below 30 MHz

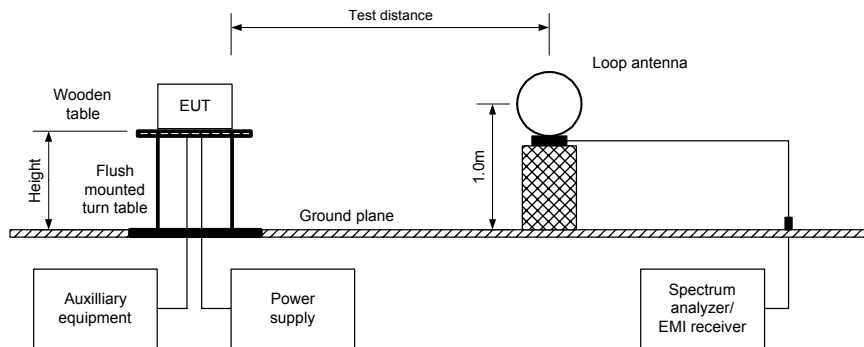

Photograph 7.4.1 Setup for spurious emission field strength measurements in 9 kHz to 30 MHz band



Test specification:	Section 22.917, Radiated spurious emissions		
Test procedure:	FCC part 22, Section 22.917		
Test mode:	Compliance	Verdict:	PASS
Date:	6/25/2007		
Temperature: 27°C	Air Pressure: 1010 hPa	Relative Humidity: 40 %	Power Supply: 5 VDC
Remarks:			

Figure 7.4.2 Setup for spurious emission field strength measurements above 30 MHz

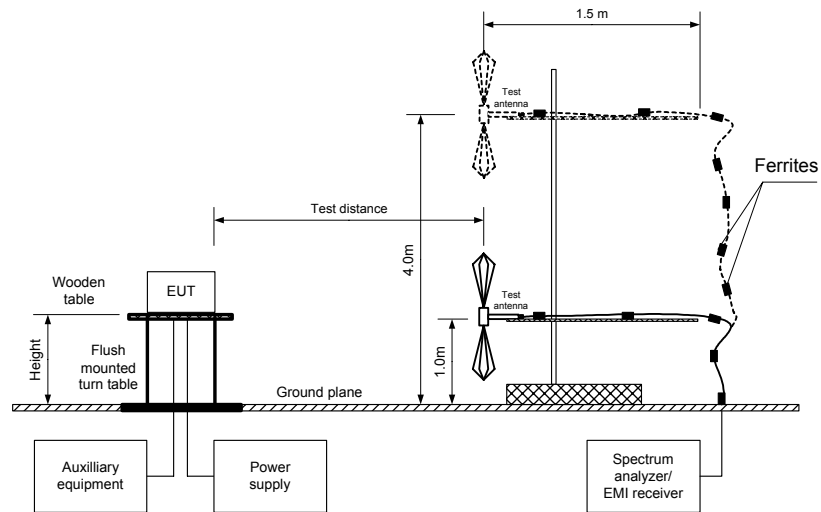

Photograph 7.4.2 Setup for spurious emission field strength measurements with double ridged guide antenna



Test specification:	Section 22.917, Radiated spurious emissions		
Test procedure:	FCC part 22, Section 22.917		
Test mode:	Compliance	Verdict:	PASS
Date:	6/25/2007		
Temperature: 27°C	Air Pressure: 1010 hPa	Relative Humidity: 40 %	Power Supply: 5 VDC
Remarks:			

Photograph 7.4.3 Setup for spurious emission field strength measurements, close view



Test specification:		Section 22.917, Radiated spurious emissions	
Test procedure:		FCC part 22, Section 22.917	
Test mode:	Compliance	Verdict:	PASS
Date:	6/25/2007		
Temperature: 27°C	Air Pressure: 1010 hPa	Relative Humidity: 40 %	Power Supply: 5 VDC
Remarks:			

Table 7.4.2 Spurious emission field strength test results

ASSIGNED FREQUENCY RANGE: 824-849 MHz
TEST DISTANCE: 3 m
TEST SITE: OATS
EUT HEIGHT: 0.8 m
INVESTIGATED FREQUENCY RANGE: 0.009 – 9000 MHz
DETECTOR USED: Peak
VIDEO BANDWIDTH: > Resolution bandwidth
TEST ANTENNA TYPE: Active loop (9 kHz – 30 MHz)
Biconical (30 MHz – 200 MHz)
Log periodic (200 MHz – 1000 MHz)
Biconilog (30 MHz – 1000 MHz)
Double ridged guide (above 1000 MHz)
MODULATION: GMSK
MODULATING SIGNAL: PRBS
BIT RATE: 270 kbps
TRANSMITTER OUTPUT POWER SETTINGS: Maximum

Frequency, MHz	Field strength, dB(μV/m)	Limit, dB(μV/m)	Margin, dB*	RBW, kHz	Antenna polarization	Antenna height, m	Turn-table position**, degrees
Low carrier frequency MHz							
All spurious are 20dB below limit							
Mid carrier frequency MHz							
All spurious are 20dB below limit							
High carrier frequency MHz							
All spurious are 20dB below limit							

*- Margin = Field strength of spurious – calculated field strength limit.

**- EUT front panel refers to 0 degrees position of turntable.

Reference numbers of test equipment used

HL 0446	HL 0521	HL 0589	HL 0604	HL 1984	HL 1947	HL 2009	HL 2259
HL 2909							

Full description is given in Appendix A.

Test specification:	Section 22.917, Radiated spurious emissions		
Test procedure:	FCC part 22, Section 22.917		
Test mode:	Compliance	Verdict:	PASS
Date:	6/25/2007		
Temperature: 27°C	Air Pressure: 1010 hPa	Relative Humidity: 40 %	Power Supply: 5 VDC
Remarks:			

Plot 7.4.1 Radiated emission measurements in 9 to 150 kHz range

TEST SITE: Semi anechoic chamber
 CARRIER FREQUENCY: Low
 ANTENNA POLARIZATION: Vertical and Horizontal
 TEST DISTANCE: 3 m

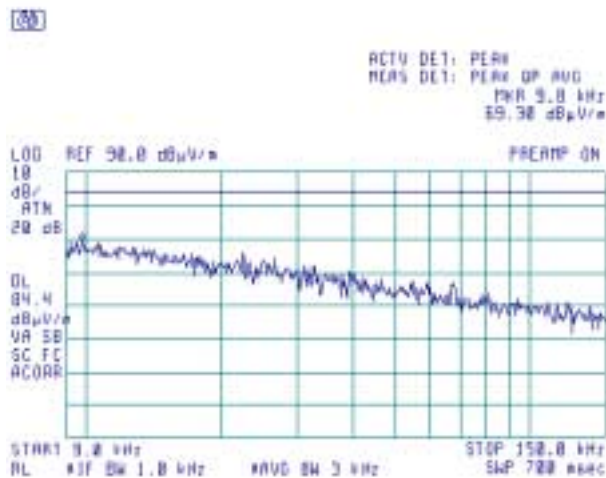

Plot 7.4.2 Radiated emission measurements in 9 to 150 kHz range

TEST SITE: Semi anechoic chamber
 CARRIER FREQUENCY: Mid
 ANTENNA POLARIZATION: Vertical and Horizontal
 TEST DISTANCE: 3 m

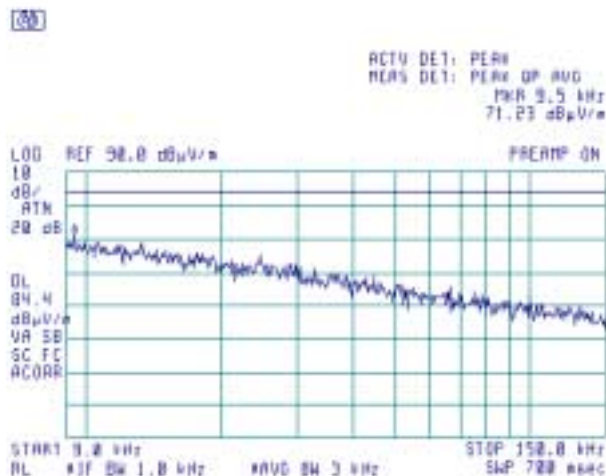

Test specification:	Section 22.917, Radiated spurious emissions		
Test procedure:	FCC part 22, Section 22.917		
Test mode:	Compliance	Verdict:	PASS
Date:	6/25/2007		
Temperature: 27°C	Air Pressure: 1010 hPa	Relative Humidity: 40 %	Power Supply: 5 VDC
Remarks:			

Plot 7.4.3 Radiated emission measurements in 9 to 150 kHz range

TEST SITE: Semi anechoic chamber
 CARRIER FREQUENCY: High
 ANTENNA POLARIZATION: Vertical and Horizontal
 TEST DISTANCE: 3 m

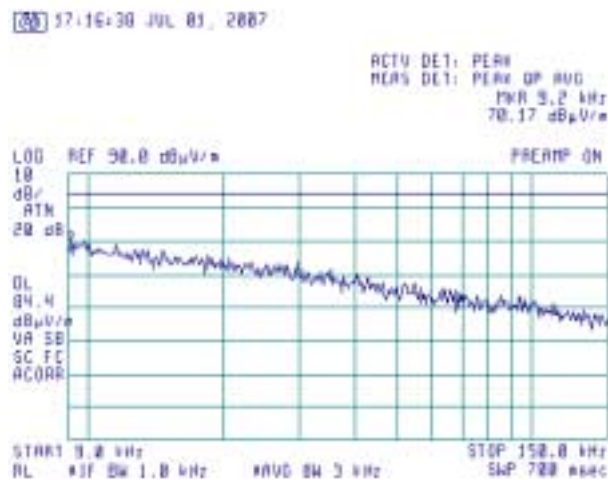

Plot 7.4.4 Radiated emission measurements in 0.15 - 30 MHz range

TEST SITE: Semi anechoic chamber
 CARRIER FREQUENCY: Low
 ANTENNA POLARIZATION: Vertical and Horizontal
 TEST DISTANCE: 3 m

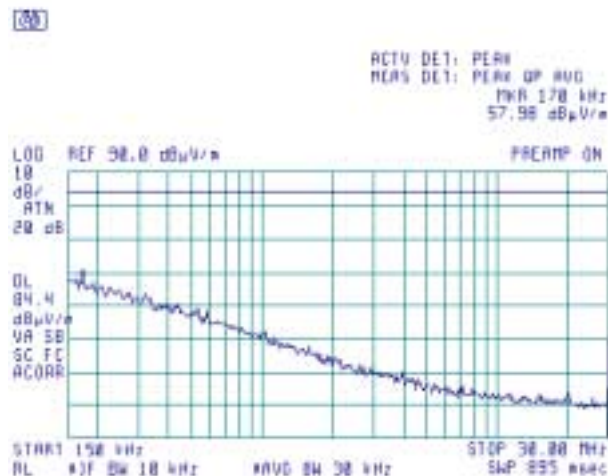

Test specification:	Section 22.917, Radiated spurious emissions		
Test procedure:	FCC part 22, Section 22.917		
Test mode:	Compliance	Verdict:	PASS
Date:	6/25/2007		
Temperature: 27°C	Air Pressure: 1010 hPa	Relative Humidity: 40 %	Power Supply: 5 VDC
Remarks:			

Plot 7.4.5 Radiated emission measurements in 0.15 - 30 MHz range

TEST SITE: Semi anechoic chamber
 CARRIER FREQUENCY: Mid
 ANTENNA POLARIZATION: Vertical and Horizontal
 TEST DISTANCE: 3 m

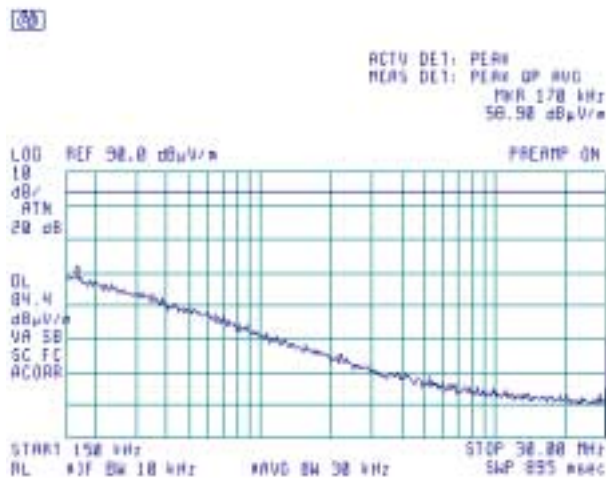

Plot 7.4.6 Radiated emission measurements in 0.15 - 30 MHz range

TEST SITE: Semi anechoic chamber
 CARRIER FREQUENCY: High
 ANTENNA POLARIZATION: Vertical and Horizontal
 TEST DISTANCE: 3 m

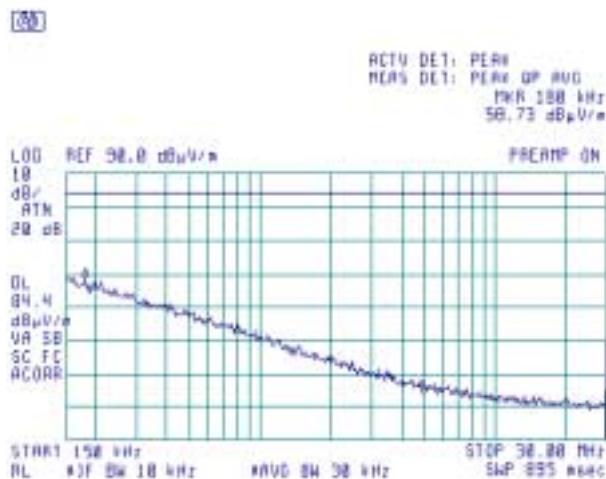

Test specification:	Section 22.917, Radiated spurious emissions		
Test procedure:	FCC part 22, Section 22.917		
Test mode:	Compliance	Verdict:	PASS
Date:	6/25/2007		
Temperature: 27°C	Air Pressure: 1010 hPa	Relative Humidity: 40 %	Power Supply: 5 VDC
Remarks:			

Plot 7.4.7 Radiated emission measurements in 30 - 1000 MHz range

TEST SITE: Semi anechoic chamber
CARRIER FREQUENCY: Low
ANTENNA POLARIZATION: Vertical and Horizontal
TEST DISTANCE: 3 m

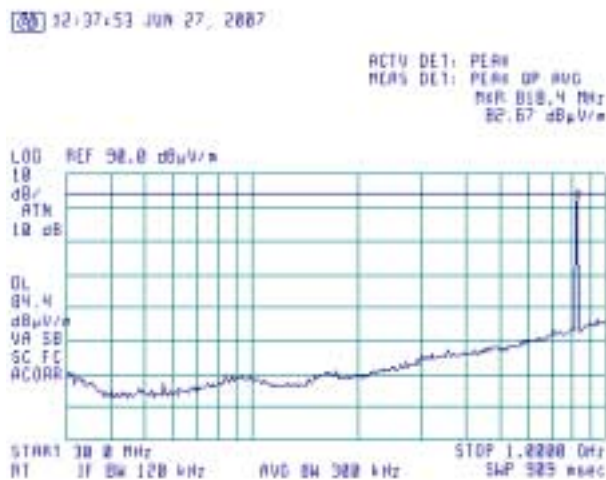

Plot 7.4.8 Radiated emission measurements in 30 - 1000 MHz range

TEST SITE: Semi anechoic chamber
CARRIER FREQUENCY: Mid
ANTENNA POLARIZATION: Vertical and Horizontal
TEST DISTANCE: 3 m

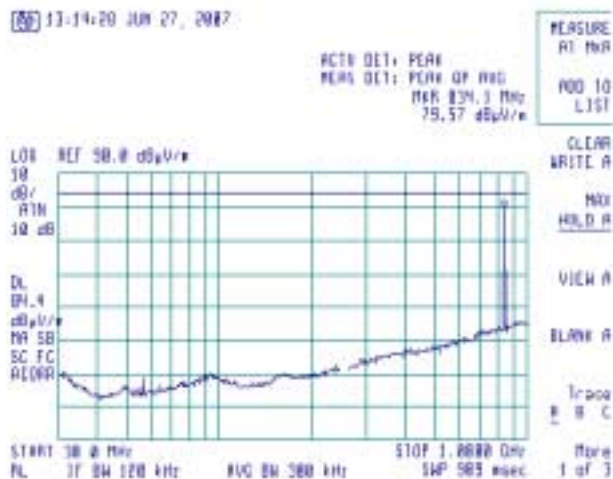

Test specification:	Section 22.917, Radiated spurious emissions		
Test procedure:	FCC part 22, Section 22.917		
Test mode:	Compliance	Verdict:	PASS
Date:	6/25/2007		
Temperature: 27°C	Air Pressure: 1010 hPa	Relative Humidity: 40 %	Power Supply: 5 VDC
Remarks:			

Plot 7.4.9 Radiated emission measurements in 30 - 1000 MHz range

TEST SITE: Semi anechoic chamber
CARRIER FREQUENCY: High
ANTENNA POLARIZATION: Vertical and Horizontal
TEST DISTANCE: 3 m

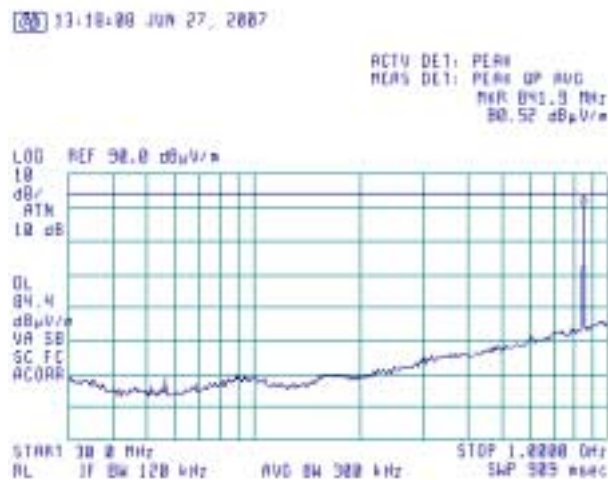

Plot 7.4.10 Radiated emission measurements in 1000 – 6500 MHz range

TEST SITE: Semi anechoic chamber
CARRIER FREQUENCY: Low
ANTENNA POLARIZATION: Vertical and Horizontal
TEST DISTANCE: 3 m

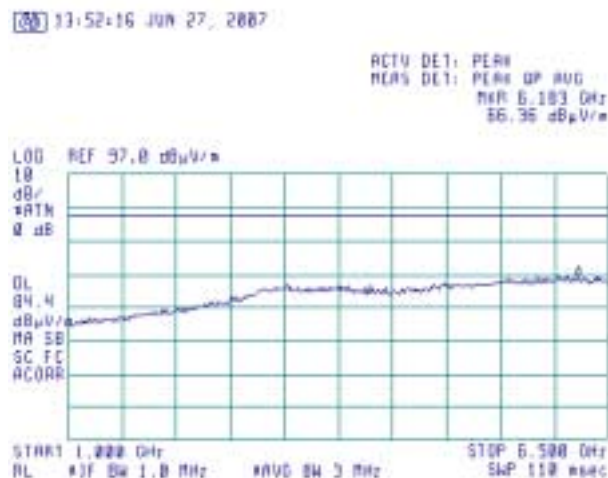

Test specification:	Section 22.917, Radiated spurious emissions		
Test procedure:	FCC part 22, Section 22.917		
Test mode:	Compliance	Verdict:	PASS
Date:	6/25/2007		
Temperature: 27°C	Air Pressure: 1010 hPa	Relative Humidity: 40 %	Power Supply: 5 VDC
Remarks:			

Plot 7.4.11 Radiated emission measurements in 1000 – 6500 MHz range

TEST SITE: Semi anechoic chamber
 CARRIER FREQUENCY: Mid
 ANTENNA POLARIZATION: Vertical and Horizontal
 TEST DISTANCE: 3 m

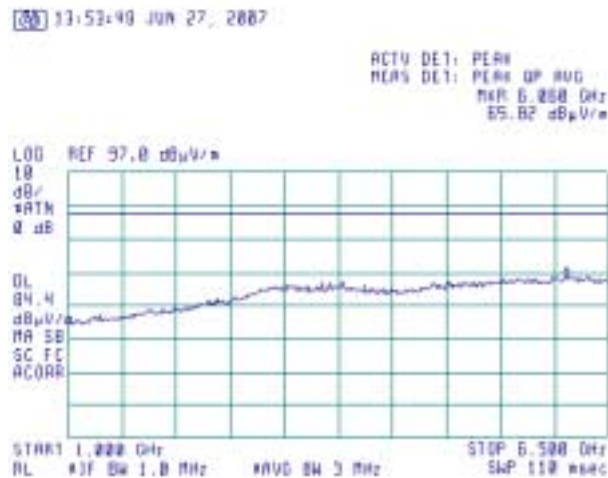

Plot 7.4.12 Radiated emission measurements in 1000 – 6500 MHz range

TEST SITE: Semi anechoic chamber
 CARRIER FREQUENCY: High
 ANTENNA POLARIZATION: Vertical and Horizontal
 TEST DISTANCE: 3 m

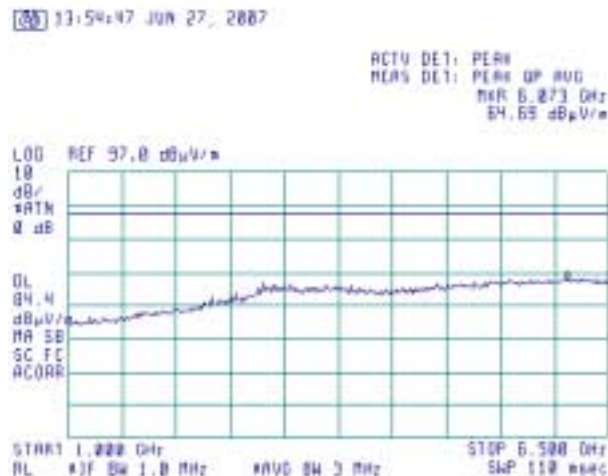

Test specification:	Section 22.917, Radiated spurious emissions		
Test procedure:	FCC part 22, Section 22.917		
Test mode:	Compliance	Verdict:	PASS
Date:	6/25/2007		
Temperature: 27°C	Air Pressure: 1010 hPa	Relative Humidity: 40 %	Power Supply: 5 VDC
Remarks:			

Plot 7.4.13 Radiated emission measurements in 6500 - 9000 MHz range

TEST SITE: Semi anechoic chamber
 CARRIER FREQUENCY: Low
 ANTENNA POLARIZATION: Vertical and Horizontal
 TEST DISTANCE: 3 m

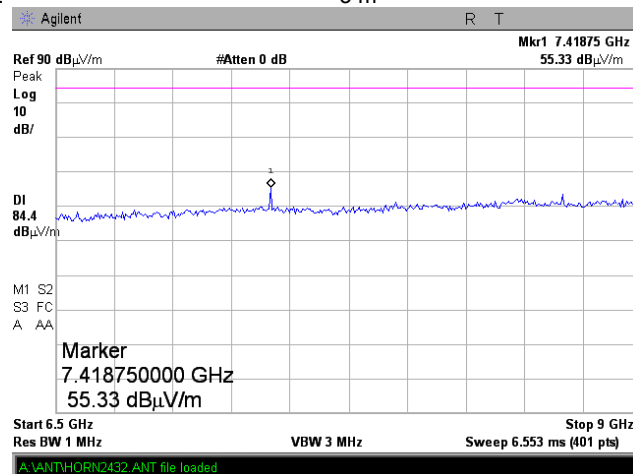

Plot 7.4.14 Radiated emission measurements in 6500 - 9000 MHz range

TEST SITE: Semi anechoic chamber
 CARRIER FREQUENCY: Mid
 ANTENNA POLARIZATION: Vertical and Horizontal
 TEST DISTANCE: 3 m

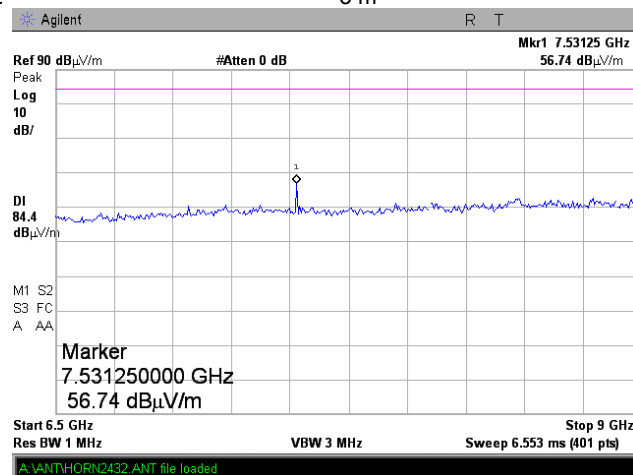

Test specification:	Section 22.917, Radiated spurious emissions		
Test procedure:	FCC part 22, Section 22.917		
Test mode:	Compliance	Verdict:	PASS
Date:	6/25/2007		
Temperature: 27°C	Air Pressure: 1010 hPa	Relative Humidity: 40 %	Power Supply: 5 VDC
Remarks:			

Plot 7.4.15 Radiated emission measurements in 6500 - 9000 MHz range

TEST SITE:	Semi anechoic chamber
CARRIER FREQUENCY:	High
ANTENNA POLARIZATION:	Vertical and Horizontal
TEST DISTANCE:	3 m

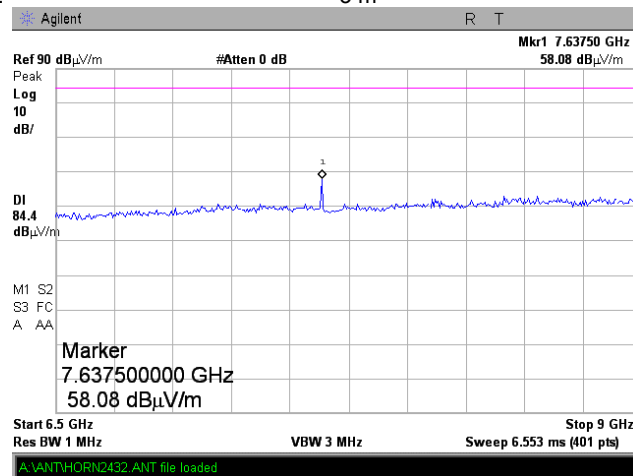

Test specification:	Section 22.917, Radiated spurious emissions		
Test procedure:	FCC part 22, Section 22.917		
Test mode:	Compliance	Verdict:	PASS
Date:	6/25/2007		
Temperature: 27°C	Air Pressure: 1010 hPa	Relative Humidity: 40 %	Power Supply: 5 VDC
Remarks:			

Plot 7.4.16 Radiated emission measurements at the 2nd harmonic

TEST SITE: Semi anechoic chamber
 CARRIER FREQUENCY: Low
 ANTENNA POLARIZATION: Vertical & Horizontal
 TEST DISTANCE: 3 m

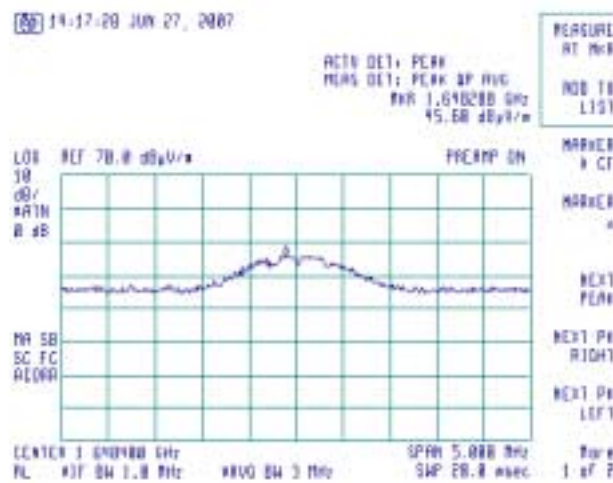

Plot 7.4.17 Radiated emission measurements at the 2nd harmonic

TEST SITE: Semi anechoic chamber
 CARRIER FREQUENCY: Mid
 ANTENNA POLARIZATION: Vertical & Horizontal
 TEST DISTANCE: 3 m

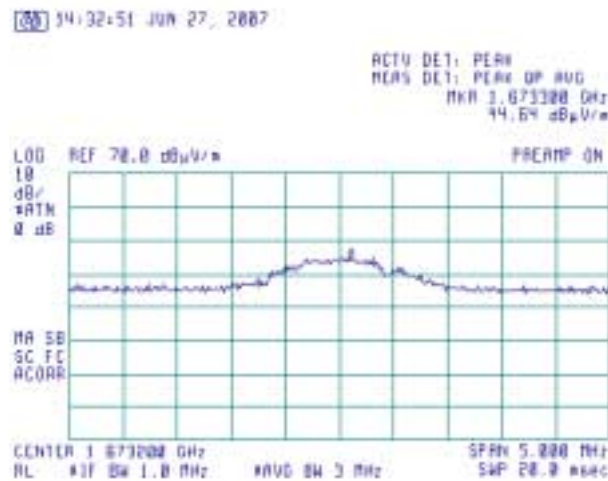

Test specification:	Section 22.917, Radiated spurious emissions		
Test procedure:	FCC part 22, Section 22.917		
Test mode:	Compliance	Verdict:	PASS
Date:	6/25/2007		
Temperature: 27°C	Air Pressure: 1010 hPa	Relative Humidity: 40 %	Power Supply: 5 VDC
Remarks:			

Plot 7.4.18 Radiated emission measurements at the 2nd harmonic

TEST SITE: Semi anechoic chamber
CARRIER FREQUENCY: High
ANTENNA POLARIZATION: Vertical & Horizontal
TEST DISTANCE: 3 m

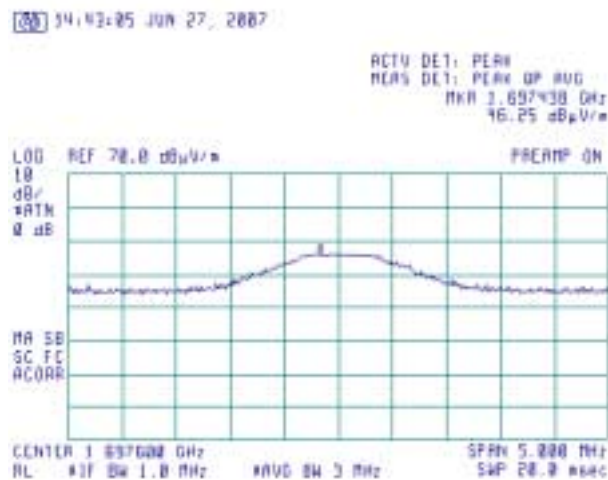

Plot 7.4.19 Radiated emission measurements at the 3rd harmonic

TEST SITE: Semi anechoic chamber
CARRIER FREQUENCY: Low
ANTENNA POLARIZATION: Vertical & Horizontal
TEST DISTANCE: 3 m

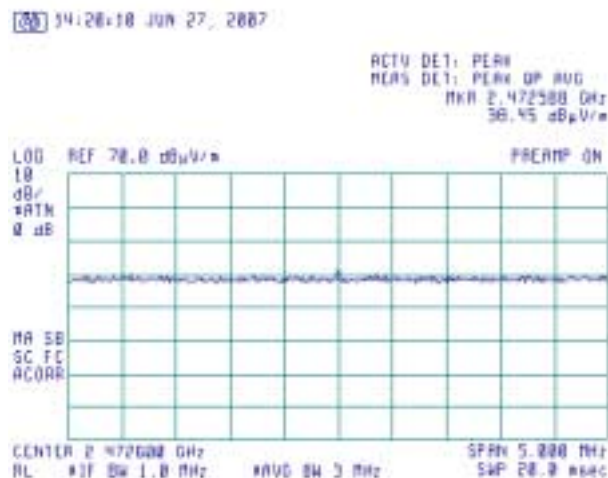

Test specification:	Section 22.917, Radiated spurious emissions		
Test procedure:	FCC part 22, Section 22.917		
Test mode:	Compliance	Verdict:	PASS
Date:	6/25/2007		
Temperature: 27°C	Air Pressure: 1010 hPa	Relative Humidity: 40 %	Power Supply: 5 VDC
Remarks:			

Plot 7.4.20 Radiated emission measurements at the 3rd harmonic

TEST SITE: Semi anechoic chamber
 CARRIER FREQUENCY: Mid
 ANTENNA POLARIZATION: Vertical & Horizontal
 TEST DISTANCE: 3 m

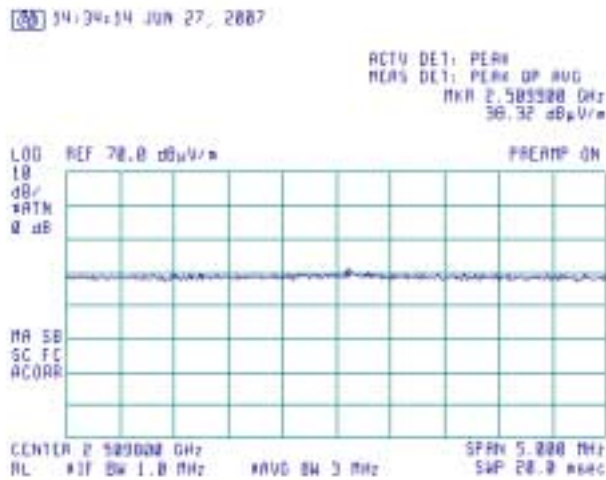

Plot 7.4.21 Radiated emission measurements at the 3rd harmonic

TEST SITE: Semi anechoic chamber
 CARRIER FREQUENCY: High
 ANTENNA POLARIZATION: Vertical & Horizontal
 TEST DISTANCE: 3 m

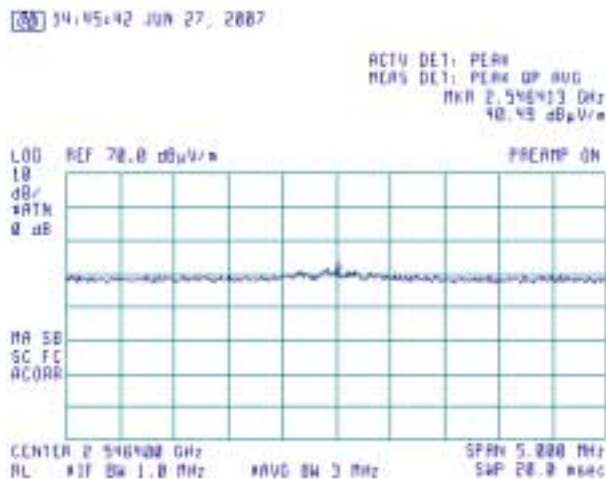

Test specification:	Section 22.917, Radiated spurious emissions		
Test procedure:	FCC part 22, Section 22.917		
Test mode:	Compliance	Verdict:	PASS
Date:	6/25/2007		
Temperature: 27°C	Air Pressure: 1010 hPa	Relative Humidity: 40 %	Power Supply: 5 VDC
Remarks:			

Plot 7.4.22 Radiated emission measurements at the 4th harmonic

TEST SITE: Semi anechoic chamber
CARRIER FREQUENCY: Low
ANTENNA POLARIZATION: Vertical & Horizontal
TEST DISTANCE: 3 m

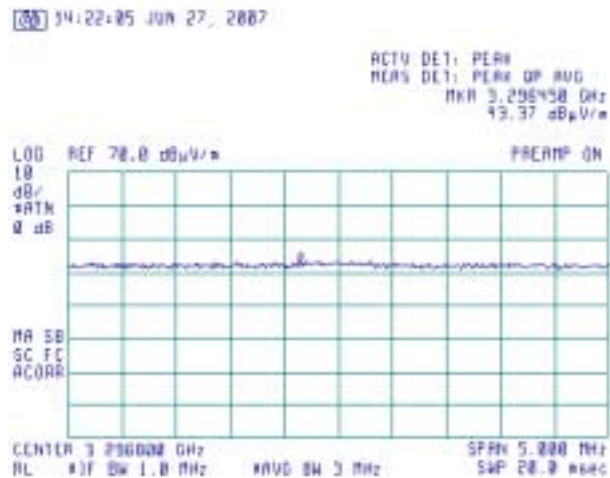

Plot 7.4.23 Radiated emission measurements at the 4th harmonic

TEST SITE: Semi anechoic chamber
CARRIER FREQUENCY: Mid
ANTENNA POLARIZATION: Vertical & Horizontal
TEST DISTANCE: 3 m

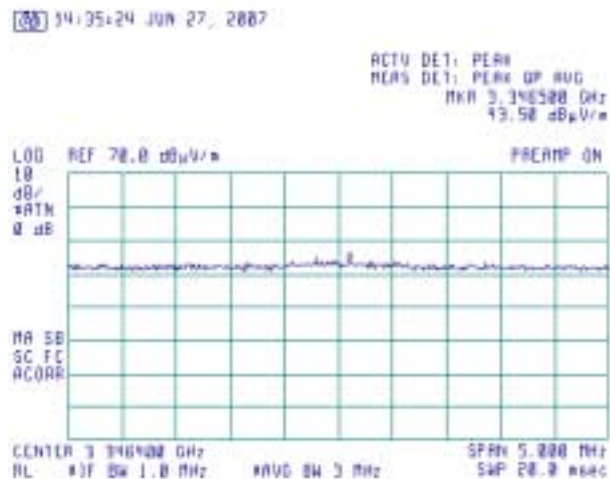

Test specification:	Section 22.917, Radiated spurious emissions		
Test procedure:	FCC part 22, Section 22.917		
Test mode:	Compliance	Verdict:	PASS
Date:	6/25/2007		
Temperature: 27°C	Air Pressure: 1010 hPa	Relative Humidity: 40 %	Power Supply: 5 VDC
Remarks:			

Plot 7.4.24 Radiated emission measurements at the 4th harmonic

TEST SITE: Semi anechoic chamber
 CARRIER FREQUENCY: High
 ANTENNA POLARIZATION: Vertical & Horizontal
 TEST DISTANCE: 3 m

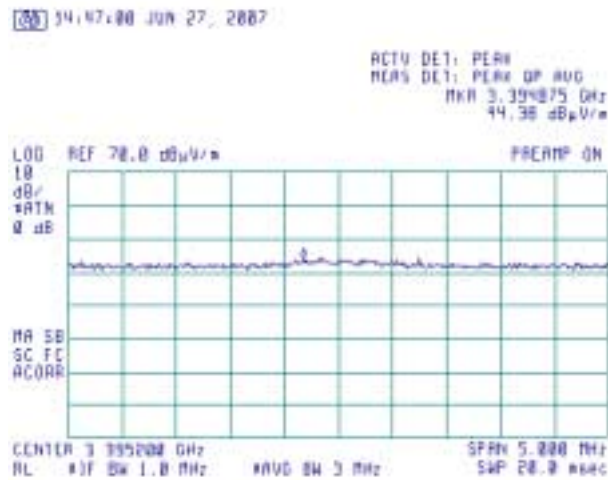

Plot 7.4.25 Radiated emission measurements at the 5th harmonic

TEST SITE: Semi anechoic chamber
 CARRIER FREQUENCY: Low
 ANTENNA POLARIZATION: Vertical & Horizontal
 TEST DISTANCE: 3 m

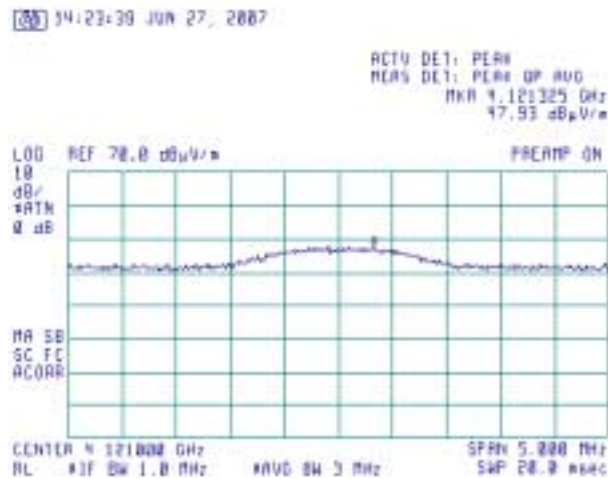

Test specification:	Section 22.917, Radiated spurious emissions		
Test procedure:	FCC part 22, Section 22.917		
Test mode:	Compliance	Verdict:	PASS
Date:	6/25/2007		
Temperature: 27°C	Air Pressure: 1010 hPa	Relative Humidity: 40 %	Power Supply: 5 VDC
Remarks:			

Plot 7.4.26 Radiated emission measurements at the 5th harmonic

TEST SITE:	Semi anechoic chamber
CARRIER FREQUENCY:	Mid
ANTENNA POLARIZATION:	Vertical & Horizontal
TEST DISTANCE:	3 m

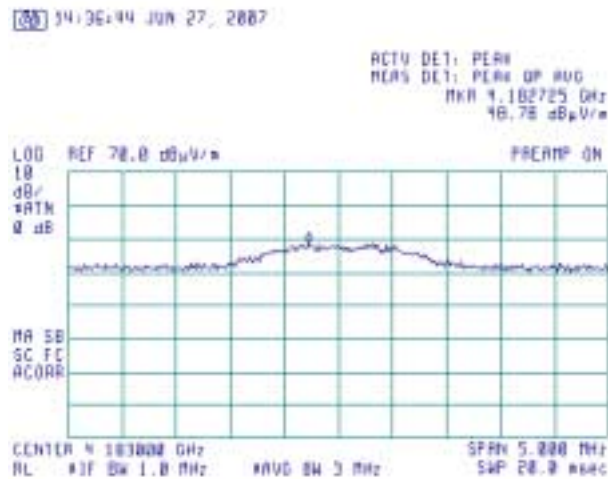

Plot 7.4.27 Radiated emission measurements at the 5th harmonic

TEST SITE:	Semi anechoic chamber
CARRIER FREQUENCY:	High
ANTENNA POLARIZATION:	Vertical & Horizontal
TEST DISTANCE:	3 m

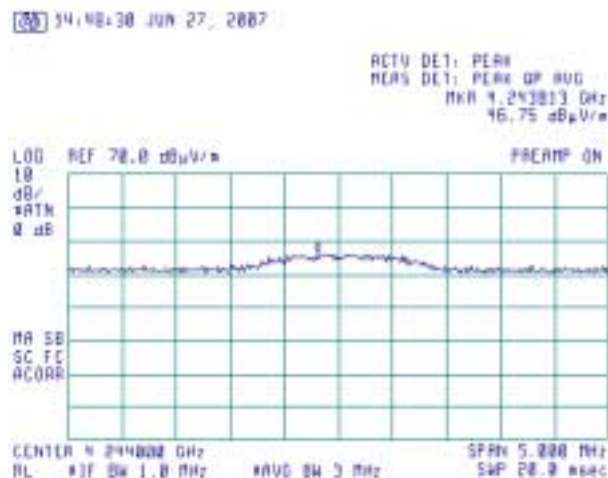

Test specification:	Section 22.917, Radiated spurious emissions		
Test procedure:	FCC part 22, Section 22.917		
Test mode:	Compliance	Verdict:	PASS
Date:	6/25/2007		
Temperature: 27°C	Air Pressure: 1010 hPa	Relative Humidity: 40 %	Power Supply: 5 VDC
Remarks:			

Plot 7.4.28 Radiated emission measurements at the 6th harmonic

TEST SITE: Semi anechoic chamber
CARRIER FREQUENCY: Low
ANTENNA POLARIZATION: Vertical & Horizontal
TEST DISTANCE: 3 m

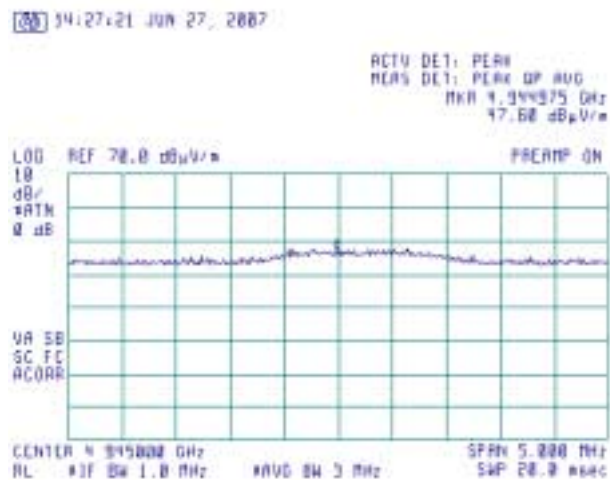

Plot 7.4.29 Radiated emission measurements at the 6th harmonic

TEST SITE: Semi anechoic chamber
CARRIER FREQUENCY: Mid
ANTENNA POLARIZATION: Vertical & Horizontal
TEST DISTANCE: 3 m

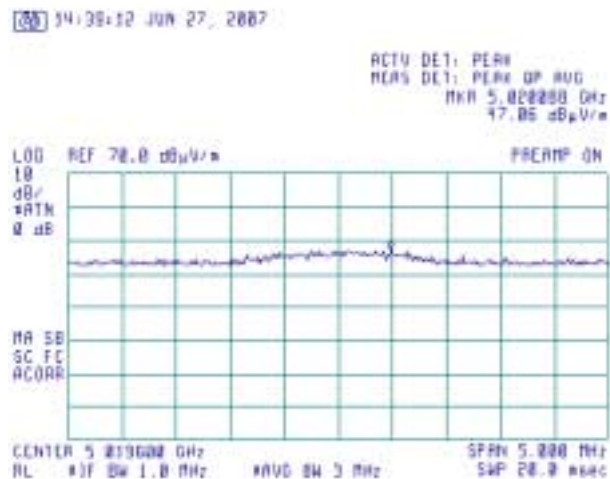

Test specification:	Section 22.917, Radiated spurious emissions		
Test procedure:	FCC part 22, Section 22.917		
Test mode:	Compliance	Verdict:	PASS
Date:	6/25/2007		
Temperature: 27°C	Air Pressure: 1010 hPa	Relative Humidity: 40 %	Power Supply: 5 VDC
Remarks:			

Plot 7.4.30 Radiated emission measurements at the 6th harmonic

TEST SITE: Semi anechoic chamber
 CARRIER FREQUENCY: High
 ANTENNA POLARIZATION: Vertical & Horizontal
 TEST DISTANCE: 3 m

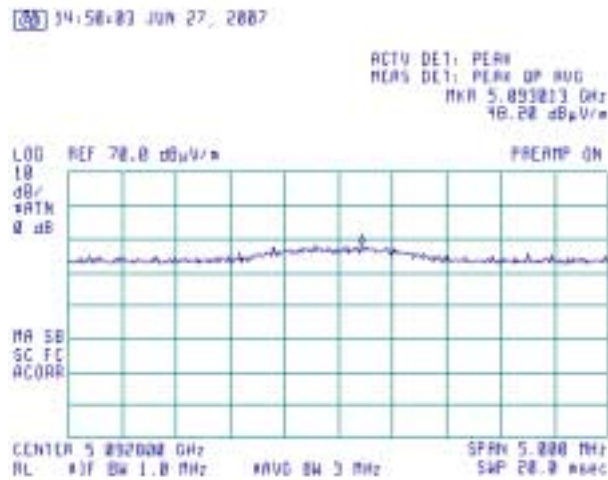

Plot 7.4.31 Radiated emission measurements at the 7th harmonic

TEST SITE: Semi anechoic chamber
 CARRIER FREQUENCY: Low
 ANTENNA POLARIZATION: Vertical & Horizontal
 TEST DISTANCE: 3 m

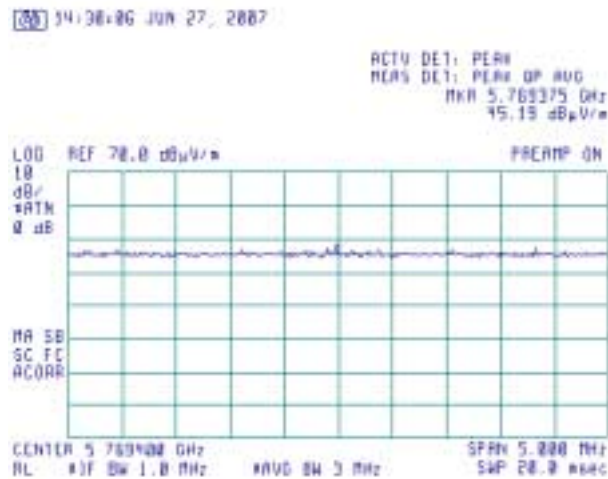

Test specification:	Section 22.917, Radiated spurious emissions		
Test procedure:	FCC part 22, Section 22.917		
Test mode:	Compliance	Verdict:	PASS
Date:	6/25/2007		
Temperature: 27°C	Air Pressure: 1010 hPa	Relative Humidity: 40 %	Power Supply: 5 VDC
Remarks:			

Plot 7.4.32 Radiated emission measurements at the 7th harmonic

TEST SITE: Semi anechoic chamber
 CARRIER FREQUENCY: Mid
 ANTENNA POLARIZATION: Vertical & Horizontal
 TEST DISTANCE: 3 m

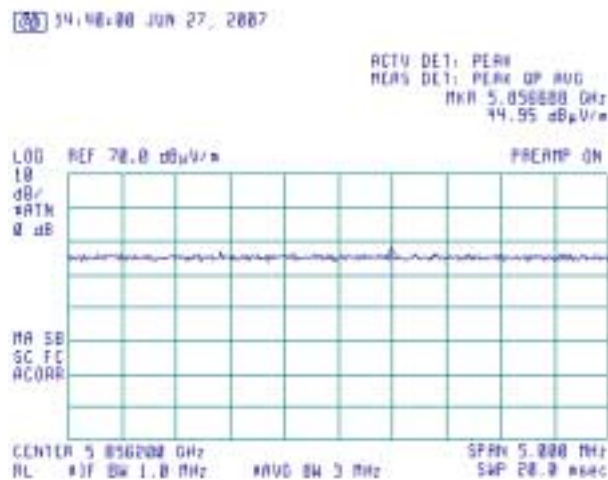

Plot 7.4.33 Radiated emission measurements at the 7th harmonic

TEST SITE: Semi anechoic chamber
 CARRIER FREQUENCY: High
 ANTENNA POLARIZATION: Vertical & Horizontal
 TEST DISTANCE: 3 m

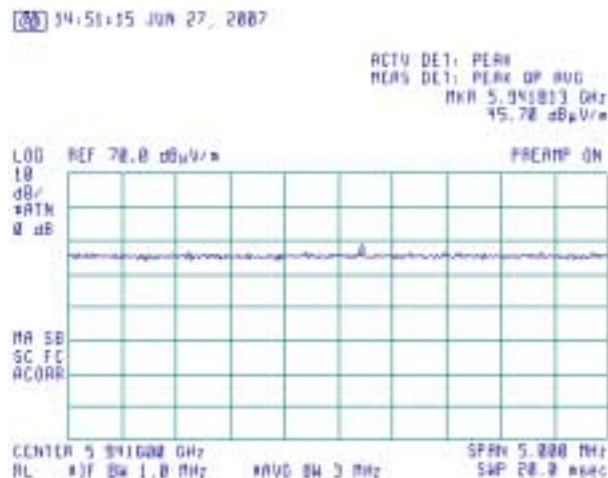

Test specification:	Section 22.917, Radiated spurious emissions		
Test procedure:	FCC part 22, Section 22.917		
Test mode:	Compliance	Verdict:	PASS
Date:	6/25/2007		
Temperature: 27°C	Air Pressure: 1010 hPa	Relative Humidity: 40 %	Power Supply: 5 VDC
Remarks:			

Plot 7.4.34 Radiated emission measurements at the 8th harmonic

TEST SITE: Semi anechoic chamber
 CARRIER FREQUENCY: Low
 ANTENNA POLARIZATION: Vertical & Horizontal
 TEST DISTANCE: 3 m

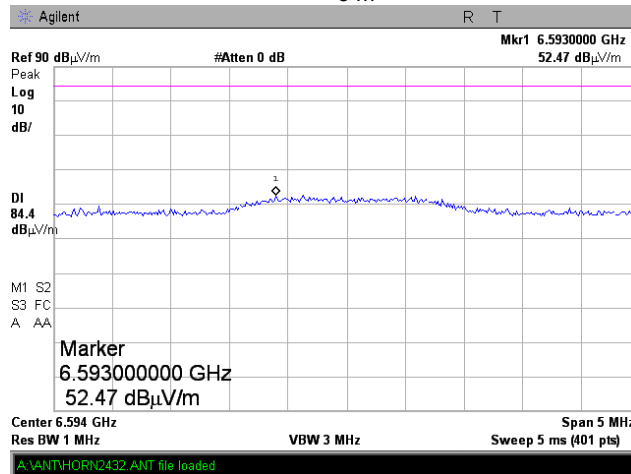

Plot 7.4.35 Radiated emission measurements at the 8th harmonic

TEST SITE: Semi anechoic chamber
 CARRIER FREQUENCY: Mid
 ANTENNA POLARIZATION: Vertical & Horizontal
 TEST DISTANCE: 3 m

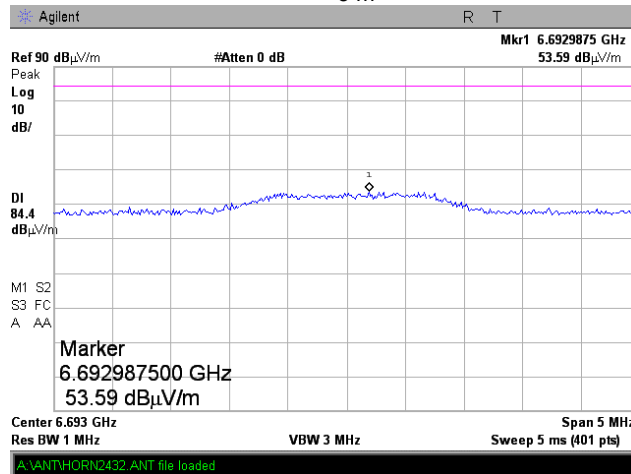

Test specification:	Section 22.917, Radiated spurious emissions		
Test procedure:	FCC part 22, Section 22.917		
Test mode:	Compliance	Verdict:	PASS
Date:	6/25/2007		
Temperature: 27°C	Air Pressure: 1010 hPa	Relative Humidity: 40 %	Power Supply: 5 VDC
Remarks:			

Plot 7.4.36 Radiated emission measurements at the 8th harmonic

TEST SITE: Semi anechoic chamber
 CARRIER FREQUENCY: High
 ANTENNA POLARIZATION: Vertical & Horizontal
 TEST DISTANCE: 3 m

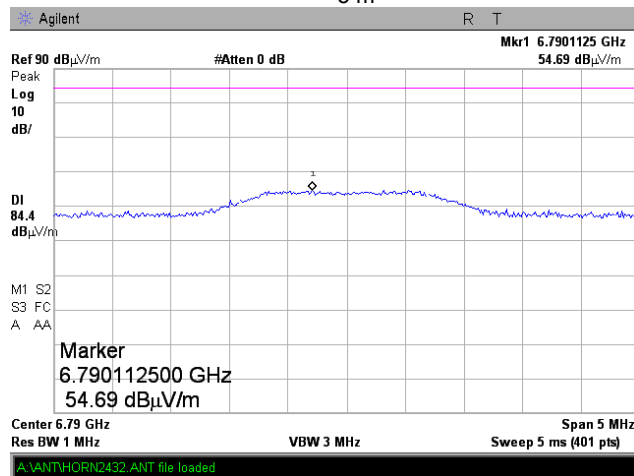

Plot 7.4.37 Radiated emission measurements at the 9th harmonic

TEST SITE: OATS
 CARRIER FREQUENCY: Low
 ANTENNA POLARIZATION: Vertical & Horizontal
 TEST DISTANCE: 3 m

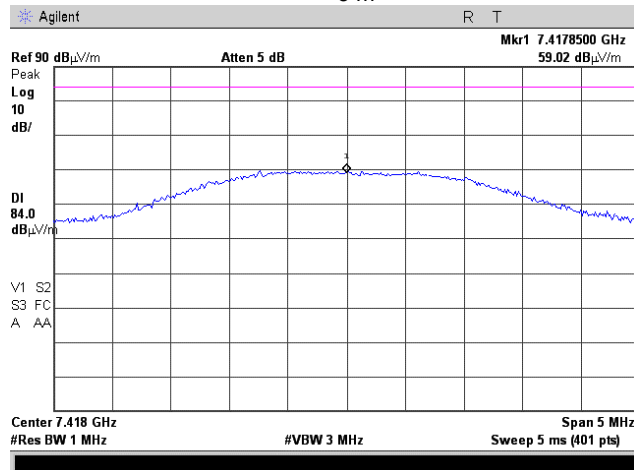

Test specification:	Section 22.917, Radiated spurious emissions		
Test procedure:	FCC part 22, Section 22.917		
Test mode:	Compliance	Verdict:	PASS
Date:	6/25/2007		
Temperature: 27°C	Air Pressure: 1010 hPa	Relative Humidity: 40 %	Power Supply: 5 VDC
Remarks:			

Plot 7.4.38 Radiated emission measurements at the 9th harmonic

TEST SITE: Semi anechoic chamber
 CARRIER FREQUENCY: Mid
 ANTENNA POLARIZATION: Vertical & Horizontal
 TEST DISTANCE: 3 m

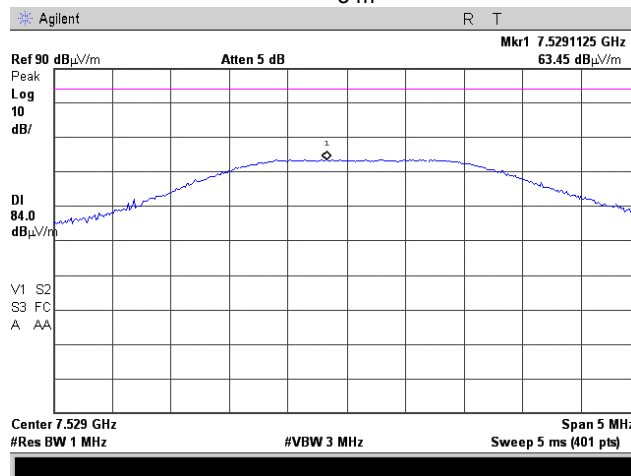

Plot 7.4.39 Radiated emission measurements at the 9th harmonic

TEST SITE: Semi anechoic chamber
 CARRIER FREQUENCY: High
 ANTENNA POLARIZATION: Vertical & Horizontal
 TEST DISTANCE: 3 m

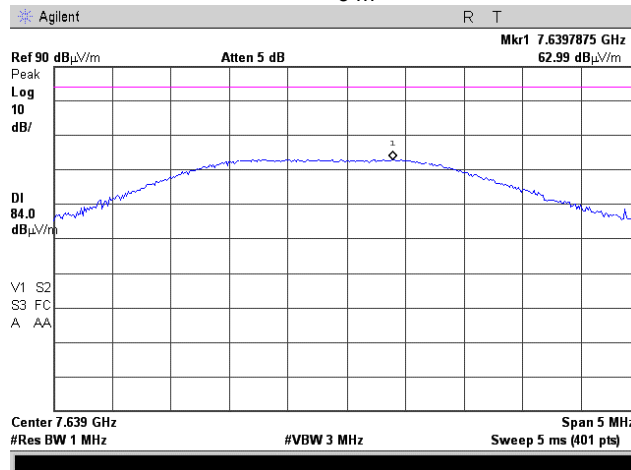

Test specification:	Section 22.917, Radiated spurious emissions		
Test procedure:	FCC part 22, Section 22.917		
Test mode:	Compliance	Verdict:	PASS
Date:	6/25/2007		
Temperature: 27°C	Air Pressure: 1010 hPa	Relative Humidity: 40 %	Power Supply: 5 VDC
Remarks:			

Plot 7.4.40 Radiated emission measurements at the 10th harmonic

TEST SITE: Semi anechoic chamber
 CARRIER FREQUENCY: Low
 ANTENNA POLARIZATION: Vertical & Horizontal
 TEST DISTANCE: 3 m

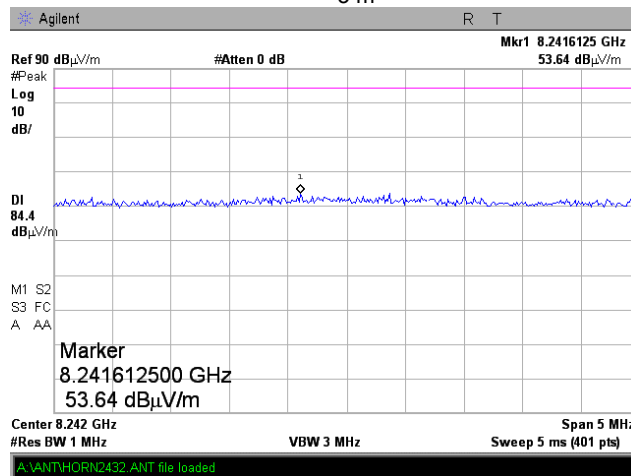

Plot 7.4.41 Radiated emission measurements at the 10th harmonic

TEST SITE: Semi anechoic chamber
 CARRIER FREQUENCY: Mid
 ANTENNA POLARIZATION: Vertical & Horizontal
 TEST DISTANCE: 3 m

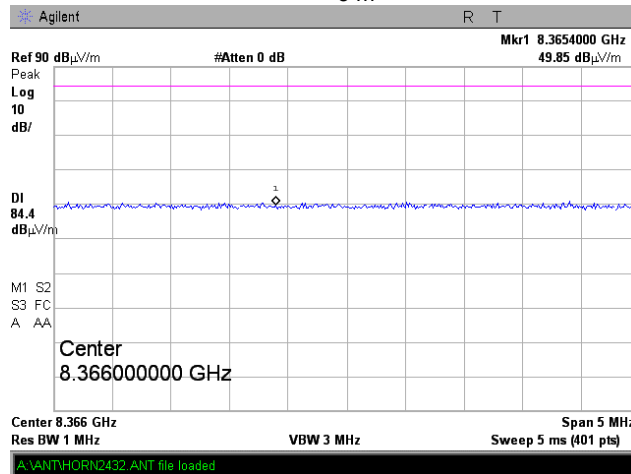

Test specification:	Section 22.917, Radiated spurious emissions		
Test procedure:	FCC part 22, Section 22.917		
Test mode:	Compliance	Verdict:	PASS
Date:	6/25/2007		
Temperature: 27°C	Air Pressure: 1010 hPa	Relative Humidity: 40 %	Power Supply: 5 VDC
Remarks:			

Plot 7.4.42 Radiated emission measurements at the 10th harmonic

TEST SITE: Semi anechoic chamber
 CARRIER FREQUENCY: High
 ANTENNA POLARIZATION: Vertical & Horizontal
 TEST DISTANCE: 3 m

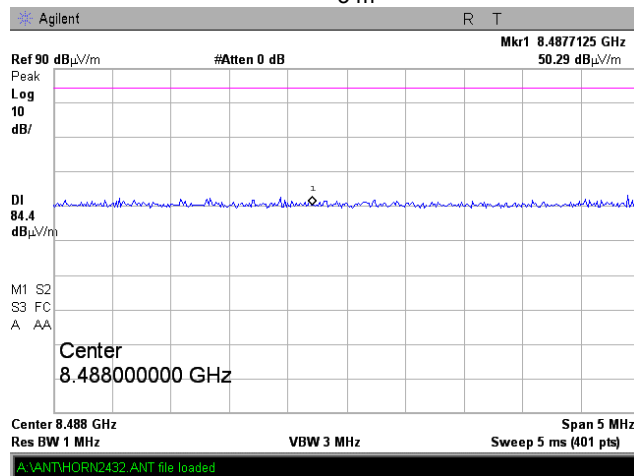

Test specification: Section 22.355, Frequency stability test			
Test procedure: FCC part 22, Section 22.355, part 2 section 2.1055			
Test mode: Compliance	Verdict: PASS		
Date: 7/04/2007			
Temperature: 26°C	Air Pressure: 1012 hPa	Relative Humidity: 48 %	Power Supply: 120 VAC
Remarks:			

7.5 Frequency stability test

7.5.1 General

This test was performed to measure frequency stability of transmitter RF carrier. Specification test limits are given in Table 7.5.1. The test results are provided in Table 7.5.2.

Table 7.5.1 Frequency stability limits

Assigned frequency, MHz	Limit, ppm	Limits, Hz
824.2	2.5	2061
836.4		2092
848.8		2122

7.5.2 Test procedure

- 7.5.2.1 The EUT was set up as shown in Figure 7.5.1, energized and its proper operation was checked.
- 7.5.2.2 The EUT power was turned off. Temperature within test chamber was set to +30°C and a period of time sufficient to stabilize all of the oscillator circuit components was allowed.
- 7.5.2.3 The EUT was powered on and carrier frequency was measured at start up moment and then every minute until frequency had been stabilized or 10 minutes elapsed whichever reached the last. The EUT was powered off.
- 7.5.2.4 The above procedure was repeated at 0°C and at the lowest test temperature.
- 7.5.2.5 The EUT was powered on and carrier frequency was measured at start up moment and at the end of stabilization period at the rest of test temperatures and voltages. The EUT was powered off.
- 7.5.2.6 Frequency displacement was calculated and compared with the limit as provided in Table 7.5.2

Figure 7.5.1 Frequency stability test setup

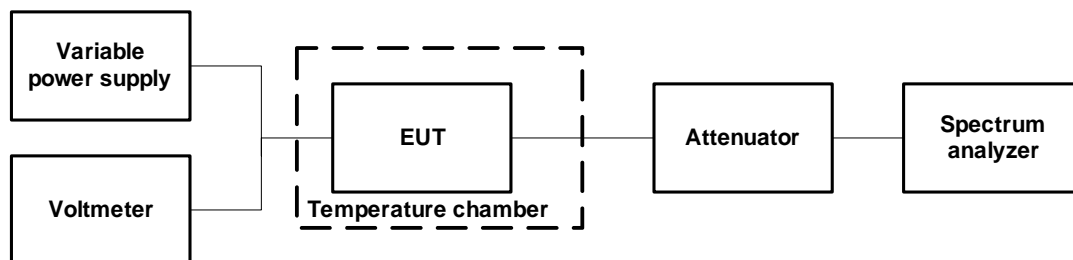

Test specification:	Section 22.355, Frequency stability test		
Test procedure:	FCC part 22, Section 22.355, part 2 section 2.1055		
Test mode:	Compliance	Verdict:	PASS
Date:	7/04/2007		
Temperature: 26°C	Air Pressure: 1012 hPa	Relative Humidity: 48 %	Power Supply: 120 VAC
Remarks:			

Photograph 7.5.1 Frequency stability test setup



Photograph 7.5.2 Frequency stability test setup



Test specification: Section 22.355, Frequency stability test	
Test procedure: FCC part 22, Section 22.355, part 2 section 2.1055	
Test mode: Compliance	Verdict: PASS
Date: 7/04/2007	
Temperature: 26°C	Air Pressure: 1012 hPa
Relative Humidity: 48 %	
Power Supply: 120 VAC	
Remarks:	

Table 7.5.2 Frequency stability test results

OPERATING FREQUENCY: 824.2 – 848.8 MHz
 NOMINAL POWER VOLTAGE: 230 V
 TEMPERATURE STABILIZATION PERIOD: 20 min
 POWER DURING TEMPERATURE TRANSITION: Off
 SPECTRUM ANALYZER MODE: Counter
 RESOLUTION BANDWIDTH: 10 kHz
 VIDEO BANDWIDTH: 100 Hz
 MODULATION: modulated

T, °C	Voltage V	Frequency, MHz							Max frequency drift, Hz		Limit, Hz	Margin, Hz	Verdict
		Start up	1 st min	2 nd min	3 rd min	4 th min	5 th min	0 th min	Positive	Negative			
Low frequency													
-30	nominal	824.200037	824.20001	824.20004	824.199986	824.200009	824.200009	824.199982	0	-200	2061	-1860	Pass
-20	nominal	824.200343	NA	NA	NA	NA	NA	824.200223	161	0		-1900	Pass
-10	nominal	824.200125	NA	NA	NA	NA	NA	824.200297	115	-57		-1946	Pass
0	nominal	824.200418	824.200421	824.200381	824.200380	824.200351	824.200411	824.200322	239	0		-1822	Pass
10	nominal	824.200197	NA	NA	NA	NA	NA	824.200379	197	0		-1864	Pass
20	-15%	824.200243	NA	NA	NA	NA	NA	824.200535	353	0		-1708	Pass
20	nominal	824.200819	NA	NA	NA	NA	NA	824.200182	637	0		-1424	Pass
20	+15%	824.200525	NA	NA	NA	NA	NA	824.200394	343	0		-1718	Pass
30	nominal	824.200023	824.200042	824.200046	824.200024	824.200002	824.200031	824.200026	0	-180		-1880	Pass
40	nominal	824.199996	NA	NA	NA	NA	NA	824.200013	0	-186		-1875	Pass
50	nominal	824.200012	NA	NA	NA	NA	NA	824.199990	0	-192	-1868	Pass	
Mid frequency													
-30	nominal	836.600019	836.600037	836.600025	836.600042	836.600019	836.600051	836.600018	0	-233	2092	-1859	Pass
-20	nominal	836.600368	NA	NA	NA	NA	NA	836.600315	117	0		-1974	Pass
-10	nominal	836.600268	NA	NA	NA	NA	NA	836.600204	17	-47		-2045	Pass
0	nominal	836.600165	836.600121	836.600191	836.600155	836.600082	836.600134	836.600137	0	-169		-1923	Pass
10	nominal	836.600182	NA	NA	NA	NA	NA	836.600230	0	-69.0		-2022.5	Pass
20	-15%	836.600241	NA	NA	NA	NA	NA	836.600272	21	-10		-2070	Pass
20	nominal	836.600359	NA	NA	NA	NA	NA	836.600251	108	0		-1983	Pass
20	+15%	836.600252	NA	NA	NA	NA	NA	836.600171	1	-80		-2012	Pass
30	nominal	836.600032	836.600023	836.600046	836.600028	836.600016	836.600012	836.600034	0	-239		-1853	Pass
40	nominal	836.600025	NA	NA	NA	NA	NA	836.600038	0	-226		-1866	Pass
50	nominal	836.600044	NA	NA	NA	NA	NA	836.600016	0	-235	-1857	Pass	
High frequency													
-30	nominal	848.800065	848.800037	848.800049	848.800055	848.800025	848.800028	848.800039	0	-346	2122	-1776	Pass
-20	nominal	848.800244	NA	NA	NA	NA	NA	848.800177	0	-194		-1928	Pass
-10	nominal	848.800527	NA	NA	NA	NA	NA	848.800397	156	0		-1966	Pass
0	nominal	848.800203	848.800197	848.800352	848.800379	848.800371	848.800349	848.800399	28	-174		-1948	Pass
10	nominal	848.800211	NA	NA	NA	NA	NA	848.800296	0	-160		-1962	Pass
20	-15%	848.800310	NA	NA	NA	NA	NA	848.800229	0	-142		-1980	Pass
20	nominal	848.800222	NA	NA	NA	NA	NA	848.800371	0	-149		-1973	Pass
20	+15%	848.800256	NA	NA	NA	NA	NA	848.800200	0	-171		-1951	Pass
30	nominal	848.800029	848.800034	848.799988	848.800049	848.800052	848.800037	848.800062	0	-383		-1739	Pass
40	nominal	848.800042	NA	NA	NA	NA	NA	848.800026	0	-345		-1777	Pass
50	nominal	848.800040	NA	NA	NA	NA	NA	848.800049	0	-331	-1791	Pass	

* - Reference frequency
 ** - Battery operating end point specified by the manufacturer.

Reference numbers of test equipment used

HL 2011	HL 2869	HL 2909	HL 2912	HL 3178	HL 3180	HL 3210
---------	---------	---------	---------	---------	---------	---------

Full description is given in Appendix A.

Test specification:	Section 24.232, Peak output power		
Test procedure:	FCC part 24, Section 24.232		
Test mode:	Compliance	Verdict:	PASS
Date:	6/24/2007		
Temperature: 27°C	Air Pressure: 1010 hPa	Relative Humidity: 42 %	Power Supply: 5 VDC
Remarks:			

8 Transmitter tests according to 47CFR part 24 requirements

8.1 Peak output power

8.1.1 General

This test was performed to measure the peak output power at RF antenna connector. Specification test limits are given in Table 8.1.1.

Table 8.1.1 Peak output power limits

Assigned frequency range, MHz	Maximum peak output power	
	W	dBm
1850 - 1910	2.0	33.0

8.1.2 Test procedure

8.1.2.1 The EUT was set up as shown in Figure 8.1.1, energized and its proper operation was checked.

8.1.2.2 The EUT was adjusted to produce maximum available to the end user RF output power.

8.1.2.3 The peak output power was measured with spectrum analyzer as provided in Table 8.1.2 and associated plots.

Figure 8.1.1 Peak output power test setup



Photograph 8.1.1 Peak output power test setup



Test specification: Section 24.232, Peak output power			
Test procedure: FCC part 24, Section 24.232			
Test mode: Compliance	Verdict: PASS		
Date: 6/24/2007			
Temperature: 27°C	Air Pressure: 1010 hPa	Relative Humidity: 42 %	Power Supply: 5 VDC
Remarks:			

Table 8.1.2 Peak output power test results

OPERATING FREQUENCY RANGE: 1850 - 1910 MHz
DETECTOR USED: Peak
RESOLUTION BANDWIDTH: 1 MHz
VIDEO BANDWIDTH: 3 MHz
MODULATION: GMSK
MODULATING SIGNAL: PRBS
BIT RATE: 270 kbps
TRANSMITTER OUTPUT POWER SETTINGS: Maximum

Carrier frequency, MHz	Spectrum analyzer reading, dBm	External attenuation, dB	Cable loss, dB	RF output power, dBm	Limit, dBm	Margin, dB	Verdict
1850.2	30.74	Included	Included	30.74	33.0	-2.26	Pass
1880.0	30.54	Included	Included	30.54	33.0	-2.46	Pass
1909.8	30.78	Included	Included	30.78	33.0	-2.22	Pass

Reference numbers of test equipment used

HL 2910	HL 2910	HL 3001	HL 3178	HL 3182			
---------	---------	---------	---------	---------	--	--	--

Full description is given in Appendix A.

Plot 8.1.1 Peak output power test results at low frequency

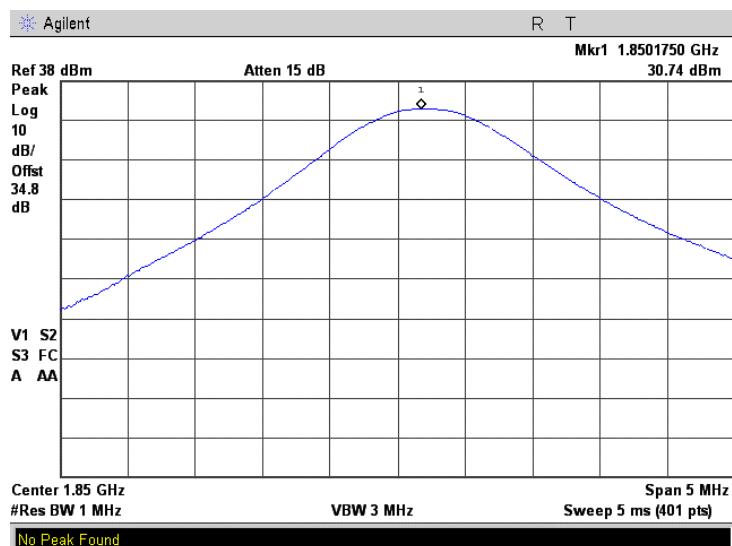

Test specification:	Section 24.232, Peak output power		
Test procedure:	FCC part 24, Section 24.232		
Test mode:	Compliance	Verdict:	PASS
Date:	6/24/2007		
Temperature: 27°C	Air Pressure: 1010 hPa	Relative Humidity: 42 %	Power Supply: 5 VDC
Remarks:			

Plot 8.1.2 Peak output power test results at mid frequency

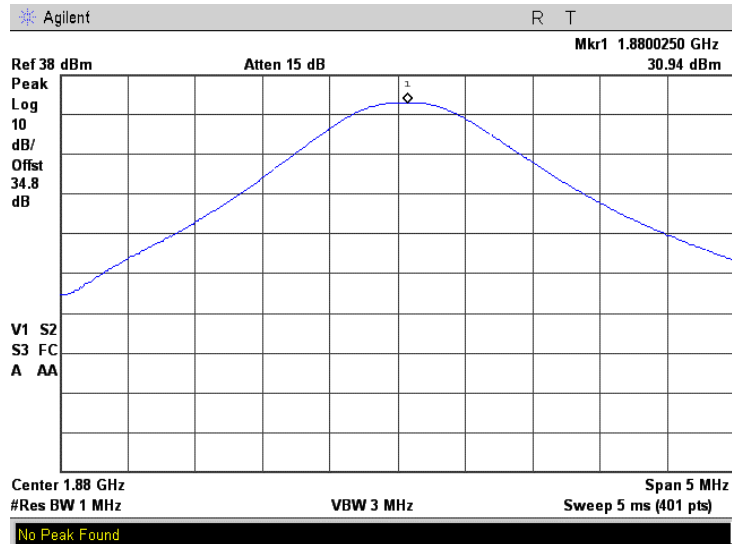

Plot 8.1.3 Peak output power test results at high frequency

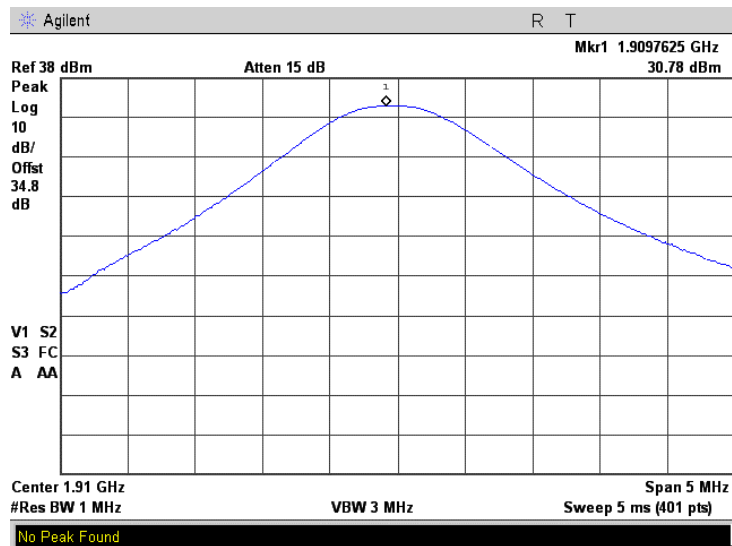

Test specification:	Section 24.238(b), Occupied bandwidth		
Test procedure:	FCC part 24, Section 24.238		
Test mode:	Compliance	Verdict:	PASS
Date:	6/25/2007		
Temperature: 26°C	Air Pressure: 1010 hPa	Relative Humidity: 40 %	Power Supply: 5 VDC
Remarks:			

8.2 Occupied bandwidth test

8.2.1 General

This test was performed to measure transmitter occupied bandwidth. Specification test limits are given in Table 8.2.1

Table 8.2.1 Occupied bandwidth limits

Assigned frequency, MHz	Modulation envelope reference points*, dBc
1850 – 1910	26

* - Modulation envelope reference points are provided in terms of attenuation below the unmodulated carrier.

8.2.2 Test procedure

- 8.2.2.1 The EUT was set up as shown in Figure 8.2.1, energized and its proper operation was checked.
- 8.2.2.2 The EUT was set to transmit the unmodulated carrier and the reference peak power level was measured.
- 8.2.2.3 The EUT was set to transmit the normally modulated carrier.
- 8.2.2.4 The transmitter occupied bandwidth was measured with spectrum analyzer as a frequency delta between the reference points on modulation envelope and the results provided in Table 8.2.2 and the associated plots.

Figure 8.2.1 Occupied bandwidth test setup

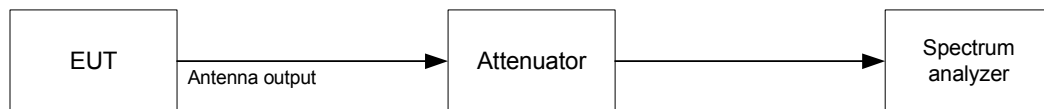

Photograph 8.2.2 Occupied bandwidth test setup



Test specification:	Section 24.238(b), Occupied bandwidth		
Test procedure:	FCC part 24, Section 24.238		
Test mode:	Compliance	Verdict:	PASS
Date:	6/25/2007		
Temperature: 26°C	Air Pressure: 1010 hPa	Relative Humidity: 40 %	Power Supply: 5 VDC
Remarks:			

Table 8.2.2 Occupied bandwidth test results

DETECTOR USED: Peak hold
 RESOLUTION BANDWIDTH: 3 kHz
 VIDEO BANDWIDTH: 10 kHz
 MODULATION ENVELOPE REFERENCE POINTS: 26 dBc
 MODULATION: GMSK
 MODULATING SIGNAL: PRBS
 BIT RATE: 270 kbps

Carrier frequency, MHz	Occupied bandwidth, kHz
1850.2	262.5
1880.0	277.5
1909.8	267.5

Reference numbers of test equipment used

HL 2910	HL 2912	HL 3001	HL 3178	HL 3182		
---------	---------	---------	---------	---------	--	--

Full description is given in Appendix A.

Test specification:	Section 24.238(b), Occupied bandwidth		
Test procedure:	FCC part 24, Section 24.238		
Test mode:	Compliance	Verdict:	PASS
Date:	6/25/2007		
Temperature: 26°C	Air Pressure: 1010 hPa	Relative Humidity: 40 %	Power Supply: 5 VDC
Remarks:			

Plot 8.2.1 Occupied bandwidth test result at low frequency, reference level

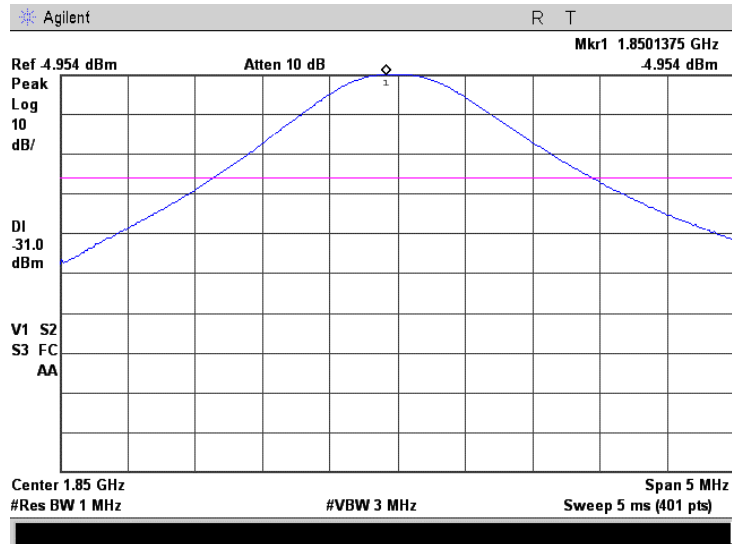

Plot 8.2.2 Occupied bandwidth test result at low frequency

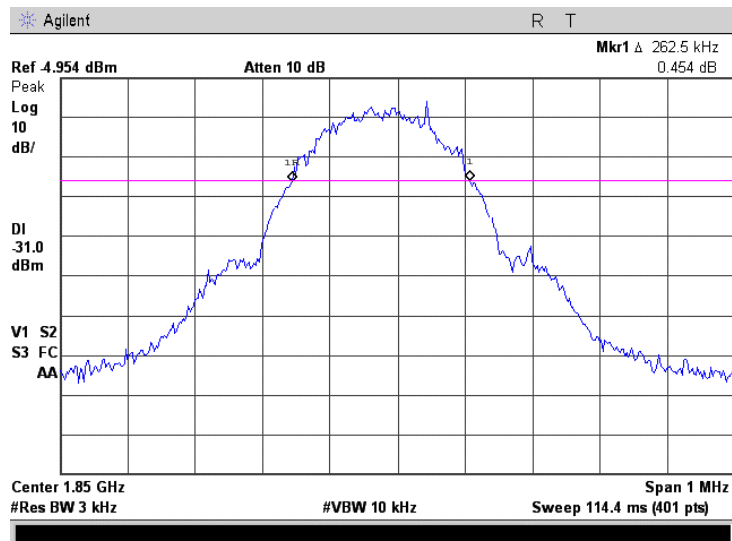

Test specification:	Section 24.238(b), Occupied bandwidth		
Test procedure:	FCC part 24, Section 24.238		
Test mode:	Compliance	Verdict:	PASS
Date:	6/25/2007		
Temperature: 26°C	Air Pressure: 1010 hPa	Relative Humidity: 40 %	Power Supply: 5 VDC
Remarks:			

Plot 8.2.3 Occupied bandwidth test result at mid frequency, reference level

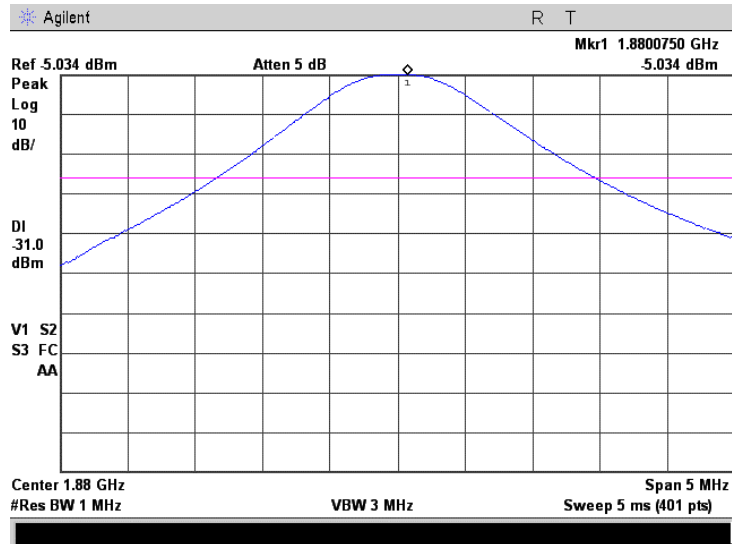

Plot 8.2.4 Occupied bandwidth test result at mid frequency

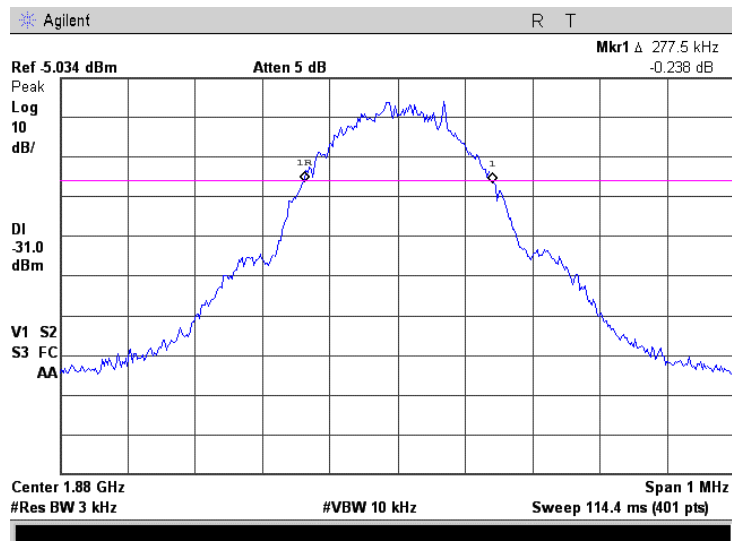

Test specification:	Section 24.238(b), Occupied bandwidth		
Test procedure:	FCC part 24, Section 24.238		
Test mode:	Compliance	Verdict:	PASS
Date:	6/25/2007		
Temperature: 26°C	Air Pressure: 1010 hPa	Relative Humidity: 40 %	Power Supply: 5 VDC
Remarks:			

Plot 8.2.5 Occupied bandwidth test result at high frequency, reference level

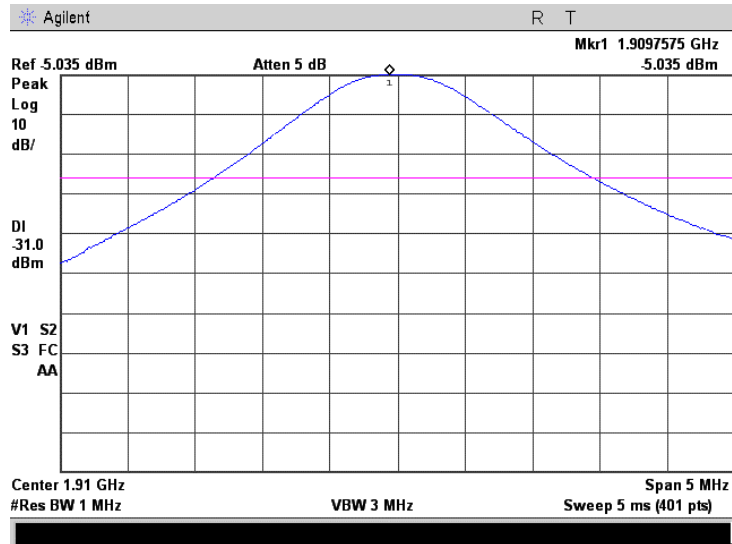

Plot 8.2.6 Occupied bandwidth test result at high frequency

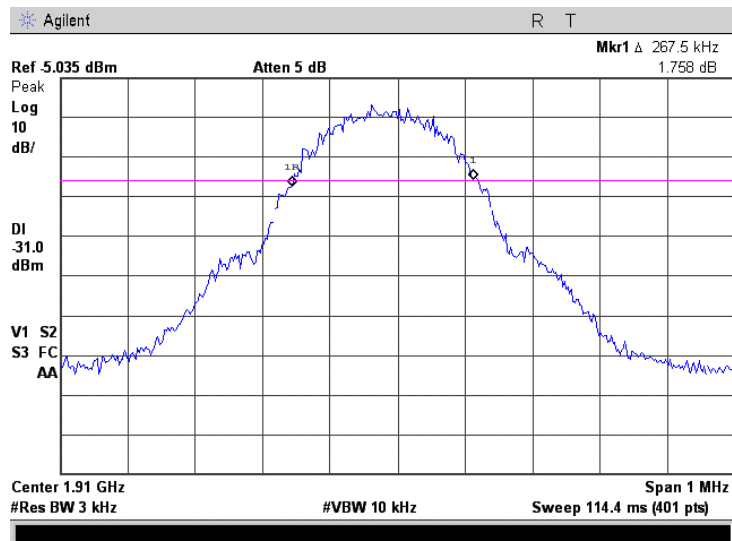

Test specification:	Section 24.238, Spurious emission at antenna terminal		
Test procedure:	FCC part 24, Section 24.238		
Test mode:	Compliance	Verdict:	PASS
Date:	6/25/2007		
Temperature: 26°C	Air Pressure: 1010 hPa	Relative Humidity: 40 %	Power Supply: 5 VDC
Remarks:			

8.3 Spurious emissions at RF antenna connector test

8.3.1 General

This test was performed to measure spurious emissions at RF antenna connector. Specification test limits are given in Table 8.3.1.

Table 8.3.1 Spurious emission limits

Frequency, MHz	Attenuation below carrier, dBc	ERP of spurious, dBm
0.009 – 10 th harmonic*	43+10logP*	-13.0

8.3.2 Test procedure

8.3.2.1 The EUT was set up as shown in Figure 8.3.1, energized and its proper operation was checked.

8.3.2.2 The EUT was adjusted to produce maximum available for end user RF output power.

8.3.2.3 The spurious emission was measured with spectrum analyzer as provided in Table 8.3.2 and associated plots.

Figure 8.3.1 Spurious emission test setup

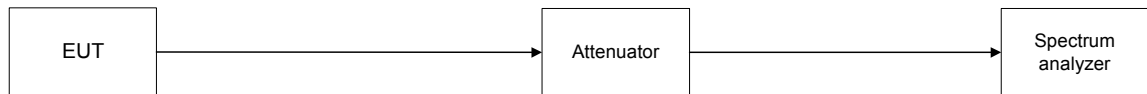

Photograph 8.3.1 Spurious emission test setup



Test specification:	Section 24.238, Spurious emission at antenna terminal		
Test procedure:	FCC part 24, Section 24.238		
Test mode:	Compliance	Verdict:	PASS
Date:	6/25/2007		
Temperature: 26°C	Air Pressure: 1010 hPa	Relative Humidity: 40 %	Power Supply: 5 VDC
Remarks:			

Table 8.3.2 Spurious emission test results

ASSIGNED FREQUENCY RANGE: 1850-1910 MHz
 INVESTIGATED FREQUENCY RANGE: 0.009-20000 MHz
 DETECTOR USED: Peak
 VIDEO BANDWIDTH: ≥ Resolution bandwidth
 MODULATION: GMSK
 MODULATING SIGNAL: PRBS
 BIT RATE: 270 kbps
 TRANSMITTER OUTPUT POWER SETTINGS: Maximum
 TRANSMITTER OUTPUT POWER: 30.74 dBm at low frequency
 30.54 dBm at mid frequency
 30.78 dBm at high frequency

Frequency, MHz	SA reading, dBm	Attenuator, dB	Cable loss, dB	RBW, kHz	Spurious emission, dBm	Attenuation below carrier, dBc	Limit, dBc	Margin, dB*	Verdict
Low carrier frequency									
1849.99	-15.39	Included	Included	3.0	-15.39	46.13	43.74	2.39	Pass
Mid carrier frequency									
No spurious were found									Pass
High carrier frequency									
1910.00	-13.31	Included	Included	3.0	-13.31	44.09	43.78	0.31	Pass

*- Margin = Spurious emission – specification limit.

Reference numbers of test equipment used

HL 2910	HL 2912	HL 3001	HL 3178	HL 3182	
---------	---------	---------	---------	---------	--

Full description is given in Appendix A.

Test specification:		Section 24.238, Spurious emission at antenna terminal	
Test procedure:		FCC part 24, Section 24.238	
Test mode:	Compliance	Verdict:	PASS
Date:	6/25/2007		
Temperature: 26°C	Air Pressure: 1010 hPa	Relative Humidity: 40 %	Power Supply: 5 VDC
Remarks:			

Plot 8.3.1 Spurious emission measurements in 9 - 150 kHz range at low carrier frequency

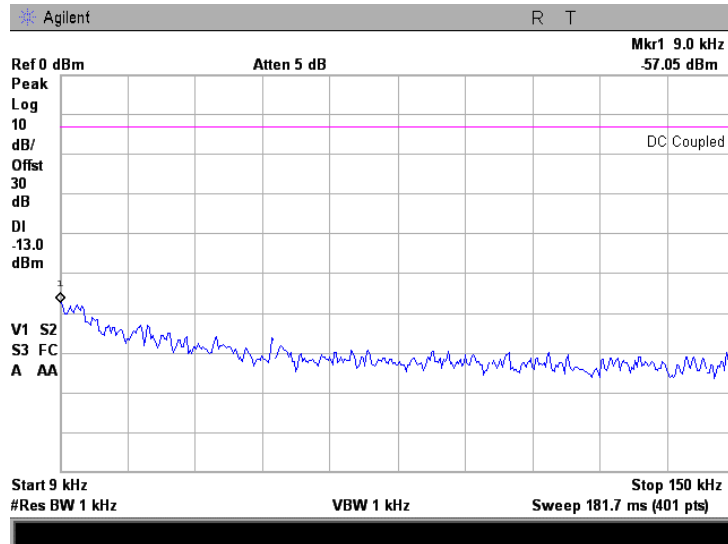

Plot 8.3.2 Spurious emission measurements in 9 - 150 kHz range at mid carrier frequency

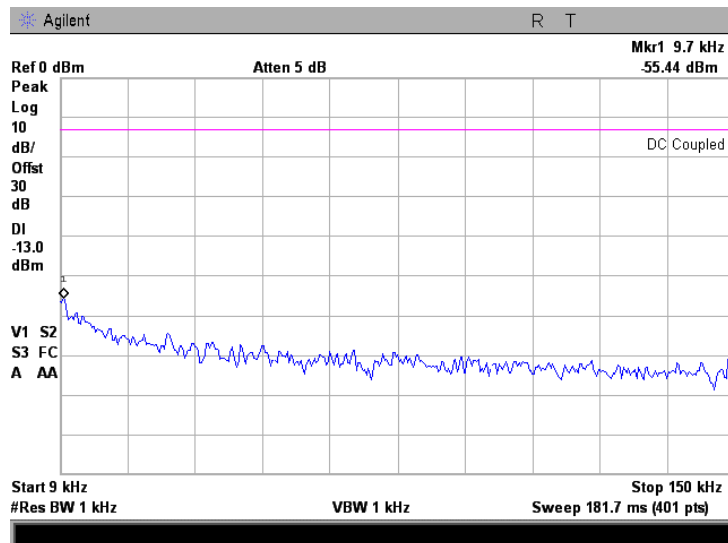

Test specification:	Section 24.238, Spurious emission at antenna terminal		
Test procedure:	FCC part 24, Section 24.238		
Test mode:	Compliance	Verdict:	PASS
Date:	6/25/2007		
Temperature: 26°C	Air Pressure: 1010 hPa	Relative Humidity: 40 %	Power Supply: 5 VDC
Remarks:			

Plot 8.3.3 Spurious emission measurements in 9 - 150 kHz range at high carrier frequency

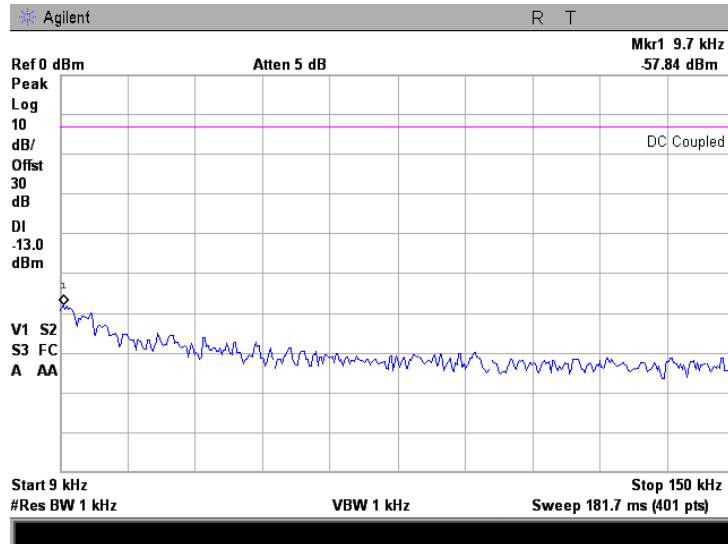

Plot 8.3.4 Spurious emission measurements in 0.15 - 30.0 MHz range at low carrier frequency

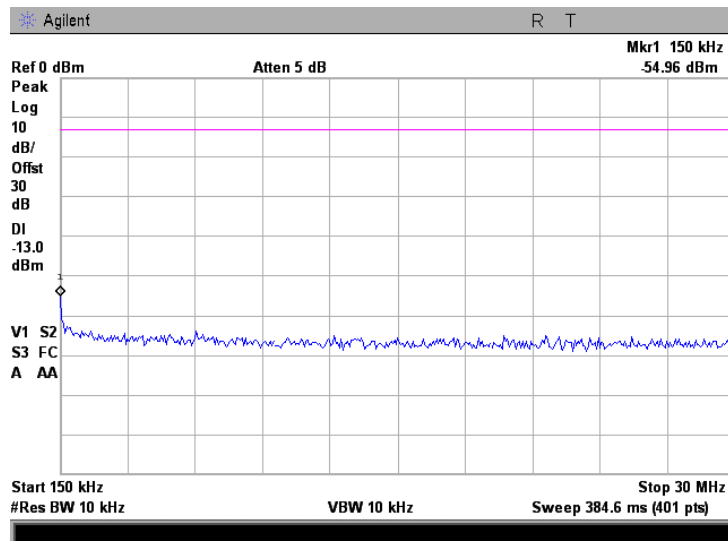

Test specification:	Section 24.238, Spurious emission at antenna terminal		
Test procedure:	FCC part 24, Section 24.238		
Test mode:	Compliance	Verdict:	PASS
Date:	6/25/2007		
Temperature: 26°C	Air Pressure: 1010 hPa	Relative Humidity: 40 %	Power Supply: 5 VDC
Remarks:			

Plot 8.3.5 Spurious emission measurements in 0.15 - 30.0 MHz range at mid carrier frequency

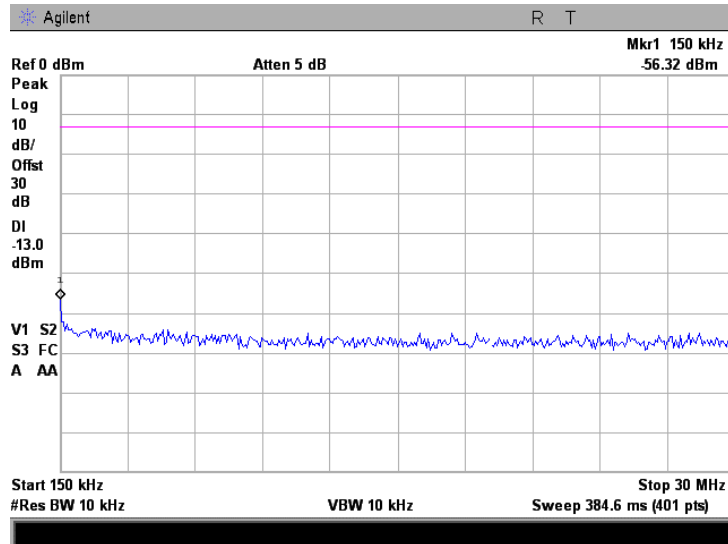

Plot 8.3.6 Spurious emission measurements in 0.15 – 30.0 MHz range at high carrier frequency

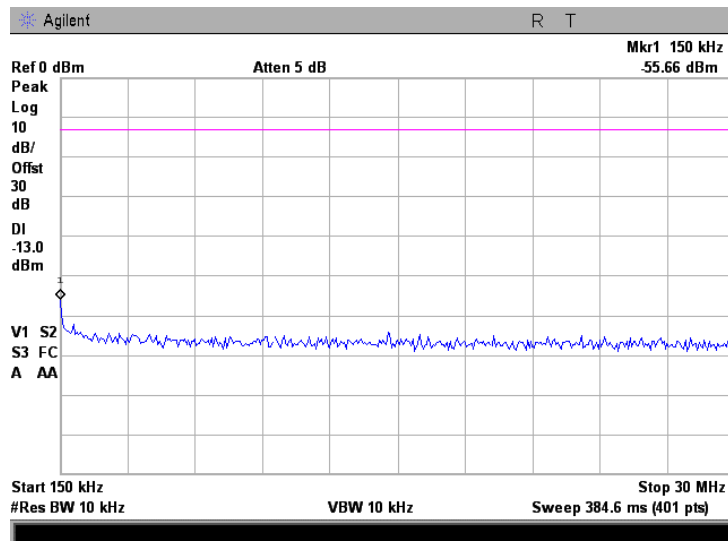

Test specification: Section 24.238, Spurious emission at antenna terminal			
Test procedure: FCC part 24, Section 24.238			
Test mode: Compliance	Verdict: PASS		
Date: 6/25/2007			
Temperature: 26°C	Air Pressure: 1010 hPa	Relative Humidity: 40 %	Power Supply: 5 VDC
Remarks:			

Plot 8.3.7 Spurious emission measurements in 30.0 - 500 MHz range at low carrier frequency

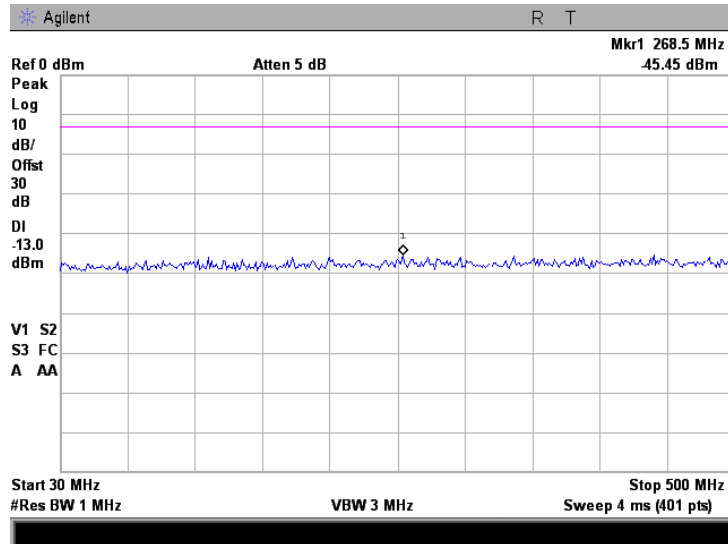

Plot 8.3.8 Spurious emission measurements in 30.0 - 500 MHz range at mid carrier frequency

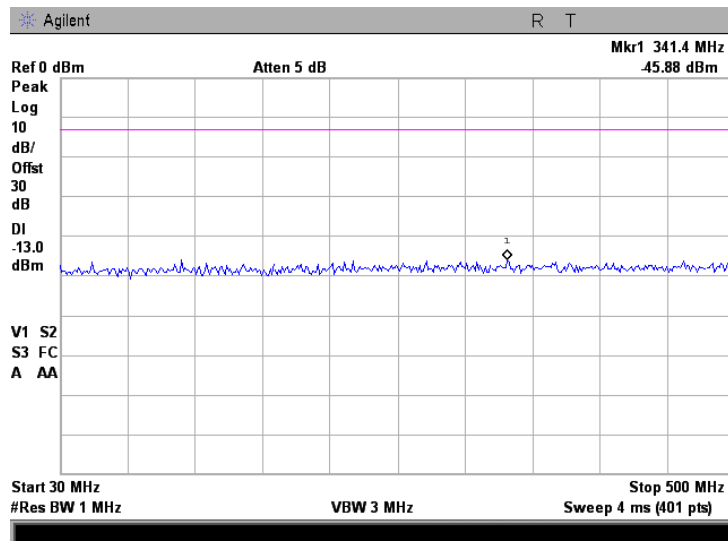

Test specification:	Section 24.238, Spurious emission at antenna terminal		
Test procedure:	FCC part 24, Section 24.238		
Test mode:	Compliance	Verdict:	PASS
Date:	6/25/2007		
Temperature: 26°C	Air Pressure: 1010 hPa	Relative Humidity: 40 %	Power Supply: 5 VDC
Remarks:			

Plot 8.3.9 Spurious emission measurements in 30.0 - 500 MHz range at high carrier frequency

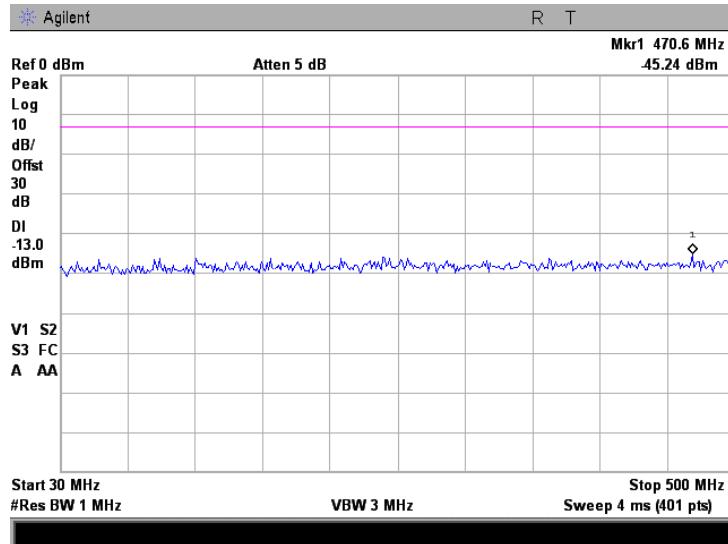

Plot 8.3.10 Spurious emission measurements in 500.0 - 1000 MHz range at low carrier frequency

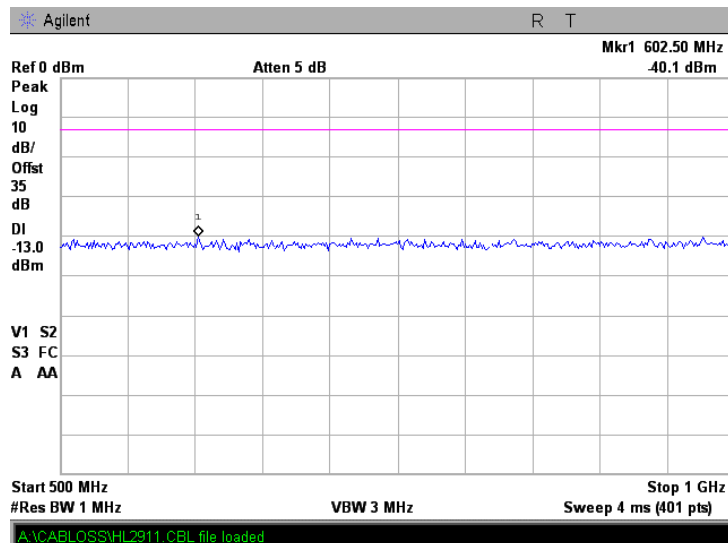

Test specification:		Section 24.238, Spurious emission at antenna terminal	
Test procedure:		FCC part 24, Section 24.238	
Test mode:	Compliance	Verdict:	PASS
Date:	6/25/2007		
Temperature: 26°C	Air Pressure: 1010 hPa	Relative Humidity: 40 %	Power Supply: 5 VDC
Remarks:			

Plot 8.3.11 Spurious emission measurements in 500.0 - 1000 MHz range at mid carrier frequency

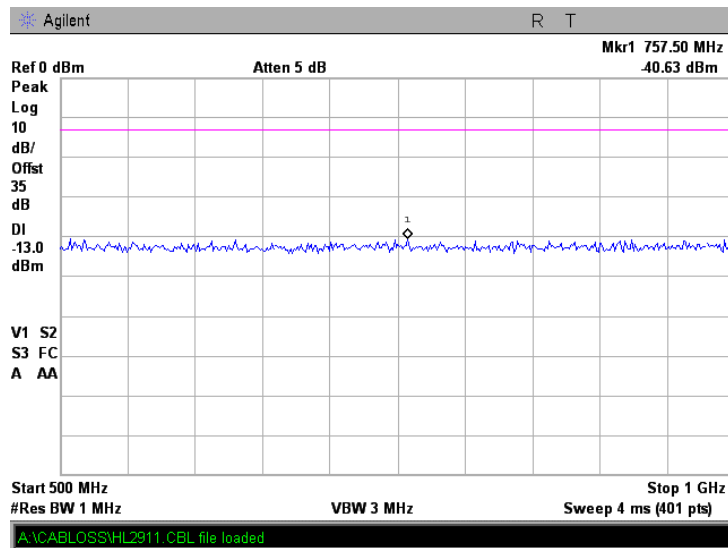

Plot 8.3.12 Spurious emission measurements in 500.0 - 1000 MHz range at high carrier frequency

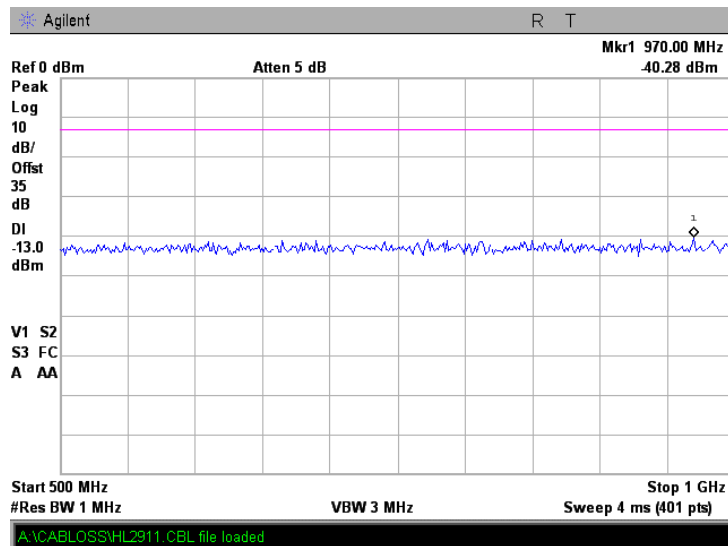

Test specification:	Section 24.238, Spurious emission at antenna terminal		
Test procedure:	FCC part 24, Section 24.238		
Test mode:	Compliance	Verdict:	PASS
Date:	6/25/2007		
Temperature: 26°C	Air Pressure: 1010 hPa	Relative Humidity: 40 %	Power Supply: 5 VDC
Remarks:			

Plot 8.3.13 Spurious emission measurements in 1000 -1849 MHz range at low carrier frequency

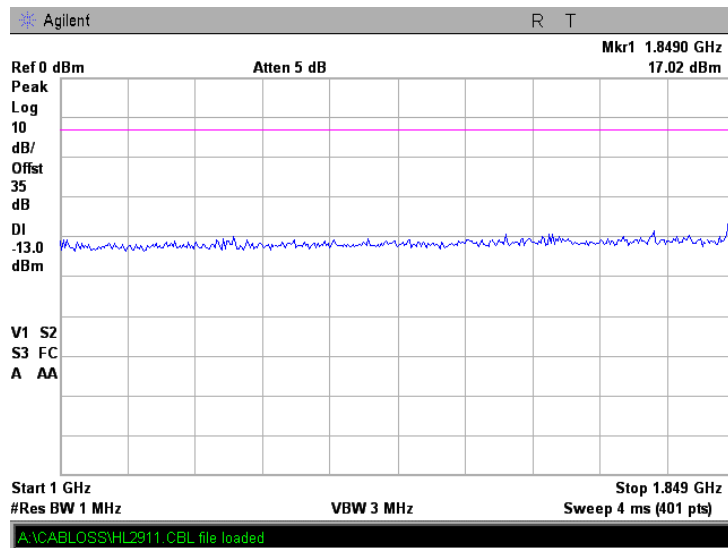

Plot 8.3.14 Spurious emission measurements in 1849 -1850 MHz range at low carrier frequency

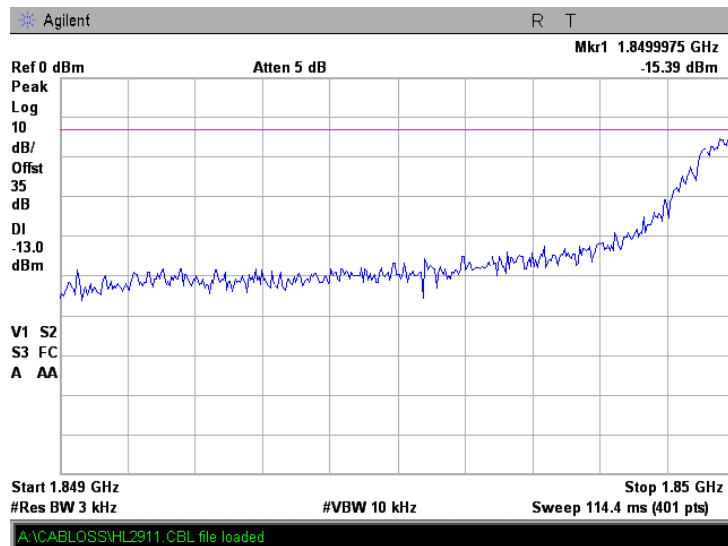

Test specification:	Section 24.238, Spurious emission at antenna terminal		
Test procedure:	FCC part 24, Section 24.238		
Test mode:	Compliance	Verdict:	PASS
Date:	6/25/2007		
Temperature: 26°C	Air Pressure: 1010 hPa	Relative Humidity: 40 %	Power Supply: 5 VDC
Remarks:			

Plot 8.3.15 Spurious emission measurements in 1000 – 1850 MHz range at mid carrier frequency

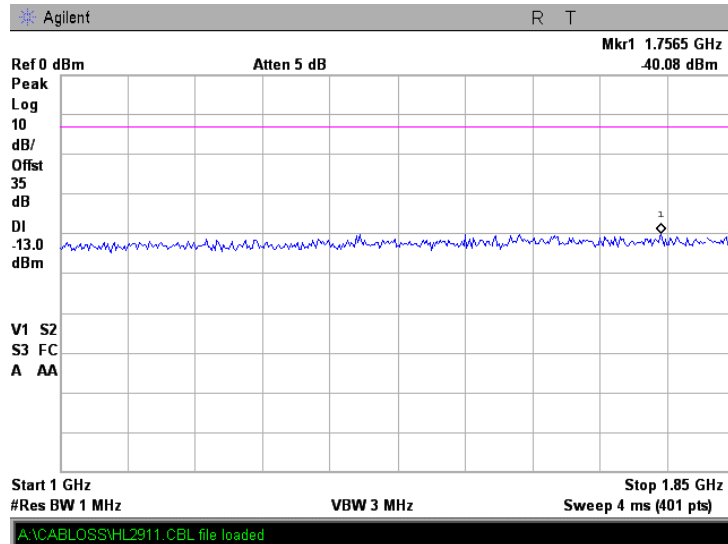

Plot 8.3.16 Spurious emission measurements in 1000 – 1850 MHz range at high carrier frequency

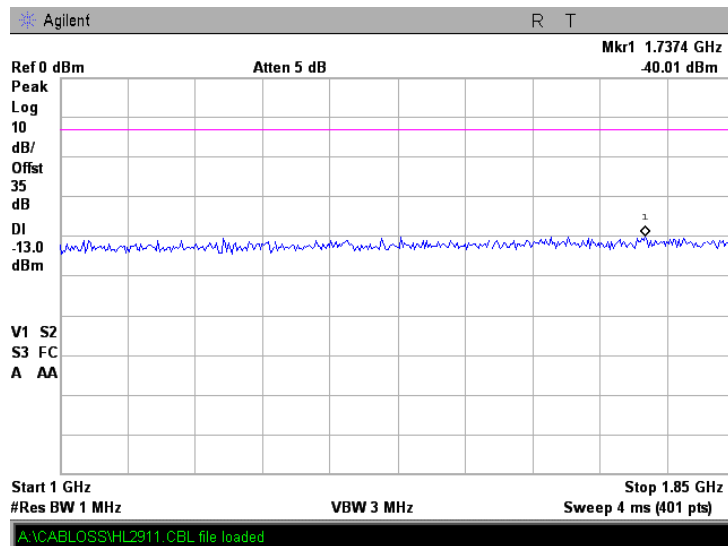

Test specification:	Section 24.238, Spurious emission at antenna terminal		
Test procedure:	FCC part 24, Section 24.238		
Test mode:	Compliance	Verdict:	PASS
Date:	6/25/2007		
Temperature: 26°C	Air Pressure: 1010 hPa	Relative Humidity: 40 %	Power Supply: 5 VDC
Remarks:			

Plot 8.3.17 Spurious emission measurements in 1910 -10000 MHz range at low carrier frequency

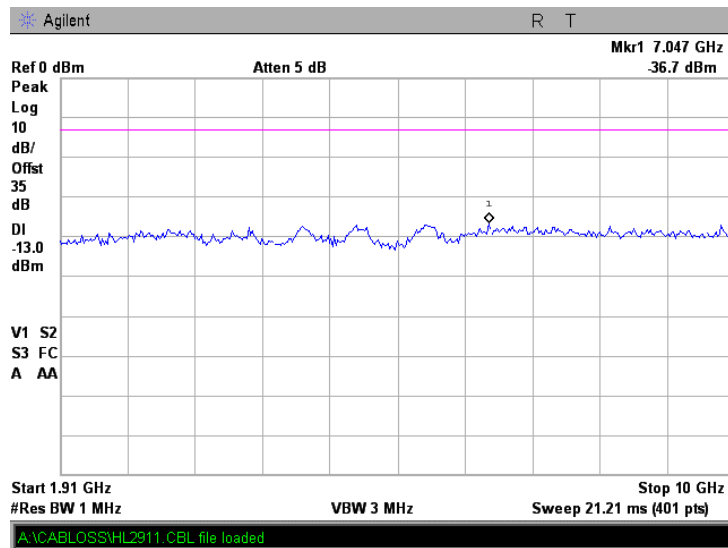

Test specification:	Section 24.238, Spurious emission at antenna terminal		
Test procedure:	FCC part 24, Section 24.238		
Test mode:	Compliance	Verdict:	PASS
Date:	6/25/2007		
Temperature: 26°C	Air Pressure: 1010 hPa	Relative Humidity: 40 %	Power Supply: 5 VDC
Remarks:			

Plot 8.3.18 Spurious emission measurements in 1910 – 10000 MHz range at mid carrier frequency

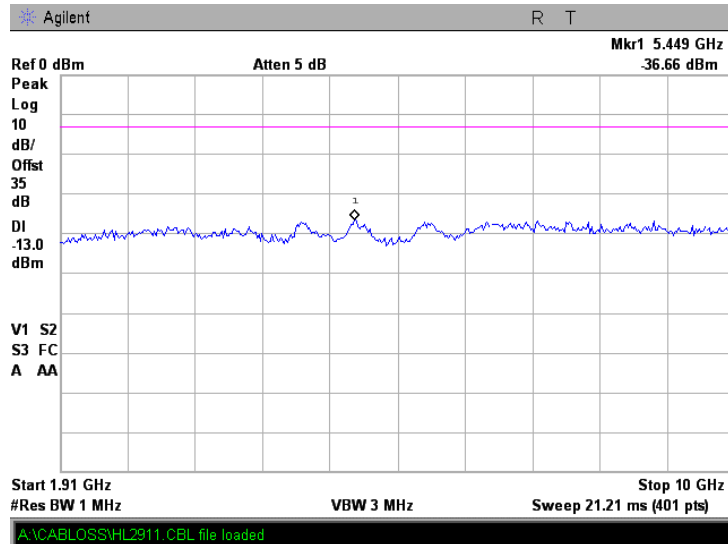

Plot 8.3.19 Spurious emission measurements in 1910 – 1911 MHz range at high carrier frequency

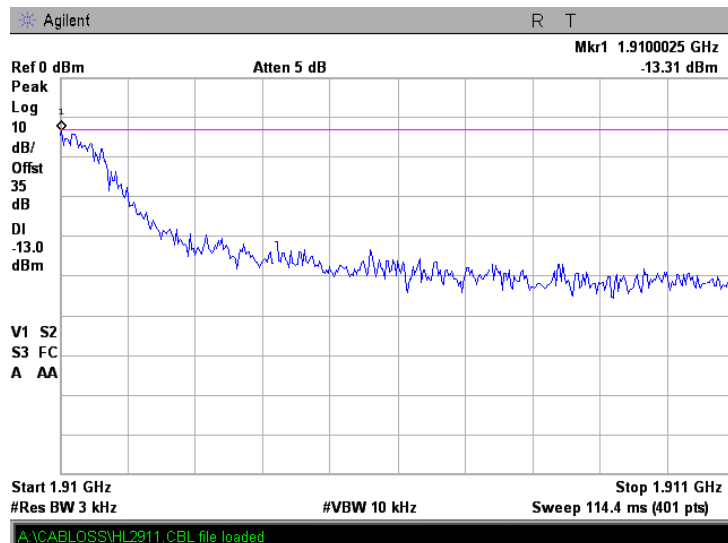

Test specification:	Section 24.238, Spurious emission at antenna terminal		
Test procedure:	FCC part 24, Section 24.238		
Test mode:	Compliance	Verdict:	PASS
Date:	6/25/2007		
Temperature: 26°C	Air Pressure: 1010 hPa	Relative Humidity: 40 %	Power Supply: 5 VDC
Remarks:			

Plot 8.3.20 Spurious emission measurements in 1911 – 10000 MHz range at high carrier frequency

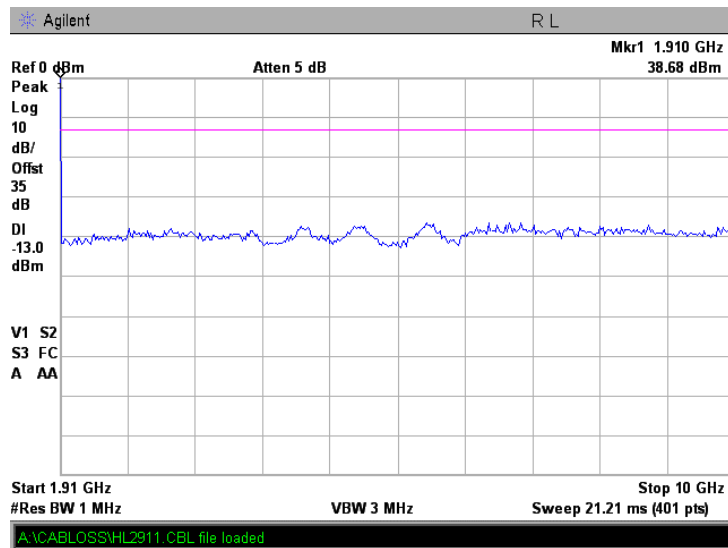

Plot 8.3.21 Spurious emission measurements in 10000 -20000 MHz range at low carrier frequency

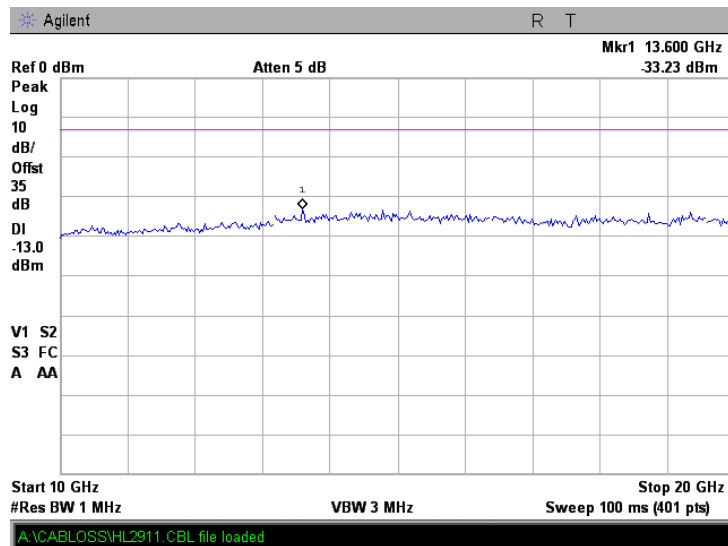

Test specification:	Section 24.238, Spurious emission at antenna terminal		
Test procedure:	FCC part 24, Section 24.238		
Test mode:	Compliance	Verdict:	PASS
Date:	6/25/2007		
Temperature: 26°C	Air Pressure: 1010 hPa	Relative Humidity: 40 %	Power Supply: 5 VDC
Remarks:			

Plot 8.3.22 Spurious emission measurements in 10000 – 20000 MHz range at mid carrier frequency

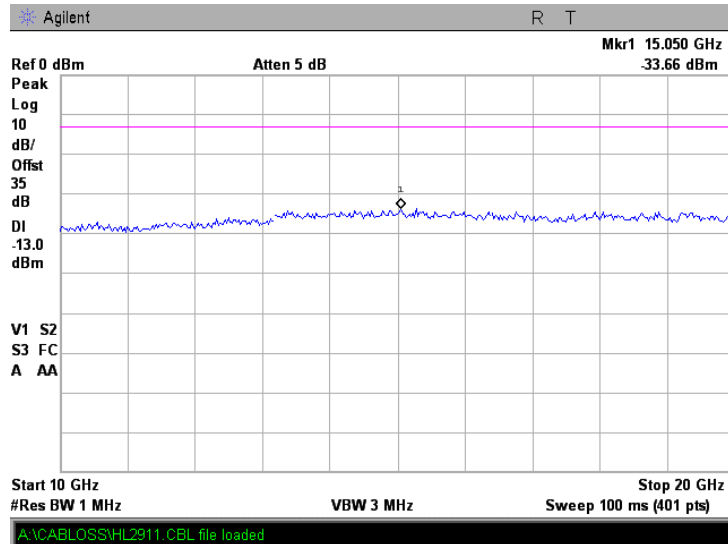

Plot 8.3.23 Spurious emission measurements in 10000 – 20000 MHz range at high carrier frequency

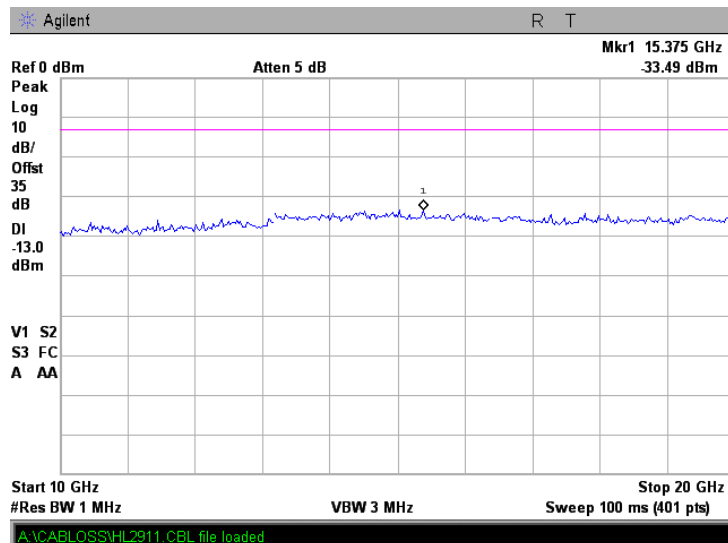

Test specification:	Section 24.238, Spurious emission at antenna terminal		
Test procedure:	FCC part 24, Section 24.238		
Test mode:	Compliance	Verdict:	PASS
Date:	6/25/2007		
Temperature: 26°C	Air Pressure: 1010 hPa	Relative Humidity: 40 %	Power Supply: 5 VDC
Remarks:			

Plot 8.3.24 Conducted spurious emission measurements at the 2nd harmonic of low carrier frequency

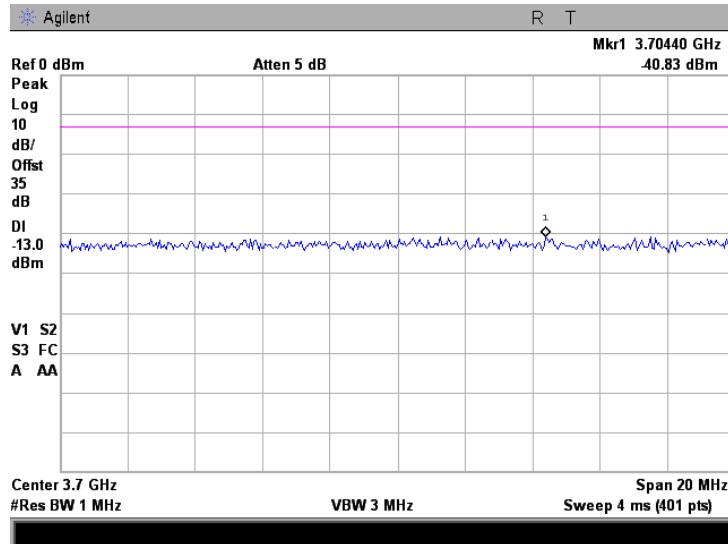

Plot 8.3.25 Conducted spurious emission measurements at the 2nd harmonic of mid carrier frequency

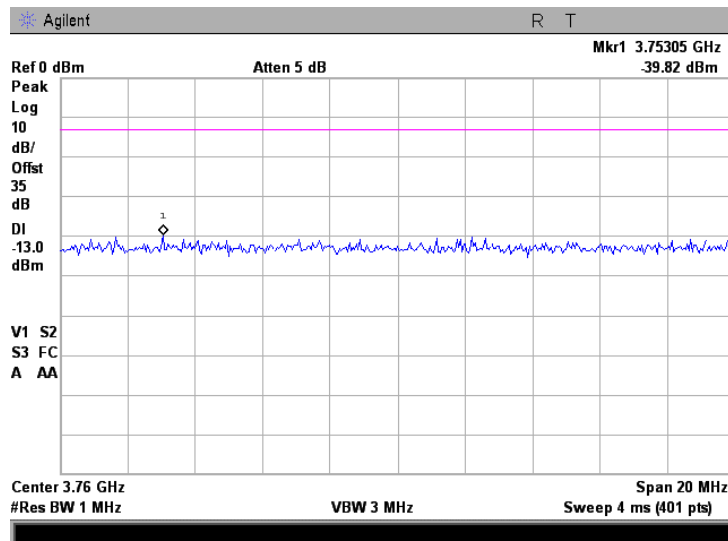

Test specification:	Section 24.238, Spurious emission at antenna terminal		
Test procedure:	FCC part 24, Section 24.238		
Test mode:	Compliance	Verdict:	PASS
Date:	6/25/2007		
Temperature: 26°C	Air Pressure: 1010 hPa	Relative Humidity: 40 %	Power Supply: 5 VDC
Remarks:			

Plot 8.3.26 Conducted spurious emission measurements at the 2nd harmonic of high carrier frequency

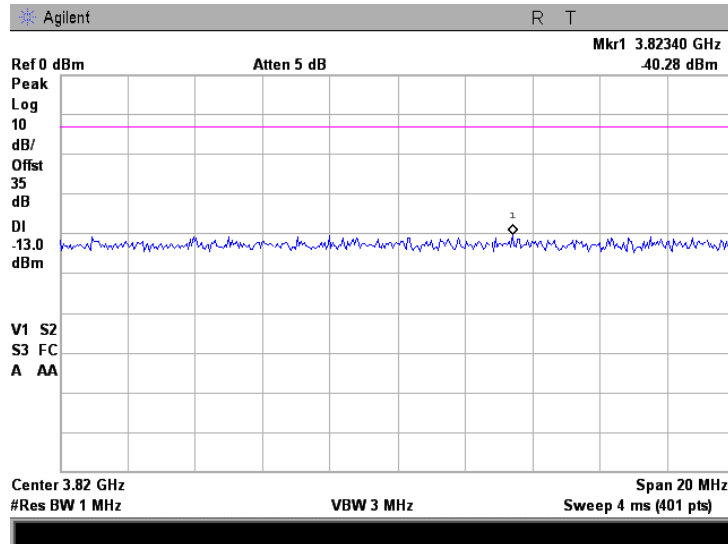

Plot 8.3.27 Conducted spurious emission measurements at the 3rd harmonic of low carrier frequency

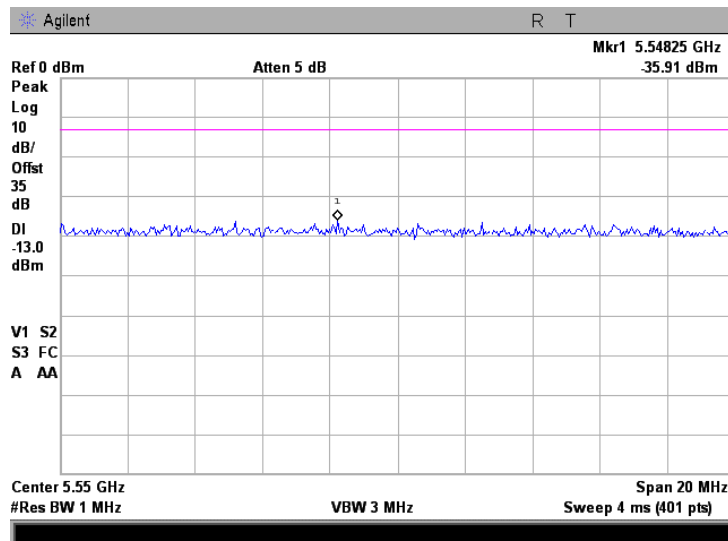

Test specification:		Section 24.238, Spurious emission at antenna terminal	
Test procedure:		FCC part 24, Section 24.238	
Test mode:	Compliance	Verdict:	PASS
Date:	6/25/2007		
Temperature: 26°C	Air Pressure: 1010 hPa	Relative Humidity: 40 %	Power Supply: 5 VDC
Remarks:			

Plot 8.3.28 Conducted spurious emission measurements at the 3rd harmonic of mid carrier frequency

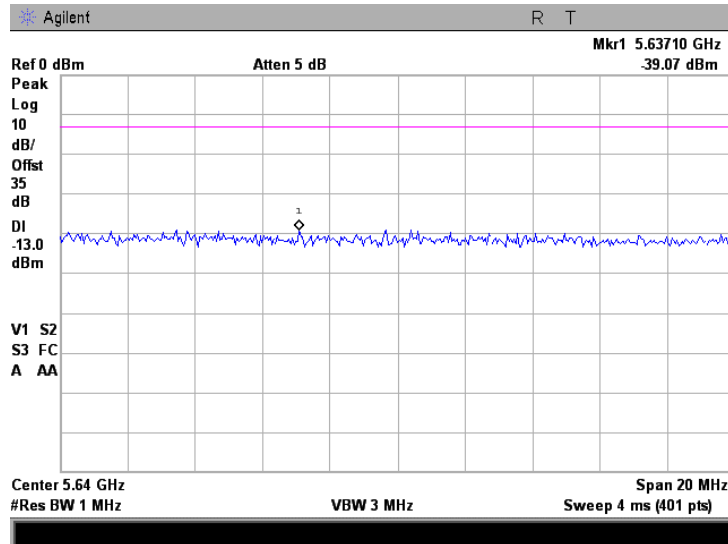

Plot 8.3.29 Conducted spurious emission measurements at the 3rd harmonic of high carrier frequency

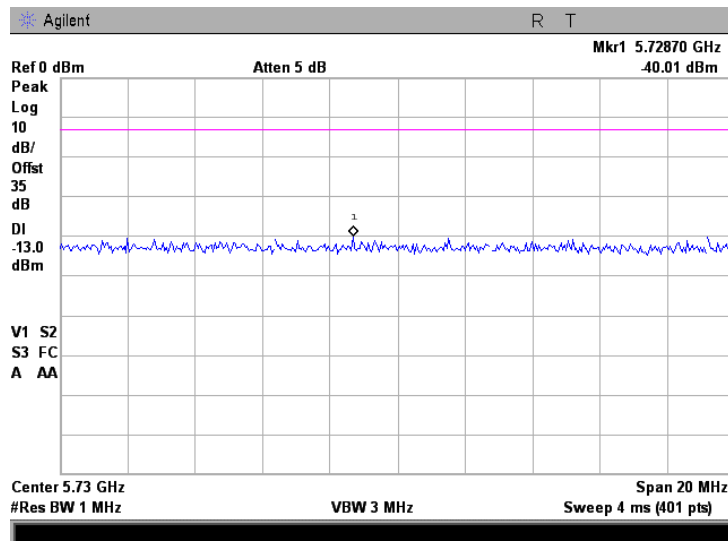

Test specification:	Section 24.238, Spurious emission at antenna terminal		
Test procedure:	FCC part 24, Section 24.238		
Test mode:	Compliance	Verdict:	PASS
Date:	6/25/2007		
Temperature: 26°C	Air Pressure: 1010 hPa	Relative Humidity: 40 %	Power Supply: 5 VDC
Remarks:			

Plot 8.3.30 Conducted spurious emission measurements at the 4th harmonic of low carrier frequency

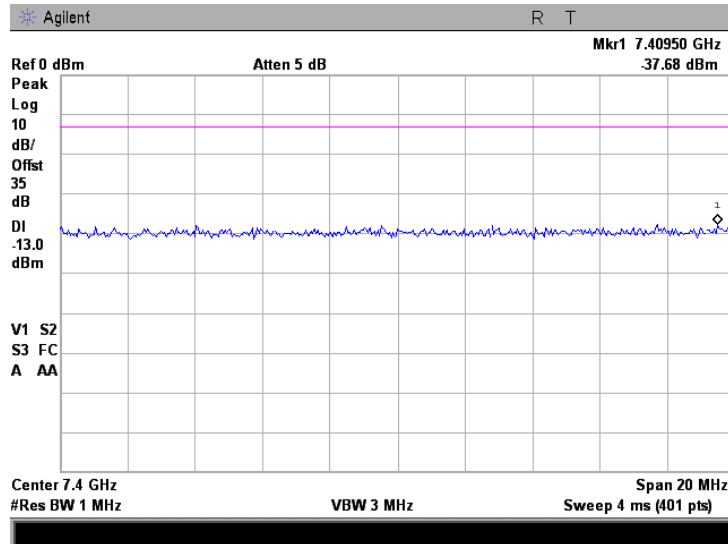

Plot 8.3.31 Conducted spurious emission measurements at the 4th harmonic of mid carrier frequency

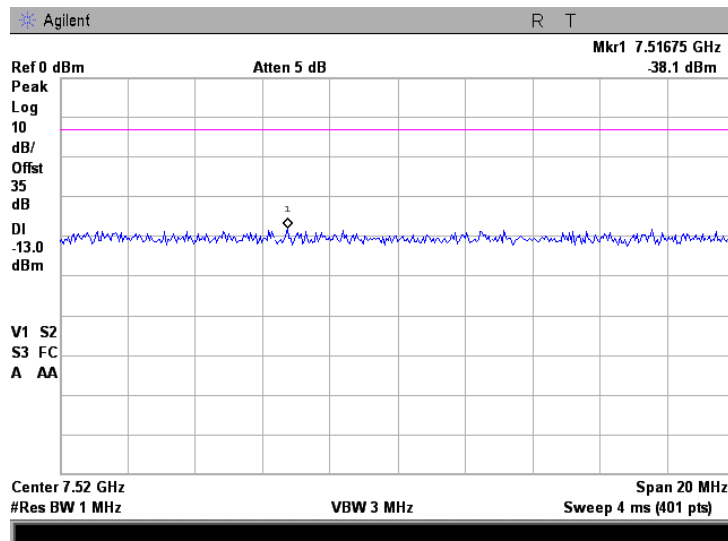

Test specification:	Section 24.238, Spurious emission at antenna terminal		
Test procedure:	FCC part 24, Section 24.238		
Test mode:	Compliance	Verdict:	PASS
Date:	6/25/2007		
Temperature: 26°C	Air Pressure: 1010 hPa	Relative Humidity: 40 %	Power Supply: 5 VDC
Remarks:			

Plot 8.3.32 Conducted spurious emission measurements at the 4th harmonic of high carrier frequency

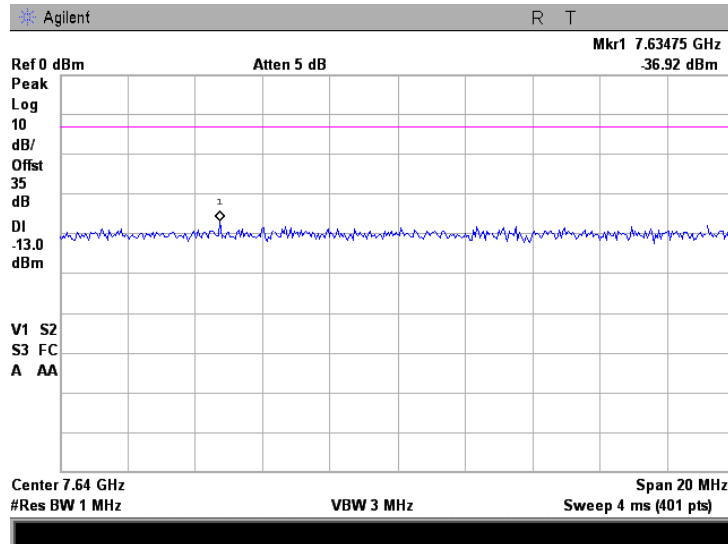

Plot 8.3.33 Conducted spurious emission measurements at the 5th harmonic of low carrier frequency

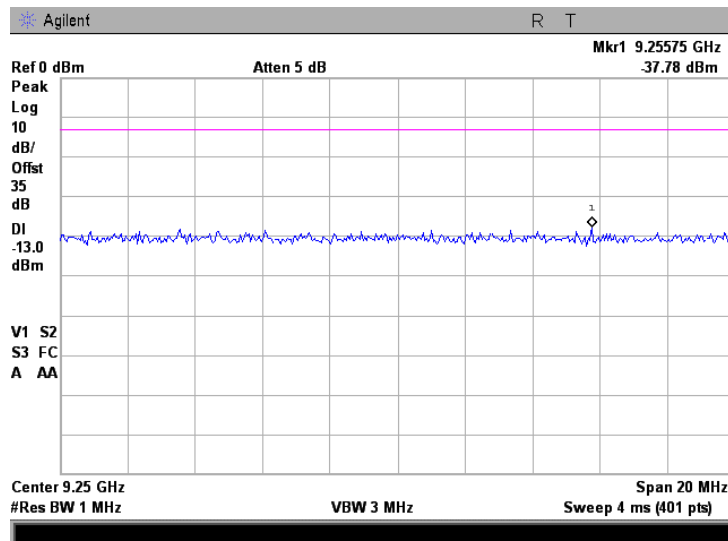

Test specification:	Section 24.238, Spurious emission at antenna terminal		
Test procedure:	FCC part 24, Section 24.238		
Test mode:	Compliance	Verdict:	PASS
Date:	6/25/2007		
Temperature: 26°C	Air Pressure: 1010 hPa	Relative Humidity: 40 %	Power Supply: 5 VDC
Remarks:			

Plot 8.3.34 Conducted spurious emission measurements at the 5th harmonic of mid carrier frequency

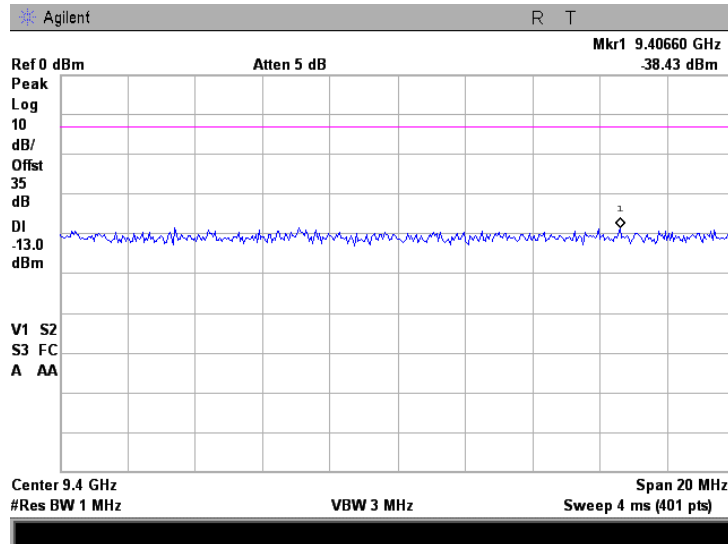

Plot 8.3.35 Conducted spurious emission measurements at the 5th harmonic of high carrier frequency

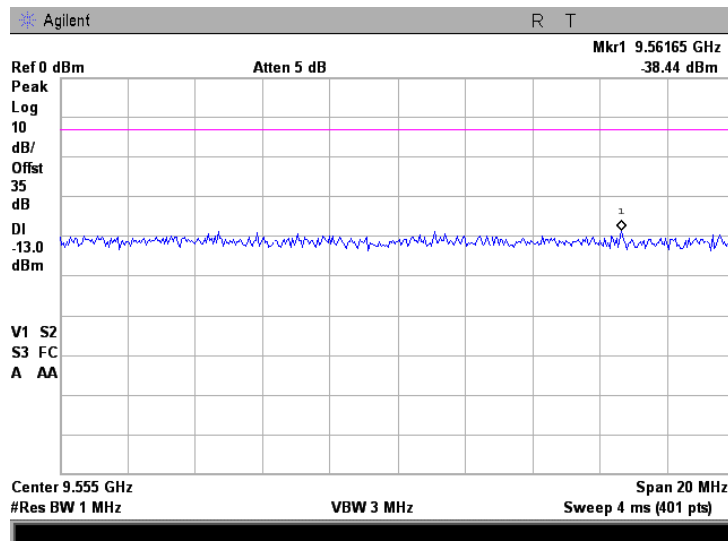

Test specification:	Section 24.238, Radiated spurious emissions		
Test procedure:	Public notice DA 00-705		
Test mode:	Compliance	Verdict:	PASS
Date:	6/24/2007		
Temperature: 27°C	Air Pressure: 1010 hPa	Relative Humidity: 42 %	Power Supply: 5 VDC
Remarks:			

8.4 Field strength of spurious emissions

8.4.1 General

This test was performed to measure field strength of spurious emissions from the EUT. Specification test limit is given in Table 8.4.1.

Table 8.4.1 Radiated spurious emissions limits

Frequency, MHz	Attenuation below carrier dBc	ERP of spurious, dBm	Equivalent field strength limit @ 3m, dB(μ V/m)**
0.009 – 10 th harmonic	43+10logP*	-13	84.4

* - P is transmitter output power in Watts.

** - Equivalent field strength limit was calculated from maximum allowed ERP of spurious as follows:
 $E = \sqrt{30 \times P \times 1.64} / r$, where P is ERP in Watts, 1.64 is numeric gain of ideal dipole and r is antenna to EUT distance in meters.

8.4.2 Test procedure for spurious emission field strength measurements in 9 kHz to 30 MHz band

8.4.2.1 The EUT was set up as shown in Figure 8.4.1, energized and the performance check was conducted.

8.4.2.2 The specified frequency range was investigated with antenna connected to spectrum analyzer/ EMI receiver. To find maximum radiation the turntable was rotated 360° and the measuring antenna was rotated around its vertical axis.

8.4.2.3 The worst test results (the lowest margins) were recorded and shown in the associated plots.

8.4.3 Test procedure for spurious emission field strength measurements above 30 MHz

8.4.3.1 The EUT was set up as shown in Figure 8.4.2, energized and the performance check was conducted.

8.4.3.2 The specified frequency range was investigated with antenna connected to spectrum analyzer/ EMI receiver. To find maximum radiation the turntable was rotated 360°, the measuring antenna height was changed from 1 to 4 m, its polarization was switched from vertical to horizontal.

8.4.3.3 The worst test results (the lowest margins) were recorded and shown in the associated plots.

Test specification:	Section 24.238, Radiated spurious emissions		
Test procedure:	Public notice DA 00-705		
Test mode:	Compliance	Verdict:	PASS
Date:	6/24/2007		
Temperature: 27°C	Air Pressure: 1010 hPa	Relative Humidity: 42 %	Power Supply: 5 VDC
Remarks:			

Figure 8.4.1 Setup for spurious emission field strength measurements below 30 MHz

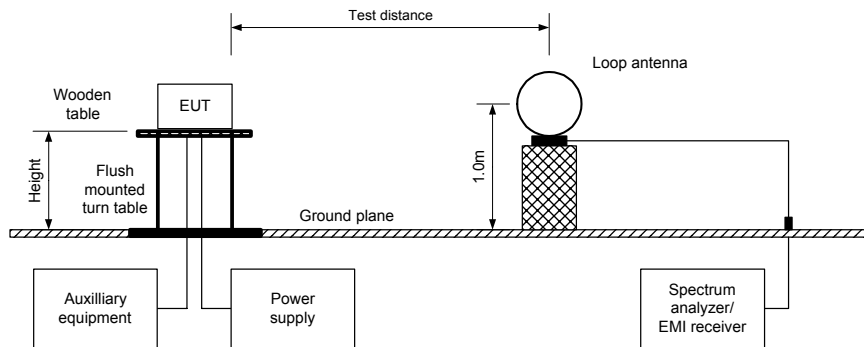

Photograph 8.4.1 Setup for spurious emission field strength measurements in 9 kHz to 30 MHz band



Test specification:	Section 24.238, Radiated spurious emissions		
Test procedure:	Public notice DA 00-705		
Test mode:	Compliance	Verdict:	PASS
Date:	6/24/2007		
Temperature: 27°C	Air Pressure: 1010 hPa	Relative Humidity: 42 %	Power Supply: 5 VDC
Remarks:			

Figure 8.4.2 Setup for spurious emission field strength measurements above 30 MHz

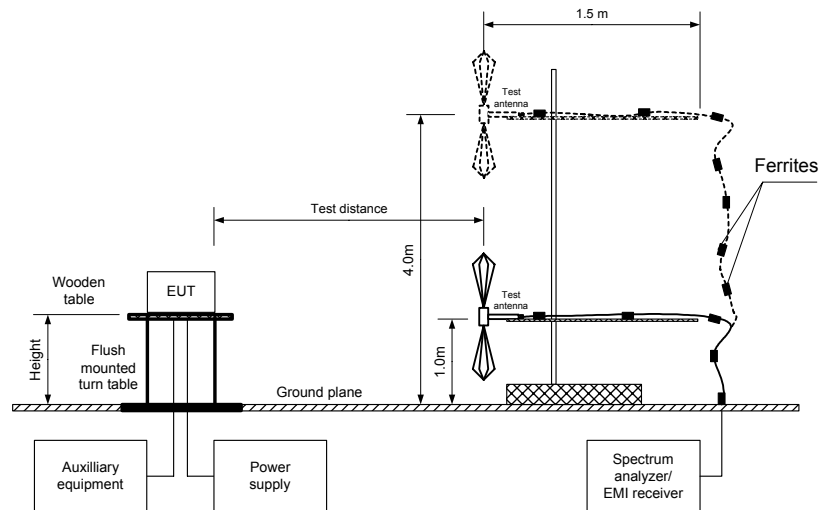

Photograph 8.4.2 Setup for spurious emission field strength measurements with double-ridged horn antenna



Test specification:	Section 24.238, Radiated spurious emissions		
Test procedure:	Public notice DA 00-705		
Test mode:	Compliance	Verdict:	PASS
Date:	6/24/2007		
Temperature: 27°C	Air Pressure: 1010 hPa	Relative Humidity: 42 %	Power Supply: 5 VDC
Remarks:			

Photograph 8.4.3 Setup for spurious emission field strength measurements, close view



Test specification:		Section 24.238, Radiated spurious emissions	
Test procedure:		Public notice DA 00-705	
Test mode:	Compliance	Verdict:	PASS
Date:	6/24/2007		
Temperature: 27°C	Air Pressure: 1010 hPa	Relative Humidity: 42 %	Power Supply: 5 VDC
Remarks:			

Table 8.4.2 Spurious emission field strength test results

ASSIGNED FREQUENCY RANGE: 1850-1910 MHz
TEST DISTANCE: 3 m
TEST SITE: Semi anechoic chamber / OATS
EUT HEIGHT: 0.8 m
INVESTIGATED FREQUENCY RANGE: 0.009 – 20000 MHz
DETECTOR USED: Peak
VIDEO BANDWIDTH: > Resolution bandwidth
TEST ANTENNA TYPE: Active loop (9 kHz – 30 MHz)
Biconical (30 MHz – 200 MHz)
Log periodic (200 MHz – 1000 MHz)
Biconilog (30 MHz – 1000 MHz)
Double ridged guide (above 1000 MHz)
MODULATION: GMSK
MODULATING SIGNAL: PRBS
BIT RATE: 270 kbps
TRANSMITTER OUTPUT POWER SETTINGS: Maximum

Frequency, MHz	Field strength, dB(μV/m)	Limit, dB(μV/m)	Margin, dB*	RBW, kHz	Antenna polarization	Antenna height, m	Turn-table position**, degrees
Low carrier frequency MHz							
All spurious are 20dB below limit							
Mid carrier frequency MHz							
All spurious are 20dB below limit							
High carrier frequency MHz							
All spurious are 20dB below limit							

*- Margin = Field strength of spurious – calculated field strength limit.

**- EUT front panel refers to 0 degrees position of turntable.

Reference numbers of test equipment used

HL 0446	HL 0521	HL 0589	HL 0604	HL 1984	HL 1947	HL 2009	HL 2259
HL 2909							

Full description is given in Appendix A.

Test specification:	Section 24.238, Radiated spurious emissions		
Test procedure:	Public notice DA 00-705		
Test mode:	Compliance	Verdict:	PASS
Date:	6/24/2007		
Temperature: 27°C	Air Pressure: 1010 hPa	Relative Humidity: 42 %	Power Supply: 5 VDC
Remarks:			

Plot 8.4.1 Radiated emission measurements in 9 - 150 kHz range

TEST SITE: Semi anechoic chamber
 CARRIER FREQUENCY: Low
 ANTENNA POLARIZATION: Vertical and Horizontal
 TEST DISTANCE: 3 m

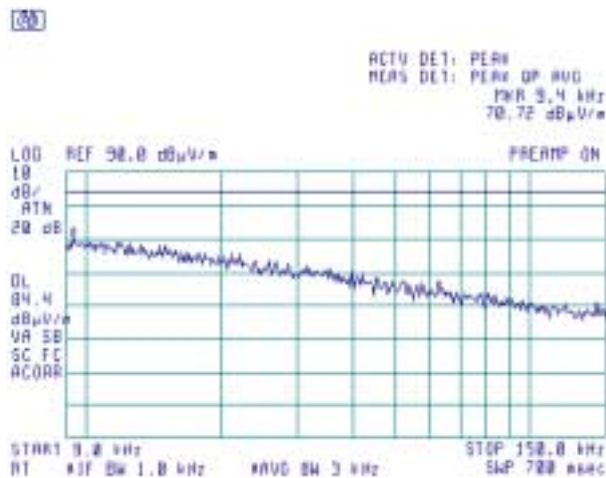

Plot 8.4.2 Radiated emission measurements in 9 - 150 kHz range

TEST SITE: Semi anechoic chamber
 CARRIER FREQUENCY: Mid
 ANTENNA POLARIZATION: Vertical and Horizontal
 TEST DISTANCE: 3 m

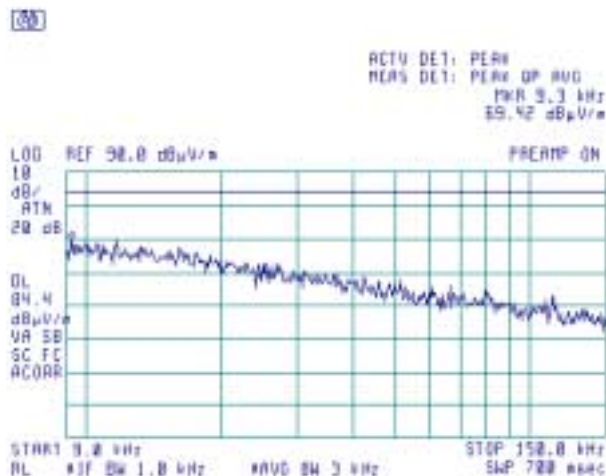

Test specification:	Section 24.238, Radiated spurious emissions		
Test procedure:	Public notice DA 00-705		
Test mode:	Compliance	Verdict:	PASS
Date:	6/24/2007		
Temperature: 27°C	Air Pressure: 1010 hPa	Relative Humidity: 42 %	Power Supply: 5 VDC
Remarks:			

Plot 8.4.3 Radiated emission measurements in 9 - 150 kHz range

TEST SITE: Semi anechoic chamber
 CARRIER FREQUENCY: High
 ANTENNA POLARIZATION: Vertical and Horizontal
 TEST DISTANCE: 3 m

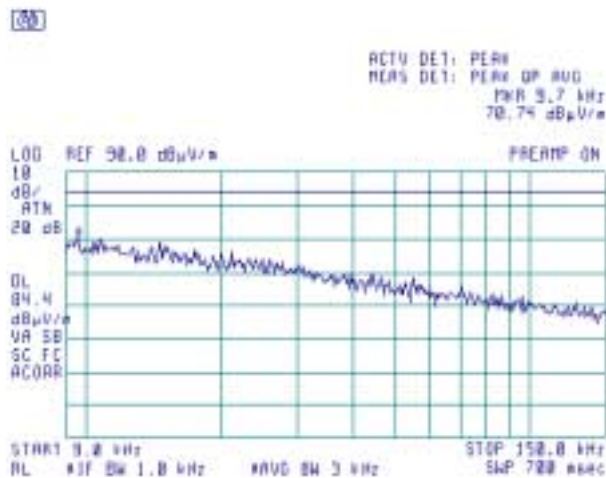

Plot 8.4.4 Radiated emission measurements in 0.15 - 30 MHz range

TEST SITE: Semi anechoic chamber
 CARRIER FREQUENCY: Low
 ANTENNA POLARIZATION: Vertical and Horizontal
 TEST DISTANCE: 3 m

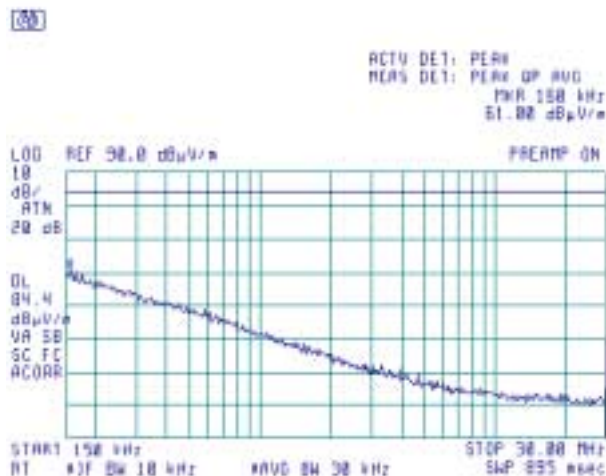

Test specification:	Section 24.238, Radiated spurious emissions		
Test procedure:	Public notice DA 00-705		
Test mode:	Compliance	Verdict:	PASS
Date:	6/24/2007		
Temperature: 27°C	Air Pressure: 1010 hPa	Relative Humidity: 42 %	Power Supply: 5 VDC
Remarks:			

Plot 8.4.5 Radiated emission measurements in 0.15 - 30 MHz range

TEST SITE: Semi anechoic chamber
CARRIER FREQUENCY: Mid
ANTENNA POLARIZATION: Vertical and Horizontal
TEST DISTANCE: 3 m

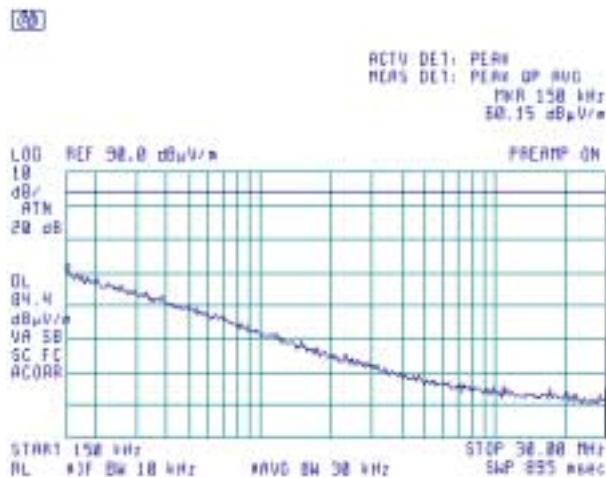

Plot 8.4.6 Radiated emission measurements in 0.15 - 30 MHz range

TEST SITE: Semi anechoic chamber
CARRIER FREQUENCY: High
ANTENNA POLARIZATION: Vertical and Horizontal
TEST DISTANCE: 3 m

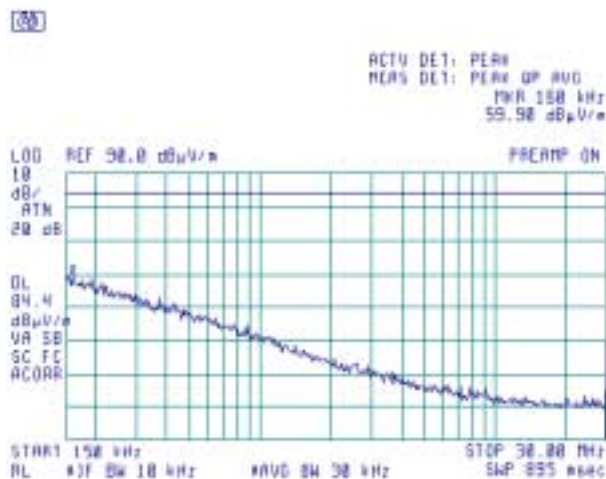

Test specification:	Section 24.238, Radiated spurious emissions		
Test procedure:	Public notice DA 00-705		
Test mode:	Compliance	Verdict:	PASS
Date:	6/24/2007		
Temperature: 27°C	Air Pressure: 1010 hPa	Relative Humidity: 42 %	Power Supply: 5 VDC
Remarks:			

Plot 8.4.7 Radiated emission measurements in 30 - 1000 MHz range

TEST SITE: Semi anechoic chamber
 CARRIER FREQUENCY: Low
 ANTENNA POLARIZATION: Vertical and Horizontal
 TEST DISTANCE: 3 m

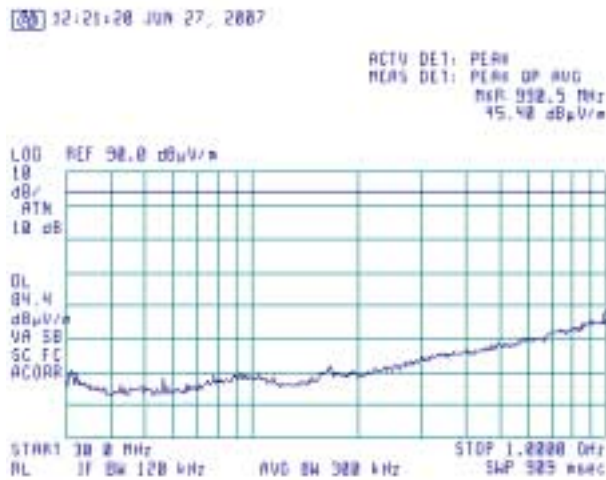

Plot 8.4.8 Radiated emission measurements in 30 - 1000 MHz range

TEST SITE: Semi anechoic chamber
 CARRIER FREQUENCY: Mid
 ANTENNA POLARIZATION: Vertical and Horizontal
 TEST DISTANCE: 3 m

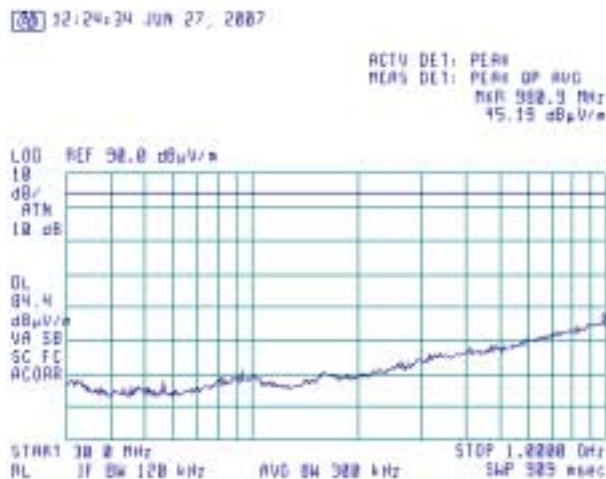

Test specification:	Section 24.238, Radiated spurious emissions		
Test procedure:	Public notice DA 00-705		
Test mode:	Compliance	Verdict:	PASS
Date:	6/24/2007		
Temperature: 27°C	Air Pressure: 1010 hPa	Relative Humidity: 42 %	Power Supply: 5 VDC
Remarks:			

Plot 8.4.9 Radiated emission measurements in 30 - 1000 MHz range

TEST SITE: Semi anechoic chamber
 CARRIER FREQUENCY: High
 ANTENNA POLARIZATION: Vertical and Horizontal
 TEST DISTANCE: 3 m

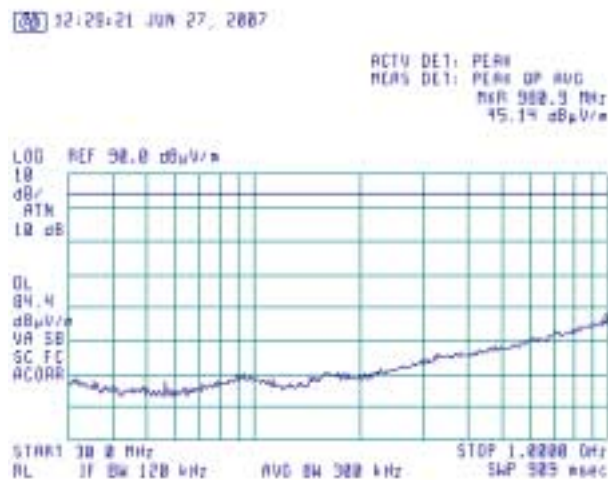

Plot 8.4.10 Radiated emission measurements in 1000 – 6500 MHz range

TEST SITE: Semi anechoic chamber
 CARRIER FREQUENCY: Low
 ANTENNA POLARIZATION: Vertical and Horizontal
 TEST DISTANCE: 3 m

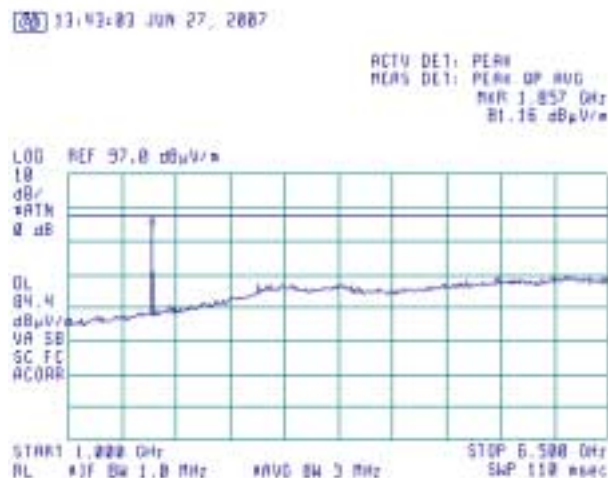

Test specification:	Section 24.238, Radiated spurious emissions		
Test procedure:	Public notice DA 00-705		
Test mode:	Compliance	Verdict:	PASS
Date:	6/24/2007		
Temperature: 27°C	Air Pressure: 1010 hPa	Relative Humidity: 42 %	Power Supply: 5 VDC
Remarks:			

Plot 8.4.11 Radiated emission measurements in 1000 – 6500 MHz range

TEST SITE: Semi anechoic chamber
CARRIER FREQUENCY: Mid
ANTENNA POLARIZATION: Vertical and Horizontal
TEST DISTANCE: 3 m

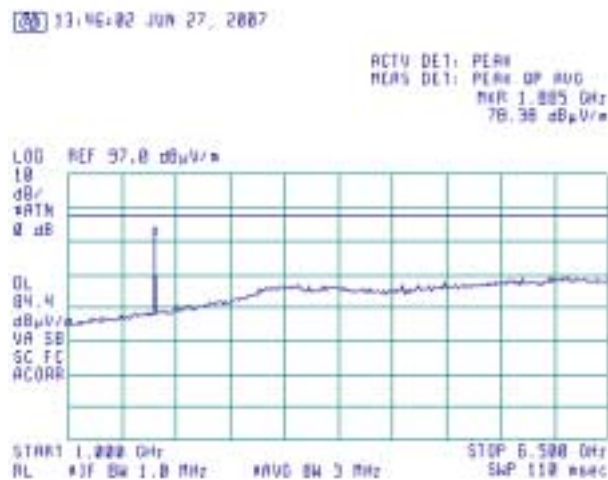

Plot 8.4.12 Radiated emission measurements in 1000 – 6500 MHz range

TEST SITE: Semi anechoic chamber
CARRIER FREQUENCY: High
ANTENNA POLARIZATION: Vertical and Horizontal
TEST DISTANCE: 3 m

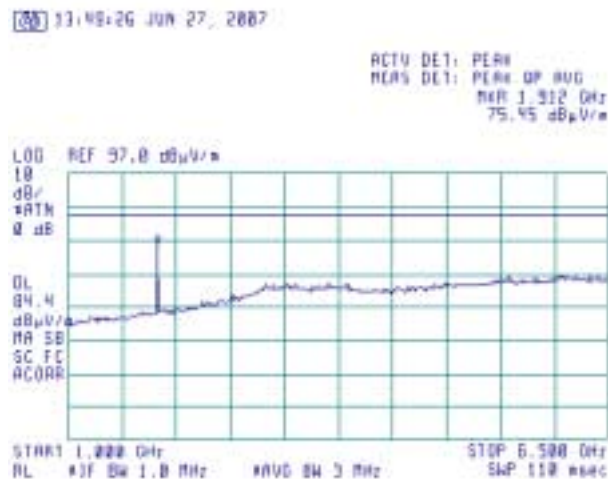

Test specification:	Section 24.238, Radiated spurious emissions		
Test procedure:	Public notice DA 00-705		
Test mode:	Compliance	Verdict:	PASS
Date:	6/24/2007		
Temperature: 27°C	Air Pressure: 1010 hPa	Relative Humidity: 42 %	Power Supply: 5 VDC
Remarks:			

Plot 8.4.13 Radiated emission measurements in 6500 - 18000 MHz range

TEST SITE: Semi anechoic chamber
 CARRIER FREQUENCY: Low
 ANTENNA POLARIZATION: Vertical and Horizontal
 TEST DISTANCE: 3 m

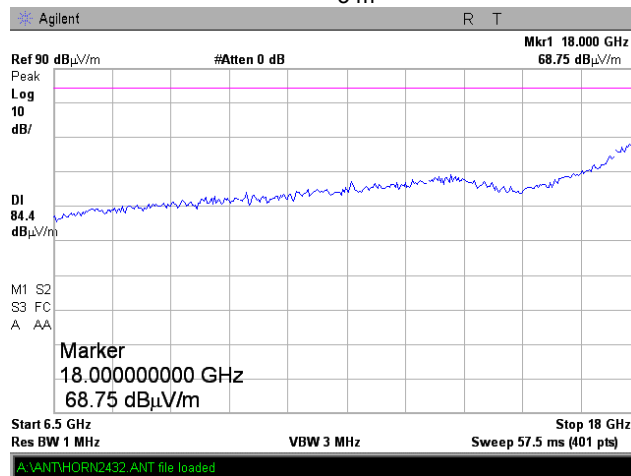

Plot 8.4.14 Radiated emission measurements in 6500 - 18000 MHz range

TEST SITE: Semi anechoic chamber
 CARRIER FREQUENCY: Mid
 ANTENNA POLARIZATION: Vertical and Horizontal
 TEST DISTANCE: 3 m

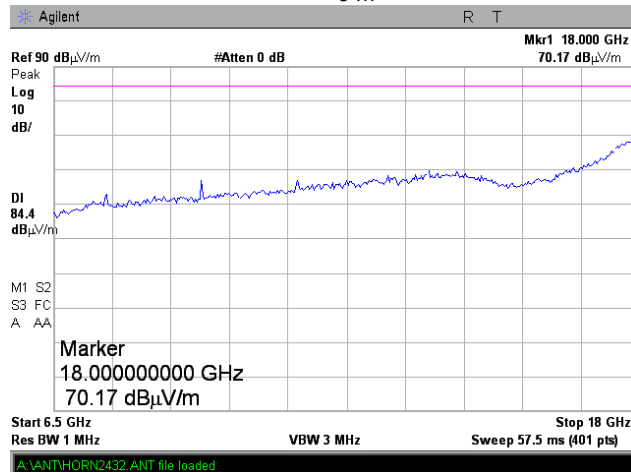

Test specification:	Section 24.238, Radiated spurious emissions		
Test procedure:	Public notice DA 00-705		
Test mode:	Compliance	Verdict:	PASS
Date:	6/24/2007		
Temperature: 27°C	Air Pressure: 1010 hPa	Relative Humidity: 42 %	Power Supply: 5 VDC
Remarks:			

Plot 8.4.15 Radiated emission measurements in 6500 - 18000 MHz range

TEST SITE: Semi anechoic chamber
 CARRIER FREQUENCY: High
 ANTENNA POLARIZATION: Vertical and Horizontal
 TEST DISTANCE: 3 m

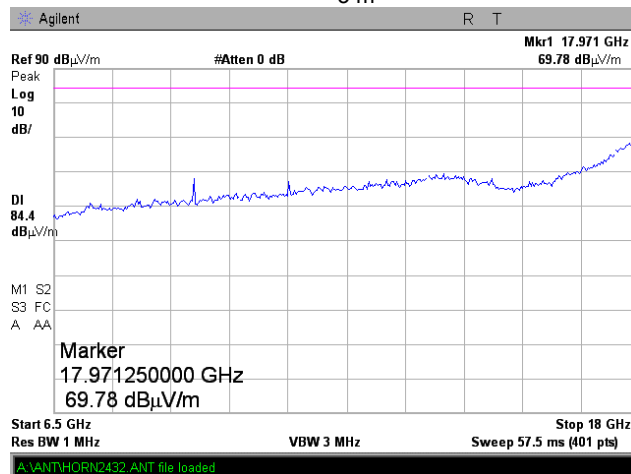

Plot 8.4.16 Radiated emission measurements in 18000 – 20000 MHz range

TEST SITE: OATS
 CARRIER FREQUENCY: Low
 ANTENNA POLARIZATION: Vertical and Horizontal
 TEST DISTANCE: 3 m

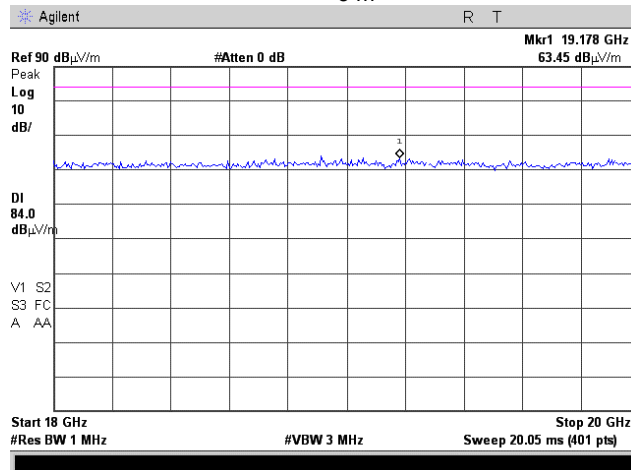

Test specification:	Section 24.238, Radiated spurious emissions		
Test procedure:	Public notice DA 00-705		
Test mode:	Compliance	Verdict:	PASS
Date:	6/24/2007		
Temperature: 27°C	Air Pressure: 1010 hPa	Relative Humidity: 42 %	Power Supply: 5 VDC
Remarks:			

Plot 8.4.17 Radiated emission measurements in 18000 – 20000 MHz range

TEST SITE: OATS
 CARRIER FREQUENCY: Mid
 ANTENNA POLARIZATION: Vertical and Horizontal
 TEST DISTANCE: 3 m

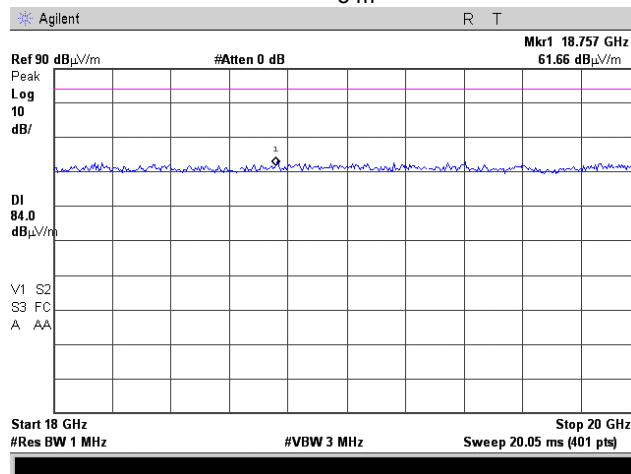

Plot 8.4.18 Radiated emission measurements in 18000 – 20000 MHz range

TEST SITE: OATS
 CARRIER FREQUENCY: High
 ANTENNA POLARIZATION: Vertical and Horizontal
 TEST DISTANCE: 3 m

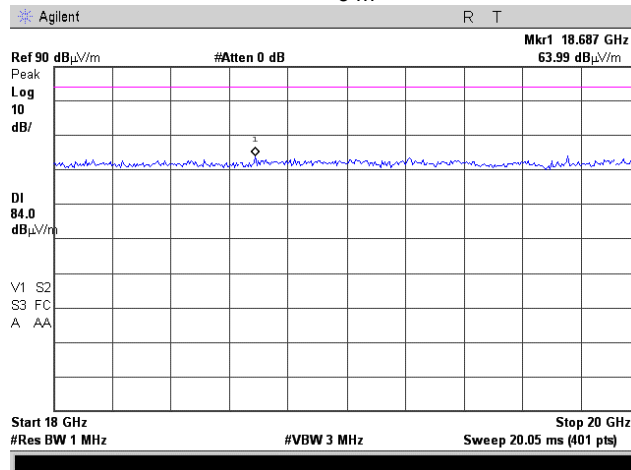

Test specification:	Section 24.238, Radiated spurious emissions		
Test procedure:	Public notice DA 00-705		
Test mode:	Compliance	Verdict:	PASS
Date:	6/24/2007		
Temperature: 27°C	Air Pressure: 1010 hPa	Relative Humidity: 42 %	Power Supply: 5 VDC
Remarks:			

Plot 8.4.19 Radiated emission measurements at the 2nd harmonic

TEST SITE: Semi anechoic chamber
 CARRIER FREQUENCY: Low
 ANTENNA POLARIZATION: Vertical & Horizontal
 TEST DISTANCE: 3 m

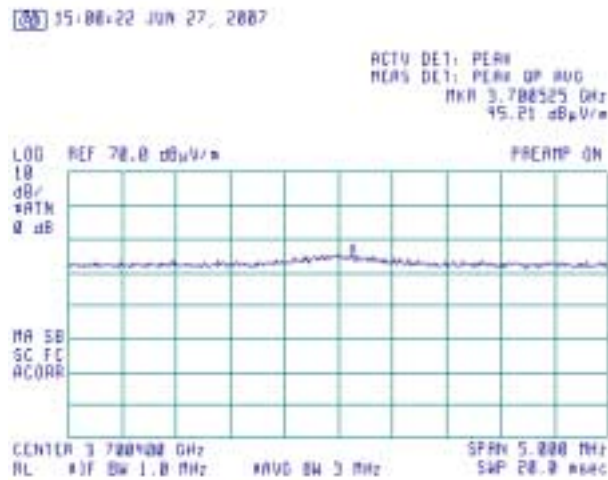

Plot 8.4.20 Radiated emission measurements at the 2nd harmonic

TEST SITE: Semi anechoic chamber
 CARRIER FREQUENCY: Mid
 ANTENNA POLARIZATION: Vertical & Horizontal
 TEST DISTANCE: 3 m

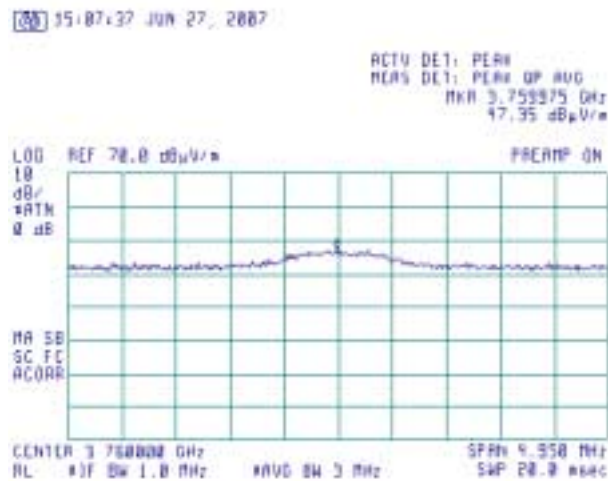

Test specification:	Section 24.238, Radiated spurious emissions		
Test procedure:	Public notice DA 00-705		
Test mode:	Compliance	Verdict:	PASS
Date:	6/24/2007		
Temperature: 27°C	Air Pressure: 1010 hPa	Relative Humidity: 42 %	Power Supply: 5 VDC
Remarks:			

Plot 8.4.21 Radiated emission measurements at the 2nd harmonic

TEST SITE: Semi anechoic chamber
 CARRIER FREQUENCY: High
 ANTENNA POLARIZATION: Vertical & Horizontal
 TEST DISTANCE: 3 m

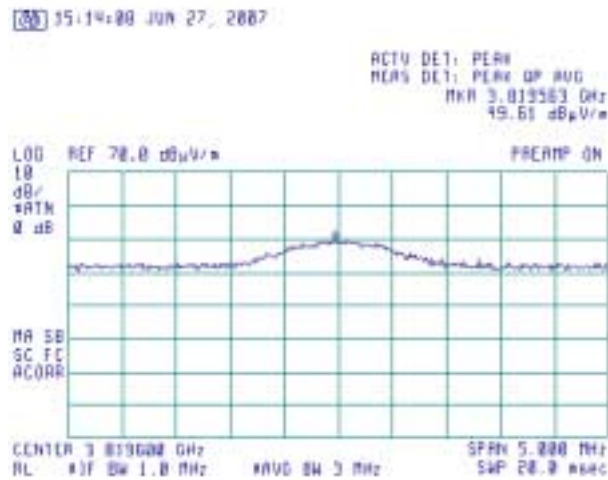

Plot 8.4.22 Radiated emission measurements at the 3rd harmonic

TEST SITE: Semi anechoic chamber
 CARRIER FREQUENCY: Low
 ANTENNA POLARIZATION: Vertical & Horizontal
 TEST DISTANCE: 3 m

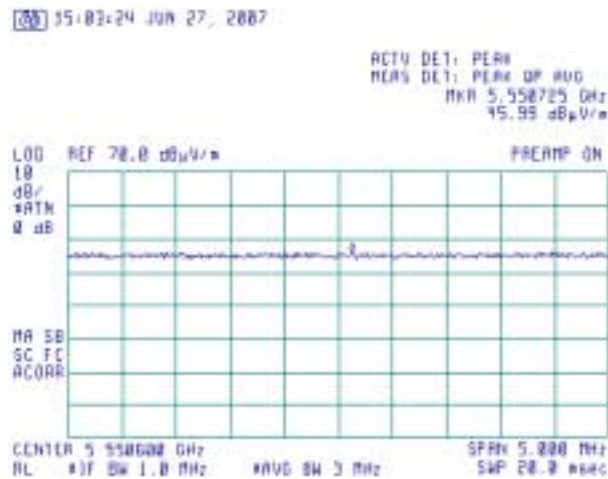

Test specification:	Section 24.238, Radiated spurious emissions		
Test procedure:	Public notice DA 00-705		
Test mode:	Compliance	Verdict:	PASS
Date:	6/24/2007		
Temperature: 27°C	Air Pressure: 1010 hPa	Relative Humidity: 42 %	Power Supply: 5 VDC
Remarks:			

Plot 8.4.23 Radiated emission measurements at the 3rd harmonic

TEST SITE: Semi anechoic chamber
 CARRIER FREQUENCY: Mid
 ANTENNA POLARIZATION: Vertical & Horizontal
 TEST DISTANCE: 3 m

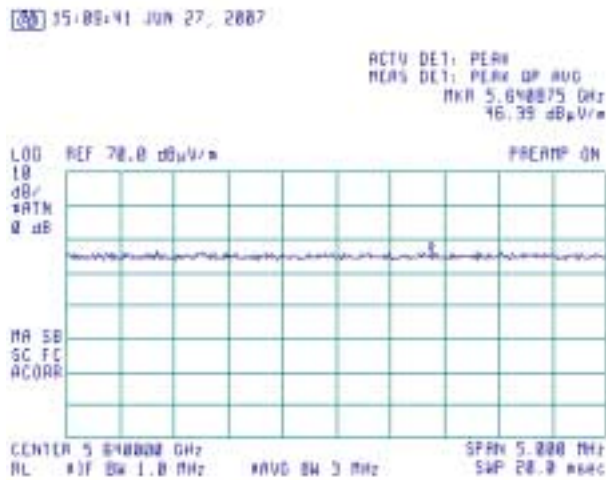

Plot 8.4.24 Radiated emission measurements at the 3rd harmonic

TEST SITE: Semi anechoic chamber
 CARRIER FREQUENCY: High
 ANTENNA POLARIZATION: Vertical & Horizontal
 TEST DISTANCE: 3 m

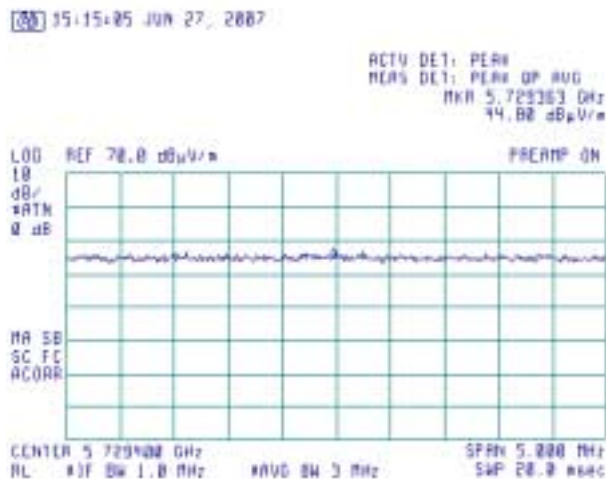

Test specification:		Section 24.238, Radiated spurious emissions	
Test procedure:		Public notice DA 00-705	
Test mode:	Compliance	Verdict:	PASS
Date:	6/24/2007		
Temperature: 27°C	Air Pressure: 1010 hPa	Relative Humidity: 42 %	Power Supply: 5 VDC
Remarks:			

Plot 8.4.25 Radiated emission measurements at the 4th harmonic

TEST SITE: OATS
 CARRIER FREQUENCY: Low
 ANTENNA POLARIZATION: Vertical & Horizontal
 TEST DISTANCE: 3 m

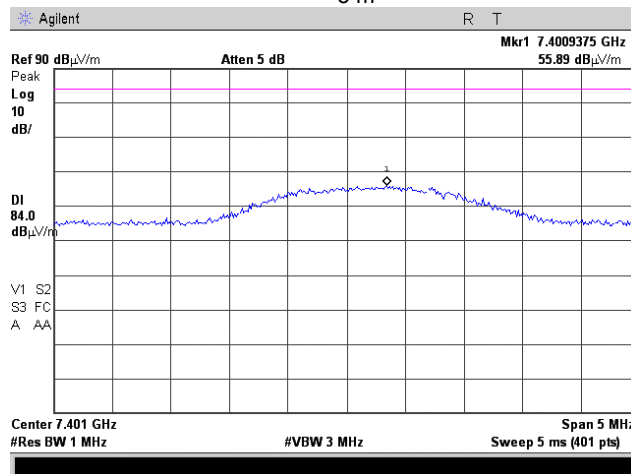

Plot 8.4.26 Radiated emission measurements at the 4th harmonic

TEST SITE: OATS
 CARRIER FREQUENCY: Mid
 ANTENNA POLARIZATION: Vertical & Horizontal
 TEST DISTANCE: 3 m

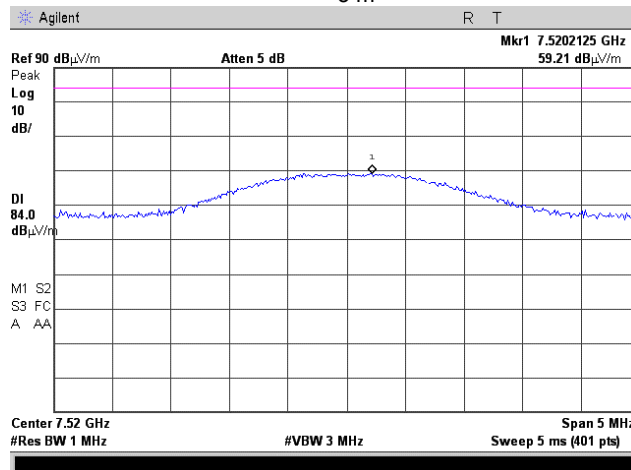

Test specification:	Section 24.238, Radiated spurious emissions		
Test procedure:	Public notice DA 00-705		
Test mode:	Compliance	Verdict:	PASS
Date:	6/24/2007		
Temperature: 27°C	Air Pressure: 1010 hPa	Relative Humidity: 42 %	Power Supply: 5 VDC
Remarks:			

Plot 8.4.27 Radiated emission measurements at the 4th harmonic

TEST SITE: OATS
 CARRIER FREQUENCY: High
 ANTENNA POLARIZATION: Vertical & Horizontal
 TEST DISTANCE: 3 m

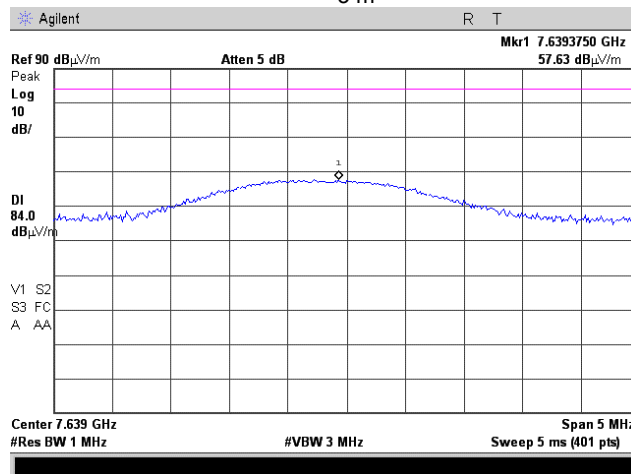

Plot 8.4.28 Radiated emission measurements at the 5th harmonic

TEST SITE: OATS
 CARRIER FREQUENCY: Low
 ANTENNA POLARIZATION: Vertical & Horizontal
 TEST DISTANCE: 3 m

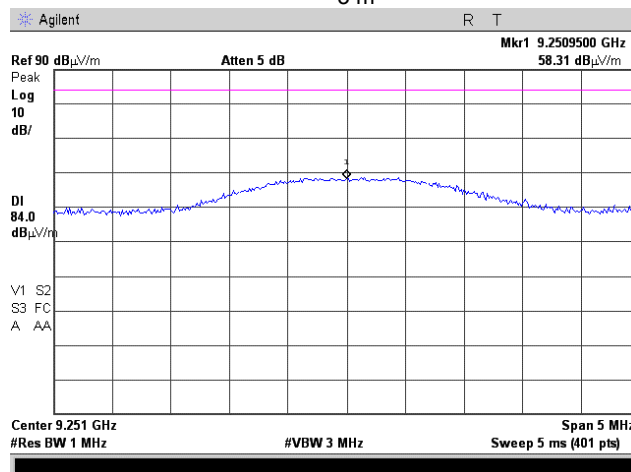

Test specification: Section 24.238, Radiated spurious emissions			
Test procedure: Public notice DA 00-705			
Test mode: Compliance	Verdict: PASS		
Date: 6/24/2007			
Temperature: 27°C	Air Pressure: 1010 hPa	Relative Humidity: 42 %	Power Supply: 5 VDC
Remarks:			

Plot 8.4.29 Radiated emission measurements at the 5th harmonic

TEST SITE: OATS
 CARRIER FREQUENCY: Mid
 ANTENNA POLARIZATION: Vertical & Horizontal
 TEST DISTANCE: 3 m

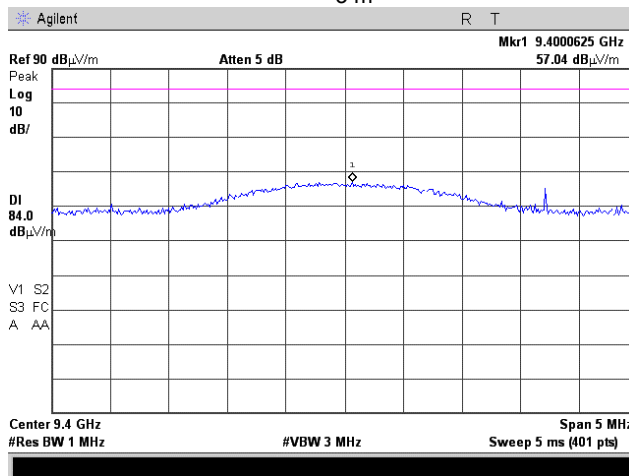

Plot 8.4.30 Radiated emission measurements at the 5th harmonic

TEST SITE: OATS
 CARRIER FREQUENCY: High
 ANTENNA POLARIZATION: Vertical & Horizontal
 TEST DISTANCE: 3 m

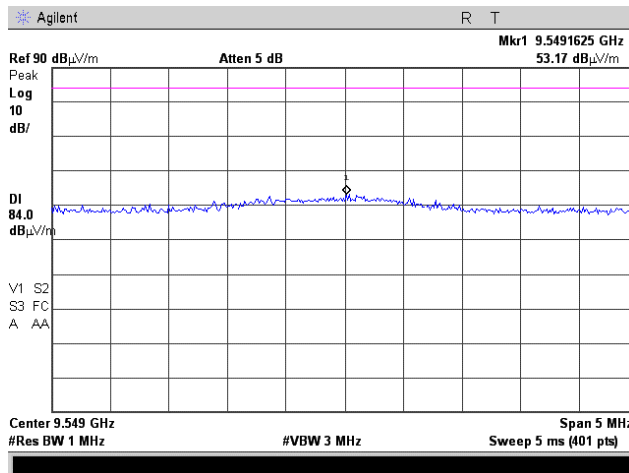

Test specification: Section 24.238, Radiated spurious emissions			
Test procedure: Public notice DA 00-705			
Test mode: Compliance	Verdict: PASS		
Date: 6/24/2007			
Temperature: 27°C	Air Pressure: 1010 hPa	Relative Humidity: 42 %	Power Supply: 5 VDC
Remarks:			

Plot 8.4.31 Radiated emission measurements at the 6th harmonic

TEST SITE: OATS
 CARRIER FREQUENCY: Low
 ANTENNA POLARIZATION: Vertical & Horizontal
 TEST DISTANCE: 3 m

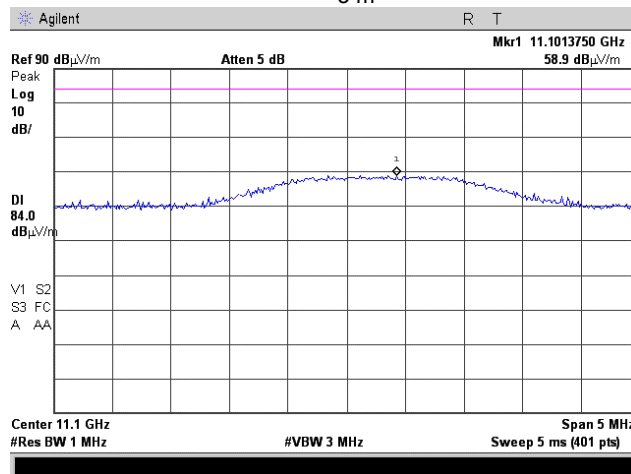

Plot 8.4.32 Radiated emission measurements at the 6th harmonic

TEST SITE: OATS
 CARRIER FREQUENCY: Mid
 ANTENNA POLARIZATION: Vertical & Horizontal
 TEST DISTANCE: 3 m

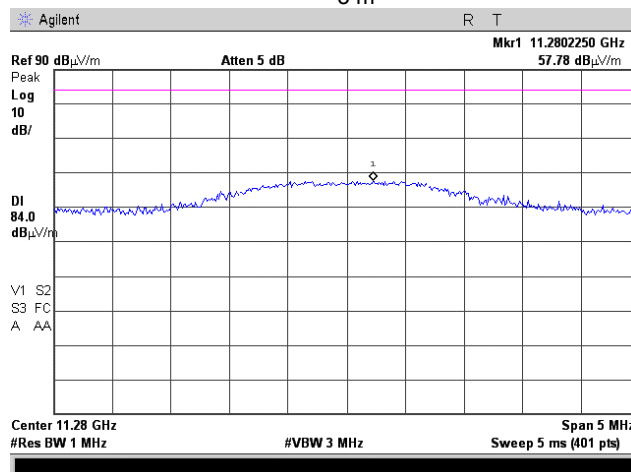

Test specification:	Section 24.238, Radiated spurious emissions		
Test procedure:	Public notice DA 00-705		
Test mode:	Compliance	Verdict:	PASS
Date:	6/24/2007		
Temperature: 27°C	Air Pressure: 1010 hPa	Relative Humidity: 42 %	Power Supply: 5 VDC
Remarks:			

Plot 8.4.33 Radiated emission measurements at the 6th harmonic

TEST SITE: OATS
 CARRIER FREQUENCY: High
 ANTENNA POLARIZATION: Vertical & Horizontal
 TEST DISTANCE: 3 m

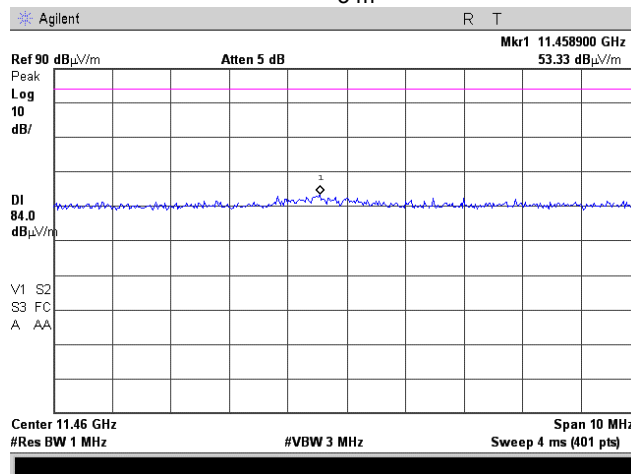

Plot 8.4.34 Radiated emission measurements at the 7th harmonic

TEST SITE: OATS
 CARRIER FREQUENCY: Low
 ANTENNA POLARIZATION: Vertical & Horizontal
 TEST DISTANCE: 3 m

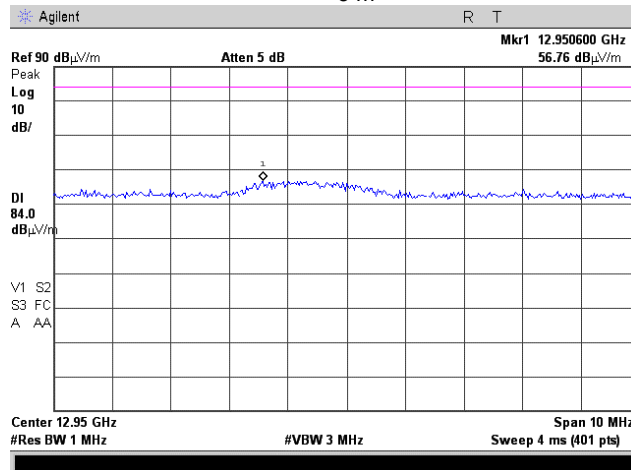

Test specification:	Section 24.238, Radiated spurious emissions		
Test procedure:	Public notice DA 00-705		
Test mode:	Compliance	Verdict:	PASS
Date:	6/24/2007		
Temperature: 27°C	Air Pressure: 1010 hPa	Relative Humidity: 42 %	Power Supply: 5 VDC
Remarks:			

Plot 8.4.35 Radiated emission measurements at the 7th harmonic

TEST SITE: OATS
 CARRIER FREQUENCY: Mid
 ANTENNA POLARIZATION: Vertical & Horizontal
 TEST DISTANCE: 3 m

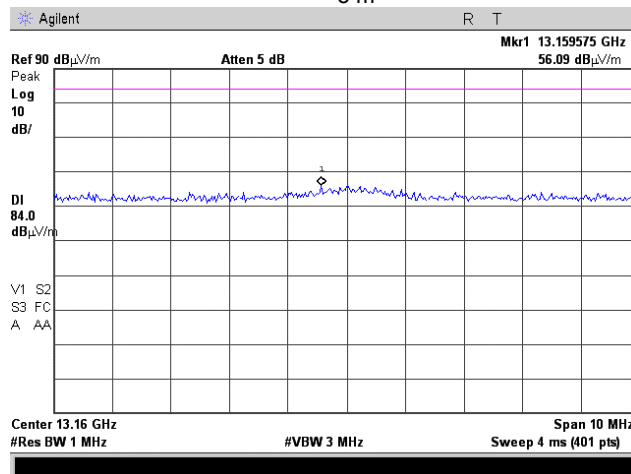

Plot 8.4.36 Radiated emission measurements at the 7th harmonic

TEST SITE: OATS
 CARRIER FREQUENCY: High
 ANTENNA POLARIZATION: Vertical & Horizontal
 TEST DISTANCE: 3 m

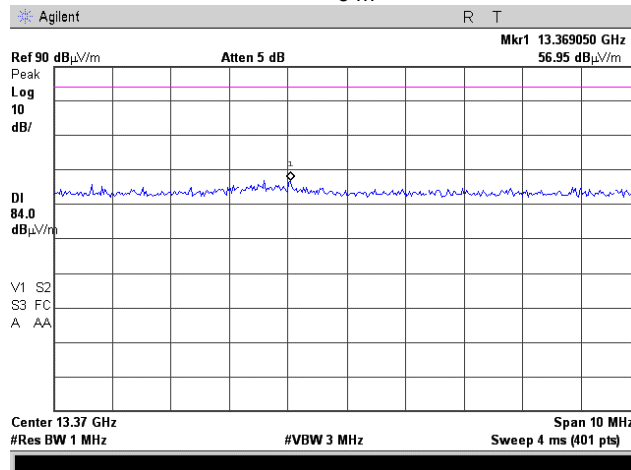

Test specification:	Section 24.238, Radiated spurious emissions		
Test procedure:	Public notice DA 00-705		
Test mode:	Compliance	Verdict:	PASS
Date:	6/24/2007		
Temperature: 27°C	Air Pressure: 1010 hPa	Relative Humidity: 42 %	Power Supply: 5 VDC
Remarks:			

Plot 8.4.37 Radiated emission measurements at the 8th harmonic

TEST SITE: OATS
 CARRIER FREQUENCY: Low
 ANTENNA POLARIZATION: Vertical & Horizontal
 TEST DISTANCE: 3 m

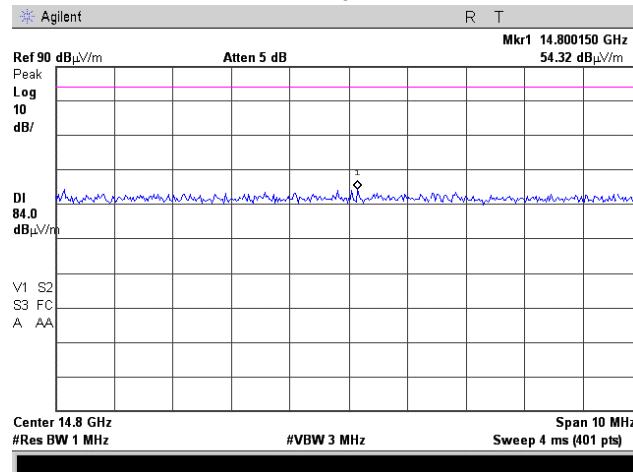

Plot 8.4.38 Radiated emission measurements at the 8th harmonic

TEST SITE: OATS
 CARRIER FREQUENCY: Mid
 ANTENNA POLARIZATION: Vertical & Horizontal
 TEST DISTANCE: 3 m

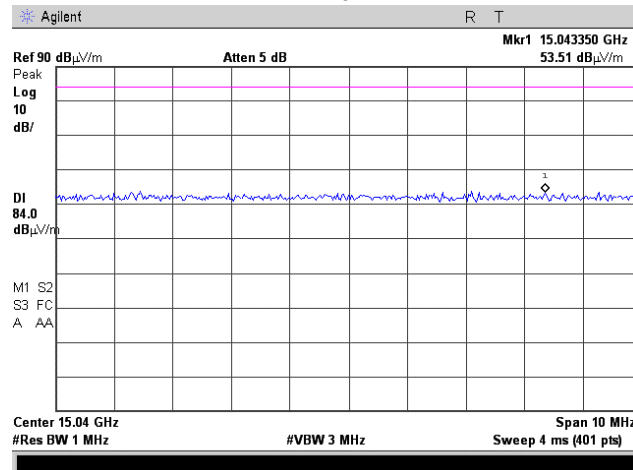

Test specification:	Section 24.238, Radiated spurious emissions		
Test procedure:	Public notice DA 00-705		
Test mode:	Compliance	Verdict:	PASS
Date:	6/24/2007		
Temperature: 27°C	Air Pressure: 1010 hPa	Relative Humidity: 42 %	Power Supply: 5 VDC
Remarks:			

Plot 8.4.39 Radiated emission measurements at the 8th harmonic

TEST SITE: OATS
 CARRIER FREQUENCY: High
 ANTENNA POLARIZATION: Vertical & Horizontal
 TEST DISTANCE: 3 m

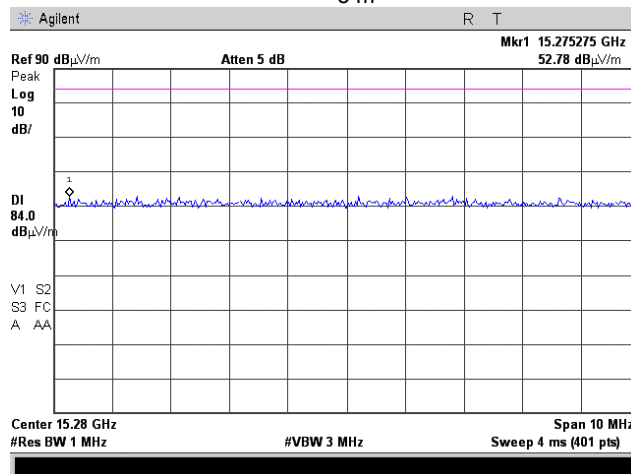

Plot 8.4.40 Radiated emission measurements at the 9th harmonic

TEST SITE: OATS
 CARRIER FREQUENCY: Low
 ANTENNA POLARIZATION: Vertical & Horizontal
 TEST DISTANCE: 3 m

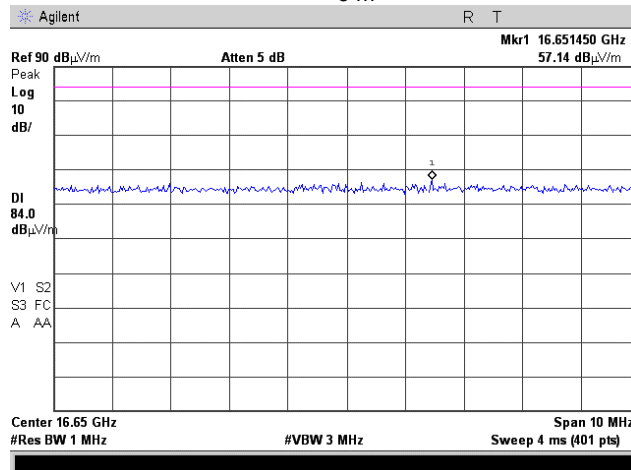

Test specification:	Section 24.238, Radiated spurious emissions		
Test procedure:	Public notice DA 00-705		
Test mode:	Compliance	Verdict:	PASS
Date:	6/24/2007		
Temperature: 27°C	Air Pressure: 1010 hPa	Relative Humidity: 42 %	Power Supply: 5 VDC
Remarks:			

Plot 8.4.41 Radiated emission measurements at the 9th harmonic

TEST SITE: OATS
 CARRIER FREQUENCY: Mid
 ANTENNA POLARIZATION: Vertical & Horizontal
 TEST DISTANCE: 3 m

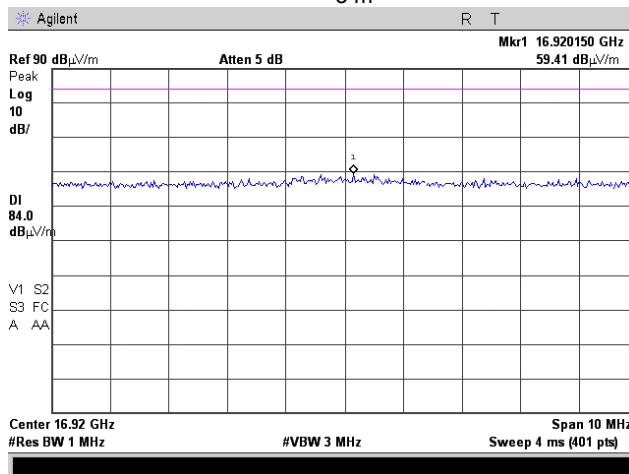

Plot 8.4.42 Radiated emission measurements at the 9th harmonic

TEST SITE: OATS
 CARRIER FREQUENCY: High
 ANTENNA POLARIZATION: Vertical & Horizontal
 TEST DISTANCE: 3 m

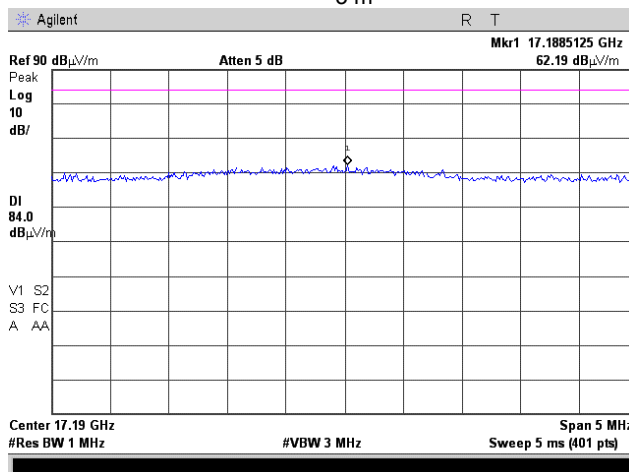

Test specification:	Section 24.238, Radiated spurious emissions		
Test procedure:	Public notice DA 00-705		
Test mode:	Compliance	Verdict:	PASS
Date:	6/24/2007		
Temperature: 27°C	Air Pressure: 1010 hPa	Relative Humidity: 42 %	Power Supply: 5 VDC
Remarks:			

Plot 8.4.43 Radiated emission measurements at the 10th harmonic

TEST SITE: OATS
 CARRIER FREQUENCY: Low
 ANTENNA POLARIZATION: Vertical & Horizontal
 TEST DISTANCE: 3 m

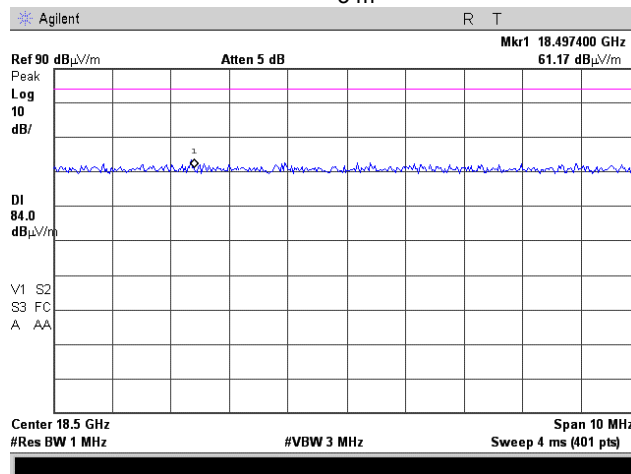

Plot 8.4.44 Radiated emission measurements at the 10th harmonic

TEST SITE: OATS
 CARRIER FREQUENCY: Mid
 ANTENNA POLARIZATION: Vertical & Horizontal
 TEST DISTANCE: 3 m

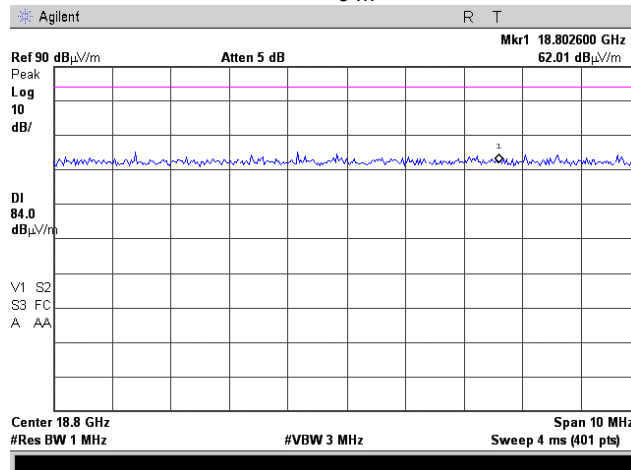

Test specification:	Section 24.238, Radiated spurious emissions		
Test procedure:	Public notice DA 00-705		
Test mode:	Compliance	Verdict:	PASS
Date:	6/24/2007		
Temperature: 27°C	Air Pressure: 1010 hPa	Relative Humidity: 42 %	Power Supply: 5 VDC
Remarks:			

Plot 8.4.45 Radiated emission measurements at the 10th harmonic

TEST SITE: OATS
 CARRIER FREQUENCY: High
 ANTENNA POLARIZATION: Vertical & Horizontal
 TEST DISTANCE: 3 m

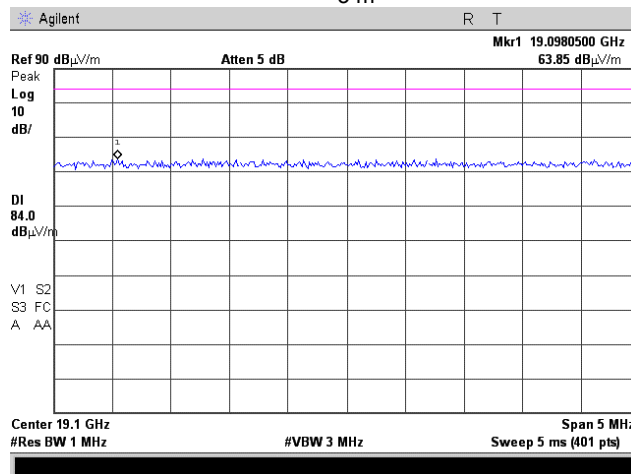

Test specification:		Section 15.107 Conducted emission	
Test procedure:		ANSI C63.4, Section 13.1.3; Sections 11.5 and 12.1.3	
Test mode:	Compliance	Verdict:	PASS
Date:	7/04/2007		
Temperature: 26°C	Air Pressure: 1012 hPa	Relative Humidity: 48 %	Power Supply: 120 VAC
Remarks:			

8.5 Frequency stability test

8.5.1 General

This test was performed to measure frequency stability of transmitter RF carrier. Specification test limits are given in Table 8.5.1.

Table 8.5.1 Frequency stability limits

Assigned frequency, MHz	Limits
1850.2	26 dBc points including frequency tolerance shall remain within the authorized frequency block
1880.0	
1909.8	

8.5.2 Test procedure

- 8.5.2.1 The EUT was set up as shown in Figure 8.5.1, energized and its proper operation was checked.
- 8.5.2.2 The EUT power was turned off. Temperature within test chamber was set to +30°C and a period of time sufficient to stabilize all of the oscillator circuit components was allowed.
- 8.5.2.3 The EUT was powered on and carrier frequency was measured at start up moment and then every minute until frequency had been stabilized or 10 minutes elapsed whichever reached the last. The EUT was powered off.
- 8.5.2.4 The above procedure was repeated at 0°C and at the lowest test temperature.
- 8.5.2.5 The EUT was powered on and carrier frequency was measured at start up moment and at the end of stabilization period at the rest of test temperatures and voltages. The EUT was powered off.
- 8.5.2.6 Frequency displacement was calculated and compared with the limit as provided in Table 8.5.2

Figure 8.5.1 Frequency stability test setup

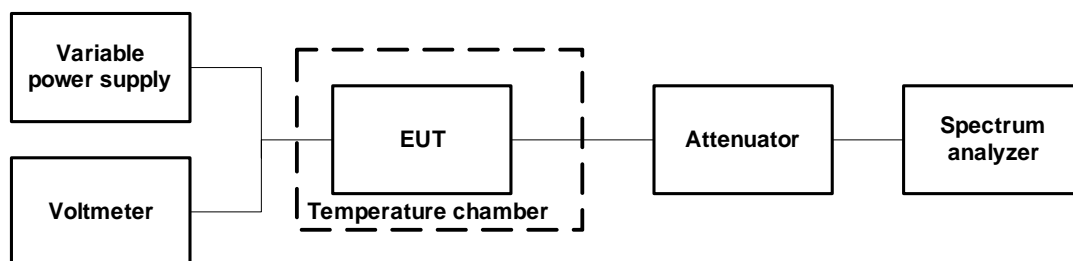

Test specification:	Section 15.107 Conducted emission		
Test procedure:	ANSI C63.4, Section 13.1.3; Sections 11.5 and 12.1.3		
Test mode:	Compliance	Verdict:	PASS
Date:	7/04/2007		
Temperature: 26°C	Air Pressure: 1012 hPa	Relative Humidity: 48 %	Power Supply: 120 VAC
Remarks:			

Photograph 8.5.1 Frequency stability test setup



Photograph 8.5.2 Frequency stability test setup



Test specification:		Section 15.107 Conducted emission			
Test procedure:		ANSI C63.4, Section 13.1.3; Sections 11.5 and 12.1.3			
Test mode:	Compliance	Verdict:		PASS	
Date:	7/04/2007				
Temperature: 26°C	Air Pressure: 1012 hPa	Relative Humidity: 48 %	Power Supply: 120 VAC		
Remarks:					

Table 8.5.2 Frequency stability test results

OPERATING FREQUENCY: 1850.2 – 1909.8 MHz
 NOMINAL POWER VOLTAGE: 230 VAC
 TEMPERATURE STABILIZATION PERIOD: 20 min
 POWER DURING TEMPERATURE TRANSITION: Off
 SPECTRUM ANALYZER MODE: Counter
 RESOLUTION BANDWIDTH: 10kHz
 VIDEO BANDWIDTH: 100Hz
 MODULATION: GMSK

T, °C	Voltage, V	Frequency, MHz							Max frequency drift, H	
		Start up	1 st min	2 nd min	3 rd min	4 th min	5 th min	10 th min	Positive	Negative
Low carrier frequency										
-30	nominal	1850.200017	1850.200001	1850.200029	1850.200021	1850.200033	1850.200044	1850.200051	0	-370
-20	nominal	1850.200273	NA	NA	NA	NA	NA	1850.200249	0	-122
-10	nominal	1850.200285	NA	NA	NA	NA	NA	1850.200191	0	-180
0	nominal	1850.200301	1850.200271	1850.200299	1850.200233	1850.200237	1850.200338	1850.200269	0	-138
10	nominal	1850.200174	NA	NA	NA	NA	NA	1850.200167	0	-204
20	+15%	1850.200280	NA	NA	NA	NA	NA	1850.200260	0	-111
20	nominal	1850.200276	NA	NA	NA	NA	NA	1850.200371	0	-95
20	-15%	1850.200302	NA	NA	NA	NA	NA	1850.200174	0	-197
30	nominal	1850.200035	1850.200046	1850.200053	1850.200025	1850.200012	1850.200008	1850.200033	0	-363
40	nominal	1850.200005	NA	NA	NA	NA	NA	1850.200000	0	-371
50	nominal	1850.200041	NA	NA	NA	NA	NA	1850.200030	0	-341
Mid carrier frequency										
-30	nominal	1880.000007	1880.000032	1880.000018	1879.999989	1880.000005	1880.000003	1880.000029	0	-297
-20	nominal	1880.000232	NA	NA	NA	NA	NA	1880.000365	79	-54
-10	nominal	1880.000394	NA	NA	NA	NA	NA	1880.000197	108	-89
0	nominal	1880.000346	1880.000365	1880.000356	1880.000418	1880.000363	1880.000333	1880.000435	149	0
10	nominal	1880.000244	NA	NA	NA	NA	NA	1880.000214	0	-72.0
20	+15%	1880.000294	NA	NA	NA	NA	NA	1880.000453	167	0
20	nominal	1880.000233	NA	NA	NA	NA	NA	1880.000286	0	-53
20	-15%	1880.000229	NA	NA	NA	NA	NA	1880.000214	0	-72
30	nominal	1880.000006	1880.000003	1879.999992	1880.000000	1880.000019	1880.000007	1880.000023	0	-294
40	nominal	1880.000011	NA	NA	NA	NA	NA	1879.999979	0	-307
50	nominal	1880.000016	NA	NA	NA	NA	NA	1880.000030	0	-270
High carrier frequency										
-30	nominal	1909.800018	1909.800047	1909.800054	1909.800029	1909.800004	1909.800042	1909.799991	0	-315
-20	nominal	1909.800311	NA	NA	NA	NA	NA	1909.800302	5	-4
-10	nominal	1909.800292	NA	NA	NA	NA	NA	1909.800277	0	-29
0	nominal	1909.800251	1909.800173	1909.800256	1909.800206	1909.800369	1909.800323	1909.800297	63	-133
10	nominal	1909.800212	NA	NA	NA	NA	NA	1909.799991	0	-315
20	+15%	1909.800227	NA	NA	NA	NA	NA	1909.799991	0	-315
20	nominal	1909.800250	NA	NA	NA	NA	NA	1909.800306	0	-56
20	-15%	1909.800375	NA	NA	NA	NA	NA	1909.800255	69	-51
30	nominal	1909.800031	1909.800016	1909.800021	1909.800018	1909.800003	1909.800024	1909.800014	0	-303
40	nominal	1909.799984	NA	NA	NA	NA	NA	1909.800034	0	-322
50	nominal	1909.800023	NA	NA	NA	NA	NA	1909.800038	0	-283

* - Reference frequency
 ** - Battery operating end point specified by the manufacturer.

Test specification:		Section 15.107 Conducted emission	
Test procedure:		ANSI C63.4, Section 13.1.3; Sections 11.5 and 12.1.3	
Test mode:	Compliance	Verdict:	PASS
Date:	7/04/2007		
Temperature: 26°C	Air Pressure: 1012 hPa	Relative Humidity: 48 %	Power Supply: 120 VAC
Remarks:			

Table 8.5.3 Transmitter operating range including frequency drift

Carrier frequency, MHz	Lower reference point, MHz	Upper reference point, MHz	Maximum negative drift, Hz	Maximum positive drift, Hz	Frequency tolerance, MHz	Limit, MHz	Margin, kHz	Verdict
1850.2	1850.0650	NA	370	0	1850.064630	1850	64.663	Pass
1909.8	NA	1909.9450	322	69	1909.945069	1910	54.931	Pass

Reference numbers of test equipment used

HL 2909	HL 3210						
---------	---------	--	--	--	--	--	--

Full description is given in Appendix A.

Test specification:	Section 15.107 Conducted emission		
Test procedure:	ANSI C63.4, Section 13.1.3; Sections 11.5 and 12.1.3		
Test mode:	Compliance	Verdict:	PASS
Date:	7/04/2007		
Temperature: 26°C	Air Pressure: 1012 hPa	Relative Humidity: 48 %	Power Supply: 120 VAC
Remarks:			

Plot 8.5.1 Transmitter band edges at the low frequency

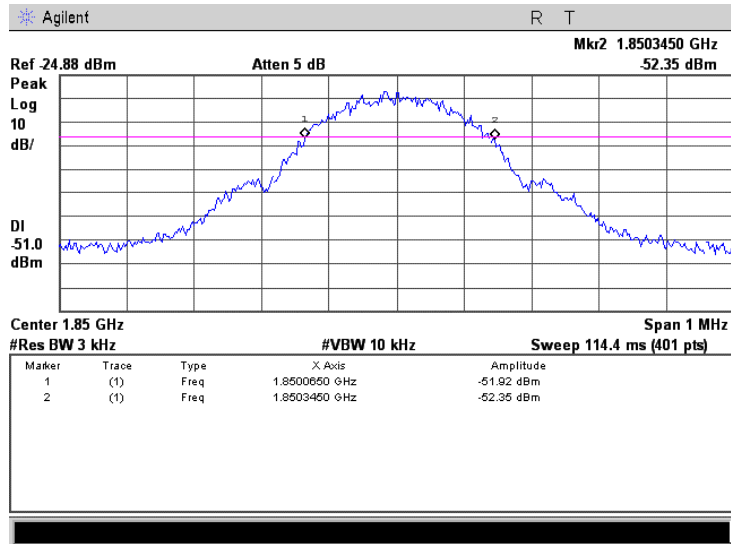

Plot 8.5.2 Transmitter band edges at the high frequency

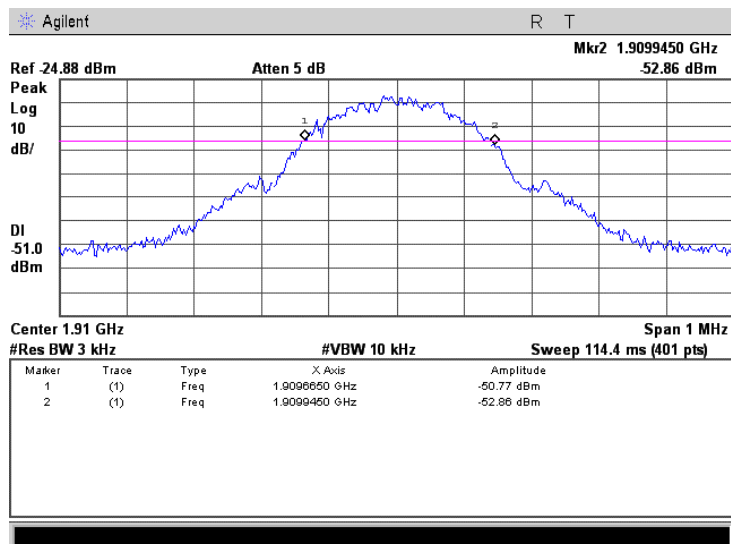

Test specification:	Section 15.107 Class B, AC power lines conducted emissions		
Test procedure:	ANSI C63.4, Section 11.5		
Test mode:	Compliance	Verdict:	PASS
Date:	6/26/2007		
Temperature: 26°C	Air Pressure: 1012 hPa	Relative Humidity: 48 %	Power Supply: 120 VAC
Remarks:			

9 Emissions tests according to FCC 47CFR part 15 subpart B requirements

9.1 Conducted emissions

9.1.1 General

This test was performed to measure the common mode conducted emissions at the EUT power port. The specification test limits are given in Table 9.1.1.

Table 9.1.1 Limits for conducted emissions

Frequency, MHz	Class B limit, dB(μ V)		Class A limit, dB(μ V)	
	QP	AVRG	QP	AVRG
0.15 - 0.5	66 - 56*	56 - 46*	79	66
0.5 - 5.0	56	46	73	60
5.0 - 30	60	50	73	60

* - The limit decreases linearly with the logarithm of frequency.

9.1.2 Test procedure

- 9.1.2.1 The EUT was set up as shown in Figure 9.1.1 and the associated photographs, energized and the EUT performance was checked.
- 9.1.2.2 The measurements were performed at the EUT power terminals with the LISN connected to the EMI receiver in the frequency range referred to in Table 9.1.2. The unused coaxial connector of the LISN was terminated with 50 Ohm.
- 9.1.2.3 The position of the EUT cables was varied to find the highest emission.
- 9.1.2.4 The worst test results with respect to the limits were recorded in Table 9.1.2 and shown in the associated plots.

Test specification:	Section 15.107 Class B, AC power lines conducted emissions		
Test procedure:	ANSI C63.4, Section 11.5		
Test mode:	Compliance	Verdict:	PASS
Date:	6/26/2007		
Temperature: 26°C	Air Pressure: 1012 hPa	Relative Humidity: 48 %	Power Supply: 120 VAC
Remarks:			

Figure 9.1.1 Setup for conducted emission measurements, table-top EUT

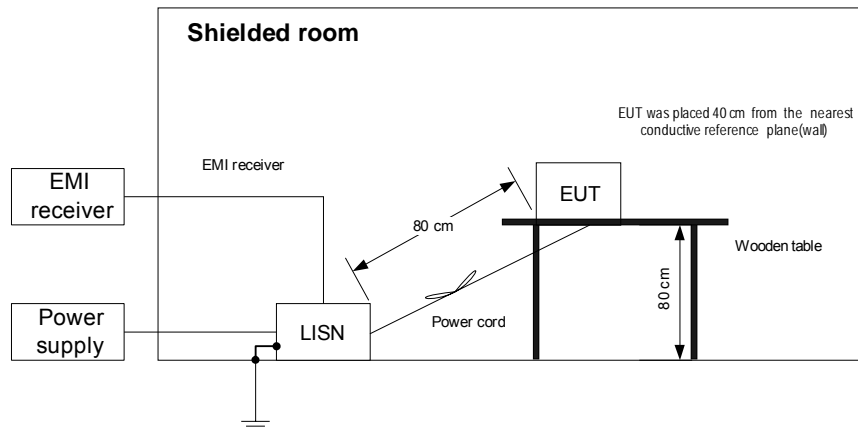

Photograph 9.1.1 Setup for conducted emission measurements



Test specification:		Section 15.107 Class B, AC power lines conducted emissions	
Test procedure:		ANSI C63.4, Section 11.5	
Test mode:	Compliance	Verdict:	PASS
Date:	6/26/2007		
Temperature: 26°C	Air Pressure: 1012 hPa	Relative Humidity: 48 %	Power Supply: 120 VAC
Remarks:			

Table 9.1.2 Conducted emission test results

LINE: AC mains
 EUT SET UP: TABLE-TOP
 TEST SITE: SHIELDED ROOM
 DETECTORS USED: PEAK / QUASI-PEAK / AVERAGE
 FREQUENCY RANGE: 150 kHz - 30 MHz
 RESOLUTION BANDWIDTH: 9 kHz

Frequency, MHz	Peak emission, dB(μV)	Quasi-peak			Average			Line ID	Verdict
		Measured emission, dB(μV)	Limit, dB(μV)	Margin, dB*	Measured emission, dB(μV)	Limit, dB(μV)	Margin, dB*		
0.358768	41.90	37.94	58.82	-20.88	31.06	48.82	-17.76	L1	Pass
0.636297	42.04	37.11	56.00	-18.89	31.63	46.00	-14.37		
0.656987	41.15	37.13	56.00	-18.87	31.39	46.00	-14.61		
1.470966	40.66	34.71	56.00	-21.29	30.82	46.00	-15.18		
0.351628	45.35	37.76	58.99	-21.23	30.47	48.99	-18.52	L2	Pass
0.609485	45.16	36.49	56.00	-19.51	30.50	46.00	-15.50		
0.638470	44.29	38.18	56.00	-17.82	29.98	46.00	-16.02		
1.038774	43.07	37.37	56.00	-18.63	29.44	46.00	-16.56		

*- Margin = Measured emission - specification limit.

Reference numbers of test equipment used

HL 1503	HL 1510	HL 1430	HL 2888			
---------	---------	---------	---------	--	--	--

Full description is given in Appendix A.

Test specification:		Section 15.107 Class B, AC power lines conducted emissions	
Test procedure:		ANSI C63.4, Section 11.5	
Test mode:	Compliance	Verdict:	PASS
Date:	6/26/2007		
Temperature: 26°C	Air Pressure: 1012 hPa	Relative Humidity: 48 %	Power Supply: 120 VAC
Remarks:			

Plot 9.1.1 Conducted emission measurements

LINE: L1
LIMIT: QUASI-PEAK, AVERAGE
DETECTOR: PEAK

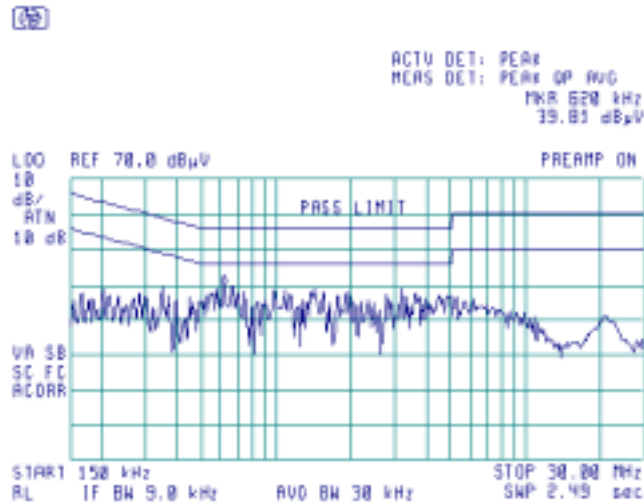

Plot 9.1.2 Conducted emission measurements

LINE: L2
LIMIT: QUASI-PEAK, AVERAGE
DETECTOR: PEAK

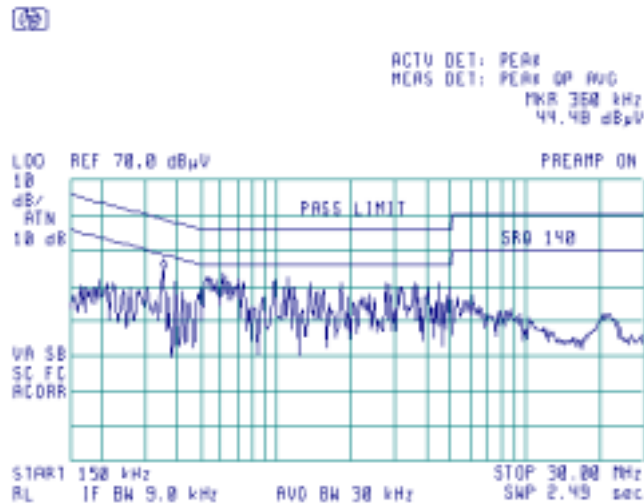

Test specification:	Section 15.109 Class B, Radiated emissions		
Test procedure:	ANSI C63.4, Section 11.6		
Test mode:	Compliance	Verdict:	PASS
Date:	7/4/2007		
Temperature: 25°C	Air Pressure: 1013 hPa	Relative Humidity: 44 %	Power Supply: 5 VDC
Remarks:			

9.2 Radiated emission measurements

9.2.1 General

This test was performed to measure radiated emissions from the EUT enclosure. The specification test limits are given in Table 9.2.1.

Table 9.2.1 Radiated emission test limits

Frequency, MHz	Class B limit, dB(μV/m)		Class A limit, dB(μV/m)	
	10 m distance	3 m distance	10 m distance	3 m distance
30 - 88	29.5*	40.0	39.0	49.5*
88 - 216	33.0*	43.5	43.5	54.0*
216 - 960	35.5*	46.0	46.4	56.9*
Above 960	43.5*	54.0	49.5	60.0*

* - The limit for a test distance other than specified was calculated using the inverse linear distance extrapolation factor as follows: $Lim_{S_2} = Lim_{S_1} + 20 \log(S_1/S_2)$, where S_1 and S_2 – the standard defined and the test distance respectively in meters.

9.2.2 Test procedure for measurements in semi-anechoic chamber

9.2.2.1 The EUT was set up as shown in Figure 9.2.1 and the associated photographs, energized and the EUT performance was checked.

9.2.2.2 The specified frequency range was investigated with the antenna connected to the EMI receiver. To find the highest emission the turntable was rotated 360° and the measuring antenna height was swept from 1 to 4 m in both, vertical and horizontal polarizations. The EUT cables position was varied to maximize emission.

9.2.2.3 The worst test results with respect to the limits were recorded in Table 9.2.2 and shown in the associated plots.

Test specification:	Section 15.109 Class B, Radiated emissions		
Test procedure:	ANSI C63.4, Section 11.6		
Test mode:	Compliance	Verdict:	PASS
Date:	7/4/2007		
Temperature: 25°C	Air Pressure: 1013 hPa	Relative Humidity: 44 %	Power Supply: 5 VDC
Remarks:			

Figure 9.2.1 Setup for radiated emission measurements in anechoic chamber, table-top EUT

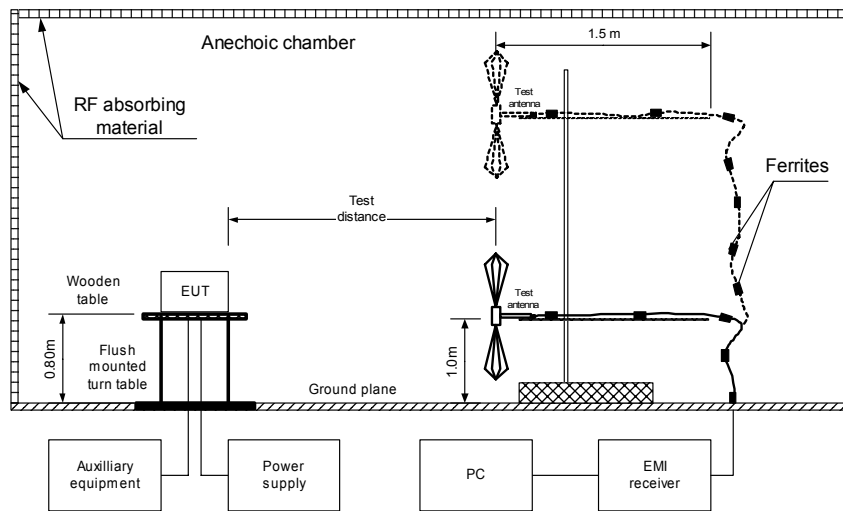

Photograph 9.2.1 Setup for radiated emission measurements



Test specification:	Section 15.109 Class B, Radiated emissions		
Test procedure:	ANSI C63.4, Section 11.6		
Test mode:	Compliance	Verdict:	PASS
Date:	7/4/2007		
Temperature: 25°C	Air Pressure: 1013 hPa	Relative Humidity: 44 %	Power Supply: 5 VDC
Remarks:			

Photograph 9.2.2 Setup for radiated emission measurements



Test specification: Section 15.109 Class B, Radiated emissions			
Test procedure: ANSI C63.4, Section 11.6			
Test mode: Compliance	Verdict: PASS		
Date: 7/4/2007			
Temperature: 25°C	Air Pressure: 1013 hPa	Relative Humidity: 44 %	Power Supply: 5 VDC
Remarks:			

Table 9.2.2 Radiated emission test results

EUT SET UP: TABLE-TOP
TEST SITE: SEMI ANECHOIC CHAMBER
TEST DISTANCE: 3 m
DETECTORS USED: PEAK / QUASI-PEAK
FREQUENCY RANGE: 30 MHz – 1000 MHz
RESOLUTION BANDWIDTH: 120 kHz

Frequency, MHz	Peak emission, dB(μV/m)	Quasi-peak			Antenna polarization	Antenna height, m	Turn-table position**, degrees	Verdict
		Measured emission, dB(μV/m)	Limit, dB(μV/m)	Margin, dB*				
37.824631	33.12	31.04	-8.96	40.00	V	1.0	120	Pass
98.277500	34.40	31.17	-12.33	43.50	H	1.2	100	
166.087500	37.17	26.50	-17.00	43.50	H	1.2	190	
196.598750	35.84	33.67	-9.83	43.50	H	1.3	210	
450.550000	32.64	30.88	-15.12	46.00	V	1.0	87	
458.082500	39.49	36.91	-9.09	46.00	V	1.2	29	
491.503750	31.16	28.44	-17.56	46.00	V	1.0	90	
728.992500	43.11	41.04	-4.96	46.00	H	1.0	180	

TEST SITE: SEMI ANECHOIC CHAMBER
TEST DISTANCE: 3 m
DETECTORS USED: PEAK / AVERAGE
FREQUENCY RANGE: 1000 – 10000 MHz
RESOLUTION BANDWIDTH: 1000 kHz

Frequency, MHz	Peak emission, dB(μV/m)	Average			Antenna polarization	Antenna height, m	Turn-table position**, degrees	Verdict
		Measured emission, dB(μV/m)	Limit, dB(μV/m)	Margin, dB*				
No spurious were found								Pass

*- Margin = Measured emission - specification limit.
**- EUT front panel refers to 0 degrees position of turntable.

Reference numbers of test equipment used

HL 0521	HL 0589	HL 0604	HL 1984	HL 1947	HL 2009	HL 2909	
---------	---------	---------	---------	---------	---------	---------	--

Full description is given in Appendix A.

Test specification: Section 15.109 Class B, Radiated emissions			
Test procedure: ANSI C63.4, Section 11.6			
Test mode: Compliance	Verdict: PASS		
Date: 7/4/2007			
Temperature: 25°C	Air Pressure: 1013 hPa	Relative Humidity: 44 %	Power Supply: 5 VDC
Remarks:			

Plot 9.2.1 Radiated emission measurements in 30 - 1000 MHz range, vertical antenna polarization

TEST SITE: Anechoic chamber
TEST DISTANCE: 3 m

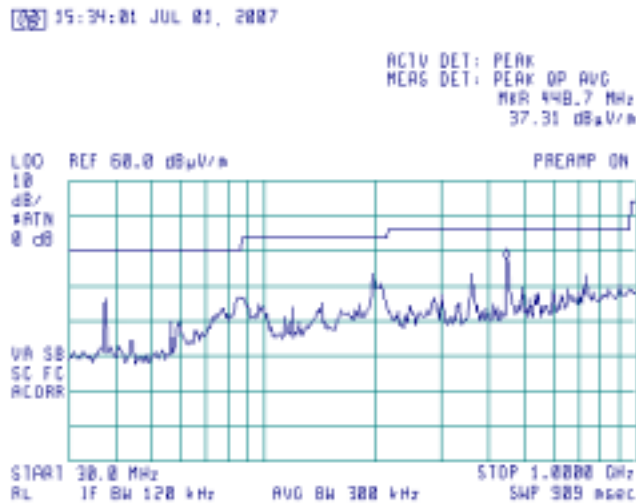

Plot 9.2.2 Radiated emission measurements in 30 - 1000 MHz range, horizontal antenna polarization

TEST SITE: Anechoic chamber
TEST DISTANCE: 3 m

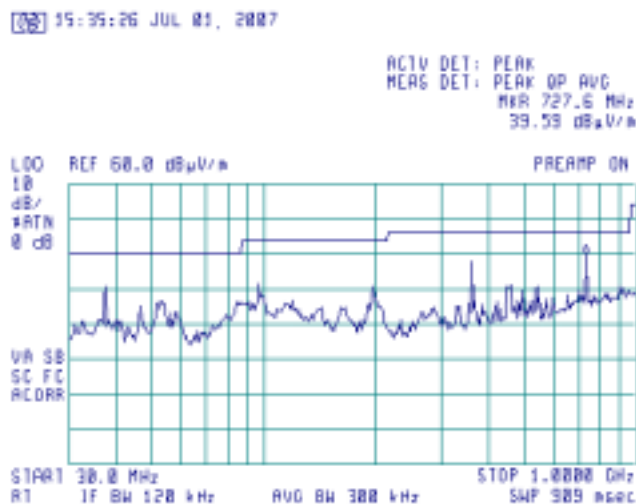

Test specification: Section 15.109 Class B, Radiated emissions			
Test procedure: ANSI C63.4, Section 11.6			
Test mode: Compliance	Verdict: PASS		
Date: 7/4/2007			
Temperature: 25°C	Air Pressure: 1013 hPa	Relative Humidity: 44 %	Power Supply: 5 VDC
Remarks:			

Plot 9.2.3 Radiated emission measurements 1000 -6500MHz, vertical & horizontal antenna polarization

TEST SITE: Anechoic chamber
TEST DISTANCE: 3 m

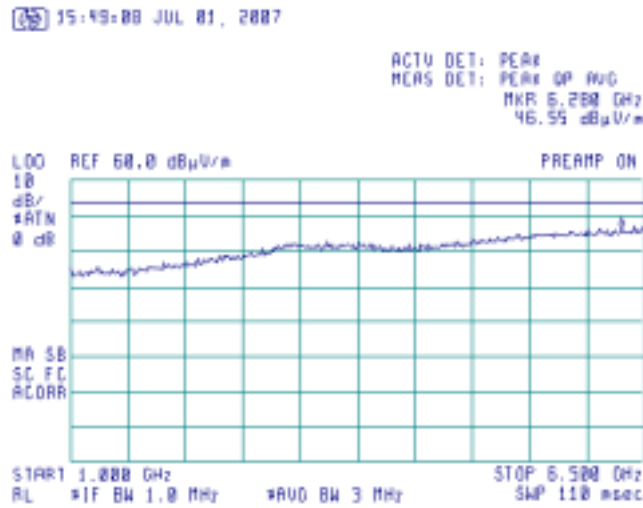

Plot 9.2.4 Radiated emission measurements 6500 -10000MHz, vertical & horizontal antenna polarization

TEST SITE: Anechoic chamber
TEST DISTANCE: 3 m
DETECTOR: Peak

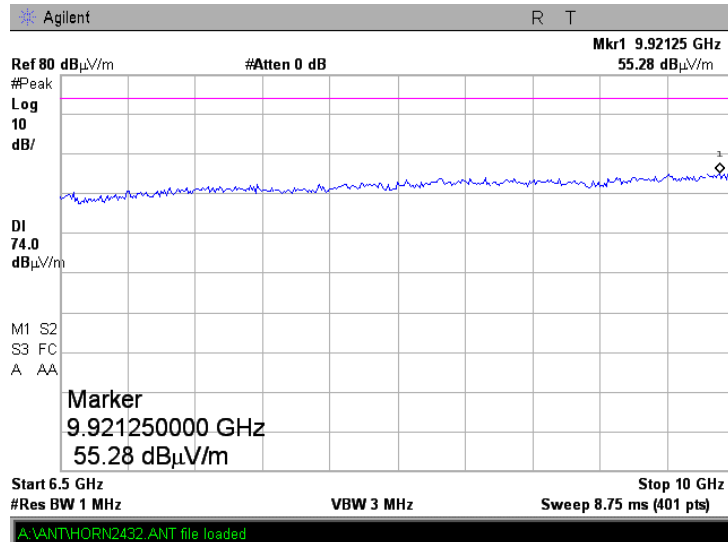

Test specification:	Section 15.109 Class B, Radiated emissions		
Test procedure:	ANSI C63.4, Section 11.6		
Test mode:	Compliance	Verdict:	PASS
Date:	7/4/2007		
Temperature: 25°C	Air Pressure: 1013 hPa	Relative Humidity: 44 %	Power Supply: 5 VDC
Remarks:			

Plot 9.2.5 Radiated emission measurements 6500 -10000MHz, vertical & horizontal antenna polarization

TEST SITE: Anechoic chamber
TEST DISTANCE: 3 m
DETECTOR: Average

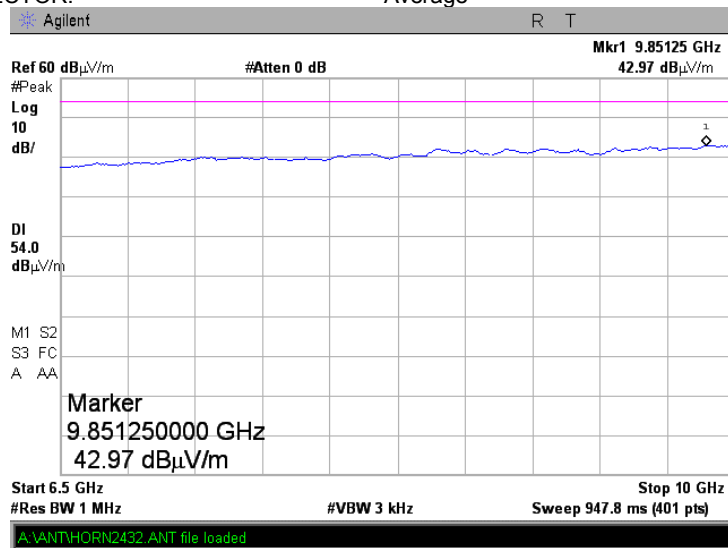

Test specification: Section 15.111, Spurious emissions at RF antenna connector			
Test procedure: ANSI C63.4, Section 12.1.5			
Test mode:	Compliance	Verdict: PASS	
:	7/11/2007		
Temperature: 28°C	Air Pressure: 1010 hPa	Relative Humidity: 30%	Power Supply: 5 V DC
Remarks:			

9.3 Spurious emissions at RF antenna connector

9.3.1 General

This test was performed to measure spurious emissions at RF antenna connector of receiver operated within 30 to 960 MHz band or a citizens band (CB) receiver which was tested for compliance with radiated emission limits with the antenna port connected to resistive termination. Specification test limits are given in Table 9.3.1.

Table 9.3.1 Spurious emission limits

Frequency, MHz	EUT type	Power of spurious	
		nW	dBm
25 MHz – 5 th harmonic*	Citizens band (CB) receiver	2.0	-57.0
30 MHz – 2 nd harmonic**	Superheterodyne receiver		
30 MHz – 5 th harmonic*	Other receiver operates within 30 – 960 MHz		

* - harmonic of the highest frequency the EUT generates, uses, operates or tunes to.

** - harmonic of the highest local oscillator frequency.

9.3.2 Test procedure

9.3.2.1 The EUT was set up as shown in Figure 9.3.1, energized and its proper operation was checked.

9.3.2.2 The spurious emission was measured with spectrum analyzer as provided in Table 9.3.2 and associated plots.

Figure 9.3.1 Spurious emission test setup

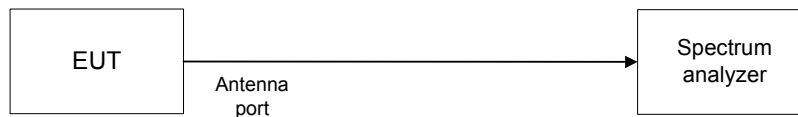

Photograph 9.3.1 Spurious emission test setup



Test specification:	Section 15.111, Spurious emissions at RF antenna connector		
Test procedure:	ANSI C63.4, Section 12.1.5		
Test mode:	Compliance	Verdict:	PASS
:	7/11/2007		
Temperature: 28°C	Air Pressure: 1010 hPa	Relative Humidity: 30%	Power Supply: 5 V DC
Remarks:			

Table 9.3.2 Spurious emission test results

INVESTIGATED FREQUENCY RANGE: 824-849 MHz
 RECEIVER TYPE: Other than CB or superheterodyne
 EUT OPERATING MODE: Receive
 DETECTOR USED: Peak
 RESOLUTION BANDWIDTH: 1000 kHz
 VIDEO BANDWIDTH: 3000 kHz

Frequency, MHz	Spurious emission, dBm	Limit, dBm	Margin, dB	Verdict
No spurious were found				Pass

Reference numbers of test equipment used

HL 2909							
---------	--	--	--	--	--	--	--

Full description is given in Appendix A.

Plot 9.3.1 Spurious emission test results

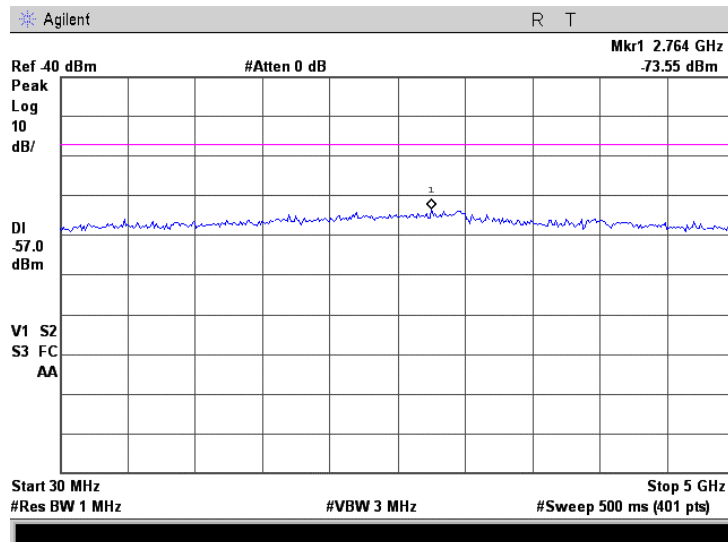

10 APPENDIX A Test equipment and ancillaries used for tests

HL No	Description	Manufacturer	Model	Ser. No.	Last Cal.	Due Cal.
0446	Antenna, Loop, Active, 10 kHz - 30 MHz	EMCO	6502	2857	28-Jun-07	28-Jun-08
0521	EMI Receiver (Spectrum Analyzer) with RF filter section 9 kHz-6.5 GHz	Hewlett Packard	8546A	3617A 00319, 3448A002 53	26-Sep-06	26-Sep-07
0589	Cable Coaxial, GORE A2P01POL118, 2.3 m	HL	GORE-3	176	02-Dec-06	02-Dec-07
0604	Antenna BiconiLog Log-Periodic/T Bow-TIE, 26 - 2000 MHz	EMCO	3141	9611-1011	10-Jan-07	10-Jan-08
1430	EMI Receiver, 9 kHz - 2.9 GHz, System: HL1431, HL1432	Agilent Technologies	8542E	3807A002 62,3705A0 0217	01-Sep-06	01-Sep-07
1503	Cable RF, 6 m, BNC/BNC	Belden	M17/167 MIL-C-17	1503	11-Sep-06	11-Sep-07
1510	Cable RF, 8 m, BNC/BNC	Belden	M17/167 MIL-C-17	1510	01-Jan-07	01-Jan-08
1947	Cable 18GHz, 6.5 m, blue	Rhophase Microwave Limited	NPS-1803A-6500-NPS	T4974	17-Oct-06	17-Oct-07
1984	Antenna, Double-Ridged Waveguide Horn, 1-18 GHz, 300 W	EMC Test Systems	3115	9911-5964	03-Mar-07	03-Mar-08
2009	Cable RF, 8 m	Alpha Wire	RG-214	C-56	20-May-07	20-May-08
2011	Power Divider, 0.5-18.0 GHz, 80 W	Omni Spectra	2090-6204-00	2011	05-Dec-06	05-Dec-07
2259	Amplifier Low Noise 2-20 GHz	Sophia Wireless	LNA0220-C	0223	05-Nov-06	05-Nov-07
2869	Cable, 18 GHz, 1.2 m, SMA - SMA, Right Angle	Gore	NA	91P72073	11-Feb-07	11-Feb-08
2888	LISN Two-line V-Network 50 Ohm / 50 uH + 5 Ohm, 16A, MIL STD 461E, CISPR 16-1	Rolf Heine	NNB-2/16Z	02/10018	29-Mar-07	29-Mar-08
2909	Spectrum analyzer, ESA-E, 100 Hz to 26.5 GHz	Agilent Technologies	E4407B	MY414447 62	07-May-07	07-May-08
2910	Cable 18 GHz, 3 m, SMA-SMA	Gore	NA	989370	01-Jan-07	01-Jan-08
2912	Cable 18 GHz, 1.5 m, SMA-SMA	Gore	NA	91P72067	11-Feb-07	11-Feb-08
3001	EMC Analyzer, 9 kHz to 3 GHz	Agilent Technologies	E7402A	US394401 80	22-Nov-06	22-Nov-07
3178	Attenuator, N-type, 20 dB, DC to 18 GHz, 5 W	Mini-Circuits	BW-N20W5+	0651	07-May-07	07-May-08
3180	Attenuator, N-type, 20 dB, DC to 18 GHz, 5 W	Mini-Circuits	BW-N20W5+	0651	07-May-07	07-May-08
3182	Attenuator, N-type, 10 dB, DC to 6 GHz, 1 W	Mini-Circuits	UNAT-10+	15542	07-May-07	07-May-08
3210	Oven	Associated	NA	NA	20-Jun-07	20-Jun-08

11 APPENDIX B Measurement uncertainties

Expanded uncertainty at 95% confidence in Hermon Labs EMC measurements

Test description	Expanded uncertainty
Conducted emissions at mains port with LISN and HP 8542E or HP 8546A receiver	9 kHz to 150 kHz: ± 3.9 dB 150 kHz to 30 MHz: ± 3.8 dB
Radiated emissions at 10 m measuring distance Horizontal polarization Vertical polarization	Biconilog antenna: ± 5.0 dB Biconical antenna: ± 5.0 dB Log periodic antenna: ± 5.1 dB Double ridged horn antenna: ± 5.3 dB Biconilog antenna: ± 5.5 dB Biconical antenna: ± 5.5 dB Log periodic antenna: ± 5.6 dB Double ridged horn antenna: ± 5.8 dB
Radiated emissions at 3 m measuring distance Horizontal polarization Vertical polarization	Biconilog antenna: ± 5.3 dB Biconical antenna: ± 5.0 dB Log periodic antenna: ± 5.3 dB Double ridged horn antenna: ± 5.3 dB Biconilog antenna: ± 6.0 dB Biconical antenna: ± 5.7 dB Log periodic antenna: ± 6.0 dB Double ridged horn antenna: ± 6.0 dB

Hermon Laboratories is accredited by A2LA for calibration according to present requirements of ISO/IEC 17025 and NCSL Z540-1. The accreditation is granted to perform calibration of parameters that are listed in the Scope of Hermon Laboratories Accreditation.

Hermon Laboratories calibrates its reference and transfer standards by calibration laboratories accredited to ISO/IEC 17025 by a mutually recognized Accreditation Body or by a recognized national metrology institute. All reference and transfer standards used in the calibration system are traceable to national or international standards.

In-house calibration of all test and measurement equipment is performed on a regular basis according to Hermon Laboratories calibration procedures, manufacturer calibration/verification procedures or procedures defined in the relevant standards. The Hermon Laboratories test and measurement equipment is calibrated within the tolerances specified by the manufacturers and/or by the relevant standards.

12 APPENDIX C Test laboratory description

Tests were performed at Hermon Laboratories Ltd., which is a fully independent, private, EMC, safety, environmental and telecommunication testing facility. Hermon Laboratories is listed by the Federal Communications Commission (USA) for all parts of Code of Federal Regulations 47 (CFR 47) and by Industry Canada for electromagnetic emissions (file numbers IC 2186-1 for OATS and IC 2186-2 for anechoic chamber), certified by VCCI, Japan (the registration numbers are R-808 for OATS, R-1082 for anechoic chamber, C-845 for conducted emissions site), assessed by TNO Certification EP&S (Netherlands) for a number of EMC, telecommunications, environmental, safety standards, and by AMTAC (UK) for safety of medical devices. The laboratory is accredited by American Association for Laboratory Accreditation (USA) according to ISO/IEC 17025 for electromagnetic compatibility, product safety, telecommunications testing and environmental simulation (for exact scope please refer to Certificate No. 839.01).

Address: P.O. Box 23, Binyamina 30500, Israel.
Telephone: +972 4628 8001
Fax: +972 4628 8277
e-mail: mail@hermonlabs.com
website: www.hermonlabs.com

Person for contact: Mr. Alex Usoskin, CEO.

13 APPENDIX D Specification references

47CFR part 22:2006	Public Mobile Services
47CFR part 24: 2006	Personal Communications Services
47CFR part 15:2006	Radio Frequency Devices
ANSI C63.2: 1996	American National Standard for Instrumentation-Electromagnetic Noise and Field Strength, 10 kHz to 40 GHz-Specifications.
ANSI C63.4: 2003	American National Standard for Methods of Measurement of Radio-Noise Emissions from Low-Voltage Electrical and Electronic Equipment in the Range of 9 kHz to 40 GHz.

14 APPENDIX E Test equipment correction factors

**Correction factor
Line impedance stabilization network
Model NNB-2/16Z, Rolf Heine, HL 2888**

Frequency, kHz	Insertion loss, dB		Measurement Uncertainty, dB
	L1	N	
10	0.48	0.79	±0.6
20	0.52	0.63	
30	0.31	0.35	
40	0.20	0.22	
50	0.16	0.17	
100	0.10	0.08	
300	0.08	0.06	
500	0.10	0.06	
600	0.09	0.07	
800	0.10	0.07	
1000	0.10	0.08	
2000	0.12	0.11	
3000	0.16	0.14	
4000	0.17	0.18	
6000	0.26	0.23	
10000	0.49	0.41	
14000	0.66	0.54	
16000	0.79	0.69	
18000	0.86	0.76	
20000	0.96	0.85	
25000	1.22	1.08	
28000	1.35	1.21	
30000	1.43	1.29	

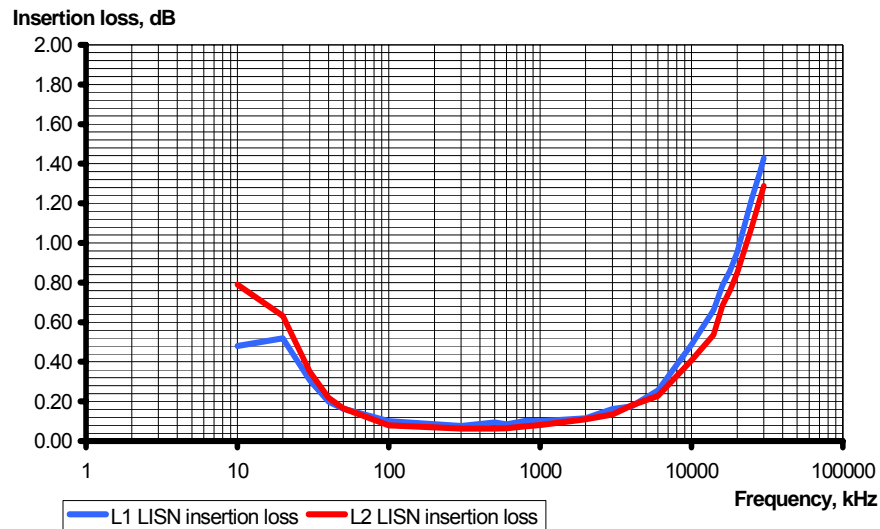

The correction factor in dB is to be added to meter readings of an interference analyzer or a spectrum analyzer.

Antenna factor
Biconilog antenna EMCO, model 3141, serial number 1011, HL 0604

Frequency, MHz	Antenna factor, dB(1/m)	Frequency, MHz	Antenna factor, dB(1/m)	Frequency, MHz	Antenna factor, dB(1/m)
26	7.8	560	19.8	1300	27.0
28	7.8	580	20.6	1320	27.8
30	7.8	600	21.3	1340	28.3
40	7.2	620	21.5	1360	28.2
60	7.1	640	21.2	1380	27.9
70	8.5	660	21.4	1400	27.9
80	9.4	680	21.9	1420	27.9
90	9.8	700	22.2	1440	27.8
100	9.7	720	22.2	1460	27.8
110	9.3	740	22.1	1480	28.0
120	8.8	760	22.3	1500	28.5
130	8.7	780	22.6	1520	28.9
140	9.2	800	22.7	1540	29.6
150	9.8	820	22.9	1560	29.8
160	10.2	840	23.1	1580	29.6
170	10.4	860	23.4	1600	29.5
180	10.4	880	23.8	1620	29.3
190	10.3	900	24.1	1640	29.2
200	10.6	920	24.1	1660	29.4
220	11.6	940	24.0	1680	29.6
240	12.4	960	24.1	1700	29.8
260	12.8	980	24.5	1720	30.3
280	13.7	1000	24.9	1740	30.8
300	14.7	1020	25.0	1760	31.1
320	15.2	1040	25.2	1780	31.0
340	15.4	1060	25.4	1800	30.9
360	16.1	1080	25.6	1820	30.7
380	16.4	1100	25.7	1840	30.6
400	16.6	1120	26.0	1860	30.6
420	16.7	1140	26.4	1880	30.6
440	17.0	1160	27.0	1900	30.6
460	17.7	1180	27.0	1920	30.7
480	18.1	1200	26.7	1940	30.9
500	18.5	1220	26.5	1960	31.2
520	19.1	1240	26.5	1980	31.6
540	19.5	1260	26.5	2000	32.0
		1280	26.6		

Antenna factor in dB(1/m) is to be added to receiver meter reading in dB(μ V) to convert it into field intensity in dB(μ V/m).

Antenna factor
Double-ridged wave guide horn antenna
EMC Test Systems, model 3115, serial no: 9911-5964, HL 1984

Frequency, MHz	Antenna gain, dBi	Antenna factor. dB(1/m)
1000.0	5.8	24.5
1500.0	9.0	24.8
2000.0	8.6	27.7
2500.0	9.5	28.7
3000.0	8.9	30.8
3500.0	8.2	32.9
4000.0	9.6	32.7
4500.0	11.2	32.1
5000.0	10.6	33.6
5500.0	9.8	35.3
6000.0	10.1	35.7
6500.0	10.7	35.8
7000.0	10.9	36.2
7500.0	10.5	37.2
8000.0	11.1	37.2
8500.0	10.8	38.1
9000.0	10.7	38.6
9500.0	11.5	38.3
10000.0	11.8	38.4
10500.0	12.3	38.3
11000.0	12.3	38.8
11500.0	11.5	39.9
12000.0	12.2	39.6
12500.0	12.6	39.5
13000.0	12.0	40.5
13500.0	11.7	41.1
14000.0	11.7	41.5
14500.0	12.7	40.8
15000.0	14.2	39.5
15500.0	16.0	38.1
16000.0	16.2	38.1
16500.0	14.5	40.1
17000.0	12.2	42.6
17500.0	9.7	45.4
18000.0	6.6	48.7

Antenna factor is to be added to receiver meter reading in dB(μ V) to convert it into field intensity in dB(μ V/m).

Antenna Factor
Active Loop Antenna
EMC Test Systems, model 6502, serial number 2857, HL 0446

Frequency, MHz	Magnetic Antenna Factor, dB(S/m)	Electric Antenna Factor, dB(1/m)
0.009	-32.8	18.7
0.010	-33.8	17.7
0.020	-38.3	13.2
0.050	-41.1	10.4
0.075	-41.3	10.2
0.100	-41.6	9.9
0.150	-41.7	9.8
0.250	-41.6	9.9
0.500	-41.8	9.7
0.750	-41.9	9.6
1.000	-41.4	10.1
2.000	-41.5	10.0
3.000	-41.4	10.1
4.000	-41.4	10.1
5.000	-41.5	10.0
10.000	-41.9	9.6
15.000	-41.9	9.6
20.000	-42.2	9.3
25.000	-42.8	8.7
30.000	-44.0	7.5

Antenna factor in dB(S/m) is to be added to receiver meter reading in dB(μ V) to convert it into field intensity in dB(μ A/m).

Cable loss
Cable Coaxial, GORE A2P01POL118, 2.3 m, model:GORE-3, HL 0589
+ Cable Coaxial, ANDREW PSWJ4, 6m, model: ANDREW-6, HL 1004

No.	Frequency, MHz	Cable loss, dB	Tolerance (Specification), dB	Measurement uncertainty, dB	
1	30	0.33	≤ 6.5	±0.12	
2	50	0.40			
3	100	0.57			
4	300	0.97			
5	500	1.25			
6	800	1.59			
7	1000	1.81			
8	1200	1.97			
9	1400	2.15			
10	1600	2.28			
11	1800	2.43			
12	2000	2.61			
13	2200	2.75			
14	2400	2.89			
15	2600	2.97			
16	2800	3.21	≤ 6.5	±0.12	
17	3000	3.32			
18	3300	3.47			
19	3600	3.62			
20	3900	3.84			
21	4200	3.92			±0.17
22	4500	4.07			
23	4800	4.36			
24	5100	4.62			
25	5400	4.78			
26	5700	5.16			
27	6000	5.67			
28	6500	5.99			

Cable loss
Cable coaxial, 6 m, model: M17/167 MIL-C-17, HL 1503

Frequency, MHz	Cable loss, dB
0.15	0.043
1	0.077
3	0.139
5	0.169
10	0.248
30	0.430
50	0.561
75	0.697
100	0.822
300	1.446
500	1.901
800	2.663
1000	2.829
1500	3.569
2000	4.179

Cable loss
Cable M17/167 MIL-C-17, HL 1510

No.	Frequency, MHz	Cable loss, dB
1	0.1	0.05
2	1	0.09
3	3	0.16
4	5	0.18
5	10	0.27
6	30	0.44
7	50	0.58
8	80	0.69
9	100	0.82
10	300	1.48
11	500	2.01
12	800	2.65
13	1000	3.12

Cable loss
Cable 18 GHz, 6.5 m, blue, model: NPS-1803A-6500-NPS, S/N T4974, HL 1947

Frequency, GHz	Cable loss, dB
0.03	0.30
0.05	0.38
0.10	0.53
0.20	0.74
0.30	0.91
0.40	1.05
0.50	1.18
0.60	1.29
0.70	1.40
0.80	1.50
0.90	1.59
1.00	1.68
1.10	1.77
1.20	1.86
1.30	1.94
1.40	2.01
1.50	2.08
1.60	2.16
1.70	2.22
1.80	2.29
1.90	2.36
2.00	2.42
2.10	2.48
2.20	2.54
2.30	2.60
2.40	2.66
2.50	2.71
2.60	2.77
2.70	2.83
2.80	2.89
2.90	2.95
3.10	3.06
3.30	3.17
3.50	3.28
3.70	3.39
3.90	3.51
4.10	3.62
4.30	3.76
4.50	3.87
4.70	4.01
4.90	4.10
5.10	4.21
5.30	4.31
5.50	4.43
5.70	4.56
5.90	4.71

Frequency, GHz	Cable loss, dB
6.10	4.87
6.30	4.95
6.50	4.94
6.70	4.88
6.90	4.87
7.10	4.83
7.30	4.85
7.50	4.86
7.70	4.91
7.90	4.96
8.10	5.03
8.30	5.08
8.50	5.13
8.70	5.21
8.90	5.22
9.10	5.34
9.30	5.35
9.50	5.52
9.70	5.51
9.90	5.66
10.10	5.70
10.30	5.78
10.50	5.79
10.70	5.82
10.90	5.86
11.10	5.94
11.30	6.06
11.50	6.21
11.70	6.44
11.90	6.61
12.10	6.76
12.40	6.68
13.00	6.66
13.50	6.81
14.00	6.90
14.50	6.90
15.00	6.97
15.50	7.17
16.00	7.28
16.50	7.27
17.00	7.38
17.50	7.68
18.00	7.92

Cable loss
RF cable 8 m, model RG-214, HL 2009

No.	Frequency, MHz	Cable loss, dB	Tolerance (Specification), dB	Measurement uncertainty, dB
1	1	0.10	NA	±0.12
2	10	0.14		
3	30	0.25		
4	50	0.34		
5	100	0.53		
6	300	0.99		
7	500	1.31		
8	800	1.73		
9	1000	1.98		
10	1100	2.11		
11	1200	2.21		
12	1300	2.35		
13	1400	2.46		
14	1500	2.55		
15	1600	2.68		
16	1700	2.78		
17	1800	2.88		
18	1900	2.98		
19	2000	3.09		

Cable loss
Cable coaxial, Gore, 18 GHz, 3m, SMA-SMA, S/N 989370
HL 2910

Frequency, GHz	Cable loss, dB	Frequency, GHz	Cable loss, dB	Frequency, GHz	Cable loss, dB
10	0.07	5750	2.97	12000	5.05
30	0.19	6000	2.91	12250	4.44
100	0.36	6250	3.23	12500	4.82
250	0.53	6500	3.42	12750	5.22
500	0.77	6750	3.17	13000	5.02
750	0.94	7000	3.56	13250	5.00
1000	1.10	7250	3.77	13500	5.09
1250	1.19	7500	3.48	13750	4.70
1500	1.35	7750	3.81	14000	5.03
1750	1.51	8000	3.82	14250	5.17
2000	1.57	8250	3.62	14500	4.92
2250	1.69	8500	3.95	14750	4.91
2500	1.76	8750	4.00	15000	5.03
2750	1.83	9000	3.80	15250	4.93
3000	2.02	9250	4.09	15500	5.28
3250	2.17	9500	4.12	15750	5.60
3500	2.13	9750	4.11	16000	5.16
3750	2.23	10000	4.36	16250	5.45
4000	2.40	10250	4.75	16500	5.78
4250	2.31	10500	4.61	16750	5.47
4500	2.52	10750	4.26	17000	5.21
4750	2.77	11000	4.62	17250	5.53
5000	2.82	11250	4.55	17500	5.53
5250	2.77	11500	4.59	17750	5.71
5500	3.04	11750	5.20	18000	5.77

Cable loss
Cable coaxial, Gore, 18 GHz, 1.5 m, SMA-SMA, S/N 91P72067
HL 2912

Frequency, GHz	Cable loss, dB	Frequency, GHz	Cable loss, dB	Frequency, GHz	Cable loss, dB
10	0.07	5750	1.56	12000	2.23
30	0.10	6000	1.48	12250	2.14
100	0.17	6250	1.55	12500	2.19
250	0.28	6500	1.52	12750	2.14
500	0.43	6750	1.57	13000	2.24
750	0.52	7000	1.59	13250	2.19
1000	0.59	7250	1.64	13500	2.24
1250	0.66	7500	1.66	13750	2.14
1500	0.72	7750	1.78	14000	2.29
1750	0.81	8000	1.87	14250	2.41
2000	0.82	8250	1.78	14500	2.48
2250	0.94	8500	1.79	14750	2.31
2500	0.94	8750	1.88	15000	2.45
2750	0.99	9000	2.01	15250	2.55
3000	1.03	9250	1.90	15500	2.75
3250	1.15	9500	1.90	15750	2.75
3500	1.13	9750	1.90	16000	2.68
3750	1.17	10000	2.03	16250	2.73
4000	1.19	10250	2.04	16500	2.82
4250	1.31	10500	2.26	16750	2.79
4500	1.24	10750	2.09	17000	2.87
4750	1.30	11000	2.05	17250	2.80
5000	1.31	11250	2.15	17500	2.90
5250	1.41	11500	2.34	17750	2.82
5500	1.41	11750	2.34	18000	2.90

15 APPENDIX F Abbreviations and acronyms

A	ampere
AC	alternating current
AM	amplitude modulation
AVRG	average (detector)
cm	centimeter
dB	decibel
dBm	decibel referred to one milliwatt
dB(μ V)	decibel referred to one microvolt
dB(μ V/m)	decibel referred to one microvolt per meter
dB(μ A)	decibel referred to one microampere
dB Ω	decibel referred to one Ohm
DC	direct current
DTS	digital transmission system
EIRP	equivalent isotropically radiated power
ERP	effective radiated power
EUT	equipment under test
F	frequency
GHz	gigahertz
GND	ground
H	height
HL	Hermon laboratories
Hz	hertz
ITE	information technology equipment
k	kilo
kHz	kilohertz
LISN	line impedance stabilization network
LO	local oscillator
m	meter
MHz	megahertz
min	minute
mm	millimeter
ms	millisecond
μ s	microsecond
NA	not applicable
OATS	open area test site
Ω	Ohm
PM	pulse modulation
ppm	part per million (10^{-6})
QP	quasi-peak
RE	radiated emission
RF	radio frequency
rms	root mean square
Rx	receive
s	second
T	temperature
Tx	transmit
V	volt
VA	volt-ampere