

PC9155 Wireless Alarm System

User Manual

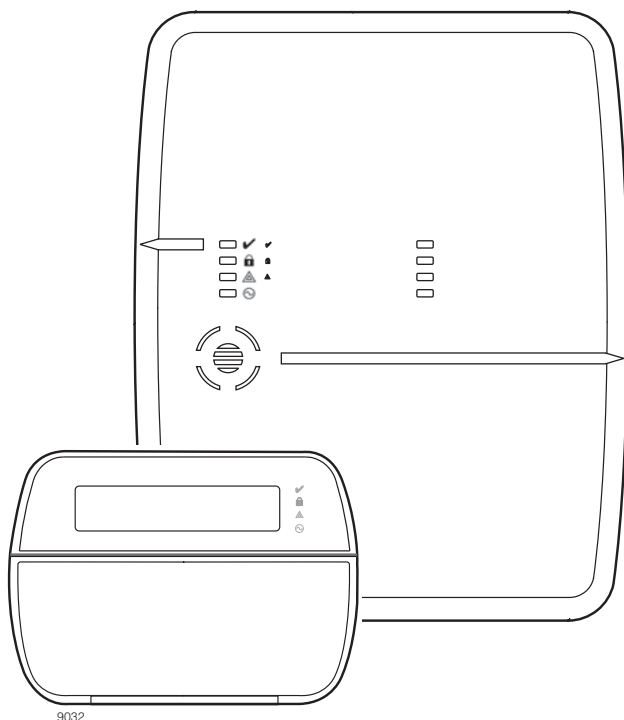

DSC®
PowerSeries™



SECURITY SYSTEM

WARNING: This manual contains information on limitations regarding product use and function and information on the limitations as to liability of the manufacturer. The entire manual should be carefully read.

FCC COMPLIANCE STATEMENT

CAUTION: Changes or modifications not expressly approved by Digital Security Controls could void your authority to use this equipment.

This equipment has been tested and found to comply with the limits for a Class B digital device, pursuant to Part 15 of the FCC Rules. These limits are designed to provide reasonable protection against harmful interference in a residential installation. This equipment generates, uses and can radiate radio frequency energy and, if not installed and used in accordance with the instructions, may cause harmful interference to radio communications. However, there is no guarantee that interference will not occur in a particular installation. If this equipment does cause harmful interference to radio or television reception, which can be determined by turning the equipment off and on, the user is encouraged to try to correct the interference by one or more of the following measures:

- Re-orient the receiving antenna.
- Increase the separation between the equipment and receiver.
- Connect the equipment into an outlet on a circuit different from that to which the receiver is connected.
- Consult a dealer or experienced radio/television technician for help.

The user may find the following booklet prepared by the FCC useful: 'How to Identify and Resolve Radio/Television Interference Problems'. This booklet is available from the U.S. Government Printing Office, Washington D.C. 20402, Stock # 004-000-00345-4.

IMPORTANT INFORMATION

This equipment complies with Part 68 of the FCC Rules and, if the product was approved July 23, 2001 or later, the requirements adopted by the ACTA. On the top side of this equipment is a label that contains, among other information, a product identifier. If requested, this number must be provided to the Telephone Company.

Product Identifier: US:F53AL01B9155
USOC Jack: RJ-31X

Telephone Connection Requirements

A plug and jack used to connect this equipment to the premises wiring and telephone network must comply with the applicable FCC Part 68 rules and requirements adopted by the ACTA. A compliant telephone cord and modular plug is provided with this product. It is designed to be connected to a compatible modular jack that is also compliant. See installation instructions for details.

Ringer Equivalence Number (REN)

The REN is used to determine the number of devices that may be connected to a telephone line. Excessive RENs on a telephone line may result in the devices not ringing in response to an incoming call. In most but not all areas, the sum of RENs should not exceed five (5.0). To be certain of the number of devices that may be connected to a line, as determined by the total RENs, contact the local Telephone Company. For products approved after July 23, 2001, the REN for this product is part of the product identifier that has the format US:AAAEQ##TXXXX. The digits represented by ## are the REN without a decimal point (e.g., .03 is a REN 0.3). For earlier products, the REN is separately shown on the label. REN = 0.1B

Incidence of Harm

If this equipment (PC9155-433) causes harm to the telephone network, the telephone company will notify you in advance that temporary discontinuance of service may be required. But if advance notice is not practical, the Telephone Company will notify the customer as soon as possible. Also, you will be advised of your right to file a complaint with the FCC if you believe it is necessary.

Changes in Telephone Company Equipment or Facilities

The Telephone Company may make changes in its facilities, equipment, operations or procedures that could affect the operation of the equipment. If this hap-

pens the Telephone Company will provide advance notice in order for you to make necessary modifications to maintain uninterrupted service.

Equipment Maintenance Facility

If trouble is experienced with this equipment (PC9155/WT5500) for repair or warranty information, contact the facility indicated below. If the equipment is causing harm to the telephone network, the Telephone Company may request that you disconnect the equipment until the problem is solved. This equipment is of a type that is not intended to be repaired by the end user.

DSC c/o APL Logistics 757 Douglas Hill Rd., Lithia Springs, GA 30122

Additional Information

Connection to party line service is subject to state tariffs. Contact the state public utility commission, public service commission or corporation commission for information.

Alarm dialling equipment must be able to seize the telephone line and place a call in an emergency situation. It must be able to do this even if other equipment (telephone, answering system, computer modem, etc.) already has the telephone line in use. To do so, alarm dialling equipment must be connected to a properly installed RJ-31X jack that is electrically in series with and ahead of all other equipment attached to the same telephone line. Proper installation is depicted in the figure below. If you have any questions concerning these instructions, you should consult your telephone company or a qualified installer about installing the RJ-31X jack and alarm dialling equipment for you.

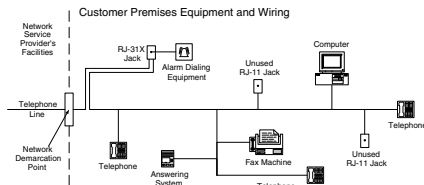

INDUSTRY CANADA STATEMENT

NOTICE: This product meets the applicable Industry Canada technical specifications.

Le présent matériel est conforme aux spécifications techniques applicables d'Industrie Canada.

The Ringer Equivalence Number (REN) for this terminal equipment is 0.1.

L'indice d'équivalence de la sonnerie (IES) du présent matériel est de 0.1.

The Ringer Equivalence Number is an indication of the maximum number of devices allowed to be connected to a telephone interface. The termination on an interface may consist of any combination of devices subject only to the requirement that the sum of the RENs of all the devices does not exceed five.

L'indice d'équivalence de la sonnerie

(IES) sert à indiquer le nombre maximal de terminaux qui peuvent être raccordés à une interface téléphonique. La terminaison d'une interface peut consister en une combinaison quelconque de dispositifs, à la seule condition que la somme d'indices d'équivalence de la sonnerie de tous les dispositifs n'exécède pas 5.

The term 'IC': before the radio certification number only signifies that Industry Canada technical specifications were met.

Certification Number IC: 160A-PC9155

This Class B digital apparatus complies with Canadian ICES-003.

Cet appareil numérique de la classe B est conforme à la norme NMB-003 du Canada.

New Zealand - The following is a list of warnings applicable when this equipment is connected to the New Zealand Telecom Network.



General Warning

The grant of a Telepermit for any item of terminal equipment indicates only that Telecom has accepted that the item complies with minimum conditions for connection to its network. It indicates no endorsement of the product by Telecom, nor does it provide any sort of warranty. Above all, it provides no assurance that any item will work correctly in all respects with another item of Telepermitted equipment of a different make or model, nor does it imply that any product is compatible with all of Telecom's network services.

Reverse Numbering (decadic signalling)

Decadic signalling should not be used as it is being progressively phased out of the network. DTMF dialling is 100% available and it should always be used.

Line Grabbing Equipment

This equipment is set up to carry out test calls at pre-determined times. Such test calls will interrupt any other calls that may be set up on the line at the same time. The timing set for such test calls should be discussed with the installer.

The timing set for test calls from this equipment may be subject to 'drift'. If this proves to be inconvenient and your calls are interrupted, then the problem of timing should be discussed with the equipment installer. The matter should NOT be reported as a fault to Telecom Faults Service.

D.C. Line Feed to Other Devices

During dialling, this device unit does not provide DC voltage to the series port connection and this may cause loss of memory functions for the terminal devices (local telephone) connected to T-1, R-1.

General Operation (ringer sensitivity and loading)

This device only responds to Distinctive Alert cadences DA1 and DA2.

Table of Contents

About Your Security System	1
Fire Detection	1
Testing	1
Monitoring	1
Maintenance	1
General System Operation	1
Controls & Indicators	2
Language Selection	2
Arming & Disarming the System	2
Stay Arming	2
Night Arming	2
Silent Exit Delay	3
Away Arming	3
Quick Exit	3
Bell/Siren Sounds After Away Arming	3
Disarming	3
Remote Arming and Disarming	4
Emergency Keys	4
When Alarm Sounds	4
Intrusion (Burglar) Alarm Continuous Siren	4
Fire Alarm Pulsed Siren	4
Time & Date Programming	4
Bypassing Zones	5
Trouble Conditions	6
Alarm Memory	6
Door Chime (Entry/Exit Beeps)	6
Access Code Programming	6
Access Codes	7
User Code Attributes	7
Zone Bypassing Attribute	8
Bell Squawk Attribute	8
Erasing an Access Code	8
User Function Commands	8
Changing Brightness/Contrast	8
Changing the Buzzer Level	8
Viewing the Event Buffer	9
Late to Open	9
Proximity Tags	9
2-Way Wireless Keys	9
Function Keys	9
Display Icons	10
Buzzer	10
Keylock Mode	10
Testing Your System	10
Sounder and Display Test	10
Walk Test	11
Allowing Computer Access To Your System	11

Reference Sheets	11
System Information	11
Access Codes	12
Sensor / Zone Information	12
Guidelines for Locating Smoke Detectors	14
Household Fire Safety Audit	15
Fire Escape Planning	15

Always ensure you obtain the latest version of the User Guide. Updated versions of this User Guide are available by contacting your distributor.

IMPORTANT SAFETY INSTRUCTIONS

To reduce the risk of fire, electric shock and/or injury, observe the following:

- Do not spill any type of liquid on the equipment.
- Do not attempt to service this product yourself. Opening or removing the cover may expose you to dangerous voltage or other risk. Refer servicing to qualified service personnel. Never open the device yourself.
- Do not touch the equipment and its connected cables during an electrical storm; there may be a risk of electric shock from lightening.
- Do not use the Alarm System to report a gas leak if it is near the leak.

REGULAR MAINTENANCE AND TROUBLESHOOTING

Keep your Alarm Controller in optimum condition by following all the instructions that are included within this manual and/or marked on the product.

CLEANING

- Clean the enclosure (case) by wiping with a damp cloth only.
- Do not use abrasives, thinners, solvents or aerosol cleaners (spray polish) that may enter through holes in the enclosure (case) of the Alarm Controller and cause damage.
- Do not use any water or any other liquid.
- Do not wipe the front cover with alcohol.

TROUBLESHOOTING

Occasionally, you may have a problem with your Alarm Controller or telephone line. If this happens, your Alarm Controller usually identifies the problem and displays an error message. Refer to the provided list when you see an error message on the display. If additional help is required, contact your distributor for service.

WARNING: This equipment, PC9155 Alarm System shall be installed and used within an environment that provides the pollution degree max 2 and over-voltages category II non-hazardous locations, indoor only. It is designed to be installed, serviced and/or repaired by service persons only; [service person is defined as a person having the appropriate technical training and experience necessary to be aware of hazards to which that person may be exposed in performing a task and of measures to minimize the risks to that person or other persons]. For EU and Australian Markets, the equipment is permanently connected; an accessible disconnect device shall be incorporated in the building installation wiring. For North America it is a direct plug-in connection; the socket outlet shall be installed near the PC9155 and shall be easily accessible. The plug of the direct plug-in transformer serves as the disconnect device.

NOTE: There are no parts replaceable by the end-user within this equipment.

This publication covers the following models:

- | | | | |
|---------------|---------------|---------------|---------------|
| • PC9155-433 | • PC9155-868 | • WT5500-433 | • WT5500P-868 |
| • PC9155D-433 | • PC9155D-868 | • WT5500P-433 | • PT4 |
| • PC9155G-433 | • PC9155G-868 | • WT5500-868 | • PT8 |

NOTE: 868 MHz models are not UL/ULC listed.

About Your Security System

Read this manual carefully and have your installer instruct you on your system's operation and on which features have been implemented in your system. All users of this system should be equally instructed in its use. Fill out the 'System Information' page with all of your zone information and access codes and store this manual in a safe place for future reference.

NOTE: Please consult your installer for further information regarding the false alarm reduction features built into your system as all are not covered in this manual.

Fire Detection

This equipment is capable of monitoring fire detection devices such as smoke detectors and providing a warning if a fire condition is detected. Good fire detection depends on having adequate number of detectors placed in appropriate locations. This equipment should be installed in accordance with NFPA 72 (N.F.P.A., Battery March Park, Quince MA 02269). Carefully review the Family Escape Planning guidelines in this manual.

NOTE: Your installer must enable fire detection before it becomes functional.

Testing

To ensure that your system continues to function as intended, you must test your system weekly. Please refer to the 'Testing your System' section in this manual. If your system does not function properly, call your installing company for service.

Monitoring

This system is capable of transmitting alarms, troubles & emergency information to a central station. If you initiate an alarm by mistake, immediately call the central station to prevent an unnecessary response.

NOTE: The monitoring function must be enabled by the installer before it becomes functional.

NOTE: This system has a communicator delay of 30 seconds. It can be removed, or it can be increased up to 45 seconds by the installer.

NOTE: Ensure that your Installer verifies that your system is compatible with the Central Station Receiver format at yearly intervals.

Maintenance

With normal use, the system requires minimum maintenance. Note the following points:

- Do not wash the security equipment with a wet cloth. Light dusting with a slightly moistened cloth should remove normal accumulations of dust.
- The standby battery shall be replaced every 4-5 years by service persons only.

NOTE: Do not attempt to replace the battery or open the enclosure, there is a risk of electric shock and/or fire.

- For other system devices such as smoke detectors, motion detectors, glassbreak detectors or door/window contacts, consult the manufacturer's literature for testing and maintenance instructions if applicable.

General System Operation

Your security system includes an alarm control/keypad and various sensors and detectors. The keypad is mounted by the main exit/entry location.

The security system has several zones of area protection. Each of these zones communicates to a single wireless sensor (motion detectors, glassbreak detectors, door contacts, etc.) or to one or more hard wired sensors. A sensor in alarm is indicated by messages on the LCD keypad.

Additional features include Automatic Inhibit (Swinger Shutdown) for Alarm; Tamper and Trouble signals after 3 occurrences in a given set period; and a Programmable Keypad Lockout option.

For SIA CP-01 classified installations, the swinger shutdown feature is programmed such that one or two trips will shut down the zone. The zone will be restored after a manual reset (by entering the access code at the time of disarming the alarm system) or it will be reset automatically after 48 hours with no trips on any zones.

NOTE: Only the installer or service professional should have access to the system.

Keypad Controls & Indicators

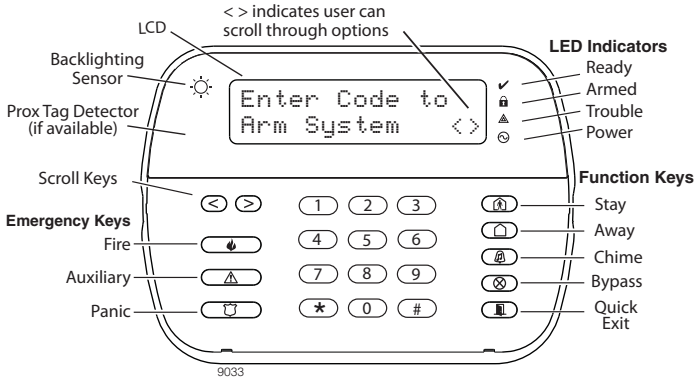

IMPORTANT NOTICE

A security system cannot prevent emergencies. It is only intended to alert you and – if included – your central station of an emergency situation. Security systems are generally very reliable but they may not work under all conditions and they are not a substitute for prudent security practices or life and property insurance. Your security system should be installed and serviced by qualified security professionals who should instruct you on the level of protection that has been provided and on system operations.

Language Selection

Your system can display messages in different languages.

1. Press and hold both buttons simultaneously.
2. Using the buttons, scroll through the available languages.
3. Press to select your desired language.

Arming & Disarming the System

Stay Arming

Stay arming will bypass the interior protection (i.e. motion sensors) and arm the perimeter of the system (i.e. doors and windows). Close all sensors (i.e. stop motion and close doors). The Ready () indicator should be on.

Press and hold the Stay () button until it beeps (approx. 2 seconds) and/or enter your Access Code and do not leave the premises. During the setting state (exit delay active), the Armed () and Ready () indicators will light.

When the exit delay is completed, the alarm system is armed/set and this is indicated on the keypad as follows: the Ready () indicator will turn off, the Armed () indicator will remain on.

The Armed () indicator and a bypass message will be displayed. The system will automatically bypass certain interior sensors (i.e. motion sensors).

NOTE: For SIA FAR listed panels, the Stay Arming Exit Delay will be twice as long as the Away Arming Exit Delay.

NOTE: If your system is installed in accordance with SIA CP-01 Standard for False Alarm Reduction then the security system will arm in the Stay Armed mode if the exit delay time expires and no exit has been made.

Night Arming

To fully arm the system when it has been armed in Stay Mode, press at the keypad. All interior zones will now be armed except for devices programmed as Night Zones.

NOTE: Your installer can also program a function key on the keypad to allow you to arm the system in Night Mode. This would allow Night Arming to be activated by holding down a function key for 2 seconds.

Night zones are only armed in Away mode, this permits limited movement within the premises when the system is fully armed. Ensure that your installer has provided you with a list identifying zones programmed as night zones.

When the interior zones are activated (i.e., ***** **1**) you must enter your access code to disarm the system to gain access to interior areas that have not been programmed as night zones.

Silent Exit Delay

If the system is armed using the Stay button or using the 'No Entry' Arming method (***** **5** [access code]), the audible progress annunciation (keypad buzzer) will be silenced and the exit time will be doubled for that exit period only.

Away Arming

Close all sensors (i.e. stop motion and close doors). The Ready (**✓**) indicator should be on.

To arm, press and hold the Away Button for 2 seconds and/or enter your Access Code, or press ***** **0** to Quick Arm.

During the setting state (exit delay active) the Armed (**Ⓜ**) and Ready (**✓**) indicators will turn on, and the keypad will sound one beep per second. You now have ____ seconds to leave the premises (please check with your installer to have this time programmed). An audible annunciation, whose pulsating rate is distinctly different, will sound during the last ten seconds of the exit delay to warn person(s) that the exit delay is running out. To cancel the arming sequence, enter your access code or present your prox tag.

When the exit delay is completed, the alarm system is armed and this is indicated on the keypad as follows: the Ready (**✓**) indicator will turn off, the Armed (**Ⓜ**) indicator will remain on and the keypad will stop sounding.

The system can also be armed/disarmed with a wireless key and with proximity tags. Refer to the 'Proximity Tags' and '2-Way Wireless Key' sections on page 9 for more details.

NOTE: If your system is installed in accordance with SIA CP-01 Standard for False Alarm Reduction then the violation, restoral followed by a second violation of the entry/exit zone before the end of the exit delay will restart the exit delay.

Quick Exit

If the system is armed and you need to exit, use the Quick Exit function to avoid disarming and rearming the system. Press and hold the Quick Exit button for 2 seconds or press ***** **0**. You now have 2 minutes to leave the premises through your exit door. When the door is closed again, the remaining exit time is cancelled.

Bell/Siren Sounds After Away Arming

Audible Exit Fault

In order to reduce false alarms, the Audible Exit Fault is designed to notify you of an improper exit when arming the system. If you fail to securely close the Exit/Entry door during the programmed exit delay period, the system will sound the alarm to indicate an improper exit (your installer will tell you if this feature has been enabled on your system). If this occurs:

1. Re-enter the premises.
2. Enter your access code, or present your prox tag, before the entry delay timer expires, to disarm the system.
3. Follow the Away arming procedure again, ensure that the entry/exit door(s) are secured.

Arming Error

An error tone will sound if the system is unable to arm. This will happen if the system is not ready to arm (i.e. sensors are open), or if an incorrect user code has been entered. If this happens, ensure all sensors are secure, press **#** and try again.

Disarming

Enter your access code to disarm the system when it is armed (Armed (**Ⓜ**) indicator is on). The keypad will sound a continuous tone after the entry delay has been initiated by opening the entry/exit door. Enter your code within _____ seconds to avoid an alarm condition (check with your installer to have this time programmed).





Disarming Error

If your code is invalid, the system will not disarm and a 2-second error tone will sound. If this happens, press **#** and try again.

Remote Arming and Disarming

The system can be armed and/or disarmed, if programmed by the installer, using a remote control device (wireless key). When arming the system using the Arm button on a 1-way wireless key, the system will acknowledge the command by sounding a single bell squawk. When disarming using the Disarm button on a 1-way wireless key, the system will acknowledge the command by sounding two bell squawks. Three squawks when disarming with the disarm button indicates that an alarm occurred while the system was armed. If you are unsure of the cause of the alarm, proceed with caution (see section on 2-Way Wireless Keys).

Emergency Keys

Press the  (Fire),  (Auxiliary) or  (Panic) button for 2 seconds to generate a Fire, Auxiliary or Panic alarm. The keypad sounder will beep indicating that the alarm input has been accepted and transmission to the central station is underway. The  button may or may not sound the bell depending on installer setup.

NOTE: The Fire button can be disabled by the installer.

When Alarm Sounds

The system can generate 2 different alarm sounds:

- Continuous Siren = Intrusion/Burglary Alarm
- Temporal / Pulsed Siren = Fire Alarm
- 4 beeps, 5-second pause, 4 beeps = Carbon Monoxide alarm

Intrusion (Burglary) Alarm Continuous Siren

If you are unsure of the source of the alarm, proceed with caution! If the alarm was accidental, enter your Access Code to silence the alarm. If the alarm system is disarmed within the programmed Abort Window (check with the installer if this option has been enabled on your system and what is the transmitter delay time programmed), no alarm transmission to the Central Station will occur. Starting at the end of the Abort Window there is a five minute Cancel window, during which a user can cancel, by entering his access code, an alarm that has been previously transmitted. A cancel signal will be transmitted to the Central Station and the alarm system will also announce that the cancel signal was transmitted. Call your central station to avoid a dispatch.

Fire Alarm Pulsed Siren



Follow your emergency evacuation plan immediately!

If the fire alarm was accidental (i.e. burned toast, bathroom steam, etc.), enter your Access Code to silence the alarm. Call your central station to avoid a dispatch.

Carbon Monoxide Alarm







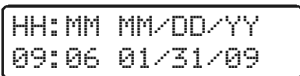

Activation of your CO alarm indicates the presence of carbon monoxide (CO) which can be fatal. During an alarm, the red LED light flashes rapidly and buzzer sounds with a repeating cadence of: 4 quick beeps, 5 second pause, 4 quick beeps. If alarm sounds:

1. Operate silence button.
2. Call your emergency services or fire department or 911.
3. Immediately move to the fresh air outdoors or by an open door/window.

WARNING: Carefully review your Carbon Monoxide Installer/User Guide to determine the necessary actions required to ensure your safety and ensure that the equipment is operating correctly. Incorporate the steps outlined in the guide into your evacuation plan.

Time & Date Programming



Press   then your Master Access Code to enter User Functions. Use the   buttons to find the menu option then press  to select. Enter the time in 24-hr. format (HH:MM), followed by the date (MM/DD:YY). Press  to exit programming. If you are viewing a 'Loss of Clock', trouble from within the trouble menu ( ), press  to directly enter Date and Time programming (see Trouble Conditions on page 6).

NOTE: Your installer may have programmed your system to display the time and date while the keypad is idle. Press the  button to temporarily clear the date and time display if desired.

Bypassing Zones

Use the zone bypassing feature when you need access to a protected area while the system is armed, or when a zone is temporarily out of service but you need to arm the system. Bypassed zones will not be able to sound an alarm. Bypassing zones reduces the level of security. If you are bypassing a zone because it is not working, call a service technician immediately so that the problem can be resolved and your system returned to proper working order. Ensure that no zones are unintentionally bypassed when arming your system. Zones cannot be bypassed once the system is armed. Bypassed zones (except for 24-hr zones) are automatically cancelled each time the system is disarmed and must be bypassed again, if required, before the next arming.

With the system disarmed:

1. Press ***** to enter the function menu, the keypad will display the screen on the right.
2. Press **1** or *****.
3. If your system is programmed to require access codes this screen will be displayed. Enter your 4-digit access code.
4. Scroll to the desired zone number using the **<** **>** keys, then press ***** to select the zone OR
5. Directly enter the 2-digit number of the zone you wish to bypass (e.g., 0 5 for zone 5).

Press (*) for <>
Zone Bypass

Enter Your
Access Code

Scroll to <>
Bypass Zones

Activating All Bypassed Zones

To remove bypass (all zones):

1. Press ***** **1**, then your access code if required.
2. Press **0** **0**.
3. To exit bypassing mode and return to the Ready state, press **#**.

Recalling Bypassed Zones

To recall the last set of bypassed zones:

1. Press ***** **1**, then your access code if required.
2. Press **9** **9**.
3. To exit bypassing mode and return to the Ready state, press **#**.

Bypass Group

A Bypass Group is a selection of zones programmed into the system. If you bypass a group of zones on a regular basis, you can program them into a Bypass Group, so that you do not have to bypass each zone individually every time. Only one Bypass Group can be programmed.

NOTE: If a group has already been bypassed before programming a Bypass Group, you will be unable to recall that group after programming the new group.

To program a bypass group:

1. Press ***** **1**, then your access code if required.
2. Enter the two-digit numbers (01-34) of the zones to be included in the Bypass Group or use the **<** **>** buttons to find the zone to be included in the bypass group, then press ***** to select the zone.
3. To save the selected zone into the group, press **9** **5**.
4. To exit bypassing mode and return to the Ready state, press **#**.

NOTE: If an access code is required to enter bypassing, only the Master Code and codes with Supervisory enabled can set the Bypass Group.

To select a bypass group when arming the system:

1. Press ***** **1**, then your access code (if necessary).
2. Press **9** **1**. The next time the system is armed, the zones in this group will be bypassed.
3. To exit bypassing mode and return to the Ready state, press **#**.

NOTE: A Bypass Group is only recalled if the system is armed/disarmed after programming the bypass group.

NOTE: This feature is not to be used in UL Listed installations.

Trouble Conditions

When a trouble condition is detected, the Trouble (▲) indicator will turn on, and the keypad will beep every 10 seconds. Press the (#) button to silence the beeps. Press (*)(2) to view the trouble condition. The Trouble (▲) indicator will flash. Use the (<)(>) keys to view troubles.

Trouble Condition	Comments	Action
Alternate Communicator Trouble	Indicates AC Failure, Low Battery, Sim Card lock, GSM Trouble, Ethernet Trouble, Central Station Receiver Trouble, Supervision Config SMS Trouble for GS/IP module if installed. Press (<)(>) to scroll through troubles.	Call for service. For Ethernet Trouble Check LAN connections.
Service Required (Press [1] for more information)	Indicates Low Battery, System Trouble, System Tamper or RF Jam detected.	Call for service.
Loss of AC Power	If the building and/or neighbourhood has lost electrical power, the system will continue to operate on battery for several hours.	Check AC connection. Call for service.
Telephone Line Fault	The system has detected that the telephone line is disconnected.	Call for service.
Failure to Communicate	The system attempted to communicate with the monitoring station but failed. This may be due to a Telephone Line Fault.	Call for service.
Module/Sensor Fault	The system is experiencing difficulties with one or more module/sensors on the system. Continue to press (5) to navigate through the Zone, Keypad and Siren fault menus.	Call for service.
Module/Sensor Tamper	The system has detected a tamper condition with one or more module/sensor on the system. Continue to press (5) to navigate through the Zone, Keypad and Siren tamper menus.	Call for service.
Module/Sensor Low Battery	The system has detected a low battery condition with one or more module/sensor on the system. Continue to press (7) to display the zone(s), wireless key(s), keypad(s), siren(s) and prox tag(s).	Call for service.
Loss of Time & Date	If complete power was lost (AC and Battery), the time and date will need to be re-programmed. Press (*).	Re-program Time & Date (see page 4).

Alarm Memory

When an alarm occurs, the Alarm Memory message will be displayed. To view which sensor(s) generated the alarm, press (*)(3).

For the system keypad use the scroll (<)(>) buttons to view the sensors in alarm memory. Press (#) to exit. To clear the memory, arm and disarm the system. If an alarm sounded while armed, the system will automatically go to alarm memory when you disarm the system. In this instance, you should approach with caution, as the intruder may still be within the building/premises.

Door Chime

To turn the door chime function on or off, press and hold the Chime (Ⓜ) button for 2 seconds or press (*)(4). The system will sound three beeps to indicate the door chime is on or one long tone to indicate that door chime is off.

Access Code Programming

In addition to the Master Access Code, you can program up to 16 additional User Access codes. If wireless keys have been programmed then wireless key #1 will log as User Access code #1 (if that access code has been programmed). User Access codes 1-16 will correspond to wireless keys or prox tags 1-16. Press (*)(5), plus your Master Access Code, the armed (Ⓜ) indicator will turn on.

Enter the 2-digit number to be programmed (i.e. 06 for user access code 6; enter 40 for the Master Access Code) or press the < > buttons to find the specific code and press * to select. Enter the new 4-digit access code. When programming is complete, enter another 2-digit code to program or press # to exit. The access codes have programmable attributes which allow zone bypassing, duress, supervisor or one-time use activation.

Access Codes

[*][5][Master Code] (when disarmed)

The [*][5] User's Programming command is used to program additional access codes.

User Codes - User Codes 1-16 are available for the System.

Master Code (Access Code 40) - The Master Code has all of the attributes listed in the Programmable Attributes list below except for Duress (2) and One Time Use (8) and is required to program all Supervisor Code attributes.

Supervisor Codes - These codes are always valid when entering the * 5 User Code Programming or * 6 User Function sections. However, these codes can only program additional codes which have equal or lesser attributes. Once programmed, the Supervisor Codes receive the Master Code's attributes. These attributes are changeable. Any User Code can be made a supervisor code by enabling User Code Attribute 1 (please see below for details).

Duress Codes - Duress codes are standard User Codes that will transmit the Duress Alarm Reporting Code whenever the code is entered to perform any function on the system. Any User Code can be made a Duress Code by enabling User Code Attribute 2 (see below for details).

One Time Use Code - This code permits temporary access to the system for a 24 hour time period. During the 24hr period, the temporary user may disarm the system once. There is no restriction on the number of times the temporary user may arm the system during the time period.

NOTE: Duress codes are not valid when entering [*][5], [*][6] or [*][8] sections.

NOTE: Access codes cannot be programmed as a duplicate or as a 'Code +/- 1'.

Enrolling/Deleting PT4/PT8 Proximity Tags

Enrolling Proximity Tags

To enrol proximity tags on your security system:

- 1. With the supervisor attribute enabled, enter [*][5] then your access code.
- 2. Select the code number (01-16) associated with the prox tag.
- 3. Enter the code number (01-16), the keypad will then prompt you to swipe your prox tag. The keypad will beep and display 'Tag Accepted'. The tag is now enrolled.

NOTE: If the tag has already been assigned to a user, an error tone will sound.

Deleting Proximity Tags

To remove proximity tags from your system:

- 1. With the supervisor attribute enabled, enter [*][5] then your access code.
- 2. Press >, the prompt 'Delete All Tags' will be displayed on the keypad.
- 3. Press [*] to delete all prox tags.

User Code Attributes

- 1. The default attributes of a new code will be the attributes of the code used to enter * 5 whether it is a new code or an existing code being programmed.
- 2. System Master (Code 40) has Attribute 3 on by default.

NOTE: These attributes are not changeable.

Inherent Attributes (all codes except installer)

Arm / Disarm - Any Access Code will be valid for arming and disarming the system.

Command Outputs ([*][7][1] and [*][7][2]) - If these outputs require Access Code entry, any Access Code is valid for performing the [*][7][1-2][Access Code] functions on the system.

Programmable Attributes ([*][5][Master/Supervisor Code 9][Code])

- 1 Supervisor Code
- 2 Duress Code
- 3 Zone Bypassing Enabled
- 4-6 For Future Use
- 7 Bell Squawk upon Away Arming/Disarming
- 8 One Time Use Code

Zone Bypassing Attribute

This attribute allows the user to manually bypass zones if bypassing requires an access code.

Bell Squawk Attribute

This attribute is used to determine whether an access code should generate an arming/disarming squawk when the away function key is pressed on a wireless key. Contact your installer to have this programmed. The Master Code cannot use Bell Squawk attribute, but is required to enable it for other codes.

NOTE: This feature cannot prevent the Arm/Disarming squawks from being generated if an access code assigned to a wireless key is manually entered at a keypad.

Erasing an Access Code

To erase a code, select the code and enter [*] as the first digit. If [*] is entered, the system will delete the code (including the associated proximity tag) immediately and the user will be returned to select another code.

User Function Commands

Disarm the system then enter [*][B] [Master Code]. The [*][B] command is used to gain access to the following list of Master functions of the system:

[1] Time and Date - Enter 4 digits for 24hr System Time (HH-MM). Valid entries are 00-23 for the hour and 00-59 for minutes. Enter 6 digits for the Month, Day and Year (MM-DD-YY).

[2]-[3] For Future Use.

[4] System Test - The system's Bell Output - 4 seconds (2 seconds medium volume, 2 seconds high volume), keypad lights, back-up battery pack and communicator are tested.

[5] Enable DLS / Allow Remote System Service - If enabled, the installer will be able to access Installer Programming remotely using DLS (Downloading Software). This function provides a window for telephone ring detection by the alarm system. The DLS window will remain open for 6 hours, during which time the installer will be able to enter DLS an unlimited number of times. After the 6-hr window has expired, access to programming via DLS will be unavailable until the window is re-opened.

[6] User Call-up - If enabled by the installer, the panel will make 1 attempt to call the downloading computer. The downloading computer must be waiting for the panel to call before downloading can be performed.

[7] For Future Use.

[8] User Walk Test - Allows the user to enter the Walk Test mode. See Walk Test on page 11.

[9] Late to Open Enable/Disable - This function enables or disables the Late to Open time programmed in [0].

[0] Late to Open Time of Day - This function is used to program the time setting enabled in [9].

Changing Brightness/Contrast

When this option is selected, the keypad will allow you to scroll through 4 brightness levels and 10 contrast levels.

1. Press [*][B] [Master Code].
2. Use the < > buttons to scroll to either Brightness Control or Contrast Control.
3. Press [*] to select the setting you want to adjust.
4. a) 'Brightness Control': There are 4 backlighting levels. Use the < > buttons to scroll to the desired level.
b) 'Contrast Control': There are 10 different display contrast levels. Use the < > buttons to scroll to the desired contrast level.
5. To exit, press [#].

Changing the Buzzer Level

When this option is selected, the keypad will allow you to scroll through 21 different buzzer levels. A level of 00 disables the buzzer.

1. Press [*][B] [Master Code].
2. Use the < > buttons to scroll to Buzzer Control.
3. There are 21 different levels, use the < > buttons to scroll to the desired level.

Viewing the Event Buffer

The event buffer will show you a list of the last 500 events that have occurred on your system.

1. Press **[*]** **[E]** [Master Code].
2. To select Event Buffer viewing, press **[*]**.
3. The keypad will display the event number and the time and date. Press **[*]** to switch between this information and the event details.
4. Use the **[<]** **[>]** buttons to scroll through the events in the buffer.
5. To exit event buffer viewing, press **[#]**.

Late to Open

NOTE: The Late to Open feature function requires the monitoring station to forward calls to the user. Verify with the installer whether this function is active.

[9] Late to Open Enable/Disable

This function enables or disables the Late to Open time programmed in [0].

The 'Late to Open' feature is typically used to track children after school. For example, if the parents get home from work at 5pm, and a child gets home at 4pm. The programmable timer could be set for 4:15. If the system is not disarmed at this time an alert would be sent to the parents.

The keypad will display 'Late to Open is Enabled' and sound a beep if **[E]** is pressed within the User Functions menu when this feature is off. The LCD keypad will display 'Late to Open is Disabled' and sound an error tone if **[E]** is pressed within the User Functions menu when this feature is on.

[0] Late to Open Time of Day

This function is used to program the time setting enabled in [9]. This function programs the 'Late to Open' time of day for all 7 days of the week.

- Valid entries for these sections are 00:00 – 23:59.
- Entering 99:99 will disable the late to open feature for the current day.
- After entering **[*]** **[6]** **[0]** menu, beeps will be sounded and 'Press **[*]** for < > Sunday' will be displayed on the keypad.
- Pressing the left scroll **[<]** button will cause the keypad to update, displaying each day of the week, from Sunday to Saturday. While in the Late to Open menu, entering keys 1-7 will also select each day from Sunday to Saturday respectively.
- If **[*]** is pressed to select a day of the week, no beeps will be sounded and the keypad will display 'Set 24hr Time' 'Enter HH:MM 9999'. If **[#]** is pressed from this menu, the user will be returned to the previous Late to Open menu.
- If the Alarm System is armed in any mode when the late to open time matches the time of day, Late to Open will be logged to the event buffer and communicated.

Proximity Tags (PT4/PT8)

Proximity Tags allow you to arm or disarm the System by placing the tag near the tag reader located on the top left hand side of the Keypad LCD. For details on enrolling/deleting prox tags please refer to 'Enrolling/Deleting Proximity Tags' on page 7.

2-Way Wireless Key (WT4989, WT8989)

The 2-way Wireless Key communicates directly with the control panel, performing many of the functions that a wireless keypad performs.

The WT4989 and WT8989 comprises 4 function keys programmable for 6 functions, an LCD icon display that can display system status using a combination of 8 icons, and an internal buzzer.

Unless custom programmed by your installer the functions are as follows:

Function Keys



Arms system in **Stay Mode**. If pressed simultaneously with the Away button will activate Command #1 Output (if programmed).



Arms system in **Away Mode**. If pressed simultaneously with the Stay button will activate Command #1 Output (if programmed).



Disarms the system. If pressed simultaneously with the Panic button will activate Command #2 Output (if programmed).



Sends a **Panic** code to the central station. If pressed simultaneously with the Disarm button will activate Command #2 Output (if programmed).



Request **System Status** (see display).

Display Icons



Indicates the key is transmitting or waiting for a response.



Indicates system is armed (all modes).



Indicates system is Stay or Night armed.



Indicates system is Night armed.



Indicates system is disarmed.



Indicates low battery. Contact service personnel for replacement.



Indicates that there are alarms in memory.



Indicates system trouble or that buttons on the wireless key are locked.

Buzzer

Provides an audible confirmation of a pressed button or that a command to the panel has been executed.



Keylock Mode

Ensures that the system is not accidentally armed or disarmed with the wireless key.

To lock the keys:

1. Press and hold the Status  button.
2. After 1 second, the wireless key will beep to indicate transmission.
3. After 3 seconds, the wireless key will beep again and flash the embedded icon to indicate keys are locked.

To unlock the keys:

1. Press and hold the Status  button for 3 seconds.
2. Press and hold the Panic  button for 3 seconds.
3. Press and hold the Stay and Away buttons OR the Disarm and Panic buttons simultaneously for 3 seconds.

Upon exiting Key Lock mode, the status will be automatically displayed.

Testing Your System

NOTE: Inform your Monitoring Station when you begin and end System Testing.

All smoke detectors in this installation must be tested by your smoke detector installer or dealer once a year to ensure they are functioning correctly. It is the user's responsibility to test the system weekly (excluding smoke detectors). Ensure you follow all the steps in the two tests below.

NOTE: Should the system fail to function properly, call your installation company for service immediately.

Sounder and Display Test

This test activates all display pixels and indicator lights and does a four second check of the sounder.

1. Press   [Master Code] .

The following will occur:

- The system activates the Bell output on medium volume for 2 seconds followed by full volume alarm for 2 seconds. All display lights and LCD pixels will turn on.
 - The Ready, Armed, Trouble and Power LED's will flash for the duration of the test.
2. To exit the function menu, press .

Walk Test

Walk Test mode allows you test the operation of each detector in the system. While in Walk Test mode, the Ready, Armed, and Trouble LED's will flash to indicate that the Walk Test is active. The Walk Test can be terminated at anytime by re-entering [Master Code] on the keypad. The system will also automatically terminate the Walk Test on completion, it will announce with an audible warning (5 beeps every 10 seconds), beginning five minutes before the termination of the test.

1. Before testing, ensure that the system is disarmed and the Ready light is on.
2. Press and close all zones to return the system to the Ready state.
3. Perform a System Test by following the steps in the previous section.
4. Press [Master Code] to initiate the Walk Test
5. To test the zones, activate each detector in turn (e.g., open each door/window or walk in motion detector areas).

The System will display the following message when each zone (detector) is activated: 'Secure System Before Arming < >', or 'Secure or Arm System'. Use the buttons to view which zones are open. The message will disappear when the zones are closed.

Allowing Computer Access To Your System

Occasionally, your installer may need to send information to or retrieve information from your security system. Your installer will do this by having a computer call your system over the telephone line. You may need to prepare your system to receive this 'downloading' call.

To do this:

Press [Master Code] at the keypad. This allows downloading for a limited period of time. During this time, the system will answer incoming downloading calls. For more information on this feature, please ask your installer.

Reference Sheets

Fill out the following information for future reference and store this guide in a safe place.

System Information Enabled?



The Exit Delay Time is _____ seconds.

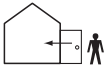

The Entry Delay Time is _____ seconds.

For Service

Central Station Information

Account#: _____ Telephone#: _____

Installer Information:

Company: _____ Telephone#: _____



If you suspect a false alarm signal has been sent to the central monitoring station, call the station to avoid an unnecessary response.

Access Codes

Master Code [40]: _____

Code	Wireless Key	Access Code	Code	Wireless Key	Access Code
01	<input type="checkbox"/>		09	<input type="checkbox"/>	
02	<input type="checkbox"/>		10	<input type="checkbox"/>	
03	<input type="checkbox"/>		11	<input type="checkbox"/>	
04	<input type="checkbox"/>		12	<input type="checkbox"/>	
05	<input type="checkbox"/>		13	<input type="checkbox"/>	
06	<input type="checkbox"/>		14	<input type="checkbox"/>	
07	<input type="checkbox"/>		15	<input type="checkbox"/>	
08	<input type="checkbox"/>		16	<input type="checkbox"/>	

Sensor / Zone Information

Sensor	Protected Area	Sensor Type	Sensor	Protected Area	Sensor Type
01			18		
02			19		
03			20		
04			21		
05			22		
06			23		
07			24		
08			25		
09			26		

Sensor	Protected Area	Sensor Type	Sensor	Protected Area	Sensor Type
10			27		
11			28		
12			29		
13			30		
14			31		
15			32		
16			33		
17			34		

Guidelines for Locating Smoke Detectors

Research has shown that all hostile fires in homes generate smoke to a greater or lesser extent. Experiments with typical fires in homes indicate that detectable quantities of smoke precede detectable levels of heat in most cases. For these reasons, smoke alarms should be installed outside of each sleeping area and on each storey of the home.

The following information is for general guidance only and it is recommended that local fire codes and regulations be consulted when locating and installing smoke alarms.

It is recommended that additional smoke alarms beyond those required for minimum protection be installed. Additional areas that should be protected include: the basement; bedrooms, especially where smokers sleep; dining rooms; furnace and utility rooms; and any hallways not protected by the required units.

On smooth ceilings, detectors may be spaced 9.1m (30 feet) apart as a guide. Other spacing may be required depending on ceiling height, air movement, the presence of joists, uninsulated ceilings, etc. Consult National Fire Alarm Code NFPA 72, CAN/ULC-S553-M86 or other appropriate national standards for installation recommendations.

- Do not locate smoke detectors at the top of peaked or gabled ceilings; the dead air space in these locations may prevent the unit from detecting smoke.
- Avoid areas with turbulent air flow, such as near doors, fans or windows. Rapid air movement around the detector may prevent smoke from entering the unit.
- Do not locate detectors in areas of high humidity.
- Do not locate detectors in areas where the temperature rises above 38°C (100°F) or falls below 5°C (41°F).
- Smoke detectors should always be installed in accordance with NFPA 72, the National Fire Alarm Code. Smoke detectors should always be located in accordance with:

'Smoke detectors shall be installed outside of each separate sleeping area in the immediate vicinity of the bedrooms and on each additional storey of the family living unit, including basements and excluding crawl spaces and unfinished attics. In new construction, a smoke detector also shall be installed in each sleeping room'. 'Split level arrangement: Smoke detectors are required where shown. Smoke detectors are optional where a door is not provided between living room and recreation room'.

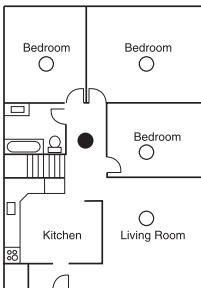

Figure 1

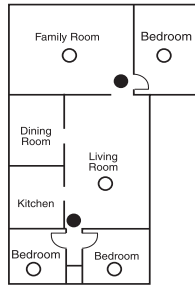

Figure 2

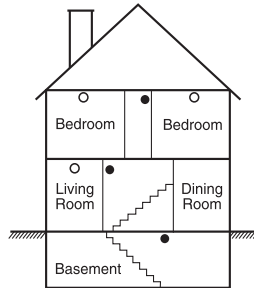
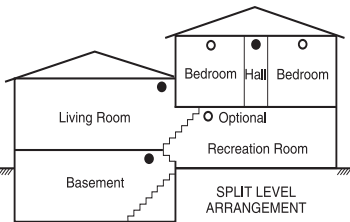
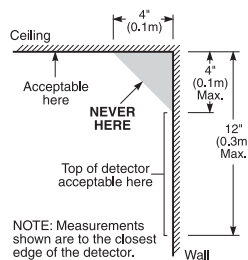

Figure 3



- Smoke detectors for better protection
- Smoke detectors for minimum protection

Figure 3a



NOTE: Measurements shown are to the closest edge of the detector.

Figure 4

Household Fire Safety Audit

Read this section carefully for important information about fire safety.

Most fires occur in the home. To minimize this danger, we recommend that a household fire safety audit be conducted and a fire escape plan be developed.

1. Are all electrical appliances and outlets in a safe condition? Check for frayed cords, overloaded lighting circuits, etc. If you are uncertain about the condition of your electrical appliances or household service, have a professional evaluate these units.
2. Are all flammable liquids stored safely in closed containers in a well-ventilated cool area? Cleaning with flammable liquids should be avoided.
3. Are fire-hazardous materials (matches) well out of reach of children?
4. Are furnaces and wood-burning appliances properly installed, clean and in good working order? Have a professional evaluate these appliances.

Fire Escape Planning





There is often very little time between the detection of a fire and the time it becomes deadly. It is thus very important that a family escape plan be developed and rehearsed.

1. Every family member should participate in developing the escape plan.
2. Study the possible escape routes from each location within the house. Since many fires occur at night, special attention should be given to the escape routes from sleeping quarters.
3. Escape from a bedroom must be possible without opening the interior door.





NOTE: Consider the following when making your escape plans:

- Make sure that all border doors and windows are easily opened. Ensure that they are not painted shut, and that their locking mechanisms operate smoothly.
- If opening or using the exit is too difficult for children, the elderly or handicapped, plans for rescue should be developed. This includes making sure that those who are to perform the rescue can promptly hear the fire warning signal.
- If the exit is above the ground level, an approved fire ladder or rope should be provided as well as training in its use.
- Exits on the ground level should be kept clear. Be sure to remove snow from exterior patio doors in winter; outdoor furniture or equipment should not block exits.
- Each person should know of a predetermined assembly point where everyone can be accounted for (e.g., across the street or at a neighbor's house). Once everyone is out of the building, call the Fire Department.
- A good plan emphasizes quick escape. Do not investigate or attempt to fight the fire, and do not gather belongings or pets as this wastes valuable time. Once outside, do not re-enter the house. Wait for the fire department.
- Write the fire escape plan down and rehearse it frequently so that should an emergency arise, everyone will know what to do. Revise the plan as conditions change, such as the number of people in the home, or if there are changes to the building's construction.
- Make sure your fire warning system is operational by conducting weekly tests. If you are unsure about system operation, contact your installing dealer.
- We recommend that you contact your local fire department and request further information on fire safety and escape planning. If available, have your local fire prevention officer conduct an in-house fire safety inspection.





Status Lights

	Ready - must be on to arm system. All zones must be secured or bypassed and the system disarmed for this light to activate.
	Armed - indicates system is armed. If the Ready light and the Armed light are both on it indicates that the Exit Delay is in progress.
	Trouble - indicates a system malfunction or tamper. Follow the instructions displayed or enter * 2 to view trouble. The Trouble light will turn off when the trouble is corrected.
	AC Power - indicates AC Power is present. The AC Power light will turn off when AC is absent.













Function Keys

	Stay	Arms the system in Stay Mode.
	Away	Arms the system in Away Mode.
	Chime	Same as pressing * 4 on the keypad.
	Bypass	Same as pressing * 1 on the keypad.
	Quick Exit	Same as pressing * 2 on the keypad.

Special Keys

 	Language Selection - Press and hold both buttons simultaneously for 2 seconds to activate. Scroll to the desired language. Press * to select choice.	
	Fire - Press and hold for 2 seconds to activate.	<i>These keys must be programmed by the installer to function.</i>
	Auxiliary - Press and hold for 2 seconds to activate.	
	Panic - Press and hold for 2 seconds to activate.	

User Commands

Press * to select, press   to scroll, press # to exit.		
PRESS...	To ...	
* 1	Bypass Zones	
	Press  	Clear Bypass
	Press  	Bypass Recall
	Press  	Save Bypass
	Press  	Recall Save
* 2	View System Troubles	Scroll to view all troubles
* 3	View Alarms in Memory	Scroll to view alarms
* 4	Chime ON/OFF	Turns chime on and off
* 5	Program User Codes Change Attributes	Press   buttons to scroll to user code. Enter [Master Code][9][xx] to enter user code (xx = 1-16). [1] Supervisor's code [2] Duress Code [3] Zone Bypassing [4]-[6] Future Use [7] Squawks bell Output [8] One Time Use Code

User Commands

* 6	User Options < >	Event Buffer System Test Time and Date System Service/DLS User Call-up Walk Test Brightness Control Contrast Control
* 7	PGM Commands	If programmed by Installer
* 8	Installer Programming	Requires Special Code
* 9	No-Entry Arming	Arms system in Away mode without requiring an exit
* 0	Quick Arm/Quick Exit	Quick Arm is equivalent to entering your User Code. Quick Exit allows you to exit the premises without disarming the system.

IMPORTANT - READ CAREFULLY: DSC Software purchased with or without Products and Components is copyrighted and is purchased under the following license terms:

- This End-User License Agreement ("EULA") is a legal agreement between You (the company, individual or entity who acquired the Software and any related Hardware) and Digital Security Controls, a division of Tyco Safety Products Canada Ltd. ("DSC"), the manufacturer of the integrated security systems and the developer of the software and any related products or components ("HARDWARE") which You acquired.
- If the DSC software product ("SOFTWARE PRODUCT" or "SOFTWARE") is intended to be accompanied by HARDWARE, and is NOT accompanied by new HARDWARE, You may not use, copy or install the SOFTWARE PRODUCT. The SOFTWARE PRODUCT includes computer software, and may include associated media, printed materials, and "online" or electronic documentation.
- Any software provided along with the SOFTWARE PRODUCT that is associated with a separate end-user license agreement is licensed to You under the terms of that license agreement.
- By installing, copying, downloading, storing, accessing or otherwise using the SOFTWARE PRODUCT, You agree unconditionally to be bound by the terms of this EULA, even if this EULA is deemed to be a modification of any previous arrangement or contract. If You do not agree to the terms of this EULA, DSC is unwilling to license the SOFTWARE PRODUCT to You, and You have no right to use it.

SOFTWARE PRODUCT LICENSE

The SOFTWARE PRODUCT is protected by copyright laws and international copyright treaties, as well as other intellectual property laws and treaties. The SOFTWARE PRODUCT is licensed, not sold.

1. GRANT OF LICENSE This EULA grants You the following rights:

- (a) Software Installation and Use - For each license You acquire, You may have only one copy of the SOFTWARE PRODUCT installed.
- (b) Storage/Network Use - The SOFTWARE PRODUCT may not be installed, accessed, displayed, run, shared or used concurrently on or from different computers, including a workstation, terminal or other digital electronic device ("Device"). In other words, if You have several workstations, You will have to acquire a license for each workstation where the SOFTWARE will be used.
- (c) Backup Copy - You may make back-up copies of the SOFTWARE PRODUCT, but You may only have one copy per license installed at any given time. You may use the back-up copy solely for archival purposes. Except as expressly provided in this EULA, You may not otherwise make copies of the SOFTWARE PRODUCT, including the printed materials accompanying the SOFTWARE.

2. DESCRIPTION OF OTHER RIGHTS AND LIMITATIONS

- (a) Limitations on Reverse Engineering, Decompilation and Disassembly - You may not reverse engineer, decompile, or disassemble the SOFTWARE PRODUCT, except and only to the extent that such activity is expressly permitted by applicable law notwithstanding this limitation. You may not make any changes or modifications to the Software, without the written permission of an officer of DSC. You may not remove any proprietary notices, marks or labels from the Software Product. You shall institute reasonable measures to ensure compliance with the terms and conditions of this EULA.
- (b) Separation of Components - The SOFTWARE PRODUCT is licensed as a single product. Its component parts may not be separated for use on more than one HARDWARE unit.
- (c) Single INTEGRATED PRODUCT - If You acquired this SOFTWARE with HARDWARE, then the SOFTWARE PRODUCT is licensed with the HARDWARE as a single integrated product. In this case, the SOFTWARE PRODUCT may only be used with the HARDWARE as set forth in this EULA.
- (d) Rental - You may not rent, lease or lend the SOFTWARE PRODUCT. You may not make it available to others or post it on a server or web site.
- (e) Software Product Transfer - You may transfer all of Your rights under this EULA only as part of a permanent sale or transfer of the HARDWARE, provided You retain no copies, You transfer all of the SOFTWARE PRODUCT (including all component parts, the media and printed materials, any upgrades and this EULA), and provided the recipient agrees to the terms of this EULA. If the SOFTWARE PRODUCT is an upgrade, any transfer must also include all prior versions of the SOFTWARE PRODUCT.
- (f) Termination - Without prejudice to any other rights, DSC may terminate this EULA if You fail to comply with the terms and conditions of this EULA. In such event, You must destroy all copies of the SOFTWARE PRODUCT and all of its component parts.

- (g) Trademarks - This EULA does not grant You any rights in connection with any trademarks or service marks of DSC or its suppliers.

3. COPYRIGHT - All title and intellectual property rights in and to the SOFTWARE PRODUCT (including but not limited to any images, photographs, and text incorporated into the SOFTWARE PRODUCT), the accompanying printed materials, and any copies of the SOFTWARE PRODUCT, are owned by DSC or its suppliers. You may not copy the printed materials accompanying the SOFTWARE PRODUCT. All title and intellectual property rights in and to the content which may be accessed through use of the SOFTWARE PRODUCT are the property of the respective content owner and may be protected by applicable copyright or other intellectual property laws and treaties. This EULA grants You no rights to use such content. All rights not expressly granted under this EULA are reserved by DSC and its suppliers.

4. EXPORT RESTRICTIONS - You agree that You will not export or re-export the SOFTWARE PRODUCT to any country, person, or entity subject to Canadian export restrictions.

5. CHOICE OF LAW - This Software License Agreement is governed by the laws of the Province of Ontario, Canada.

6. ARBITRATION - All disputes arising in connection with this Agreement shall be determined by final and binding arbitration in accordance with the Arbitration Act, and the parties agree to be bound by the arbitrator's decision. The place of arbitration shall be Toronto, Canada, and the language of the arbitration shall be English.

7. LIMITED WARRANTY

- (a) NO WARRANTY - DSC PROVIDES THE SOFTWARE "AS IS" WITHOUT WARRANTY. DSC DOES NOT WARRANT THAT THE SOFTWARE WILL MEET YOUR REQUIREMENTS OR THAT OPERATION OF THE SOFTWARE WILL BE UNINTERRUPTED OR ERROR-FREE.
- (b) CHANGES IN OPERATING ENVIRONMENT - DSC shall not be responsible for problems caused by changes in the operating characteristics of the HARDWARE, or for problems in the interaction of the SOFTWARE PRODUCT with non-DSC-SOFTWARE or HARDWARE PRODUCTS.
- (c) LIMITATION OF LIABILITY; WARRANTY REFLECTS ALLOCATION OF RISK - IN ANY EVENT, IF ANY STATUTE IMPLIES WARRANTIES OR CONDITIONS NOT STATED IN THIS LICENSE AGREEMENT, DSC'S ENTIRE LIABILITY UNDER ANY PROVISION OF THIS LICENSE AGREEMENT SHALL BE LIMITED TO THE GREATER OF THE AMOUNT ACTUALLY PAID BY YOU TO LICENSE THE SOFTWARE PRODUCT AND FIVE CANADIAN DOLLARS (CAD\$5.00). BECAUSE SOME JURISDICTIONS DO NOT ALLOW THE EXCLUSION OR LIMITATION OF LIABILITY FOR CONSEQUENTIAL OR INCIDENTAL DAMAGES, THE ABOVE LIMITATION MAY NOT APPLY TO YOU.
- (d) DISCLAIMER OF WARRANTIES - THIS WARRANTY CONTAINS THE ENTIRE WARRANTY AND SHALL BE IN LIEU OF ANY AND ALL OTHER WARRANTIES, WHETHER EXPRESSED OR IMPLIED (INCLUDING ALL IMPLIED WARRANTIES OF MERCHANTABILITY OR FITNESS FOR A PARTICULAR PURPOSE) AND OF ALL OTHER OBLIGATIONS OR LIABILITIES ON THE PART OF DSC. DSC MAKES NO OTHER WARRANTIES. DSC NEITHER ASSUMES NOR AUTHORIZES ANY OTHER PERSON PURPORTING TO ACT ON ITS BEHALF TO MODIFY OR TO CHANGE THIS WARRANTY, NOR TO ASSUME FOR IT ANY OTHER WARRANTY OR LIABILITY CONCERNING THIS SOFTWARE PRODUCT.
- (e) EXCLUSIVE REMEDY AND LIMITATION OF WARRANTY - UNDER NO CIRCUMSTANCES SHALL DSC BE LIABLE FOR ANY SPECIAL, INCIDENTAL, CONSEQUENTIAL OR INDIRECT DAMAGES BASED UPON BREACH OF WARRANTY, BREACH OF CONTRACT, NEGLIGENCE, STRICT LIABILITY, OR ANY OTHER LEGAL THEORY. SUCH DAMAGES INCLUDE, BUT ARE NOT LIMITED TO, LOSS OF PROFITS, LOSS OF THE SOFTWARE PRODUCT OR ANY ASSOCIATED EQUIPMENT, COST OF CAPITAL, COST OF SUBSTITUTE OR REPLACEMENT EQUIPMENT, FACILITIES OR SERVICES, DOWN TIME, PURCHASERS TIME, THE CLAIMS OF THIRD PARTIES, INCLUDING CUSTOMERS, AND INJURY TO PROPERTY.

WARNING: DSC recommends that the entire system be completely tested on a regular basis. However, despite frequent testing, and due to, but not limited to, criminal tampering or electrical disruption, it is possible for this SOFTWARE PRODUCT to fail to perform as expected.

WARNING Please Read Carefully

Note to Installers

This warning contains vital information. As the only individual in contact with system users, it is your responsibility to bring each item in this warning to the attention of the users of this system.

System Failures

This system has been carefully designed to be as effective as possible. There are circumstances, however, involving fire, burglary, or other types of emergencies where it may not provide protection. Any alarm system of any type may be compromised deliberately or may fail to operate as expected for a variety of reasons. Some but not all of these reasons may be:

Inadequate Installation

A security system must be installed properly in order to provide adequate protection. Every installation should be evaluated by a security professional to ensure that all access points and areas are covered. Locks and latches on windows and doors must be secure and operate as intended. Windows, doors, walls, ceilings and other building materials must be of sufficient strength and construction to provide the level of protection expected. A reevaluation must be done during and after any construction activity. An evaluation by the fire and/or police department is highly recommended if this service is available.

Criminal Knowledge

This system contains security features which were known to be effective at the time of manufacture. It is possible for persons with criminal intent to develop techniques which reduce the effectiveness of these features. It is important that a security system be reviewed periodically to ensure that its features remain effective and that it be updated or replaced if it is found that it does not provide the protection expected.

Access by Intruders

Intruders may enter through an unprotected access point, circumvent a sensing device, evade detection by moving through an area of insufficient coverage, disconnect a warning device, or interfere with or prevent the proper operation of the system.

Power Failure

Control units, intrusion detectors, smoke detectors and many other security devices require an adequate power supply for proper operation. If a device operates from batteries, it is possible for the batteries to fail. Even if the batteries have not failed, they must be charged, in good condition and installed correctly. If a device operates only by AC power, any interruption, however brief, will render that device inoperative while it does not have power. Power interruptions of any length are often accompanied by voltage fluctuations which may damage electronic equipment such as a security system. After a power interruption has occurred, immediately conduct a complete system test to ensure that the system operates as intended.

Failure of Replaceable Batteries

This system's wireless transmitters have been designed to provide several years of battery life under normal conditions. The expected battery life is a function of the device environment, usage and type. Ambient conditions such as high humidity, high or low temperatures, or large temperature fluctuations may reduce the expected battery life. While each transmitting device has a low battery monitor which identifies when the batteries need to be replaced, this monitor may fail to operate as expected. Regular testing and maintenance will keep the system in good operating condition.

Compromise of Radio Frequency (Wireless) Devices

Signals may not reach the receiver under all circumstances which could include metal objects placed on or near the radio path or deliberate jamming or other inadvertent radio signal interference.

System Users

A user may not be able to operate a panic or emergency switch possibly due to permanent or temporary physical disability, inability to reach the device in time, or unfamiliarity with the correct operation. It is important that all system users be trained in the correct operation of the alarm system and that they know how to respond when the system indicates an alarm.

Smoke Detectors

Smoke detectors that are a part of this system may not properly alert occupants of a fire for a number of reasons, some of which follow. The smoke detectors may have been improperly installed or positioned. Smoke may not be able to reach the smoke detectors, such as when the fire is in a chimney, walls or roofs, or on the other side of closed doors. Smoke detectors may not detect smoke from fires on another level of the residence or building.

Every fire is different in the amount of smoke produced and the rate of burning. Smoke detectors cannot sense all types of fires equally well. Smoke detectors may not provide timely warning of fires caused by carelessness or safety hazards such as smoking in bed, violent explosions, escaping gas, improper storage of flammable materials, overloaded electrical circuits, children playing with matches or arson.

Even if the smoke detector operates as intended, there may be circumstances when there is insufficient warning to allow all occupants to escape in time to avoid injury or death.

Motion Detectors

Motion detectors can only detect motion within the designated areas as shown in their respective installation instructions. They cannot discriminate between intruders and intended occupants. Motion detectors do not provide volumetric area protection. They have multiple beams of detection and motion can only be detected in unobstructed areas covered by these beams. They cannot detect motion which occurs behind walls, ceilings, floor, closed doors, glass partitions, glass doors or windows. Any type of tampering whether intentional or unintentional such as masking, painting, or spraying of any material on the lenses, mirrors, windows or any other part of the detection system will impair its proper operation.

Passive infrared motion detectors operate by sensing changes in temperature. However their effectiveness can be reduced when the ambient temperature rises near or above body temperature or if there are intentional or unintentional sources of heat in or near the detection area. Some of these heat sources could be heaters, radiators, stoves, barbecues, fireplaces, sunlight, steam vents, lighting and so on.

Warning Devices

Warning devices such as sirens, bells, horns, or strobes may not warn people or waken someone sleeping if there is an intervening wall or door. If warning devices are located on a different level of the residence or premise, then it is less likely that the occupants will be alerted or awakened. Audible warning devices may be interfered with by other noise sources such as stereos, radios, televisions, air conditioners or other appliances, or passing traffic. Audible warning devices, however loud, may not be heard by a hearing-impaired person.

Telephone Lines

If telephone lines are used to transmit alarms, they may be out of service or busy for certain periods of time. Also an intruder may cut the telephone line or defeat its operation by more sophisticated means which may be difficult to detect.

Insufficient Time

There may be circumstances when the system will operate as intended, yet the occupants will not be protected from the emergency due to their inability to respond to the warnings in a timely manner. If the system is monitored, the response may not occur in time to protect the occupants or their belongings.

Component Failure

Although every effort has been made to make this system as reliable as possible, the system may fail to function as intended due to the failure of a component.

Inadequate Testing

Most problems that would prevent an alarm system from operating as intended can be found by regular testing and maintenance. The complete system should be tested weekly and immediately after a break-in, an attempted break-in, a fire, a storm, an earthquake, an accident, or any kind of construction activity inside or outside the premises. The testing should include all sensing devices, keypads, consoles, alarm indicating devices and any other operational devices that are part of the system.

Security and Insurance

Regardless of its capabilities, an alarm system is not a substitute for property or life insurance. An alarm system also is not a substitute for property owners, renters, or other occupants to act prudently to prevent or minimize the harmful effects of an emergency situation.

DSC erklærer herved at denne komponenten overholder alle vigtige krav samt andre bestemmelser gitt i direktiv 1999/5/EC.

Por este meio, a DSC, declara que este equipamento está em conformidade com os requisitos essenciais e outras determinações relevantes da Directiva 1999/5/EC.

DSC bekræfter herved at denna apparat uppfyller de väsentliga kraven och andra relevanta bestämmelser i Direktivet 1999/5/EC.

Con la presente la Digital Security Controls dichiara che questo prodotto è conforme ai requisiti essenziali ed altre disposizioni rilevanti relative alla Direttiva 1999/05/CE.

Por la presente, DSC declara que este equipo está en conformidad con los requisitos esenciales y otros requisitos relevantes de la Directiva 1999/5/EC. Hierdurch erklärt DSC, daß dieses Gerät den erforderlichen Bedingungen und Voraussetzungen der Richtlinie 1999/5/EC entspricht.

Δια του παρόντος, η DSC, δηλώνει ότι αυτή η συσκευή είναι σύμφωνη με τις ουσιαστικές απαιτήσεις και με όλες τις άλλες σχετικές αναφορές της Οδηγίας 1999/5/EC.

Hierbij verklaart DSC dat dit toestel in overeenstemming is met de eisen en bepalingen van richtlijn 1999/5/EC.

Par la présente, DSC déclare que cet article est conforme aux exigences essentielles et autres relevantes stipulations de la directive 1999/5/EC.

DSC vakuuttaa laitteen täyttävän direktiivin 1999/5/EC olennaiset vaatimukset.

Hereby, DSC declares that this device is in compliance with the essential requirements and other relevant provisions of Directive 1999/5/EC.

The complete R&TE Declaration of Conformity can be found at http://www.dsc.com/listings_index.aspx.

