



Test Report: 6W64372.1

Applicant: Digital Security Controls, a Division of Tyco Safety Products Canada Ltd.
3301 Langstaff Road
Concord, Ontario
L4K 4L2

Apparatus: RFK5500-433 Keypad
RFK5501-433 Keypad
RFK5508-433 Keypad
RFK5516-433 Keypad

In Accordance With: RSS-GEN, Issue 1
Receiver Tests

Tested By: Nemko Canada Inc.
303 River Road
Ottawa, Ontario
K1V 1H2

IC OATS Reference No.: IC 2040-1

Authorized By: 
Jin Xu, Wireless Specialist

Date: April 13, 2006

Total Number of Pages: 17

Report Summary

These tests were conducted on a sample of the equipment for the purpose of demonstrating compliance with Industry Canada RSS-GEN. Radiated tests were conducted in accordance with ANSI C63.4-2003. Radiated emissions are made on an open area test site. A description of the test facility is on file with Industry Canada.

The assessment summary is as follows:

Apparatus Assessed:	RFK5500-433 Keypad RFK5501-433 Keypad RFK5508-433 Keypad RFK5516-433 Keypad
Specification:	RSS-GEN, Issue 1
Compliance Status:	Complies
Exclusions:	None
Non-compliances:	None
Report Release History:	Original Release

Author: Jason Nixon, Telecom Specialist

Note that the results contained in this report relate only to the items tested and were obtained in the period between the date of initial receipt of samples and the date of issue of the report.

This test report has been completed in accordance with the requirements of ISO/IEC 17025.

Nemko Canada Inc. authorizes the applicant to reproduce this report provided it is reproduced in its entirety and for use by the company's employees only.

Any use which a third party makes of this report, or any reliance on or decisions to be made based on it, are the responsibility of such third parties. Nemko Canada Inc. accepts no responsibility for damages, if any, suffered by any third party as a result of decisions made or actions based on this report.

TABLE OF CONTENTS

Report Summary	2
Section 1 : Equipment Under Test	4
1.1 Product Identification	4
1.2 Samples Submitted for Assessment.....	4
1.3 Theory of Operation	4
1.4 Technical Specifications of the EUT	4
1.5 Block Diagram of the EUT.....	5
Section 2 : Test Conditions	6
2.1 Specifications	6
2.2 Deviations From Laboratory Test Procedures	6
2.3 Test Environment	6
2.4 Test Equipment.....	6
Section 3 : Observations	7
3.1 Modifications Performed During Assessment	7
3.2 Record Of Technical Judgements	7
3.3 EUT Parameters Affecting Compliance	7
3.4 Test Deleted.....	7
3.5 Additional Observations	7
Section 4 : Results Summary	8
4.1 IC RSS-GEN, Issue 1 : Test Results.....	9
Appendix A : Test Results	10
Clause 7.2.2 Transmitter and Receiver AC Power Lines Conducted Emission Limits	10
Clause 7.2.3.2 Receiver Spurious Emissions (Radiated)	14
Appendix B : Setup Photographs	15
Appendix C : Block Diagram of Test Setups	17

Section 1 : Equipment Under Test

1.1 Product Identification

The Equipment Under Test was identified as follows:

RFK5500-433, RFK5501-433, RFK5508-433, RFK5516-433 Keypads

1.2 Samples Submitted for Assessment

The following samples of the apparatus have been submitted for type assessment:

Sample No.	Description	Serial No.
3	Metal enclosure	None
4	PC1555MX alarm control panel	70000701
6	RFK5501-433 Keypad	None
10	Power Supply (M/N: PTC1640U)	88014305

The first samples were received on: April 5, 2006

1.3 Theory of Operation

The EUT is used to receive signals from alarm system components such as motion detectors and pass the data to the alarm control panel to indicate alarms.

1.4 Technical Specifications of the EUT

Manufacturer: Digital Security Controls, a division of Tyco Safety Products Canada Ltd.

Receive Frequency: 433.92MHz

Receiver Type: Superheterodyne

Antenna Data: Integral

Power Source: 12VDC provided by the Alarm Panel

1.5 Block Diagram of the EUT

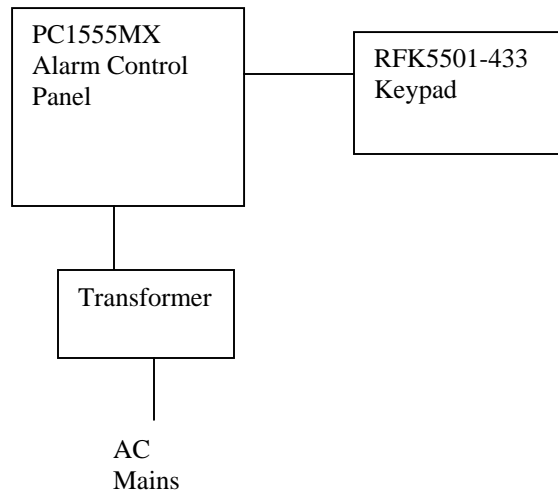

Section 2 : Test Conditions

2.1 Specifications

The apparatus was assessed against the following specifications:

IC RSS-GEN, Issue 1 September 2005

2.2 Deviations From Laboratory Test Procedures

No deviations were made from laboratory test procedures.

2.3 Test Environment

All tests were performed under the following environmental conditions:

Temperature range	:	15 – 30 °C
Humidity range	:	20 - 75 %
Pressure range	:	86 - 106 kPa
Power supply range	:	+/- 5% of rated voltages

2.4 Test Equipment

Equipment	Manufacturer	Model No.	Asset/Serial No.	Next Cal.
LISN	EMCO	4825/2	FA001545	Jan. 30/07
Receiver	Rohde & Schwarz	ESHS 10	FA001918	Feb. 17/07
Spectrum Analyzer	Hewlett-Packard	8566B	FA001309	May 18/06
Spectrum Analyzer Display	Hewlett-Packard	85662A	FA001309	May 18/06
International Power Supply	California Inst.	1001WP	FA000995	Jan. 11/07
Transient Limiter	Hewlett-Packard	1194 7A	FA001855	Jun 9/06
Receiver	Rohde & Schwarz	ESVS-30	FA001437	July 27/06
Spectrum Analyzer	Hewlett-Packard	8565E	FA000981	Sept. 15/06
Biconical (1) Antenna	EMCO	3109	FA000805	April 22/06
Log Periodic Antenna #1	EMCO	LPA-25	FA000477	Aug. 29/06
Horn Antenna #1	EMCO	3115	FA000649	Jan. 12/07
1.0 – 2.0 GHz Amplifier	JCA	12-400	FA001498	July 14/06

Section 3 : Observations

3.1 Modifications Performed During Assessment

No modifications were performed during assessment.

3.2 Record Of Technical Judgements

The following technical judgement was made during this assessment:

3.2.1 Technical Judgement 1

The RFK5500-433, RFK5501-433, RFK5508-433, RFK5516-433 Keypads all use the same hardware (RF and Keypad controls). The difference between them is the method used for displaying the status information.

RFK5500-433 – Keypad with RF receiver and Alphanumeric LCD display

RF5501-433 – Keypad with RF receiver and Fixed messages LCD display

RFK5508-433 – Keypad with RF receiver and 8 zone LED's display

RFK5516-433 – Keypad with RF receiver and 16 zone LED's display

It was judged that the results from the RFK5501-433 would be representative of all models.

3.3 EUT Parameters Affecting Compliance

The user of the apparatus could not alter parameters that would affect compliance.

3.4 Test Deleted

No Tests were deleted from this assessment.

3.5 Additional Observations

There were no additional observations made during this assessment.

Section 4 : Results Summary

This section contains the following:

IC RSS-GEN, Issue 1 : Test Results

The column headed 'Required' indicates whether the associated clauses were invoked for the apparatus under test. The following abbreviations are used:

- N No : not applicable / not relevant.
- Y Yes : Mandatory i.e. the apparatus shall conform to these tests.
- N/T Not Tested, mandatory but not assessed. (See section 3.4 Test deleted)

The results contained in this section are representative of the operation of the apparatus as originally submitted.

4.1 IC RSS-GEN, Issue 1 : Test Results

Clause 7	Test Description	Required	Result
7.1	General	—	—
7.2	Measurement Methods and Standard Specifications	—	—
7.2.1	Emission Limits for Pulsed Operation Devices	—	—
7.2.2	Transmitter and Receiver AC Power Lines Conducted Emission Limits	Y	PASS
7.2.3	Receiver Spurious Emission Limits	—	—
7.2.3.1	Antenna Conducted Measurement	N	
7.2.3.2	Radiated Measurement	Y	PASS
7.2.4	Transmitter Frequency Stability	N	

Notes:

Appendix A : Test Results

Clause 7.2.2 Transmitter and Receiver AC Power Lines Conducted Emission Limits

The purpose of this test is to measure unwanted radio frequency currents induced in any AC conductor external to the equipment which could conduct interference to other equipment via the AC electrical network.

Except when the requirements applicable to a given device state otherwise, for any licence-exempt radiocommunication device equipped to operate from the public utility AC power supply, either directly or indirectly, the radio frequency voltage that is conducted back onto the AC power lines in the frequency range of 0.15 MHz to 30 MHz shall not exceed the limits shown in Table 2. The tighter limit applies at the frequency range boundaries.

The conducted emissions shall be measured with a 50 ohm/50 microhenry line impedance stabilization network. A description of the method of measurement that is acceptable to Industry Canada is found in RSS-212.

Table 2 - AC Power Lines Conducted Emission Limits

Frequency range (MHz)	Conducted limit (dBµV)	
	Quasi-peak	Average
0.15 – 0.5	66 to 56*	56 to 46*
0.5 – 5	56	46
5 – 30	60	50

*Decreases with the logarithm of the frequency

Test Conditions:

Sample Number:	6	Temperature:	24
Date:	April 10, 2006	Humidity:	30
Modification State:	0	Tester:	Jason Nixon
		Laboratory:	Shield Room

Test Results: See Attached Plots and Table.

Additional Observations:

All Plots were performed using a Peak detector and compared to the average limits.

Conductor		Frequency (MHz)	Detector	Emission Level (dBuV)	LISN Loss (dB)	Cable Loss (dB)	Result (dBuV)	Limit (dBuV)	Margin (dB)
1	Phase	0.1518	Quasi Peak	50.3	0.00	0.18	50.48	65.9	15.4
			Average	19.7	0.00	0.18	19.88	55.9	36.0
2	Phase	0.1633	Quasi Peak	49.4	0.00	0.07	49.47	65.3	15.8
			Average	19.0	0.00	0.07	19.07	55.3	36.2
3	Phase	0.1742	Quasi Peak	48.3	0.00	0.02	48.32	64.8	16.4
			Average	17.9	0.00	0.02	17.92	54.8	36.8
4	Phase	0.1927	Quasi Peak	45.7	0.00	0.19	45.89	63.9	18.0
			Average	15.7	0.00	0.19	15.89	53.9	38.0
5	Phase	0.2165	Quasi Peak	42.2	0.00	0.20	42.40	63.0	20.6
			Average	12.9	0.00	0.20	13.10	53.0	39.9
6	Phase	10.0006	Quasi Peak	12.2	0.20	0.40	12.80	60.0	47.2
			Average	11.7	0.20	0.40	12.30	50.0	37.7
7	Neutral	0.1500	Quasi Peak	50.6	0.00	0.00	50.60	66.0	15.4
			Average	20.1	0.00	0.00	20.10	56.0	35.9
8	Neutral	0.1628	Quasi Peak	49.8	0.00	0.12	49.92	65.3	15.4
			Average	19.4	0.00	0.12	19.52	55.3	35.8
9	Neutral	0.1738	Quasi Peak	48.6	0.00	0.00	48.60	64.8	16.2
			Average	18.3	0.00	0.00	18.30	54.8	36.5
10	Neutral	0.1925	Quasi Peak	46.2	0.00	0.19	46.39	63.9	17.5
			Average	16.1	0.00	0.19	16.29	53.9	37.6
11	Neutral	0.2665	Quasi Peak	36.4	0.00	0.20	36.60	61.2	24.6
			Average	7.5	0.00	0.20	7.65	51.2	43.6
12	Neutral	1.1535	Quasi Peak	-2.3	0.00	0.21	-2.09	56.0	58.1
			Average	-9.5	0.00	0.21	-9.29	46.0	55.3

Phase Conductor – Low frequencies

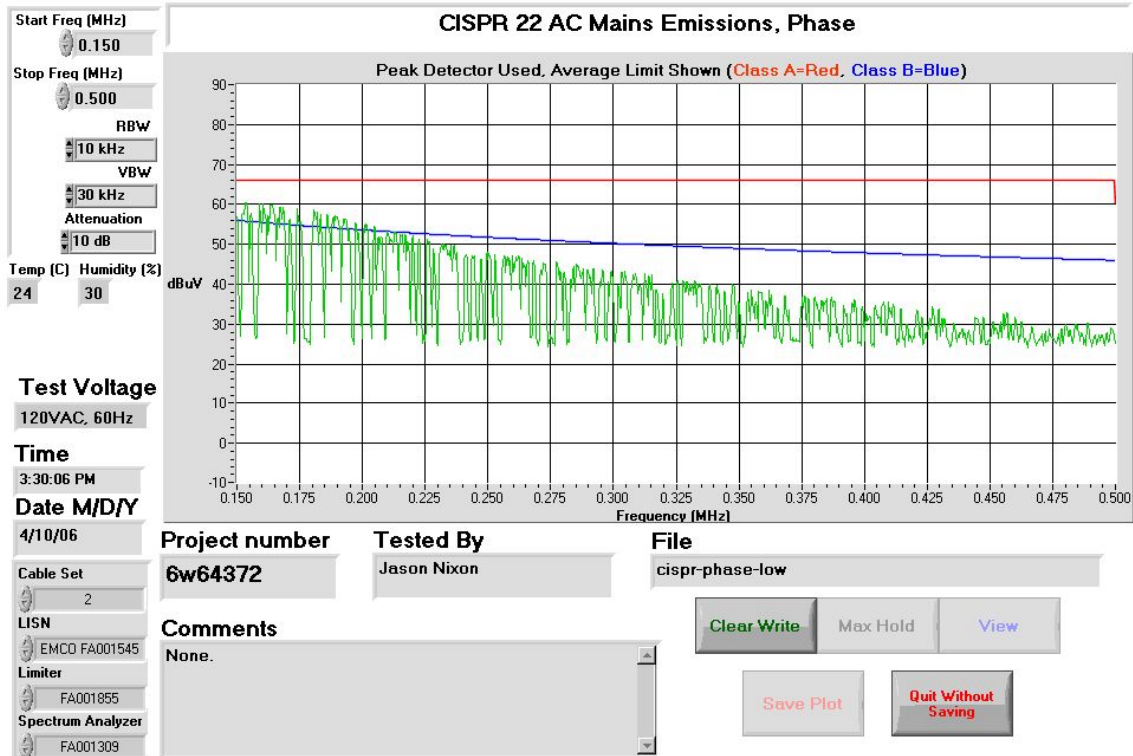

Phase Conductor – High frequencies

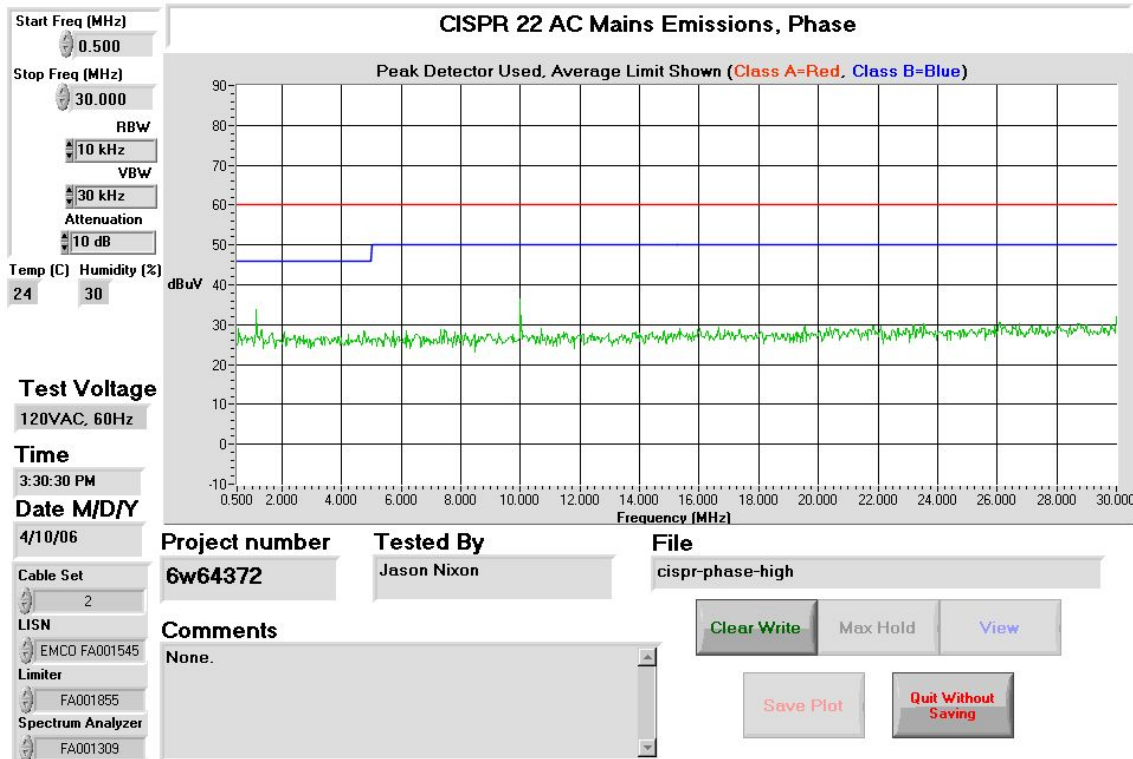

Neutral Conductor – Low frequencies

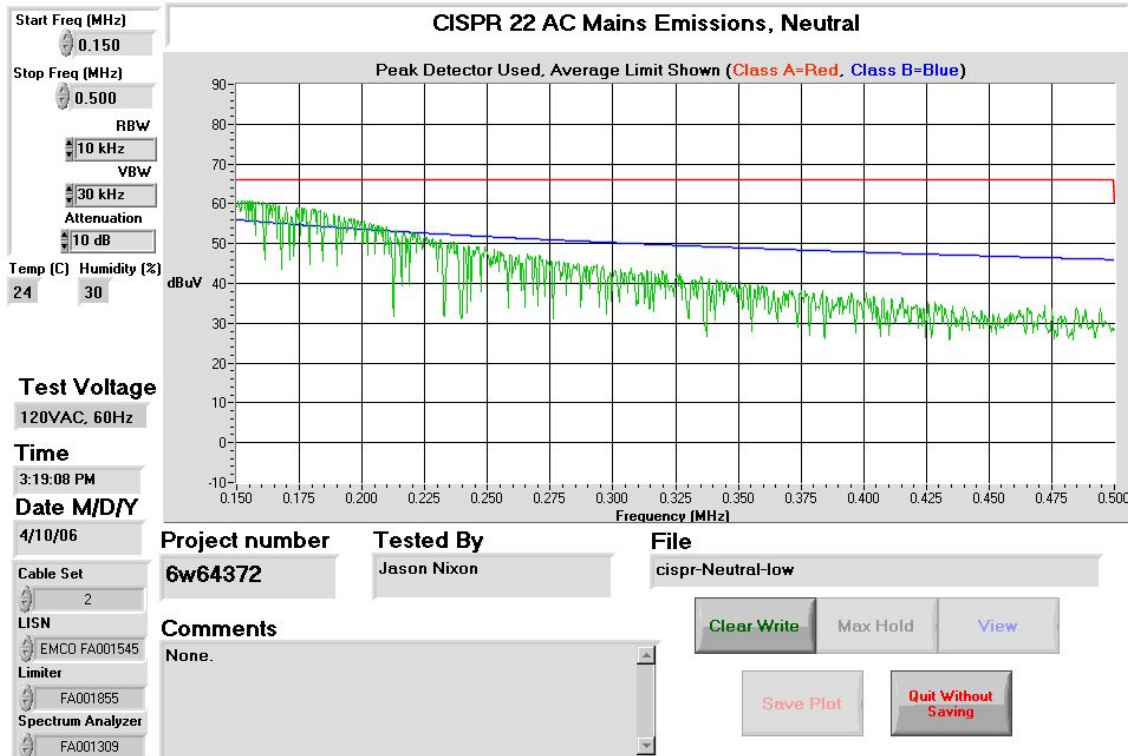

Neutral Conductor – High frequencies

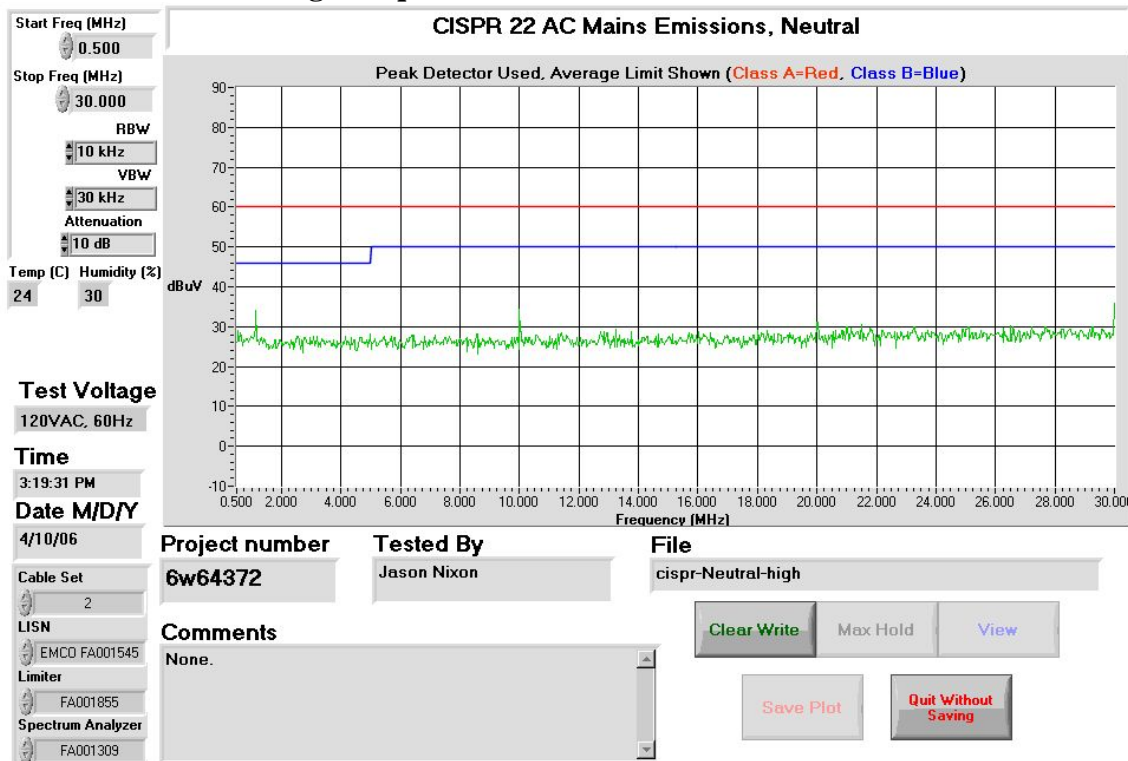

Clause 7.2.3.2 Receiver Spurious Emissions (Radiated)

All spurious emissions shall comply with the limits of Table 1 (see Section 6).

Table 1 - Spurious Emission Limits for Receivers Spurious

Frequency (MHz)	Field Strength (microvolt/m at 3 metres)
30-88	100
88-216	150
216-960	200
Above 960	500

Test Conditions:

Sample Number:	6	Temperature:	10
Date:	April 11, 2006	Humidity:	81
Modification State:	0	Tester:	Jason Nixon
		Laboratory:	OATS

Test Results:

See Attached Table for Results

Additional Observations:

The Spectrum was searched from 30MHz to 2GHz.

All measurements were performed using a Quasi-Peak Detector with 120kHz RBW/VBW below 1GHz and a 1MHz RBW/VBW above 1GHz at a distance of 3 meters.

Freq. (MHz)	Ant	Pol. V/H	RCVD Signal (dBμV)	Ant. Factor (dB)	Amp. Gain (dB)	Duty Cycle Corr. (dB)	Cable Loss (dB)	Level (dBuV)	Limit (dBuV)	Margin (dB)
40.0021	BC1	V	18.3	10.4	N/A	N/A	1.3	30.0	40.0	10.0
40.0021	BC1	H	8.6	11.5	N/A	N/A	1.3	21.4	40.0	18.6
48.0460	BC1	V	18.6	10.3	N/A	N/A	1.5	30.4	40.0	9.6
48.0473	BC1	H	15.7	10.7	N/A	N/A	1.5	27.9	40.0	12.1
60.0034	BC1	V	15.7	8.1	N/A	N/A	1.4	25.2	40.0	14.8
60.0034	BC1	H	8.2	8.4	N/A	N/A	1.4	18.0	40.0	22.0
50.0030	BC1	V	11.3	9.8	N/A	N/A	1.5	22.6	40.0	17.4
50.0030	BC1	H	8.6	9.9	N/A	N/A	1.5	20.0	40.0	20.0
69.9998	BC1	V	16.5	8.7	N/A	N/A	1.6	26.8	40.0	13.2
80.0001	BC1	V	15.6	7.7	N/A	N/A	1.7	25.0	40.0	15.0
80.0001	BC1	H	7.3	7.3	N/A	N/A	1.7	16.3	40.0	23.7

Note 1: Antenna Legend: BC = Biconical, BL = Bilog, LP = Log-Periodic, Horn = Horn, ED = EMCO Dipole

Appendix B : Setup Photographs

Conducted Emissions Setup:



Spurious Emissions Setup:



Appendix C : Block Diagram of Test Setups

Test Site For Radiated Emissions

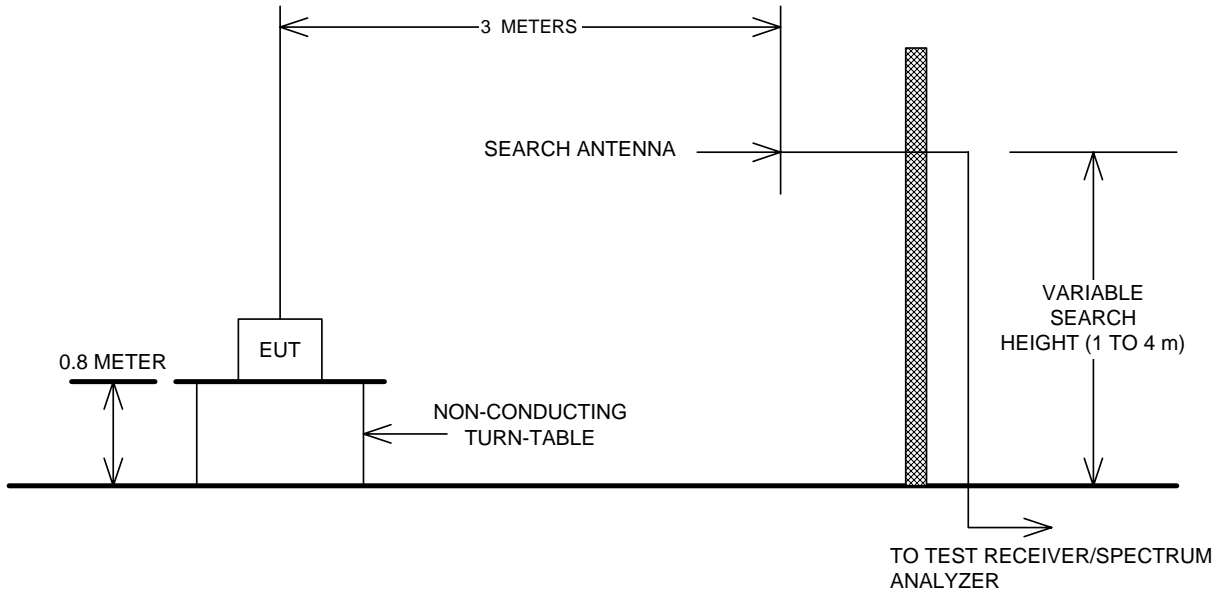

AC Conducted Emissions

