



WLS906-433

Battery-Powered Smoke Detectors
For Residential Use
**INSTRUCTIONS FOR
INSTALLATION AND USE**

**READ THIS INSTRUCTION SHEET THOROUGHLY BEFORE
INSTALLING AND USING YOUR MERIDIAN SMOKE DETECTOR**

Features

- **Advanced 90° photoelectric detection pattern and specially designed smoke chamber* for superior detection and dust resistance**
 - **Unique high signal-to-noise ratio and superior RFI immunity to prevent false alarms**
 - **Excellent smoke access provides reliable detection for all smoke flow directions and velocities**
 - **Loud 85dB piezoelectric alarm horn**
 - **Battery-powered design for easy installation and independence from house power sources**
 - **Uses six AA batteries and special circuit design to provide extra long battery life**
 - **Solid-state LED indicator light (red)**
 - **Visible flash light and audible trouble chirp for low battery warning**
 - **Equipped with an RF transmitter, WLS906 can communicate with compatible DSC Wireless Security Systems**
 - **Test Button allows user to perform sensitivity test and get a local indication of test result**
 - **Magnet-activated reed switch allows user to perform system test**
 - **Battery removal sensor alerts user to missing battery and prevents installation of detector when no battery is installed**
 - **Automatic self-test once every 40 seconds provides an audible trouble indication if the unit has insufficient smoke sensitivity**
 - **Attractive styling for any decor**
- * Protected under Canadian Patent No. 1452296. Other patents pending.

Introduction

The DSC Meridian photoelectric smoke detector incorporates many advanced design features to provide years of reliable operation. It is important to follow the installation and operation instructions on this sheet to ensure that the unit will function properly — even the best designed smoke detector will be rendered useless if it is not connected or located properly.

It is very important that you understand how to test and maintain your system. Read the *Instruction or User Manual* for your alarm system to familiarize yourself with the fire alarm functions. Be sure to test your system regularly following the test procedures described in your manual. If you should ever have problems operating or testing your system, and especially if there are problems with the fire alarm functions, contact your smoke detector installer or dealer immediately for service.

While smoke detectors and alarm systems are designed to warn you of potentially dangerous situations, no system can prevent emergencies. An alarm system is not a substitute for life and property insurance; you should always maintain appropriate insurance coverage.

How the Smoke Detector Works

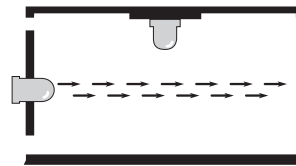

Normally, light pulses in the smoke chamber do not reach the light sensor.

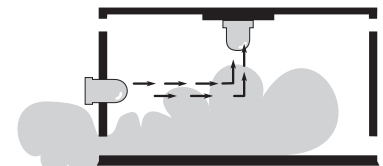

Smoke in the smoke chamber deflects light into the light sensor, triggering an alarm.

As shown in the illustration, a light source is directed across the smoke chamber and is not normally reflected into the sensing element. When smoke enters the chamber, the light beam is scattered by the smoke and is reflected into the sensor. When enough light is detected by the sensor, an alarm is activated. On alarm, the sounder is activated and the red LED will flash. **When the smoke clears from the smoke chamber, the unit will automatically reset itself.**

Alarm Indications

Condition	Sounder	Indicator Light	RF Transmission
No smoke	Silent	Flash every 40-50 s	Supervision transmission every 12 min. for Europe / every 64 min. for North America
Smoke	Alarm	Flash every 0.67 s	Alarm transmission
Automatic self test functioning normally	Silent	Flash every 40-50 s	Supervision transmission every 12 min. for Europe / every 64 min. for North America
Automatic self test insufficient sensitivity	Chirp between LED flashes	Flash every 40-50 s	Fire Trouble transmission
Push-button test functioning normally	Alarm	Flash every 0.67 s	Supervision transmission every 12 min. for Europe / every 64 min. for North America
Push-button test insufficient sensitivity	Silent	Flash every 40-50 s	Fire Trouble transmission
Magnet/reed switch test functioning normally	Alarm	Flash every 0.67 s	Alarm transmission
Magnet/reed switch test insufficient sensitivity	Silent	Flash every 40-50 s	Fire Trouble transmission
Low battery	Chirp simultaneous with LED flash	Flash every 40-50 s	Fire Trouble transmission

Limitations of Smoke Detectors

While the Meridian smoke detector has been designed for reliability, it is important to know that all smoke detectors have limitations.

- Smoke detectors will not work without power. If the batteries are low, the smoke detector will not function. See 'Battery Installation' below for important information on battery use.
- Smoke detectors can only generate an alarm when smoke gets inside the smoke chamber; anything that prevents smoke from entering the smoke chamber may prevent or delay an alarm. Refer to the 'Guidelines for Locating Smoke Detectors' on this *Instruction Sheet*; it is important that smoke detectors be located on at least every floor of the premises, preferably in every room. It is also important to avoid obstructions, such as closed doors, that may prevent smoke from reaching the unit. A smoke detector will not detect a fire in the walls, in the chimney or on the roof of a building until smoke enters the smoke chamber.

- Smoke detectors have certain obvious limitations: they may not provide protection for someone smoking in bed, for children playing with matches, or for sudden and violent explosions. A smoke detector is a single part of overall fire safety precautions; the smoke detector should never be seen as a substitute for a complete fire safety program.

Guidelines for Locating Smoke Detectors

On smooth ceilings, detectors may be spaced 9.1m (30 feet) apart as a guide. Other spacing may be required depending on ceiling height, air movement, the presence of joists, uninsulated ceilings, etc. Consult National Fire Alarm Code NFPA 72, CAN/ULS-S553-M86 or other appropriate national standards for installation recommendations.

Do not locate smoke detectors at the top of peaked or gabled ceilings; the dead air space in these locations may prevent the unit from detecting smoke.

Avoid areas with turbulent air flow, such as near doors, fans or windows. Rapid air movement around the detector may prevent smoke from entering the unit.

Do not locate detectors in areas of high humidity.

Do not locate detectors in areas where the temperature rises above 38°C (100°F) or falls below 5°C (41°F).

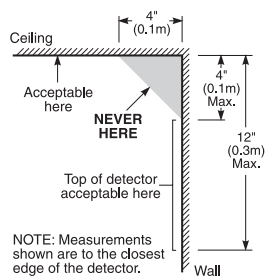
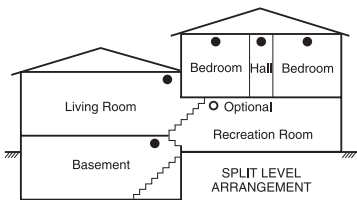
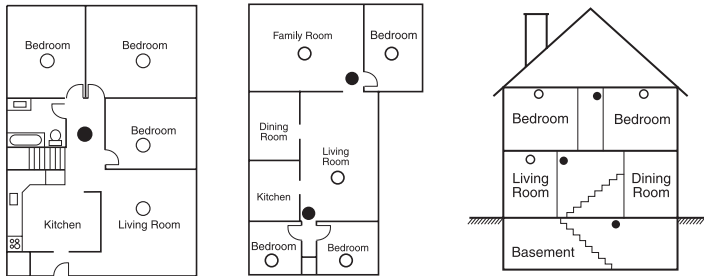

- Smoke detectors for better protection
- Smoke detectors for minimum protection

NOTE: Measurements shown are to the closest edge of the detector.

Smoke detectors should always be installed in accordance with NFPA 72, the National Fire Alarm Code. Smoke detectors should always be located in accordance with:

- Paragraph 2-2.1.1.1 of NFPA 72, Chapter 2.: "Smoke detectors shall be installed outside of each separate sleeping area in the immediate vicinity of the bedrooms and on each additional story of the family living unit, including basements and excluding crawl spaces and unfinished attics. In new construction, a smoke detector also shall be installed in each sleeping room."
- Paragraph 2-2.1.1.2 of NFPA 72, Chapter 2.: "Split level arrangement. Smoke detectors are required where shown. Smoke detectors are optional where a door is not provided between living room and recreation room."

Testing Your Smoke Detector

Follow the test procedure described here or contact your smoke detector dealer or installer for testing instructions.

It is recommended that your entire alarm system be tested at least once per week to verify the operation of all system functions.

Smoke Detector Unit Test

To test the smoke detector, press and hold the test button on the front of the unit. When the button is pressed, the unit's alarm should sound. When the button is released, the alarm should be silenced. If this does not occur, check that the batteries are the correct type, in good condition and are installed correctly (see the 'Battery Installation' section below).

Upon completing the functional testing of the smoke detector, check the unit's sensing chamber to ensure proper operation. To test the sensing chamber, waft a lit cotton wick or punk stick around the outside of the unit until a generous amount of smoke enters the sensing chamber, or the unit alarms. If the smoke detector does not function properly, call your smoke detector installer or dealer for service.

System Test

To prepare your alarm system for a complete test, refer to the testing instructions section of your system's manual. **Observe carefully all instructions regarding notification of the monitoring station in order to avoid an unnecessary emergency response.** When the system is ready to be tested, hold the test magnet against the smoke detector case as shown below.

After activating the smoke detector's system test, an alarm should sound and the indicator light should flash every 0.67 seconds. When the magnet is removed, the alarm should be silenced. **See your system manual for further instructions regarding completion of the alarm system test.**

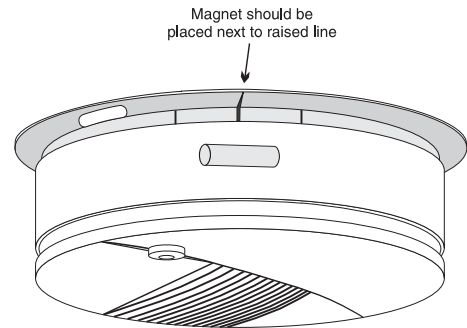

Owner's Maintenance Instructions

The Meridian smoke detector is designed to require a minimum of maintenance. If the case becomes dusty, wipe the case gently with a soft dry cloth. If the case is greasy, wipe the case gently with a soft cloth slightly dampened with soapy water.

Never disassemble the smoke detector; there are no user serviceable parts inside the unit. Never paint the unit, as paint may prevent smoke from entering the unit. If you are planning renovations or repainting, contact your installer and ask that the unit be temporarily removed until work is complete.

If the unit is located in an area where it is exposed to high levels of dust or insects and is found to cause false alarms, it may require service; contact your smoke detector installer or dealer.

Fire Safety In The Home

Most fires occur in the home, and to minimize this danger, it is recommended that a household fire safety audit be conducted and a family escape plan be developed.

Household Fire Safety Audit

- 1 Are all electrical appliances and outlets in a safe condition? Check for frayed cords, overloaded lighting circuits, etc. If you are uncertain about the condition of your electrical appliances or household service, have a professional evaluation.
- 2 Are all flammable liquids stored safely in closed containers in a cool, well ventilated area? Cleaning with flammable liquids should be avoided.
- 3 Are hazardous materials such as matches out of the reach of children?
- 4 Are furnaces and wood burning appliances properly installed, clean and in good working order? If in doubt, have a professional evaluation.

Family Escape Planning

There is often very little time between the detection of a fire and the time it becomes deadly. Because of this, it is very important that a family escape plan be developed and rehearsed.

- 1 Every family member should participate in developing the escape plan.
- 2 Study the possible escape routes from each location within the house. Since many fires occur at night, special attention should be given to the escape routes from sleeping quarters.
- 3 It is essential that escape from a bedroom be possible without opening the interior door. Consider the following when making your escape plans:
 - Make sure that doors and windows that open to the outside are easily opened. Ensure that they are not painted shut, and that their locking mechanisms operate smoothly.
 - If opening the exit or using the exit is too difficult for children, the elderly or handicapped, plans for rescue should be developed. This includes making sure that those who are to perform the rescue can promptly hear the fire warning signal.
 - If the exit is above the ground level, an approved fire ladder or rope should be provided, as well as training in its use.
 - Exits on the ground level should be kept clear. Be sure to remove snow from exterior patio doors in winter; outdoor furniture or equipment should not block exits.
 - The family should have a predetermined assembly point where everyone can be accounted for; for example, across the street or at a neighbour's house.
 - Once everyone is out of the house, call the Fire Department.
 - A good plan emphasizes quick escape. Do not investigate first or attempt to fight the fire, and do not attempt to rescue belongings or valuables as this takes up time. Once outside, do not re-enter the house; wait for the fire department.
 - Write the plan down and rehearse frequently so that should an emergency arise, everyone will know what to do. Revise the plan as conditions change; for example, when there are more or fewer family members in the home, or if there are changes to the house.
 - Make sure your fire warning system is operational by conducting weekly tests. If you are unsure about system operation, contact your smoke detector installer or dealer.
 - It is recommended that you contact your local fire department and request further information on home fire safety and escape planning. If available, have your local fire prevention officer conduct an in-house fire safety inspection.

Enrolling a WLS906

On the back of the smoke detector housing, there will be a five digit and/or six digit serial number. Please refer to your receiver installation manual for information on which serial number should be enrolled. NOTE: If using a WLS900 system, you must use the 5 digit serial number.

Installation Instructions

Specifications

Operating Voltage	9V (six AA alkaline batteries)
Smoke Sensitivity	2.3±0.5 %/ft
Ambient Installation Operating Range	
.....	32°F - 100°F / 0°C - 37.8°C
.....	5% - 95% RH, non-condensing
Field Test	Magnet-activated reed switch or pushbutton
.....	and Gemini 501 Smoke Detector Analyser

Dimensions

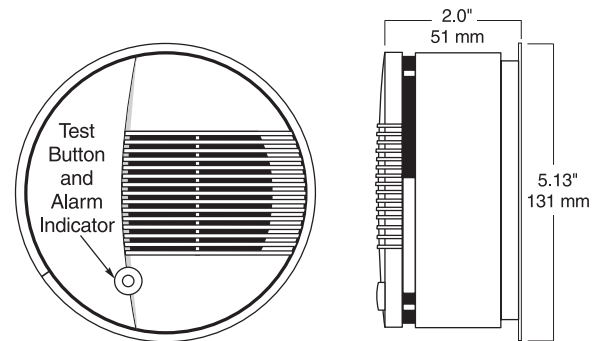

Battery Installation

Remove the mounting plate from the detector by pushing the locking tab and turning the mounting plate counter-clockwise. Hold the unit with the battery compartment facing you, and the imprinted wording right-side up. Install the first two batteries in the row nearest to you, with the + terminals facing left. Next, install the middle two batteries with the + terminals facing to the right. Place your thumb over the centre of these four batteries to keep them in place. Install the last two batteries, with their + terminals facing to the left, by snapping them past the nylon retainer.

Use six AA Alkaline Energizer E91, or Duracell MN1500 batteries. Do not use other brands of batteries for the smoke detector. Using brands other than the Energizer E91 or Duracell MN1500 may affect the operation of the system. Batteries may be purchased in supermarkets and hardware stores.

Mounting the Unit

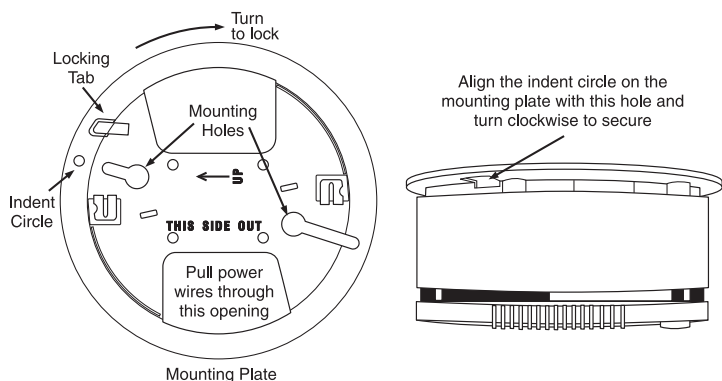

Locate the smoke detector mounting plate on the wall or ceiling and mark all desired screw locations. Use the supplied wall anchors for all screw locations. When the anchors have been placed, secure the mounting plate to the ceiling or wall.

To place the smoke detector on its mounting plate, align the mounting plate's locking tab with the lock recess on the case and turn the unit clockwise until it is firmly secured.

THIS EQUIPMENT SHOULD BE INSTALLED IN ACCORDANCE WITH THE NATIONAL FIRE PROTECTION ASSOCIATION'S STANDARD 72. (National Fire Protection Association, Batterymarch Park, Quincy, MA 02269)

Dust Cover

The dust cover is intended to protect the unit from dust and dirt entry, only while the unit is not in service.

CAUTION: The smoke detector will not function with the dust cover in place.

Installer's Maintenance Instructions

Normally, the Meridian smoke detector will not require maintenance. If the unit is mounted in a dusty environment, the inlet areas of the case should be wiped gently with a soft, dry cloth.

Be sure to inform the user and their monitoring station when maintenance of any sort is performed on the smoke detector or any part of the alarm control system. Always test smoke detectors after maintenance. If a smoke detector continues to generate nuisance alarms even after maintenance, return the unit to DSC for service. Contact DSC at the address and number below to obtain a return authorization number before returning the unit.

Installer's Responsibility to the User

It is the installer's responsibility to thoroughly instruct the end user of the system on the operation, testing and maintenance of their system. The installer should fully explain and demonstrate all functions of the alarm control system and any equipment, such as smoke detectors, connected to it. The user should be provided with all instruction sheets and manuals for their system and any components connected to it. Complete and thorough instruction for the user is essential to ensure they will obtain the greatest benefit from their system. Providing the user with complete operational information will also benefit the installer through a reduction in service calls for nuisance alarms.

Limited Warranty

Digital Security Controls Ltd. warrants that for a period of twelve months from the date of purchase, the product shall be free of defects in materials and workmanship under normal use and that in fulfillment of any breach of such warranty, Digital Security Controls Ltd. shall, at its option, repair or replace the defective equipment upon return of the equipment to its repair depot. This warranty applies only to defects in parts and workmanship and not to damage incurred in shipping or handling, or damage due to causes beyond the control of Digital Security Controls Ltd. such as lightning, excessive voltage, mechanical shock, water damage, or damage arising out of abuse, alteration or improper application of the equipment.

The foregoing warranty shall apply only to the original buyer, and is and shall be in lieu of any and all other warranties, whether expressed or implied and of all other obligations or liabilities on the part of Digital Security Controls Ltd. Digital Security Controls Ltd. neither assumes, nor authorizes any other person purporting to act on its behalf to modify or to change this warranty, nor to assume for it any other warranty or liability concerning this product.

In no event shall Digital Security Controls Ltd. be liable for any direct, indirect or consequential damages, loss of anticipated profits, loss of time or any other losses incurred by the buyer in connection with the purchase, installation or operation or failure of this product.

Smoke detectors that are a part of this system may not properly alert occupants of a fire for a number of reasons, some of which follow. The smoke detectors may have been improperly installed or positioned. Smoke may not be able to reach the smoke detectors, such as when the fire is in a chimney, walls or roofs, or on the other side of closed doors. Smoke detectors may not detect smoke from fires on another level of the residence or building.

Every fire is different in the amount of smoke produced and the rate of burning. Smoke detectors cannot sense all types of fires equally well. Smoke detectors may not provide timely warning of fires caused by carelessness or safety hazards such as smoking in bed, violent explosions, escaping gas, improper storage of flammable materials, overloaded electrical circuits, children playing with matches or arson.

Even if the smoke detector operates as intended, there may be circumstances when there is insufficient warning to allow all occupants to escape in time to avoid injury or death.

Warning: Digital Security Controls Ltd. recommends that the entire system be completely tested on a regular basis. However, despite frequent testing, and due to, but not limited to, criminal tampering or electrical disruption, it is possible for this product to fail to perform as expected.

Important Information: Changes or modifications not expressly approved by Digital Security Controls Ltd. could void the user's authority to operate this equipment.

FCC Compliance Statement

CAUTION: Changes or modifications not expressly approved by Digital Security Controls Ltd. could void your authority to use this equipment.

This equipment generates and uses radio frequency energy and if not installed and used properly, in strict accordance with the manufacturer's instructions, may cause interference to radio and television reception. It has been type tested and found to comply with the limits for Class B device in accordance with the specifications in Subpart "B" of Part 15 of FCC Rules, which are designed to provide reasonable protection against such interference in any residential installation. However, there is no guarantee that interference will not occur in a particular installation. If this equipment does cause interference to television or radio reception, which can be determined by turning the equipment off and on, the user is encouraged to try to correct the interference by one or more of the following measures:

- Re-orient the receiving antenna
- Relocate the alarm control with respect to the receiver
- Move the alarm control away from the receiver
- Connect the alarm control into a different outlet so that alarm control and receiver are on different circuits.

If necessary, the user should consult the dealer or an experienced radio/television technician for additional suggestions. The user may find the following booklet prepared by the FCC helpful: "How to Identify and Resolve Radio/Television Interference Problems". This booklet is available from the U.S. Government Printing Office, Washington, D.C. 20402, Stock # 004-000-00345-4.



For more information and technical assistance:

© 2000 Digital Security Controls Ltd.
Toronto, Canada • www.dscgrp.com
Printed in Canada 29004973 R002