

KTL Test Report: 0R03329.2

Applicant: Digital Security Controls Ltd.
3301 Langstaff Road
Vaughan, Ontario
L4K 4L2

**Equipment Under Test:
(E.U.T.)** WLS906-433
Smoke Detector

In Accordance With: **FCC Part 15, Subpart C**
For Low Power Transmitters Operating Periodically
In The Band 40.66 - 40.77 MHz And Above 70 MHz

Tested By: KTL Ottawa Inc.
3325 River Road, R.R. 5
Ottawa, Ontario K1V 1H2

Authorized By:

G. Westwell, Technologist

Date:

Total Number of Pages: 23

EQUIPMENT: WLS906-433 Smoke Detector

Table of Contents

Section 1. Summary of Test Results..... 3

Section 2. Equipment Under Test (E.U.T.) 5

Section 3. Transmission Requirements 13

Section 4. Radiated Emissions..... 16

Section 5. Occupied Bandwidth..... 19

Section 9. Block Diagrams..... 21

Section 6. Test Equipment List 23

EQUIPMENT: WLS906-433 Smoke Detector

Section 1. Summary of Test Results

General

All measurements are traceable to national standards.

These tests were conducted on a sample of the equipment for the purpose of demonstrating compliance with Part 15, Subpart C, Paragraph 15.231. All tests were conducted using measurement procedure ANSI C63.4-1992. Radiated emissions are made on an open area test site. A description of the test facility is on file with the FCC.

New Submission

Production Unit

Class II Permissive Change

Pre-Production Unit

D	S	C
---	---	---

Equipment Code

THIS TEST REPORT RELATES ONLY TO THE ITEM(S) TESTED.

THE FOLLOWING DEVIATIONS FROM, ADDITIONS TO, OR EXCLUSIONS FROM THE TEST SPECIFICATIONS HAVE BEEN MADE.

See " Summary of Test Data".



NVLAP LAB CODE: 100351-0

TESTED BY: _____ DATE: _____
Russell Grant, Wireless Group Manager

KTL Ottawa Inc. authorizes the above named company to reproduce this report provided it is reproduced in its entirety and for use by the company's employees only.

Any use which a third party makes of this report, or any reliance on or decisions to be made based on it, are the responsibility of such third parties. KTL Ottawa Inc. accepts no responsibility for damages, if any, suffered by any third party as a result of decisions made or actions based on this report.

This report applies only to the items tested.

EQUIPMENT: WLS906-433 Smoke Detector

Summary Of Test Data

Name of Test	Para. Number	Results
Transmission Requirements	15.231(a)	Complies
Radiated Emissions	15.231(b)	Complies
Occupied Bandwidth	15.231(c)	Complies
Frequency Tolerance	15.231(d)	Not Applicable
Periodic Alternate Field Strength Requirements	15.231(e)	Not Applicable
Powerline Conducted Emissions	15.207	Not Applicable

EQUIPMENT: WLS906-433 Smoke Detector

Section 2. Equipment Under Test (E.U.T.)

General Equipment Information

Manufacturer: Digital Security Controls Ltd.

Date Received In Laboratory: November 27, 2000

KTL Identification No.: Items #4 & 5

Frequency Range: 433.92 MHz

Emission Designator: 105 KL1D

Supply Power Requirement: Batteries

Duty Cycle Calculation: $20 \log \left(\frac{12.25}{100} \right) = -18.23 \text{ dB}$

EQUIPMENT: WLS906-433 Smoke Detector

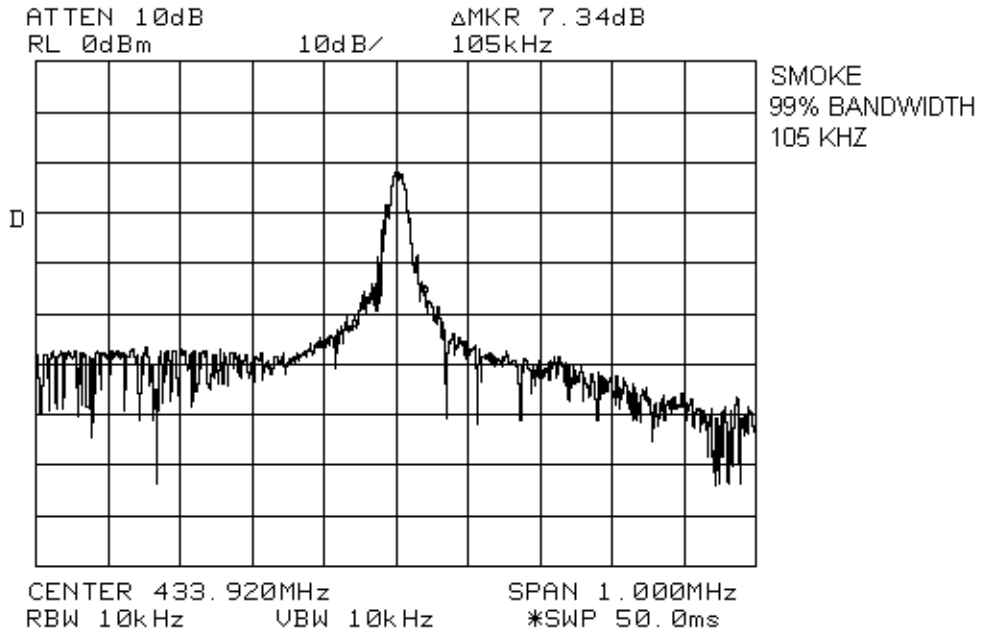

EQUIPMENT: WLS906-433 Smoke Detector

DSC Digital Security Controls
3301 Langstaff Road, Concord
Ontario, Canada L4K 4L2
Tel: (905) 760-3000
Fax: (905) 760-3030
Security Products

Narrow Band 2K baud
Data Transmission Format

CONFIDENTIAL

Data Transmission Format

The transmitted data packet is a fixed length, amplitude modulated packet. The packet contains all of the necessary information to indicate which sensor generated the packet, the type of sensor and the status of the sensor's inputs. The data is sent at a rate of 500 µS per bit or 2 Kbits per Second.
Figure 1 shows the bit timing used for all bits in the packet. Where a low logic present for the 500 us bit time represents a data logic "0", and 250 us low then 250 us high represents a data logic "1".

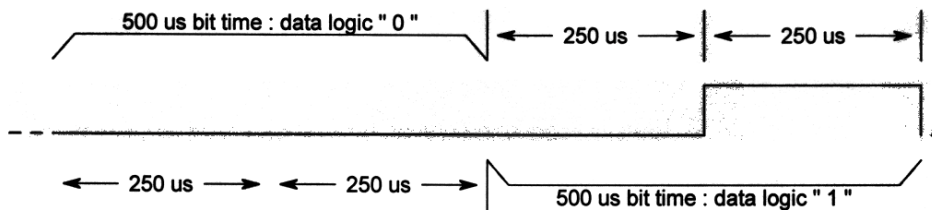

Figure 1 – Bit Timing

Figure 2 shows the format of the transmitted data packet. Bytes highlighted in green are bytes that are variable information that would depend on the current status, module type, and serial number of the particular device.

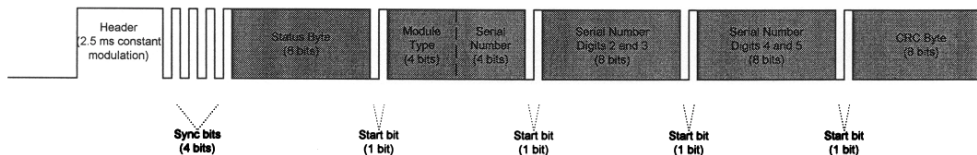

Figure 2 – Data Packet format

Because these bytes are variable there is a best and worst case packet when considering ON time.

Minimum ON time

The packet with the minimum on time would be:

$$2.5\text{ms header} + 1111 + 1000\ 0000 + 1 + 0010\ 0000 + 1 + 0000\ 0001 + 1 + 0000\ 0001 + 1 + 0011\ 1001$$

Thus the minimum ON time would be: $2.5\text{ ms} + (16\ \text{ON bits} * 0.25\ \text{ms per bit})$
 $2.5\ \text{ms} + 4\ \text{ms}$
6.5 ms

Maximum ON time

The packet with the maximum on time would be:

$$2.5\text{ms header} + 1111 + 1111\ 1111 + 1 + 0110\ 1111 + 1 + 1111\ 1110 + 1 + 1111\ 1110 + 1 + 1001\ 0001$$

EQUIPMENT: WLS906-433 Smoke Detector



Narrow Band 2K baud
Data Transmission Format

CONFIDENTIAL

Thus the maximum ON time would be: $2.5 \text{ ms} + (39 \text{ ON bits} * 0.25 \text{ ms per bit})$
 $2.5 \text{ ms} + 9.75 \text{ ms}$
12.25

The components of the data packet are broken down in Table 1 showing the maximum and minimum ON times for the packet. These maximum and minimum ON times are based on best and worst case possible information that is transmitted by the devices.

Packet Component	Description	# of Bits	Max. ON Time	Min. ON Time	Total Time
Header	2.5 ms of carrier frequency to indicate start of packet.	-	2.5 ms	2.5 ms	2.5 ms
Sync Bits	4 logic '1' bits for synchronization	4	1 ms	1 ms	2 ms
Status	Status information:				4 ms
	minimum valid value = 80 hex (1000 0000 binary)	1	-	0.25 ms	
	maximum valid value = FF hex (1111 1111 binary)	8	2 ms	-	
Start Bit	1 logic '1' bit for synchronization	1	0.25 ms	0.25 ms	0.5 ms
Module Type	Valid module types currently used are: 2 hex (0010 binary), 3 hex (0011 binary), 4 hex (0100 binary), 5 hex (0101 binary), 6 hex (0110 binary), and 9 hex (1001 binary).				2 ms
	minimum valid value = 2 or 4 hex	1	-	0.25 ms	
	maximum valid value = 3, 5, 6, or 9 hex	2	0.5 ms	-	
Serial # Digit 1	minimum valid value = 0 hex (0000 binary)	0	-	0 ms	2 ms
	maximum valid value = F hex (1111 binary)	4	1 ms	-	
Start Bit	1 logic '1' bit for synchronization	1	0.25 ms	0.25 ms	0.5 ms
Serial # Digit 2 and 3	minimum valid value = 01 hex (0000 0001 binary)	1	-	0.25 ms	4 ms
	maximum valid value = FE hex (1111 1110 binary)	7	1.75 ms	-	
Start Bit	1 logic '1' bit for synchronization	1	0.25 ms	0.25 ms	0.5 ms
Serial # Digit 4 and 5	minimum valid value = 01 hex (0000 0001 binary)	1	-	0.25 ms	4 ms
	maximum valid value = FE hex (1111 1110 binary)	7	1.75 ms	-	
Start Bit	1 logic '1' bit for synchronization	1	0.25 ms	0.25 ms	0.5 ms
CRC	Cyclic Redundancy Check value				4 ms
	CRC byte calculated from above minimum values = 39 hex (0011 1001 binary)	4	-	1 ms	
	CRC byte calculated from above maximum values = 91 hex (1001 0001 binary)	3	0.75 ms	-	
Total Maximum ON time based on valid packet information:			12.25 ms		
Total Minimum ON time based on valid packet information:				6.50 ms	
Total packet time:					26.5 ms

Diagram 1 – Maximum / Minimum packet ON times

EQUIPMENT: WLS906-433 Smoke Detector

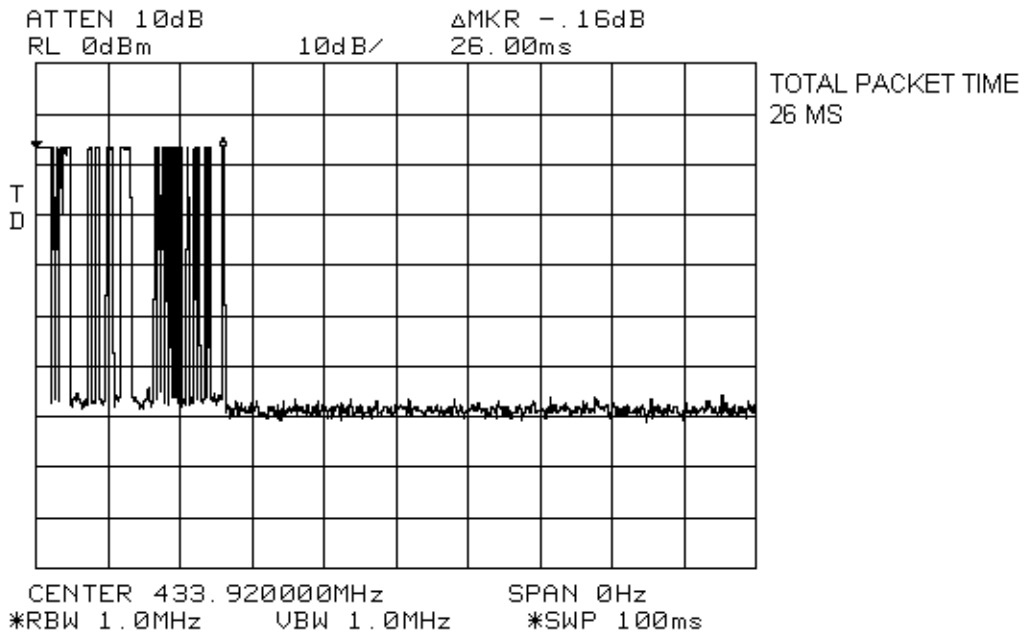

EQUIPMENT: WLS906-433 Smoke Detector

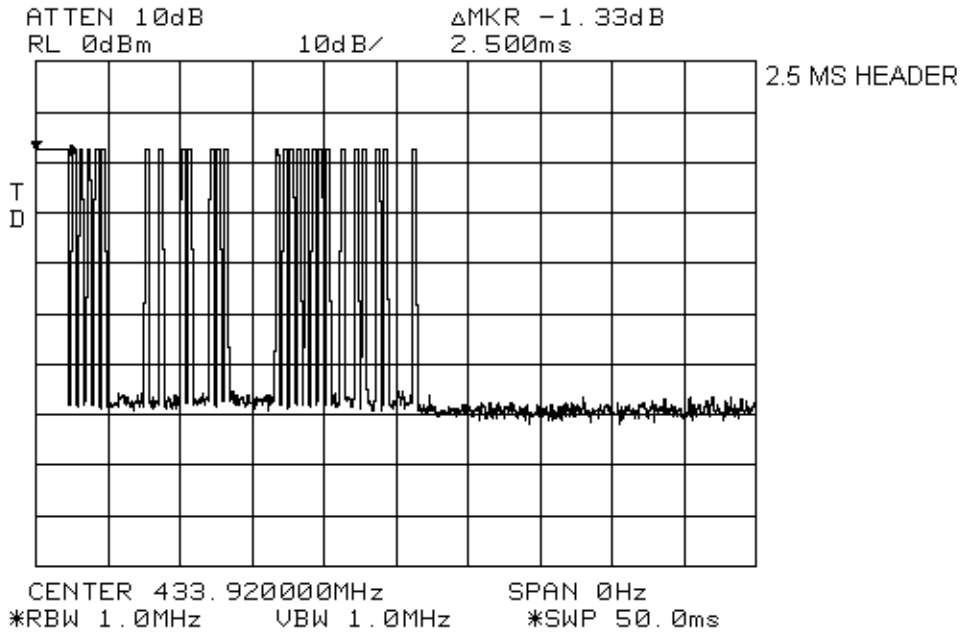

EQUIPMENT: WLS906-433 Smoke Detector

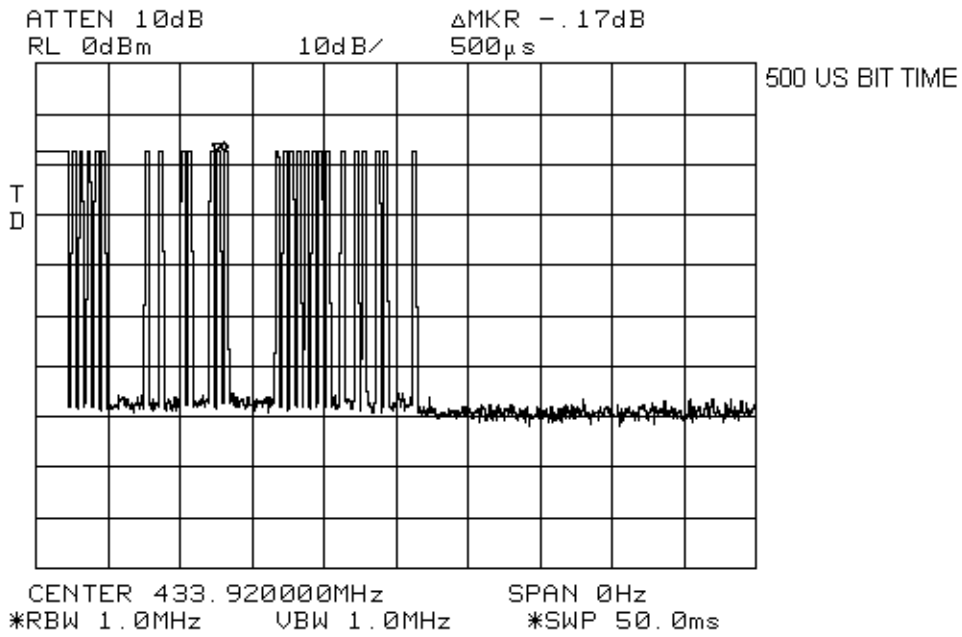

EQUIPMENT: WLS906-433 Smoke Detector

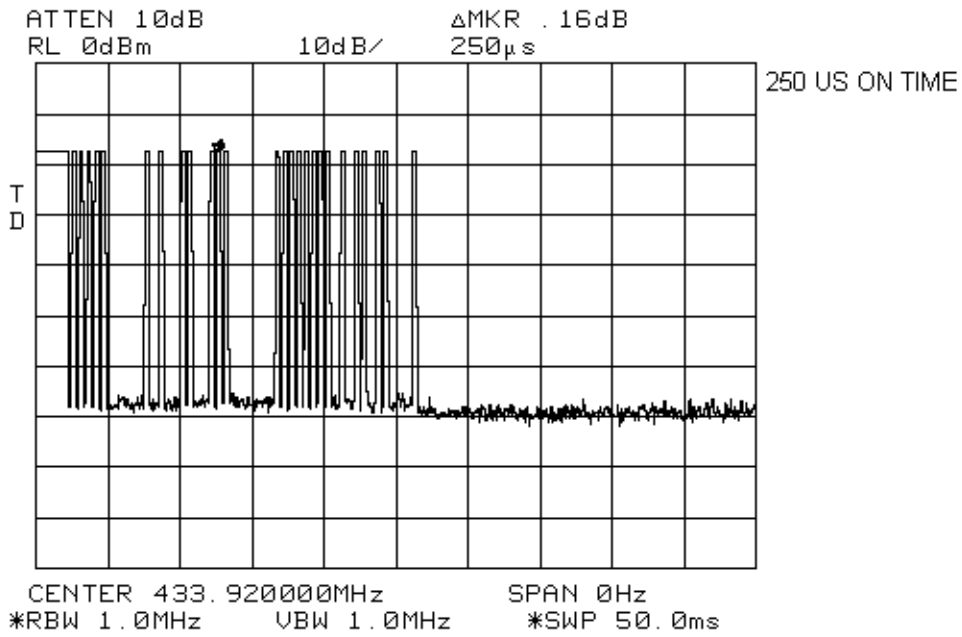

EQUIPMENT: WLS906-433 Smoke Detector

Section 3. Transmission Requirements

Para. No.: 15.231(a)

Test Performed By: Russell Grant	Date of Test: November 28, 2000
-----------------------------------------	----------------------------------------

Minimum Standard: 15.231(a) Continuous transmissions such as voice, video or data transmissions are not permitted.

15.231(a)(1) A manually operated transmitter shall employ a switch that will automatically deactivate the transmitter within not more than 5 seconds after being released.

15.231(a)(2) A transmitter activated automatically shall cease transmission within 5 seconds of activation.

15.231(a)(3) Periodic transmissions at regular pre-determined intervals are not permitted. However polling or supervisory transmissions to determine system integrity of transmitters used in security or safety applications are allowed if the periodic rate of transmission does not exceed one transmission of not more than one second duration per hour for each transmitter.

15.231(a)(4) Intentional radiators which are employed for radio control purposes during emergencies involving fire, security, and safety of life, when activated to signal an alarm, may operate during the pendency of the alarm.

Test Results: Complies.

Test Data: Compliance was determined by verification of technical specifications and a functional test on the equipment.

EQUIPMENT: WLS906-433 Smoke Detector

Rationale for Compliance with Transmission Requirements

15.231(a)(1) : Not applicable.

15.231(a)(2) : Involves fire, security and safety of life.

15.231(a)(3) : Not applicable.

15.231(a)(4) : 14 seconds.

EQUIPMENT: WLS906-433 Smoke Detector

Section 4. Radiated Emissions

Para. No.: 15.231(b)

Test Performed By: Russell Grant	Date of Test: November 28, 2000
-----------------------------------------	----------------------------------------

Minimum Standard:

Permissible Field Strength Limits (Momentarily Operated Devices)

Fundamental Frequency (MHz)	Field Strength of Fundamental Microvolts/Meter at 3 meters; (watts)	Field Strength of Unwanted Emissions Microvolts/Meter at 3 meters; (watts)
40.66 - 40.70	2,250	225
70-130	1, 250	125
130-174	1,250 to 3,750*	125 to 375
174-260 (note 1)	3,750	375
260-470 (note 1)	3,750 to 12,500*	375 to 1,250
Above 470	12,500	1,250

Notes:

# Use quasi-peak or averaging meter.	For 130 - 174 MHz: $FS \text{ (microvolts/m)} = (56.82 \times F) - 6136$
* Linear interpolation with frequency F in MHz	For 260 - 470 MHz: $FS \text{ (microvolts/m)} = (41.67 \times F) - 7083$

Any emissions that fall within the restricted bands of 15.205 shall not exceed the following limits:

Frequency (MHz)	Field Strength ($\mu\text{V/m}$ @ 3m)	Field Strength (dB @ 3m)
30 - 88	100	40.0
88 - 216	150	43.5
216 - 960	200	46.0
Above 960	500	54.0

Test Results: Complies. The worst-case emission level is 76.2 dB $\mu\text{V/m}$ @ 3m at 433.92 MHz. This is 4.6dB below the specification limit.

Test Data: See attached table.

Above 1 GHz a spectrum analyzer and low noise amplifier are used to measure emission levels. The spectrum analyzer resolution bandwidth was set to 1 MHz and video bandwidth was 3 MHz.

In the case of handheld equipment, the E.U.T. is rotated in three planes to obtain worst-case results.

EQUIPMENT: WLS906-433 Smoke Detector

Test Data - Radiated Emissions

Test Distance (meters) : 3		Range: A Tower		RBW(kHz): 1000			Detector: Peak		
Freq. (MHz)	Ant. *	Pol. (V/H)	RCVD Signal (dBµV/m)	Ant. Factor (dB)**	Amp. Gain (dB)***	Dist. Corr. (dB)	Field Strength (dBµV/m)	Limit (dBµV/m)	Margin (dB)
433.92	E/D4	V	66.8	24.9		-18.23	73.4	80.8	7.4
433.92	E/D4	H	69.6	24.9		-18.23	76.2	80.8	4.6
867.84	E/D4	V	17.1	31.9		-18.23	30.7	60.8	30.1
867.84	E/D4	H	20.2	31.9		-18.23	33.8	60.8	27.0
1301.78	Hrn1	V	52.0	30.6	-48.0	-18.23	16.3	54.0	37.7
1301.78	Hrn1	H	60.5	30.6	-48.0	-18.23	24.8	54.0	29.2
1735.68	Hrn1	V	62.3	32.4	-48.0	-18.23	28.4	60.8	32.4
1735.68	Hrn1	H	68.8	32.4	-48.0	-18.23	34.9	60.8	25.9
2169.6	Hrn1	V	73.5	35.2	-58.3	-18.23	32.1	60.8	28.7
2169.6	Hrn1	H	73.7	35.2	-58.3	-18.23	32.3	60.8	28.5
2603.52	Hrn1	V	78.3	37.5	-60.0	-18.23	37.5	60.8	23.3
2603.52	Hrn1	H	82.1	37.5	-60.0	-18.23	41.3	60.8	19.5
3037.44	Hrn1	V	76.2	38.8	-59.4	-18.23	37.3	60.8	23.5
3037.44	Hrn1	H	78.0	38.8	-59.4	-18.23	39.1	60.8	21.7
3471.36	Hrn1	V	71.7	40.2	-57.3	-18.23	36.3	60.8	24.5
3471.36	Hrn1	H	73.2	40.2	-57.3	-18.23	37.8	60.8	23.0
3905.28	Hrn1	V	72.0	42.2	-57.8	-18.23	38.1	54.0	15.9
3905.28	Hrn1	H	71.5	42.2	-57.8	-18.23	37.6	54.0	16.4
4339.25	Hrn1	V	66.3	43.1	-54.9	-18.23	36.2	54.0	17.8
4339.28	Hrn1	H	66.7	43.1	-54.9	-18.23	36.6	54.0	17.4

Notes:
 B/C = Biconical, B/L = Biconilog, L/P = Log-Periodic, H = Horn, D/P = Dipole
 * Re-measured using dipole antenna.
 ** Includes cable loss when amplifier is not used.
 *** Includes cable loss.
 () Denotes failing emission level.
 N.D. = Not Detected

EQUIPMENT: WLS906-433 Smoke Detector

Radiated Photographs (Worst Case Configuration)

Front View

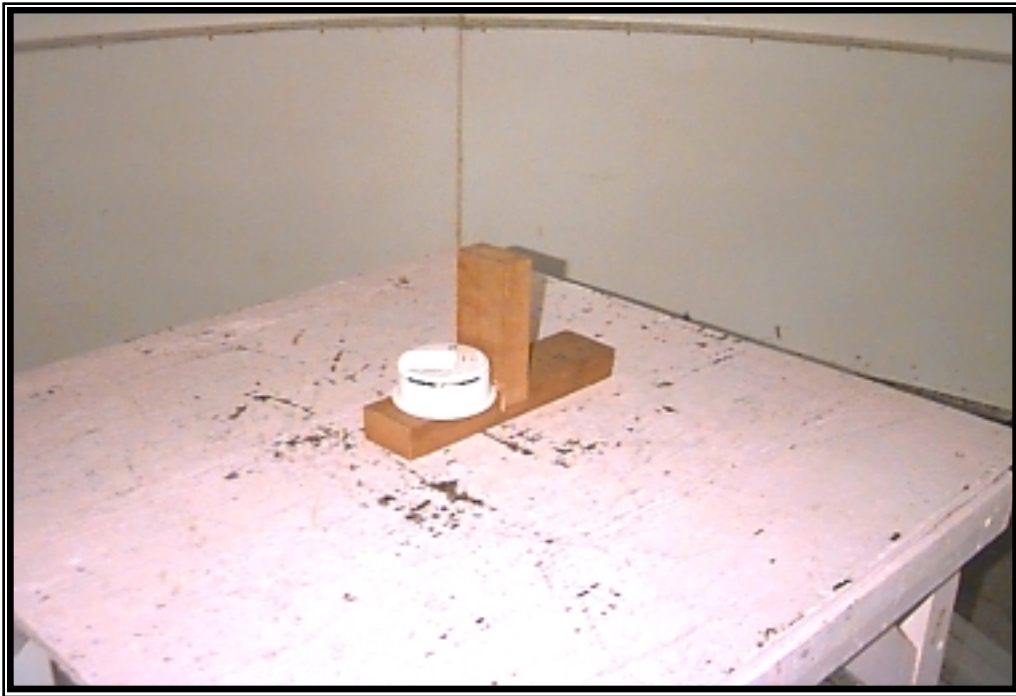

EQUIPMENT: WLS906-433 Smoke Detector

Section 5. Occupied Bandwidth

Para. No.: 15.231(c)

Test Performed By: Russell Grant	Date of Test: November 28, 2000
-----------------------------------------	----------------------------------------

Minimum Standard: 15.231(c) The bandwidth of the emission shall be no wider than 0.25% of the center frequency for devices operating above 70 MHz and below 900 MHz. For devices operating above 900 MHz, the emission shall be no wider than 0.5% of the center frequency. Bandwidth is determined at the points 20 dB down from the modulated carrier.

Test Results: Complies. See attached graph.

Test Data: See attached graph.

EQUIPMENT: WLS906-433 Smoke Detector

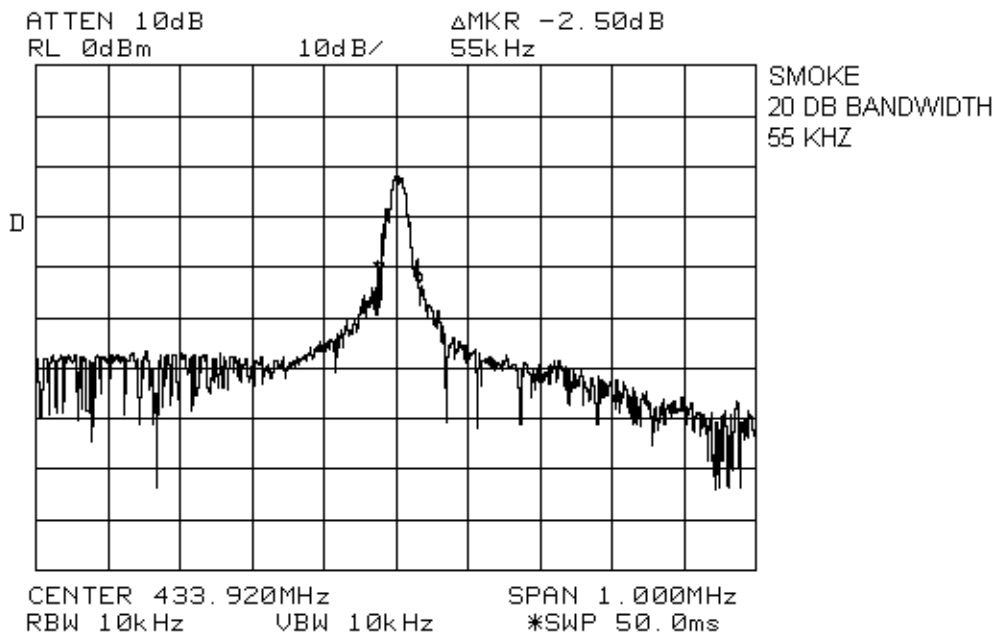

EQUIPMENT: WLS906-433 Smoke Detector

Section 9. Block Diagrams

Radiated Prescan

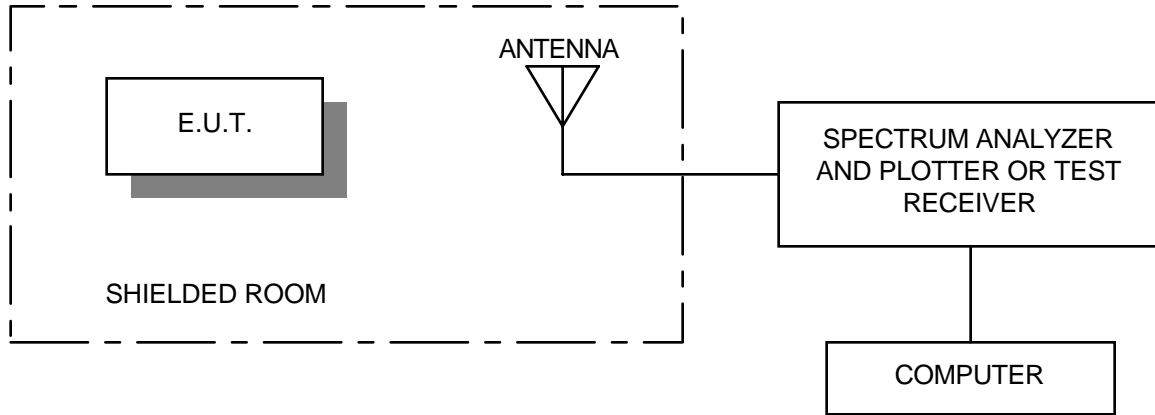

Outdoor Test Site For Radiated Emissions

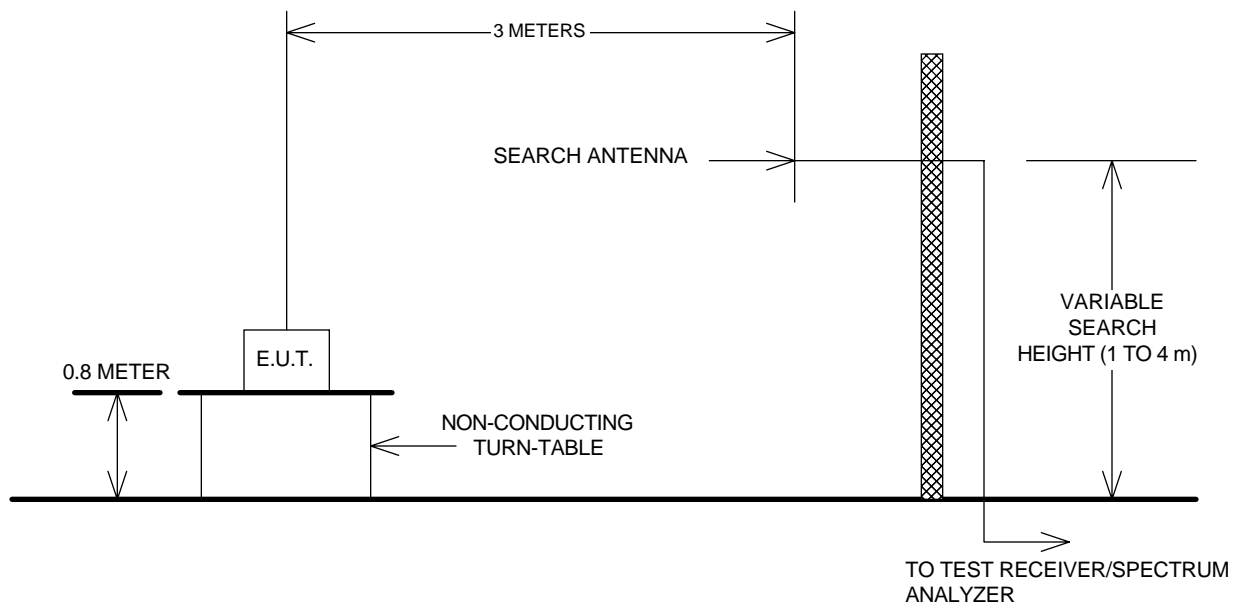

The spectrum was searched up to the 10th harmonic of the fundamental frequency of operation.

EQUIPMENT: WLS906-433 Smoke Detector

Occupied Bandwidth

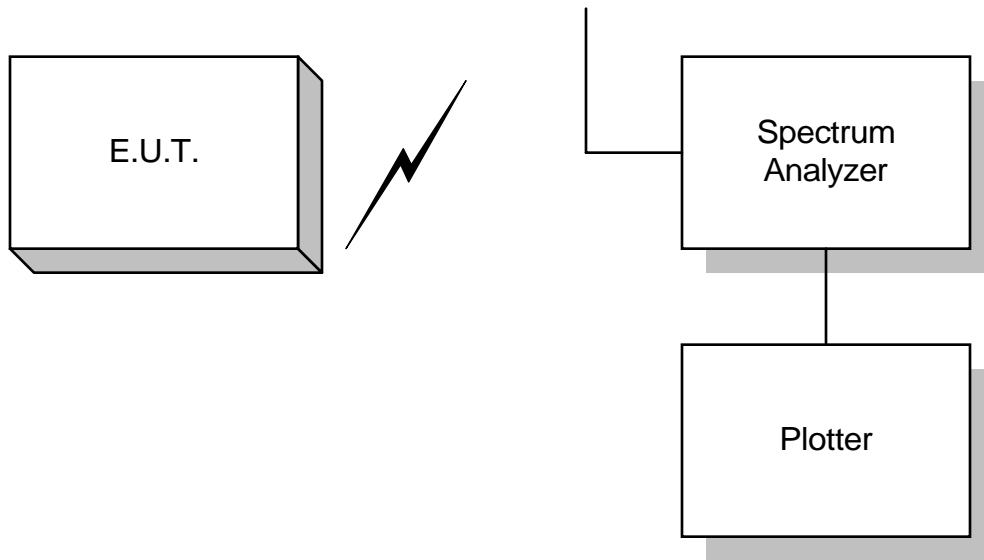

EQUIPMENT: WLS906-433 Smoke Detector

Section 6. Test Equipment List

CAL CYCLE	EQUIPMENT	MANUFACTURER	MODEL	SERIAL	LAST CAL.	NEXT CAL.
1 Year	Spectrum Analyzer	Hewlett Packard	8565E	FA000981	June 16/00	June 16/01
1 Year	Receiver	Rohde & Schwarz	ESVP	892661/014	April 5/00	April 5/01
1 Year	Horn Antenna	EMCO #1	3115	3132	Dec. 21/99	Dec. 21/00
1 Year	Dipole Antenna Set	EMCO #2	3121C	FA001349	June 27/00	June 27/01
1 Year	RF AMP	JCA	2-4 GHz	FA001496	May 31/00	May 31/01
1 Year	RF AMP	JCA	1-2 GHz	FA001498	May 31/00	May 31/01
1 Year	RF AMP	JCA	4-8 GHz	FA001497	May 31/00	May 31/01

NA: Not Applicable
NCR: No Cal Required
COU: CAL On Use