

**KTL Test Report:** 0R02419

**Applicant:** Digital Security Controls Ltd.  
3301 Langstaff Road  
Vaughan, Ontario  
L4K 4L2

**Equipment Under Test:  
(E.U.T.)** WLS914-433

**FCC ID:** F5300NB914

**In Accordance With:** **FCC Part 15, Subpart C**  
For Low Power Transmitters Operating Periodically  
In The Band 40.66 - 40.77 MHz And Above 70 MHz

**Tested By:** KTL Ottawa Inc.  
3325 River Road, R.R. 5  
Ottawa, Ontario K1V 1H2

**Authorized By:**  
  
R. Grant, Wireless Group Manager

**Date:**

**Total Number of Pages:** 24

*EQUIPMENT: WLS914-433*  
*FCC ID: F5300NB914*

---

**Table of Contents**

**Section 1. Summary of Test Results..... 3**

**Section 2. Equipment Under Test (E.U.T.) ..... 5**

**Section 3. Transmission Requirements ..... 11**

**Section 4. Radiated Emissions..... 14**

**Section 5. Occupied Bandwidth..... 17**

**Section 6. Block Diagrams..... 20**

**Section 7. Test Equipment List ..... 22**

**Annex A Restricted Bands..... A1**

*EQUIPMENT: WLS914-433*  
*FCC ID: F5300NB914*

---

## **Section 1. Summary of Test Results**

### **General**

**All measurements are traceable to national standards.**

These tests were conducted on a sample of the equipment for the purpose of demonstrating compliance with Part 15, Subpart C, Paragraph 15.231. All tests were conducted using measurement procedure ANSI C63.4-1992. Radiated emissions are made on an open area test site. A description of the test facility is on file with the FCC.



New Submission



Production Unit



Class II Permissive Change



Pre-Production Unit

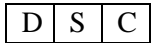

Equipment Code

THIS TEST REPORT RELATES ONLY TO THE ITEM(S) TESTED.

THE FOLLOWING DEVIATIONS FROM, ADDITIONS TO, OR EXCLUSIONS FROM THE TEST SPECIFICATIONS HAVE BEEN MADE.

See " Summary of Test Data".



**NVLAP LAB CODE: 100351-0**

TESTED BY: \_\_\_\_\_ DATE: \_\_\_\_\_  
Kevin Carr, Technologist

KTL Ottawa Inc. authorizes the above named company to reproduce this report provided it is reproduced in its entirety and for use by the company's employees only.

Any use which a third party makes of this report, or any reliance on or decisions to be made based on it, are the responsibility of such third parties. KTL Ottawa Inc. accepts no responsibility for damages, if any, suffered by any third party as a result of decisions made or actions based on this report.

This report applies only to the items tested.

*EQUIPMENT: WLS914-433*  
*FCC ID: F5300NB914*

---

**Summary Of Test Data**

<b>Name of Test</b>	<b>Para. Number</b>	<b>Results</b>
Transmission Requirements	15.231(a)	Complies
Radiated Emissions	15.231(b)	Complies
Occupied Bandwidth	15.231(c)	Complies
Frequency Tolerance	15.231(d)	Not Applicable
Periodic Alternate Field Strength Requirements	15.231(e)	Not Applicable
Powerline Conducted Emissions	15.207	Not Applicable

**Footnotes For N/A's:**

**Test Conditions:**

**Indoor**                      Temperature: 24 °C  
   Humidity: 40 %

**Outdoor**                     Temperature: 15 °C  
   Humidity: 40 %

*EQUIPMENT: WLS914-433*  
*FCC ID: F5300NB914*

---

**Section 2. Equipment Under Test (E.U.T.)**

**General Equipment Information**

**Manufacturer:** Digital Control Systems

**Model No.:** WLS914-433

**Serial No.:** 399907

**Date Received In Laboratory:** April 24, 2000

**KTL Identification No.:** Items #2 & 4

**Frequency Range:** 433.92 MHz, Fixed Frequency

**Operating Frequency(ies) of Sample:** 433.92

**Type of Emission:** Pulse Width Modulation

**Emission Designator:** 387KL1D

**Supply Power Requirement:** 3AA Batteries

**Duty Cycle Calculation:**  $20 \text{ Log } \frac{12.25ms}{100ms} = -18.2 \text{ dB}$

EQUIPMENT: WLS914-433  
 FCC ID: F5300NB914

**Data Transmission Format**

The transmitted data packet is a fixed length, amplitude modulated packet. The packet contains all of the necessary information to indicate which sensor generated the packet, the type of sensor and the status of the sensor’s inputs. The data is sent at a rate of 500  $\mu$ S per bit or 2 Kbits per second.

Figure 1 shows the bit timing used for all bits in the packet. Where a low logic present for the 500  $\mu$ S bit time represents a data logic “0” and 250  $\mu$ S low then 250  $\mu$ S high represents a data logic “1”.

**Figure 1 – Bit Timing**

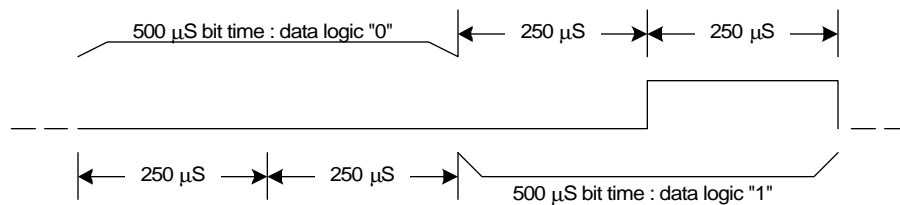
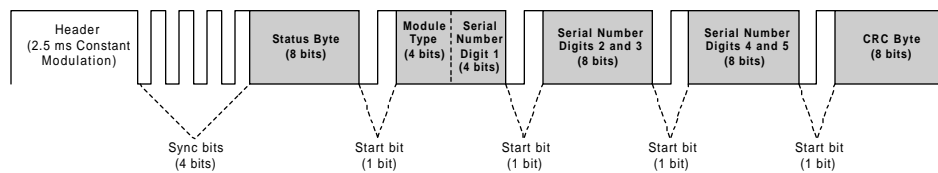

Figure 2 shows the format of the transmitted data packet. Bytes highlighted in green are bytes that are variable information that would depend on the current status, module type and serial number of the particular device.

**Figure 2 – Data Packet Format**



Because these bytes are variable there is a best and worst case packet when considering ON Time.

EQUIPMENT: WLS914-433  
 FCC ID: F5300NB914

**Diagram 1 – Maximum / Minimum Packet ON Times**

Packet Component	Description	No. Of Bits	Maximum ON Time	Minimum ON Time	Total Time
<b>Header</b>	2.5 ms Of Carrier Frequency To Indicate Start of Packet	—	2.5 ms	2.5 ms	2.5 ms
<b>Sync Bits</b>	4 Logic '1' Bits For Synchronization	4	1 ms	1 ms	2 ms
<b>Status</b>	Status Information:				4 ms
	Minimum Valid Value = 80 hex (1000 0000 Binary)	1	—	0.25 ms	
	Maximum Valid Value = FF hex (1111 1111 Binary)	8	2 ms	—	
<b>Start Bit</b>	1 Logic '1' Bit For Synchronization	1	0.25 ms	0.25 ms	0.5 ms
<b>Module Type</b>	Valid Module Types Currently Used Are: 2 Hex (0010 Binary), 3 Hex (0011 Binary) 4 Hex (0100 Binary), 5 Hex (0101 Binary) 6 Hex (0110 Binary), 9 Hex (1001 Binary)				2 ms
	Minimum Valid Value = 2 or 4 Hex	1	—	0.25 ms	
	Maximum Valid Value = 3,5,6 or 9 Hex	2	0.5 ms	—	
<b>Serial # Digit 1</b>	Minimum Valid Value = 0 Hex (0000 Binary)	0	—	0 ms	2 ms
	Maximum Valid Value = F Hex (1111 Binary)	4	1 ms	—	
<b>Start Bit</b>	1 Logic '1' Bit For Synchronization	1	0.25 ms	0.25 ms	0.5 ms
<b>Serial # Digit 2&amp;3</b>	Minimum Valid Value = 01 Hex (0000 0001 Binary)	1	—	0.25 ms	4 ms
	Maximum Valid Value = F0 Hex (1111 1110 Binary)	7	1.75 ms	—	
<b>Start Bit</b>	1 Logic '1' Bit For Synchronization	1	0.25 ms	0.25 ms	0.5 ms
<b>Serial # Digit 4&amp;5</b>	Minimum Valid Value = 01 Hex (0000 0001 Binary)	0	—	0.25 ms	4 ms
	Maximum Valid Value = F0 Hex (1111 1110 Binary)	7	1.75 ms	—	
<b>Start Bit</b>	1 Logic '1' Bit For Synchronization	1	0.25 ms	0.25 ms	0.5 ms
<b>CRC</b>	Cyclic Redundancy Check Value				4 ms
	CRC Byte Calculated From Above Minimum Values = 39 Hex (0011 1001 Binary)	4	—	1 ms	
	CRC Byte Calculated From Above Maximum Values = 91 Hex (1001 0001 Binary)	3	0.75 ms	—	
Total Maximum ON Time Based On Valid Packet Information			<b>12.25 ms</b>		
Total Minimum ON Time Based On Valid Packet Information				<b>6.50 ms</b>	
Total Packet Time					<b>26.5 ms</b>









*EQUIPMENT: WLS914-433*  
*FCC ID: F5300NB914*

---

### **Section 3.       Transmission Requirements**

**Para. No.: 15.231(a)**

<b>Test Performed By:</b> Kevin Carr	<b>Date of Test:</b> April 24, 2000
--------------------------------------	-------------------------------------

**Minimum Standard:**       15.231(a) Continuous transmissions such as voice, video or data transmissions are not permitted.

15.231(a)(1) A manually operated transmitter shall employ a switch that will automatically deactivate the transmitter within not more than 5 seconds after being released.

15.231(a)(2) A transmitter activated automatically shall cease transmission within 5 seconds of activation.

15.231(a)(3) Periodic transmissions at regular pre-determined intervals are not permitted. However polling or supervisory transmissions to determine system integrity of transmitters used in security or safety applications are allowed if the periodic rate of transmission does not exceed one transmission of not more than one second duration per hour for each transmitter.

15.231(a)(4) Intentional radiators which are employed for radio control purposes during emergencies involving fire, security, and safety of life, when activated to signal an alarm, may operate during the pendency of the alarm.

**Test Results:**               Complies.

**Test Data:**                 Compliance was determined by verification of technical specifications and a functional test on the equipment.

*EQUIPMENT: WLS914-433*

*FCC ID: F5300NB914*

---

**Rationale for Compliance with Transmission Requirements**

**15.231(a)(1) :** Not applicable. This equipment has no provision for manual activation.

**15.231(a)(2) :** Tx duration is 1.125 sec.

**15.231(a)(3) :** Not applicable. This equipment has no provision for periodic operation.

**15.231(a)(4) :** Not applicable.



EQUIPMENT: WLS914-433  
 FCC ID: F5300NB914

**Section 4. Radiated Emissions**

Para. No.: 15.231(b)

<b>Test Performed By:</b> Kevin Carr	<b>Date of Test:</b> April 24, 2000
--------------------------------------	-------------------------------------

**Minimum Standard:**

**Permissible Field Strength Limits (Momentarily Operated Devices)**

Fundamental Frequency (MHz)	Field Strength of Fundamental Microvolts/Meter at 3 meters; (watts)	Field Strength of Unwanted Emissions Microvolts/Meter at 3 meters; (watts)
40.66 - 40.70	2,250	225
70-130	1, 250	125
130-174	1,250 to 3,750*	125 to 375
174-260 (note 1)	3,750	375
260-470 (note 1)	3,750 to 12,500*	375 to 1,250
Above 470	12,500	1,250

**Notes:**

# Use quasi-peak or averaging meter.	For 130 - 174 MHz: $FS \text{ (microvolts/m)} = (56.82 \times F) - 6136$
* Linear interpolation with frequency F in MHz	For 260 - 470 MHz: $FS \text{ (microvolts/m)} = (41.67 \times F) - 7083$

Any emissions that fall within the restricted bands of 15.205 shall not exceed the following limits:

Frequency (MHz)	Field Strength ( $\mu\text{V/m}$ @ 3m)	Field Strength (dB @ 3m)
30 - 88	100	40.0
88 - 216	150	43.5
216 - 960	200	46.0
Above 960	500	54.0

**Test Results:** Complies. The worst-case emission level is 75.6 dB $\mu\text{V/m}$  @ 3m at 433.92 MHz. This is 5.2 dB below the specification limit.

**Test Data:** See attached table.

Above 1 GHz a spectrum analyzer and low noise amplifier are used to measure emission levels. The spectrum analyzer resolution bandwidth was set to 1 MHz and video bandwidth was 3 MHz.

In the case of handheld equipment, the E.U.T. is rotated in three planes to obtain worst-case results.

EQUIPMENT: WLS914-433  
 FCC ID: F5300NB914

**Test Data - Radiated Emissions**

Test Distance (meters) : 3		Range: A Tower		Receiver: ESVP		RBW 120 kHz, 1 MHz		Detector: CISPR, PEAK	
Freq. (MHz)	Ant. *	Pol. (V/H)	RCVD Signal (dBµV/m)	Ant. Factor (dB)**	Amp. Gain (dB)***	Duty Cycle (dB)	Field Strength (dBµV/m)	Limit (dBµV/m)	Margin (dB)
433.86	E/D4	V	67.9	25.9		-18.2	75.6	80.8	5.2
433.86	E/D4	H	63.2	25.9		-18.2	70.9	80.8	9.9
867.84	E/D4	V	21.0	34.4		-18.2	37.2	60.8	23.6
867.84	E/D4	H	17.2	34.4		-18.2	33.4	60.8	27.4
1301.8	Hrn2	V	31.8	29.4		-18.2	43.0	54.0	11.0
1301.8	Hrn2	H	27.5	29.4		-18.2	38.7	54.0	15.3
1735.7	Hrn2	V	24.2	32.1		-18.2	38.1	60.8	22.7
1735.6	Hrn2	H	24.7	32.1		-18.2	38.6	60.8	22.2
2169.6	Hrn2	V	34.7	34.4		-18.2	50.9	60.8	9.9
2169.6	Hrn2	H	30.0	34.4		-18.2	46.2	60.8	14.6
2603.5	Hrn2	V	26.2	36.0		-18.2	44.0	60.8	16.8
2603.5	Hrn2	H	25.0	36.0		-18.2	42.8	60.8	18.0
3037.4	Hrn2	V	17.5	37.6		-18.2	36.9	60.8	23.9
3037.4	Hrn2	H	19.6	37.6		-18.2	39.0	60.8	21.8
3471.4	Hrn2	V	19.3	40.4		-18.2	41.5	60.8	19.3
3471.5	Hrn2	H	22.7	40.4		-18.2	44.9	60.8	15.9
3905.3	Hrn2	V	17.2	41.3		-18.2	40.3	54.0	13.7
3905.3	Hrn2	H	16.7	41.3		-18.2	39.8	54.0	14.2
4339.2	Hrn2	V	16.8	41.8		-18.2	40.4	54.0	13.6
4339.2	Hrn2	H	16.8	41.8		-18.2	40.4	54.0	13.6

**Notes:**  
 B/C = Biconical, B/L = Biconilog, L/P = Log-Periodic, H = Horn, D/P = Dipole  
 \* Re-measured using dipole antenna.  
 \*\* Includes cable loss when amplifier is not used.  
 \*\*\* Includes cable loss.  
 ( ) Denotes failing emission level.  
 N.D. = Not Detected

*EQUIPMENT: WLS914-433*

*FCC ID: F5300NB914*

---

**Radiated Photographs (Worst Case Configuration)**

**Front View**

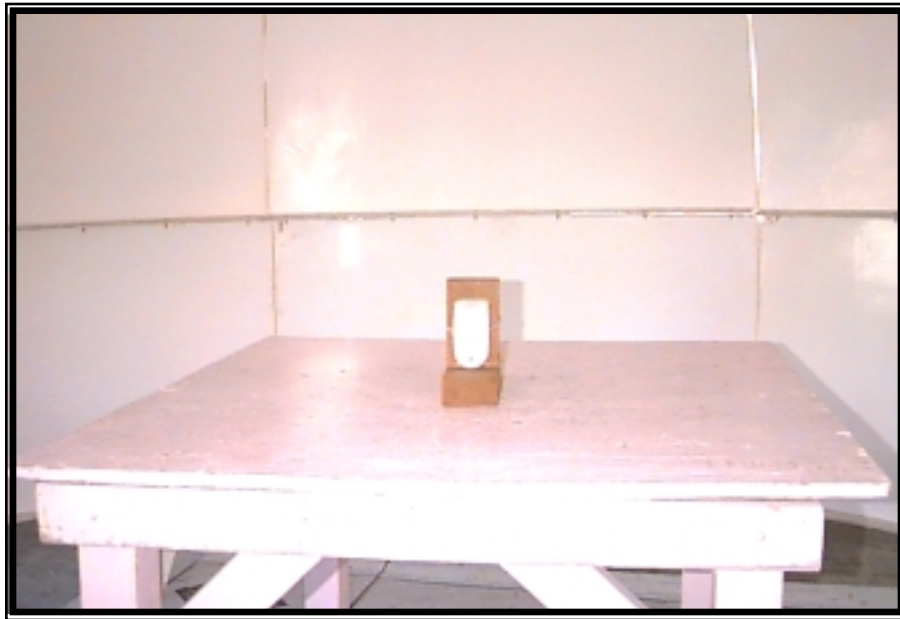



*EQUIPMENT: WLS914-433*  
*FCC ID: F5300NB914*

---

**Section 5. Occupied Bandwidth**

**Para. No.: 15.231(c)**

<b>Test Performed By:</b> Kevin Carr	<b>Date of Test:</b> April 24, 2000
--------------------------------------	-------------------------------------

**Minimum Standard:** 15.231(c) The bandwidth of the emission shall be no wider than 0.25% of the center frequency for devices operating above 70 MHz and below 900 MHz. For devices operating above 900 MHz, the emission shall be no wider than 0.5% of the center frequency. Bandwidth is determined at the points 20 dB down from the modulated carrier.

**Test Results:** Complies. See attached graph.

**Test Data:** See attached graph.

EQUIPMENT: WLS914-433  
FCC ID: F5300NB914

---

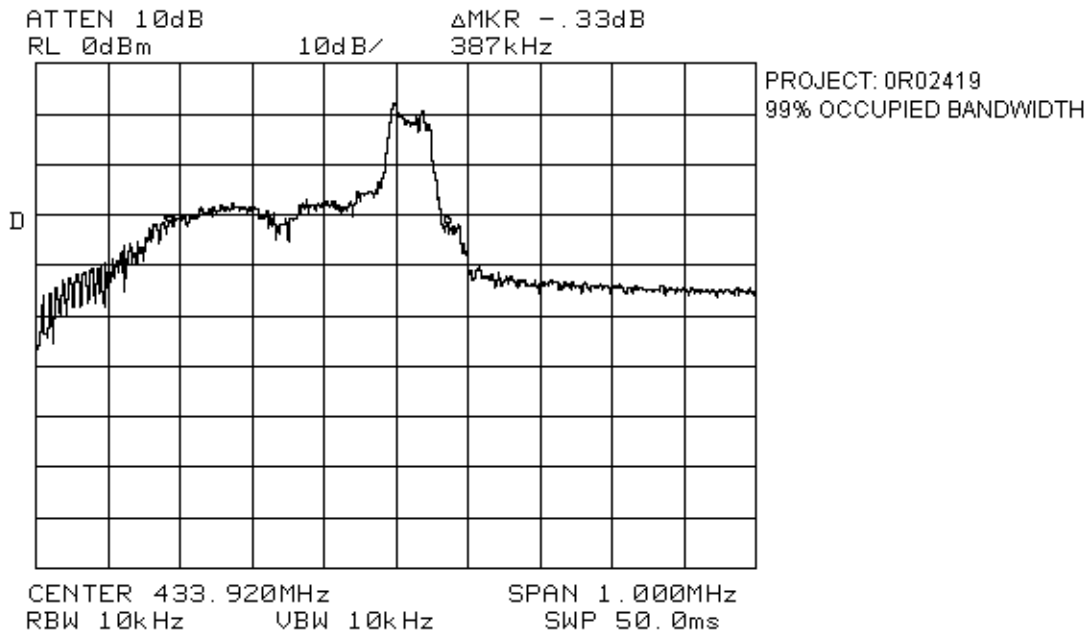

EQUIPMENT: WLS914-433  
FCC ID: F5300NB914

---

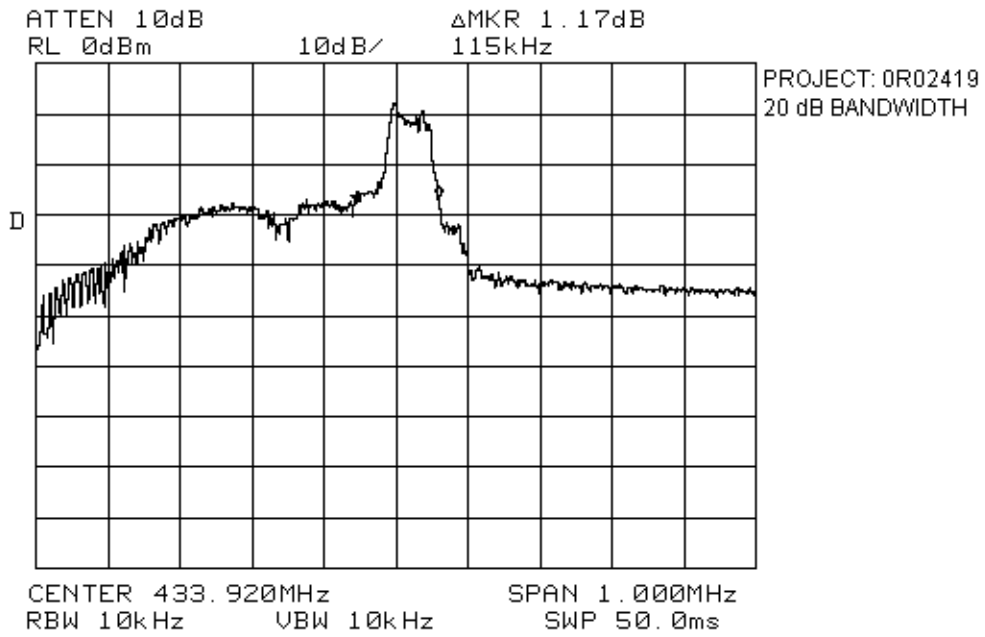

EQUIPMENT: WLS914-433  
FCC ID: F5300NB914

---

## Section 6. Block Diagrams

### Radiated Prescan

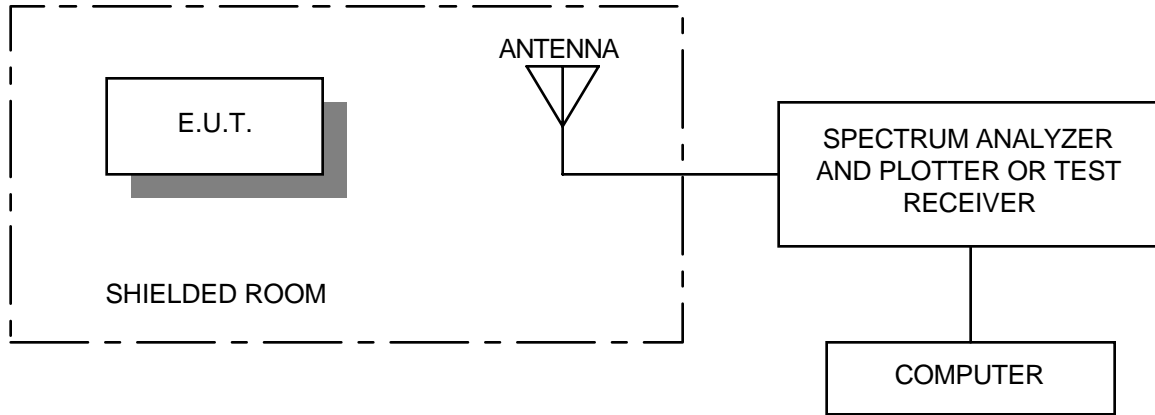

### Outdoor Test Site For Radiated Emissions

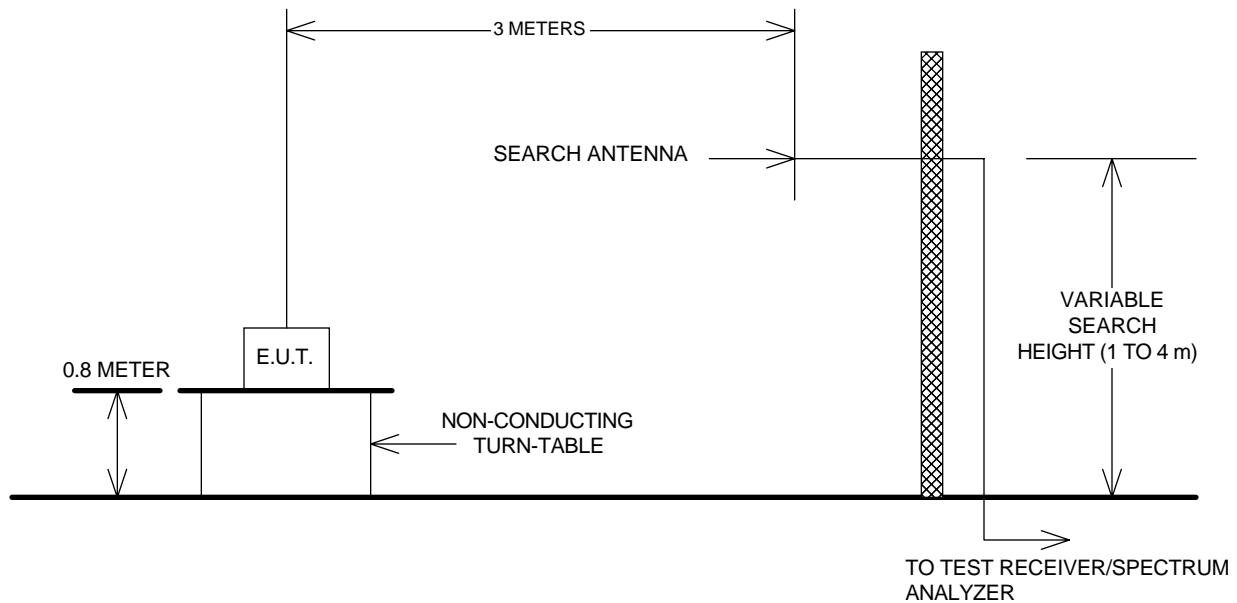

The spectrum was searched up to the 10th harmonic of the fundamental frequency of operation.

*EQUIPMENT: WLS914-433*  
*FCC ID: F5300NB914*

---

**Occupied Bandwidth**

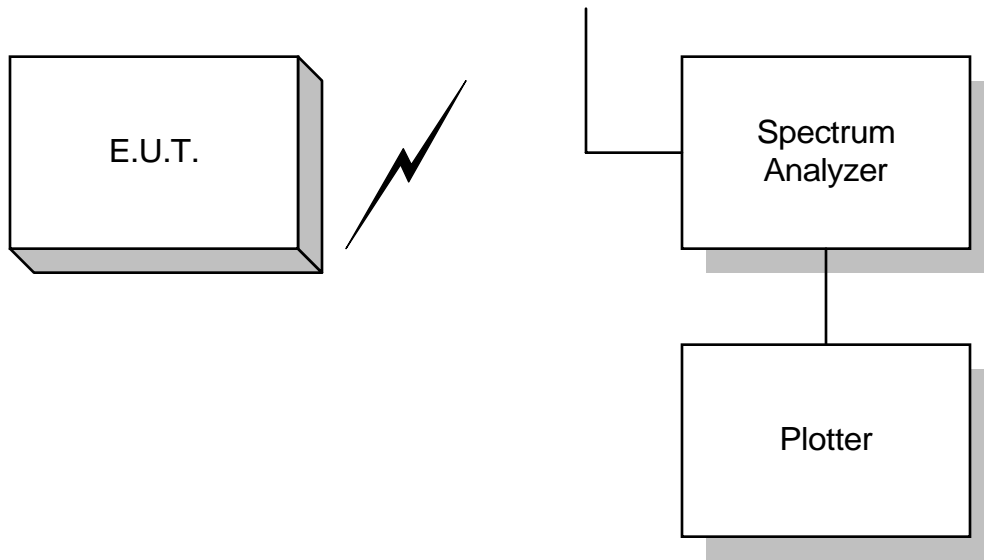

*EQUIPMENT: WLS914-433*  
*FCC ID: F5300NB914*

---

**Section 7. Test Equipment List**

<b>CAL CYCLE</b>	<b>EQUIPMENT</b>	<b>MANUFACTURER</b>	<b>MODEL</b>	<b>SERIAL</b>	<b>LAST CAL.</b>	<b>NEXT CAL.</b>
1 Year	Spectrum Analyzer	Hewlett Packard	8565E	FA000981	June 16/99	June 16/00
1 Year	Receiver	Rohde & Schwarz	ESVP	892661/014	April 5/2000	April 5/2001
1 Year	Horn Antenna	EMCO #2	3115	4336	Nov. 11/99	Nov. 11/00
1 Year	Dipole Antenna Set	EMCO #2	3121C	FA001349	Apr. 5/99	Apr. 5/00
1 Year	Biconical (1) Antenna	EMCO	3109	9204-2708	Aug. 4/99	Aug. 4/00

NA: Not Applicable  
NCR: No Cal Required  
COU: CAL On Use

**KTL Ottawa**

FCC PART 15, SUBPART C  
FOR LOW POWER TRANSMITTERS  
PROJECT NO.: 0R02419  
ANNEX A

*EQUIPMENT: WLS914-433*  
*FCC ID: F5300NB914*

---

## **Annex A**

### **Restricted Bands**

*EQUIPMENT: WLS914-433*  
*FCC ID: F5300NB914*

---

**Section A            Restricted Bands of Operation**

(a) Except as shown in paragraph (d) of this section , only spurious emissions are permitted in any of the frequency bands listed below:

<b>MHz</b>	<b>MHz</b>	<b>MHz</b>	<b>GHz</b>
0.090 - 0.110	16.42-16.423	399.9-410	4.5-5.15
0.49 - 0.51	16.69475-16.69525	608-614	5.35-5.46
2.1735 - 2.1905	16.80425-16.80475	960-1240	7.25-7.75
3.020 - 3.026	25.5-25.67	1300-1427	8.025-8.5
4.125 - 4.128	37.5-38.25	1435-1626.6	9.0-9.2
4.17725 - 4.17775	73-74.6	1645.5-1646.5	9.3-9.5
4.20725 - 4.20775	74.8-75.2	1660-1710	10.6-12.7
6.215 - 6.218	108-121.94	1718.8-1722.2	13.25-13.4
6.31175 - 6.31225	123-138	2220-2300	14.47-14.5
8.291 - 8.294	149.9-150.05	2310-2390	15.35-16.2
8.362 - 8.366	156.52475-156.52525	2483.5-2500	17.7-21.4
8.37625 - 8.38675	156.7-156.9	2655-2900	22.01-23.12
8.41425 - 8.41475	162.0125-167.17	3260-3267	23.6-24.0
12.29 - 12.293	167.72-173.2	3332-3339	31.2-31.8
12.51975 - 12.52025	240-285	3345.8-3358	36.43-36.5
12.57675 - 12.57725	322-335.4	3600-4400	Above 38.6
13.36 - 13.41			