

KTL Test Report: 9R02127

Applicant: Digital Security Controls Ltd.
3301 Langstaff Road
Concord, Ontario
L4K 4L2

**Equipment Under Test:
(E.U.T.)** WLS904NB433 Wireless Motion Detector

FCC ID: F5300NB904

In Accordance With: **FCC Part 15, Subpart C**
For Low Power Transmitters Operating Periodically
In The Band 40.66 - 40.77 MHz And Above 70 MHz

Tested By: KTL Ottawa Inc.
3325 River Road, R.R. 5
Ottawa, Ontario K1V 1H2

Authorized By:

K. Carr, Technologist

Date:

Total Number of Pages: 23

EQUIPMENT: WLS904NB433 Wireless Motion Detector
FCC ID: F5300NB904

Table of Contents

Section 1. Summary of Test Results..... 3

Section 2. Equipment Under Test (E.U.T.)..... 5

Section 3. Transmission Requirements 11

Section 4. Radiated Emissions 14

Section 5. Occupied Bandwidth..... 17

Section 6. Block Diagrams..... 19

Section 7. Test Equipment List..... 21

Annex A Restricted Bands.....A1

EQUIPMENT: WLS904NB433 Wireless Motion Detector
FCC ID: F5300NB904

Section 1. Summary of Test Results

Manufacturer: Digital Security Controls Ltd.

Model No.: WLS904NB433

Serial No.: None

Date Received In Laboratory: February 24, 2000

KTL Identification No.: Item #1

General: **All measurements are traceable to national standards.**

These tests were conducted on a sample of the equipment for the purpose of demonstrating compliance with Part 15, Subpart C, Paragraph 15.231. All tests were conducted using measurement procedure ANSI C63.4-1992. Radiated emissions are made on an open area test site. A description of the test facility is on file with the FCC.

New Submission

Production Unit

Class II Permissive Change

Pre-Production Unit

D	S	C
---	---	---

Equipment Code

THIS TEST REPORT RELATES ONLY TO THE ITEM(S) TESTED.

THE FOLLOWING DEVIATIONS FROM, ADDITIONS TO, OR EXCLUSIONS FROM THE TEST SPECIFICATIONS HAVE BEEN MADE.

See " Summary of Test Data".



NVLAP LAB CODE: 100351-0

TESTED BY: _____ DATE: _____
Russell Grant, Wireless Group Manager

TESTED BY: Glen Westwell DATE: April 14, 2000
Technologist

KTL Ottawa Inc. authorizes the above named company to reproduce this report provided it is reproduced in its entirety and for use by the company's employees only.

Any use which a third party makes of this report, or any reliance on or decisions to be made based on it, are the responsibility of such third parties. KTL Ottawa Inc. accepts no responsibility for damages, if any, suffered by any third party as a result of decisions made or actions based on this report. This report applies only to the items tested.

EQUIPMENT: WLS904NB433 Wireless Motion Detector
FCC ID: F5300NB904

Summary Of Test Data

Name of Test	Paragraph Number	Results
Transmission Requirements	15.231(a)	Complies
Radiated Emissions	15.231(b)	Complies
Occupied Bandwidth	15.231(c)	Complies
Frequency Tolerance	15.231(d)	Not Applicable
Periodic Alternate Field Strength Requirements	15.231(e)	Not Applicable
Powerline Conducted Emissions	15.207	Not Applicable

Footnotes For N/A's: This equipment is battery operated.

Test Conditions:

Indoor Temperature: 20 °C
 Humidity: 20 %

Outdoor Temperature: 10 °C
 Humidity: 20 %

EQUIPMENT: WLS904NB433 Wireless Motion Detector
FCC ID: F5300NB904

Section 2. Equipment Under Test (E.U.T.)

General Equipment Information

Frequency Range:	433.92 MHz
Operating Frequency(ies) of Sample:	433.92 MHz
Type of Emission:	Pulse Width Modulation
Emission Designator:	75K0L1D (See Attached Graph)
Supply Power Requirement:	4 x 1.5 V AAA Batteries
Duty Cycle Calculation:	-16.6 dB (See attached description of duty cycle calculation and time domain graphs)

EQUIPMENT: WLS904NB433 Wireless Motion Detector
 FCC ID: F5300NB904

Data Transmission Format

The transmitted data packet is a fixed length, amplitude modulated packet. The packet contains all of the necessary information to indicate which sensor generated the packet, the type of sensor and the status of the sensor’s inputs. The data is sent at a rate of 500 μ S per bit or 2 Kbits per second.

Figure 1 shows the bit timing used for all bits in the packet. Where a low logic present for the 500 μ S bit time represents a data logic “0” and 250 μ S low then 250 μ S high represents a data logic “1”.

Figure 1: Bit Timing

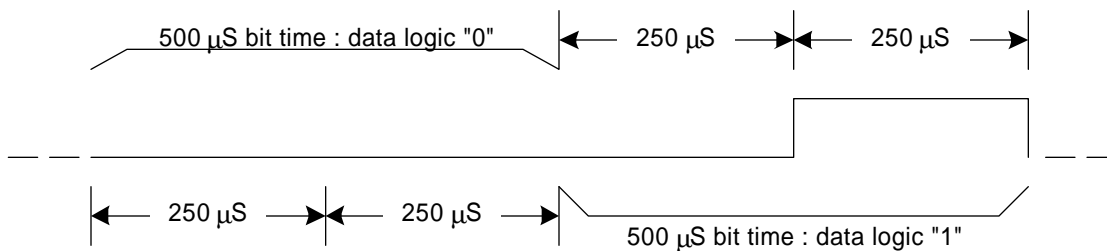
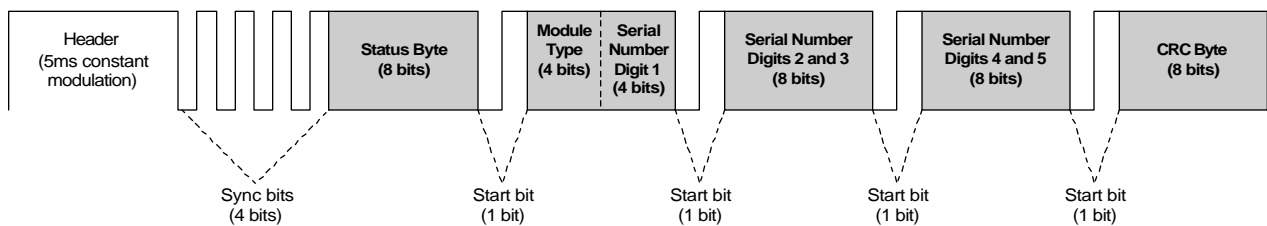

Figure 2 shows the format of the transmitted data packet. Bytes highlighted are bytes that are variable information that would depend on the current status, module type and serial number of the particular device.

Figure 2: Data Packet Format



Because these bytes are variable there is a best and worst case packet when considering ON time.

EQUIPMENT: WLS904NB433 Wireless Motion Detector
FCC ID: F5300NB904

Minimum ON Time

The packet with the minimum on time would be:

5ms header + 1111 + 1000 0000 + 1 + 0010 0000 + 1 + 0000 0001 + 1 + 0000 0001 +1 + 0011 1001

Thus the minimum ON time would be: 5ms + (16 ON bits * 0.25ms per bit)
5ms + 4ms
9ms

Maximum ON Time

The packet with the maximum on time would be:

5ms header + 1111 + 1111 + 1 + 0110 1111 + 1 + 1111 1110 + 1 + 1111 1110 + 1 + 1001 0001

Thus the maximum ON time would be: 5ms + (39 ON bits * 0.25ms per bit)
5ms + 9.75ms
14.75

Duty Cycle

$$20 \text{ Log} \left(\frac{14.75}{100} \right) = -16.6 \text{ dB}$$

EQUIPMENT: WLS904NB433 Wireless Motion Detector
FCC ID: F5300NB904

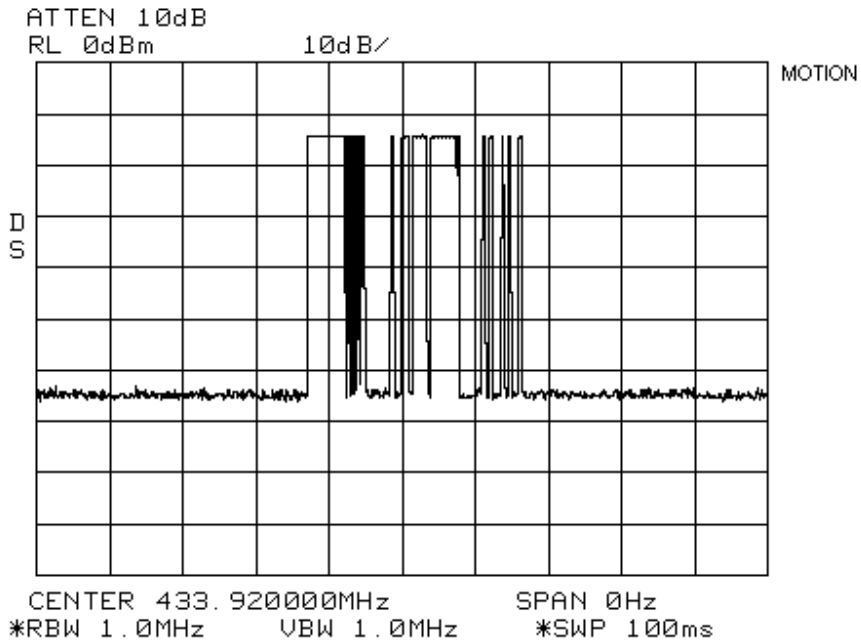

EQUIPMENT: WLS904NB433 Wireless Motion Detector
FCC ID: F5300NB904

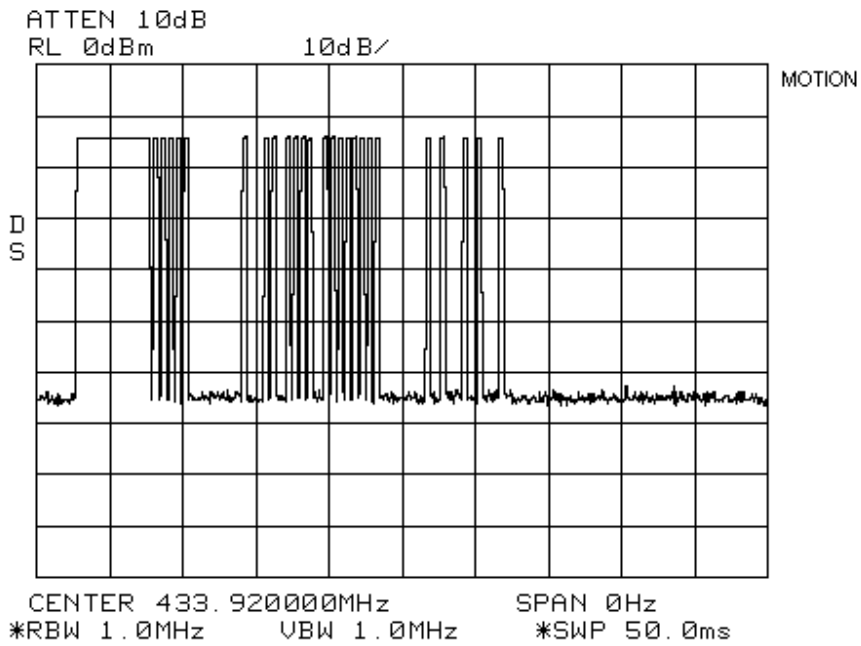

EQUIPMENT: WLS904NB433 Wireless Motion Detector
FCC ID: F5300NB904

Section 3. Transmission Requirements

NAME OF TEST: Transmission Requirements	PARA. NO.: 15.231(a)
TESTED BY: Russell Grant	DATE: January 20, 2000

- Minimum Standard:**
- 15.231(a) Continuous transmissions such as voice, video or data transmissions are not permitted.
 - 15.231(a)(1) A manually operated transmitter shall employ a switch that will automatically deactivate the transmitter within not more than 5 seconds after being released.
 - 15.231(a)(2) A transmitter activated automatically shall cease transmission within 5 seconds of activation.
 - 15.231(a)(3) Periodic transmissions at regular pre-determined intervals are not permitted. However polling or supervisory transmissions to determine system integrity of transmitters used in security or safety applications are allowed if the periodic rate of transmission does not exceed one transmission of not more than one second duration per hour for each transmitter.
 - 15.231(a)(4) Intentional radiators which are employed for radio control purposes during emergencies involving fire, security, and safety of life, when activated to signal an alarm, may operate during the pendency of the alarm.

Test Results: Complies.

Test Data: Compliance was determined by verification of technical specifications and a functional test on the equipment.

EQUIPMENT: WLS904NB433 Wireless Motion Detector
FCC ID: F5300NB904

Rationale for Compliance with Transmission Requirements

- 15.231(a)(1) :** Not applicable. This equipment has no provision for manual activation.
- 15.231(a)(2) :** The maximum transmission duration is 3.3 seconds. See attached graph.
- 15.231(a)(3) :** Not applicable. This equipment does not have any provision for periodic transmissions.
- 15.231(a)(4) :** Not applicable.

EQUIPMENT: WLS904NB433 Wireless Motion Detector
FCC ID: F5300NB904

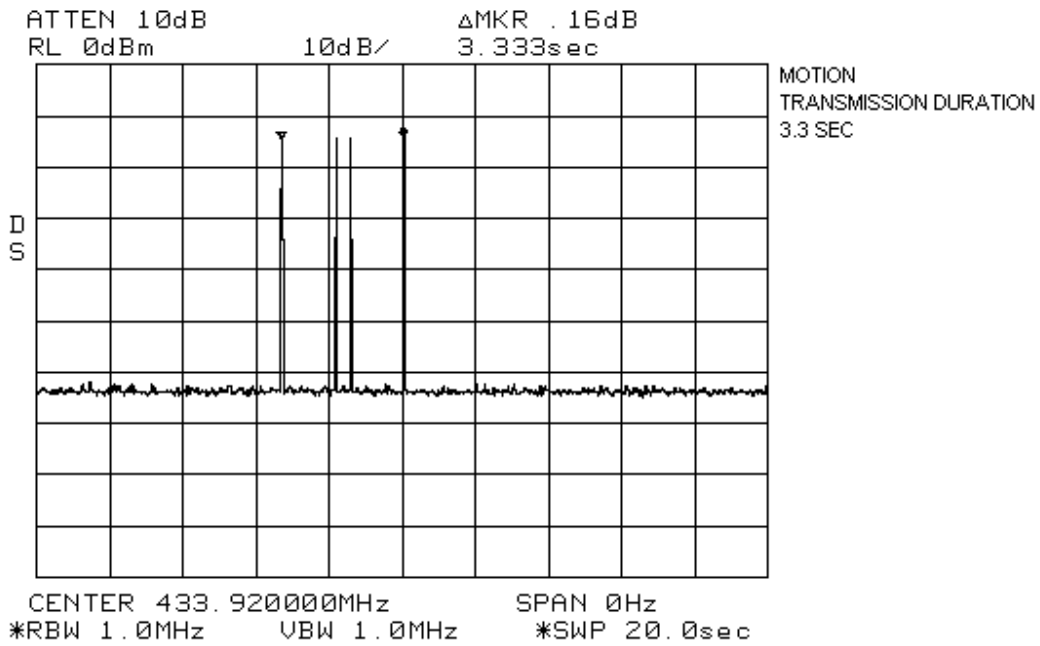

EQUIPMENT: WLS904NB433 Wireless Motion Detector
FCC ID: F5300NB904

Section 4. Radiated Emissions

NAME OF TEST: Radiated Emissions	PARA. NO.: 15.231(b)
TESTED BY: Glen Westwell	DATE: February 24, 2000

Minimum Standard:

Permissible Field Strength Limits (Momentarily Operated Devices)

Fundamental Frequency (MHz)	Field Strength of Fundamental Microvolts/Meter at 3 meters; (watts)	Field Strength of Unwanted Emissions Microvolts/Meter at 3 meters; (watts)
40.66 - 40.70	2,250	225
70-130	1, 250	125
130-174	1,250 to 3,750*	125 to 375
174-260 (note 1)	3,750	375
260-470 (note 1)	3,750 to 12,500*	375 to 1,250
Above 470	12,500	1,250

Notes:

# Use quasi-peak or averaging meter.	For 130 - 174 MHz: $FS \text{ (microvolts/m)} = (56.82 \times F) - 6136$
* Linear interpolation with frequency <i>F</i> in MHz	For 260 - 470 MHz: $FS \text{ (microvolts/m)} = (41.67 \times F) - 7083$

Any emissions that fall within the restricted bands of 15.205 shall not exceed the following limits:

Frequency (MHz)	Field Strength (µV/m @ 3m)	Field Strength (dB @ 3m)
30 - 88	100	40.0
88 - 216	150	43.5
216 - 960	200	46.0
Above 960	500	54.0

Test Results: Complies. The worst-case emission level is 79.7 dBµV/m @ 3m at 433.92 MHz. This is 1.3 dB below the specification limit.

Test Data: See attached table.

Above 1 GHz a spectrum analyzer and low noise amplifier are used to measure emission levels. The spectrum analyzer resolution bandwidth was set to 1 MHz and video bandwidth was 3 MHz.

In the case of handheld equipment, the E.U.T. is rotated in three planes to obtain worst-case results.

EQUIPMENT: WLS904NB433 Wireless Motion Detector
FCC ID: F5300NB904

Test Data - Radiated Emissions

Test Distance (meters) : 3		Range: A Tower		Receiver: ESVP		RBW(kHz): 120		Detector: Q-Peak			
Freq. (MHz)	Ant. *	Pol. (V/H)	Ant. HGT. (m)	Table (deg.)	RCVD Signal (dBµV/m)	Ant. Factor (dB)**	Amp. Gain (dB)***	Dist. Corr. (dB)	Field Strength (dBµV/m)	Limit (dBµV/m)	Margin (dB)
433.90	E/D4	V			70.4	25.9		-16.6	79.7	81.0	1.3
433.90	E/D4	H			56.6	25.9		-16.6	65.9	81.0	15.1
867.87	E/D4	V			15.9	34.4		-16.6	33.7	61.0	27.3
867.87	E/D4	H			15.5	34.4		-16.6	33.3	61.0	27.7
1302.0	Hrn2	V			28.6	29.4		-16.6	41.4	54.0	12.6
1302.0	Hrn2	H			27.0	29.4		-16.6	39.8	54.0	14.2
1736.0	Hrn2	V			50.3	32.1	-46.4	-16.6	19.4	61.0	41.6
1736.0	Hrn2	H			44.2	32.1	-46.4	-16.6	13.3	61.0	47.7
2170.0	Hrn2	V			53.8	34.4	-47.5	-16.6	24.1	61.0	36.9
2170.0	Hrn2	H			60.5	34.4	-47.5	-16.6	30.8	61.0	30.2
2604.0	Hrn2	V			39.5	36.0	-47.8	-16.6	11.1	61.0	49.9
2604.0	Hrn2	H			39.2	36.0	-47.8	-16.6	10.8	61.0	50.2
3038.0	Hrn2	V			49.3	37.6	-47.5	-16.6	22.8	61.0	38.2
3038.0	Hrn2	H			45.3	37.6	-47.5	-16.6	18.8	61.0	42.2
3472.0	Hrn2	V			43.0	40.4	-47.2	-16.6	19.6	61.0	41.4
3472.0	Hrn2	H			40.5	40.4	-47.2	-16.6	17.1	61.0	43.9

Notes:

B/C = Biconical, B/L = Biconilog, L/P = Log-Periodic, H = Horn, D/P = Dipole

* Re-measured using dipole antenna.

** Includes cable loss when amplifier is not used.

*** Includes cable loss.

() Denotes failing emission level.

All harmonics to the 10th were searched.

Non-reported harmonics were not detected.

Noise floor was 20 dB below the limit.

EQUIPMENT: WLS904NB433 Wireless Motion Detector
FCC ID: F5300NB904

Radiated Photographs (Worst Case Configuration)

Front View



Rear View



EQUIPMENT: WLS904NB433 Wireless Motion Detector
FCC ID: F5300NB904

Section 5. Occupied Bandwidth

NAME OF TEST: Occupied Bandwidth	PARA. NO.: 15.231(c)
TESTED BY: Russell Grant	DATE: January 20, 2000

Minimum Standard: 15.231(c) The bandwidth of the emission shall be no wider than 0.25% of the center frequency for devices operating above 70 MHz and below 900 MHz. For devices operating above 900 MHz, the emission shall be no wider than 0.5% of the center frequency. Bandwidth is determined at the points 20 dB down from the modulated carrier.

Test Results: Complies. See attached graph.
The 20 dB bandwidth is 42 kHz.

Test Data: See attached graph.

EQUIPMENT: WLS904NB433 Wireless Motion Detector
FCC ID: F5300NB904

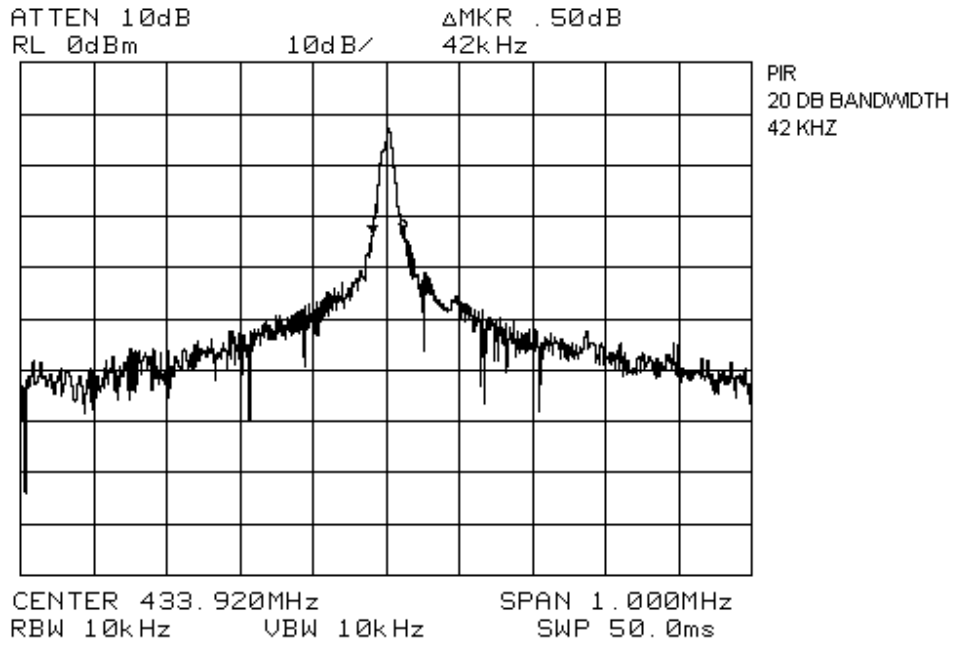

EQUIPMENT: WLS904NB433 Wireless Motion Detector
FCC ID: F5300NB904

Section 6. Block Diagrams

Radiated Prescan

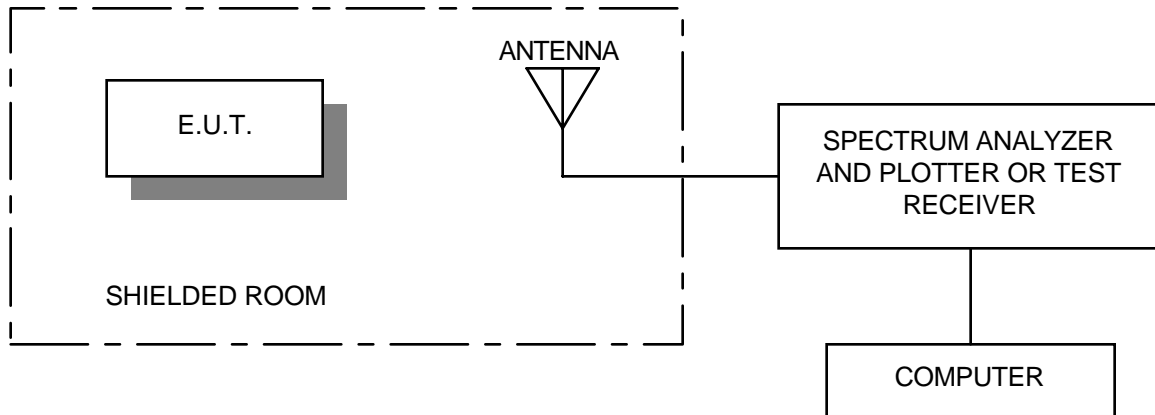

Outdoor Test Site For Radiated Emissions

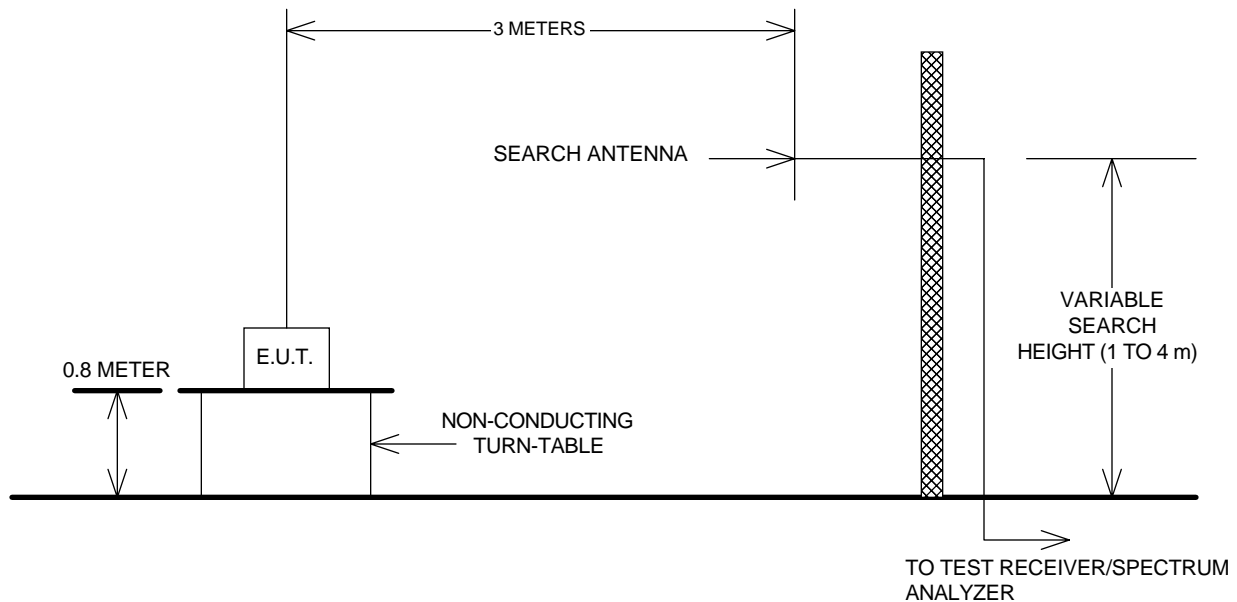

The spectrum was searched up to the 10th harmonic of the fundamental frequency of operation.

EQUIPMENT: WLS904NB433 Wireless Motion Detector
FCC ID: F5300NB904

Occupied Bandwidth

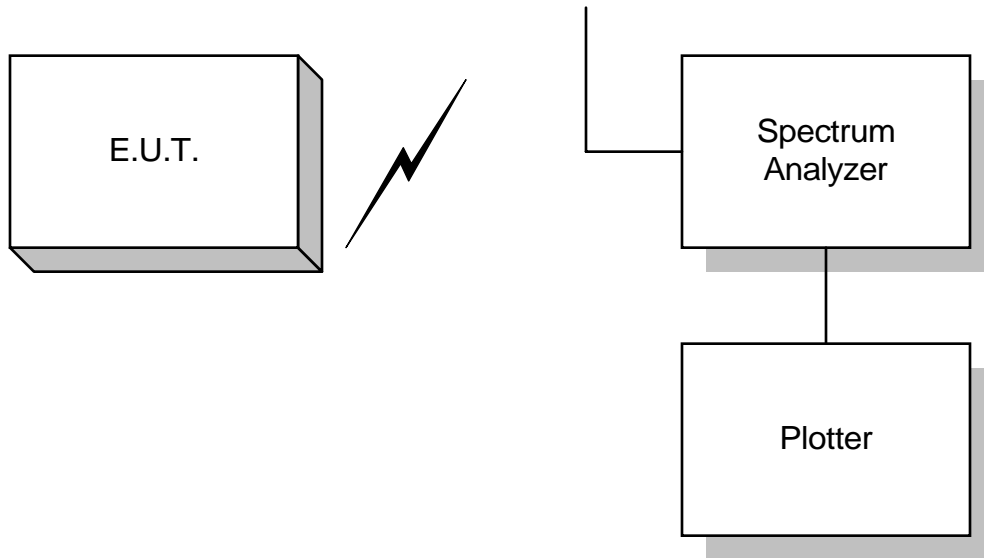

EQUIPMENT: WLS904NB433 Wireless Motion Detector
FCC ID: F5300NB904

Section 7. Test Equipment List

CAL CYCLE	EQUIPMENT	MANUFACTURER	MODEL	SERIAL	LAST CAL.	NEXT CAL.
1 Year	Spectrum Analyzer	Hewlett Packard	8564E	3846A01407	May 31/99	May 31/00
1 Year	Receiver	Rohde & Schwarz	ESVP	892661/014	Mar. 29/99	Mar. 29/00
2 Year	Horn Antenna	EMCO #2	3115	4336	Nov. 11/99	Nov. 11/00
1 Year	RF Amplifier	AVENTEK	AWT-8035	FA001428	Jan. 7/00	Jan. 7/01

NA: Not Applicable
NCR: No Cal Required
COU: CAL On Use

KTL Ottawa

FCC PART 15, SUBPART C
FOR LOW POWER TRANSMITTERS
PROJECT NO.: 9R02127
ANNEX A

EQUIPMENT: WLS904NB433 Wireless Motion Detector
FCC ID: F5300NB904

ANNEX A
RESTRICTED BANDS

EQUIPMENT: WLS904NB433 Wireless Motion Detector
FCC ID: F5300NB904

Section A Restricted Bands of Operation

(a) Except as shown in paragraph (d) of this section , only spurious emissions are permitted in any of the frequency bands listed below:

MHz	MHz	MHz	GHz
0.090 - 0.110	16.42-16.423	399.9-410	4.5-5.15
0.49 - 0.51	16.69475-16.69525	608-614	5.35-5.46
2.1735 - 2.1905	16.80425-16.80475	960-1240	7.25-7.75
3.020 - 3.026	25.5-25.67	1300-1427	8.025-8.5
4.125 - 4.128	37.5-38.25	1435-1626.6	9.0-9.2
4.17725 - 4.17775	73-74.6	1645.5-1646.5	9.3-9.5
4.20725 - 4.20775	74.8-75.2	1660-1710	10.6-12.7
6.215 - 6.218	108-121.94	1718.8-1722.2	13.25-13.4
6.31175 - 6.31225	123-138	2220-2300	14.47-14.5
8.291 - 8.294	149.9-150.05	2310-2390	15.35-16.2
8.362 - 8.366	156.52475-156.52525	2483.5-2500	17.7-21.4
8.37625 - 8.38675	156.7-156.9	2655-2900	22.01-23.12
8.41425 - 8.41475	162.0125-167.17	3260-3267	23.6-24.0
12.29 - 12.293	167.72-173.2	3332-3339	31.2-31.8
12.51975 - 12.52025	240-285	3345.8-3358	36.43-36.5
12.57675 - 12.57725	322-335.4	3600-4400	Above 38.6
13.36 - 13.41			