

Channelized Signal Booster (Model 611-70A)- Internal Photos

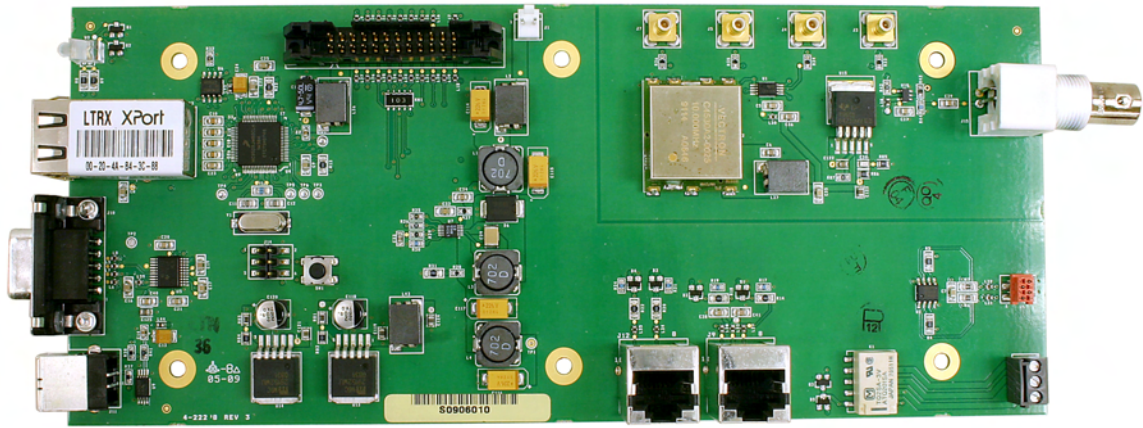

Control Board for Channel Modules 3-22297 top view.

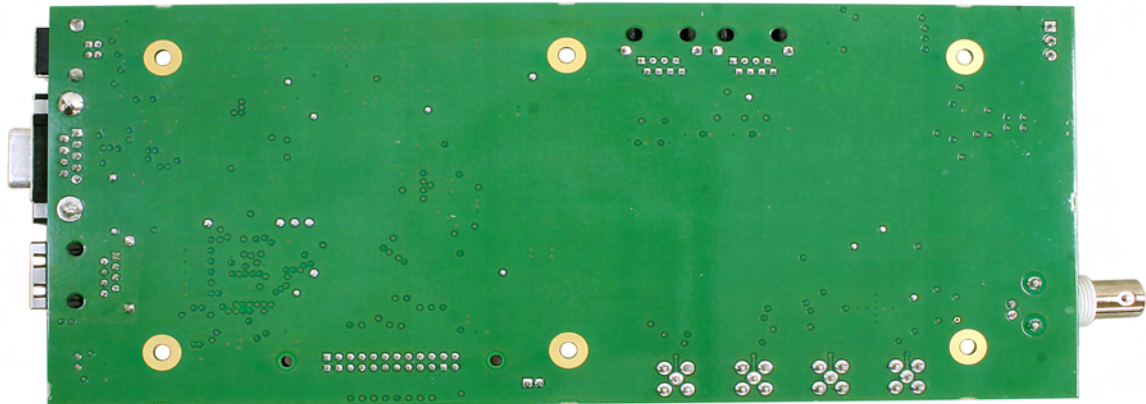

Control Board for Channel Modules 3-22297 bottom view.

Channelized Signal Booster (Model 611-70A) - Internal Photos

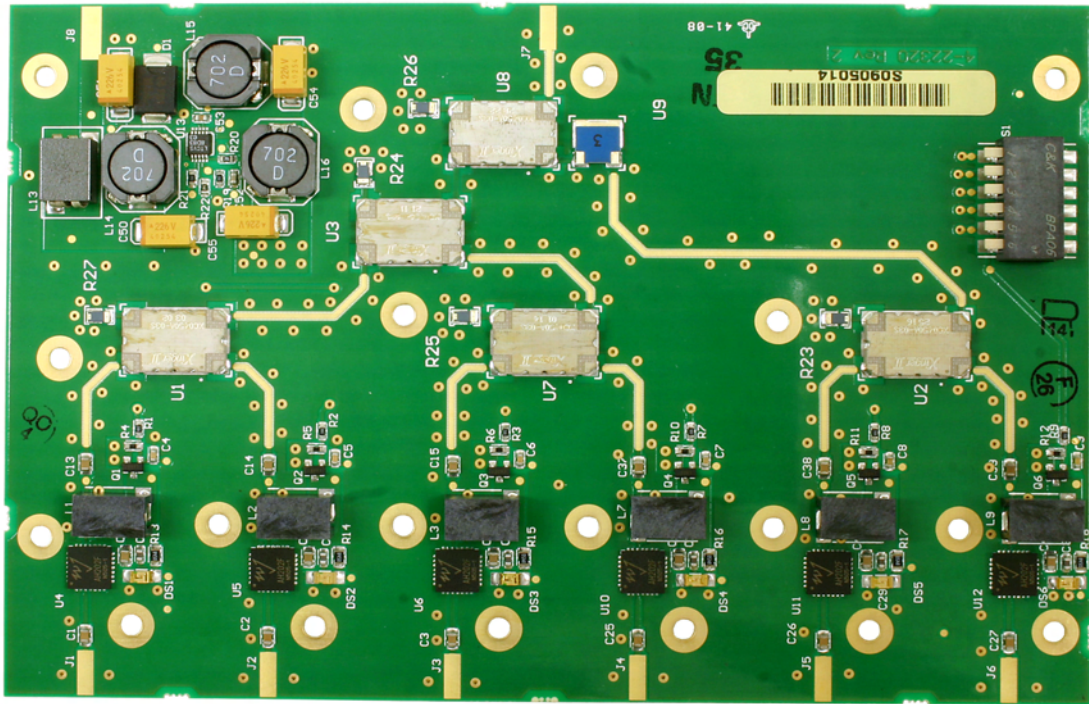

Active Combiner 3-22318 circuit board (3-22319) top view.

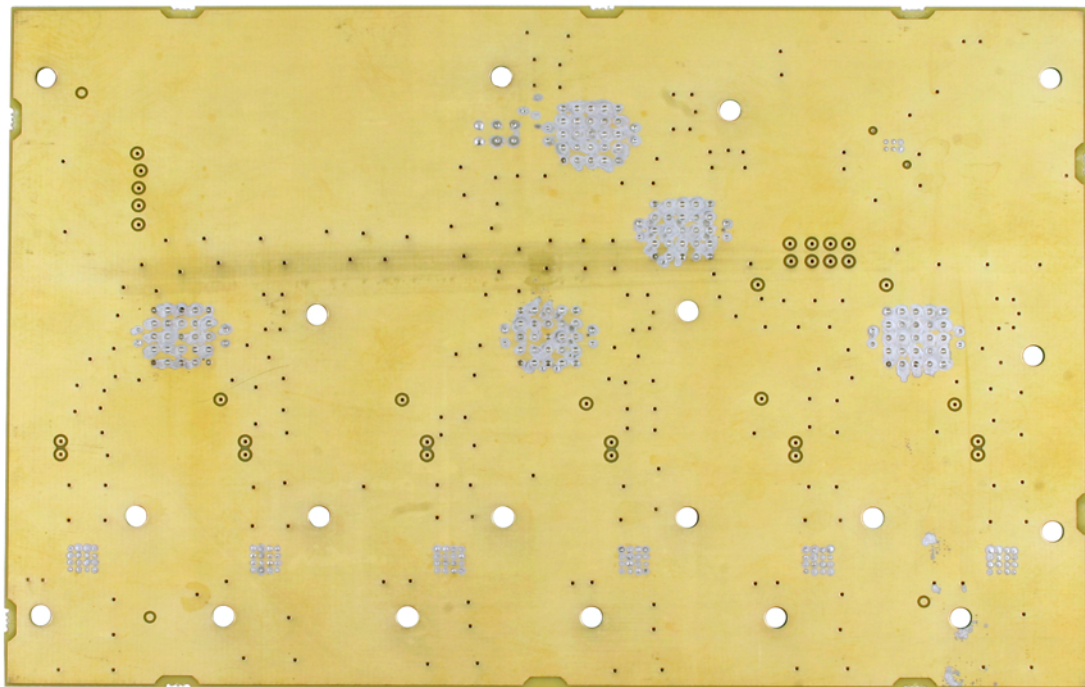

Active Combiner 3-22318 circuit board (3-22319) bottom view.

Channelized Signal Booster (Model 611-70A)- Internal Photos

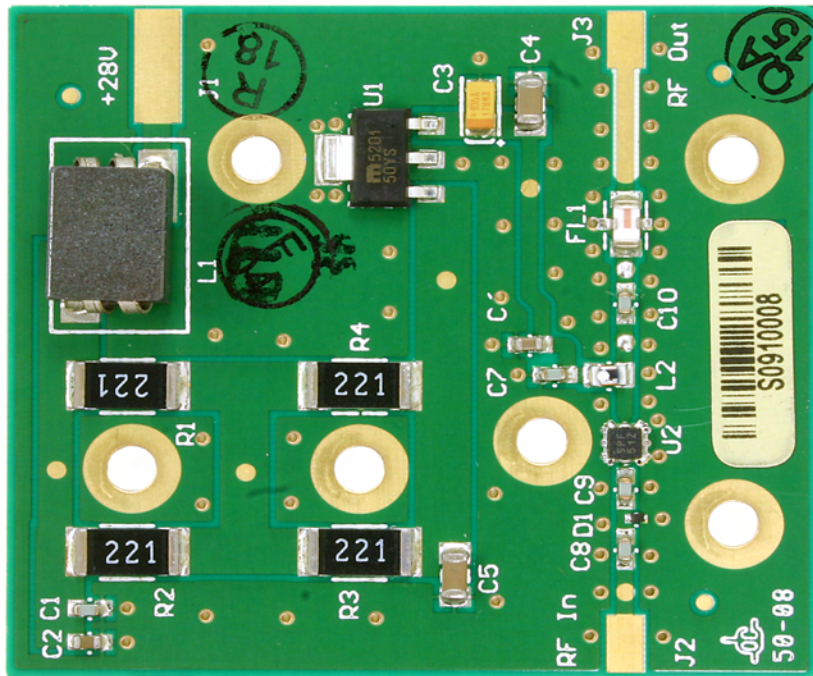

UHF Distribution Amplifier 3-22340 circuit board (3-22341) top view.

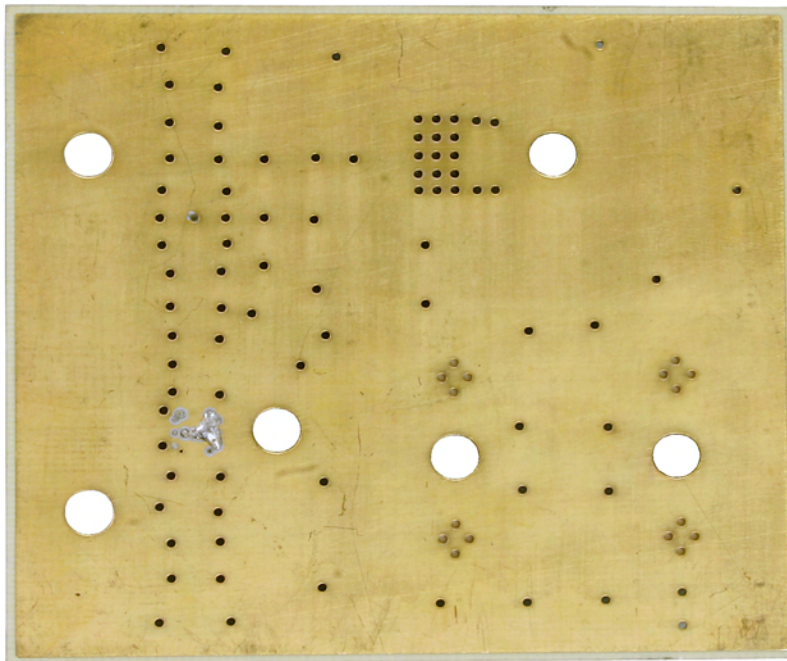

UHF Distribution Amplifier 3-22340 circuit board (3-22341) bottom view.

Channelized Signal Booster (Model 611-70A) - Internal Photos

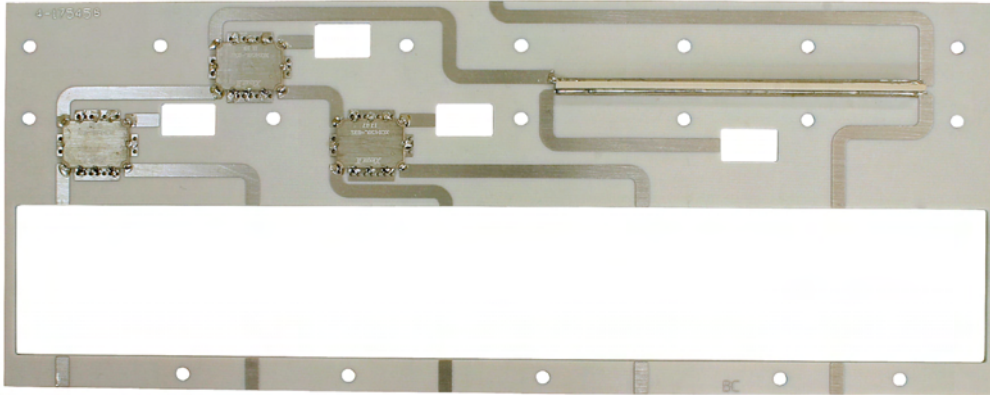

Hybrid Combiner 3-18317-1 Circuit Board top view.

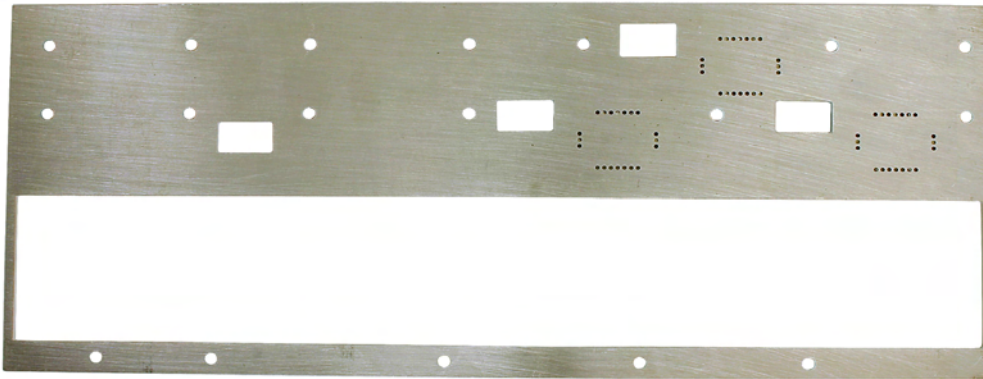

Hybrid Combiner 3-18317-1 Circuit Board bottom view.

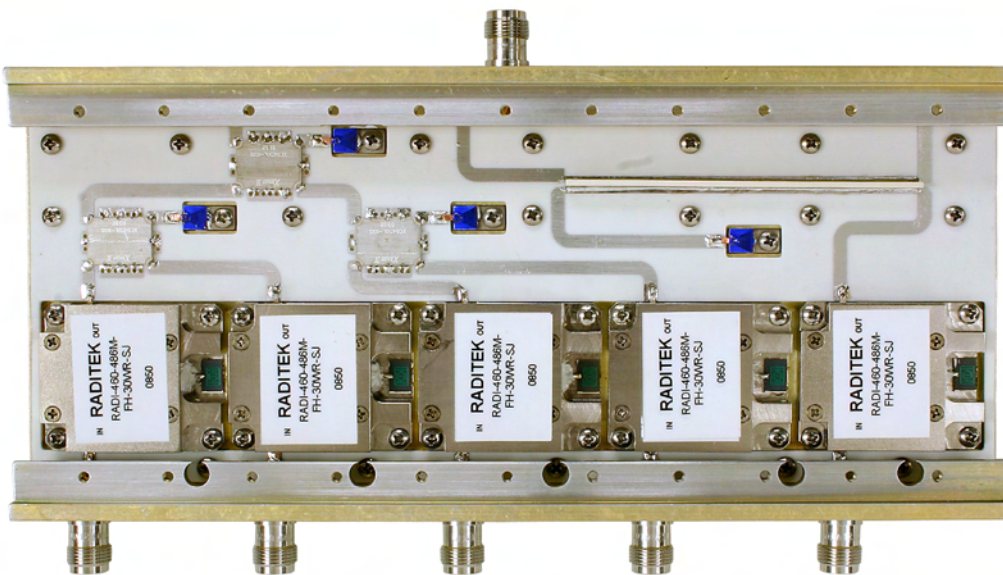

Hybrid Combiner 3-18317-1 with Circuit Board installed in chassis.

Channelized Signal Booster (Model 611-70A)- Internal Photos

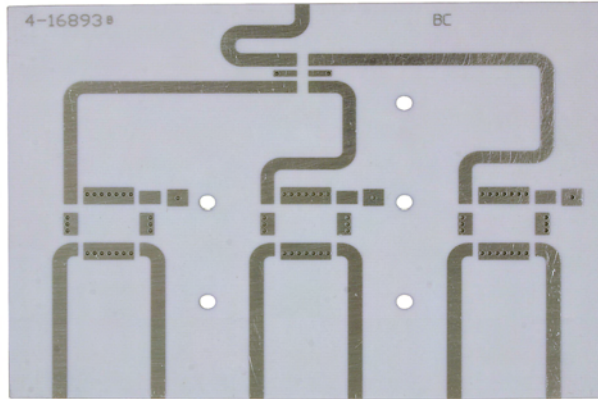

6-Way Power Divider 3-16676 Circuit Board top view.

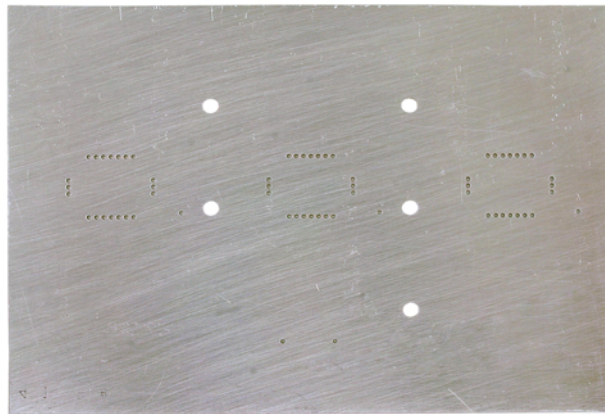

6-Way Power Divider 3-16676 Circuit Board bottom view.

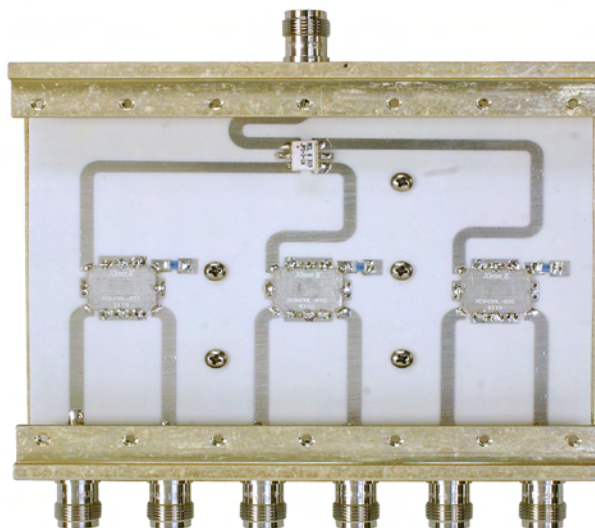

6-Way Power Divider 3-16676 with circuit board installed in chassis.

Channelized Signal Booster (Model 611-70A) - Internal Photos

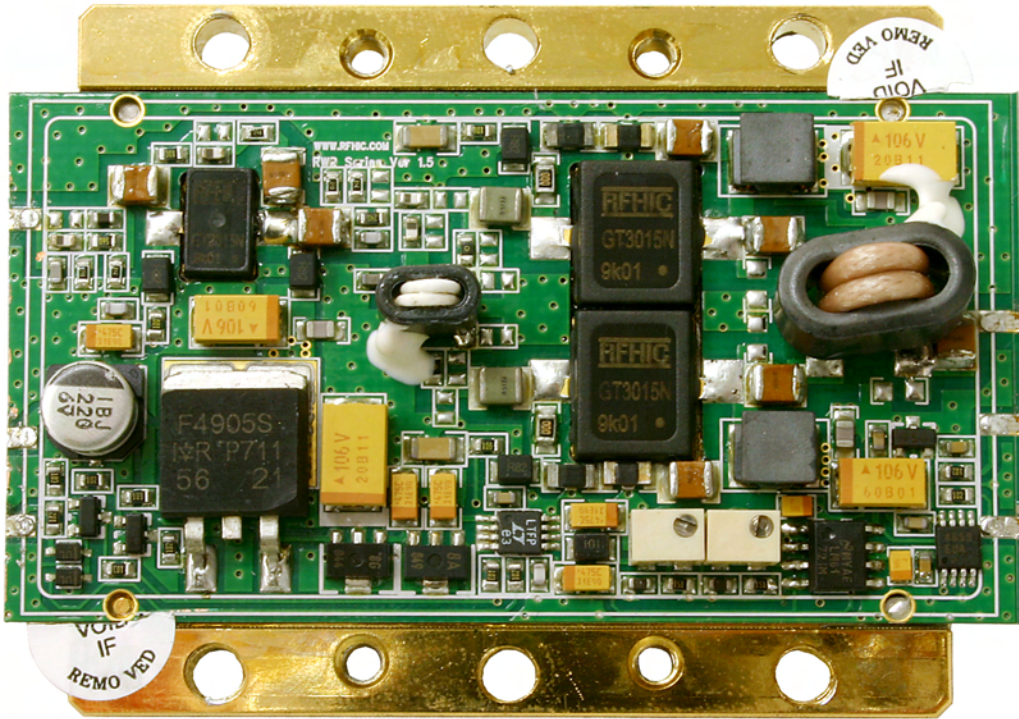

Power Amplifier 8-23291 component side view.

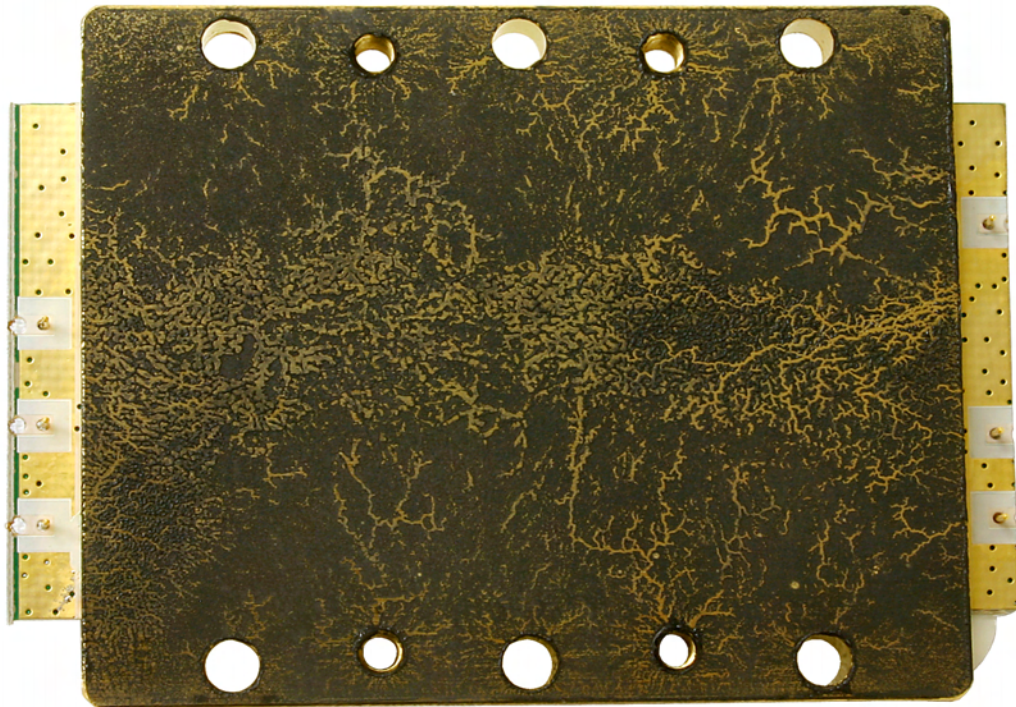

Power Amplifier 8-23291 non-component side view.