

3-5969 Regulator Assembly

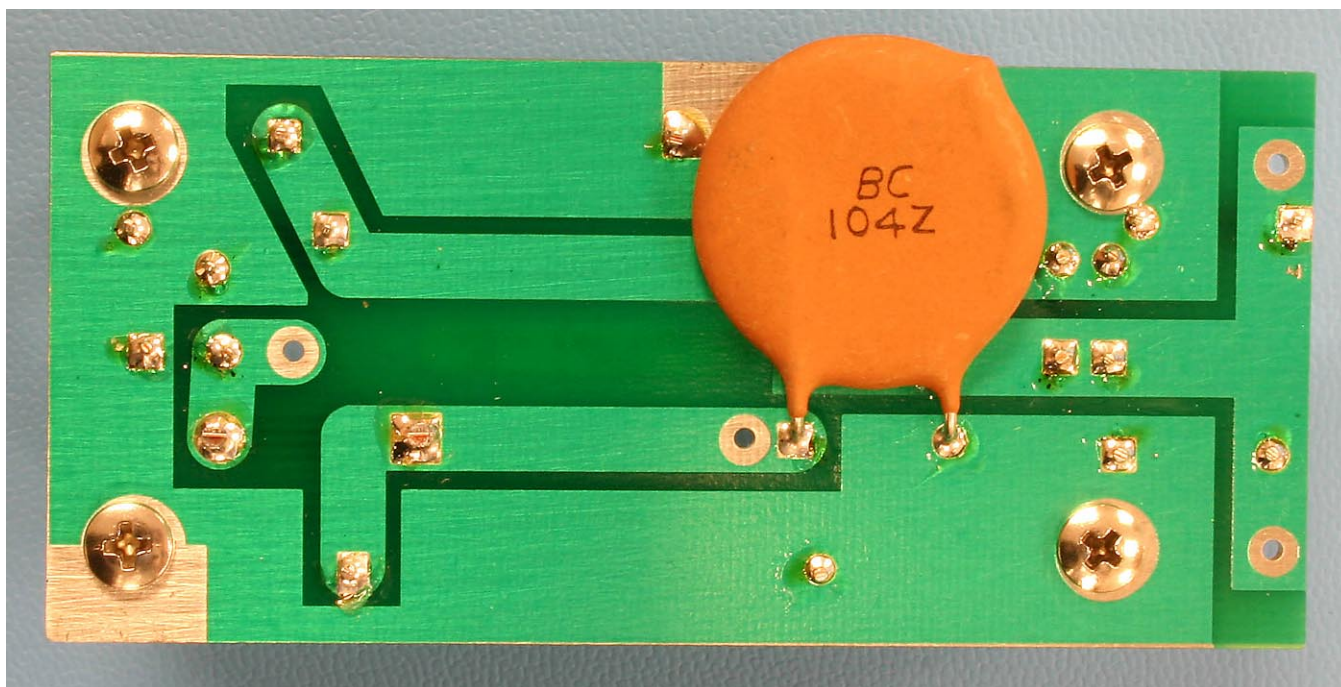

3-1296 Regulator Circuit Board Assembly

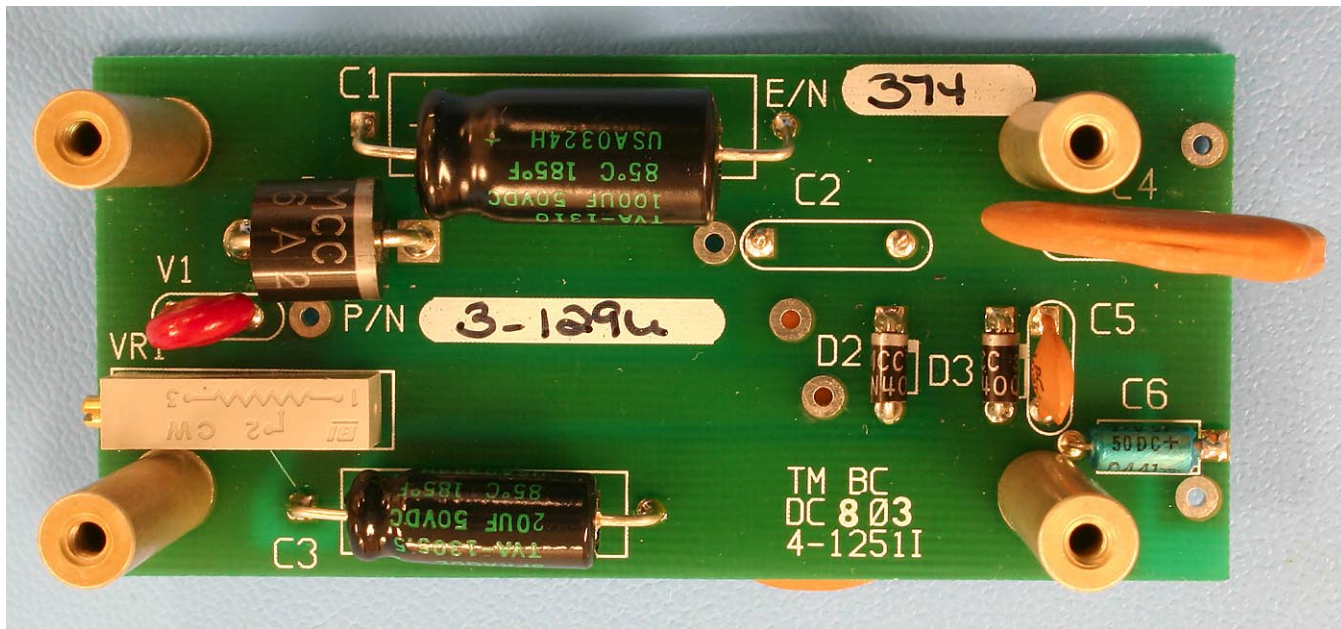

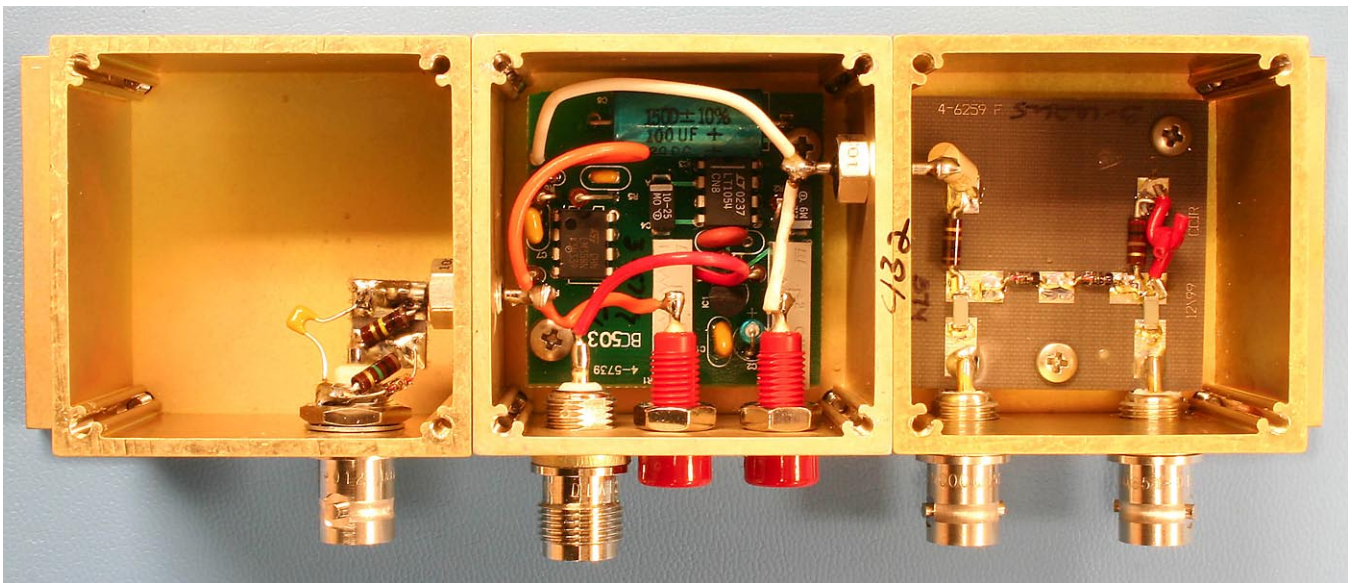

3-6280 Attenuator Assembly

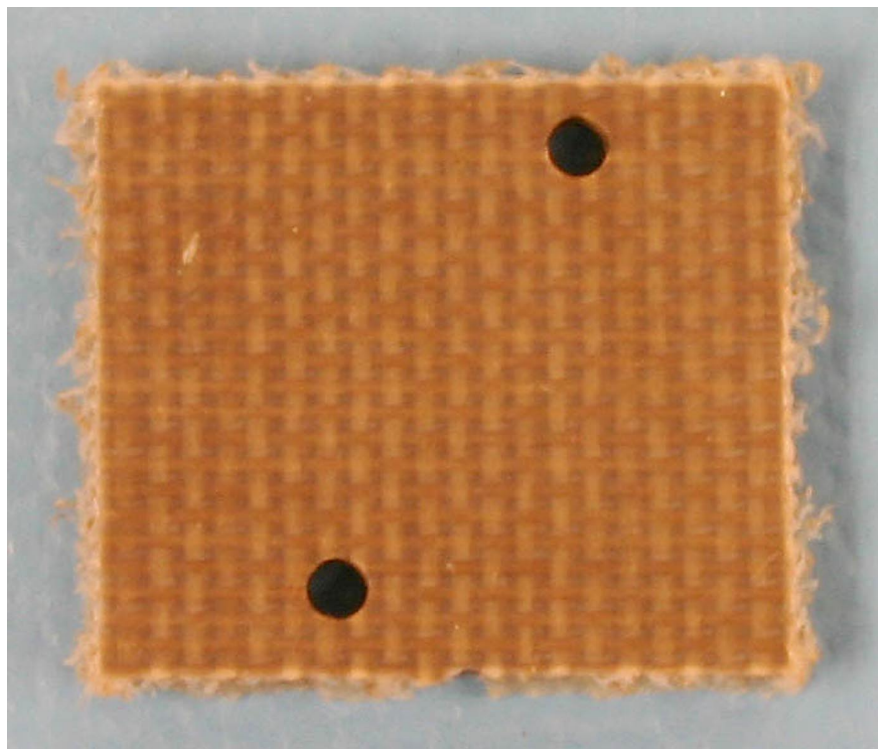
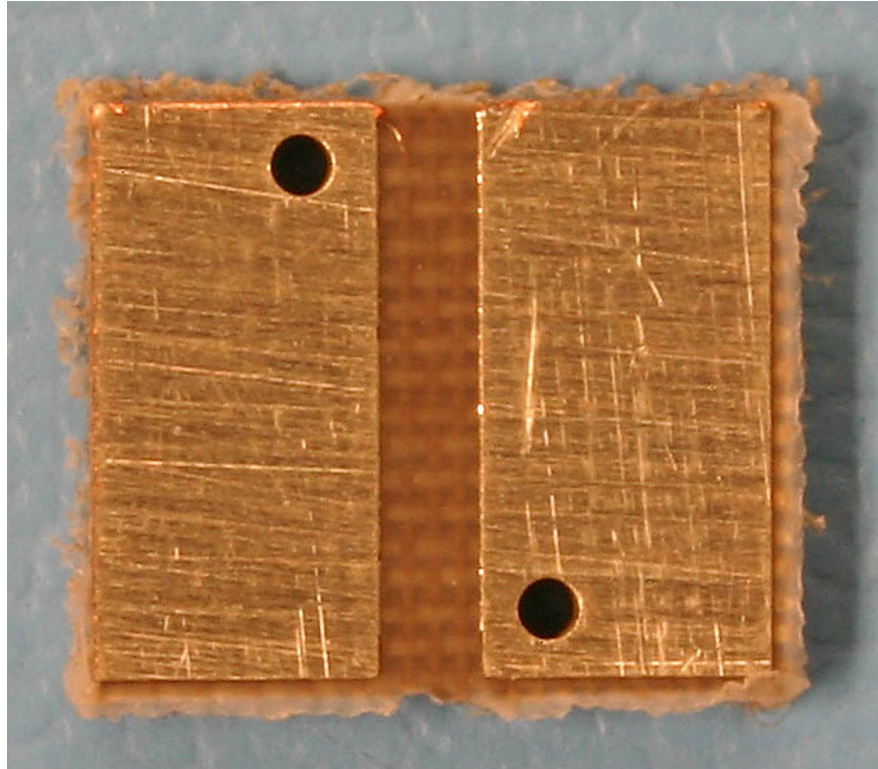

1-5874 PC Board Junction



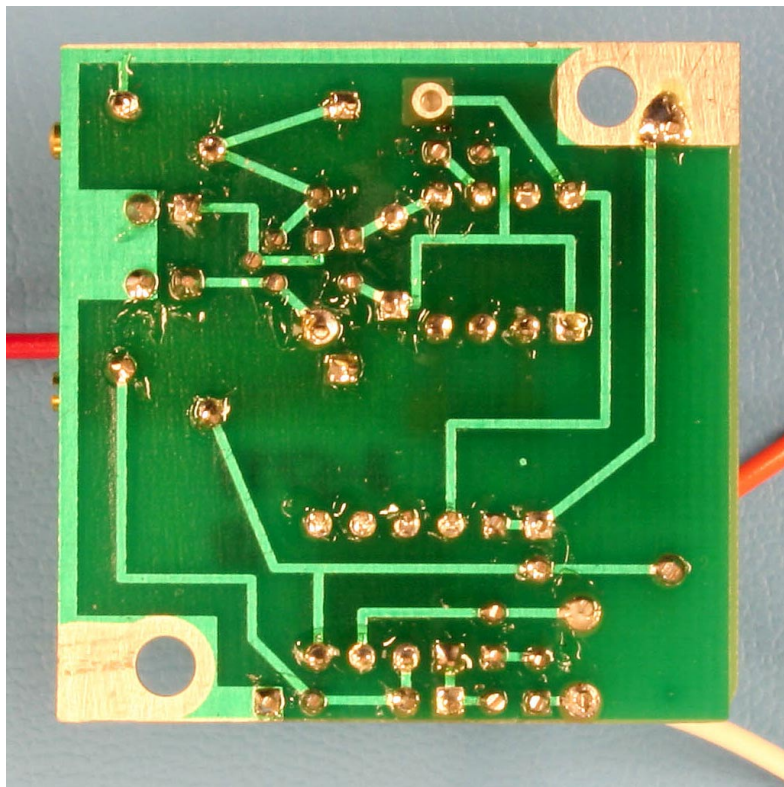
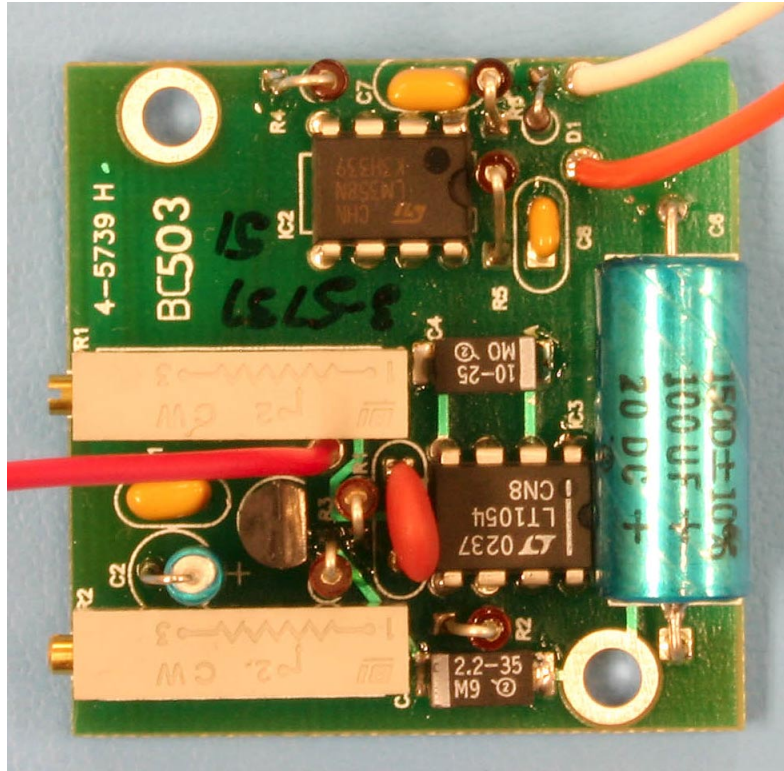

3-5737 Control Board Assembly

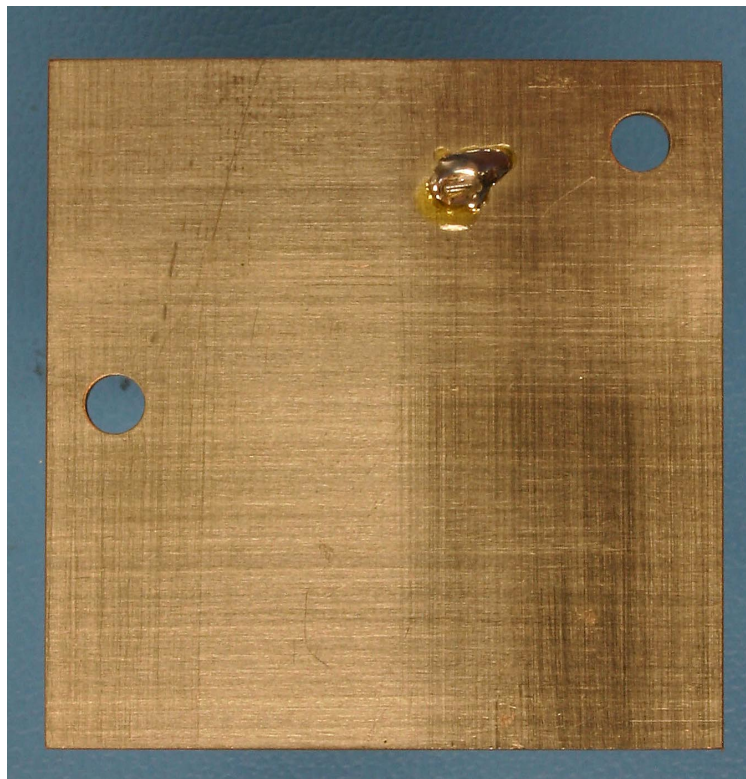
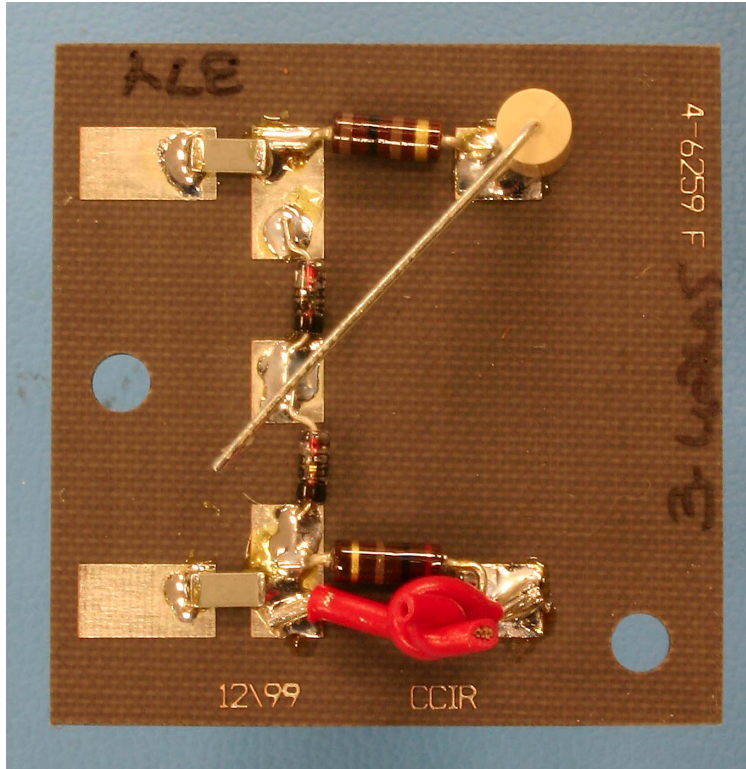

3-6265 Attenuator Circuit Board Assembly