

CFR 47 FCC Part 15.231

TEST REPORT

Product : **Remote Control**

Trade Name : Avital

Model Number : 7352L

FCC ID : EZSDEI7352

Prepared for

DEI Headquarters, Inc

One Viper Way, Vista CA 92081

TEL. : +1 760 599 1331

FAX. : +1 760 598 6400

Prepared by

Interocean EMC Technology Corp.

No. 5-2, Lin 1, Tin-Fu, Lin-Kou Dist., New Taipei City,

Taiwan 244, R.O.C.

TEL.: +886 2 2600 6861

FAX.: +886 2 2600 6859

Remark:

The test report consists of **27** pages in total. It shall not be reproduced except in full, without the written approval of IETC. This document may be altered or revised by IETC only, and shall be noted in the revision section of the document.

The test results in the report only to the tested sample.

Statement of Compliance

Applicant: DEI Headquarters, Inc

Manufacturer: Nutek Corporation

Product: Remote Control

Model No.: 7352L

Tested Power Supply: 1.5Vdc Battery

Date of Final Test: Jul. 25, 2011

Revision of Report: Rev. 00

Configuration of Measurements and Standards Used :

FCC Rules and Regulations Part 15 Subpart C

1. The result of the testing report relate only to the item tested.
2. The testing report shall not be reproduced expect in full, without the written approval of IETC.

Report Issued: 2011/08/05

Project Engineer: 

Elli Chang

Approved: 

Jerry Liu

Table of Contents

1	Summary of Measurement	4
2	General Information	5
2.1	Description of Equipment Under Test	5
2.2	Details of tested peripheral equipment	6
2.3	Test Facility	7
3	Test specifications	8
3.1	Test standard	8
3.2	Operation mode	8
3.3	Test Equipment	9
4	Radiated emission test	10
4.1	Limits	10
4.2	Calculation of Average Factor	11
4.3	Configuration of Measurement	16
4.4	Test Procedure	16
4.5	Test Result	16
5	Emission bandwidth	19
5.1	Limits	19
5.2	Test Result	19
6	Photographs of Test	21
6.1	Radiated Emission Measurement	21
7	Photographs of EUT	23

1 Summary of Measurement

Report Clause	Test Parameter	Reference Document CFR47 Part15	Results
4	Radiated Emission	§15.231(b), 15.209	Pass
5	Emission bandwidth	§15.231(c)	Pass

2 General Information

2.1 Description of Equipment Under Test

- Product** : Remote Control
- Model Number** : 7352L
- Applicant** : **DEI Headquarters, Inc**
One Viper Way, Vista CA 92081
- Manufacturer** : **Nutek Corporation**
NO. 167, Lane 235, Bauchiau Rd., Shindian City, Taipei County
23145, Taiwan
- Power Supply** : 1.5Vdc Battery
- Operating Frequency** : 433.92MHz
- Channel Number** : 1 channel
- Type of Modulation** : ASK
- Antenna description** : This device uses Spring antenna.
The antenna is integral to the device, thereby meeting the
requirement of FCC 15.203.
- Date of Test** : Jul. 20 ~ 25, 2011
- Additional Description** : 1) The Model Number "**7352L**" is representative selected in the
test and included in this report.
2) For more detail specification about EUT, please refer to the
user's manual.

2.2 Details of tested peripheral equipment

N/A

2.3 Test Facility

- Site Description** : ☑OATS 2
- Name of Firm** : Interocean EMC Technology Corp.
- Company web** : <http://www.ietc.com.tw>
- Site 1, 2, 3 Location** : No. 5-2, Lin 1, Tin-Fu, Lin-Kou Dist., New Taipei City, Taiwan 244, R.O.C.
- Site Filing** :
- Federal Communication Commissions – USA
Registration No.: 96399 (OATS 1 & 2)
Registration No.: 518958 (OATS 3)
Designation No.: TW1020
 - Voluntary Control Council for Interference by Information Technology Equipment (VCCI) – Japan
Member No.: 1349
Registration No. (Conducted Room): C-1094
Registration No. (Conducted Room): T-1562
Registration No. (OATS 1): R-1040; G-274
Registration No. (OATS 2): R-1041
 - Industry Canada (IC)
OUR FILE: 46405-4437 Submission: 145171
Registration No. (OATS 1): Site# 4437A-1
Registration No. (OATS 2): Site# 4437A-2
Registration No. (OATS 3): Site# 4437A-3
- Site Accreditation** :
- Bureau of Standards and Metrology and Inspection (BSMI) – Taiwan, R.O.C.
Accreditation No.:
SL2-IN-E-0026 for CNS13438 / CISPR22
SL2-R1-E-0026 for CNS13439 / CISPR13
SL2-R2-E-0026 for CNS13439 / CISPR13
SL2-A1-E-0026 for CNS13783-1 / CISPR14-1
SL2-L1-E-0026 for CNS 14115 / CISPR 15
 - Taiwan Accreditation Foundation (TAF)
Accrditation No.: 1113
 - TÜV NORD
Certificate No: TNTW0801R-03

3 Test specifications

3.1 Test standard

The EUT was performed according to FCC Part 15 Subpart C Section 15.231 procedure and setup followed by ANSI C63.4, 2003 requirements.

3.2 Operation mode

By preliminary testing and verifying three axis (X, Y and Z) position of EUT transmitted status, it was found that "X axis" position was the worst, then the final test was executed the worst condition and test data were recorded in this report

The EUT was operated in continuous transmission mode during all of the tests.



X axis mode



Y axis mode



Z axis mode

3.3 Test Equipment

Instrument	Manufacturer	Model	Serial No.	Next Cal. Date
Spectrum Analyzer	R&S	FSP30	100002	2012/01/02
Preamplifier	Agilent	8449B	3008A01434	2012/04/28
Horn Antenna	Schwarzbeck	BBHA 9120	9120D-583	2013/05/01
Horn Antenna	COM-POWER	AH-118	10081	2012/05/19
Cable	HARBOUR	27478LL142	CBL22	2011/09/28
Cable	HARBOUR	27478LL142	CBL23	2011/09/28
EMI Test Receiver	R&S	ESCS30	100127	2011/09/08
Biconical Antenna	Schwarzbeck	VHA 9103	2484	2011/10/08
Log Antenna	Schwarzbeck	UHALP 9108	A 0765	2011/10/08
Pre-Amplifier	SCHAFFNER	CPA9231A	3349	2011/08/03
RF Cable	IETC	8DFB	CBL14	2012/07/13

Note: The above equipments are within the valid calibration period.

4 Radiated emission test

4.1 Limits

According to FCC 15.231(b) requirement:

In addition to the provisions of §15.205, the field strength of emissions from intentional radiator operated under this section shall not exceed the following:

Fundamental and harmonics emission limits

Frequency (MHz)	Field Strength of Fundamental		Field Strength of Harmonics	
	(μ V/m@3m)	(dB μ V/m@3m)	(μ V/m@3m)	(dB μ V/m@3m)
433.92	10996	80.8	1099.6	60.8

General Radiated emission Limit

Spurious Emission tested through until 10th harmonic. Radiated emissions, which fall in the restricted bands, as defined in §15.205 (a), comply with the radiated emission limits specified in §15.209 (a).

Frequency (MHz)	15.209 Limits	
	(μ V/m@3m)	(dB μ V/m@3m)
30-88	100	40
88-216	150	43.5
216-960	200	46
Above 960	500	54

Remark :

1. The table above tighter limit applies at the band edges.
2. The measurement distance in meters, which that between form closest point of EUT to instrument antenna.

4.2 Calculation of Average Factor

The output field strengths of specification in accordance with the FCC rules specify measurements with an average detector. During the test, a spectrum analyzer incorporating a peak detector was used. Therefore, a reduction factor can be applied to the resultant peak signal level and compared to the limit for measurement instrumentation incorporating an average detector.

The duty cycle is measured in 100 ms or the repetition cycle period, whichever is a shorter time frame. The duty cycle is measured by placing the spectrum analyzer to set zero span at 100kHz resolution bandwidth.

Averaging factor in dB = $20 \log (\text{duty cycle})$

The duration of one cycle = 111.201ms

The duty cycle is simply the on-time divided by 100ms

Duty Cycle = $(0.78\text{ms} \times 43 + 0.38\text{ms} \times 34) = 46.46 \text{ ms} / 100\text{ms}$

Therefore, the averaging factor is found by $20 \log 0.4646 = -6.66\text{dB}$

Please see the diagrams below.

Duty Cycle

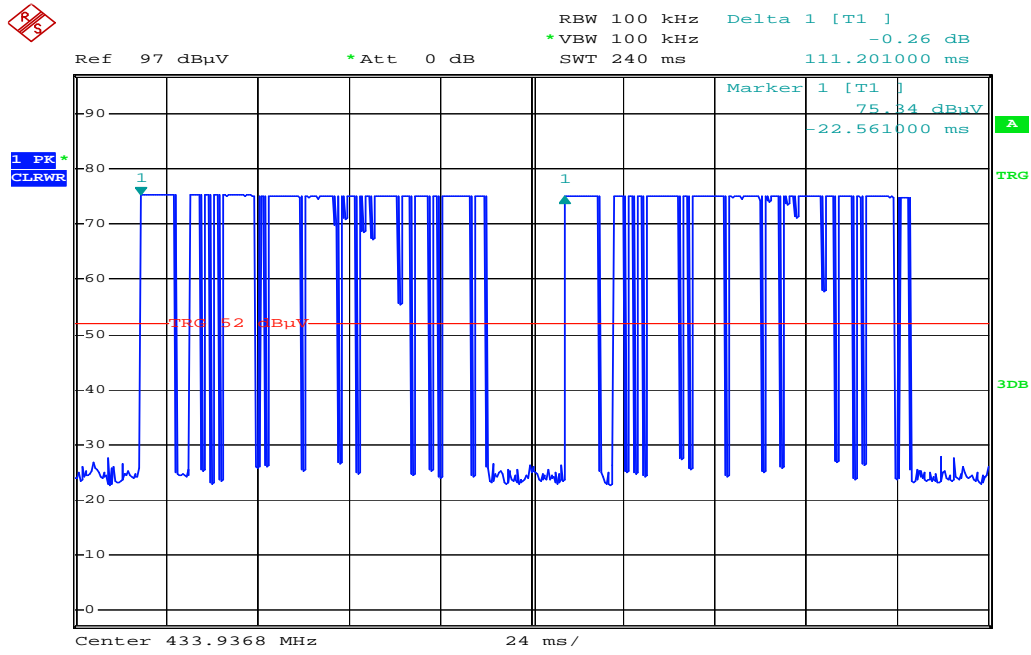

Date: 20.JUL.2011 16:27:24

Time Slot

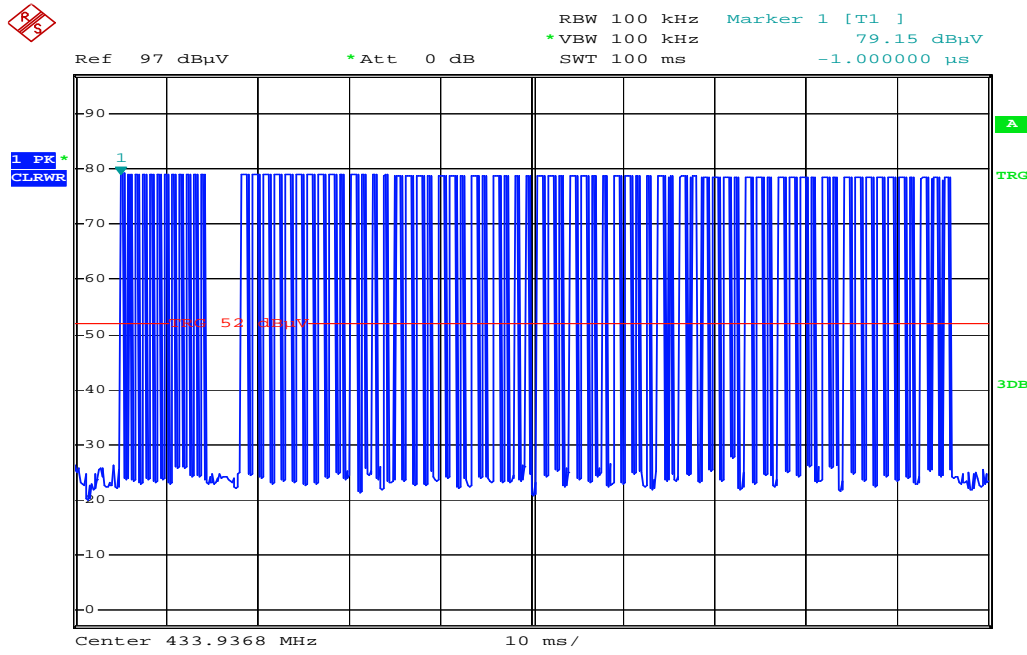

Date: 20.JUL.2011 16:21:12

Time Slot 1

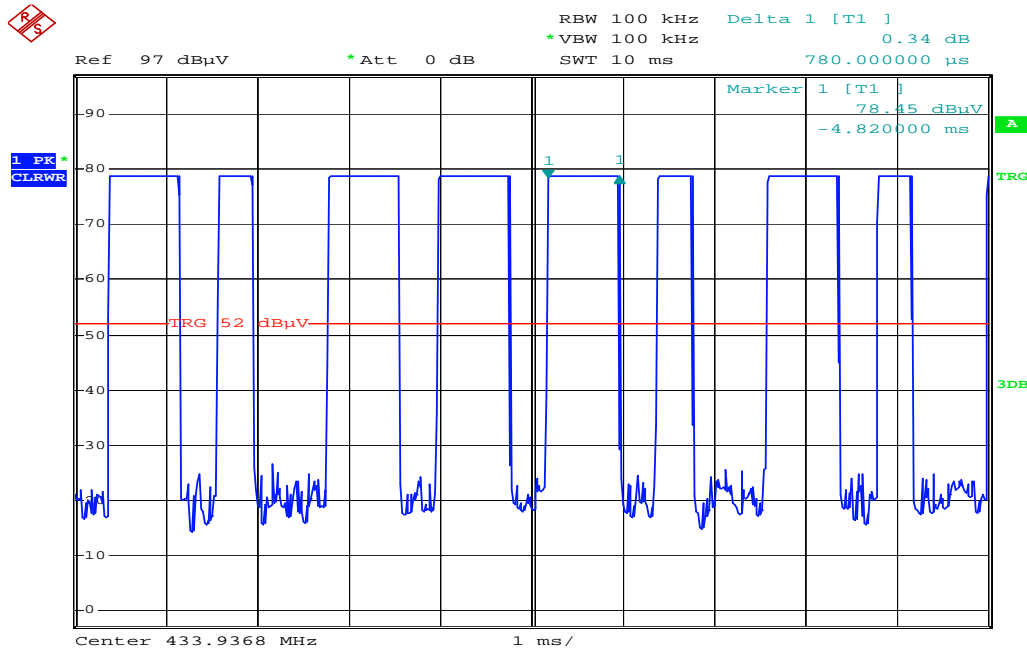

Date: 20.JUL.2011 16:10:43

Time Slot 2

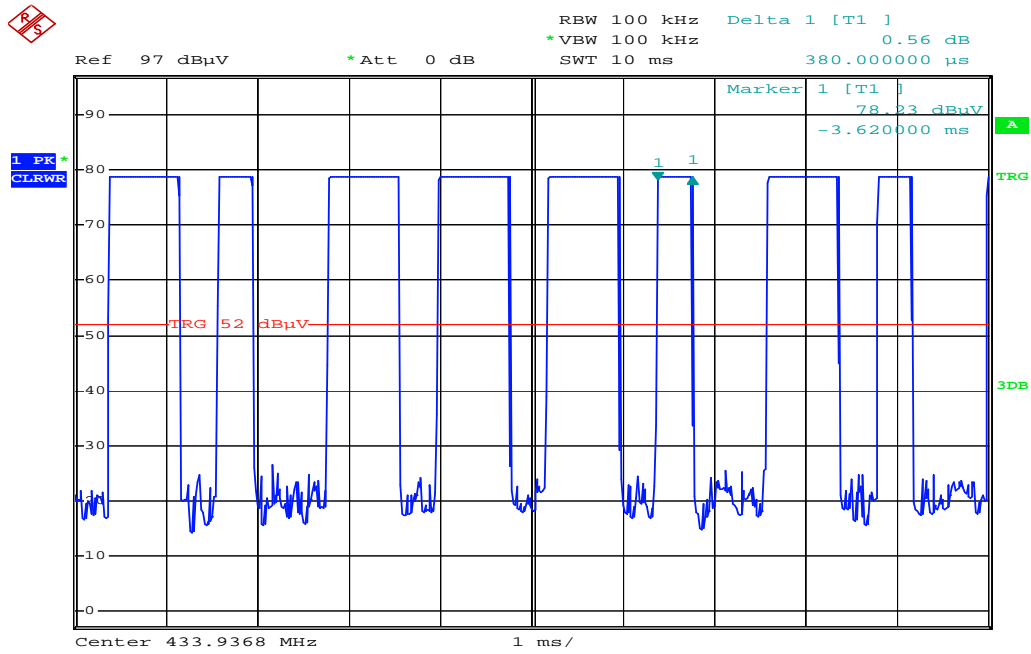

Date: 20.JUL.2011 16:11:19

Time Slot 3

The EUT was complied with the requirement of FCC 15.231 (a)(1), which employed a switch that will automatically deactivate the transmitter within less than 5 seconds of being released.

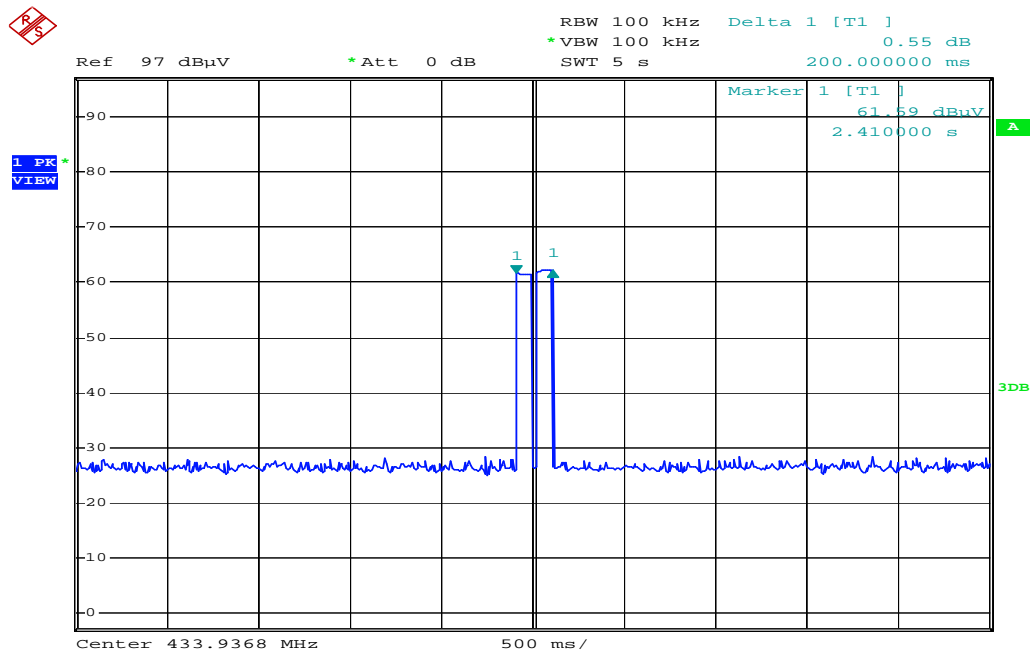

Date: 20.JUL.2011 16:32:29

4.3 Configuration of Measurement

Measurement Frequency under 1GHz

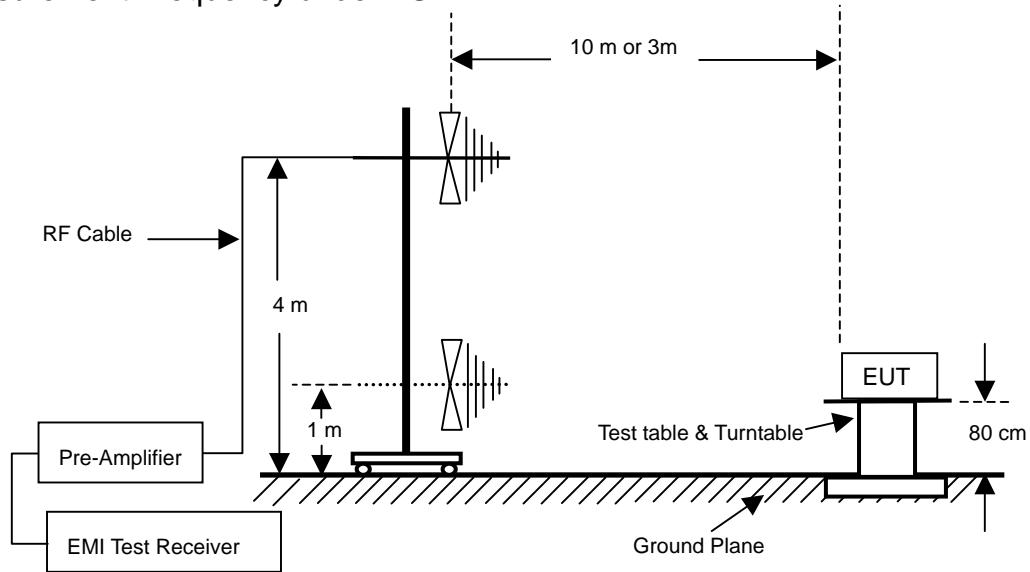

Measurement Frequency above 1GHz

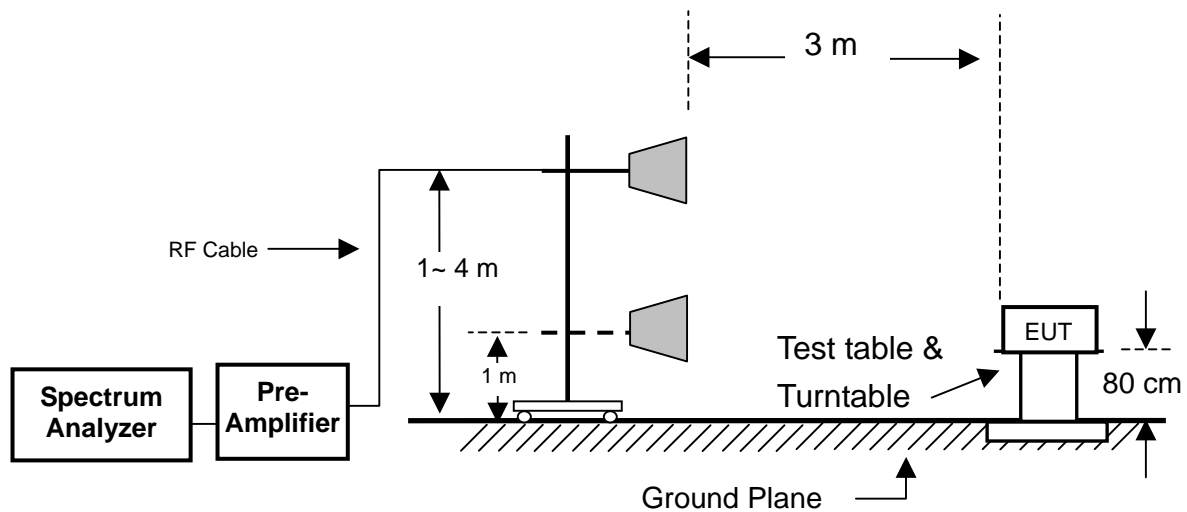

4.4 Test Procedure

Radiated emission measurements frequency range were performed from 30MHz to 5GHz. Spectrum Analyzer Resolution Bandwidth set to 100kHz or greater for frequencies from 30MHz to 1GHz, and set 1MHz Resolution Bandwidth for frequencies above 1GHz.

The EUT is place on non-conductive turntable for the test. If peripheral devices apply to the EUT, the peripheral devices will be connected to EUT and whole system. During the emission test, the signal is maximized through rotation and all cables were present worst-case emissions. The height of antenna and polarization is constantly changed for exploring maximum signal reading. The height of antenna can be up form reference ground to 4 meter and down to 1 meter.

4.5 Test Result

PASS.

The final test emission data is shown as following tables.

Radiated Emission below 1GHz

Frequency (MHz)	Antenna Polarization	Reading (dB μ V)	Preamp (dB)	Correction Factor (dB/m)	Corrected Level (dB μ V/m)	Limits (dB μ V/m)	Margin (dB)	Det. Mode
56.880	H	47.75	33.30	10.35	24.80	40.00	-15.20	QP
136.610	H	43.45	33.10	16.07	26.42	43.52	-17.10	QP
176.850	H	43.14	33.40	17.98	27.72	43.52	-15.80	QP
217.090	H	42.55	33.30	19.75	29.00	46.02	-17.02	QP
297.710	H	39.23	33.60	23.75	29.38	46.02	-16.64	QP
367.360	H	42.59	33.67	19.23	28.15	46.02	-17.87	QP
75.280	V	51.12	33.29	7.91	25.74	40.00	-14.26	QP
122.520	V	45.78	33.03	15.28	28.03	43.52	-15.49	QP
186.630	V	42.62	33.40	19.33	28.55	43.52	-14.97	QP
224.890	V	42.78	33.35	20.19	29.62	46.02	-16.40	QP
278.900	V	43.00	33.59	22.17	31.58	46.02	-14.44	QP
337.190	V	45.09	33.57	17.91	29.43	46.02	-16.59	QP

Remark : Corrected Level = Reading – Preamp + Correction Factor
 Correction Factor = Antenna Factor + Cable Loss

Fundamental and harmonics emissions

Freq. (MHz)	Antenna Polarization	Reading (dB μ V)	Preamp (dB)	Correction Factor (dB/m)	Average Factor (dB)	Corrected Level (dB μ V/m)	Limits (dB μ V/m)	Margin (dB)	Det. Mode
433.92	H	85.00	34.20	20.83	--	71.63	80.8	-9.17	PK
867.84	H	60.98	33.78	28.71	--	55.91	60.8	-4.89	PK
1301.76	H	51.64	26.14	28.48	--	53.98	54.0	-0.02	PK
1735.68	H	56.33	26.15	29.80	--	59.98	60.8	-0.82	PK
2169.60	H	51.85	26.23	31.14	--	56.76	60.8	-4.04	PK
2603.52	H	52.86	26.28	32.23	--	58.81	60.8	-1.99	PK
3037.44	H	51.13	26.20	33.15	--	58.08	60.8	-2.72	PK
3471.36	H	48.15	26.20	33.76	--	55.71	60.8	-5.09	PK
3905.28	H	44.06	26.12	35.01	--	52.95	54.0	-1.05	PK
4339.20	H	42.72	26.10	36.12	--	52.74	54.0	-1.26	PK
433.92	V	92.39	34.20	20.59	--	78.78	80.8	-2.02	PK
867.84	V	61.40	33.78	28.29	--	55.91	60.8	-4.89	PK
1301.76	V	55.56	26.14	28.48	--	57.90	74.0	-16.10	PK
1301.76	V	55.56	26.14	28.48	-6.66	51.24	54.0	-2.76	AV
1735.68	V	61.60	26.15	29.80	--	65.25	80.8	-15.55	PK
1735.68	V	61.60	26.15	29.80	-6.66	58.59	60.8	-2.21	AV
2169.60	V	51.65	26.23	31.14	--	56.56	60.8	-4.24	PK
2603.52	V	51.46	26.28	32.23	--	57.41	60.8	-3.39	PK
3037.44	V	53.60	26.20	33.15	--	60.55	60.8	-0.25	PK
3471.36	V	48.23	26.20	33.76	--	55.79	60.8	-5.01	PK
3905.28	V	44.63	26.12	35.01	--	53.52	54.0	-0.48	PK
4339.20	V	42.90	26.10	36.12	--	52.92	54.0	-1.08	PK

Remark :

1. Corrected Level = Reading – Preamp + Correction Factor
2. Correction Factor = Antenna Factor + Cable Loss
3. “ * ” Mark indicated Background Noise Level
4. The signal bandwidth was measured and less then 100KHz RBW so PDCF factor is not required to correct the fundamental signal peak result.

5 Emission bandwidth

5.1 Limits

According to FCC 15.231(c) requirement:

The bandwidth of the emission shall be no wider than 0.25% of the center frequency for devices operating between 70 MHz to 900 MHz. Those devices operating above 900 MHz, the emission spurious shall be no wider than 0.5% of the center frequency. Bandwidth is determined at the points 20 dB down from the modulated carrier.

B.W (20dBc) Limit = 0.25% * f(MHz) = 0.25% * 433.92MHz = 1084.8kHz

5.2 Test Result

PASS.

The final test data is shown as following.

Channel Frequency (MHz)	Measured 20dB Bandwidth (kHz)	Limit (kHz)	Result
433.92	59.6	1084.8	PASS

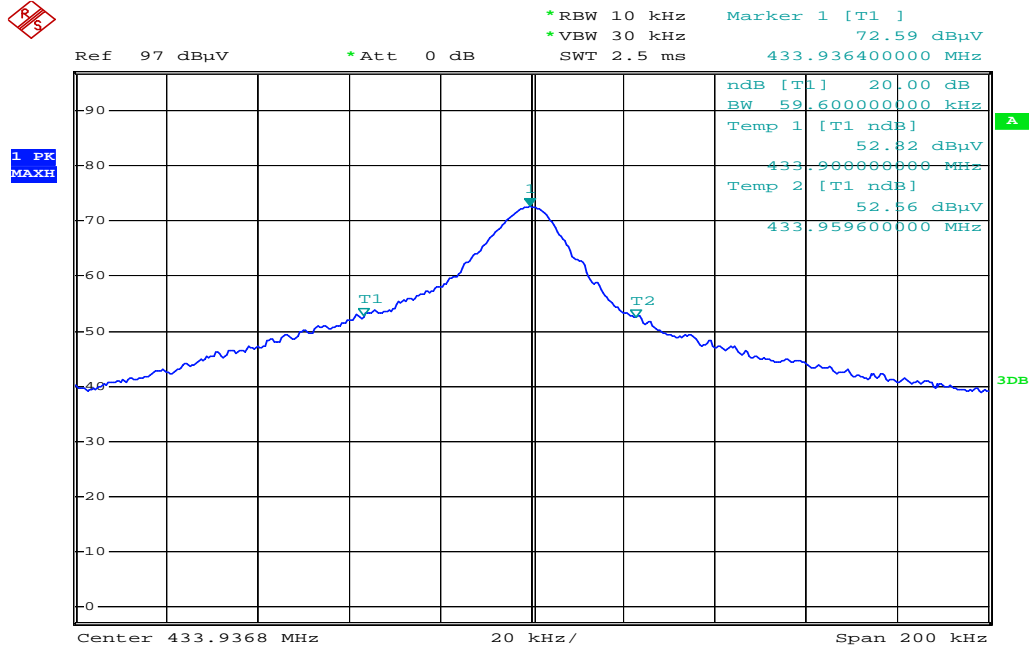

Date: 20.JUL.2011 16:01:38

6 Photographs of Test

6.1 Radiated Emission Measurement

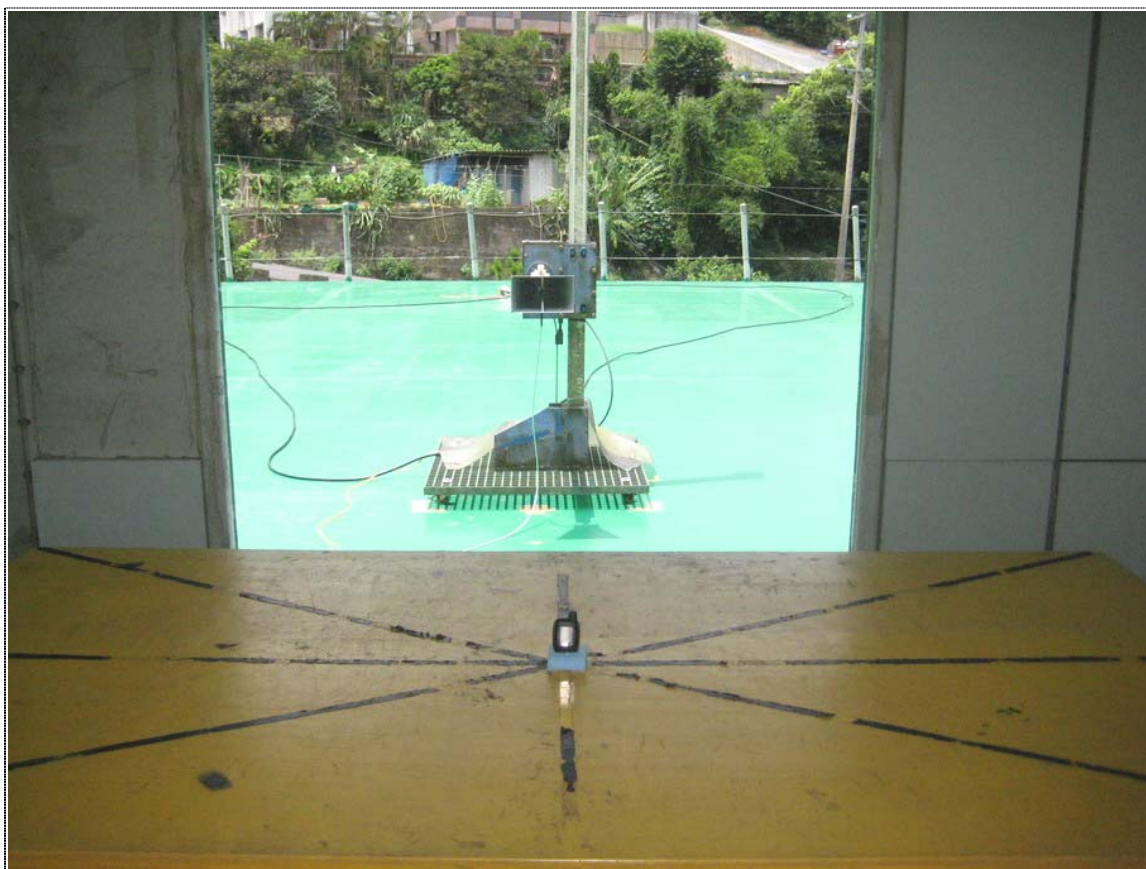

Front View of Above 1GHz

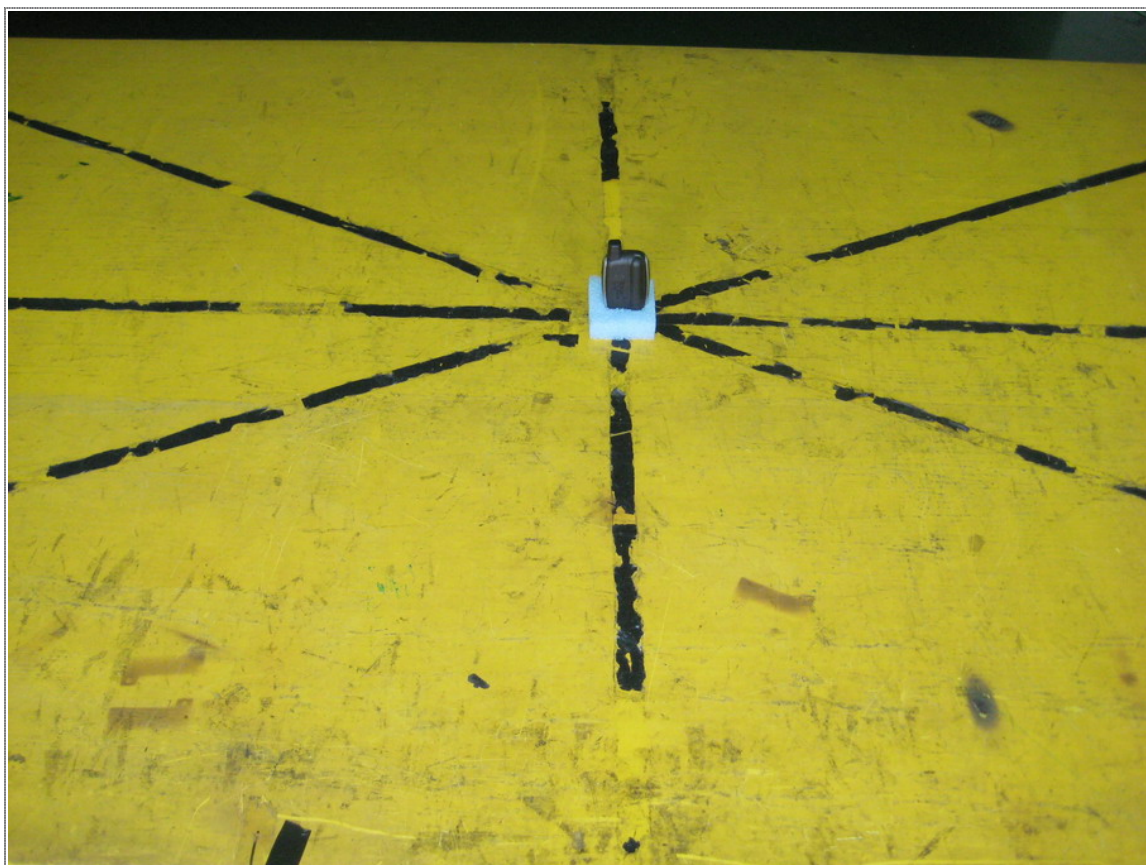

Rear View of Above 1GHz

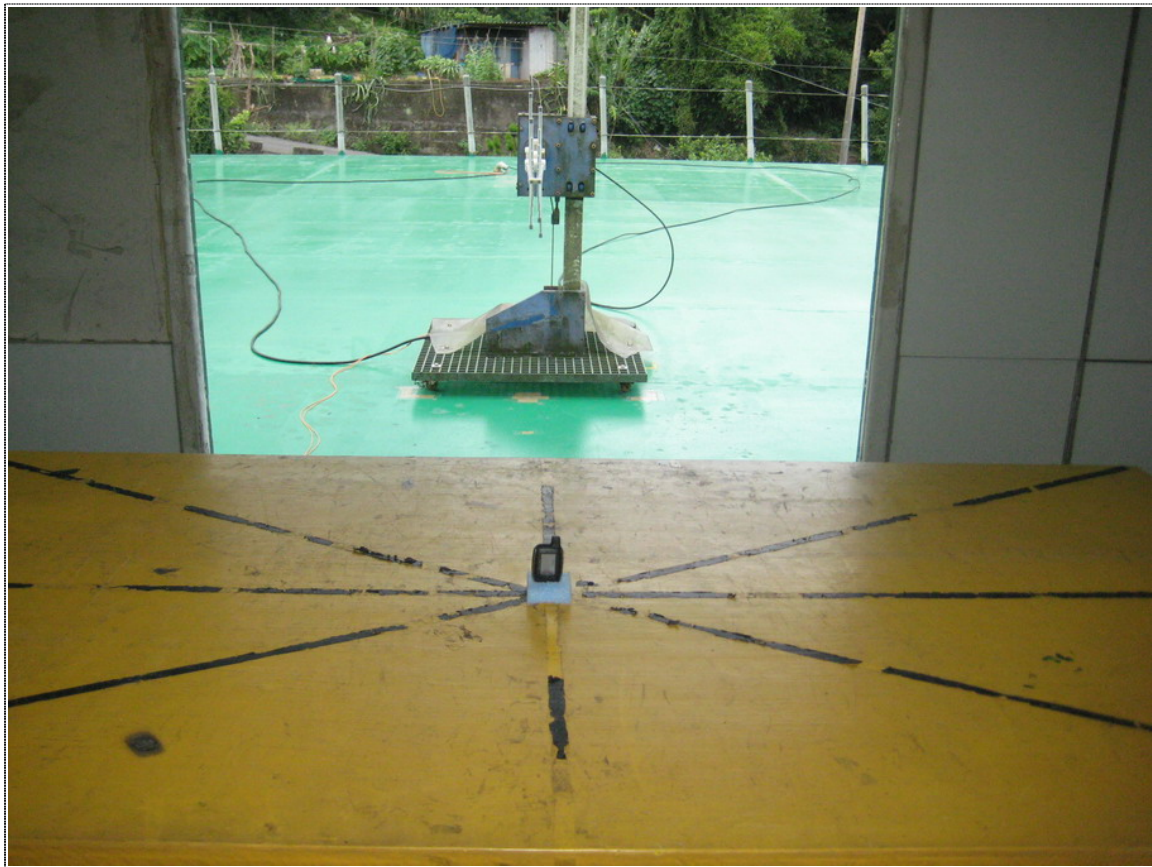

Front View of below 1GHz

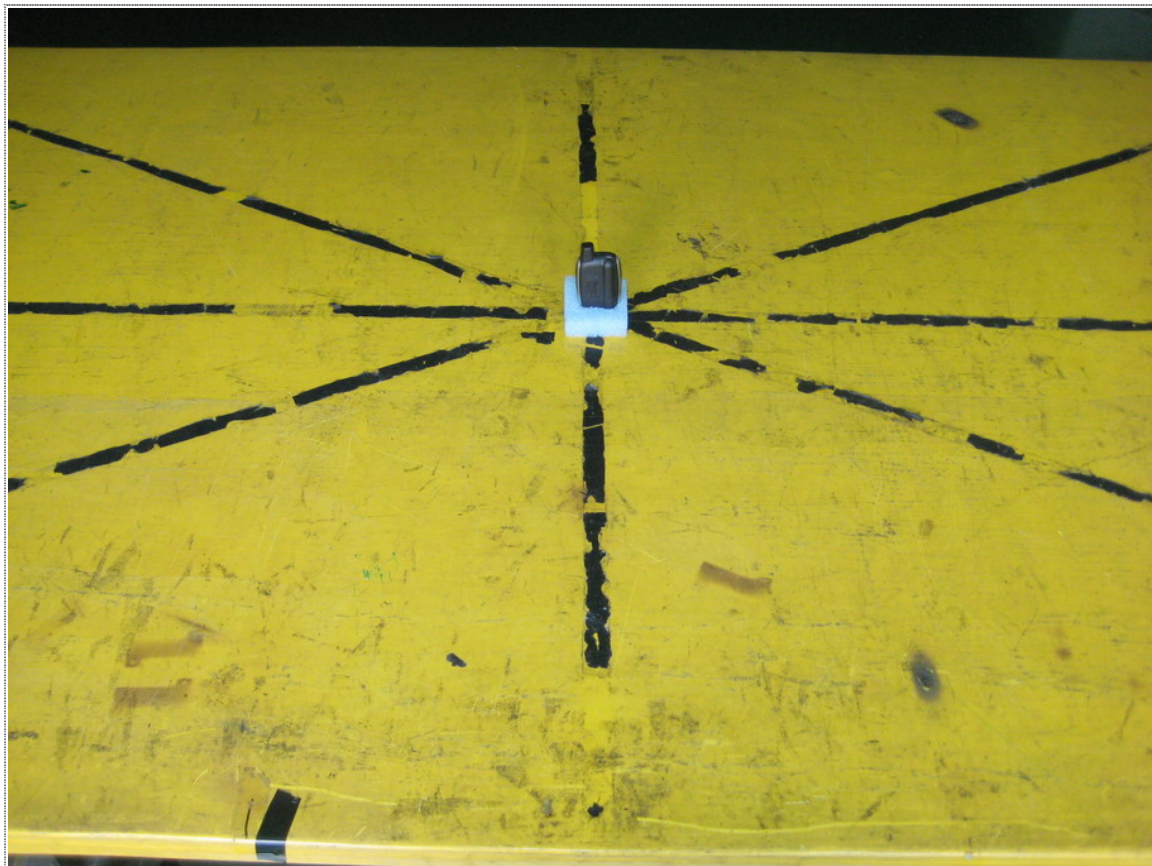

Rear View of below 1GHz

7 Photographs of EUT



Front View of EUT



Rear View of EUT



Label



Inner View of EUT

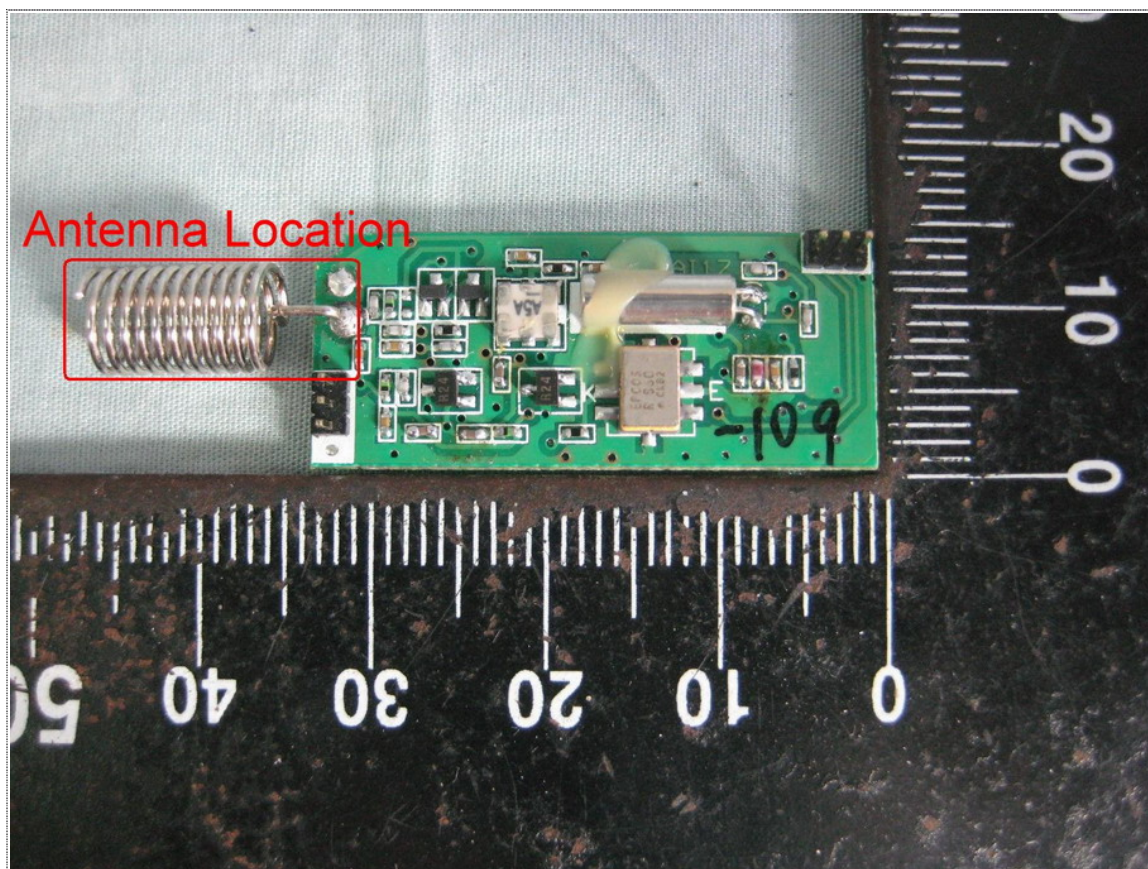

Antenna Location

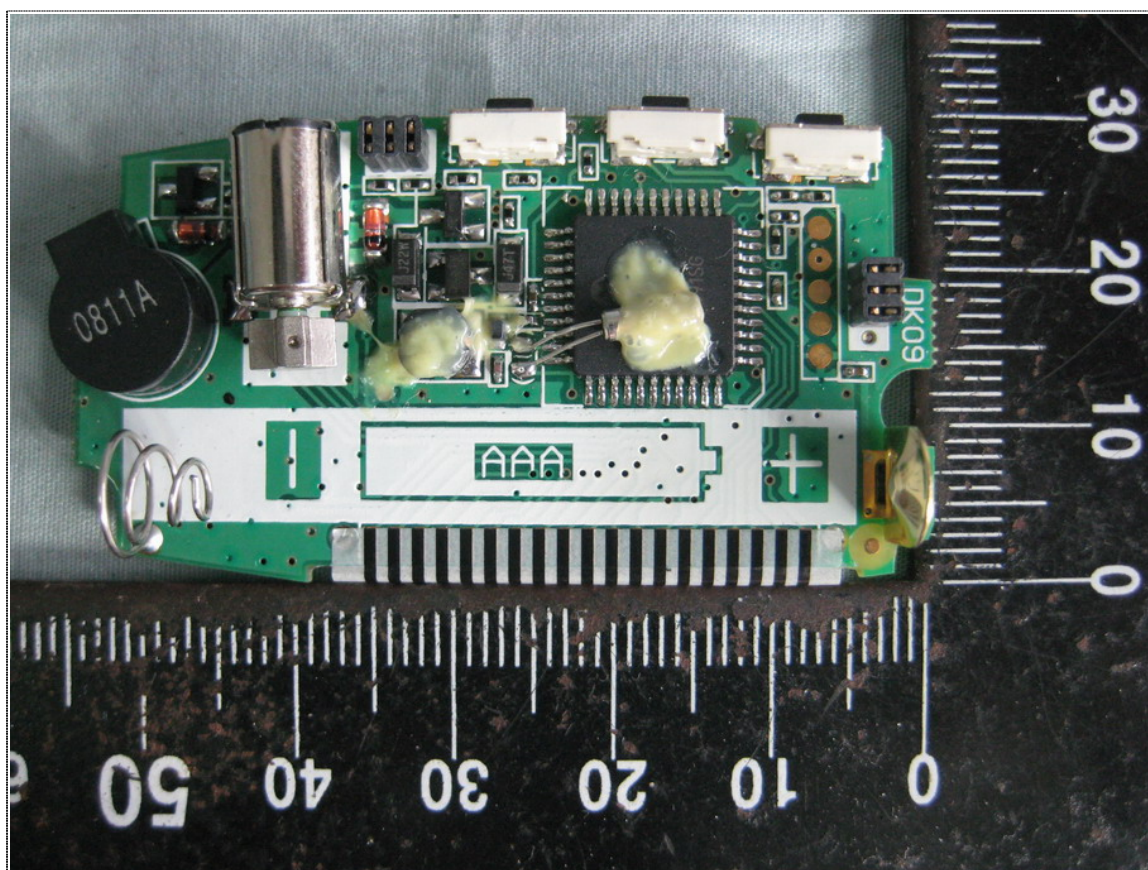

Component View of PCB Board-1

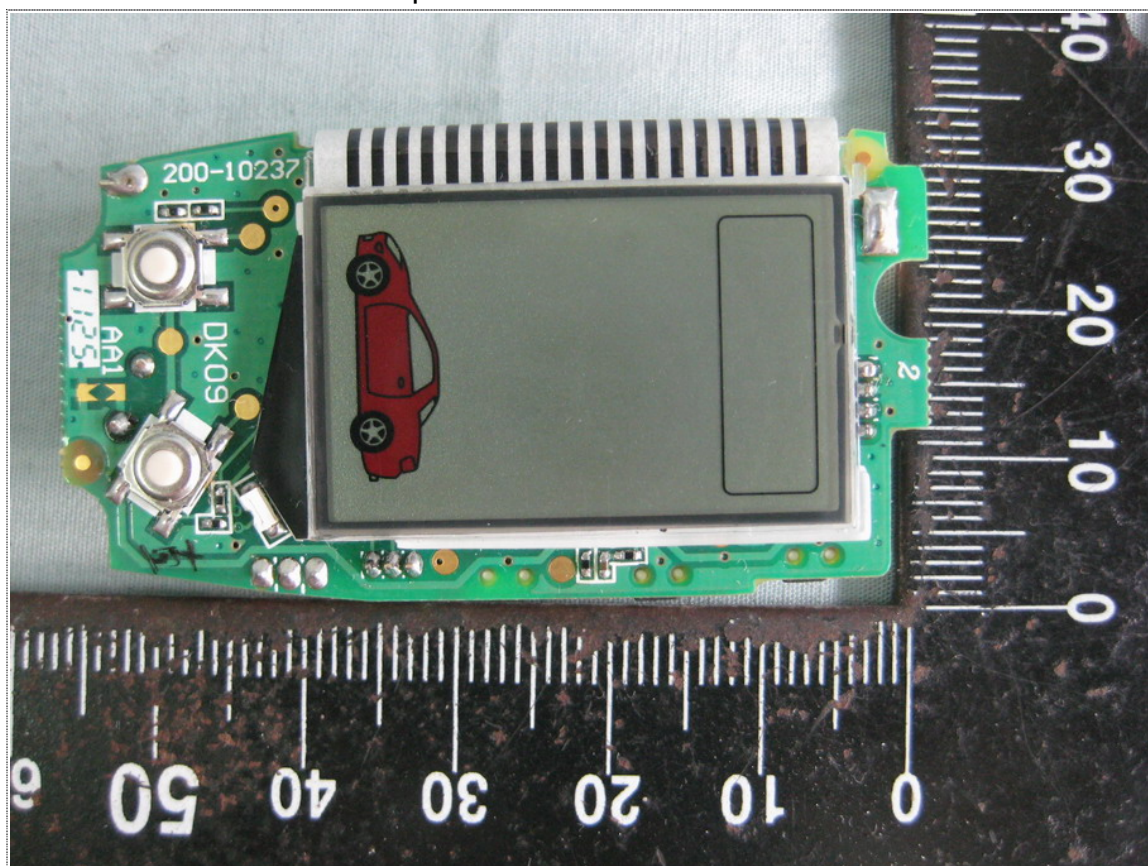

Solder View of PCB Board-1

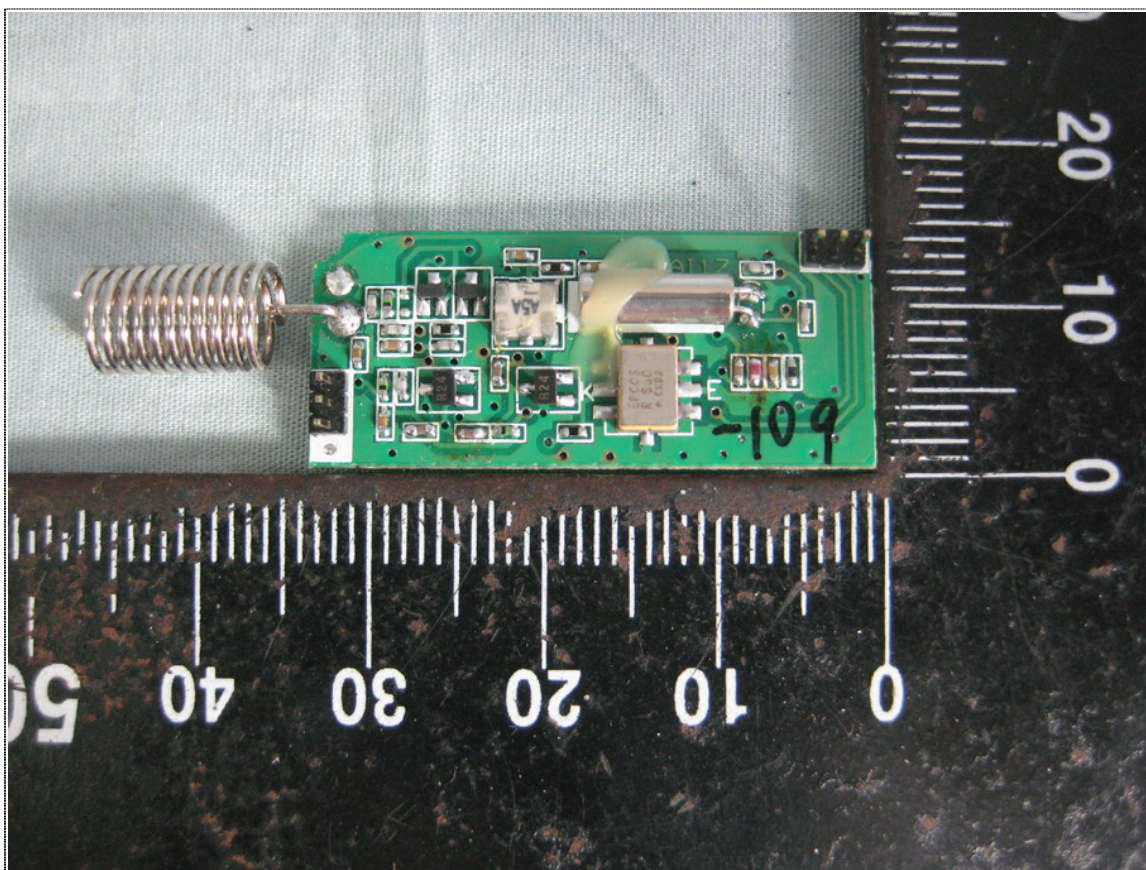

Component View of PCB Board-2

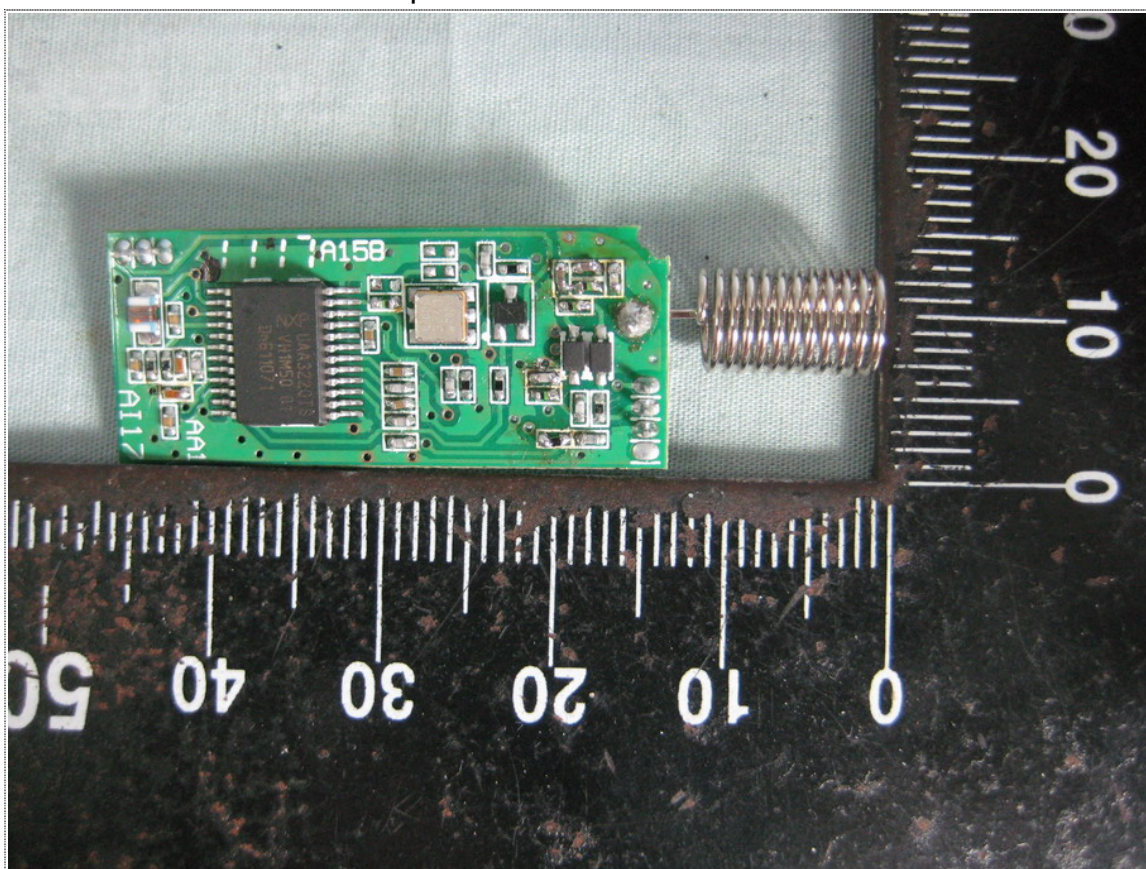

Solder View of PCB Board-2