

# 47 CFR FCC Part 15 Subpart C & Innovation, Science and Economic Development Canada RSS-210

## TEST REPORT

Product : Remote Control  
Trade Name : Viper, Automate  
Model Number : 7146V; 7145A  
FCC ID : EZSDEI7146  
IC : 1513A-7146

Prepared for

**DEI Headquarters, Inc.**

One Viper Way Vista, CA 92081-7853 United States

TEL. : (760) 598-6200

FAX : (760) 598-6400

Prepared by

**Interocean EMC Technology Corp.**

**Interocean EMC Technology Tin-Fu Laboratory**

No. 5-2, Lin 1, Tin-Fu, Lin-Kou Dist., New Taipei City,

Taiwan 244, R.O.C.

TEL.: +886 2 2600 6861

FAX.: +886 2 2600 6859



**Remark:**

The test report consists of **33** pages in total. It shall not be reproduced except in full, without the written approval of IETC. This document may be altered or revised by IETC only, and shall be noted in the revision section of the document.  
The test result in the report is only subjected to the test sample.

## Statement of Compliance

**Applicant:** DEI Headquarters, Inc.

**Manufacturer:** Nutek Corporation

**Product:** Remote Control

**Model No.:** 7146V; 7145A

**Tested Power Supply:** DC 6 V (For Battery)

**Date of Final Test:** Jun. 08, 2016

**Revision of Report:** Rev. 01

**Configuration of Measurements and Standards Used :**

47 FCC Part 15 Subpart C

Innovation, Science and Economic Development Canada RSS-Gen Issue 4

Innovation, Science and Economic Development Canada RSS-210 Issue 8

1. The result of the testing report relate only to the item tested.
2. The testing report shall not be reproduced expect in full, without the written approval of IETC.

Report Issued: 2016/06/21

Project Engineer: 

Elli Chang

Approved: 

Jerry Liu

## Table of Contents

<b>1</b>	<b>Summary of Measurement</b>	<b>4</b>
<b>2</b>	<b>General Information</b>	<b>5</b>
2.1	Description of Equipment Under Test	5
2.2	Details of Tested Peripheral Equipment	6
2.3	Test Facility	7
<b>3</b>	<b>Test Specifications</b>	<b>8</b>
3.1	Test Standard	8
3.2	Operation Mode	8
3.3	Test Step of EUT	8
3.4	Test Equipment	9
<b>4</b>	<b>Radiated Emission Test</b>	<b>10</b>
4.1	Limits	10
4.2	Calculation of Average Factor	11
4.3	Configuration of Measurement	16
4.4	Test Procedure	16
4.5	Test Result	16
<b>5</b>	<b>Emission Bandwidth</b>	<b>20</b>
5.1	Limits	20
5.2	Test Result	20
<b>6</b>	<b>99% Occupied Bandwidth</b>	<b>22</b>
6.1	Limits	22
6.2	Test Result	22
<b>7</b>	<b>Photographs of Test</b>	<b>24</b>
7.1	Radiated Emission Measurement	24
<b>8</b>	<b>Photographs of EUT</b>	<b>26</b>
8.1	Model Number: 7146V	26
8.2	Model Number: 7145A	28

## 1 Summary of Measurement

Report Clause	Test Parameter	Reference Document		Results
4	Timing Requirement	§FCC15.231(a)	RSS-210 A1.1.1	Pass
4	Radiated Emission	§FCC15.231(b), 15.209	RSS-210 A1.1.2	Pass
5	Emission Bandwidth	§FCC15.231(c)		Pass
6	99% Occupied Bandwidth		RSS-210 A1.1.3	Pass

## 2 General Information

### 2.1 Description of Equipment Under Test

<b>Product</b>	: Remote Control
<b>Model Number</b>	: 7146V; 7145A
<b>Applicant</b>	: <b>DEI Headquarters, Inc.</b> 2266 Tigereye Place Carlsbad, CA 92009 United States
<b>Manufacturer</b>	: <b>Nutek Corporation</b> No.167, Lane 235, Bauchiau Rd., Shindian City, Taipei Country 23145, Taiwan
<b>Power Supply</b>	: DC 6 V (For Battery)
<b>Operating Frequency</b>	: 433.92MHz
<b>Type of Modulation</b>	: ASK
<b>Product SW/HW version</b>	: DEIE07 // DTQA
<b>Radio SW/HW version</b>	: DEIE07 // DTQA
<b>Test SW Version</b>	: N/A ,no test SW was used during testing” Parameters are fixed by hardware design.
<b>RF power setting in TEST SW</b>	: N/A , RF power setting was not able to alter during testing” RF power output is fixed by hardware design.
<b>Antenna Description</b>	: This device uses PCB Antenna.  The antenna is integral to the device, thereby meeting the requirement of FCC 15.203.
<b>Measurement Software</b>	: e3; Ver: 8.120803a7-2
<b>Date of Test</b>	: Jun. 02 ~ 08, 2016
<b>Additional Description</b>	: 1) The Model Number “ <b>7146V</b> ” is representative selected in the test and included in this report. 2) All models included in this report have the same PCB & Layout, the difference is only in Housing. 3) For more detail specification about EUT, please refer to the user’s manual.

## **2.2 Details of Tested Peripheral Equipment**

N/A

## 2.3 Test Facility

- Site Description** : ☒ Chamber 3
- Name of Firm** : Interocean EMC Technology Corp.
- Company web** : <http://www.ietc.com.tw>
- Location** : No. 5-2, Lin 1, Tin-Fu, Lin-Kou Dist., New Taipei City, Taiwan 244, R.O.C.
- Site Filing** :
- Federal Communication Commissions – USA  
Registration No.: 651092 (OATS 1, 2, 3 & Chamber 3)  
Designation No.: TW1020
  - Industry Canada (IC)  
OUR FILE: 46405-4437  
Registration No. (OATS 1): Site# 4437A-1  
Registration No. (OATS 3): Site# 4437A-3  
Registration No. (Chamber 3): Site# 4437A-5  
Registration No. (OATS 5): Site# 4437A-6
  - Voluntary Control Council for Interference by Information Technology Equipment (VCCI) – Japan  
Member No.: 1349  
Registration No. (Conducted Room): C-1094  
Registration No. (Conducted Room): T-1562  
Registration No. (OATS 1): R-1040; G-274
- Site Accreditation** :
- Bureau of Standards and Metrology and Inspection (BSMI) – Taiwan, R.O.C.  
Accreditation No.:  
SL2-IN-E-0026 for CNS 13438 / CISPR 22  
SL2-IN-E-0026 for CNS 14757-2 / IEC 62040-2  
SL2-R1-E-0026 for CNS 13439 / CISPR 13  
SL2-R2-E-0026 for CNS 13439 / CISPR 13  
SL2-L1-E-0026 for CNS 14115 / CISPR 15
  - Taiwan Accreditation Foundation (TAF)  
Accreditation No.: 1113
  - Vehicle Safety Certification Center (VSCC)  
Approval No.: TW16-11-0
  - TÜV NORD  
Certificate No: TNTW0801R-04

### 3 Test Specifications

#### 3.1 Test Standard

The EUT was performed according to FCC Part 15 Subpart C Section 15.231 and Innovation, Science and Economic Development Canada RSS-210 procedure and setup followed by ANSI C63.10, 2013 requirements.

#### 3.2 Operation Mode

By preliminary testing and verifying three axis (X, Y and Z) position of EUT transmitted status, it was found that "X axis" position was the worst, then the final test was executed the worst condition and test data were recorded in this report.

The EUT was operated in continuous transmission mode during all of the tests.



X axis mode



Y axis mode



Z axis mode

#### 3.3 Test Step of EUT

- 3.3.1 Setup the fixture to EUT for power supplying.
- 3.3.2 Turn on the power of all equipment.
- 3.3.3 Let the EUT continuous transmission. Executed the test.



### 3.4 Test Equipment

Instrument	Manufacturer	Model	Serial No.	Next Cal. Date
Spectrum Analyzer	R&S	FSP40	100478	2017/06/05
EMI Test Spectrum Analyzer & Receiver	R&S	ESI7	830154/002	2016/09/24
Preamplifier	Burgeon	BPA-530	100216	2016/06/30
Preamplifier	Schaffner	CAP9231A	3351	2016/08/25
Preamplifier	Mini-Circuits	ZVA-213-S+	491801136	2016/08/25
Preamplifier	EMCI	EMC 051845	980110	2016/10/20
Preamplifier	Agilent	83050A	3950M00225	2016/09/21
Bilog Antenna	Schwarzbeck	VULB 9163	113	2016/07/26
Horn Antenna	Schwarzbeck	BBHA 9120	9120D-583	2016/09/29
Horn Antenna	Schwarzbeck	BBHA 9170	213	2016/07/19
RF Cable	HARBOUR	27478LL142	CBL22	2017/03/22
RF Cable	Jye Bao	N30N30-5006	CBL53	2017/03/29
RF Cable	HARBOUR	27478LL142	CBL65	2017/03/22
Measurement Software	AUDIX-e3			

Note: The above equipments are within the valid calibration period.

### 3.5 Measurement Uncertainty

Item	Expended Uncertainty (k=2)
Conduction 1:	
Conducted Emission (9 kHz to 30 MHz)	2.98 dB
Chamber 3:	
Radiated Emission Test (30 MHz to 1 GHz)	4.86 dB
Radiated Emission Test (above 1 GHz)	5.12 dB
RF test:	
RF conducted measurement (9 kHz to 40GHz)	2.92 dB

## 4 Radiated Emission Test

### 4.1 Limits

According to FCC 15.231(b) and RSS-210 Annex 1 requirement:

In addition to the provisions of §15.205, the field strength of emissions from intentional radiator operated under this section shall not exceed the following:

#### Fundamental and harmonics emission limits

Frequency (MHz)	Field Strength of Fundamental		Field Strength of Harmonics	
	( $\mu$ V/m@3m)	(dB $\mu$ V/m@3m)	( $\mu$ V/m@3m)	(dB $\mu$ V/m@3m)
433.92	10996	80.8	1099.6	60.8

#### General Radiated Emission Limit

Spurious Emission tested through until 10<sup>th</sup> harmonic. Radiated emissions, which fall in the restricted bands, as defined in §15.205 (a), comply with the radiated emission limits specified in §15.209 (a) and defined in RSS-Gen Table 3, comply with the radiated emission limits specified in RSS-Gen 7.2.5.

Frequency (MHz)	15.209 Limits	
	( $\mu$ V/m@3m)	(dB $\mu$ V/m@3m)
30-88	100	40
88-216	150	43.5
216-960	200	46
Above 960	500	54

Remark :

1. The table above tighter limit applies at the band edges.
2. The measurement distance in meters, which that between form closest point of EUT to instrument antenna.

## 4.2 Calculation of Average Factor

The output field strengths of specification in accordance with the rules specify measurements with an average detector. During the test, a spectrum analyzer incorporating a peak detector was used. Therefore, a reduction factor can be applied to the resultant peak signal level and compared to the limit for measurement instrumentation incorporating an average detector. The duty cycle is measured in 100 ms or the repetition cycle period, whichever is a shorter time frame. The duty cycle is measured by placing the spectrum analyzer to set zero span at 100kHz resolution bandwidth.

Averaging factor in dB =  $20 \log (\text{duty cycle})$

The duration of one cycle = 102.82ms

The duty cycle is simply the on-time divided by 100ms

Duty Cycle =  $(0.75\text{ms} \times 30 + 0.39\text{ms} \times 48) / 100\text{ms} = 41.22 \text{ ms} / 100\text{ms}$

Therefore, the averaging factor is found by  $20 \log 0.4122 = -7.70 \text{ dB}$

Please see the diagrams below.

# Duty Cycle

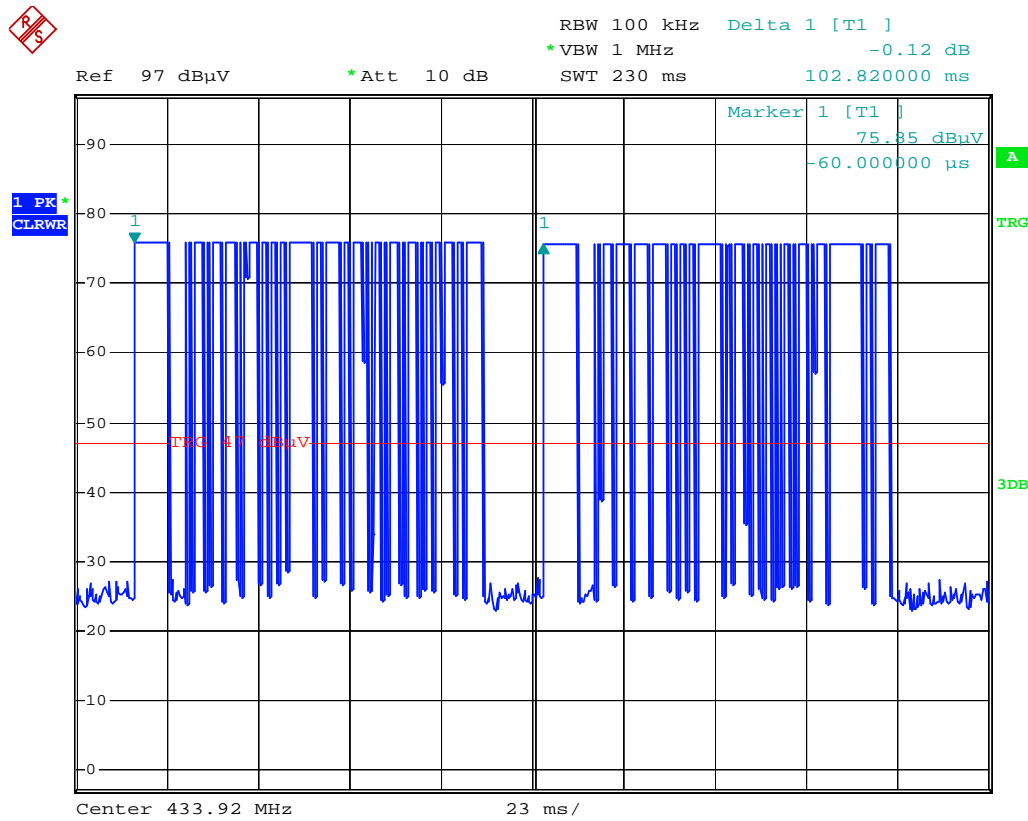

### Time Slot

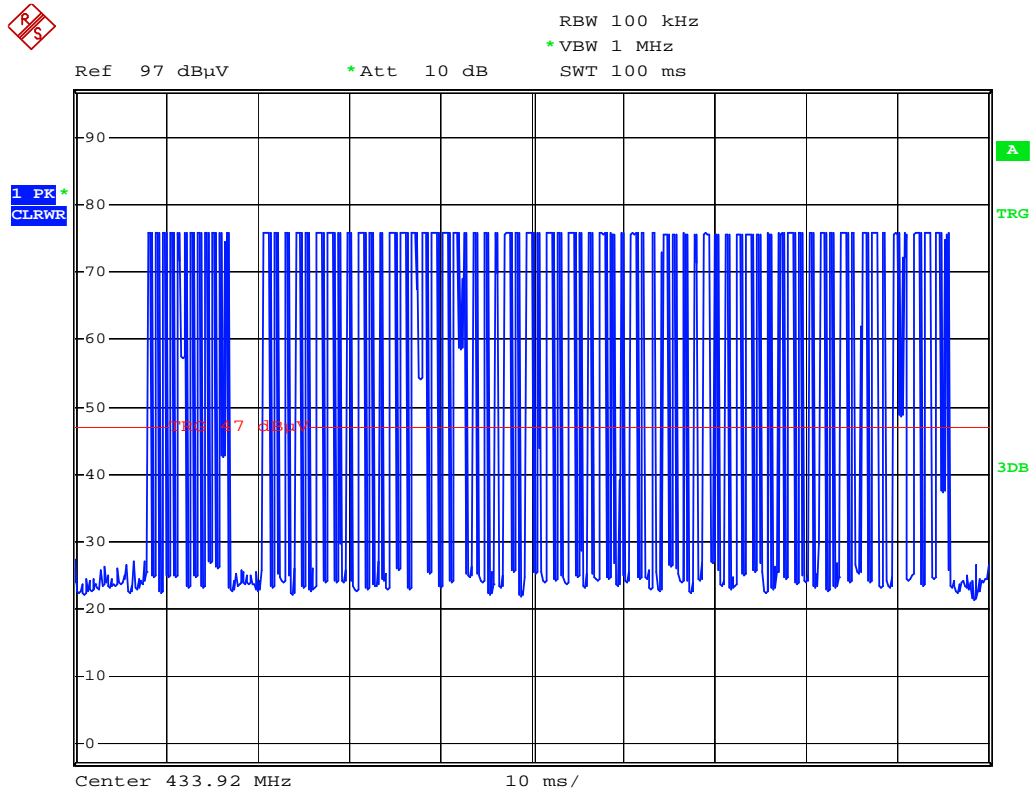

### Time Slot

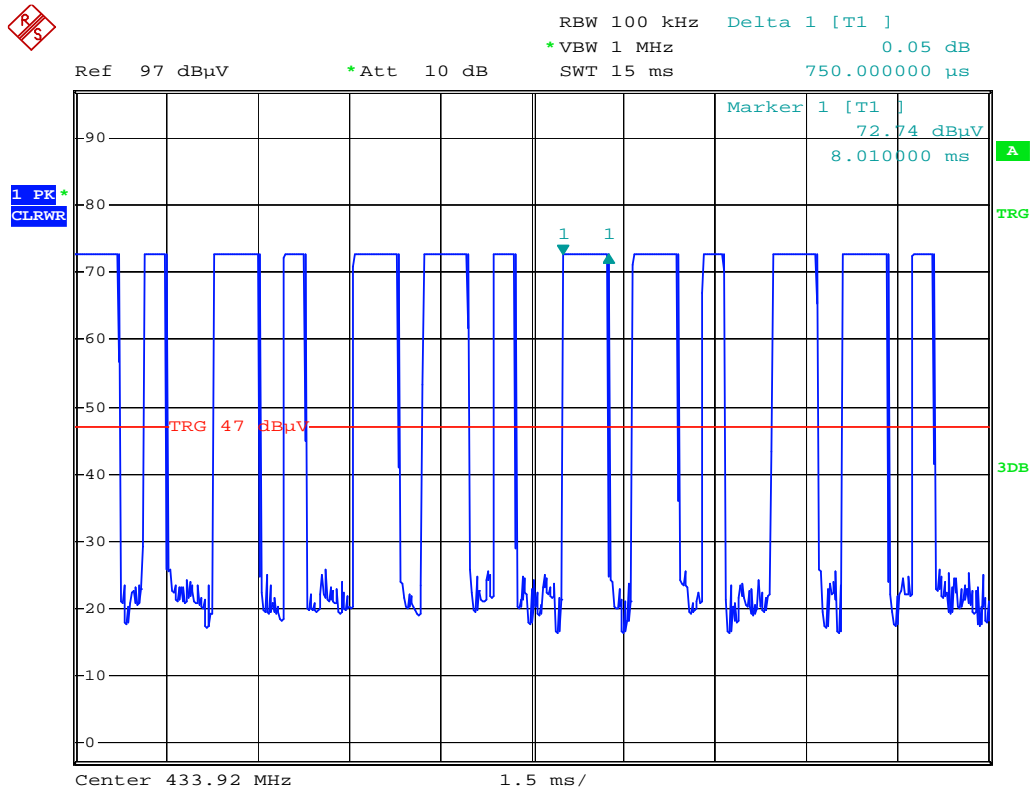

### Time Slot 1

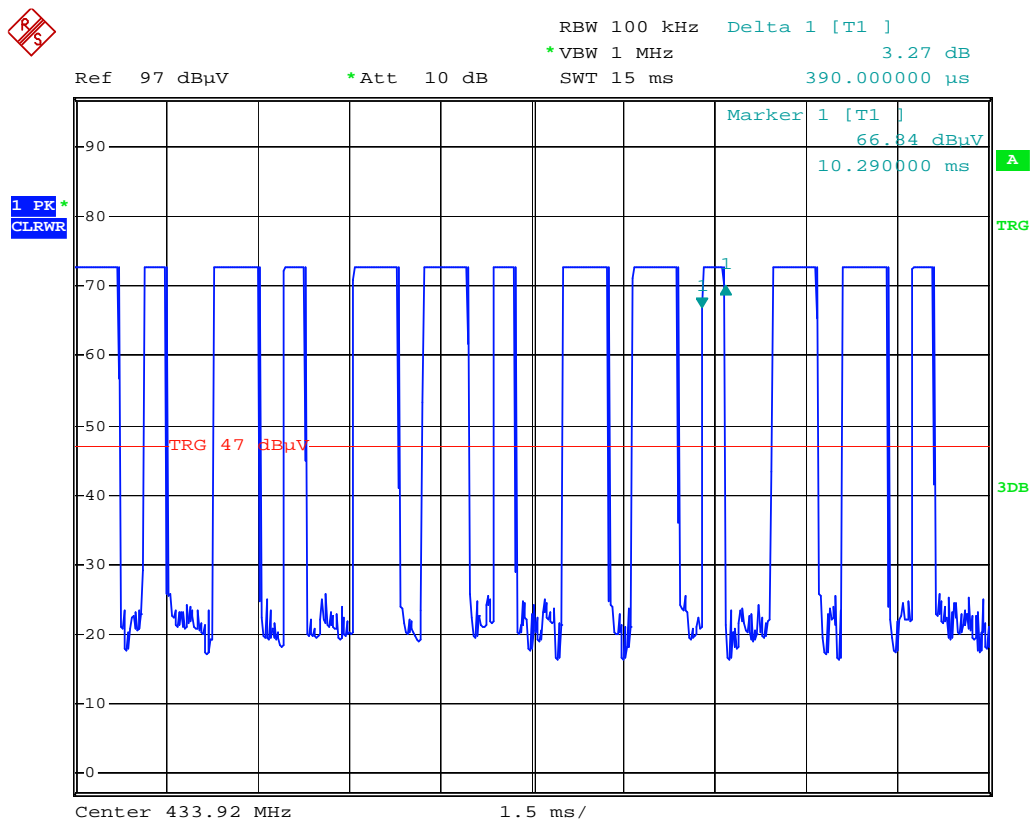

Time Slot 2

The EUT was complied with the requirement of FCC 15.231 (a)(1) and RSS-210 Annex 1, which employed a switch that will automatically deactivate the transmitter within less than 5 seconds of being released.

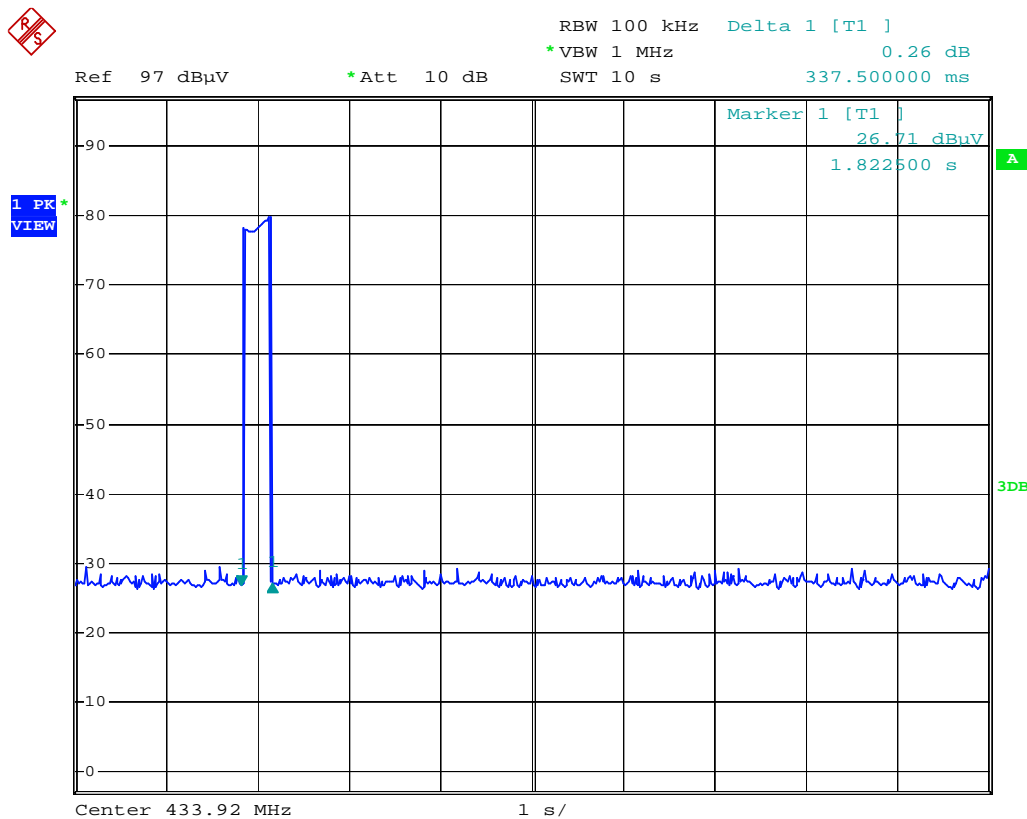

### 4.3 Configuration of Measurement

#### Measurement Frequency under 1GHz

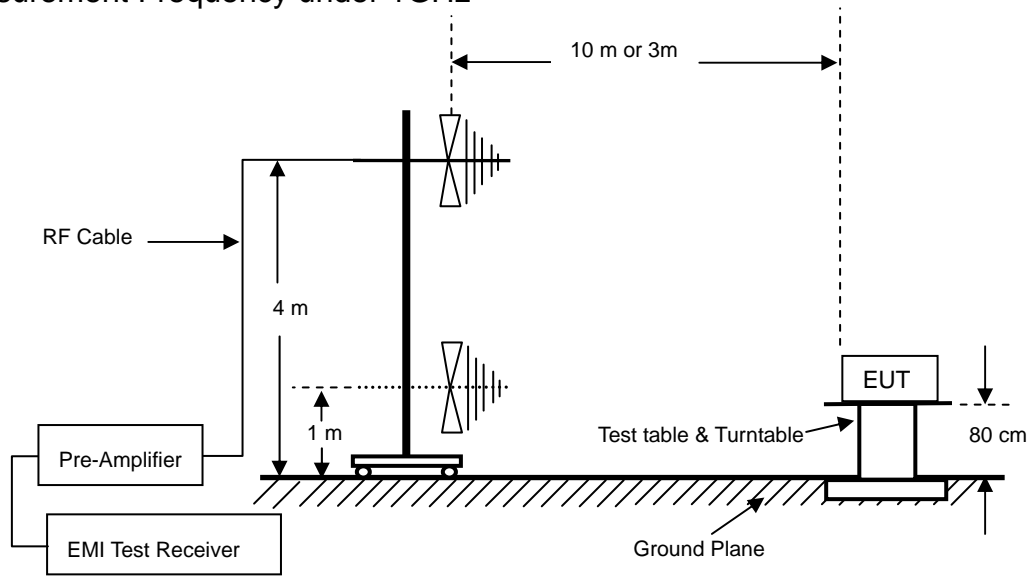

#### Measurement Frequency above 1GHz

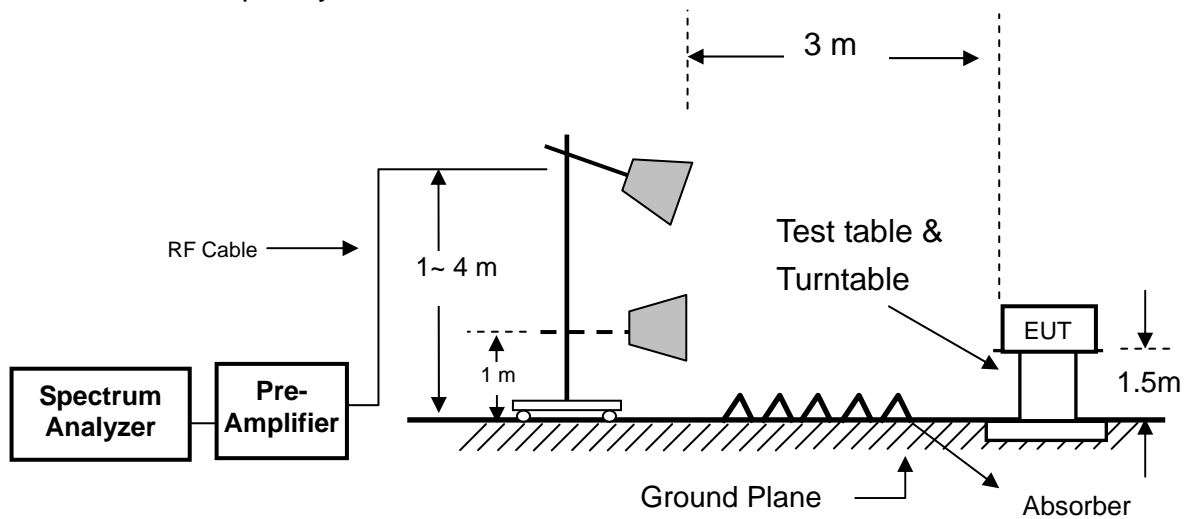

### 4.4 Test Procedure

Radiated emission measurements frequency range were performed from 30MHz to 5GHz. Spectrum Analyzer Resolution Bandwidth set to 100kHz or greater for frequencies from 30MHz to 1GHz, and set 1MHz Resolution Bandwidth for frequencies above 1GHz.

The EUT is place on non-conductive turntable for the test. If peripheral devices apply to the EUT, the peripheral devices will be connected to EUT and whole system. During the emission test, the signal is maximized through rotation and all cables were present worst-case emissions. The height of antenna and polarization is constantly changed for exploring maximum signal reading. The height of antenna can be up form reference ground to 4 meter and down to 1 meter.

### 4.5 Test Result

**PASS.**

The final test emission data is shown as following tables.



## Radiated emission below 1GHz

### Worse case: X axis

Frequency	Antenna	Reading	Preamp	Correction Factor	Corrected Level	Limits	Margin	Det
(MHz)	Polarization	(dBUV)	(dB)	(dB/m)	(dBUV/m)	(dBUV/m)	(dB)	Mode
69.38	H	40.19	31.59	10.59	19.19	40.00	-20.81	PK
120.50	H	44.89	31.43	10.93	24.39	43.50	-19.11	PK
178.20	H	43.62	31.28	11.23	23.57	43.50	-19.93	PK
234.80	H	41.62	31.23	14.24	24.63	46.00	-21.37	PK
330.50	H	38.67	31.26	17.13	24.54	46.00	-21.46	PK
397.50	H	38.59	31.33	18.73	25.99	46.00	-20.01	PK
56.30	V	39.18	31.64	13.79	21.33	40.00	-18.67	PK
113.58	V	44.27	31.46	12.37	25.18	43.50	-18.32	PK
189.37	V	42.04	31.25	13.51	24.30	43.50	-19.20	PK
269.30	V	40.67	31.22	15.05	24.50	46.00	-21.50	PK
368.30	V	39.63	31.30	18.24	26.57	46.00	-19.43	PK
469.83	V	38.58	31.31	20.25	27.52	46.00	-18.48	PK

Remark : Corrected Level = Reading + Correction Factor – Preamp  
 Correction Factor = Antenna Factor + Cable Loss

**Fundamental and Harmonics Emissions**

Freq.	Antenna	Reading	Preamp	Correction Factor	Average Factor	Corrected Level	Limits	Margin	Det
(MHz)	Polarization	(dBUV)	(dB)	(dB/m)	(dB)	(dBUV/m)	(dBUV/m)	(dB)	Mode
433.92 (X)	H	62.00	0.00	19.44	--	81.44	100.8	-19.36	PK
433.92 (X)	H	62.00	0.00	19.44	-7.70	73.74	80.8	-7.06	AV
433.92 (Y)	H	62.87	0.00	19.44	--	82.31	100.8	-18.49	PK
433.92 (Y)	H	62.87	0.00	19.44	-7.70	74.61	80.8	-6.19	AV
433.92 (Z)	H	66.66	0.00	19.44	--	86.10	100.8	-14.70	PK
433.92 (Z)	H	66.66	0.00	19.44	-7.70	78.40	80.8	-2.40	AV
867.84	H	54.71	31.27	26.26	--	49.70	80.8	-31.10	PK
867.84	H	54.71	31.27	26.26	-7.70	42.00	60.8	-18.80	AV
1301.76	H	73.13	50.92	30.59	--	52.80	74.0	-21.20	PK
1301.76	H	73.13	50.92	30.59	-7.70	45.10	54.0	-8.90	AV
1735.68	H	72.56	50.95	32.16	--	53.77	80.8	-27.03	PK
1735.68	H	72.56	50.95	32.16	-7.70	46.07	60.8	-14.73	AV
2169.60	H	73.80	50.93	33.46	--	56.33	80.8	-24.47	PK
2169.60	H	73.80	50.93	33.46	-7.70	48.63	60.8	-12.17	AV
2603.52	H	67.49	51.02	34.76	--	51.23	80.8	-29.57	PK
2603.52	H	67.49	51.02	34.76	-7.70	43.53	60.8	-17.27	AV
3037.44	H	65.42	51.11	36.12	--	50.43	80.8	-30.37	PK
3037.44	H	65.42	51.11	36.12	-7.70	42.73	60.8	-18.07	AV
3471.36	H	67.49	51.29	36.68	--	52.88	80.8	-27.92	PK
3471.36	H	67.49	51.29	36.68	-7.70	45.18	60.8	-15.62	AV
3905.28	H	70.50	51.38	38.00	--	57.12	74.0	-16.88	PK
3905.28	H	70.50	51.38	38.00	-7.70	49.42	54.0	-4.58	AV
4339.20	H	62.54	51.54	39.45	--	50.45	74.0	-23.55	PK
4339.20	H	62.54	51.54	39.45	-7.70	42.75	54.0	-11.25	AV
433.92 (X)	V	67.04	0.00	19.44	--	86.48	100.8	-14.32	PK
433.92 (X)	V	67.04	0.00	19.44	-7.70	78.78	80.8	-2.02	AV
433.92 (Y)	V	63.34	0.00	19.44	--	82.78	100.8	-18.02	PK
433.92 (Y)	V	63.34	0.00	19.44	-7.70	75.08	80.8	-5.72	AV
433.92 (Z)	V	52.93	0.00	19.44	--	72.37	100.8	-28.43	PK
433.92 (Z)	V	52.93	0.00	19.44	-7.70	64.67	80.8	-16.13	AV
867.84	V	53.07	31.27	26.26	--	48.06	80.8	-32.74	PK
867.84	V	53.07	31.27	26.26	-7.70	40.36	60.8	-20.44	AV
1301.76	V	72.53	50.92	30.59	--	52.20	74.0	-21.80	PK
1301.76	V	72.53	50.92	30.59	-7.70	44.50	54.0	-9.50	AV
1735.68	V	74.07	50.95	32.16	--	55.28	80.8	-25.52	PK
1735.68	V	74.07	50.95	32.16	-7.70	47.58	60.8	-13.22	AV

2169.60	V	64.97	50.93	33.46	--	47.50	80.8	-33.30	PK
2169.60	V	64.97	50.93	33.46	-7.70	39.80	60.8	-21.00	AV
2603.52	V	67.77	51.02	34.76	--	51.51	80.8	-29.29	PK
2603.52	V	67.77	51.02	34.76	-7.70	43.81	60.8	-16.99	AV
3037.44	V	69.92	51.11	36.12	--	54.93	80.8	-25.87	PK
3037.44	V	69.92	51.11	36.12	-7.70	47.23	60.8	-13.57	AV
3471.36	V	67.48	51.29	36.68	--	52.87	80.8	-27.93	PK
3471.36	V	67.48	51.29	36.68	-7.70	45.17	60.8	-15.63	AV
3905.28	V	73.17	51.38	38.00	--	59.79	74.0	-14.21	PK
3905.28	V	73.17	51.38	38.00	-7.70	52.09	54.0	-1.91	AV
4339.20	V	65.89	51.54	39.45	--	53.80	74.0	-20.20	PK
4339.20	V	65.89	51.54	39.45	-7.70	46.10	54.0	-7.90	AV

- Remark :
1. Corrected Level = Reading + Correction Factor – Preamp
  2. Correction Factor = Antenna Factor + Cable Loss
  3. “ \* ” Mark indicated Background Noise Level

## **5 Emission Bandwidth**

### **5.1 Limits**

According to FCC 15.231(c) requirement:

The bandwidth of the emission shall be no wider than 0.25% of the center frequency for devices operating between 70 MHz to 900 MHz. Those devices operating above 900 MHz, the emission spurious shall be no wider than 0.5% of the center frequency. Bandwidth is determined at the points 20 dB down from the modulated carrier.

B.W (20dBc) Limit = 0.25% \* f(MHz) = 0.25% \* 433.92MHz = 1084.8kHz

### **5.2 Test Result**

**PASS.**

The final test data is shown as following.

Channel Frequency (MHz)	20dB Bandwidth (kHz)	Limit (kHz)	Result
433.92	52.8	1084.8	PASS

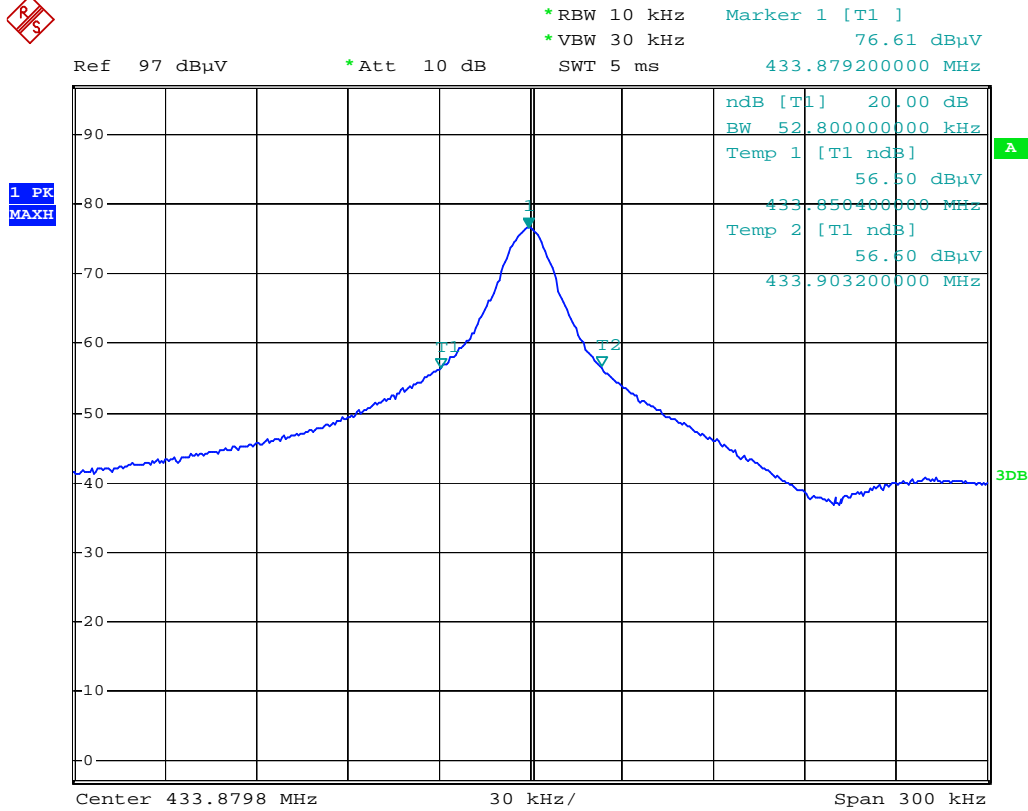

## **6 99% Occupied Bandwidth**

### **6.1 Limits**

According to RSS-210 Annex 1 requirement:

The 99% bandwidth shall be no wider than 0.25% of the centre frequency for devices operating between 70 MHz and 900 MHz. For devices operating above 900 MHz, the emission shall be no wider than 0.5% of the centre frequency.

99% OBW Limit = 0.25% \* f(MHz) = 0.25% \* 433.92MHz = 1084.8kHz

### **6.2 Test Result**

**PASS.**

The final test data is shown as following.

Channel Frequency (MHz)	OBW (kHz)	Limit (kHz)	Result
433.92	108	1084.8	PASS

