

VIPER[®] 500PC

AUTO SECURITY

Installation Guide

TABLE OF CONTENTS :

Installation Points to Remember	2	System Features Learn Routine	15
		To Access Another Feature In	
		The Same Menu	16
Harness Diagrams	3	To Select Another Men	16
Primary Harness	3	To exit the learn routine	16
Wire Connection Guide	4	System Feature Menus	17
Main Harness	4	Menu #1-Basic Features	17
Door Lock Outputs	7	Menu #2-Advanced Features	17
Door Lock Wiring Guide	8	Feature Descriptions	18
Positive-Triggered, Relay Driven		Basic Features	18
Systems (Type A)	8	Advanced Features	19
Negative-Triggered, Relay Driven		Transmitter/Receiver Learn Routine	20
Systems (Type B)	9	Table of Zones	21
Reversing Polarity (Type C)	10	Long-term event history	21
Aftermarket Actuators (Type D)	11	Optional Vehicle Recovery System	
Electrically Activated Vacuum (Type E)	11	Installation	22
One-Wire System. (Type F)	12	Rapid Resume Logic	23
Plug-In Harnesses	13	Troubleshooting	23
Super Bright LED	13		
Valet [®] /Program Switch	13		
Personal Computer Interface	13		
Four-Pin Shock Sensor Harness	13		
Internal Programming Jumpers	14		
Light Flash	14		
Learn enable: Valet [®] only	14		



- PC Programmable
- Rapid Resume Logic
- Owner Recognition



Directed Electronics, Inc.

© 1997 Directed Electronics, Inc. Vista, CA

Part No. 439V

Sidewinder

6000PC

Installation Guide

TABLE OF CONTENTS

Installation Points to Remember	2	System Features Learn Routine	15
Harness Diagrams	3	To Access Another Feature In	
Primary Harness	3	The Same Menu	16
Wire Connection Guide	4	To Select Another Men	16
Main Harness	4	To exit the learn routine	16
Door Lock Outputs	7	System Feature Menus	17
Door Lock Wiring Guide	8	Menu #1-Basic Features	17
Positive-Triggered, Relay Driven		Menu #2-Advanced Features	17
Systems (Type A)	8	Feature Descriptions	18
Negative-Triggered, Relay Driven		Basic Features	18
Systems (Type B)	9	Advanced Features	19
Reversing Polarity (Type C)	10	Transmitter/Receiver Learn Routine	20
Aftermarket Actuators (Type D)	11	Table of Zones	21
Electrically Activated Vacuum (Type E)	11	Long-term event history	21
One-Wire System, (Type F)	12	Optional Vehicle Recovery System	
Plug-In Harnesses	13	Installation	22
Super Bright LED	13	Rapid Resume Logic	23
Valet [®] Program Switch	13	Troubleshooting	23
Personal Computer Interface	13		
Four-Pin Shock Sensor Harness	13		
Internal Programming Jumpers	14		
Light Flash	14		
Learn enable, Valet [®] only	14		



- PC Programmable
- Rapid Resume Logic
- Owner Recognition



Directed Electronics, Inc.

1997 Directed Electronics, Inc. Vista, CA

Part No. 439S

Installation Guide

TABLE OF CONTENTS

Installation Points to Remember	2	System Features Learn Routine	15
		To Access Another Feature In	
Harness Diagrams	3	The Same Menu	16
Primary Harness	3	To Select Another Men	16
		To exit the learn routine	16
Wire Connection Guide	4	System Feature Menus	17
Main Harness	4	Menu #1-Basic Features	17
Door Lock Outputs	7	Menu #2-Advanced Features	17
Door Lock Wiring Guide	8	Feature Descriptions	18
Positive-Triggered, Relay Driven		Basic Features	18
Systems (Type A)	8	Advanced Features	19
Negative-Triggered, Relay Driven		Transmitter/Receiver Learn Routine	20
Systems (Type B)	9	Table of Zones	21
Reversing Polarity (Type C)	10	Long-term event history	21
Aftermarket Actuators (Type D)	11	Optional Vehicle Recovery System	
Electrically Activated Vacuum (Type E)	11	Installation	22
One-Wire System. (Type F)	12	Rapid Resume Logic	23
Plug-In Harnesses	13	Troubleshooting	23
Super Bright LED	13		
Valet®/Program Switch	13		
Personal Computer Interface	13		
Four-Pin Shock Sensor Harness	13		
Internal Programming Jumpers	14		
Light Flash	14		
Learn enable/Valet® only	14		



- PC Programmable
- Rapid Resume Logic
- Owner Recognition

Part No. 439P



Directed Electronics, Inc.

1997 Directed Electronics, Inc. Vista, CA

439 SERIES

Installation Guide

TABLE OF CONTENTS

Installation Points to Remember	2	System Features Learn Routine	15
Harness Diagrams	3	To Access Another Feature in	
Primary Harness	3	The Same Menu	16
Wire Connection Guide	4	To Select Another Menu	16
Main Harness	4	To exit the learn routine	16
Door Lock Outputs	7	System Feature Menus	17
Door Lock Wiring Guide	8	Menu #1-Basic Features	17
Positive-Triggered, Relay Driven		Menu #2-Advanced Features	17
Systems (Type A)	8	Feature Descriptions	18
Negative-Triggered, Relay Driven		Basic Features	18
Systems (Type B)	9	Advanced Features	19
Reversing Polarity (Type C)	10	Transmitter/Receiver Learn Routine	20
Aftermarket Actuators (Type D)	11	Table of Zones	21
Electrically Activated Vacuum (Type E)	11	Long-term event history	21
One-Wire System. (Type F)	12	Optional Vehicle Recovery System	
Plug-In Harnesses	13	Installation	22
Super Bright LED	13	Rapid Resume Logic	23
Valet [®] /Program Switch	13	Troubleshooting	23
Personal Computer Interface	13		
Four-Pin Shock Sensor Harness	13		
Internal Programming Jumpers	14		
Light Flash	14		
Learn enable/Valet [®] only	14		



- PC Programmable
- Rapid Resume Logic
- Owner Recognition

Part No. 439



Directed Electronics, Inc.

© 1997 Directed Electronics, Inc.

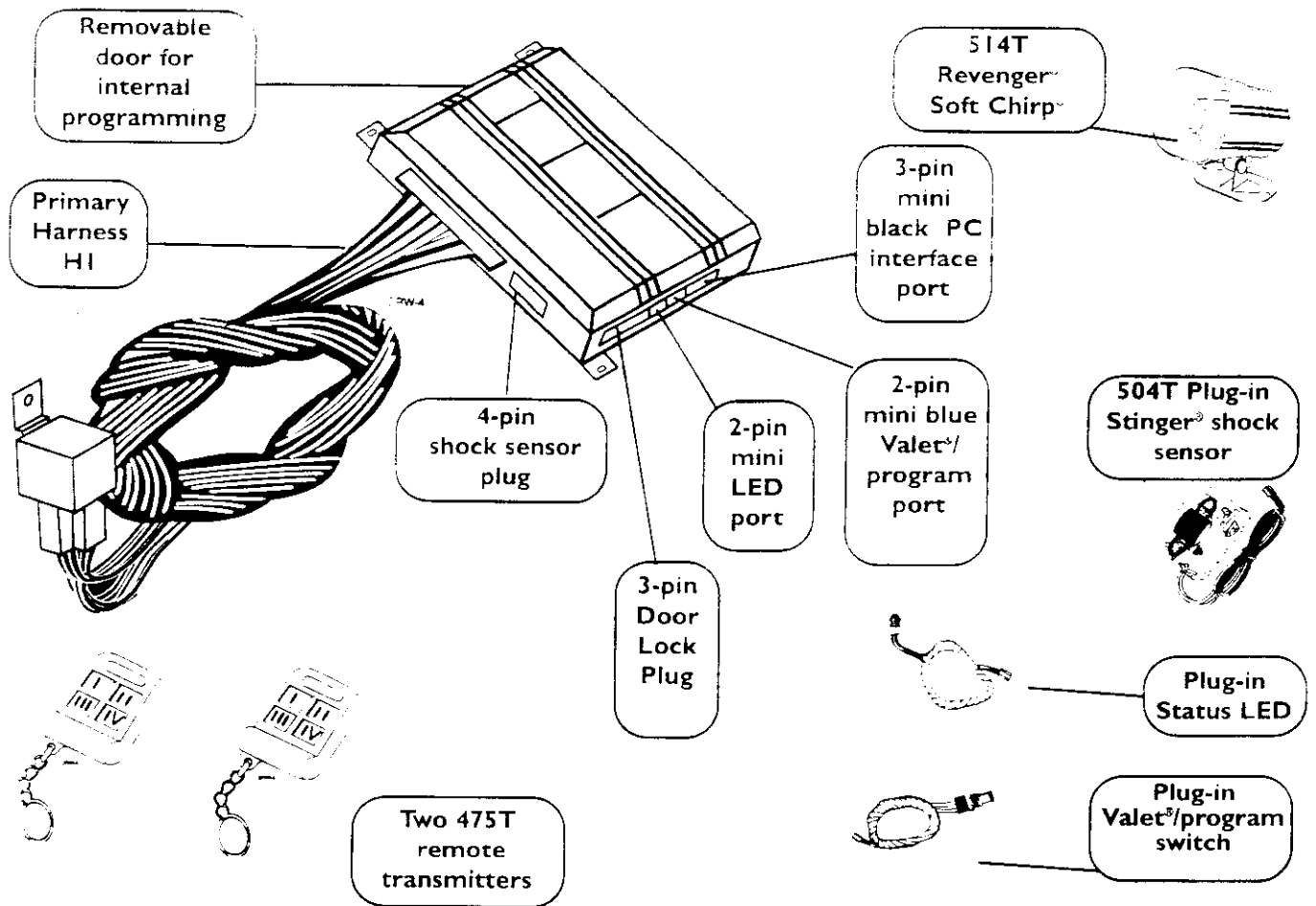

INSTALLATION POINTS TO REMEMBER

This product represents many years of research and development. It is very sophisticated and should be installed by experienced security installers only. Please do not attempt installation of this product without reading this guide. The system has been designed to provide the ultimate in security, coupled with limitless convenience and expansion options.

This product is not intended for consumer installation and will have NO WARRANTY unless it is installed by an authorized dealer.

Do not disconnect the battery if the vehicle has an anti-theft coded radio. If equipped with an air bag, avoid disconnecting the battery if possible.

IMPORTANT! Many airbag systems will display a diagnostic code through their warning light after they lose power. Disconnecting the battery requires this code to be erased, a procedure that can require a trip to the dealer.

Before beginning the installation:

- Check with the customer on Status LED location.
- Remove the dome light fuse. This prevents accidentally draining the battery.
- Roll down a window to avoid being locked out of the car.

After the install:

- Test all functions. The "Using Your System" section of the Owner's Guide is very helpful when testing.
- When testing, don't forget that this system is equipped with Nuisance Prevention® Circuitry. NPC™ can bypass both instant trigger zones, making them seem to stop working.

PRIMARY HARNESS H1, 12-PIN CONNECTOR

H1/1	ORANGE	(-) 500 mA ARMED OUTPUT
H1/2	WHITE	(+)/(-) SELECTABLE LIGHT FLASH OUTPUT
H1/3	WHITE/BLUE	(-) 200 mA CHANNEL 3 SELECTABLE OUTPUT
H1/4	BLACK/WHITE	(-) 200 mA DOMELIGHT SUPERVISION
H1/5	GREEN	(-) DOOR TRIGGER INPUT, ZONE 3
H1/6	BLUE	(-) INSTANT TRIGGER INPUT, ZONE 1
H1/7	VIOLET	(+) DOOR TRIGGER INPUT, ZONE 3
H1/8	BLACK	(-) CHASSIS GROUND INPUT
H1/9	YELLOW	(+) SWITCHED IGNITION INPUT, ZONE 5
H1/10	BROWN	(+) SIREN OUTPUT
H1/11	RED	(+) CONSTANT POWER INPUT
H1/12	RED/WHITE	(-) 200 mA CHANNEL 2 OUTPUT

WIRE CONNECTION GUIDE

This guide describes in detail the connection of each wire. Also included are possible applications of each wire. This system was designed with the ultimate in flexibility and security in mind. Many of the wires have more than one possible function. Please read carefully to ensure a thorough understanding of this unit.

Main Harness. 12-pin connector

H1/1 ORANGE (-) ground-when-armed output: This wire supplies a (-) ground as long as the system is armed. This output ceases as soon as the system is disarmed. The ORANGE wire is pre-wired to control the 8618 starter kill relay. It can supply up to 500 mA of current.

NOTE: If connecting the orange wire to control another module, such as a 529T or 530T window module, a 1 amp diode (type 1N4004) will be required (see below).

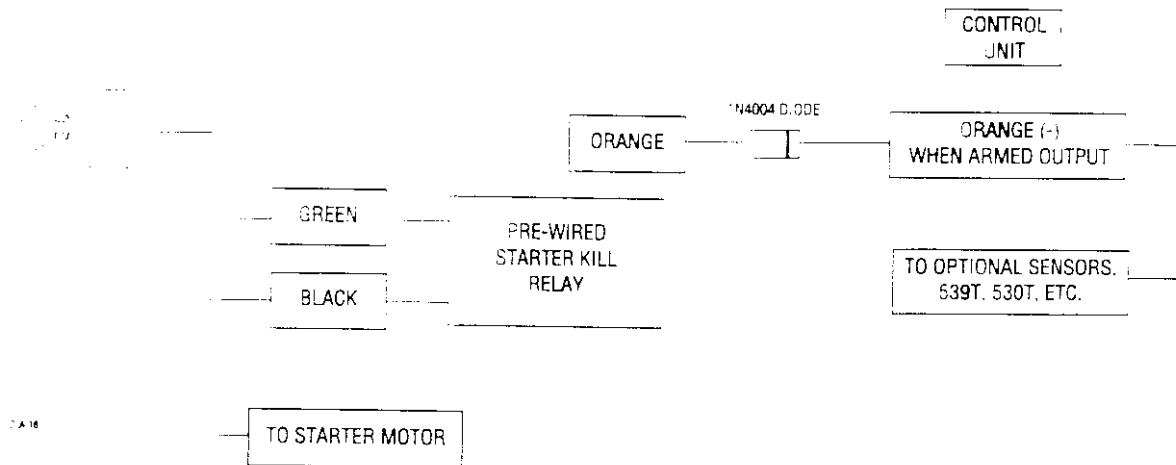

IMPORTANT! Never interrupt any wire other than the starter wire.

H1/2 WHITE light flash output: As shipped, this wire should be connected to the (+) parking light wire. If the light flash polarity jumper under the sliding door is moved to the opposite position (see Internal Jumpers, page 14), this wire supplies a (-) 200 mA output. This is suitable for driving (-) light control wires in Toyota, Lexus, BMW, some Mitsubishi, some Mazda, and other model cars.

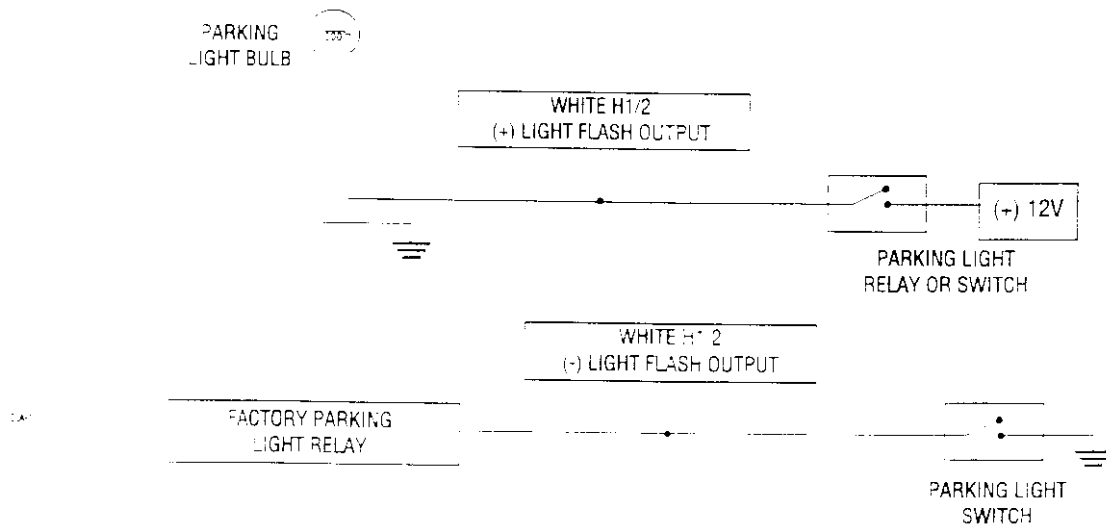

H1/3 WHITE/BLUE 200 mA (-) channel three output: This wire provides a 200 mA (-) output whenever the transmitter button(s) controlling channel three is pressed. This output can be programmed to provide the following type of outputs (see system features learn routine, page 15): A **validity** output will send a signal as long as the transmission is received. A **latched** output will send a signal continuously when channel three pressed and will continue until channel three is pressed again. A **latched/reset with ignition** output works similar to the latched output, but will also reset (output will stop) when the ignition is turned on then off. A **30 second timed output** will send a signal for 30 seconds when channel three is pressed. This output can also be programmed to provide a second unlock pulse when the disarm button is pressed within 15 second after disarming the system. This can be used to unlock the passenger doors when installing progressive door locks.

IMPORTANT! Never use this wire to drive anything but a relay or a low-current input! This transistorized output can only supply 200 mA, and connecting directly to a solenoid, motor, or other high-current device will cause the module to fail.

H1/4 BLACK/WHITE 200 mA (-) dome/night-supervision output: Connect this wire to the optional dome/night supervision relay as shown below:

IMPORTANT! This output is only intended to drive a relay. It cannot be connected directly to the dome/night circuit, as the output cannot support the current draw of one or more bulbs.

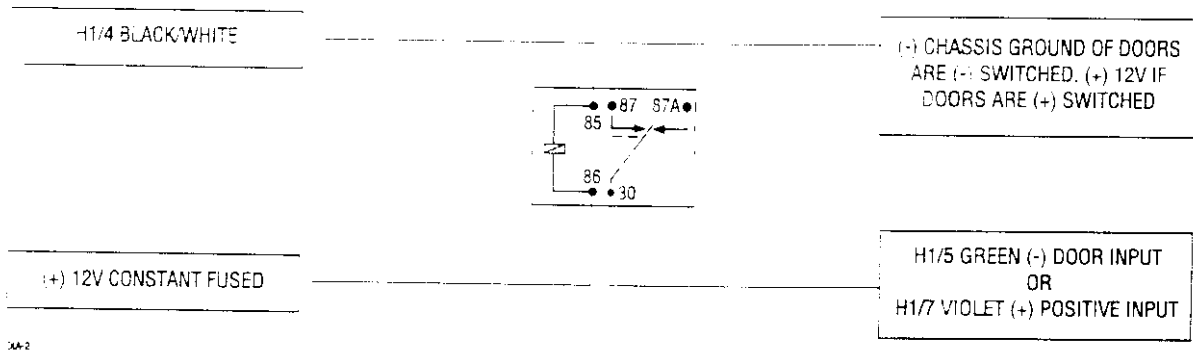

H1/5 GREEN (-) door trigger input: Most vehicles use negative door trigger circuits. Connect the GREEN wire to a wire which shows ground when any door is opened. In vehicles with factory delays on the dome/night circuit, there is usually a wire that is unaffected by the delay circuitry.

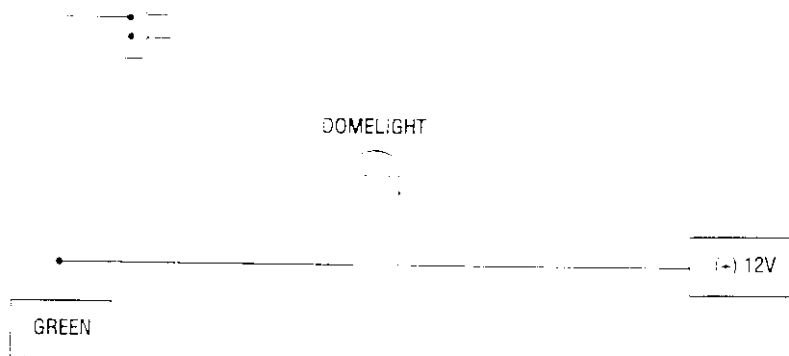

H1/6 BLUE (-) instant trigger: This input will respond to a negative input with an instant trigger. It is ideal for hood and trunk pins and will report on zone one. It can also be used with 506T Glass Breakage Sensor, as well as other DEIT single stage sensors.

H1/7 VIOLET (-) door trigger input: This type of dome circuit is used in many Ford products. Connect the VIOLET wire to a wire that shows (+)12V when any door is opened, and ground when the door is closed.

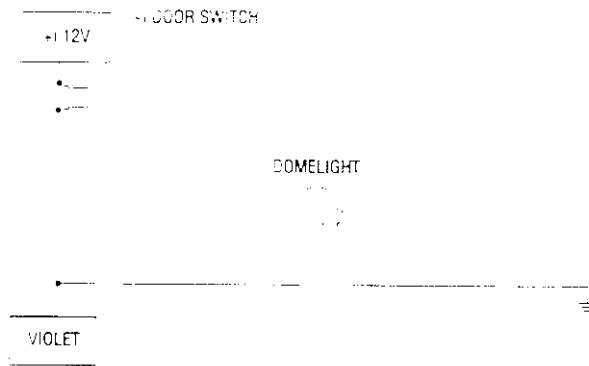

H1/8 BLACK (-) chassis ground connection: Connect this wire to bare metal, preferably with a factory bolt rather than your own screw. Screws tend to either strip or loosen with time. We recommend grounding all your components, including the siren, to the same point in the vehicle.

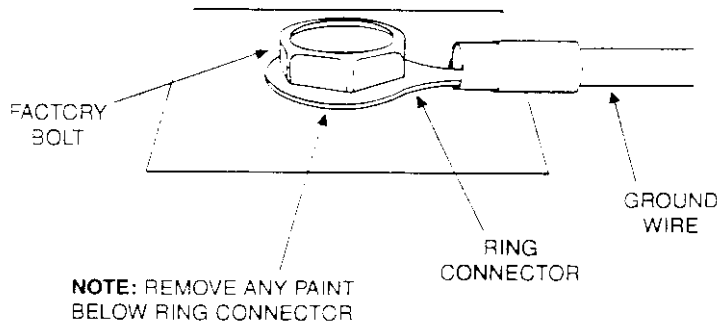

H1/9 YELLOW (+) ignition input: Connect this wire to the (+)12V ignition wire. This wire is pre-wired to the starter kill relay and must show (+)12V with the key in Run position and during cranking. Take great care that this wire cannot be shorted to the chassis at any point.

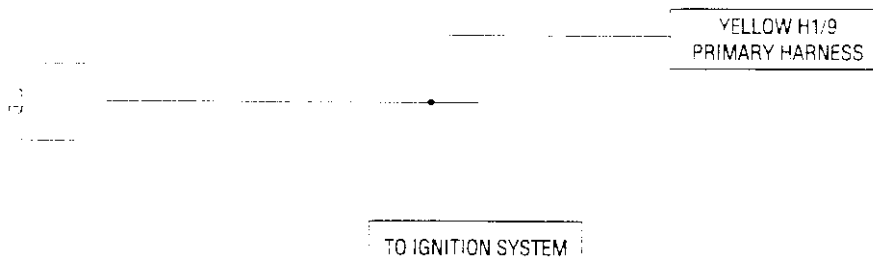

H1/10 BROWN (+) siren output: Connect this to the RED wire of the 514T Revenger[®] siren. Connect the BLACK wire of the siren to (-) chassis ground, preferably at the same point you connect the control module's BLACK ground wire.

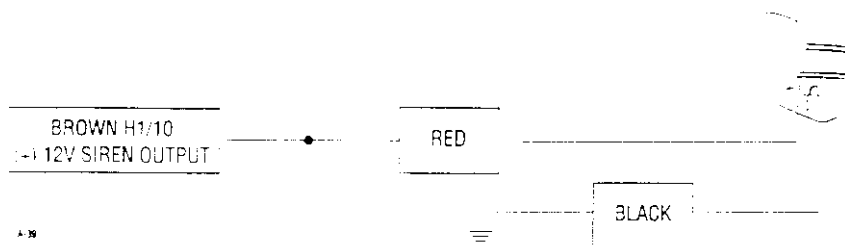

H1/11 RED (+) 12V constant power input: Before connecting this wire, remove the supplied fuse. Connect to the battery positive terminal or the constant 12V supply to the ignition switch.

NOTE: Always use a fuse within 12 inches of the point you obtain (+)12V. Do not use the 10A fuse in the harness for this purpose. This fuse protects the module itself.

H1/12 RED/WHITE 200 mA (-) channel 2 output: When the system receives the code controlling channel 2 for longer than 1.5 seconds, the RED/WHITE will supply an output as long as the transmission continues. This is often used to operate a trunk hatch release or other relay/driven function.

IMPORTANT! Never use this wire to drive anything but a relay or a low-current input! The transistorized output can only supply 200 mA of current. Connecting directly to a solenoid, motor, or other high-current device will cause it to fail.

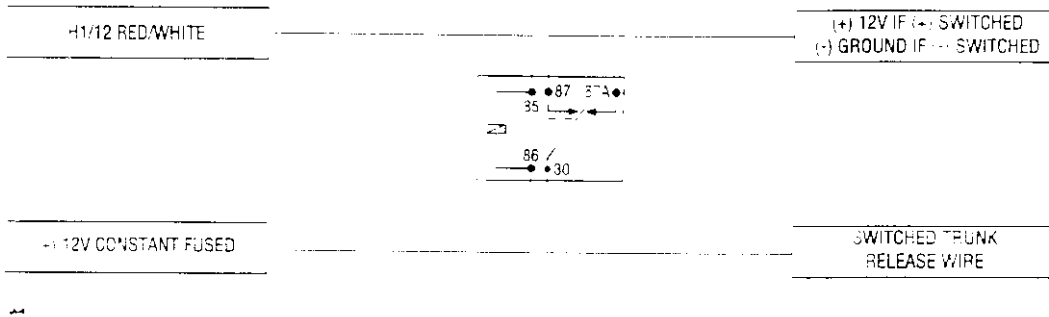

HARNESS 2, (+/-) DOOR LOCK OUTPUTS

H2/A	GREEN	(-) LOCK, (+) UNLOCK OUTPUT
H2/B	EMPTY	UNLESS USING 451M
H2/C	BLUE	(-) UNLOCK. (+) LOCK OUTPUT

This system can control two common power door lock types without any additional parts! With certain vehicles, or if an actuator is to be installed, either a 451M Door Lock Relay Satellite or two relays will be required.

IMPORTANT! If you mistake a Type C direct-wired system for a Type A positive-pulse system, the module will be damaged!

DOOR LOCK WIRING GUIDE

Type A - (+) 12V pulses from the switch to the factory relays

The system can control a Type A system directly, with no additional parts. The switch will have three wires on it, and one will test (+)12V constantly. The others will alternately pulse (+)12V when the switch is pressed to the lock or unlock position.

If you cannot get to the switch, and you find a set of wires that pulse (+)12V alternately on lock and unlock, you must take care to ensure that it is not a Type C direct-wire system.

Here is a test: Cut the wire which pulses (+)12V on lock, and then operate the switch to unlock. If all doors unlock, the vehicle uses type A system. If you lose all door lock operation in both directions, you are operating the master switch in a Type C system.

If you lose all door lock operation of one or more doors, but not all motors stop operating, and other doors still work, you have cut a wire leading directly to one or more motors. You must instead find the actual wires leading to the switch.

Many domestically-made GM vehicles use Type A locks. However, many more GM vehicles are Type C than in previous years. The full-size pickups (1989-up), many of the S10 Blazers, the Corvette, 1995 Cavalier/Sunfire 1993 - and newer, Camaro, Firebird all use Type C door locks, and cannot be controlled without a 451M! Almost all domestically-built Fords are Type C. Ford builds very few Type A systems. Chrysler builds both Type A and Type C, so use caution.

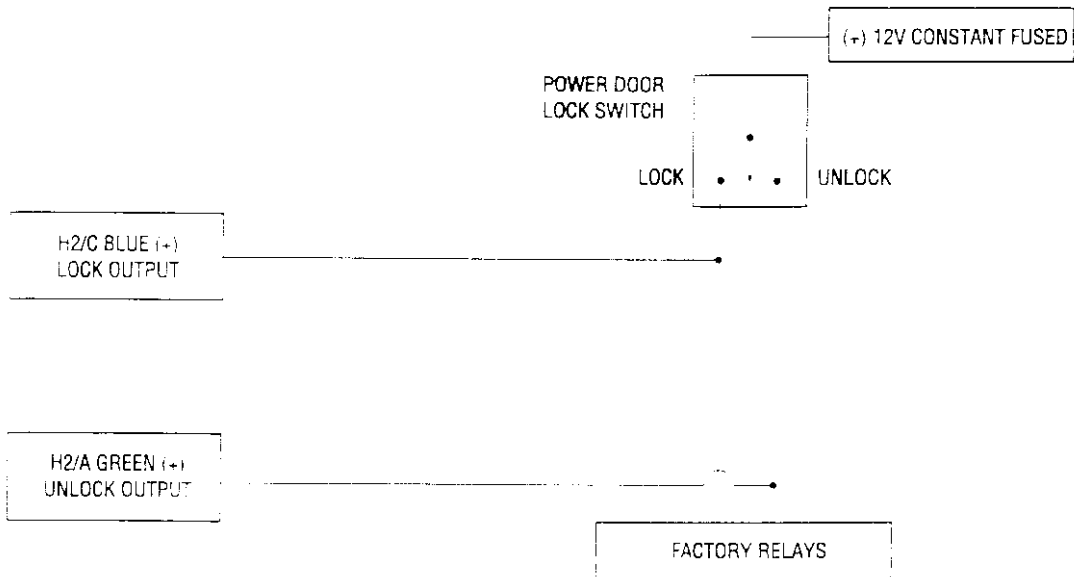

Type B (-) pulses from the switch to the factory relays

This system is common in many Toyota, Nissan, Honda, and Saturn models, as well as Fords with the keyless-entry system (some other Fords also use Type B).

The switch will have three wires on it, and one wire will test ground all the time. One wire will pulse (-) when the switch locks the doors, and the other wire will pulse (-) when the switch unlocks the doors. This type of system is difficult to mistake for any other type.

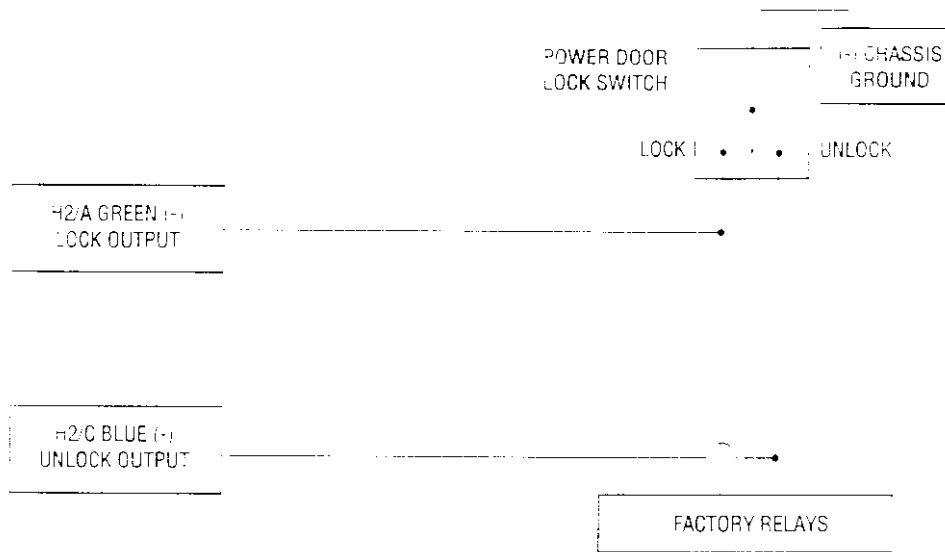

Type C - Reversing Polarity

Interfacing with a reversing polarity system requires either two relays or one 451M (not included).

It is critical to identify the proper wires and locate the master switch to interface properly. Locate wires that show voltage on lock and unlock. Cut one of the suspect wires and check operation of the locks from both switches. If one switch loses operation in both directions and the other switch operates in one direction only, you have located one of the target wires. The switch that lost all operation is the master switch. If one switch works both directions and the other switch works only one direction, you have a Type A system. If both switches still operate, but one or more doors have stopped responding entirely, you have cut a motor lead. Reconnect it and continue to test for another wire. Once both wires have been located and the master switch identified, cut both wires and interface as shown below.

IMPORTANT! If these are not connected properly, you will send (+) 12 volts directly to (-) ground, possibly damaging the alarm or the factory switch.

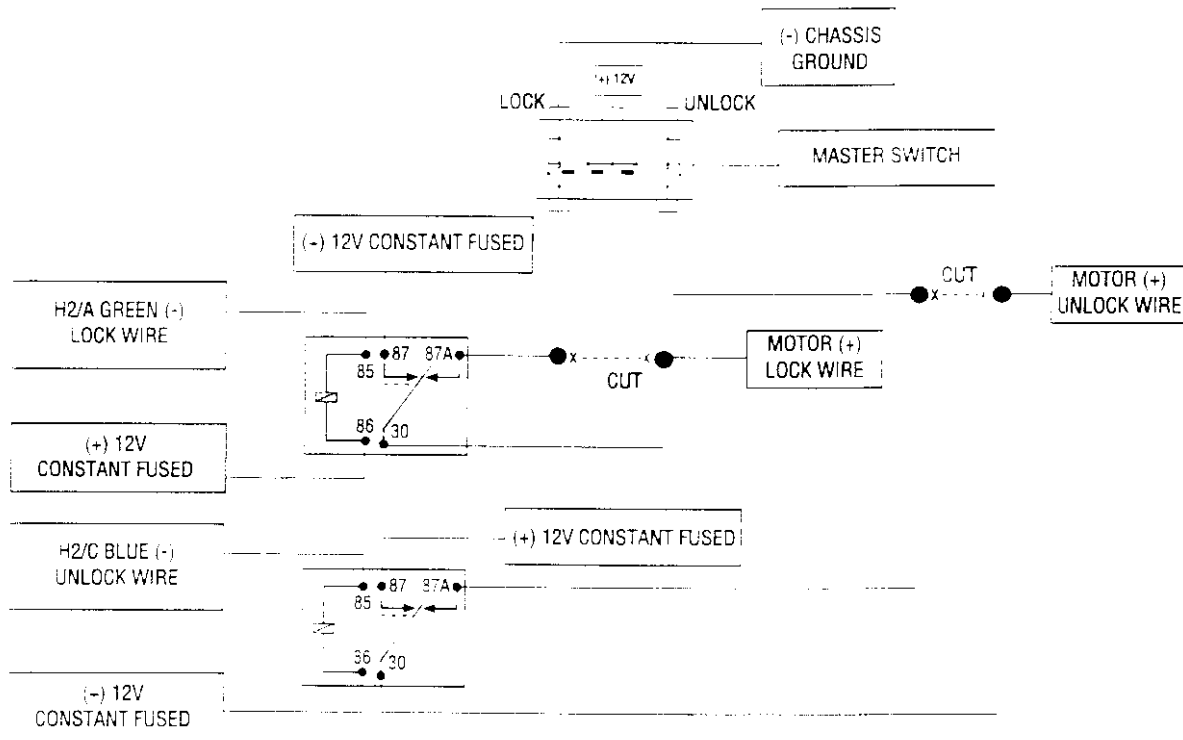

4-12

Type D - Aftermarket Actuators

In order for this system to control one or more aftermarket actuators, a 451M or two relays (optional) are needed.

Vehicles without factory power door locks require the installation of one actuator per door. This requires mounting the door lock actuator inside the door. Other vehicles may only require one actuator installed in the driver's door if all door locks are operated when the driver's lock is used. This type of installation is required to operate factory lock systems in Volvo (except 850), SAAB, and most Mazda, Isuzu and Subaru models. The fuse used on 12-volt inputs should be 7.5A per motor installed in the vehicle.

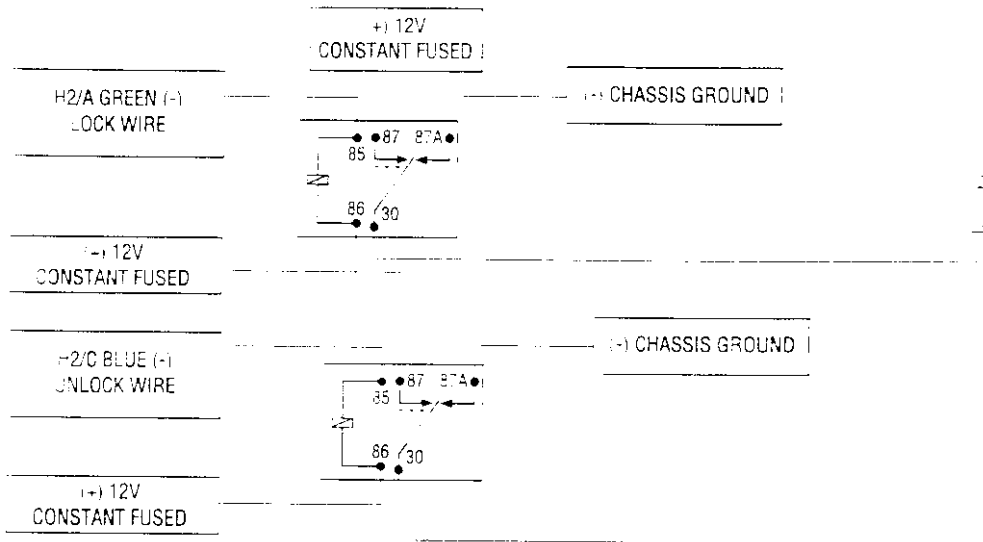

1A-13

Type E - Mercedes-Benz and Audi (1985 & Newer)

Door locks are controlled by an electrically activated vacuum pump. Some Mercedes and Audi models use a Type D system. Test by locking doors from the passenger key cylinder. If all the doors lock, the vehicle's door lock system can be controlled with just two relays (optional). The control wire can be found in either kick panel and will show (+) 12V when doors are unlocked and (-) ground when doors are locked.

To interface, see diagram below. The system must be programmed for 3.5 second door lock pulses (see System Features Learn Routine, page 15).

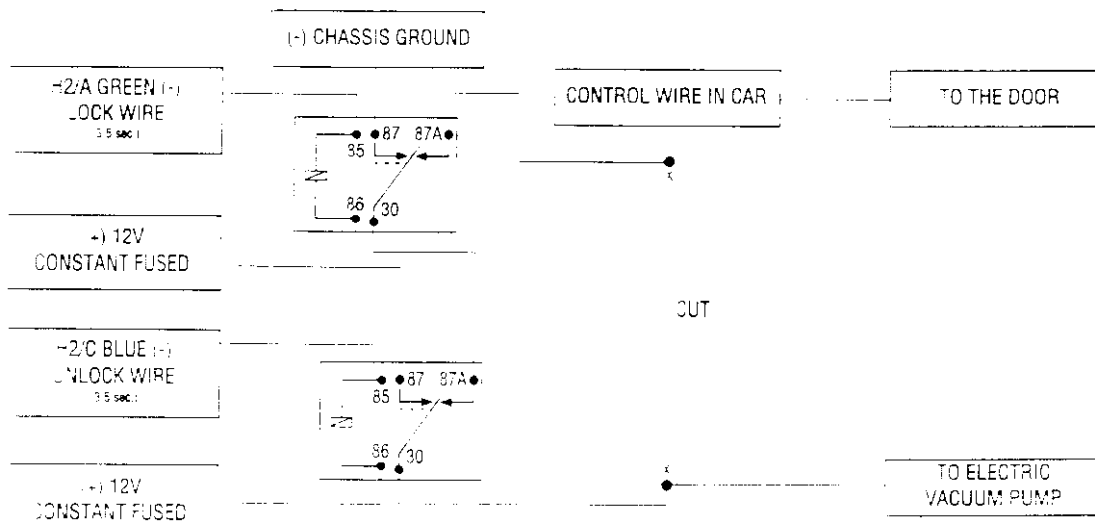

Type F - One-Wire System

This system usually requires a negative pulse to unlock, and cutting the wire to lock the door. In some vehicles, these are reversed. It is found in late-model Nissan Sentras, some Nissan 240SX, and Nissan 300ZX 1992-up. It is also found in some Mazda MPV's and some Mitsubishi's.

One relay (optional) is used to interface to this type of system as follows:

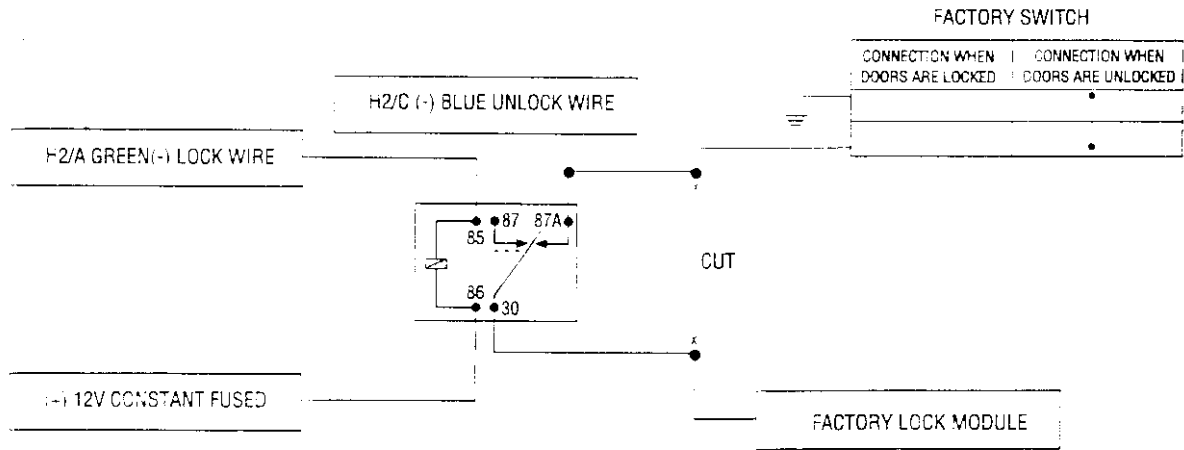

A-15

PLUG-IN HARNESSES

Super Bright LED. 2-pin white plug

The super bright LED operates at 2V DC. Make sure the LED wires are not shorted to ground as the LED will be damaged. Multiple LED's can be used, but they must be wired in series. The LED fits into a 9/32 inch mounting hole. Be sure to check for clearance prior to drilling the mounting hole.

Valet®/program Switch. 2-pin blue plug

The Valet®/program switch should be accessible from the driver's seat. It plugs into the blue port on the side of the unit. Since the system features Valet® by Remote, the switch can be well hidden. Consider what the switch will be used for before choosing a mounting location. Check for rear clearance before drilling a 9/32 inch hole and mounting the switch. The GRAY wire in the two-pin plug may also be used as a (+) ghost switch input and can be connected to any (+) switch in the vehicle (see Feature Descriptions, page 19).

Personal Computer Interface. 3-pin black plug

The black three pin port is provided for personal computer programming of the unit. When using the optional PC Interface module, part number 996T, it is possible to configure any and all of the programmable functions using an IBM-compatible personal computer. For more information please refer to the guide packaged on the disk with the 996T.

FOUR-PIN SHOCK SENSOR HARNESS

GREEN (-) Multiplex input: Inputs shorter than 0.8 seconds will trigger the Warn Away® response, while inputs longer than 0.8 seconds will trigger full alarm sequence and report zone four. If installing an optional DEI® dual stage sensor, connect to the GREEN wire as shown below. The diagram below eliminates the need for diodes to isolate the sensors, as well as providing a separate zone for each sensor.

Diagram for adding optional DEI® dual stage sensor to GREEN wire (zone 4)

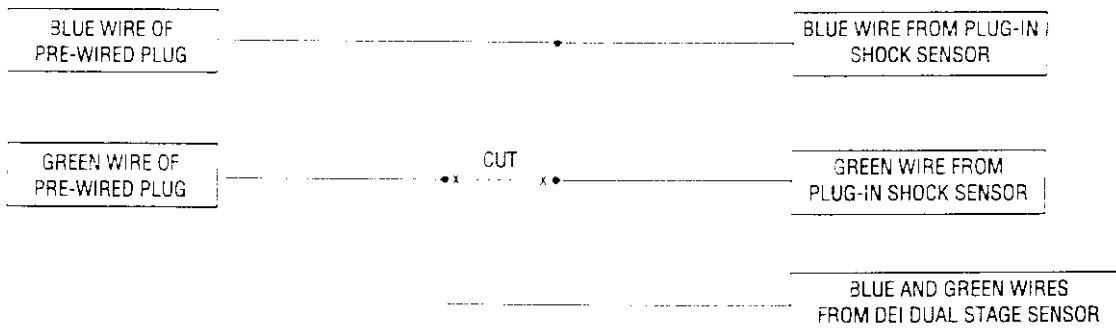

1A3

BLUE (-) Multiplex input: Inputs shorter than .8 seconds will trigger the Warn Away® response, while inputs longer than 0.8 seconds will trigger full alarm sequence and report zone two.

RED, BLACK: RED is (+)12V constant. BLACK is (-) ground. Do not use these for anything besides the plug-in shock sensor.

INTERNAL PROGRAMMING JUMPERS

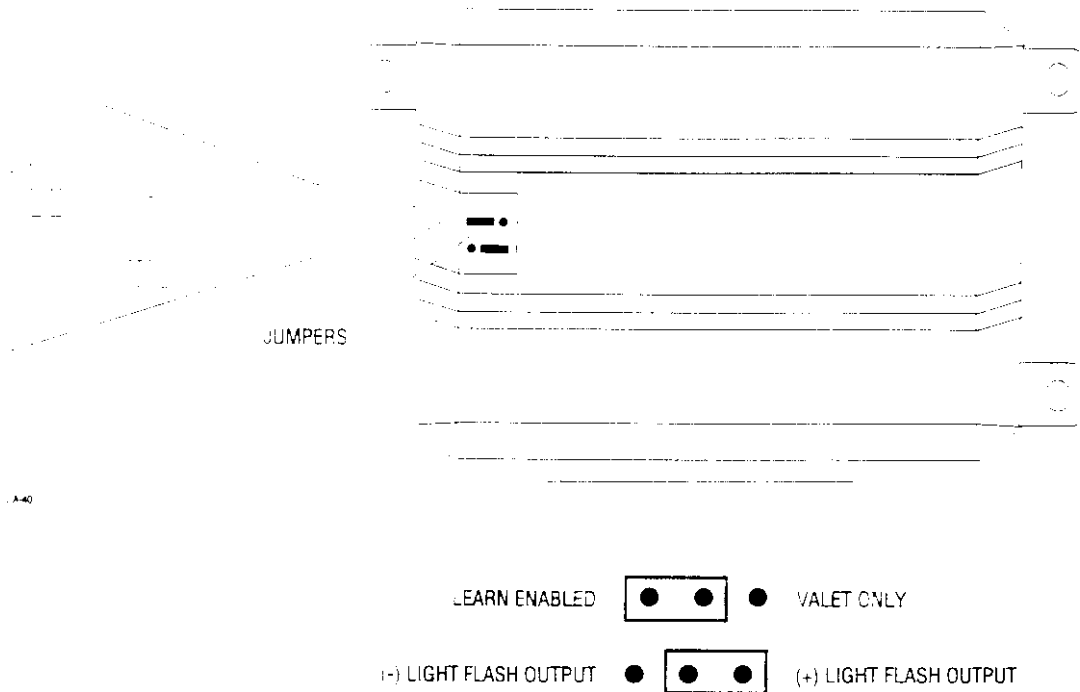

LIGHT FLASH JUMPER: This jumper is used to determine the light flash output. In the (+) position, the on-board relay is enabled and the unit will output (+)12V on the WHITE wire, H1/2. In the (-) position, the on-board relay is disabled. The WHITE wire, H1/2, will supply a 200 mA (-) output suitable for driving factory parking light relays.

LEARN ENABLE/VALET® ONLY JUMPER: In the Learn enable position (L), you can use the Valet®/program switch to access both the Learn Routine™ and Valet® mode. In the Valet® only position (V), the Valet®/program switch will only function as a Valet® switch. Entering Learn Routine™ is not possible with the jumper in the (V) position.

SYSTEM FEATURES LEARN ROUTINE

The System Features Learn Routine dictates how the unit operates. Due to the number of steps, they have been broken up into two menus. It is possible to access and change any of the feature settings using the Valet®/program switch. However, this process can be greatly simplified by using the optional Personal Computer Interface, part number 996T. Any of the settings can be changed and then assigned to a particular transmitter, up to four, a feature called Owner Recognition. Each time that particular transmitter is used to disarm the system, the assigned feature settings will be recalled. Owner Recognition is only possible when programming the unit via the 996T.

To access the System Features Learn Routine, the jumper under the sliding door must be in the (L) position. To enter the System Features Learn Routine:



1. **Open a door:** The GREEN wire, H1/5, or the VIOLET, H1/7 must be connected.



2. **Turn the ignition on, then off:** The YELLOW wire, H1/9 must be connected.



3. **Select a menu:** Press and HOLD the Valet®/program button. The Valet®/program button must be plugged into the blue port. After three seconds the siren will chirp once indicating entry to the Basic Features Menu. If this is the menu you wish to access, release the button and go on to step 4. If the button is not released, you will jump to the Advanced Features Menu and the siren will chirp twice. Once you have selected the desired menu, release the program button, then go to step four.



4. **Select a feature:** Press and release the Valet®/program button the number of times corresponding to the step you wish to change. For example, to access the third feature, press and release three times. Then press the button once more and HOLD it. The siren will chirp the number of times equal to the step you have accessed.

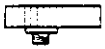

5. **Program the feature:** While holding the Valet®/program button, you can toggle the feature on and off using the remote transmitter. Pressing the button that arms the system will select the one chirp or default setting. Pressing the button that is assigned to channel 2 (or the disarm only button when in OEM configuration, see Transmitter/Receiver Learn Routine, page 20), will select the two chirp setting.

NOTE: The Valet® pulse count feature (2-5) and the Channel three timed output (2-9) have five possible settings each. Pressing channel 2 will toggle through all the possible settings.



6. **Release the Valet®/program button.**

Once the feature is programmed:

- other features can be programmed within the same menu.
- another menu can be selected.
- the Learn Routine can be exited if programming is complete.

To access another feature in the same menu

Press and release the Valet®/program button the number of times necessary to advance from the feature you just programmed to the next one you want to program. Then press the Valet®/program button once more and hold it. For example, if you just programmed the third feature in the menu and you would like to program the seventh feature in the menu, you would: Press and release the Valet®/program button four times. Then press it once more and hold it. The siren would chirp seven times to confirm access to the seventh feature.

To select another menu

Press and hold the Valet®/program button. After three seconds, the unit will advance to the next menu and the siren will chirp, indicating which menu has been accessed. For instance, if you just programmed some features in the first menu (Basic Features) and you desire to program a feature in the second menu, you press and hold the Valet®/program button. After three seconds, the siren chirps twice indicating access to the second menu.

To exit the learn routine

Do one of the following:

1. Close the open door
2. Turn the ignition on
3. No activity for longer than 15 seconds
4. Press the Valet®/program button too many times

SYSTEM FEATURES MENUS

items in **bold** text have been programmed to the two chirps setting at the factory.

Menu #1- Basic Features

Step	One Chirp (Default)	Two Chirps
1-1	Active arming	Passive arming
1-2	Audible arm/disarm confirmation on	Audible Arm/disarm confirmation off
1-3	Ignition-controlled door locks on	Ignition-controlled door locks off
1-4	Active locking	Passive locking
1-5	Panic with ignition on	No panic with ignition on
1-6	0.8 second door lock pulses	3.5 second door lock pulses
1-7	Forced passive arming on	Forced passive arming off
1-8	Automatic engine disable on	Automatic engine disable off
1-9	Armed while driving	Vehicle Recovery System(VRS®)
1-10	Code-Hopping™ on	Code-Hopping™ off

Menu #2- Advanced Features

Step	One Chirp (Default)	Two Chirps
2-1	Siren	Horn honk
2-2	30 second siren duration	60 second siren duration
2-3	Nuisance Prevention® Circuitry on	Nuisance Prevention® Circuitry off
2-4	Progressive door trigger	Instant door trigger
2-5	Valet switch input - 1 pulse	Valet switch input - 2-5 pulses
2-6	Door trigger error chirp ON	Door trigger error chirp OFF
2-7	Ignition-controlled domelight on	Ignition-controlled domelight off
2-8	Single unlock pulse	Double unlock pulse
2-9	Channel 3 - Validity	Channel 3 - latched/latched reset with ignition timed- 30 seconds/second unlock output

FEATURES DESCRIPTIONS

Basic Features

1-1 ACTIVE/PASSIVE ARMING: When active arming is selected, the system will only arm when the transmitter is used. When set to passive, the system will arm automatically 30 seconds after the last door is closed. To alert the consumer of passive arming, the siren will chirp 20 seconds after the door is closed. This provides the consumer with an audible warning prior to the system actually arming. At the 30 second mark, the system will arm but the siren will not chirp.

1-2 AUDIBLE ARM/DISARM CONFIRMATION ON/OFF: This feature controls the chirps or voice messages (if using the 516M voice module) that confirm the arming and disarming of the system.

1-3 IGNITION-CONTROLLED DOOR LOCKS ON/OFF: When turned on, the doors will lock three seconds after the ignition is turned on and unlock when the ignition is turned off.

1-4 ACTIVE/PASSIVE LOCKING: If passive arming is selected in step 1-1, then the system can be programmed to either lock the doors when passive arming occurs, or only lock the doors when the system is armed via the transmitter. Active locking means the system will not lock the doors when it passively arms. Passive locking means that the system will lock the doors when it passively arms.

NOTE: Remember, when passive arming is selected, the unit will chirp 20 seconds after the last door is closed. The system does not actually arm or lock the doors until 30 seconds after the door has been closed.

1-5 PANIC WITH IGNITION ON: This step controls whether or not the Panic Mode is available with the ignition on. In some states, there are laws prohibiting a siren sounding in a moving vehicle. This feature makes the system compliant with these regulations.

1-6 DOOR LOCK PULSE DURATION: Some European vehicles, such as Mercedes-Benz and Audi, require longer lock and unlock pulses to operate the vacuum pump. Programming the system to provide 3.5 second pulses, will accommodate the door lock interface in these vehicles. The default setting is 0.8 second door lock pulses.

1-7 FORCED PASSIVE ARMING ON/OFF: To use this feature, passive arming must be selected in step 1-1. When turned on, forced passive arming will ensure that the system will passively arm, even if a zone is left open or invalid. Forced passive arming occurs one hour after the ignition is turned off.

1-8 AUTOMATIC ENGINE DISABLE (AED) ON/OFF: AED is a full-time, passive starter disable that works independently of the security system. When turned on, the ORANGE, ground-when-armed output (H1/1) will go active 30 seconds after the ignition is turned off. The LED will flash at half its normal rate when the ignition is turned off to indicate that AED is active and will interrupt the starter in 30 seconds. AED does not occur in Valet® mode and can be bypassed using the emergency override procedure. The transmitter can be used to disarm AED. However, the system must be armed and then disarmed, using the transmitter, to disarm AED.

1-9 ARMED WHILE DRIVING/VEHICLE RECOVERY SYSTEM: In the default setting (Armed While Driving), the system can be armed with the ignition on. When armed, the ground-when-armed is not active and the sensors are bypassed. The door triggers will remain active. If programmed to the Vehicle Recovery System (VRS®) setting, VRS will be activated.

1-10 CODE-HOPPING™ ON/OFF: The system uses a mathematical formula to change its code each time the transmitter and receiver communicate. This makes the group of bits or "word" from the transmitter very long. The longer the word is, the easier it is to block its transmission to the unit. Disabling the Code-Hopping™ feature lets the receiver ignore the Code-Hopping™ part of the transmitted word. As a result, the unit may have better range with Code-Hopping™ off.

FEATURES DESCRIPTIONS

Advanced Features

2-1 SIREN/HORN HONK: The system can be programmed to output pulses instead of a continuous output when the system is triggered. This is useful to honk the factory horn in applications where a siren is undesirable. Remember that the unit is only capable of supplying 1 amp of current. A relay will be required to interface with most factory horn systems.

2-2 SIREN DURATION 30/60 SECONDS: It is possible to program the unit to sound for 30 or 60 seconds during the triggered sequence. Some states have laws regulating how long a security system can sound. The default setting is 30 seconds.

2-3 NUISANCE PREVENTION[®] CIRCUITRY (NPC™) ON/OFF: NPC™ stops repeated triggering of the same zone. If one zone is triggered three times in one hour, that zone is bypassed for one hour, starting from the time of the third trigger. During that hour, if the system sees a trigger on that zone again, the system resets the one hour timer. If one hour passes and the zone has not triggered again, the zone is activated and can trigger the system again. NPC™ only monitors sensor inputs, and does not bypass the door trigger or the ignition trigger at any time. If NPC™ is turned off, the system will respond to repeated triggers on the sensor inputs and will do so indefinitely. Some states have laws regulating how many times a security system can trigger before it is considered a nuisance and the vehicle is towed away.

2-4 PROGRESSIVE DOOR TRIGGER ON/OFF: The system responds to a door trigger input with a progressive response. When the door is opened with the system armed, the siren will chirp 10 times prior to the full triggered sequence. The door trigger is still treated as an instant trigger and closing the door quickly will not prevent a full triggered sequence from occurring. If the progressive door trigger is programmed off, the full siren output will occur the moment the door is opened.

2-5 VALET PULSE COUNT 1-5 PULSES: The system can be programmed to count the number presses of the valet switch before disarming the security system or VRS[®]. The factory default setting is one pulse. The unit can be set for 2-5 pulses using Button II to select the setting.

Ghost Switch option: For added security, the **GRAY** wire on the two-pin Valet[®]/program can be connected to any switch in the vehicle that provides a positive (+) momentary pulse.

2-6 DOOR TRIGGER ERROR CHIRP ON/OFF: With the door trigger error chirp programmed off, the system will not report an invalid zone on arming when the door trigger wire is active. This eliminates the extra chirps that occur when interfacing with vehicles that have exceptionally long dome light delay circuits.

2-7 IGNITION-CONTROLLED DOME LIGHT SUPERVISION ON/OFF: If turned on, the system will turn on the dome light for 30 seconds when the ignition is turned off. The optional dome light supervision feature must be installed.

2-8 DOUBLE PULSE UNLOCK ON/OFF: Some vehicles require two pulses on a single wire to unlock the doors. When the double pulse unlock feature is turned on, the BLUE H2/C wire will supply two negative pulses instead of a single pulse. At the same time, the GREEN H2/A wire will supply two positive pulses instead of a single pulse. This makes it possible to directly interface with double pulse vehicles without any extra parts.

2-9 CHANNEL 3 VALIDITY/LATCHED/LATCHED RESET WITH IGNITION/30 SECOND TIMED/SECOND UNLOCK OUTPUT: Channel 3 can be programmed for these output configurations. The unit is set to the default validity output. To change the configuration, use Button II to toggle to the different settings.

TRANSMITTER/RECEIVER LEARN ROUTINE

The system comes with two transmitters that have been taught to the receiver. The receiver can store up to 4 different transmitter codes in memory. Use the following learn routine to add transmitters to the system or to change button assignments if desired.



1. Open a door: The GREEN wire, H1/5, or the VIOLET, H1/7 must be connected.



2. Turn the ignition on: The YELLOW wire, H1/9 must be connected.

3. Select the receiver channel: Press and release the Valet® program button the number of times necessary to access the desired channel.

NOTE: If adding a remote, a button must be taught to the unit in the channel one or channel four position prior to programming other channels.

Press and hold the Valet®/program button once more. The siren will chirp and the LED will blink the number of times corresponding to the channel that is accessed.

<i>Channel #</i>	<i>Function</i>	<i>Wire Color</i>
1	Arm/ Disarm/ Panic	
2	Silent Mode™/ Remote Valet®/ Trunk Release	RED/WHITE
3	Remote Start or other accessories	WHITE/BLUE
4	Arm only	
5	Disarm only	
6	Panic only	
7	Delete all transmitters	



4. Press the transmitter button: While holding the Valet®/program button, press the button from the transmitter that you wish to assign to that channel. The unit will chirp indicating successful programming. It is not possible to teach a transmitter button to the system more than once.

Channel #4-6: To configure the system's remote transmitters for OEM mode, channels four through six are used to assign the arm, disarm, and panic functions to separate buttons on the remote control. If the remote transmitter being used has already been programmed to the system it will be necessary to delete all transmitters (see channel 7 below) before that transmitter can be programmed to channels 4-6.

Channel #7: If any transmitter button from a known transmitter is programmed to channel 7, all transmitters will be erased from memory, and system features will return to factory default settings. This is useful in cases where the one of the customer's transmitters is lost or stolen. This will erase any lost or stolen transmitters from the system's memory. It can also be used to start from scratch if the transmitter buttons were programmed incorrectly.

TABLE OF ZONES

When using the diagnostic functions, use the Table of Zones to see what input has triggered the system. It is also helpful in deciding what input to use when connecting optional sensors and switches.

<u>Zone #</u>	<u>Trigger Type</u>	<u>Input Description</u>
One	Instant	H1/6 BLUE wire. Connect to optional hood/trunk pins.
Two	Multiplex	Blue wire of plug-in shock sensor. Inputs shorter than 0.8 seconds will trigger a Warn Away [®] response, while inputs longer than 0.8 seconds will instantly trigger full alarm sequence.
Three	Two-stage, progresses from warning to full alarm	Door switch circuit. H1/5 GREEN or H1/7 VIOLET.
Four	Multiplex	GREEN wire of plug-in shock sensor. Inputs shorter than 0.8 seconds will trigger a Warn Away [®] response, while inputs longer than 0.8 seconds will instantly trigger full alarm sequence.
Five	Two-stage (similar to doors)	Ignition input. H1/9 YELLOW.

The Warn Away[®] response does not report on the LED.

Long-term event history

The system stores the last two full triggers in memory. These are not erasable. Each time the unit sees a full trigger, the older of the two triggers in memory will be replaced by the new trigger. To access long-term event history:



1. Turn on the ignition.
2. Press and hold the Valet[®]/program switch.

The LED will flash in groups, indicating the last two zones that triggered the unit.

NOTE: The Warn Away[®] triggers are not stored to memory.

OPTIONAL VEHICLE RECOVERY SYSTEM (VRS®)

No additional parts are required to add the optional VRS feature. However for the VRS® feature to be effective, the 8618 starter kill relay must be installed. The VRS feature can be activated with the remote transmitter and deactivated with the valet switch. If the VRS option is selected it is recommended to program the Valet switch to respond to more than one pulse for maximum security. (see System Features Learn Routine, page 15)

To arm VRS:



1. Turn the ignition to the ON position.



2. Press the ARM button for 1 second.

The parking light will flash once and the siren will chirp once to confirm that the VRS system is armed and will enter the trigger sequence next time a door is opened then closed.

To disarm VRS (before siren begins chirping):



1. Turn the ignition to the ON position



2. Press the ARM button for 1 second.

The parking lights will flash twice and the siren will chirp twice to confirm that the VRS® system is disarmed.

To disarm VRS® (after siren has begun chirping):



1. Turn the ignition to the ON position.



2. Press and release the Valet®/program switch the selected number of times programmed in step 2-5 (see System Features Learn Routine, page 15).

NOTE: For a detailed explanation to the VRS triggered sequence, refer to the Vehicle Recovery System section of the Owner's Guide.

RAPID RESUME LOGIC

When the security system is powered back up, it will come back to the same state it was in when power was lost. For example, if power is disconnected during its full trigger sequence, when power is reconnected to the unit it will remain in the full trigger sequence. If power is disconnected while the unit is disarmed, it will power back up disarmed. This also applies to the VRS sequence. If the unit loses power at any time during the VRS sequence, when the unit is powered back up it will automatically go to the VRS full trigger sequence.

TROUBLESHOOTING

Starter kill doesn't work:

Is the correct starter wire being interrupted? If the car starts when the starter kill relay is completely disconnected, the wrong starter wire has been cut and interrupted.

YELLOW wire is not connected to true ignition. It is connected to an accessory circuit.

Shock sensor doesn't trigger the alarm:

Has the NPC™ system been triggered? If so, you will hear five chirps when disarming. To check this, turn the ignition key on and off to clear the NPC™ from memory, and then retest the shock sensor. For a detailed description of NPC™, see Owner's Guide.

Door input does not immediately trigger full alarm. Instead, first I hear chirps for three seconds:

That's how the progressive two-stage door input works! This is a feature of this system. This is an instant trigger, remember, since even if the door is instantly closed, the progression from chirps to constant siren will continue.

Closing the door triggers the system, but opening the door does not:

Have you correctly identified the type of door switch system? This happens often when the wrong door input has been used.

System will not passively arm until it is remotely armed and then disarmed:

Are the door inputs connected? Is a BLUE wire connected to the door trigger wire in the vehicle? Either the GREEN H1/5 or the VIOLET H1/7 should be used instead.

Door input does not respond with the progressive trigger, but with immediate full alarm:

What zone does the LED indicate? If the LED indicates that the impact sensor caused the trigger, the sensor may be detecting the door opening. Reducing the sensitivity or relocating the sensor can often solve this problem. If the LED indicates that the door caused the trigger, you may have programmed the progressive door trigger off. See page 19.

The Valet® switch doesn't work.

Is it plugged into the correct socket?

Check the System Features Learn Routine for the programmed Valet pulse count.

Status LED doesn't work.

Make sure that it is plugged in. See page 13. Is the LED plugged into the correct socket?