



FCC PART 15D  
RSS-GEN ISSUE 5, FEBRUARY 2021 AMENDMENT 2  
RSS-213, ISSUE 3, MARCH 2015

MEASUREMENT AND TEST REPORT

For

**FCC: VTech Telecommunications Ltd.**

FCC: 23/F Tai Ping Ind Center Block 1 57 Ting Kok Rd Tai Po NT, Hong Kong

**ISED: VTECH TELECOMMUNICATIONS LIMITED**

ISED: BL.1 23/F Tai Ping Industr Ctr. 57 Ting Kok Road Tai Po, NT Hongkong

**FCC ID: EW780-H0FT-06**  
**IC: 1135B-80H0FT06**

<b>Report Type:</b> Original Report	<b>Product Type:</b> Cordless Hotel Telephone
<b>Report Number:</b> SZ1210429-14614E	
<b>Report Date:</b> 2021-05-18	
<b>Reviewed By:</b> RF Engineer	Jacob Kong
<b>Prepared By:</b> Bay Area Compliance Laboratories Corp. (Shenzhen) 5F(B-West), 6F, 7F, the 3rd Phase of Wan Li Industrial Building D, Shihua Rd, FuTian Free Trade Zone, Shenzhen, China Tel: +86-755-33320018 Fax: +86-755-33320008 <a href="http://www.baclcorp.com.cn">www.baclcorp.com.cn</a>	

**Note:** This report may contain data that are not covered by the A2LA accreditation and are marked with an asterisk "★".

BACL is not responsible for the authenticity of any test data provided by the applicant. Data included from the applicant that may affect test results are marked with an asterisk '\*'. Customer model name, addresses, names, trademarks etc. are not considered data.

This report cannot be reproduced except in full, without prior written approval of the Company. Unless otherwise stated the results shown in this test report refer only to the sample(s) tested. This report is valid only with a valid digital signature. The digital signature may be available only under the Adobe software above version 7.0.

## TABLE OF CONTENTS

<b>GENERAL INFORMATION.....</b>	<b>4</b>
PRODUCT DESCRIPTION FOR EQUIPMENT UNDER TEST (EUT).....	4
OBJECTIVE .....	4
TEST METHODOLOGY .....	4
MEASUREMENT UNCERTAINTY.....	5
TEST FACILITY .....	5
<b>SYSTEM TEST CONFIGURATION.....</b>	<b>6</b>
DESCRIPTION OF TEST CONFIGURATION .....	6
EQUIPMENT MODIFICATIONS .....	6
LOCAL SUPPORT EQUIPMENT LIST AND DETAILS .....	6
EXTERNAL I/O CABLE.....	6
BLOCK DIAGRAM OF TEST SETUP .....	7
<b>SUMMARY OF TEST RESULTS .....</b>	<b>8</b>
<b>TEST EQUIPMENT LIST .....</b>	<b>9</b>
<b>§2.1093 &amp; RSS-102 RF EXPOSURE.....</b>	<b>10</b>
APPLICABLE STANDARD .....	10
TEST RESULT .....	10
<b>§ 15.317, § 15.203 &amp; RSS-GEN §6.8 ANTENNA REQUIREMENT.....</b>	<b>11</b>
APPLICABLE STANDARD .....	11
ANTENNA CONNECTOR CONSTRUCTION .....	11
<b>§ 15.315, § 15.207 &amp; RSS-213 §5.4 CONDUCTED EMISSIONS.....</b>	<b>12</b>
APPLICABLE STANDARD .....	12
EUT SETUP .....	12
EMI TEST RECEIVER SETUP.....	13
TEST PROCEDURE .....	13
CORRECTED FACTOR & MARGIN CALCULATION .....	13
TEST DATA .....	13
<b>§ 15.323 (A) &amp; RSS-213 §5.5 EMISSION BANDWIDTH.....</b>	<b>16</b>
APPLICABLE STANDARD .....	16
TEST PROCEDURE .....	16
TEST DATA .....	17
<b>§ 15.319 (C) &amp; RSS-213 §5.6 PEAK TRANSMIT POWER .....</b>	<b>19</b>
APPLICABLE STANDARD .....	19
TEST PROCEDURE .....	19
TEST DATA .....	20
<b>§ 15.319 (D) &amp; RSS-213 §5.7 POWER SPECTRAL DENSITY.....</b>	<b>23</b>
APPLICABLE STANDARD .....	23
TEST PROCEDURE .....	23
TEST DATA .....	23
<b>§ 15.323 (D) &amp; RSS-213 §5.8 EMISSION INSIDE AND OUTSIDE THE SUB-BAND .....</b>	<b>28</b>
APPLICABLE STANDARD .....	28
TEST PROCEDURE .....	29
TEST DATA .....	29

**§ 15.323 (F) & RSS-213 §5.3 FREQUENCY STABILITY.....47**  
APPLICABLE STANDARD .....47  
TEST PROCEDURE .....47  
TEST DATA .....48

**§ 15.323 (C)(E) § 15.319 (F) & RSS-213 §5.1&§5.2 SPECIFIC REQUIREMENTS FOR UPCS DEVICE.....49**  
APPLICABLE STANDARD .....49  
TEST PROCEDURE .....49  
TEST DATA .....49  
1) AUTOMATIC DISCONTINUATION OF TRANSMISSION.....50  
2) MONITORING TIME .....50  
3) LOWER MONITORING THRESHOLD.....50  
4) MAXIMUM TRANSMIT PERIOD .....51  
5) SYSTEM ACKNOWLEDGEMENT .....51  
6) LEAST INTERFERED CHANNEL (LIC) .....52  
7) RANDOM WAITING .....54  
8) MONITORING BANDWIDTH AND REACTION TIME .....55  
9) MONITORING ANTENNA.....56  
10) MONITORING THRESHOLD RELAXATION .....56  
11) DUPLEX CONNECTIONS.....56  
12) ALTERNATIVE MONITORING INTERVAL .....58  
13) FAIR ACCESS .....59  
14) FRAME REPETITION STABILITY FRAME PERIOD AND JITTER .....59

## GENERAL INFORMATION

### Product Description for Equipment under Test (EUT)

Product	Cordless Hotel Telephone
Tested Model	CTM-S2116
Multiple Model	NGC-S3410HC, CTM-A2116
HVIN	35-400324HS
Model Differences	Refer to the DoS letter
Frequency Range	1921.536~1928.448 MHz
Maximum conducted peak output power	19.54dBm
Modulation Technique	GFSK
Antenna Specification	0 dBi
Voltage Range	DC 6.0V from adapter or DC 3.7V from battery
Date of Test	2021-05-10 to 2021-05-14
Sample serial number	SZ1210429-14614E-RF-S1(Assigned by BAACL, Shenzhen)
Received date	2021-04-29
Sample/EUT Status	Good condition
Normal/Extreme Condition	L.V.: Low Voltage: 3.35V <sub>DC</sub> ; L.T.: Low Temperature -20°C N.V.: Normal Voltage: 3.7V <sub>DC</sub> ; N.T.: Normal Temperature +20°C H.V.: High Voltage: 4.2V <sub>DC</sub> ; H.T.: High Temperature +50°C
Adapter information	Model:VT05EUS06045 Input: 100-240V~ 50/60Hz, 0.15A Output: DC 6.0V, 0.45A 2.70W

### Objective

The tests were performed in order to determine the compliance of the EUT with FCC Part 15-Subpart D, section 15.207, 15.315, 15.317, 15.319 and 15.323 rules. The EMI measurements were performed according to the measurement procedure described in ANSI C63.17 – 2013 and RSS-213 Issue 3, 2GHz License-Exempt Personal Communications Service Devices (PCS) OF THE Canadian Department of Industry rules and RSS-GEN ISSUE 5, FEBRUARY 2021 AMENDMENT 2 of the Innovation, Science and Economic Development Canada rules.

The objective of the manufacturer is to demonstrate the compliance of EUT with RSS-213 rules including Output Power, Occupied Bandwidth, Power Spectral Density, Unwanted Emissions, Frequency Stability.

### Test Methodology

All measurements contained in this report were conducted with ANSI C63.17 - 2013, American National Standard Methods of Measurement of the Electromagnetic and Operational Compatibility of Unlicensed Personal Communications Services (UPCS) Devices.

All emissions measurement was performed at Bay Area Compliance Laboratories Corp. (Shenzhen). The radiated testing was performed at an antenna-to-EUT distance of 3 meters.

In addition to the requirements in RSS-Gen, the limits and requirements set out in this standard and in associated Innovation, science and Economic Development Canada standards shall apply. Compliance with these limits shall be demonstrated using the method of measurement described in Section 3 of this standard.

A test report shall be prepared in accordance with RSS-Gen, ANSI C63.17-2013.

All radiated and conducted emissions measurement was performed BACL. The radiated testing was performed at an antenna-to –EUT distance of 3 Meters.  
Each test item follows test standards and with no deviation.

### Measurement Uncertainty

Item	Uncertainty
AC Power Lines Conducted Emissions	±1.95dB
RF conducted test with spectrum	±1.5dB
Occupied Bandwidth	±5%
Temperature	±3°C
Humidity	±6%
Supply voltages	±0.4%
All emissions, radiated	±4.88dB

*Note: The extended uncertainty given in this report is obtained by combining the standard uncertainty times the coverage factor K with the 95% confidence interval. Otherwise required by the applicant or Product Regulations, Decision Rule in this report did not consider the uncertainty.*

### Test Facility

The Test site used by Bay Area Compliance Laboratories Corp. (Shenzhen) to collect test data is located on the 5F(B-West) , 6F, 7F, the 3rd Phase of Wan Li Industrial Building D, Shihua Rd, FuTian Free Trade Zone, Shenzhen, China

The test site has been approved by the FCC under the KDB 974614 D01 and is listed in the FCC Public Access Link (PAL) database, FCC Registration No. : 342867, the FCC Designation No. : CN1221.

The lab has been recognized by Innovation, Science and Economic Development Canada to test to Canadian radio equipment requirements, the CAB identifier: CN0023.

## SYSTEM TEST CONFIGURATION

---

### Description of Test Configuration

The system was configured to testing mode which is provided by the manufacturer.

### Equipment Modifications

No modification was made to the EUT tested.

### Local Support Equipment List and Details

Manufacturer	Description	Model	Serial Number
BULL	Socket	GN-415K	5503290068073
Rohde & Schwarz	Digital Radio Communication Test	CMD60	830861/029

### External I/O Cable

Cable Description	Length (m)	From Port	To
Un-Shielded Un-Detachable AC Cable	1.0	Socket	LISN
Un-Shielded Un-Detachable DC Cable	1.5	EUT	Adapter
Un-Shielded Un-Detachable AC Cable	1.2	AC Power	CMD60

### Block Diagram of Test Setup

Test Mode: Charging & Transmitting

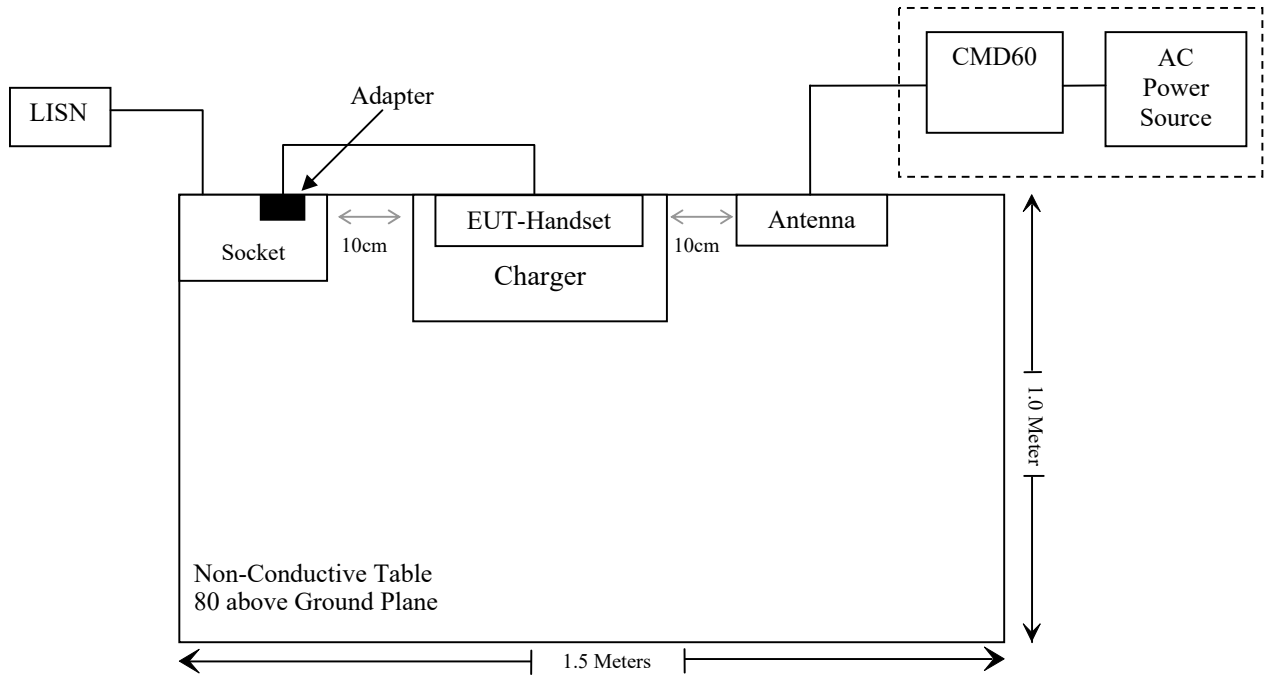

**SUMMARY OF TEST RESULTS**

<b>FCC Rules</b>	<b>IC Rules</b>	<b>Description of Test</b>	<b>Result</b>
§2.1093	RSS-102	RF EXPOSURE	Compliance
§ 15.317, § 15.203	RSS-Gen §6.8	Antenna Requirement	Compliance
§ 15.315, § 15.207	RSS-213 §5.4	Conducted Emission	Compliance
§ 15.323 (a)	RSS-213 §5.5	Emission Bandwidth	Compliance
§ 15.319 (c)	RSS-213 §5.6	Peak Transmit Power	Compliance
§ 15.319 (d)	RSS-213 §5.7	Power Spectral Density	Compliance
§ 15.323 (d)	RSS-213 §5.8	Emission Inside and Outside the sub-band	Compliance
/	RSS-213 §5.8	Radiated Emission	Compliance
§ 15.323 (f)	RSS-213 §5.3	Frequency Stability	Compliance
§ 15.323 (c)(e) § 15.319 (f)	RSS-213 §5.1&§5.2	Specific Requirements for UPCS	Compliance



**TEST EQUIPMENT LIST**

Manufacturer	Description	Model	Serial Number	Calibration Date	Calibration Due Date
<b>Conducted Emissions Test</b>					
Rohde & Schwarz	EMI Test Receiver	ESCI	101120	2020/08/04	2021/08/03
Rohde & Schwarz	LISN	ENV216	101613	2020/08/04	2021/08/03
Rohde & Schwarz	Transient Limitor	ESH3Z2	DE25985	2020/11/29	2021/11/28
Unknown	CE Cable	CE Cable	UF A210B-1-0720-504504	2020/11/29	2021/11/28
Rohde & Schwarz	CE Test software	EMC 32	V8.53.0	NCR	NCR
<b>Radiated Emission Test</b>					
R&S	EMI Test Receiver	ESR3	102455	2020/08/04	2021/08/03
Sonoma instrument	Pre-amplifier	310 N	186238	2020/08/04	2021/08/03
Sunol Sciences	Broadband Antenna	JB1	A040904-2	2020/12/22	2023/12/21
Unknown	Cable 2	RF Cable 2	F-03-EM197	2020/11/29	2021/11/28
Unknown	Cable	Chamber Cable 1	F-03-EM236	2020/11/29	2021/11/28
Rohde & Schwarz	Auto test software	EMC 32	V9.10	NCR	NCR
Rohde & Schwarz	Spectrum Analyzer	FSV40-N	102259	2020/08/04	2021/08/03
COM-POWER	Pre-amplifier	PA-122	181919	2020/11/29	2021/11/28
Quinstar	Amplifier	QLW-18405536-J0	15964001002	2020/11/28	2021/11/27
Sunol Sciences	Horn Antenna	3115	9107-3694	2021/01/15	2024/01/14
Insulated Wire Inc.	RF Cable	SPS-2503-3150	02222010	2020/11/29	2021/11/28
Unknown	RF Cable	W1101-EQ1 OUT	F-19-EM005	2020/11/29	2021/11/28
Ducommun Technologies	Horn antenna	ARH-4223-02	1007726-021304	2020/12/06	2023/12/05
<b>RF Conducted test</b>					
Rohde & Schwarz	SPECTRUM ANALYZER	FSU26	200120	2021/04/02	2022/04/01
Unknown	RF Cable	Unknown	2301 276	2020/11/29	2021/11/28
Unknown	RF Cable	Unknown	0501 067	2020/11/29	2021/11/28
Weinschel	Power divider	1515	RH386	2021/04/20	2022/04/20
Rohde & Schwarz	Digital Radio Communication Tester	CMD60	830861/029	2020/08/04	2021/08/03
Agilent	MXG Vector Signal Generator	N5182B	MY53051503	2020/08/04	2021/08/03
ESPEC	Temperature & Humidity Chamber	EL-10KA	9107726	2021/01/05	2022/01/05
instek	DC Power Supply	GPS-3030DD	EM832096	NCR	NCR
Fluke	Digital Multimeter	287	19000011	2020/07/23	2021/07/22

**Statement of Traceability:** Bay Area Compliance Laboratories Corp. (Shenzhen) attests that all calibrations have been performed in accordance to requirements that traceable to National Primary Standards and International System of Units (SI).

---

## **§ 2.1093 & RSS-102 RF EXPOSURE**

---

### **Applicable Standard**

According to FCC §2.1093 & RSS-102, systems operating under the provisions of this section shall be operated in a manner that ensures that the public is not exposed to radio frequency energy level in excess of the Commission's guideline.

### **Test Result**

Pass, please refer to the SAR report: SZ1210429-14614E-SA.

## § 15.317, § 15.203 & RSS-Gen §6.8 ANTENNA REQUIREMENT

### Applicable Standard

According to FCC § 15.203, an intentional radiator shall be designed to ensure that no antenna other than that furnished by the responsible party shall be used with the device. The use of a permanently attached antenna or of an antenna that uses a unique coupling to the intentional radiator shall be considered sufficient to comply with the provisions of this Section. The manufacturer may design the unit so that a broken antenna can be replaced by the user, but the use of a standard antenna jack or electrical connector is prohibited.

The applicant for equipment certification shall provide a list of all antenna types that may be used with the transmitter, where applicable (i.e. for transmitters with detachable antenna), indicating the maximum permissible antenna gain (in dBi) and the required impedance for each antenna. The test report shall demonstrate the compliance of the transmitter with the limit for maximum equivalent isotropically radiated power (e.i.r.p.) specified in the applicable RSS, when the transmitter is equipped with any antenna type, selected from this list.

For expediting the testing, measurements may be performed using only the antenna with highest gain of each combination of transmitter and antenna type, with the transmitter output power set at the maximum level. However, the transmitter shall comply with the applicable requirements under all operational conditions and when in combination with any type of antenna from the list provided in the test report (and in the notice to be included in the user manual, provided below).

When measurements at the antenna port are used to determine the RF output power, the effective gain of the device's antenna shall be stated, based on a measurement or on data from the antenna's manufacturer.

The test report shall state the RF power, output power setting and spurious emission measurements with each antenna type that is used with the transmitter being tested.

For licence-exempt equipment with detachable antennas, the user manual shall also contain the following notice in a conspicuous location:

This radio transmitter [enter the device's ISED certification number] has been approved by Innovation, Science and Economic Development Canada to operate with the antenna types listed below, with the maximum permissible gain indicated. Antenna types not included in this list that have a gain greater than the maximum gain indicated for any type listed are strictly prohibited for use with this device. Immediately following the above notice, the manufacturer shall provide a list of all antenna types which can be used with the transmitter, indicating the maximum permissible antenna gain (in dBi) and the required impedance for each antenna type.

### Antenna Connector Construction

The EUT has one internal antenna arrangement which was permanently attached and the gain is 0dBi, fulfill the requirement of this section. Please refer to the EUT photos.

Type	Antenna Gain	Impedance
Monopole	0dBi	50 Ω

## § 15.315, § 15.207 & RSS-213 §5.4 CONDUCTED EMISSIONS

### Applicable Standard

FCC§15.315, an unlicensed PCS device that is designed to be connected to the public utility (AC) power line must meet the limits specified in §15.207.

A radio apparatus that is designed to be connected to the public utility (AC) power line shall ensure that the radio frequency voltage, which is conducted back onto the AC power line on any frequency or frequencies within the band 150 kHz-30 MHz, shall not exceed the limits in the below table.

Unless the requirements applicable to a given device state otherwise, for any radio apparatus equipped to operate from the public utility AC power supply either directly or indirectly (such as with a battery charger), the radio frequency voltage of emissions conducted back onto the AC power lines in the frequency range of 0.15 MHz to 30 MHz shall not exceed the limits shown in below table. The more stringent limit applies at the frequency range boundaries.

Table - AC Power Lines Conducted Emission Limits		
Frequency range (MHz)	Conducted limit (dBµV)	
	Quasi-Peak	Average**
0.15 – 0.5	66 to 56*	56 to 46*
0.5 – 5	56	46
5 – 30	60	50

Note: \*Decreases with the logarithm of the frequency  
 \*\* A linear average detector is required

### EUT Setup

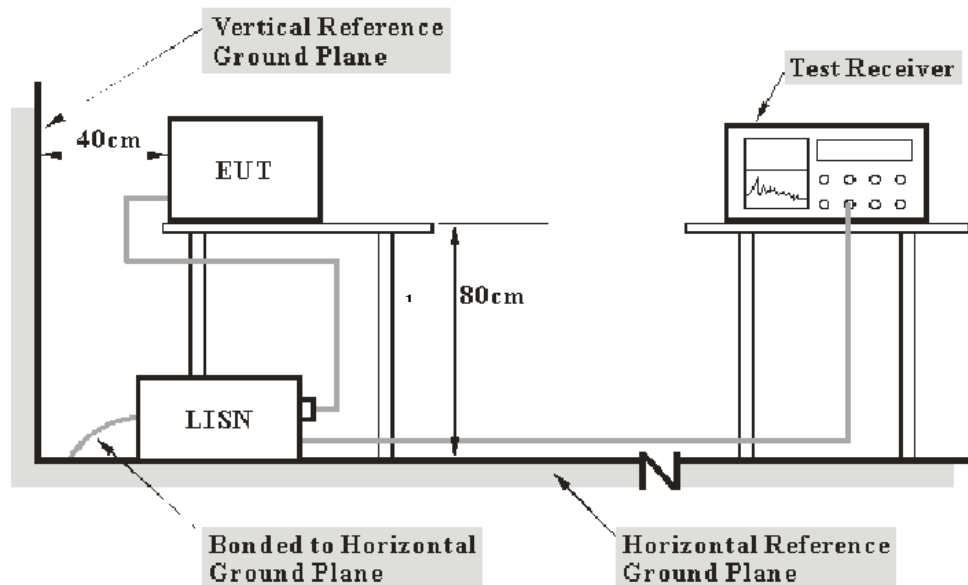

- Note: 1. Support units were connected to second LISN.  
 2. Both of LISNs (AMN) 80 cm from EUT and at the least 80 cm from other units and other metal planes support units.

The setup of EUT is according with per ANSI C63.10-2013 measurement procedure. The specification used was with the FCC 15.315, FCC 15.207 and RSS-Gen limits.

The external I/O cables were draped along the test table and formed a bundle 30 to 40 cm long in the middle.

The spacing between the peripherals was 10 cm.

The adapter was connected to a 120 VAC/60 Hz power source.

### EMI Test Receiver Setup

The EMI test receiver was set to investigate the spectrum from 150 kHz to 30 MHz.

During the conducted emission test, the EMI test receiver was set with the following configurations:

Frequency Range	IF B/W
150 kHz – 30 MHz	9 kHz

### Test Procedure

During the conducted emission test, adapter was connected to the outlet of the LISN.

Maximizing procedure was performed on the six (6) highest emissions of the EUT.

All final data was recorded in the Quasi-peak and average detection mode.

### Corrected Factor & Margin Calculation

The Corrected factor is calculated by adding the Outlet Cable Loss, LISN Insertion Loss, Cable Loss and Transient Limiter Attenuation. The basic equation is as follows:

Correction Factor = Outlet Cable Loss + LISN Insertion Loss + Cable Loss + Transient Limiter Attenuation

The “**Margin**” column of the following data tables indicates the degree of compliance with the applicable limit. For example, a margin of 7 dB means the emission is 7 dB below the limit. The equation for margin calculation is as follows:

$$\text{Margin} = \text{Limit} - \text{Corrected Amplitude}$$

### Test Data

#### Environmental Conditions

Temperature:	25°C
Relative Humidity:	65 %
ATM Pressure:	101.0 kPa

*The testing was performed by Haiguo Li on 2021-05-12.*

EUT operation mode: Transmitting & Charging

AC 120V/60 Hz, Line

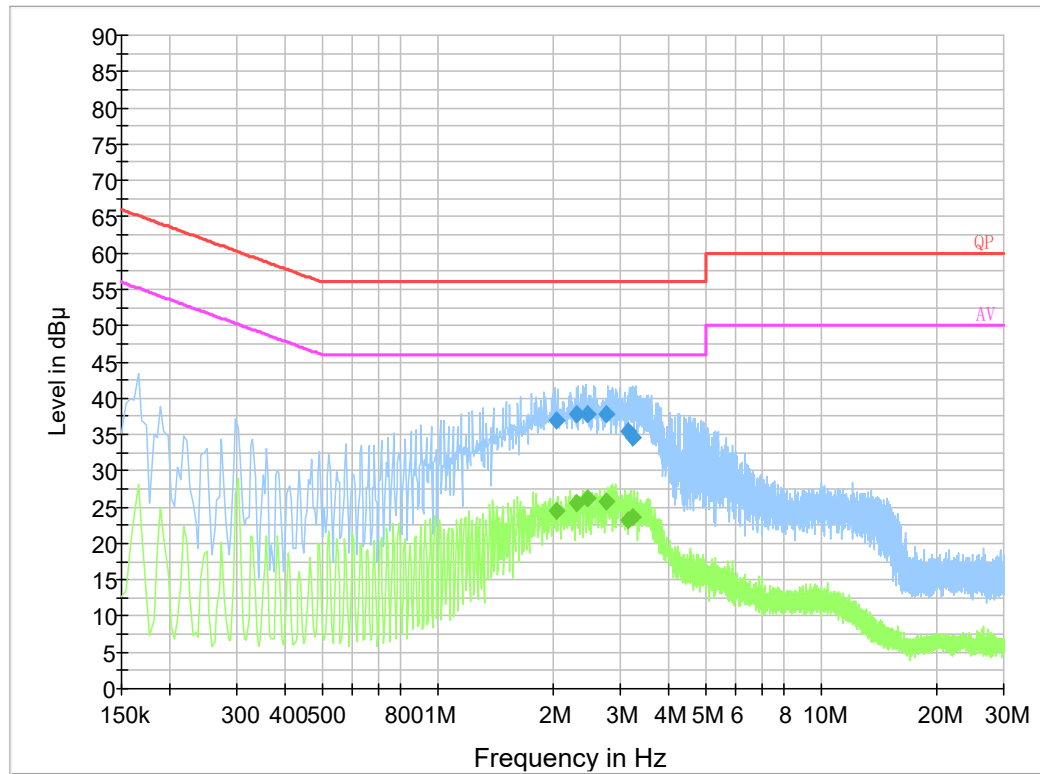

**Final Result 1**

Frequency (MHz)	QuasiPeak (dB µ V)	Bandwidth (kHz)	Line	Corr. (dB)	Margin (dB)	Limit (dB µ V)
2.035550	37.0	9.000	L1	19.9	19.0	56.0
2.310990	37.8	9.000	L1	19.9	18.2	56.0
2.473310	37.8	9.000	L1	19.8	18.2	56.0
2.748270	37.9	9.000	L1	19.9	18.1	56.0
3.138330	35.4	9.000	L1	19.9	20.6	56.0
3.245310	34.6	9.000	L1	19.9	21.4	56.0

**Final Result 2**

Frequency (MHz)	Average (dB µ V)	Bandwidth (kHz)	Line	Corr. (dB)	Margin (dB)	Limit (dB µ V)
2.035550	24.6	9.000	L1	19.9	21.4	46.0
2.310990	25.7	9.000	L1	19.9	20.3	46.0
2.473310	26.1	9.000	L1	19.8	19.9	46.0
2.748270	25.8	9.000	L1	19.9	20.2	46.0
3.138330	23.3	9.000	L1	19.9	22.7	46.0
3.245310	23.7	9.000	L1	19.9	22.3	46.0

**AC 120V/60 Hz, Neutral**

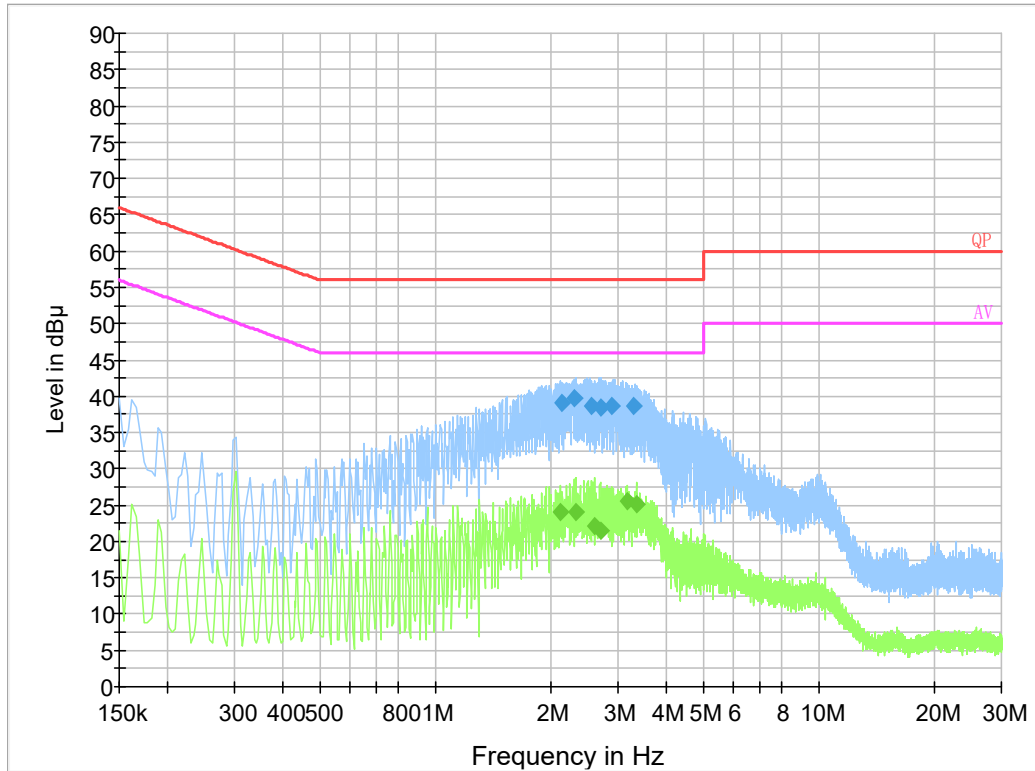

**Final Result 1**

Frequency (MHz)	QuasiPeak (dB µ V)	Bandwidth (kHz)	Line	Corr. (dB)	Margin (dB)	Limit (dB µ V)
2.142230	39.0	9.000	N	19.9	17.0	56.0
2.302990	39.7	9.000	N	19.8	16.3	56.0
2.548110	38.6	9.000	N	19.8	17.4	56.0
2.713230	38.5	9.000	N	19.8	17.5	56.0
2.894050	38.7	9.000	N	19.9	17.3	56.0
3.304350	38.6	9.000	N	19.9	17.4	56.0

**Final Result 2**

Frequency (MHz)	Average (dB µ V)	Bandwidth (kHz)	Line	Corr. (dB)	Margin (dB)	Limit (dB µ V)
2.118000	24.0	9.000	N	19.9	22.0	46.0
2.334000	24.1	9.000	N	19.8	21.9	46.0
2.610000	22.2	9.000	N	19.8	23.8	46.0
2.694000	21.4	9.000	N	19.8	24.6	46.0
3.178000	25.5	9.000	N	19.9	20.5	46.0
3.342000	25.2	9.000	N	19.9	20.8	46.0

**§ 15.323 (A) & RSS-213 §5.5 EMISSION BANDWIDTH**

**Applicable Standard**

Operation shall be contained within the 1920–1930 MHz band. The emission bandwidth shall be less than 2.5 MHz and greater than 50 kHz.

The emission bandwidth is measured in accordance with ANSI C63.17 sub-clause 6.1.3 using the setup below:

Test Setup 1:

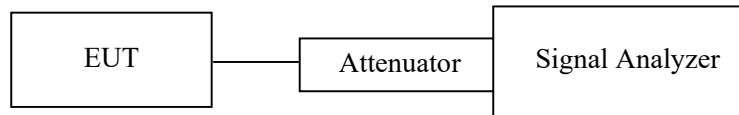

The width, in Hz, of the signal between two points, one below the carrier center frequency and one above the carrier center frequency, that is 26 dB down relative to the maximum level of the modulated carrier. It is based on the use of measurement instrumentation employing a peak detector function with an instrument resolution bandwidth approximately equal to 1% of the emission band-width of the device under measurement. [Extraction from 47 CFR 15, subpart D, 15.303 (C)].

**Test Procedure**

Using the manufacturer’s information on occupied bandwidth set the spectrum analyzer as follows:

Resolution bandwidth	1.0% of the emission bandwidth (as close as possible)
Video bandwidth	>3 times the resolution bandwidth
Number of sweeps	sufficient to stability the trace
Detection mode	peak detection with maximum hold

**EBW:**

The emission bandwidth (x dB) is defined as the frequency range between two points, one above and one below the carrier frequency, at which the spectral density of the emission is attenuated x dB below the maximum in-band spectral density of the modulated signal. Spectral density (power per unit bandwidth) is to be measured with a detector of resolution bandwidth in the range of 1% to 5% of the anticipated emission bandwidth, and a video bandwidth at least 3x the resolution bandwidth.

**OBW:**

- The transmitter shall be operated at its maximum carrier power measured under normal test conditions.
- The span of the analyzer shall be set to capture all products of the modulation process, including the emission skirts.
- The resolution bandwidth (RBW) shall be in the range of 1% to 5% of the occupied bandwidth (OBW) and video bandwidth (VBW) shall be approximately 3x RBW.



**Test Data**

**Environmental Conditions**

<b>Temperature:</b>	24 °C
<b>Relative Humidity:</b>	64 %
<b>ATM Pressure:</b>	101.0 kPa

The testing was performed by Andy Yu on 2021-05-10.

Test mode: Transmitting

Channel	Frequency (MHz)	26 dB Emission Bandwidth (MHz)	99% Occupied Bandwidth (MHz)	Limit
Low	1921.536	1.471	1.197	50 kHz ~ 2.5 MHz
Middle	1924.992	1.466	1.202	50 kHz ~ 2.5 MHz
High	1928.448	1.466	1.202	50 kHz ~ 2.5 MHz

**Test Result: Pass**

Please refer to the following plots.

**Low Channel**

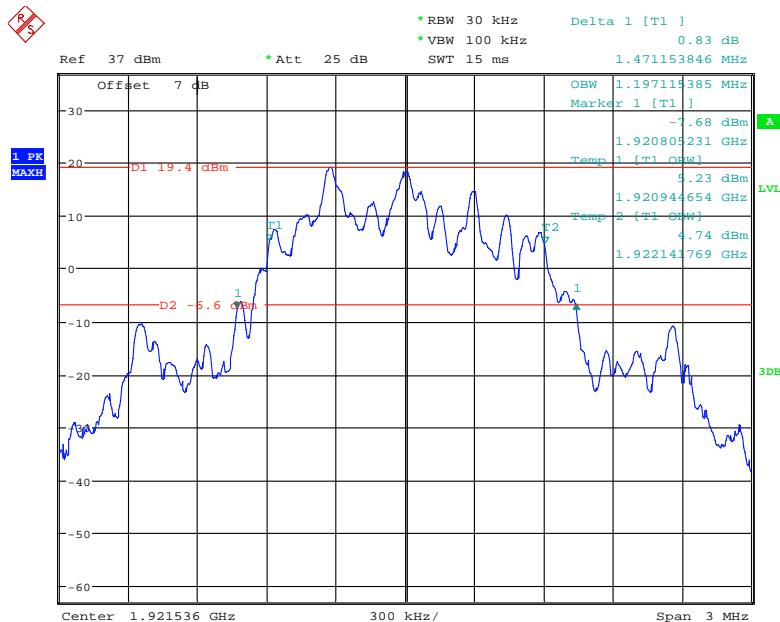

Date: 10.MAY.2021 09:57:16

### Middle Channel

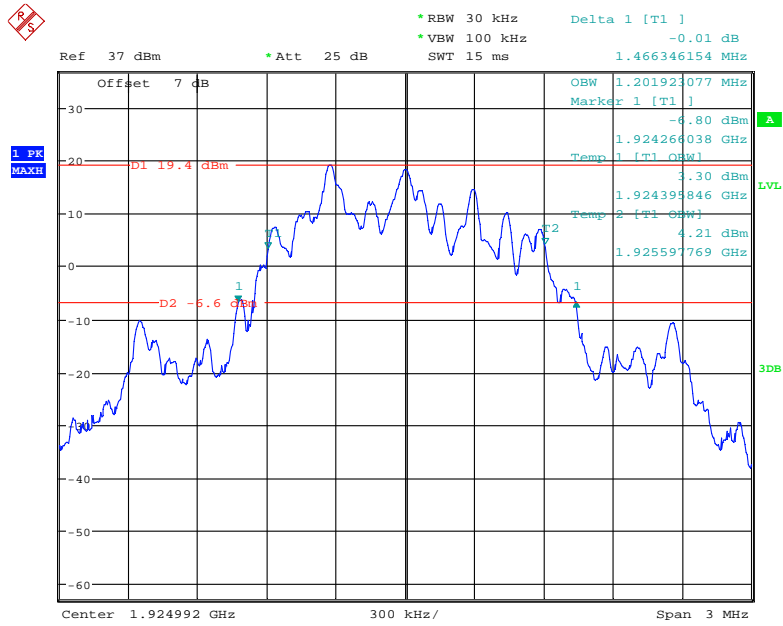

Date: 10.MAY.2021 09:55:40

### High Channel

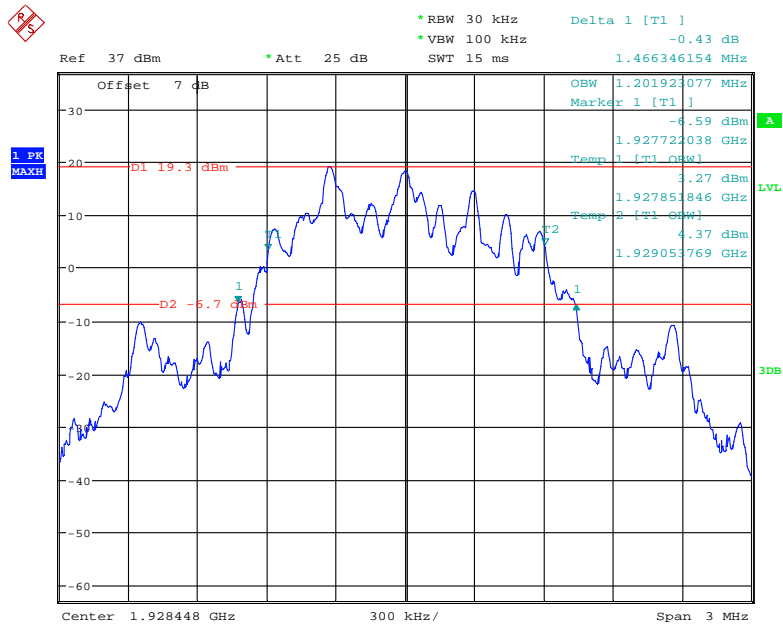

Date: 10.MAY.2021 09:58:29

## § 15.319 (c) & RSS-213 §5.6 PEAK TRANSMIT POWER

### Applicable Standard

The peak power output as measured over an interval of time equal to the frame rate or transmission burst of the device under all conditions of modulation. Usually this parameter is measured as a conducted emission by direct connection of a calibrated test instrument to the equipment under test. If the device cannot be connected directly, alternative techniques acceptable to the Commission may be used [47 CFR 15, subpart D, 15.303].

The peak transmit power is according to ANSI C63.17-2013 §6.1.2

Per FCC Part 15.319 (c) Peak transmit power shall not exceed 100 microwatts multiplied by the square root of the emission bandwidth in hertz. Peak transmit power must be measured over any interval of continuous transmission using instrumentation calibrated in terms of an rms-equivalent voltage. The measurement results shall be properly adjusted for any instrument limitations, such as detector response times, limited resolution bandwidth capability when compared to the emission bandwidth, sensitivity, etc., so as to obtain a true peak measurement for the emission in question over the full bandwidth of the channel.

Per FCC Part 15.319 (e), the peak transmit power shall be reduced by the amount in decibels that the maximum directional gain of the antenna exceeds 3 dBi.

Calculation of Peak Transmit Power Limit:

$$\text{Peak Transmit Power Limit} = 100\mu\text{W} \times (\text{EBW})^{1/2}$$

EBW is the transmit emission bandwidth in Hz determined in the other test item:

Peak transmit power shall not exceed 100  $\mu\text{W}$  multiplied by the square root of the occupied bandwidth in hertz. The peak transmit power shall be reduced by the amount in decibels that the maximum directional gain of the antenna exceeds 3 dBi.

### Test Procedure

Using the manufacturer's information on occupied bandwidth set the spectrum analyzer as follows:

RBW	$\geq$ Emission bandwidth
Video bandwidth	$\geq$ RBW
Span	Zero
Center frequency	Nominal center frequency of channels
Amplitude scale	Log (linear may be used if analyzer has sufficient linear dynamic range and accuracy)
Detection	Peak detection
Trigger	Video
Sweep rate	Sufficiently rapid to permit the transmit pulse to be resolved accurately

**Test Data**

**Environmental Conditions**

<b>Temperature:</b>	25 °C
<b>Relative Humidity:</b>	61 %
<b>ATM Pressure:</b>	101.0 kPa

The testing was performed by Andy Yu on 2021-05-10.

Test mode: Transmitting:

**Test Result: Pass**

Please refer to the following table and plots.

Channel	Frequency (MHz)	Peak Transmit Power (dBm)	FCC Limit (dBm)	ISED Limit (dBm)
Low	1921.536	19.37	20.84	20.39
Middle	1924.992	19.36	20.83	20.40
High	1928.448	19.54	20.83	20.40
FCC: EBW <sub>Low channel</sub> = 1471000Hz, EBW <sub>Middle channel</sub> = 1466000 Hz, EBW <sub>High channel</sub> = 1466000 Hz Peak Transmit Power Limit = $100(EBW)^{1/2} \mu W$				
ISED: OBW <sub>Low channel</sub> = 1197000 Hz, OBW <sub>Middle channel</sub> = 1202000 Hz, OBW <sub>High channel</sub> = 1202000Hz Peak Transmit Power Limit = $100(OBW)^{1/2} \mu W$				

### Low Channel

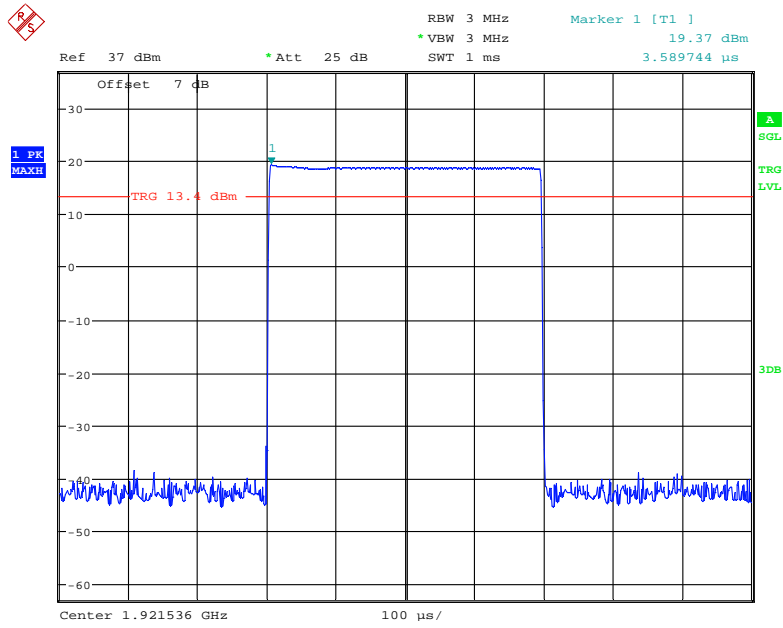

Date: 10.MAY.2021 10:11:51

### Middle Channel

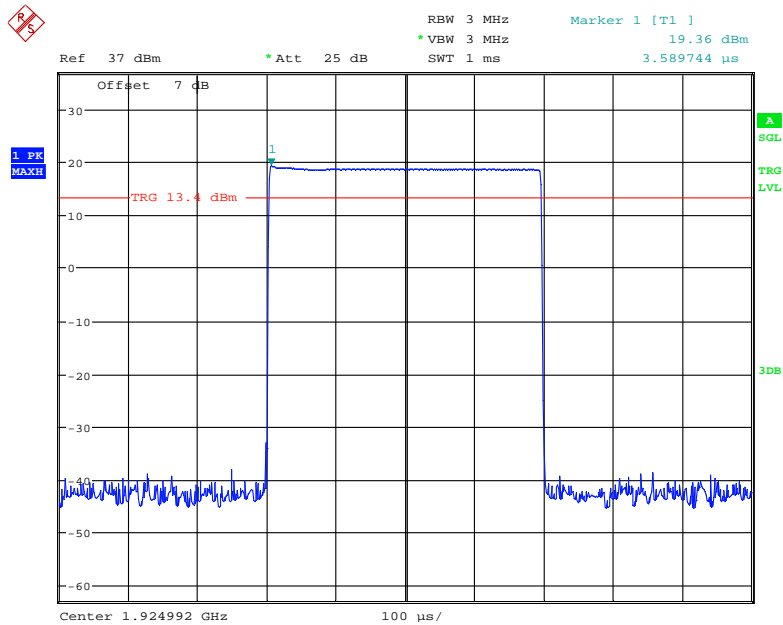

Date: 10.MAY.2021 10:11:12

### High Channel

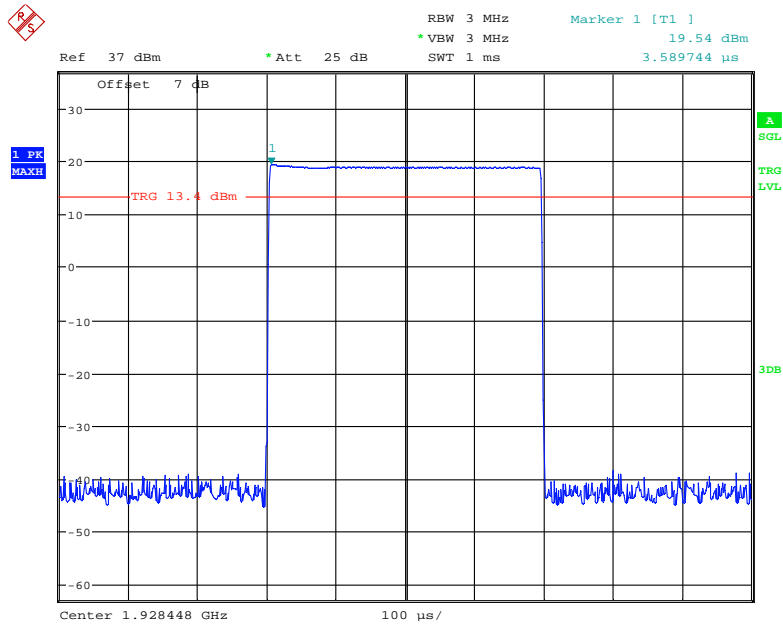

Date: 10.MAY.2021 10:10:27

## § 15.319 (d) & RSS-213 §5.7 POWER SPECTRAL DENSITY

### Applicable Standard

The average pulse energy in a 3 kHz bandwidth is divided by the pulse duration.

The power spectral density shall not exceed 3mW in any 3 kHz bandwidth as measured with a spectrum analyzer having a resolution bandwidth of 3 kHz.

The power spectral density is measured in accordance with ANSI C63.17-2013 Clause 6.1.5.

The peak-hold power spectral density of transmitters shall not exceed 12 mW per any 3 kHz bandwidth. As an alternative to the peak-hold power spectral density, the time-averaged power spectral density may be measured and it shall not exceed 3 mW per any 3 kHz bandwidth.

### Test Procedure

Using the manufacturer's information on occupied bandwidth set the spectrum analyzer as follows:

RBW	3 kHz
Video bandwidth	$\geq 3 \times \text{RBW}$
Span	Zero span at frequency with the maximum level (frequency determined in 6.1.3 if the same type of signal (continuous versus burst) was used in 6.1.3)
Center frequency	Spectral peak as determined in 6.1.3
Sweep time	For burst signals, sufficient to include essentially all of the maximum length burst at the output of a 3 kHz filter (e.g., maximum input burst duration plus 600 $\mu\text{s}$ ). For continuous signals, 20 ms.
Amplitude scale	Log power
Detection	Sample detection and averaged for a minimum of 100 sweeps
Trigger	External or internal

### Test Data

#### Environmental Conditions

<b>Temperature:</b>	24°C
<b>Relative Humidity:</b>	64 %
<b>ATM Pressure:</b>	101.0 kPa

*The testing was performed by Andy Yu on 2021-05-10.*

#### Test Result: Pass

*Please refer to following table and plots*

*Test mode: Transmitting*

Channel	Frequency (MHz)	Power Spectral Density		Limit (mW/3kHz)	Result
		(dBm/3kHz)	(mW/3kHz)		
Low	1921.536	-0.07	0.98	3	Pass
Middle	1924.992	-0.14	0.97	3	Pass
High	1928.448	-0.58	0.87	3	Pass



Low Channel

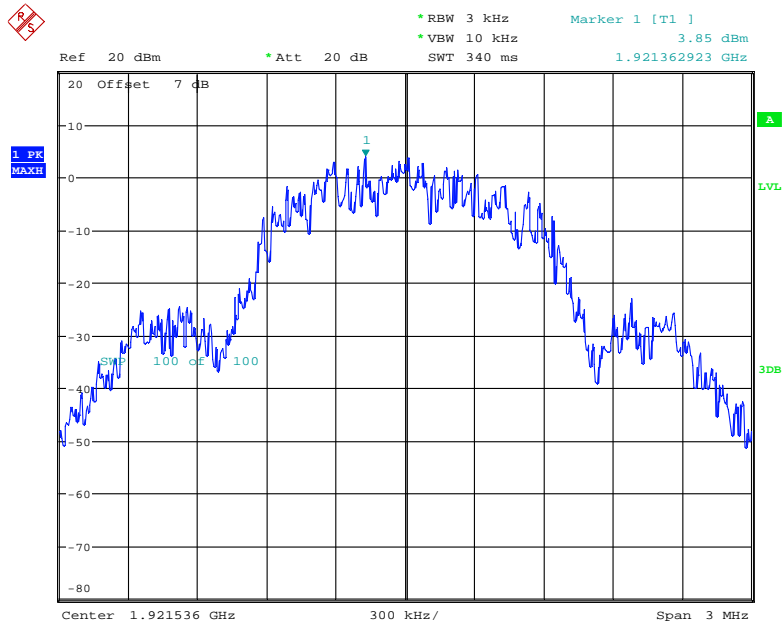

Date: 10.MAY.2021 12:07:09

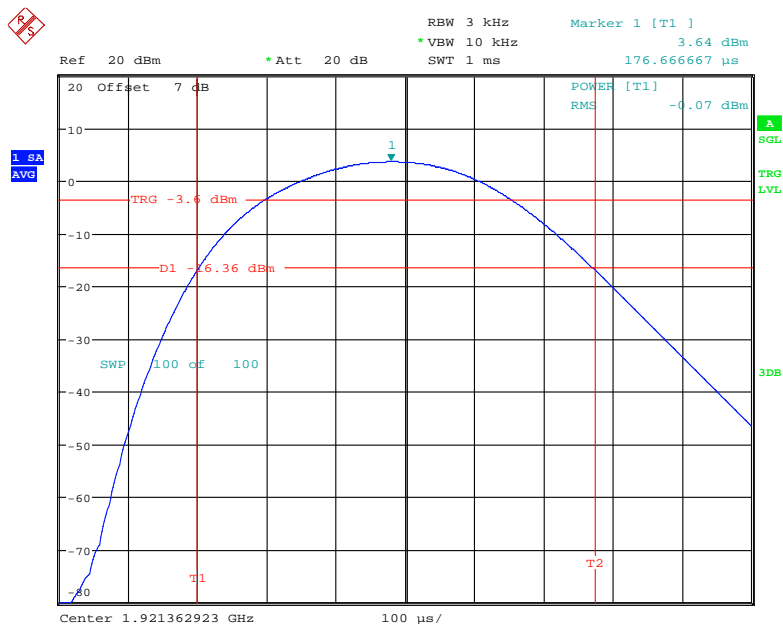

Date: 10.MAY.2021 12:08:23

### Middle Channel

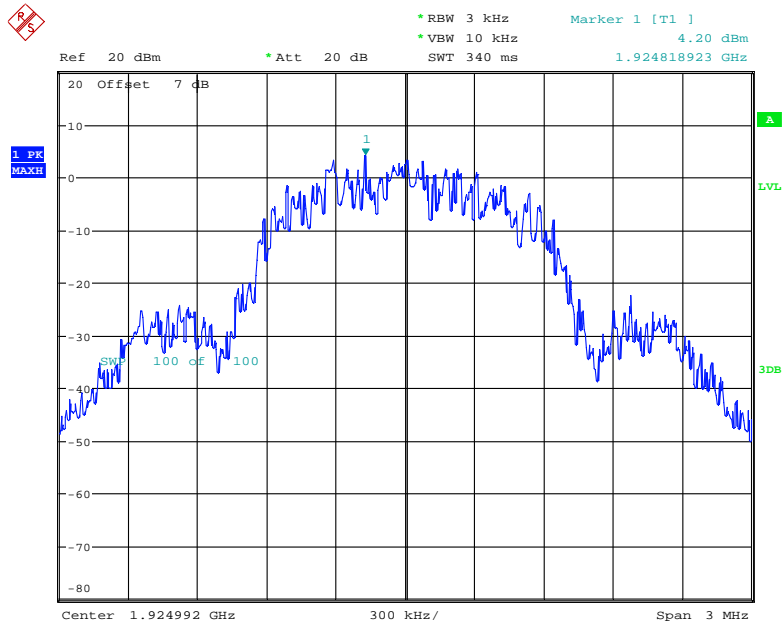

Date: 10.MAY.2021 12:04:27

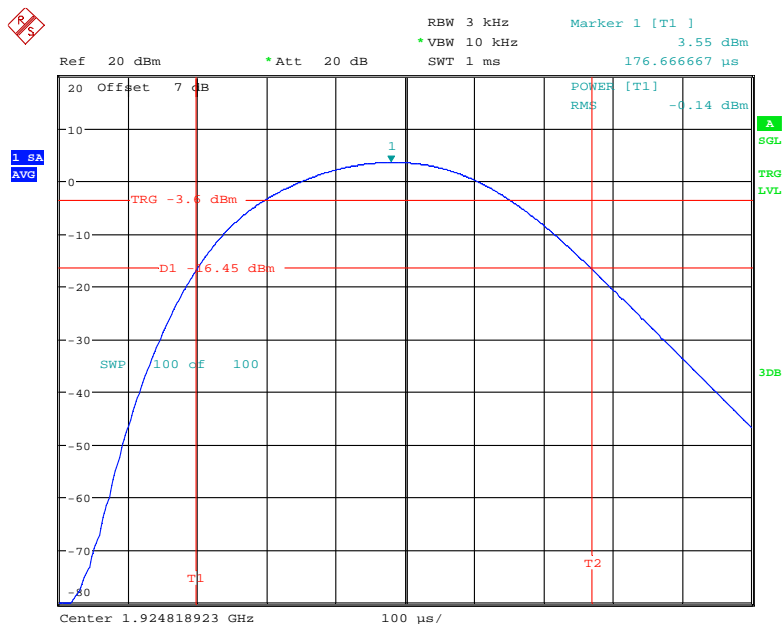

Date: 10.MAY.2021 12:05:37

### High Channel

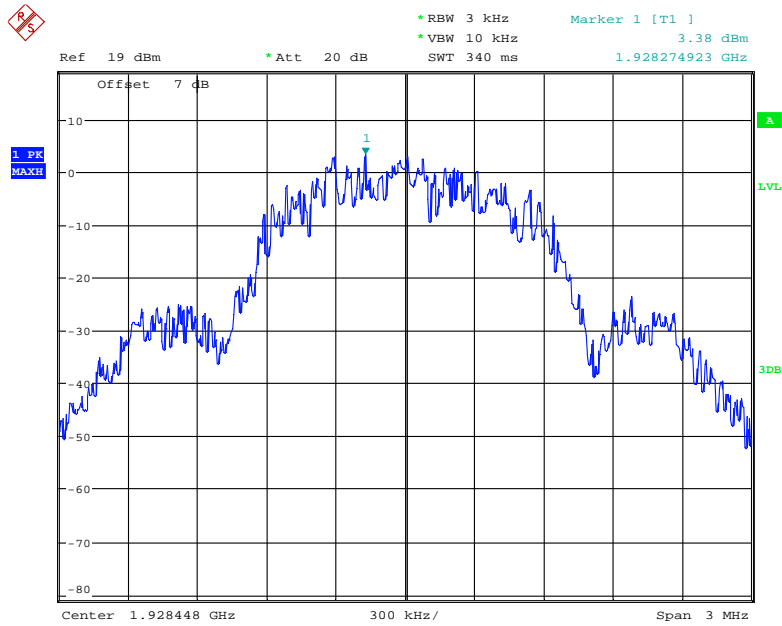

Date: 10.MAY.2021 13:19:19

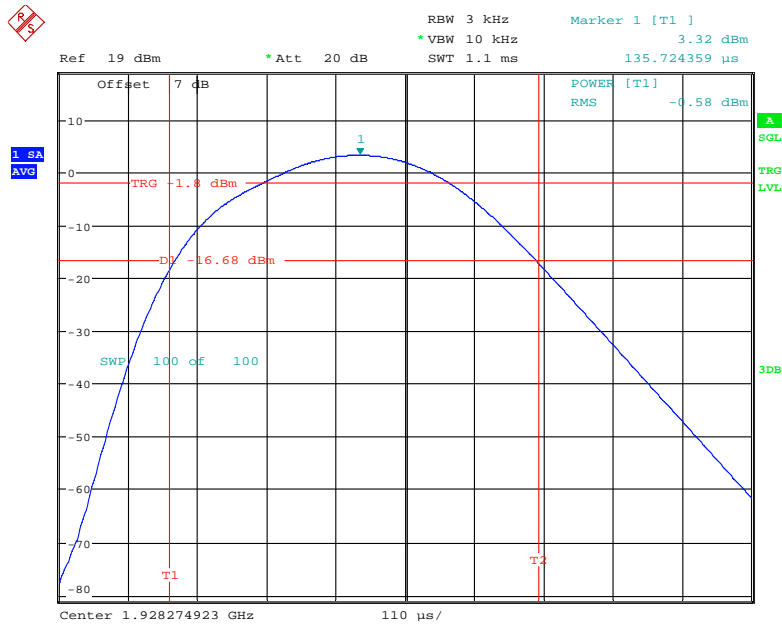

Date: 10.MAY.2021 13:22:06

---

## **§ 15.323 (d) & RSS-213 §5.8 EMISSION INSIDE AND OUTSIDE THE SUB-BAND**

---

### **Applicable Standard**

Emissions inside the sub-band must comply with the following emission mask:

1. In the bands between 1B and 2B measured from the center of the emission bandwidth the total power emitted by the device shall be at least 30 dB below the transmit power permitted for that device;
2. in the bands between 2B and 3B measured from the center of the emission bandwidth the total power emitted by an intentional radiator shall be at least 50 dB below the transmit power permitted for that radiator;
3. in the bands between 3B and the sub-band edge the total power emitted by an intentional radiator in the measurement bandwidth shall be at least 60 dB below the transmit power permitted for that radiator.

Where B = emission bandwidth

Emission Outside the sub-band shall be attenuated below a reference power of 112 mw (20.5 dBm) as follows:

1. 30 dB between the sub-band and 1.25 MHz above or below the sub-band;
2. 50 dB between 1.25 and 2.5 MHz above or below the sub-band;
3. 60 dB at 2.5 MHz or greater above or below the sub-band.

### **Emissions outside the 1920-1930 MHz Band**

Emissions outside the 1920-1930 MHz band shall be attenuated below a reference power of 112 milliwatts (-9.5 dBW) by at least:

- 30 dB between the band edges and 1.25 MHz above and below the band edges;
- 50 dB between 1.25 MHz and 2.5 MHz above or below the band edges; and
- 60 dB at 2.5 MHz or greater above or below the band edges.

### **Emissions inside the 1920-1930 MHz Band**

Emissions inside the 1920-1930 MHz band shall be attenuated below the transmit power permitted for that device, as follows:

- 30 dB between the frequencies 1B and 2B measured from the centre of the occupied bandwidth;
- 50 dB between the frequencies 2B and 3B measured from the centre of the occupied bandwidth; and
- 60 dB between the frequencies 3B and band edge, where B is the occupied bandwidth in hertz.

**Test Procedure**

According to ANSI C63.17.2013 Clause 6.1.6.

**In-band emission:**

**Spectrum analyzer settings for measuring in-band emission**

RBW	Approximately 1% of the emission bandwidth ( $B$ )
Video bandwidth	$3 \times \text{RBW}$
Sweep time	The sweep time shall be sufficiently slow that the swept frequency rate shall not exceed one RBW per three transmit bursts.
Number of sweeps	Sufficient to stabilize the trace
Amplitude scale	Log
Detection	Peak detection and max hold enabled
Span	Approximately equal to $3.5 B$

**Out-band emission:**

RBW	30kHz
Video bandwidth	100kHz
Center frequency	Nominal center frequency of channels
Amplitude scale	Log (linear may be used if analyzer has sufficient linear dynamic range and accuracy)
Detection	Peak detection

**Test Data**

**Environmental Conditions**

<b>Temperature:</b>	27.7~28 °C
<b>Relative Humidity:</b>	54~59 %
<b>ATM Pressure:</b>	100.9~101.0 kPa

*The testing was performed by Zero Yan on 2021-05-13 below 1GHz, by Alan He on 2021-05-14 for above 1GHz and by Andy Yu on 2021-05-10 for conducted emission*

*Test mode: Transmitting*

**Test Result: Pass**

*Please refer to following plots*

FCC:

### Low Channel (Unwanted Emission inside the Sub-band)

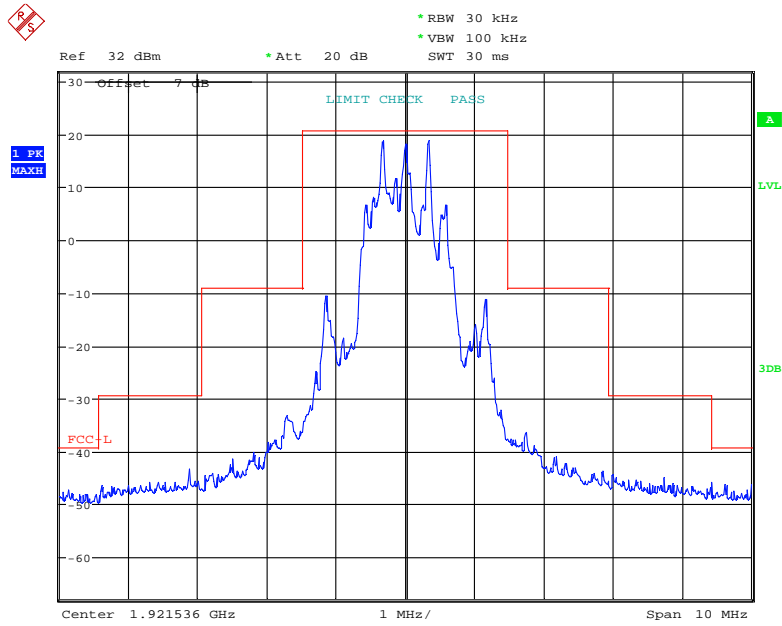

Date: 10.MAY.2021 10:33:53

### Middle Channel (Unwanted Emission inside the Sub-band)

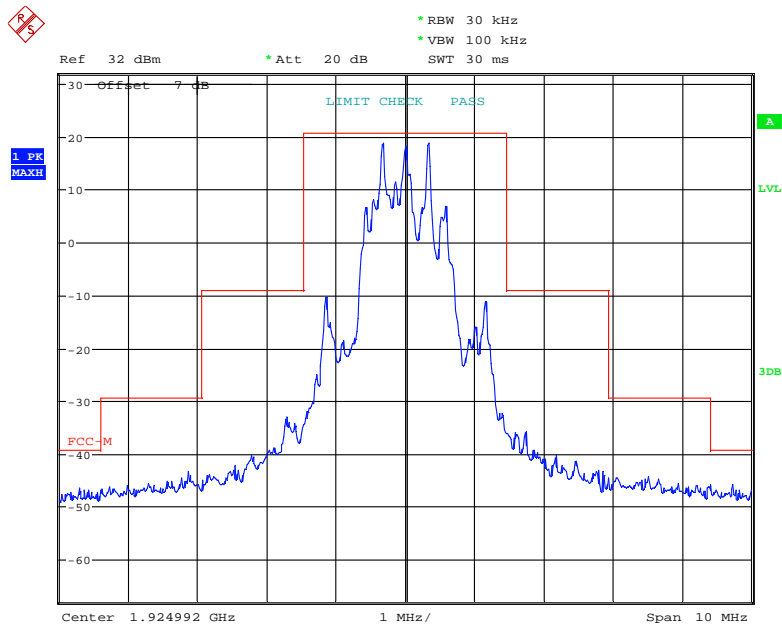

Date: 10.MAY.2021 10:24:08

### High Channel (Unwanted Emission inside the Sub-band)

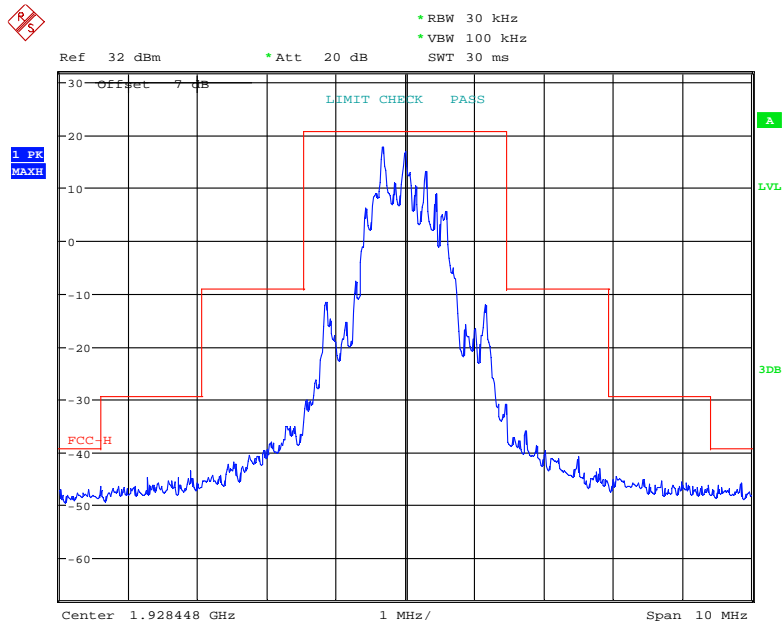

Date: 10.MAY.2021 10:28:04

### ISED:

### Low Channel (Unwanted Emission inside the Sub-band)

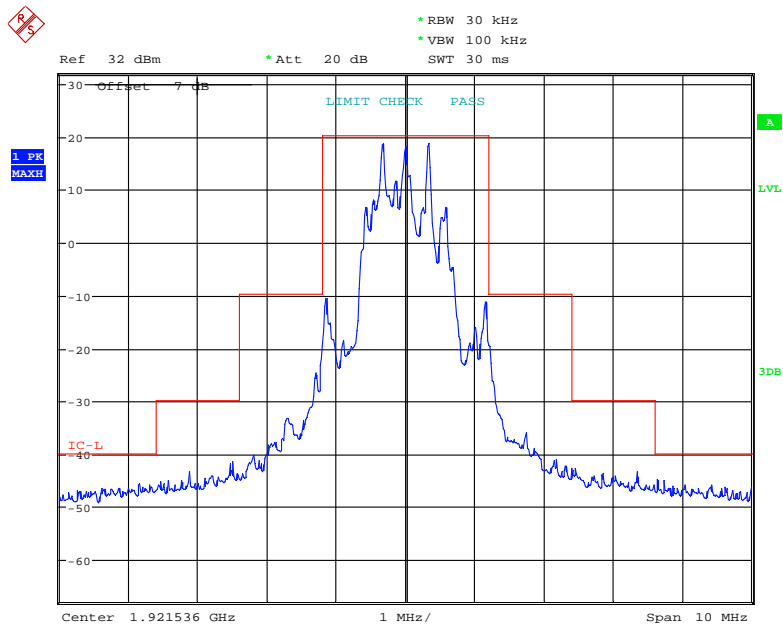

Date: 10.MAY.2021 10:36:58

### Middle Channel (Unwanted Emission inside the Sub-band)

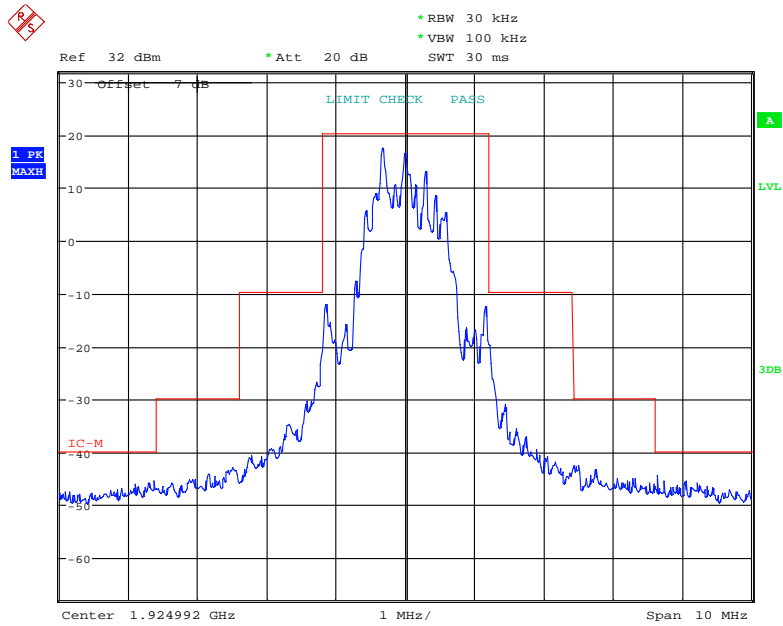

Date: 10.MAY.2021 11:31:37

### High Channel (Unwanted Emission inside the Sub-band)

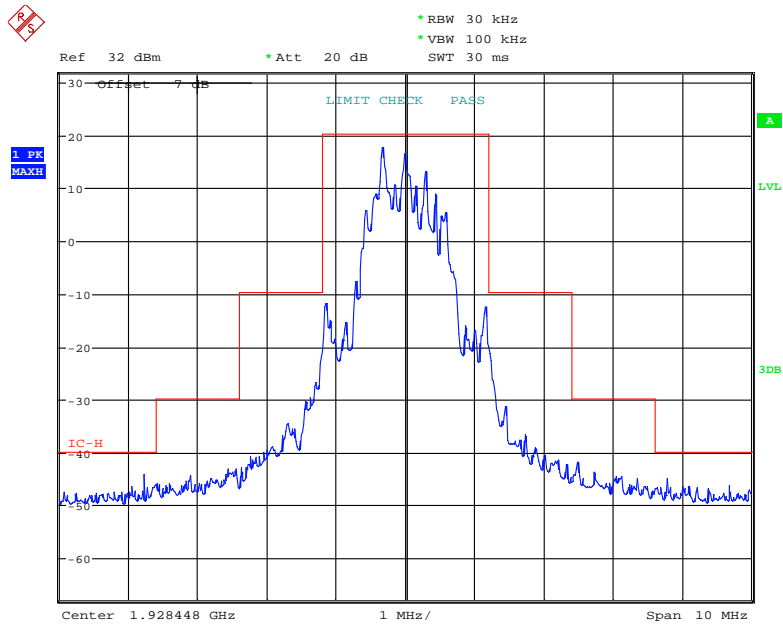

Date: 10.MAY.2021 11:34:04



### Low Channel (Unwanted Emission outside the Sub-band)

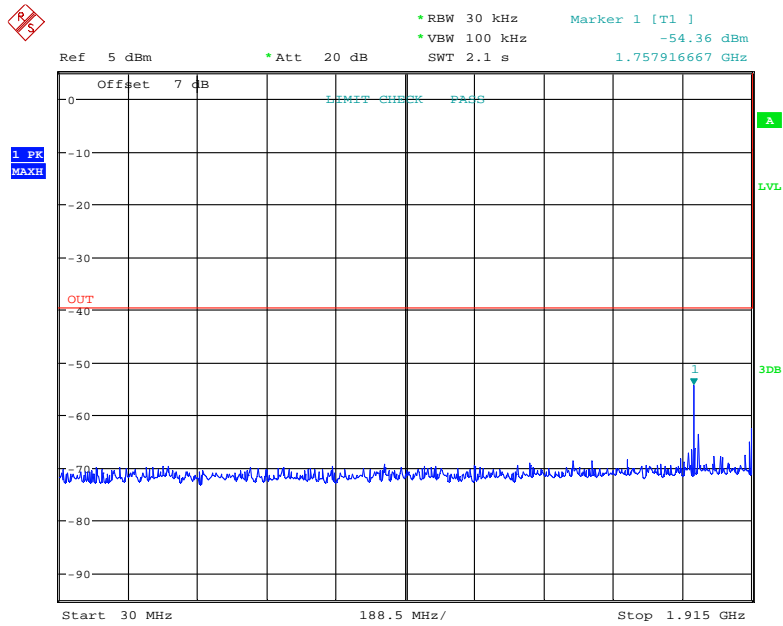

Date: 10.MAY.2021 11:43:12

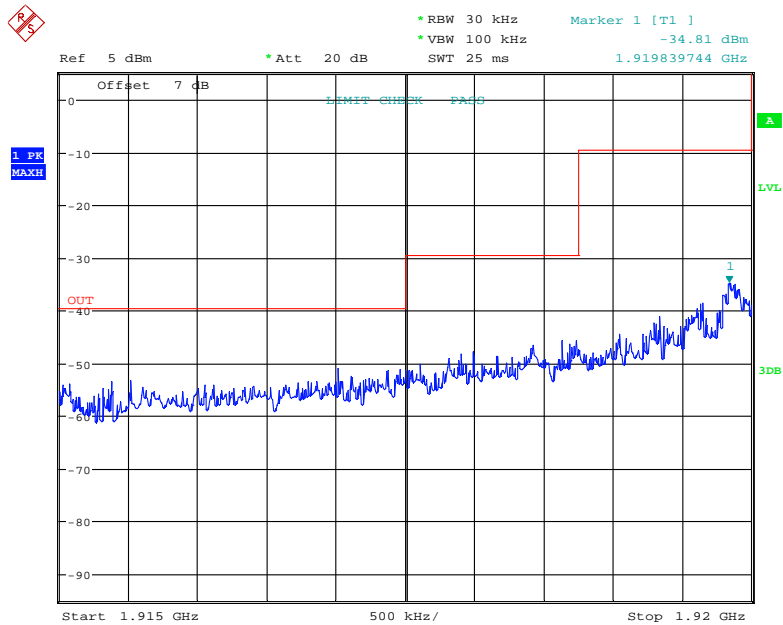

Date: 10.MAY.2021 11:43:45

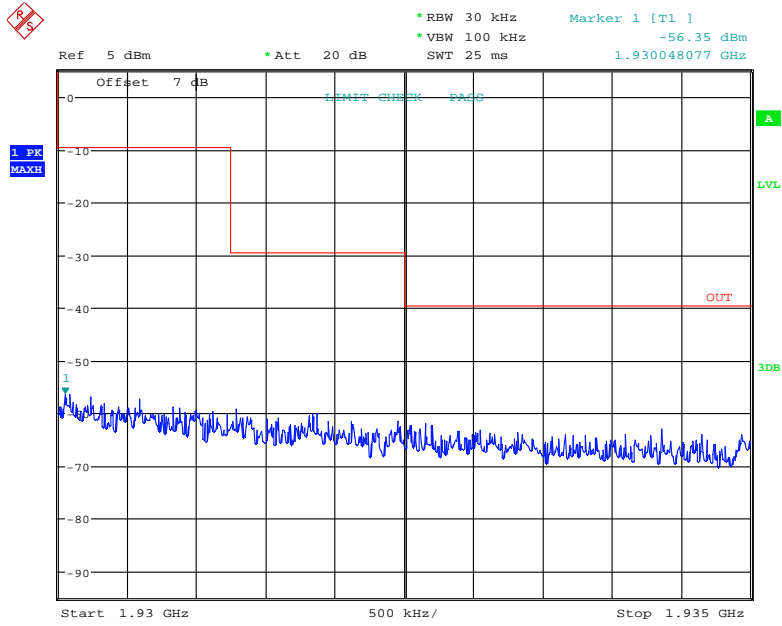

Date: 10.MAY.2021 11:44:12

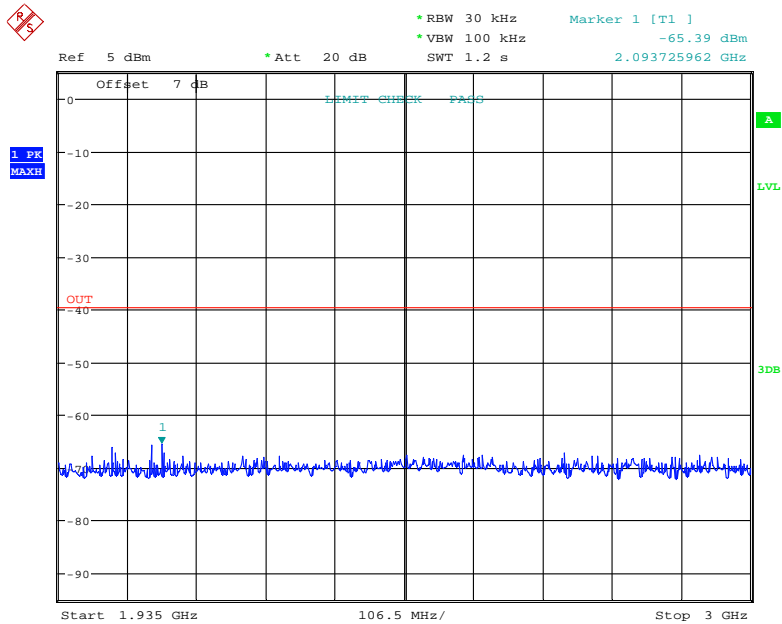

Date: 10.MAY.2021 11:44:38

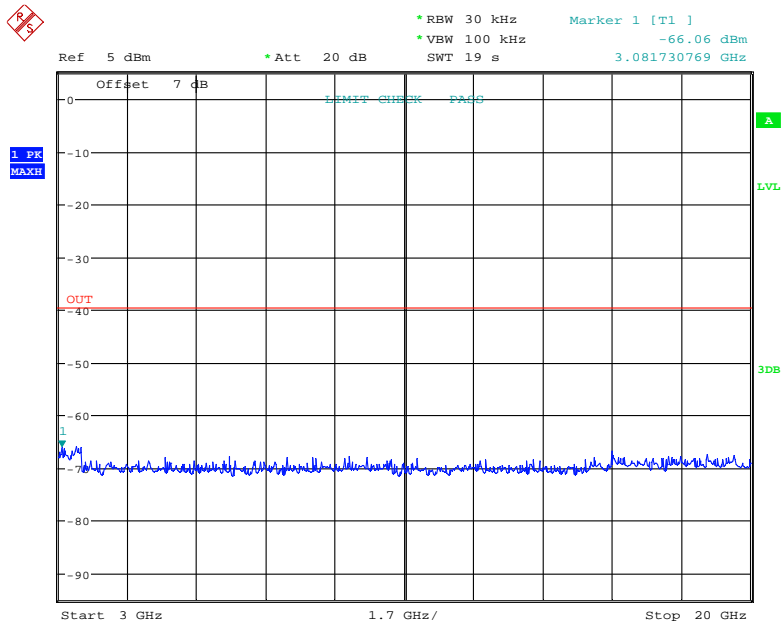

Date: 10.MAY.2021 11:45:17

**Middle Channel (Unwanted Emission outside the Sub-band)**

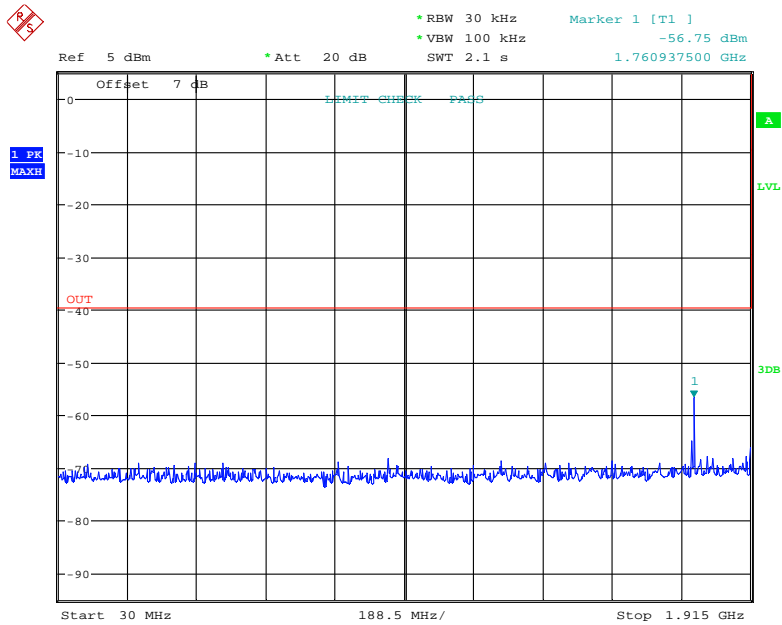

Date: 10.MAY.2021 11:42:31

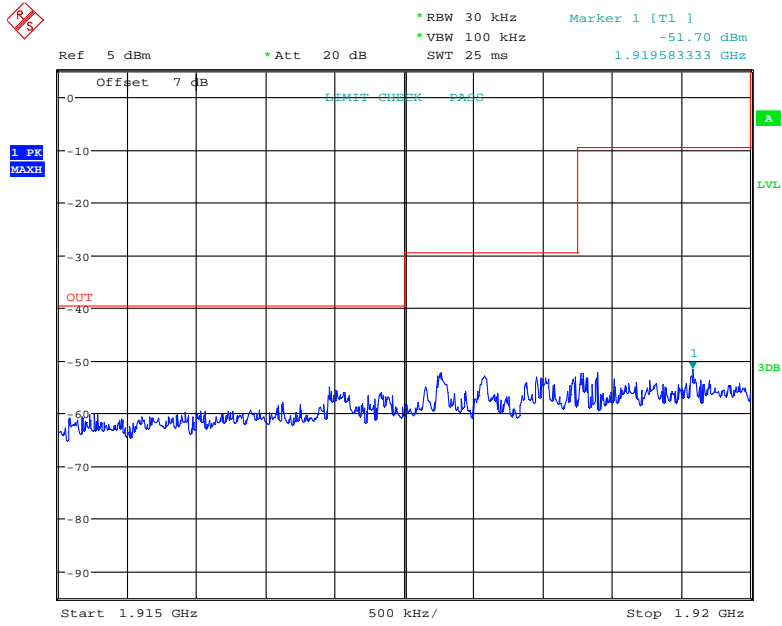

Date: 10.MAY.2021 11:42:03

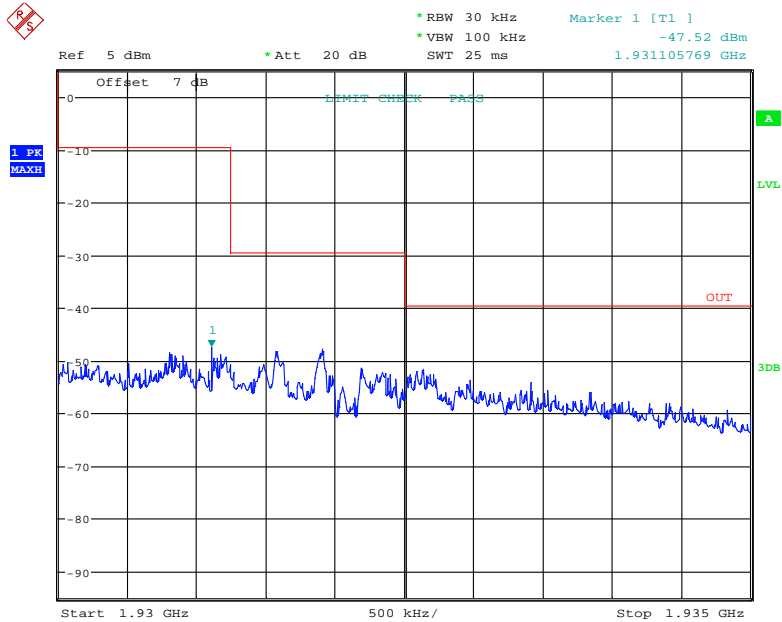

Date: 10.MAY.2021 11:41:22

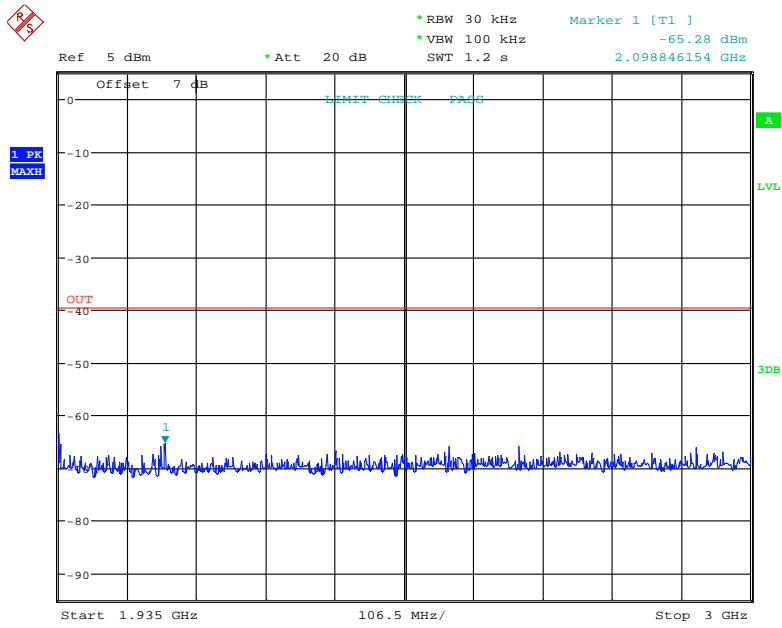

Date: 10.MAY.2021 11:40:42

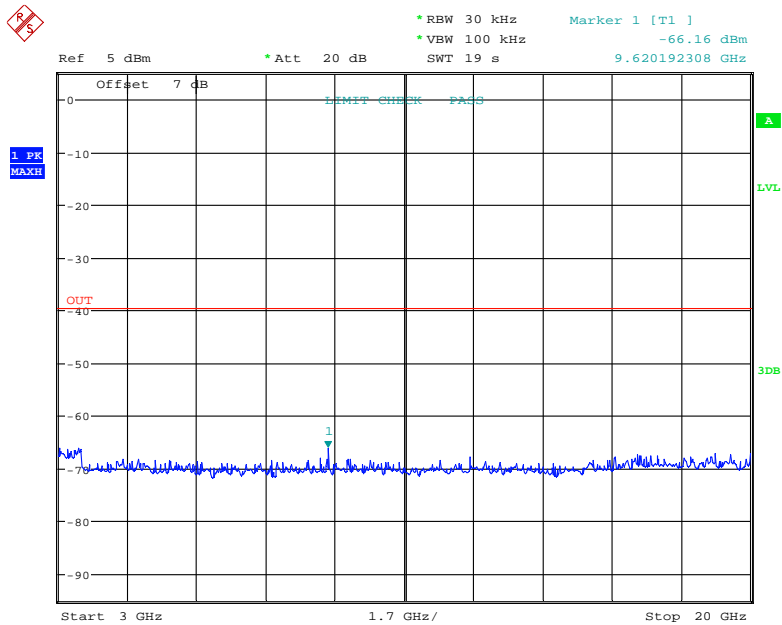

Date: 10.MAY.2021 11:40:21

**High Channel (Unwanted Emission outside the Sub-band)**

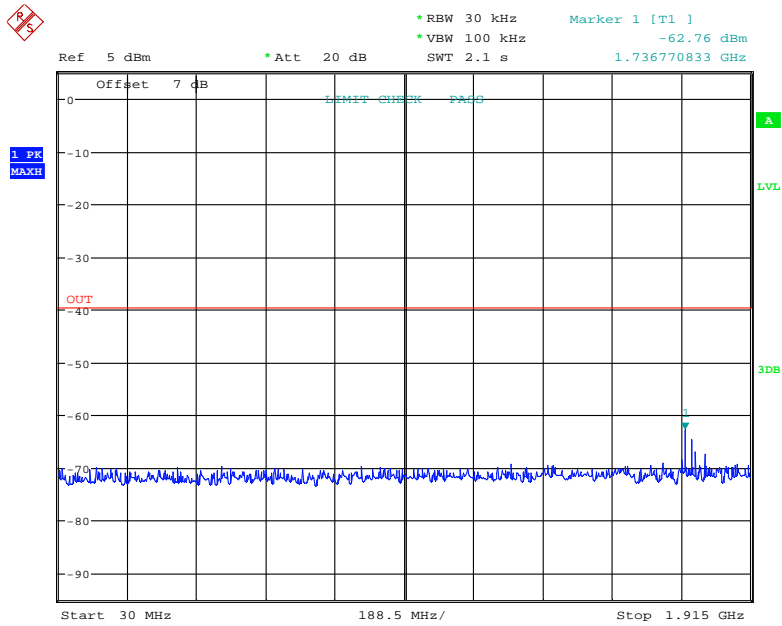

Date: 10.MAY.2021 11:35:10

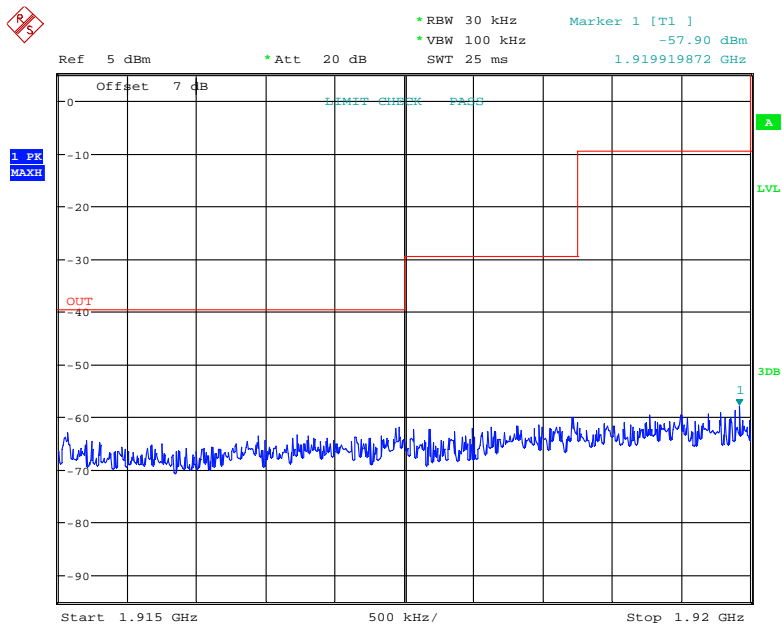

Date: 10.MAY.2021 11:35:44

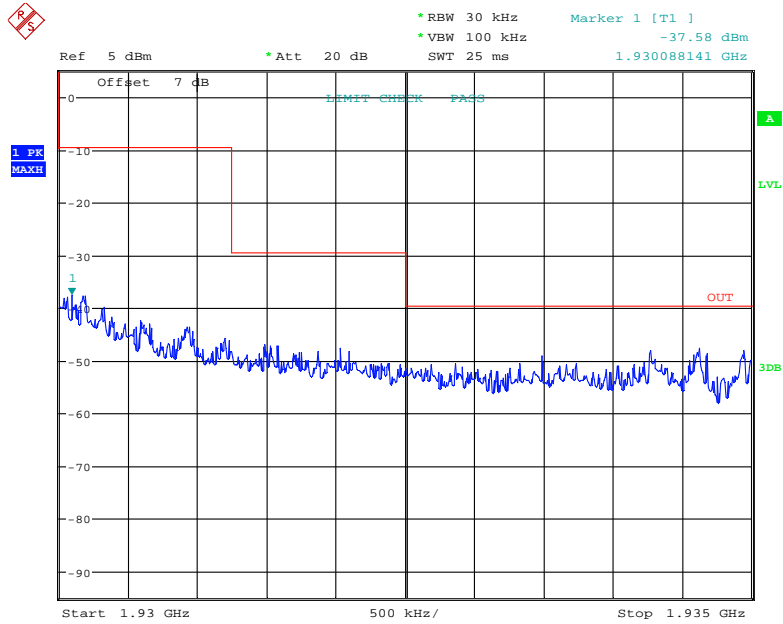

Date: 10.MAY.2021 11:36:26

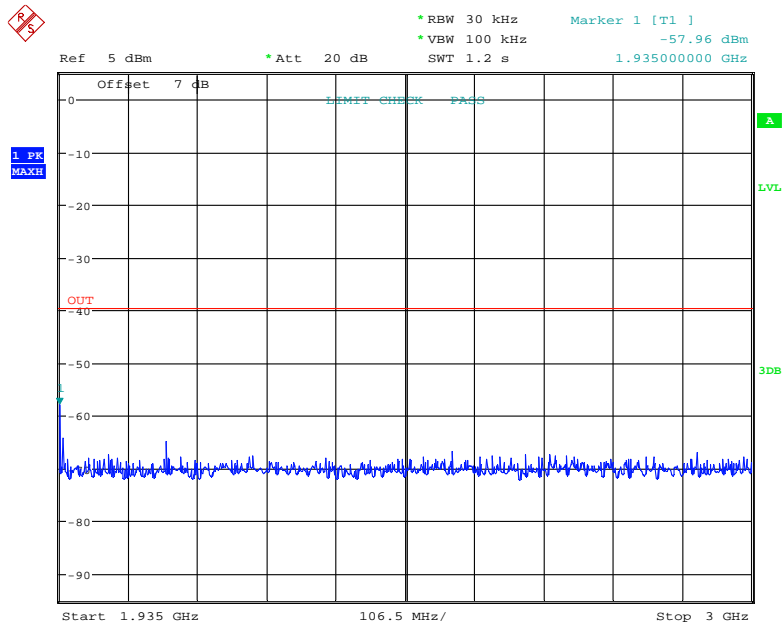

Date: 10.MAY.2021 11:37:02

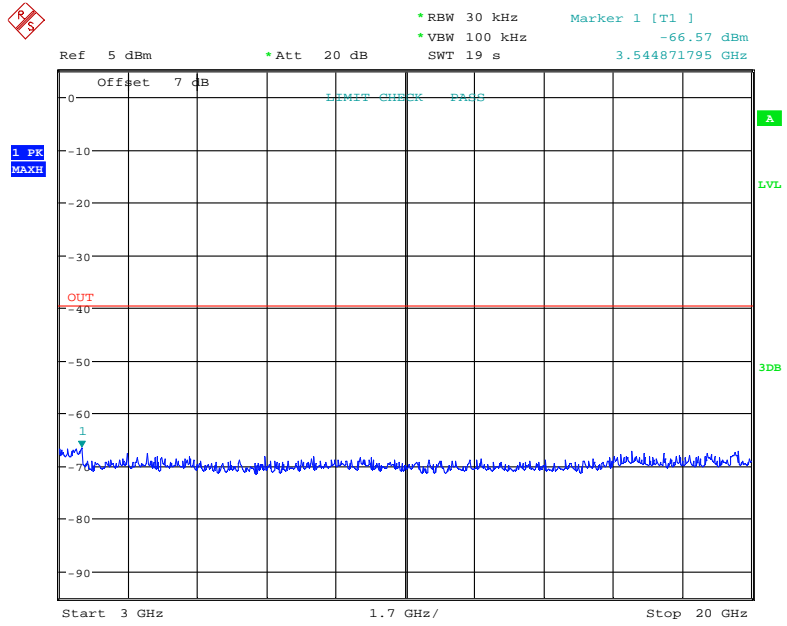

Date: 10.MAY.2021 11:38:50



30MHz-1GHz: (High channel was worst case)

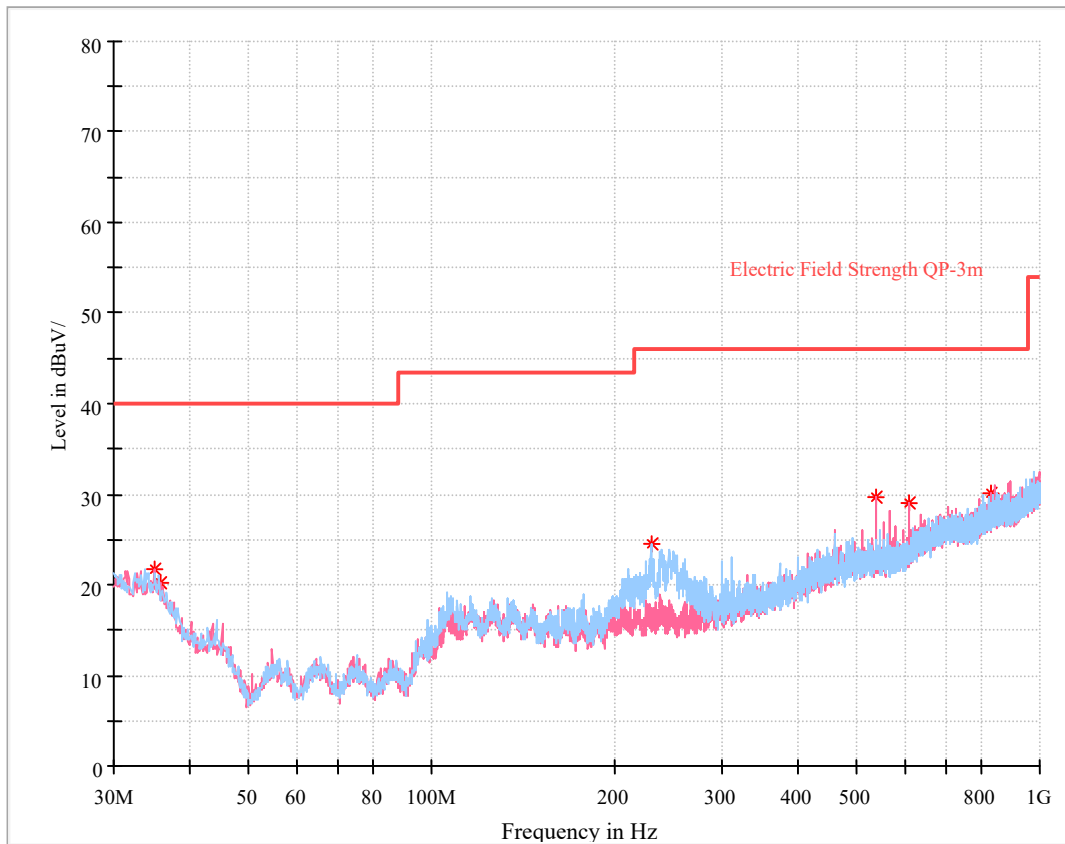

**Critical Freqs**

Frequency (MHz)	MaxPeak (dB $\mu$ V/m)	Limit (dB $\mu$ V/m)	Margin (dB)	Height (cm)	Pol	Azimuth (deg)	Corr. (dB)
34.971250	21.68	40.00	18.32	300.0	V	311.0	-7.3
35.820000	20.13	40.00	19.87	400.0	V	69.0	-7.8
229.335000	24.55	46.00	21.45	100.0	H	97.0	-11.5
539.128750	29.63	46.00	16.37	100.0	V	301.0	-4.7
608.241250	28.96	46.00	17.04	100.0	V	350.0	-4.1
833.523750	30.07	46.00	15.93	100.0	V	208.0	0.0

**1 GHz ~ 20 GHz:**

Frequency (MHz)	Receiver		Turntable Degree	Rx Antenna		Corrected Factor (dB/m)	Corrected Amplitude (dBµV/m)	Limit (dBµV/m)	Margin (dB)
	Reading (dBµV)	Detector (PK/QP/Ave.)		Height (m)	Polar (H/V)				
Low Channel (1921.536 MHz)									
1921.536	67.61	PK	95	1.9	H	30.71	98.32	/	/
1921.536	74.61	PK	113	2.2	V	30.71	105.32	/	/
3843.07	45.13	PK	299	1.8	H	3.95	49.08	74	24.92
3843.07	45.39	PK	251	1.5	V	3.95	49.34	74	24.66
Middle Channel (1924.992 MHz)									
1924.992	67.27	PK	54	2.2	H	30.71	97.98	/	/
1924.992	74.53	PK	326	1.4	V	30.71	105.24	/	/
3849.98	45.02	PK	277	2.4	H	3.95	48.97	74	25.03
3849.98	45.17	PK	341	1.6	V	3.95	49.12	74	24.88
High Channel (1928.448 MHz)									
1928.448	67.83	PK	48	1.3	H	30.71	98.54	/	/
1928.448	74.89	PK	63	2.0	V	30.71	105.60	/	/
3856.90	44.12	PK	81	1.5	H	4.10	48.22	74	25.78
3856.90	44.53	PK	163	1.8	V	4.10	48.63	74	25.37

Frequency (MHz)	Peak value@3m (dBμV/m)	Rx Antenna	Corrected Factor (dB)	Corrected Amplitude (dBμV/m)	RSS213	
		Polar (H / V)			Limit (dBμV/m)	Margin (dB)
Average						
Low Channel(1921.536MHz)						
1921.536	98.32	H	-26.36	71.96	/	/
1921.536	105.32	V	-26.36	78.96	/	/
3843.08	49.08	H	-26.36	22.72	54	31.28
3843.08	49.34	V	-26.36	22.98	54	31.02
Middle Channel(1924.992MHz)						
1924.992	97.98	H	-26.36	71.62	/	/
1924.992	105.24	V	-26.36	78.88	/	/
3849.98	48.97	H	-26.36	22.61	54	31.39
3849.98	49.12	V	-26.36	22.76	54	31.24
High Channel(1928.448MHz)						
1928.448	98.54	H	-26.36	72.18	/	/
1928.448	105.60	V	-26.36	79.24	/	/
3856.90	48.22	H	-26.36	21.86	54	32.14
3856.90	48.63	V	-26.36	22.27	54	31.73

**Note:**

Corrected Amplitude = Corrected Factor + Reading

Corrected Factor=Antenna factor (RX) + Cable loss - Amplifier factor

Margin = Limit- Corr. Amplitude

Duty cycle:

Ton1 =480.77us

Tp = 10.00 ms

Duty cycle = Ton/Tp = 0.48077/10.000=0.048077

Duty Cycle Corrected Factor = 20lg (Duty cycle) = -26.36

### Duty Cycle

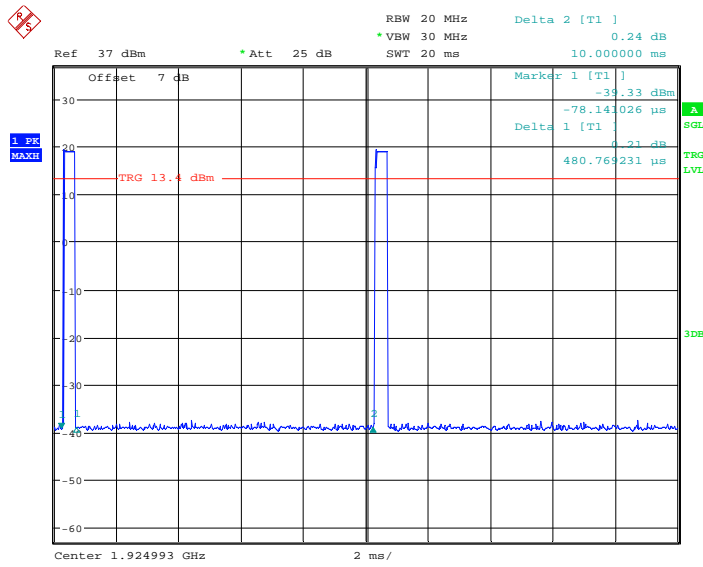

Date: 10.MAY.2021 10:13:57

### Pre-scan with the Low Channel Horizontal (1-18 GHz)

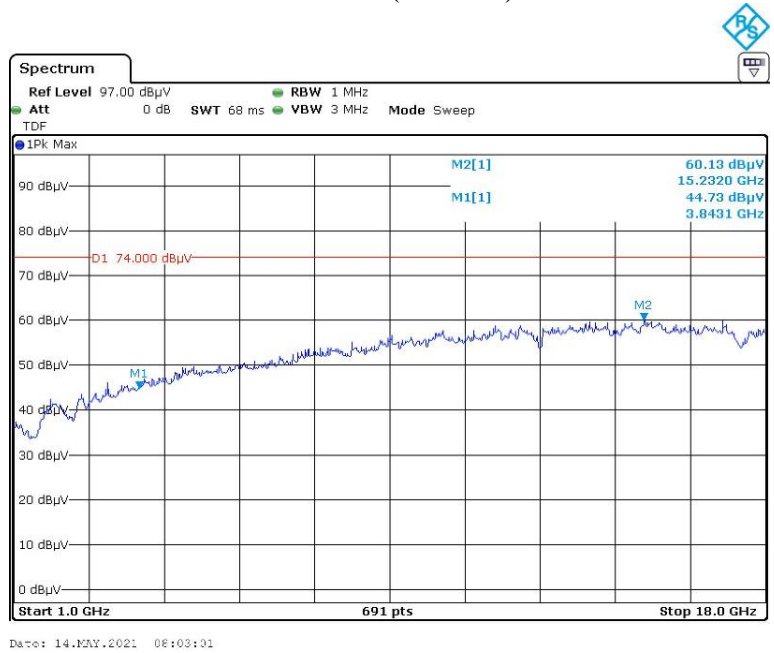

### Horizontal (18-20 GHz)

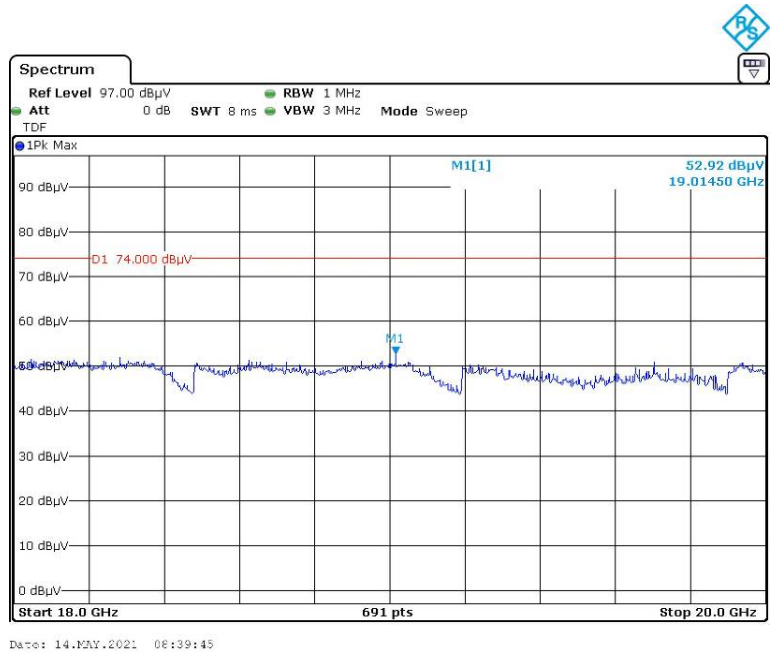

### Vertical (1-18 GHz)

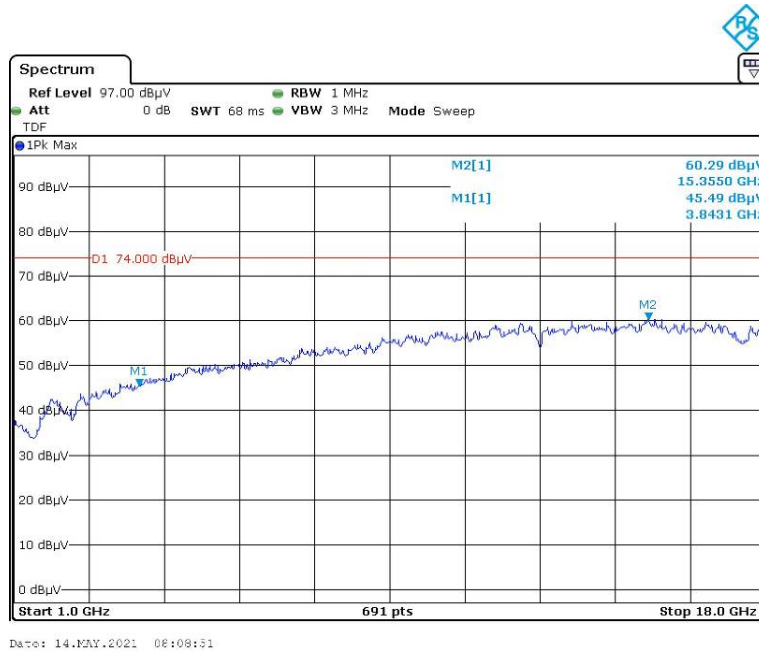

### Vertical (18-20 GHz)

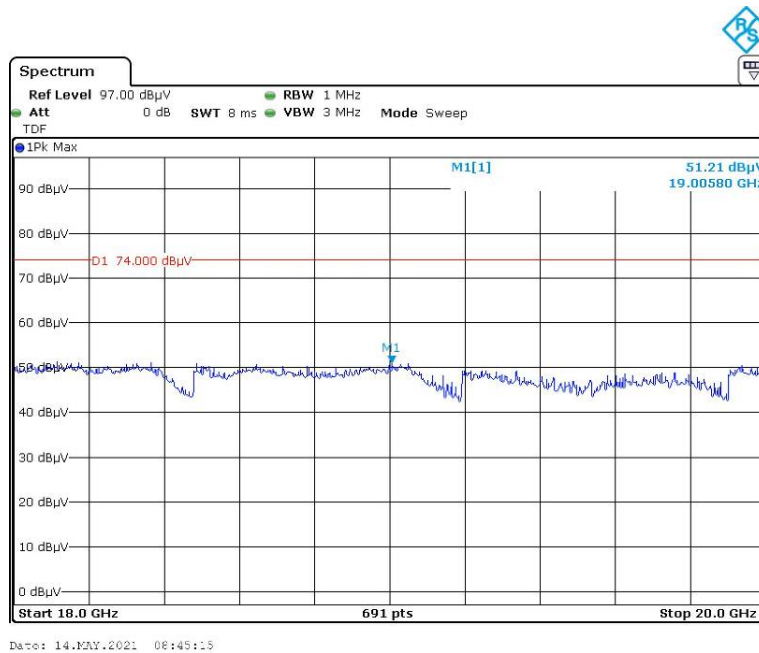

## § 15.323 (f) & RSS-213 §5.3 FREQUENCY STABILITY

### Applicable Standard

Per §15.323(f), the frequency stability of the carrier frequency of the intentional radiator shall be maintained within  $\pm 10$  ppm over 1 hour or the interval between channel access monitoring, whichever is shorter. The frequency stability shall be maintained over a temperature variation of  $-20^{\circ}\text{C}$  to  $+50^{\circ}\text{C}$  at normal supply voltage, and over a variation in the primary supply voltage of 85 percent to 115 percent of the rated supply voltage at a temperature of  $20^{\circ}\text{C}$ . For equipment that is capable only of operating from a battery, the frequency stability tests shall be performed using a new battery without any further requirement to vary supply voltage

According to RSS-213 Issue 3 (2015-03) § (5.3):  
The carrier frequency stability shall be maintained within  $\pm 10$  ppm ( $\pm 0.001\%$ ).

According to RSS-Gen Issue 5 (2021-02) § (8.11):  
Transmitter frequency stability for licence-exempt radio apparatus shall be measured in accordance with Section 6.11. For licence-exempt radio apparatus, the frequency stability shall be measured at temperatures of  $-20^{\circ}\text{C}$  ( $-4^{\circ}\text{F}$ ),  $+20^{\circ}\text{C}$  ( $+68^{\circ}\text{F}$ ) and  $+50^{\circ}\text{C}$  ( $+122^{\circ}\text{F}$ ) instead of at the temperatures specified in Section 6.11.

### Test Procedure

This procedure should be carried out for each of the following test cases:

Temperature	Supply Voltage
$20^{\circ}\text{C}$	85-115% or new batteries
$-20^{\circ}\text{C}$	Normal
$+50^{\circ}\text{C}$	Normal

During test, the equipment shall be placed in the boxes and set the temperature to the specified requirement until the thermal balance has been reached.

Using the mean carrier frequency at  $20^{\circ}\text{C}$  and at nominal supply voltage as the reference, the mean carrier frequency shall be maintained within  $\pm 10$  ppm at the two extreme temperatures (or as declared by the manufacturer) and at normal temperature (typically  $20^{\circ}\text{C}$ ) at the two extreme supply voltages. This test does not apply to a EUT that is capable only of operating from a battery.

**Test Data****Environmental Conditions**

<b>Temperature:</b>	25 °C
<b>Relative Humidity:</b>	61 %
<b>ATM Pressure:</b>	101.0 kPa

*The testing was performed by Andy Yu on 2021-05-10.*

**Test Result: Pass**

*Test mode: Transmitting*

<b>Temperature (°C)</b>	<b>Voltage (V<sub>DC</sub>)</b>	<b>Frequency (MHz)</b>	<b>Measured Frequency Offset (kHz)</b>	<b>Measured Frequency Offset (ppm)</b>	<b>Limit (ppm)</b>
L.T.	N.V.	1924.992	5	2.6	±10
N.T.	L.V.	1924.992	7	3.64	±10
	H.V.	1924.992	6	3.12	±10
H.T.	N.V.	1924.992	7	3.64	±10



**§ 15.323 (c)(e) § 15.319 (f) & RSS-213 §5.1&§5.2 SPECIFIC REQUIREMENTS FOR UPCS DEVICE**

**Applicable Standard**

FCC§15.323(c)(e) & §15.319(f) Specific Requirements for UPCS device.  
ANSI C63.17 2013 §6.2 Frequency and time stability and §7.Monitoring tests and §8.Time and spectrum window access procedure.

According to RSS-213 §5.1&§5.2 type of modulation and access protocol  
Equipment certified under this standard shall use digital modulation.  
In order to provide equitable access to the radio frequency spectrum, the licence-exempt PCS device must possess an access protocol.

**Test Procedure**

Measurement method according to ANSI C63.17- 2013

Test configuration as below

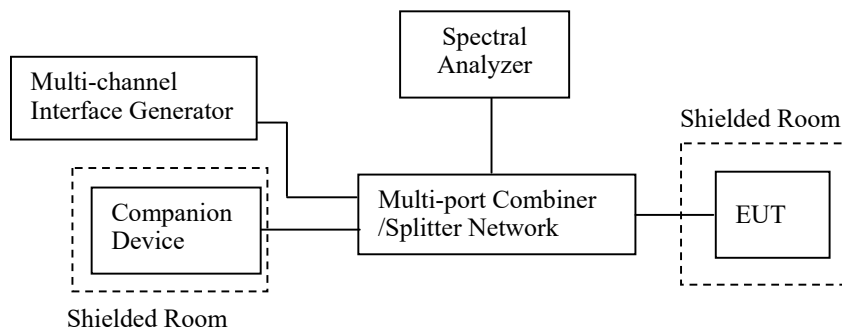

**Test Data**

**Environmental Conditions**

<b>Temperature:</b>	25 °C
<b>Relative Humidity:</b>	61 %
<b>ATM Pressure:</b>	101.0 kPa

*The testing was performed by Andy Yu on 2021-05-10.*

**Test Result: Pass**

*Please see the below data*

### 1) Automatic Discontinuation of Transmission

The device shall automatically discontinue transmission in case of either absence of information to transmit or operational failure. The provisions in this section are not intended to preclude transmission of control and signaling information or use of repetitive codes used by certain digital technologies to complete frame or burst intervals.

#### Test result:

The following tests were performed after a connection had been established with Base.

Test condition	Reaction of EUT	Pass/Fail
Adapter removed from Base	Connection break down	Pass
Battery removed from handset	Connection break down	Pass

### 2) Monitoring Time

Immediately prior to initiating transmission, devices must monitor the combined time and spectrum window in which they intend to transmit. For a period of at least 10 milliseconds for systems designed to use a 10 milliseconds or shorter frame period or at least 20 milliseconds for systems designed to use a 20 milliseconds frame period

#### Test procedure:

Measurement method is in according to ANSI C63.17 -2013 clause 7.3.3.

RF signal generators apply uniform CW interference on all system carriers except two carriers (designated  $f_1$  and  $f_2$ ), each at level  $T_L + U_M$ . EUT can only transmit on these two carriers.

#### Test result:

This requirement is covered by the results of Least Interfered Channel (LIC).

Interference (Refer to ANSI C63.17 clause 7.3.3)	Reaction of EUT	Results
a) Apply the interference on $f_1$ at level $T_L + U_M + 20\text{dB}$ and no interference on $f_2$ . Initiate transmission and verify the transmission only on $f_2$ . Then terminate it.	EUT transmits on $f_2$	Pass
b) Apply the interference on $f_2$ at level $T_L + U_M + 20\text{dB}$ and immediately remove all interference from $f_1$ . The EUT should immediately attempt transmission on $f_1$ (but at least 20 ms after the interference on $f_2$ is applied), verify the transmission only on $f_1$ .	EUT transmission $f_1$	Pass

### 3) Lower Monitoring Threshold

The monitoring threshold must not be more than 30 dB above the thermal noise power for a bandwidth equivalent to the emission bandwidth used by the device.

#### Test procedure:

Measurement method according to ANSI C63.17 -2013 clause 7.3.1

**Test result:**

Not applicable because the EUT has more 40 defined duplex system access channels and meet the provision of the Least Interfered Channel (LIC).

**4) Maximum Transmit Period**

If no signal above the threshold level is detected, transmission may commence and continue with the same emission bandwidth in the monitored time and spectrum windows without further monitoring. However, occupation of the same combined time and spectrum windows by a device or group of cooperating devices continuously over a period of time longer than 8 hours is not permitted without repeating the access criteria.

**Test procedure:**

The test procedure is as follows:

- a) Activate the EUT and initiate a communication channel with the companion device, and start a timer or frame counter.
- b) The centre frequency of spectrum analyzer was set to the carrier frequency and SPAN was set to ZERO. The spectrum analyzer was used to monitor the time and spectrum window of the communication channel.
- c) Stop the timer at the end of the EUT transmission on the current time and frequency window (measure the time until the EUT changes to a different slot).

**Test result:**

Repetition of Access Criteria	Measured Maximum Transmission Time (Second)	Limit (Second)	Results
First	17680	28,800	Pass
Second	17680	28,800	Pass

**5) System Acknowledgement**

Once access to specific combined time and spectrum windows is obtained an acknowledgment from a system participant must be received by the initiating transmitter within one second or transmission must cease.

Periodic acknowledgments must be received at least every 30 seconds or transmission must cease. Channels used exclusively for control and signaling information may transmit continuously for 30 seconds without receiving an acknowledgment, at which time the access criteria must be repeated.

**Test procedure:**

Measurement method according to ANSI C63.17 2013 clause 8.1, 8.2, 8.2.1

During testing initial transmission without acknowledgement, the signal from the EUT to the companion device is blocked by the circulator.

The test of the transmission time after loss of acknowledgements is performed by cutting off the signal from the companion device by a RF switch and measuring the time until the EUT stops transmitting.

**Test result:**

Test	Time taken (second)	Limit (second)	Result
Initial Connection acknowledgement	0.35	1	Pass
Change of access criteria for control information	N/A	30	N/A
Transmission cease time after loss of acknowledgement	4.11	30	Pass

Note: N/A=Not Applicable

**6) Least Interfered Channel (LIC)**

If access to spectrum is not available as determined by the above, and a minimum of 20 duplex system access channels are defined for the system, the time and spectrum windows with the lowest power level may be accessed.

A device utilizing the provisions of this paragraph (5) must have monitored all access channels defined for its system within the last 10 seconds and must verify, within the 20 milliseconds (40 milliseconds for devices designed to use a 20 millisecond frame period) immediately preceding actual channel access, that the detected power of the selected time and spectrum windows is no higher than the previously detected value.

The power measurement resolution bandwidth for this comparison must be accurate to within 6 dB. No device or group of cooperating devices located within 1 metre of each other shall during any frame period occupy more than 6 MHz of aggregate bandwidth, or alternatively, more than one third of the time and spectrum windows defined by the system.

Calculation of monitoring threshold limits for isochroous devices:

Lower threshold:  $T_L = -174 + 10\log_{10}B + M_L + P_{MAX} - P_{EUT}$  (dBm)

Where: B=Emission bandwidth (Hz)

$M_L$  = dB the threshold may exceed thermal noise (30 for  $T_L$ )

$P_{MAX} = 5\log_{10}B - 10$  (dBm)

$P_{EUT}$  = Transmitted power (dBm)

**Calculated thresholds:**

Monitor Threshold	B(MHz)	M <sub>L</sub> (dB)	P <sub>MAX</sub> (dBm)	P <sub>EUT</sub> (dBm)	Threshold (dBm)
Lower threshold	1.471	30	20.84	19.54	-81.02

Note: 1. The upper threshold is applicable as the EUT utilizes more than 20 duplex system channels

**Test procedure:**

Measurement method according to ANSI C63.17 clause 7.3.2, 7.3.3

**C63.17 clause 7.3.2, LIC procedure test:**

- a) Allow EUT transmission on only two carrier frequencies, which will be designated  $f_1$  and  $f_2$ .
- b) Apply interference to the EUT on  $f_1$  at a level of  $TL + UM + 7$  dB and on  $f_2$  at a level of  $TL + UM$ . Initiate transmission. The EUT should transmit on  $f_2$ . Terminate the connection. Repeat five times. If the EUT transmits once on  $f_1$ , the test failed.
- c) Apply interference to the EUT on  $f_1$  at a level of  $TL + UM$  and on  $f_2$  at a level of  $TL + UM + 7$  dB. Initiate transmission. The EUT should transmit on  $f_1$ . Terminate the connection. Repeat five times. If the EUT transmits once on  $f_2$ , the test failed.
- d) Apply interference to the EUT on  $f_1$  at a level of  $TL + UM + 1$  dB and on  $f_2$  at a level of  $TL + UM - 6$  dB. Initiate transmission. If the EUT transmits on  $f_2$ , terminate the connection. Repeat five times. If the EUT transmits once on  $f_1$ , the test failed.
- e) Apply interference to the EUT on  $f_1$  at a level of  $TL + UM - 6$  dB and on  $f_2$  at a level of  $TL + UM + 1$  dB. Initiate transmission. If the EUT transmits on  $f_1$ , terminate the connection. Repeat five times. If the EUT transmits once on  $f_2$ , the test failed.

**C63.17 clause 7.3.3, Selected channel confirmation:**

- a) Allow EUT transmission on only two carrier frequencies, which will be designated  $f_1$  and  $f_2$ . This limitation to carriers  $f_1$  and  $f_2$  is performed preferably by administration commands for the EUT, or alternatively by applying by a multicarrier interference generator uniform interference on all system carriers except  $f_1$  and  $f_2$ , at a level of  $TL + UM + 20$  dB in-band per carrier. Set the interference level to the EUT on  $f_1$  to a level of  $TL + UM + 20$ dB, and let there be no interference applied on  $f_2$ .
- b) Initiate transmission and verify that the EUT transmits on  $f_2$ . If a connection was made, terminate it.
- c) Apply interference on  $f_2$  at a level of  $TL + UM + 20$  dB in-band, and immediately remove all interference from  $f_1$  and immediately (but not sooner than 20 ms after the interference on  $f_2$  is applied) cause the EUT to attempt transmission. The EUT should now transmit on  $f_1$ , if it transmits.
- d) If the EUT transmits on  $f_2$ , it fails.

**Test result:**

**1) LIC procedure test:**

Interference (Refer to ANSI C63.17 clause 7.3.3)	Reaction of EUT	Results
a) Apply the interference on $f_1$ at level $T_L+U_M+7\text{dB}$ and the interference on $f_2$ at level $T_L+U_M$ . Initiate transmission and verify the transmission only on $f_2$ . Repeat 5 times.	EUT transmits on $f_2$	Pass
b) Apply the interference on $f_1$ at level $T_L+U_M$ and the interference on $f_2$ at level $T_L+U_M+7\text{dB}$ . Initiate transmission and verify the transmission only on $f_1$ . Repeat 5 times.	EUT transmits on $f_1$	Pass
c) Apply the interference on $f_1$ at level $T_L+U_M+1\text{dB}$ the interference on $f_2$ at level $T_L+U_M-6\text{dB}$ . Initiate transmission and verify the transmission only on $f_2$ . Repeat 5 times.	EUT transmits on $f_2$	Pass
d) Apply the interference on $f_1$ at level $T_L+U_M-6\text{dB}$ and the interference on $f_2$ at level $T_L+U_M+1\text{dB}$ . Initiate transmission and verify the transmission only on $f_1$ . Repeat 5 times.	EUT transmits on $f_1$	Pass

**2) Selected channel confirmation:**

Interference (Refer to ANSI C63.17 clause 7.3.4)	Reaction of EUT	Results
a) Apply the interference on $f_1$ at level $T_U+U_M$ and no interference on $f_2$ . Initiate transmission and verify the transmission only on $f_2$ . Then terminate it.	EUT transmits on $f_2$	Pass
b) Apply the interference on $f_2$ at level $T_L+U_M$ and immediately remove all interference from $f_1$ . The EUT should immediately attempt transmission on $f_1$ (but at least 20 ms after the interference on $f_2$ is applied), verify the transmission only on $f_1$ .	EUT transmission $f_1$	Pass

**7) Random waiting**

If the selected combined time and spectrum windows are unavailable, the device may either monitor and select different windows or seek to use the same window after waiting an amount of time, randomly chosen from a uniform random distribution between 10 and 150 milliseconds, commencing when the channel becomes available.

**Test procedure:**

This test is for EUTs that transmit control and signaling channels and that use the provisions of FCC §15.323(c)(6) & IC RSS-213 5.2(6), thus to verify that the EUT (if in deferral) waits for a channel to go clear, then implements a 10 ms to 150 ms hold off prior to using the channel. FCC §15.323(c)(6) is not restrictive for EUTs that use the LIC and offer 20 or more duplex communications channels, as a combined time and spectrum window cannot become unavailable as there is no threshold limit. Test method according to ANSI C63.17 2013 clause 8.1.2 or 8.1.3

- a) Restrict operation of the EUT to a single carrier designated  $f_1$ . For TDMA system, further restrict EUT transmission to a single timeslot of the usable timeslots available in the TDMA frame structure and synchronize the interference so as to occur centered within the timeslot.

- b) Activate the EUT with no interference present. The EUT must transmit on  $f_1$ . Then apply CW interference on  $f_1$ . The interference level shall be at  $TL + UM$  as appropriate for EUTs that do or do not meet the requirements for using the upper threshold. The EUT must stop transmitting within 30 s.
- c) Cancel the interference. Measure the time interval between the end of the interference transmission and the beginning of transmission by the EUT.
- d) Repeat step b) and step c) 100 times. If the measured time intervals vary uniformly between 10 ms and 150 ms, the EUT passes the test.

Note: This is Not Applicable

### 8) Monitoring Bandwidth and Reaction Time

The monitoring system bandwidth must be equal to or greater than the emission bandwidth of the intended transmission and have a maximum reaction time less than  $50 \times \text{SQRT}(1.25/\text{emission bandwidth in MHz})$  microseconds for signals at the applicable threshold level but shall not be required to be less than 50 microseconds.

**Note:** Testing of the monitoring system bandwidth is not required if the designed bandwidth from the manufacturer is available and given in the test report.

The maximum reaction time of the monitor shall be less than  $50 \sqrt{1.25/\text{occupied bandwidth in MHz}}$   $\mu\text{s}$  for signals at the applicable threshold level but shall not be required to be less than 50  $\mu\text{s}$ .

If a signal of 6 dB or more above the threshold level is detected, the maximum reaction time shall be  $35 \sqrt{1.25/\text{occupied bandwidth in MHz}}$   $\mu\text{s}$  but shall not be required to be less than 35  $\mu\text{s}$ .

#### Test procedure:

Measurement method according to ANSI C63.17 2013 clause 7.4 & 7.5

- a) Restrict the EUT to a single transmit carrier frequency  $f_1$ , and verify that the EUT can establish a connection with no interference applied on  $f_1$ .
- b) Apply time-synchronized, pulsed interference on  $f_1$  at the pulsed level  $TL + UM$ , verify that the EUT does not establish a connection when the width of the interference pulse exceeds the largest of 50  $\mu\text{s}$  and  $50 \sqrt{1.25/B}$   $\mu\text{s}$ , where  $B$  is the emission bandwidth of the EUT in megahertz.
- c) With the channel interference level 6 dB above  $TL + UM$ , verify that the EUT does not establish a connection when the width of the interference pulse exceeds the largest of 35  $\mu\text{s}$  and  $35 \sqrt{1.25/B}$   $\mu\text{s}$ , where  $B$  is the emission bandwidth of the EUT in megahertz.

Test Pulse width Equation ( $\mu\text{s}$ )	B(bandwidth) (MHz)	Pulse width ( $\mu\text{s}$ )	Limit (largest) ( $\mu\text{s}$ )
$50 (1.25/B)^{1/2}$	1.471	46.09	50
$35 (1.25/B)^{1/2}$	1.471	32.26	35

**Test result:****1) Monitoring Bandwidth:**

The antenna of the EUT used for monitoring is the same interior antenna that used for transmission, so the monitoring system bandwidth is equal to the emission bandwidth of the intended transmission

**2) Reaction Time Test:**

No.	Interference Pulse width (μs)	Reaction of EUT	Observing time (μs)	Result
1	50μs with level $T_L+U_M$	No transmission	25.35	Pass
2	35μs with level $T_L+U_M+6dB$	No transmission	20.20	Pass

**9) Monitoring Antenna**

The monitoring system shall use the same antenna used for transmission, or an antenna that yields equivalent reception at that location.

**Test procedure:**

Measurement method according to ANSI C63.17 -2013 paragraph 4

**Test result:**

The antenna of the EUT used for transmission is the same interior antenna that used for monitoring.

**10) Monitoring threshold relaxation**

Devices that have a power output lower than the maximum permitted under the rules can increase their monitoring detection threshold by one decibel for each one decibel that the transmitter power is below the maximum permitted.

**Test procedure:**

Measurement method according to ANSI C63.17 -2013 clause 7.4 & paragraph 4

**Test result:**

This requirement is covered by the results of Least Interfered Channel (LIC).

**11) Duplex Connections**

An initiating device may attempt to establish a duplex connection by monitors both its intended transmit and receive time and spectrum windows. If both the intended transmit and receive time and spectrum windows meet the access criteria, then the initiating device can initiate a transmission in the intended transmit time and spectrum window. If the power detected by the responding device can be decoded as a duplex connection signal from the initiating device, then the responding device may immediately begin transmitting on the receive time and spectrum window monitored by the initiating device.



**Test procedure:**

This test validates proper operation of an EUT that operates according to the provisions of FCC §15.323(c)(10) using a check of both transmit and receive channels on one end of the link to qualify both ends of the link for transmissions. Test method according to ANSI C63.17 clause 8.3.2 Validation of dual access criteria check for EUTs that implement the upper threshold

- a) Adjust the path loss between the EUT and its companion device such that the received signal to the EUT from the companion device is at least 40 dB above  $TL + UM$ .
- b) Restrict the EUT and its companion device to operation at a single carrier  $f_1$  for TDMA systems and on  $f_1$  and  $f_2$  and corresponding duplex carriers for FDMA systems. Verify that the EUT and its companion device can establish a connection on a time/spectrum window on the enabled carrier(s). Terminate the connection.
- c) Apply interference to the EUT on the EUT's *transmit* time/spectrum windows at  $TL + UM$  per carrier on all time/spectrum windows except for one, which has interference at least 10 dB below  $TL$ . Adjust the interference to the EUT on its *receive* time/spectrum windows such that a single time/spectrum window has interference at least 10 dB below  $TL$ , and the interference on the other time/spectrum windows is at  $TL + UM + 7$  dB. The interference to the companion device should be at least 10 dB below  $TL$  on all active time/spectrum windows. The interference-free *receive* time/spectrum window must not be the duplex mate of the interference-free *transmit* time/spectrum window.
- d) Cause the EUT to attempt to establish a connection. The connection should be made on the interference-free *receive* time/spectrum window and its duplex mate. Otherwise, the EUT fails the test.
- e) If a connection exists, terminate it. Reduce the interference on the EUT's *receive* time/spectrum windows to a level of  $TL + UM$  per carrier on all time/spectrum windows except for one, which has interference at least 10 dB below  $TL$ . Raise the interference on the EUT's *transmit* time/spectrum windows to a level of  $TL + UM + 7$  dB, maintaining one time/spectrum window with interference at least 10 dB below  $TL$ . The interference to the companion device should be at least 10 dB below  $TL$  on all active time/spectrum windows. Again, the interference-free *transmit* and *receive* time/spectrum windows should not constitute a duplex pair if the system designates a specific duplex pairing for time/spectrum windows.
- f) Cause the EUT to attempt to establish a connection. The connection should be made on the interference-free *transmit* time/spectrum window and its duplex mate. Otherwise, the system fails the test.
- g) Terminate the connection and raise the interference to the EUT on all of the EUT's *transmit* and *receive* time/spectrum windows to  $TU + UM$  per carrier on all time/spectrum windows except for a single *transmit* time/spectrum window and a single *receive* time/spectrum window, which shall have interference at least 10 dB below  $TL$ . The low-interference *transmits* and *receives* time/spectrum windows shall not constitute a duplex pair. Adjust the path loss between the EUT and its companion device such that the received signal to the EUT from the companion device is at least 30 dB above  $TU$ . Cause the EUT to attempt to establish a connection. If a connection is established, the test fails.

**Test result:**

Interference (Refer to ANSI C63.17 § 8.3& § 8.3.2)	Reaction of EUT	Results
a) Only a single carrier $f_1$ for EUT TDMA systems and on $f_1$ and $f_2$ and corresponding duplex carriers for FDMA systems.	EUT can transmit	Pass
b) All Tx windows with level $TL+UM$ except one & Rx windows with level $TL+UM+7dB$ except one, which are not the duplex mate.	Connected on the target Rx window and its duplex mate.	Pass
c) All Tx windows with level $TL+UM+7dB$ except one & Rx windows with level $TL+UM$ except one, which are not duplex mate.	Connected on the target Tx window and its duplex mate.	Pass
d) All Tx & Rx windows with level $TU+UM$ , except one for Tx window & one for Rx window, which are not duplex mate.	No connection possible	Pass

**12) Alternative monitoring interval**

An initiating device that is prevented from monitoring during its intended transmit window due to monitoring system blocking from the transmissions of a co-located (within one meter) transmitter of the same system, may monitor the portions of the time and spectrum windows in which they intend to receive over a period of at least 10 milliseconds. The monitored time and spectrum window must total at least 50 percent of the 10 millisecond frame interval and the monitored spectrum must be within 1.25 MHz of the center frequency of channel(s) already occupied by that device or co-located co-operating devices. If the access criteria is met for the intended receive time and spectrum window under the above conditions, then transmission in the intended transmit window by the initiating device may commence.

**Test procedure:**

This test validates the ability of the EUT to distinguish between same-system and other-system interference for purposes of satisfying the requirement of 47CFR15.323(c) (11). Test method according to ANSI C63.17 2013 clause 8.4

- a) Adjust the path loss between the EUT and its companion device such that the received signal to the EUT from the companion device is at least 30 dB above  $TL$ .
- b) Restrict the EUT and its companion device to operation at a single carrier  $f_1$  for TDMA systems and on  $f_1$  and  $f_2$  and corresponding duplex carriers for FDMA systems. Verify that the EUT and its companion device can establish a connection.
- c) Apply interference at  $TL + UM$  per carrier to the EUT on all *transmit* time/spectrum windows on the enabled carrier(s). The interference must use the same physical layer parameters (modulation, frame format, etc.) as the EUT transmissions, but with a system identifier different from that used by the EUT and the companion device. Ensure that the interference level at the companion device is at least 10 dB below  $TL$ . Apply no interference to the *receive* time/spectrum windows on the enabled carriers.
- d) Cause the EUT to attempt to establish a connection. If a connection is established, the test fails.

**Test result:**

Interference (Refer to ANSI C63.17 § 8.4)	Reaction of EUT	Results
a) Only a single carrier $f_1$ for EUT TDMA systems and on $f_1$ and $f_2$ and corresponding duplex carriers for FDMA systems.	EUT can transmit	Pass
b) Apply interference with same parameters as EUT transmissions on all Tx windows with level TL+UM on the enabled carrier(s) and no interference on the Rx windows on the enabled carriers.	No connection is established	Pass

**IC:**

Not appropriate, as the system always monitor both the transmit and receive time/spectrum windows, it is not a co-located device.

**13) Fair Access**

The provisions of FCC §15.323 (c) & paragraphs 5.2 (10) or (11) shall not be used to extend the range of spectrum occupied over space or time for the purpose of denying fair access to spectrum to other devices.

**Test result:**

The manufacturer declares that this device does not use any mechanisms as provided by FCC §15.323(c)(10) or (11) & IC RSS-213 5.2(10) and (11) to extend the range of spectrum occupied over space or time for the purpose of denying fair access to spectrum to other device.

**14) Frame Repetition Stability Frame Period and Jitter**

The frame period (a set of consecutive time slots in which the position of each time slot can be identified by reference to a synchronizing source) of an intentional radiator operating in these sub-bands shall be 20 milliseconds or 10 milliseconds/X where X is a positive whole number. Each device that implements time division for the purposes of maintaining a duplex connection on a given frequency carrier shall maintain a frame repetition rate with a frequency stability of at least 50 parts per million (ppm). Each device which further divides access in time in order to support multiple communication links on a given frequency carrier shall maintain a frame repetition rate with a frequency stability of at least 10 ppm. The jitter (time-related, abrupt, spurious variations in the duration of the frame interval) introduced at the two ends of such a communication link shall not exceed 25 microseconds for any two consecutive transmissions. Transmissions shall be continuous in every time and spectrum window during the frame period defined for the device.

**Test procedure:**

Measurement method according to ANSI C63.17 2013 clause 6.2.2, 6.2.3

**Test result:**

Frame Period and Jitter:

Max. pos. Jitter ( $\mu$ s)	Max. neg. Jitter ( $\mu$ s)	Frame period (ms)	Limit	
			Frame Period (ms)	Jitter ( $\mu$ s)
0.02	-0.04	10.20	20 or10/X	25

Note: X is a positive whole number.

**\*\*\*\*\* END OF REPORT \*\*\*\*\***