

# SIP NEXT GEN SERIES

NG-S3411

SIP Next Gen Cordless 1-line Hotel Telephone

NG-S3411W

SIP Next Gen Cordless 1-line Wi-Fi Enabled Hotel Telephone

NG-C3411HC

Virtual Bundle of NGC-C5101 and C5012  
Next Gen Cordless 1-line Accessory Handset and Charging Base

NGC-C5101

Next Gen Cordless 1-line Accessory Handset

C5012

Charging Base

**vtech**<sup>®</sup>

User's Guide

# IMPORTANT SAFETY INSTRUCTIONS

The applied nameplate is located at the bottom or rear of the product.

When using your telephone equipment, basic safety precautions should always be followed to reduce the risk of fire, electric shock and injury, including the following:

1. This product should be installed by a qualified technician.
2. This product should only be connected to the host equipment and never directly to the network such as Public Switch Telephone Network (PSTN) or Plain Old Telephone Services (POTS).
3. Read and understand all instructions.
4. Follow all warnings and instructions marked on the product.
5. Unplug this product from the wall outlet before cleaning. Do not use liquid or aerosol cleaners. Use a damp cloth for cleaning.
6. Do not use this product near water such as near a bath tub, wash bowl, kitchen sink, laundry tub or swimming pool, or in a wet basement or shower.
7. Do not place this product on an unstable table, shelf, stand or other unstable surfaces.
8. Slots and openings in the back or bottom of the telephone base and handset are provided for ventilation. To protect them from overheating, these openings must not be blocked by placing the product on a soft surface such as a bed, sofa or rug. This product should never be placed near or over a radiator or heat register. This product should not be placed in any area where proper ventilation is not provided.
9. This product should be operated only from the type of power source indicated on the marking label. If you are not sure of the type of power supply on the premises, consult your dealer or local power company.
10. Do not allow anything to rest on the power cord. Do not install this product where the cord may be walked on.
11. Never push objects of any kind into this product through the slots in the telephone base or handset because they may touch dangerous voltage points or create a short circuit. Never spill liquid of any kind on the product.
12. To reduce the risk of electric shock, do not disassemble this product, but take it to an authorized service facility. Opening or removing parts of the telephone base or handset other than specified access doors may expose you to dangerous voltages or other risks. Incorrect reassembling can cause electric shock when the product is subsequently used.
13. Do not overload wall outlets and extension cords.
14. Unplug this product from the wall outlet and refer servicing to an authorized service facility under the following conditions:
  - When the power supply cord or plug is damaged or frayed.
  - If liquid has been spilled onto the product.
  - If the product has been exposed to rain or water.
  - If the product does not operate normally by following the operating instructions. Adjust only those controls that are covered by the operation instructions. Improper adjustment of other controls may result in damage and often requires extensive work by an authorized technician to restore the product to normal operation.
  - If the product has been dropped and the telephone base and/or handset has been damaged.
  - If the product exhibits a distinct change in performance.

15. Avoid using a telephone (other than cordless) during an electrical storm. There is a remote risk of electric shock from lightning.
16. Do not use the telephone to report a gas leak in the vicinity of the leak. Under certain circumstances, a spark may be created when the adapter is plugged into the power outlet, or when the handset is replaced in its cradle. This is a common event associated with the closing of any electrical circuit. The user should not plug the telephone into a power outlet, and should not put a charged handset into the cradle, if the telephone is located in an environment containing concentrations of flammable or flame-supporting gases, unless there is adequate ventilation. A spark in such an environment could create a fire or explosion. Such environments might include: medical use of oxygen without adequate ventilation; industrial gases (cleaning solvents; gasoline vapors; etc.); a leak of natural gas; etc.
17. Only put the handset of your telephone next to your ear when it is in normal talk mode.
18. The power adapters are intended to be correctly oriented in a vertical or floor mount position. The prongs are not designed to hold the plug in place if it is plugged into a ceiling, under-the-table or cabinet outlet.
19. Use only the power cord and batteries indicated in this manual. Do not dispose of batteries in a fire. They may explode. Check with local codes for possible special disposal instructions.
20. In wall mounting position, make sure to mount the telephone base on the wall by aligning the eyelets with the mounting studs of the wall plate. Then slide the telephone base down on both mounting studs until it locks into place. Refer to the full instructions in Installation in the user's manual.
21. This product should be mounted at a height of less than 2 meters.
22. Listed PoE (The product is considered not likely to require connection to an Ethernet network with outside plant routing).

   CAUTIONS

- Keep small metallic objects such as pins and staples away from the handset receiver.
- There may be a risk of explosion if a wrong type of handset battery is used. Use only the supplied rechargeable battery or replacement battery (Model No. 523450AR1000). Dispose of used batteries according to the instructions.

## SAVE THESE INSTRUCTIONS

# INSTRUCTIONS DE SÉCURITÉ IMPORTANTES

La plaque signalétique appliquée est située au bas et à l'arrière de la base du produit.

Lorsque vous utilisez votre équipement téléphonique, des précautions de base doivent toujours être prises pour réduire les risques d'incendie, d'électrocution et de blessure, notamment les suivantes :

1. Ce produit doit être installé par un technicien qualifié.
2. Ce produit ne doit être connecté qu'à l'équipement hôte et jamais directement au réseau tel que le réseau téléphonique public commuté (RTPC) ou les services téléphoniques classiques (POTS).
3. Lire et comprendre toutes les instructions.
4. Respecter tous les avertissements et instructions figurant sur le produit.
5. Débranchez ce produit de la prise murale avant de le nettoyer. N'utilisez pas de nettoyants liquides ou en aérosol. Utilisez un chiffon humide pour le nettoyage.
6. N'utilisez pas ce produit près de l'eau, par exemple près d'une baignoire, d'une cuvette de lavage, d'un évier de cuisine, d'une cuve de lavage ou d'une piscine, ou dans un sous-sol ou une douche humide.
7. Ne pas placer ce produit sur une table, une étagère, un support ou toute autre surface instable.
8. Des fentes et des ouvertures à l'arrière ou en-dessous du socle du téléphone et du combiné sont prévues pour la ventilation. Afin de les protéger contre la surchauffe, ces ouvertures ne doivent pas être obstruées en plaçant le produit sur une surface souple comme un lit, un divan ou un tapis. Ce produit ne doit jamais être placé à proximité ou au-dessus d'un radiateur ou d'un registre de chaleur. Ce produit ne doit pas être placé dans un endroit où une ventilation adéquate n'est pas assurée.
9. Ce produit ne doit être utilisé qu'avec le type de source d'énergie indiqué sur l'étiquette de marquage. Si vous n'êtes pas sûr du type d'alimentation électrique sur place, consultez votre revendeur ou votre compagnie d'électricité locale.
10. Ne laissez rien reposer sur le cordon d'alimentation. N'installez pas ce produit à un endroit où l'on pourrait marcher sur le cordon.
11. N'introduisez jamais d'objets de quelque nature que ce soit dans ce produit par les fentes du socle du téléphone ou du combiné, car ils pourraient toucher des points de tension dangereux ou créer un court-circuit. Ne jamais renverser de liquide de quelque nature que ce soit sur le produit.
12. Pour réduire le risque d'électrocution, ne démontez pas ce produit, mais confiez-le à un service après-vente agréé. Ouvrir ou retirer des parties du socle du téléphone ou du combiné autres que les portes d'accès spécifiées peut vous exposer à des tensions dangereuses ou à d'autres risques. Un remontage incorrect peut provoquer une électrocution lors de l'utilisation ultérieure du produit.
13. Ne surchargez pas les prises murales et les rallonges électriques.
14. Débranchez ce produit de la prise murale et confiez l'entretien à un centre de service agréé dans les conditions suivantes :
  - Lorsque le cordon d'alimentation ou la fiche est endommagé ou effiloché.
  - Si du liquide a été renversé sur le produit.
  - Si le produit a été exposé à la pluie ou à l'eau.
  - Si le produit ne fonctionne pas normalement en suivant les instructions d'utilisation. Ne réglez que les commandes qui sont couvertes par le

mode d'emploi. Un mauvais réglage des autres commandes peut entraîner des dommages et nécessite souvent un travail important de la part d'un technicien autorisé pour remettre le produit en état de fonctionnement.

- Si le produit est tombé et que le socle du téléphone et/ou le combiné ont été endommagés.
  - Si le produit présente un changement distinct de performance.
15. Évitez d'utiliser un téléphone (autre que sans fil) pendant un orage électrique. Il existe un risque d'électrocution dû à la foudre.
  16. N'utilisez pas le téléphone pour signaler une fuite de gaz à proximité de la fuite. Dans certaines circonstances, une étincelle peut se produire lorsque l'adaptateur est branché dans la prise de courant, ou lorsque le combiné est replacé dans son berceau. Il s'agit d'un événement courant associé à la fermeture de tout circuit électrique. L'utilisateur ne doit pas brancher le téléphone dans une prise de courant, ni placer un combiné chargé dans son socle, si le téléphone est situé dans un environnement contenant des concentrations de gaz inflammables ou propices aux flammes, à moins qu'il n'y ait une ventilation adéquate. Une étincelle dans un tel environnement pourrait créer un incendie ou une explosion. Ces environnements peuvent comprendre : l'utilisation médicale de l'oxygène sans ventilation adéquate; les gaz industriels (solvants de nettoyage; vapeurs d'essence; etc.); une fuite de gaz naturel; etc.
  17. Ne placez le combiné de votre téléphone près de votre oreille que lorsqu'il est en mode de conversation normal.
  18. Les adaptateurs d'alimentation sont destinés à être correctement orientés en position verticale ou au sol. Les broches ne sont pas conçues pour maintenir la fiche en place si elle est branchée au plafond, sous la table ou dans une prise de courant d'armoire.

19. Utilisez uniquement le cordon d'alimentation et les piles indiqués dans ce manuel. Ne jetez pas les piles au feu. Elles risquent d'exploser. Vérifiez auprès des autorités locales les éventuelles instructions spéciales d'élimination.
20. En position de montage mural, veillez à monter le socle du téléphone sur le mur en alignant les oeillets avec les montants de fixation de la plaque murale. Ensuite, faites glisser le socle téléphonique vers le bas sur les deux montants de montage jusqu'à ce qu'il se verrouille en place. Reportez-vous aux instructions complètes dans la section Installation du guide d'utilisation.
21. Ce produit doit être installé à une hauteur inférieure à 2 mètres.
22. Listé POE (Le produit est considéré comme peu susceptible de nécessiter une connexion à un réseau Ethernet avec un routage extérieur à l'installation).

### MISE EN GARDE

- Gardez les petits objets métalliques tels que les épingles et les agrafes loin du combiné.
- Il peut y avoir un risque d'explosion si un mauvais type de pile de combiné est utilisé. Utilisez uniquement la pile rechargeable fournie ou une pile de remplacement (N° de modèle 523450AR1000). Éliminez les piles usagées conformément aux instructions.

## CONSERVEZ CES INSTRUCTIONS

# TABLE OF CONTENTS

**Important safety instructions.....2**

**Instructions de sécurité importantes... 4**

**Parts check list .....7**

**Telephone layout ..... 9**

SIP Next Gen Cordless 1-line Hotel  
Telephone - NG-S3411 ..... 9

SIP Next Gen Cordless 1-line Wi-Fi Enabled  
Hotel Telephone - NG-S3411W ..... 9

Next Gen Cordless 1-line Accessory  
Handset and Charging Base -  
NG-C3411HC..... 11

**Installation.....12**

SIP Next Gen Cordless 1-line Hotel  
Telephone - NG-S3411 ..... 12

SIP Next Gen Cordless 1-line Wi-Fi Enabled  
Hotel Telephone - NG-S3411W ..... 12

Next Gen Cordless 1-line Accessory  
Handset and Charging base -  
NG-C3411HC.....17

**Set up .....18**

SIP Next Gen Cordless 1-line Hotel  
Telephone - NG-S3411 ..... 18

SIP Next Gen Cordless 1-line Wi-Fi Enabled  
Hotel Telephone - NG-S3411W ..... 18

Voice Menu ..... 19

**Operation..... 20**

SIP Next Gen Cordless 1-line Hotel  
Telephone - NG-S3411 ..... 20

SIP Next Gen Cordless 1-line Wi-Fi Enabled  
Hotel Telephone - NG-S3411W ..... 20

Next Gen Cordless 1-line Accessory  
Handset and Charging base -

NG-C3411HC.....20

**Appendix .....22**

Troubleshooting ..... 22

VTech Hospitality Limited Warranty  
Program ..... 28

Precautions for users of implanted cardiac  
pacemakers .....30

Operating range.....30

About cordless telephones .....30

FCC, ACTA and IC regulations ..... 31

Energy-saving charging mode ..... 34

Maintenance..... 35

Disclaimer and Limitation of Liability..... 35

**Technical specifications .....36**





SIP Next Gen Cordless 1-line Hotel  
Telephone - NG-S3411 ..... 36

SIP Next Gen Cordless 1-line Wi-Fi  
Enabled Hotel Telephone - NG-S3411W..  
36

Next Gen Cordless 1-line Accessory  
Handset and Charging Base -  
NG-C3411HC..... 36

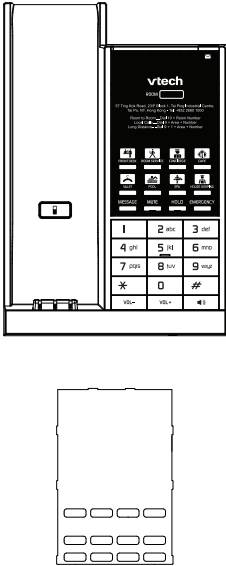
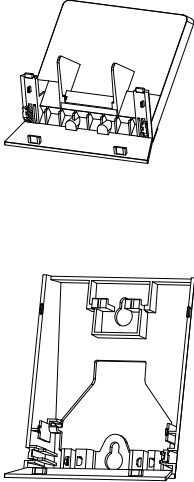
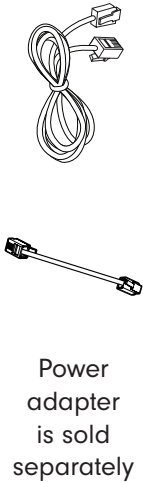

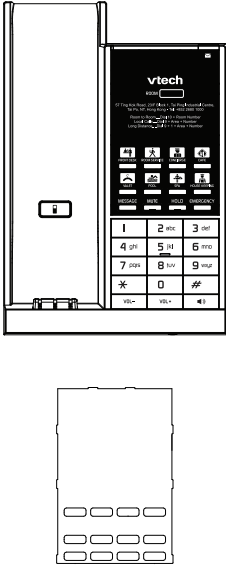
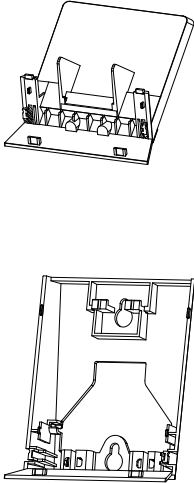
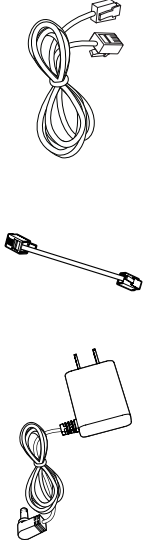
# Parts check list

Items contained in the respective **cordless telephone** package:

MODEL NAME	MODEL NUMBER	PARTS INCLUDED				
		TELEPHONE BASE WITH OVERLAY	BASE STAND   WALL MOUNT BRACKET	ETHERNET CABLE   SHORT ETHERNET CABLE   TELEPHONE BASE POWER ADAPTER	CORDLESS HANDSET AND HANDSET BATTERY	HANDSET CHARGING BASE   POWER ADAPTER
SIP Next Gen Cordless 1-line Hotel Telephone	NG-S3411			 <p>Power adapter is sold separately</p>		
SIP Next Gen Cordless 1-line Wi-Fi Enabled Hotel Telephone	NG-S3411W					

# Parts check list (continued)

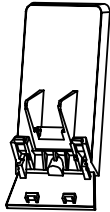
Items contained in the respective **cordless telephone** package:

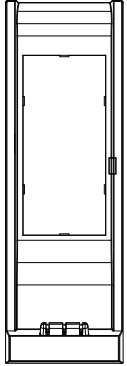
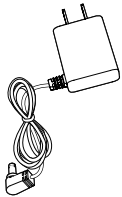
MODEL NAME	MODEL NUMBER	PARTS INCLUDED				
		TELEPHONE BASE WITH OVERLAY	BASE STAND   WALL MOUNT BRACKET	ETHERNET CABLE   SHORT ETHERNET CABLE   TELEPHONE BASE POWER ADAPTER	CORDLESS HANDSET AND HANDSET BATTERY	HANDSET CHARGING BASE   POWER ADAPTER
Next Gen Cordless 1-line Accessory Handset and Charging Base	NG-C3411HC (virtual bundle of NGC-C5101 and C5012)				 	 



# Telephone layout

SIP Next Gen Cordless 1-line Hotel Telephone - NG-S3411

SIP Next Gen Cordless 1-line Wi-Fi Enabled Hotel Telephone - NG-S3411W

## TELEPHONE BASE

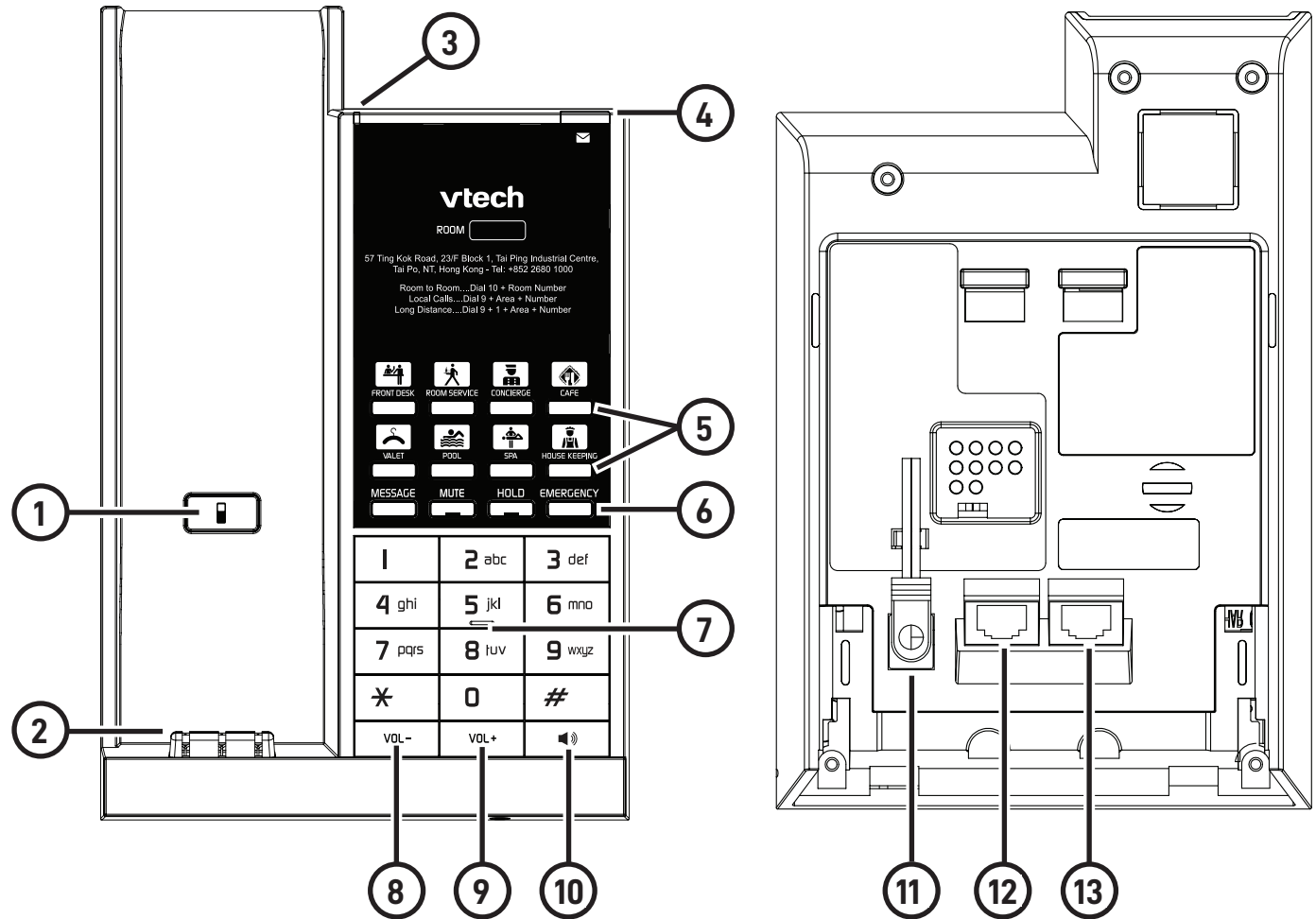

1	Find Handset button
2	Charging poles
3	Charge LED
4	Message waiting LED
5	Speed dial keys <b>MESSAGE</b> key <b>MUTE</b> key <b>HOLD</b> key
6	<b>EMERGENCY</b> key
7	Numeric dial keys
8	<b>VOLUME -</b> key
9	<b>VOLUME +</b> key
10	<b>SPEAKER</b> key

11	Power adapter input
12	<b>NET</b> Ethernet port
13	<b>PC</b> Ethernet port

# Telephone layout

## SIP Next Gen Cordless 1-line Hotel Telephone - NG-S3411

## SIP Next Gen Cordless 1-line Wi-Fi Enabled Hotel Telephone - NG-S3411W

### HANDSET

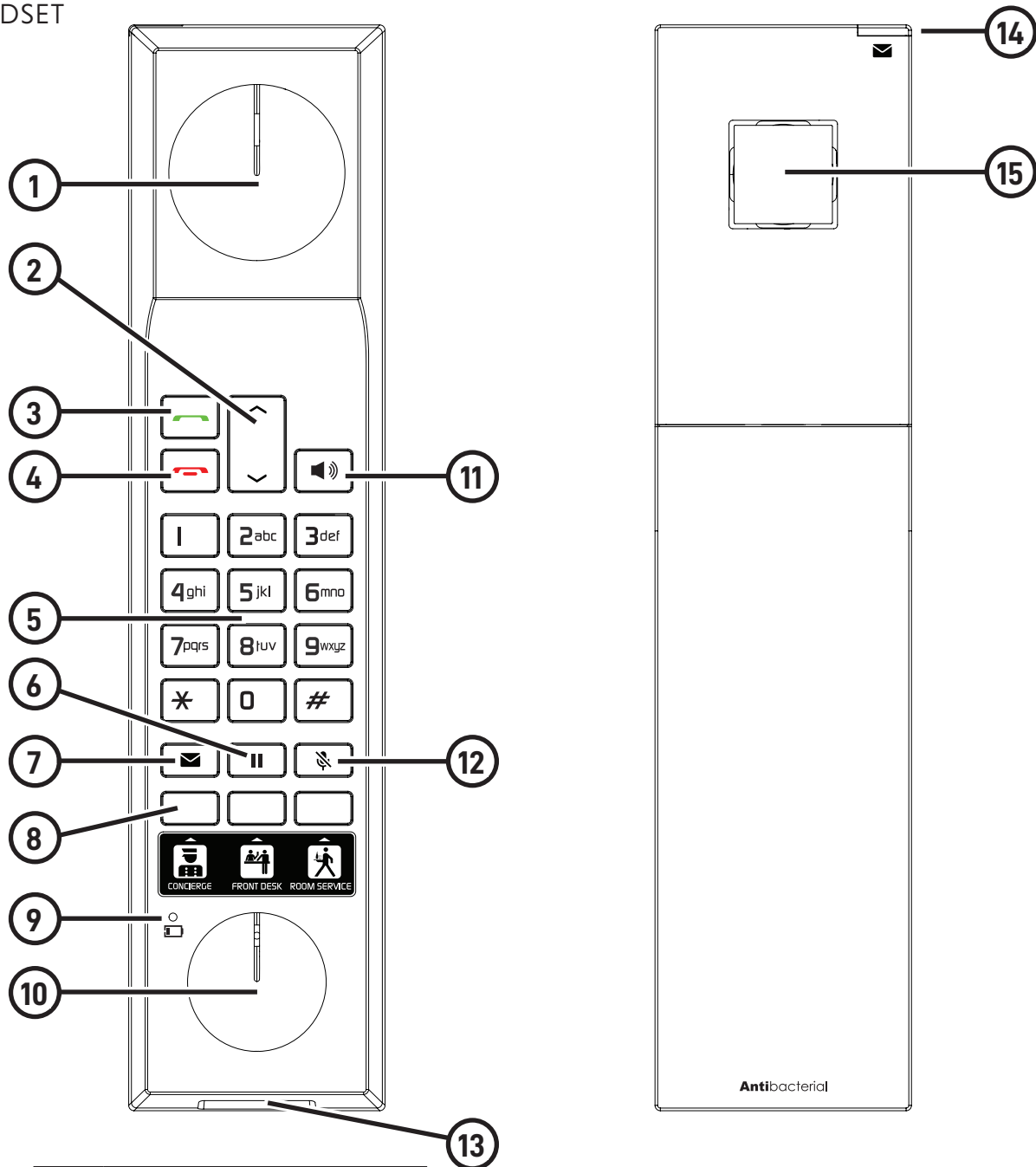

1	Handset earpiece
2	<b>^ v</b> <b>VOLUME</b> keys
3	<b>☎</b> <b>TALK/FLASH</b> key
4	<b>☎</b> <b>OFF/Cancel</b> key
5	Numeric dial keys
6	<b>  </b> <b>HOLD</b> key
7	<b>✉</b> <b>MESSAGES</b> key
8	Speed dial keys

9	Low battery LED
10	Microphone
11	<b>🔊</b> <b>SPEAKER</b> key
12	<b>🔇</b> <b>MUTE</b> key
13	Charging contacts
14	Message waiting LED
15	Speakerphone

**Next Gen Cordless 1-line Accessory  
Handset Charging Base - NG-C3411HC**

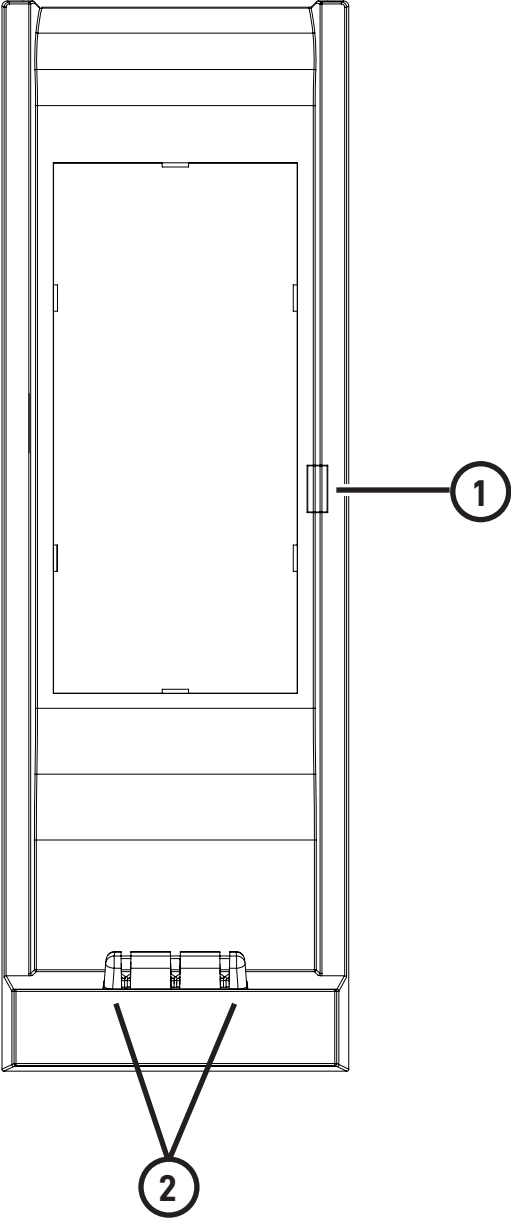

1	Charge LED
2	Charging poles

# Installation

## SIP Next Gen Cordless 1-line Hotel Telephone - NG-S3411

## SIP Next Gen Cordless 1-line Wi-Fi Enabled Hotel Telephone - NG-S3411W

### TELEPHONE BASE INSTALLATION

The telephone comes ready for desktop use.

1. Install the telephone base as shown below.
  - NOTE: Power adapter is not required for Power over Ethernet (PoE).

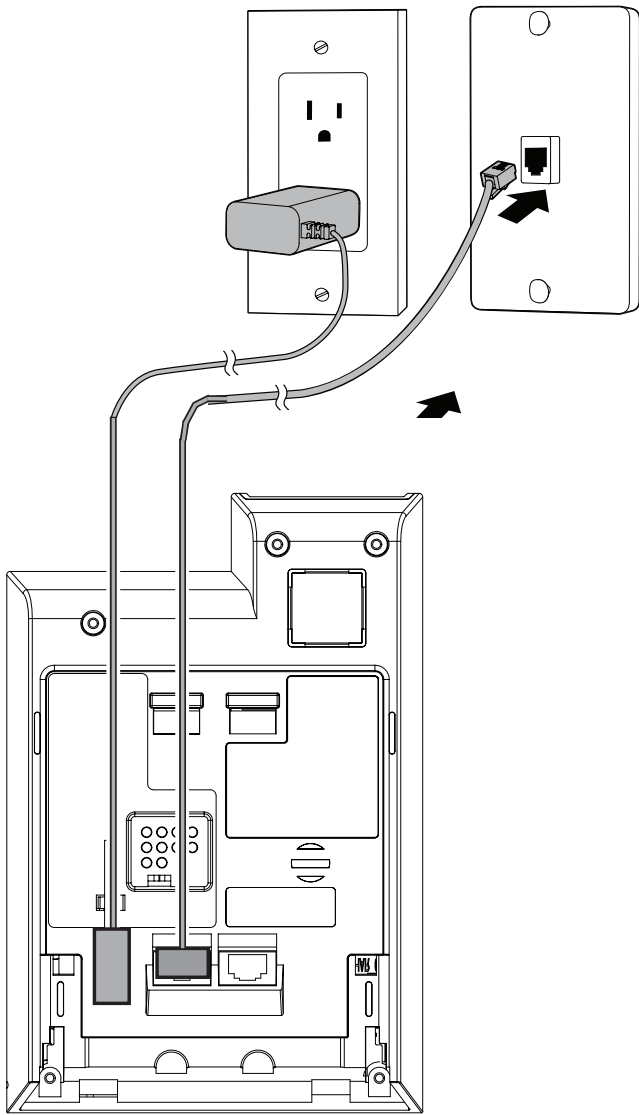

2. When the telephone base has been initially installed, make sure the power adapter is securely plugged into an outlet not controlled by a wall switch, and the Ethernet cable is plugged into the network wall jack.

- The battery is fully charged after 11 hours of continuous charging. For best performance, keep the cordless handset in the telephone base when not in use.

3. Press on the telephone base. Listen for a dial tone, and then press again to hang up.

### NOTE

- The dial tone will not be played if the SIP account used by this telephone cannot be registered.
- The power adapter is sold separately.
- Use only the power adapter described in "Technical specifications" on page 36.

### CAUTION

Use only the supplied Ethernet cables. The supplied Ethernet cables are not designed for use in any other IT devices. Misusing them on your other IT devices shall be prohibited. To order a replacement, call 1-888-907-2007.

### INSTALLATION OPTION - INSTALL BASE STAND FOR DESKTOP

#### TO MOUNT THE TELEPHONE BASE ON THE BASE STAND

1. Align the grooves of the base stand with the telephone base.
2. Slide the base stand up to secure it.

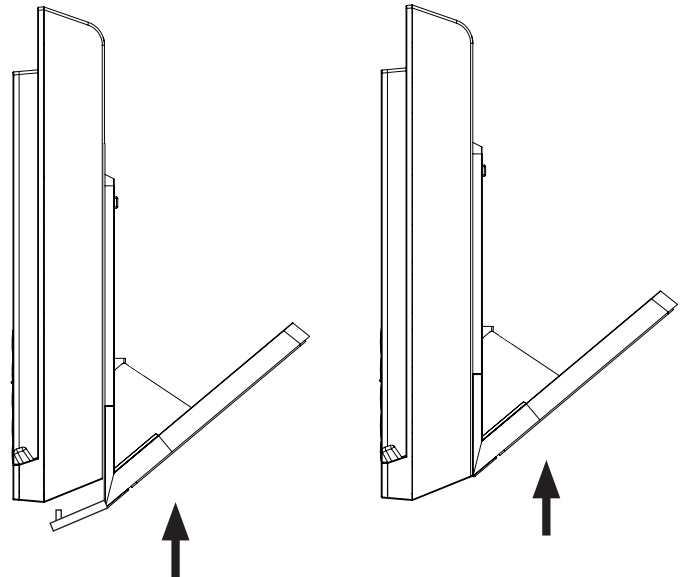

### TO UNMOUNT THE BASE STAND

Simply slide the base stand down, and lift it from the telephone base.

### INSTALLATION OPTION - CONVERTING FROM DESKTOP TO WALL MOUNT POSITION

#### TO MOUNT THE TELEPHONE BASE ON THE WALL

1. Unmount the base stand from the telephone base. Disconnect all cords and cables from the telephone base. Put the cordless handset aside.
2. Turn the telephone base over with the bottom side facing up.
3. Align the grooves with the wall mount bracket.
4. Slide the wall mount bracket up.

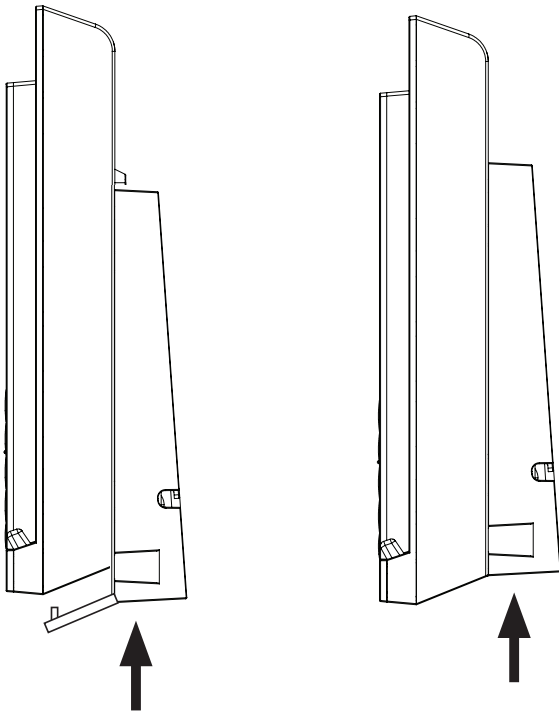

5. Connect the telephone as described in "Telephone base installation" on page 12, but use the short Ethernet cable. The short Ethernet cable and power adapter cable stick out from the hole in the wall mount bracket.

6. Mount the telephone base on the wall by positioning the eyelets on the telephone base and the mounting bracket against the mounting studs. Then slide the telephone base down on both mounting studs until it locks into place.

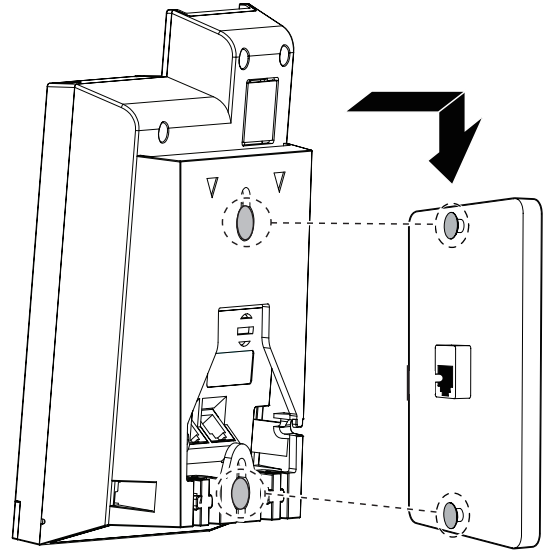

7. Replace the cordless handset on the telephone base cradle.

#### TO REMOVE THE WALL MOUNT BRACKET FROM THE TELEPHONE BASE

1. Slide the telephone base up to remove it from the mounting studs on the wall.
2. Disconnect all cords and cables from the telephone base.
3. Slide the wall mount bracket down and lift it from the telephone base.

# WALL MOUNT BRACKET DIMENSIONS

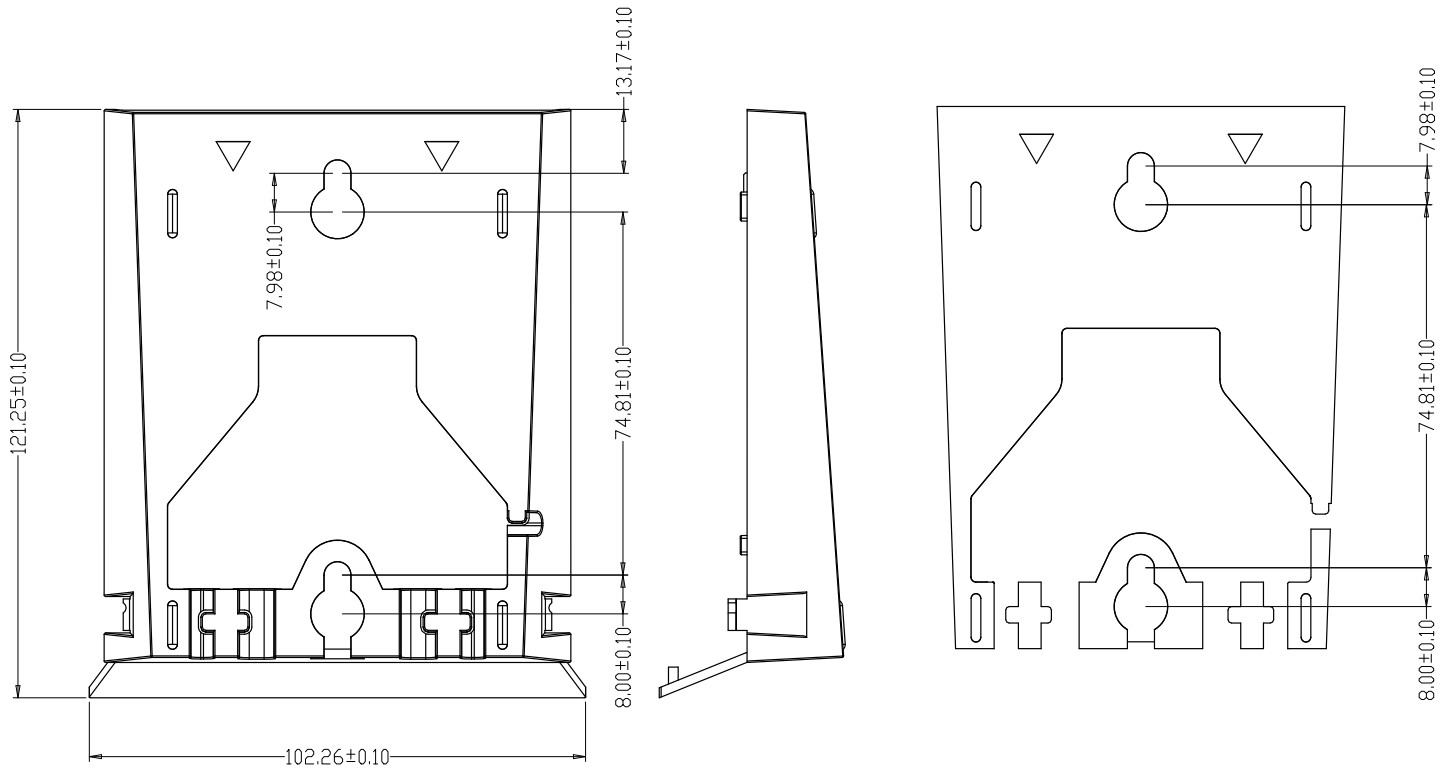

Unit: mm

## INSTALLING OR REPLACING A CORDLESS HANDSET BATTERY

To install or replace the handset battery, follow the steps below.

1. Hold the handset.
2. Press both thumbs down on the edge of the battery cover near the speaker, and slide the battery cover downwards.

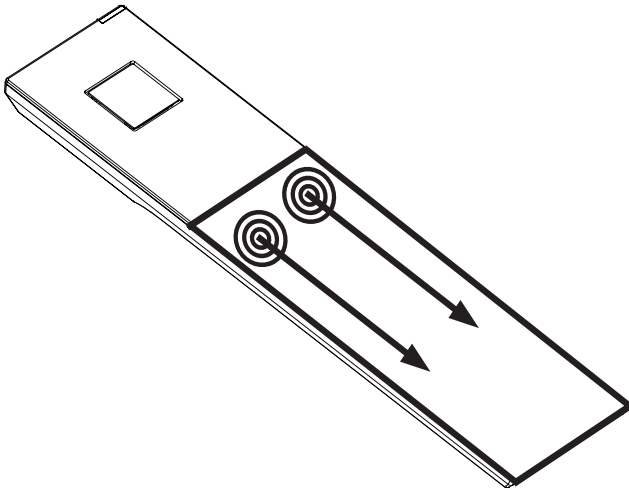

3. Lift the battery cover off the handset.

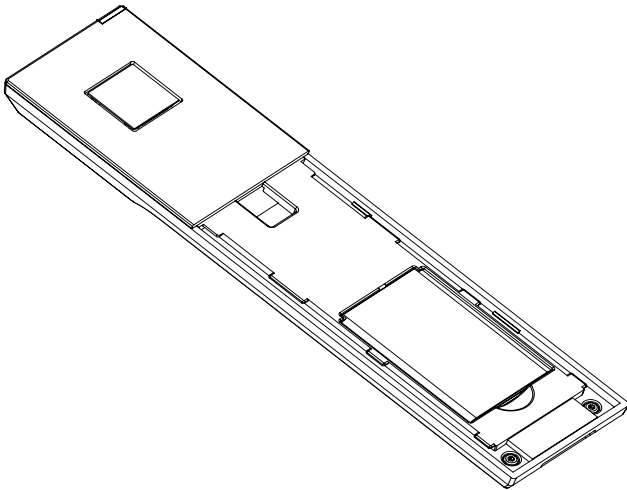

4. If you are replacing the battery: Place your thumb in the slot below the battery, and lift the battery out of the handset battery compartment.
5. Place the top of the battery in the handset battery compartment so that the battery connectors are aligned.
6. Push the bottom of the battery down into the battery compartment.

7. Align all the tabs on the handset cover against the corresponding grooves on the handset, then slide the handset cover closed.

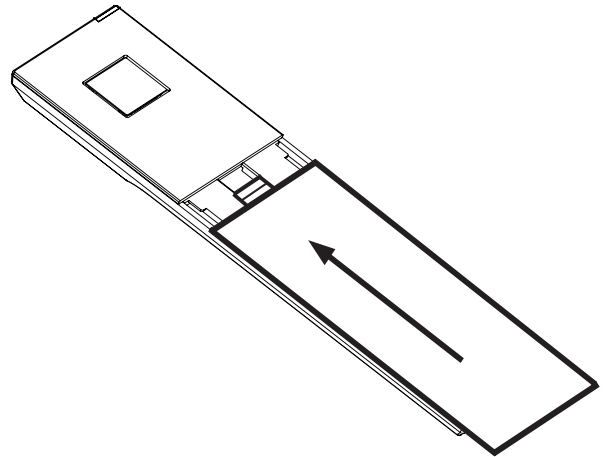

### ⚠ CAUTIONS

- There may be a risk of explosion if a wrong type of handset battery is used. Use only the supplied rechargeable battery or replacement battery (Model No. 523450AR1000). To order a replacement, call 1-888-907-2007.
- Dispose of used batteries according to the information in The RBRC® seal.

### INSTALLATION NOTES

⚠ CAUTION! Please be careful of sharp edges of base stand that can cause harm during the installation process.

Avoid placing the phone too close to:

- Communication devices such as television sets, DVD players, or other cordless telephones
- Excessive heat sources
- Noise sources such as a window with traffic outside, motors, microwave ovens, refrigerators, or fluorescent lighting
- Excessive dust sources such as a workshop or garage
- Excessive moisture
- Extremely low temperature
- Mechanical vibration or shock such as on top of a washing machine or work bench

## HANDSET REGISTRATION

Place the cordless handset on the telephone base cradle. Handset registration happens automatically the first time a cordless handset is placed on the telephone base.

When the registration process completes, the **MESSAGE WAITING** LED flashes once and you hear 3 rising beeps as confirmation.

Each telephone base accommodates up to five cordless handsets. When you already have five registered handsets, you can replace one of them by a new handset if any one of the five registered handsets is disconnected from the base. For example, it is out of range, or its battery is removed or depleted. The previous registered handset is then deregistered from the telephone base.

## HANDSET DEREGISTRATION

When a registered cordless handset is idle, press **\*331734#**, then press **HOLD**. You will hear a confirmation tone when the deregistration process completes.

## REGISTER A HANDSET TO ANOTHER TELEPHONE BASE

Any Next Gen cordless 1-line handset can register to any Next Gen cordless 1-line telephone base.

When a registered cordless handset is idle, place it on another telephone base. This cordless handset automatically registers to the new telephone base.

## HANDSET BATTERY CHARGING

The battery must be fully charged before using the cordless handset for the first time. The **CHARGE** LED turns on when the cordless handset is charging on the telephone base. The battery is fully charged after 11 hours of continuous charging. For best performance, keep the cordless handset in the telephone base or charging base when not in use.



## Installation

### Next Gen Cordless 1-line Accessory Handset and Charging base - NG-C3411HC

#### INSTALL CHARGING BASE FOR DESKTOP

#### TO MOUNT THE BASE STAND ON THE CHARGING BASE

1. Align the grooves of the base stand with the charging base.
2. Slide the base stand up to secure it.

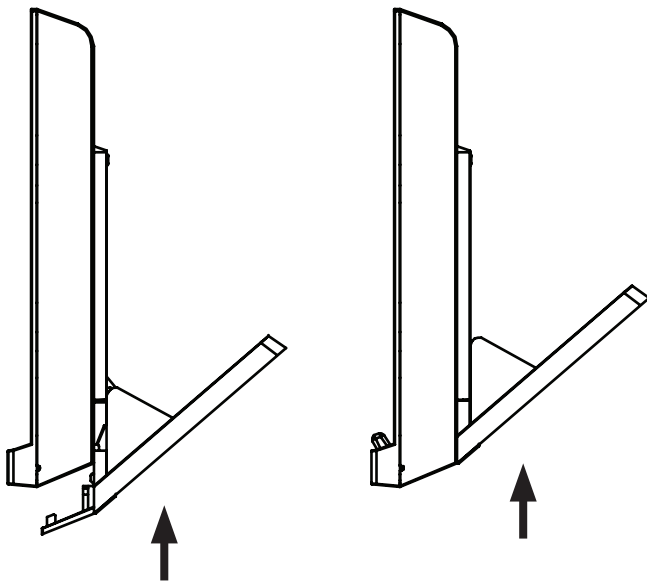

#### TO UNMOUNT THE BASE STAND



Simply slide the base stand down and lift it from the charging base.

#### CHARGING BASE INSTALLATION

The telephone comes ready for desktop use.

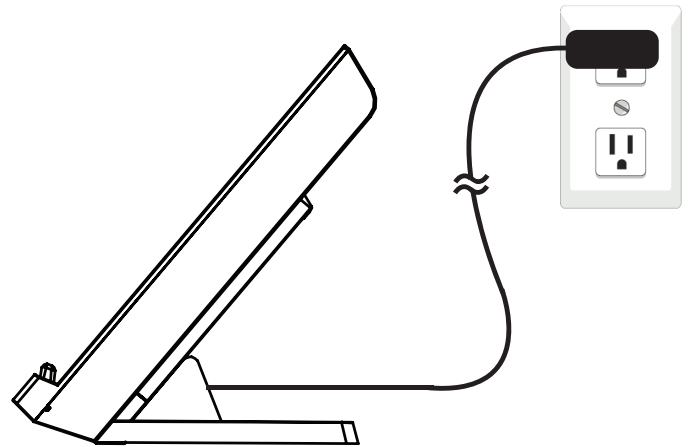
1. Install the charging base as shown below.
  - Make sure the power adapter is securely plugged into an outlet not controlled by a wall switch.



- The battery is fully charged after 11 hours of continuous charging. For best performance, keep the cordless handset in the charging base when not in use.
2. Press  on the handset. Listen for a dial tone, and then press  again to hang up.

#### ⚠ CAUTIONS

Use only the supplied power adapter. The supplied power adapter is not designed for use in any other IT devices. Misusing it on your other IT devices shall be prohibited. To order a replacement, call 1-888-907-2007.

## Set up

### SIP Next Gen Cordless 1-line Hotel Telephone - NG-S3411

### SIP Next Gen Cordless 1-line Wi-Fi Enabled Hotel Telephone - NG-S3411W

Default settings are indicated by asterisks (\*).

SETTING	OPTIONS	ADJUSTABLE BY
Listening volume- Handset	1, 2, 3, 4*, 5, 6	User and administrator
Speakerphone volume - Handset	1, 2, 3, 4*, 5, 6	User and administrator
Speakerphone volume - telephone base	1, 2, 3, 4, 5*, 6, 7, 8, 9	User and administrator
Ringer volume - telephone base	1, 2, 3, 4, 5*, 6, 7, 8, 9	User and administrator
Ringer tone	Tone 1*, Tone 2, Tone 3	Administrator only

**All telephone settings are programmed through the administrative web portal. Please refer to the SIP Phone Configuration Guide for details.**

## Voice Menu

The Voice menu enables you to use the handset to query and change telephone settings.

### To access the Voice Menu:

1. When the telephone is idle, press this key sequence on the handset: **TALK \* \* \* \***. A digitized voice on the handset will announce Voice Menu options.
2. Press the number key on the handset to select the desired menu option, or enter information. A list of menu options is shown in the diagram below.

For example, to find out the IP address of the telephone, press **1** for Network Configuration, then press **2** for IP Address.

3. When you are finished with the Voice menu, press **OFF** on the handset or place it in the cradle.

**NOTE:** if you changed any network settings, your telephone will automatically reboot. This will enable your new settings to take effect.

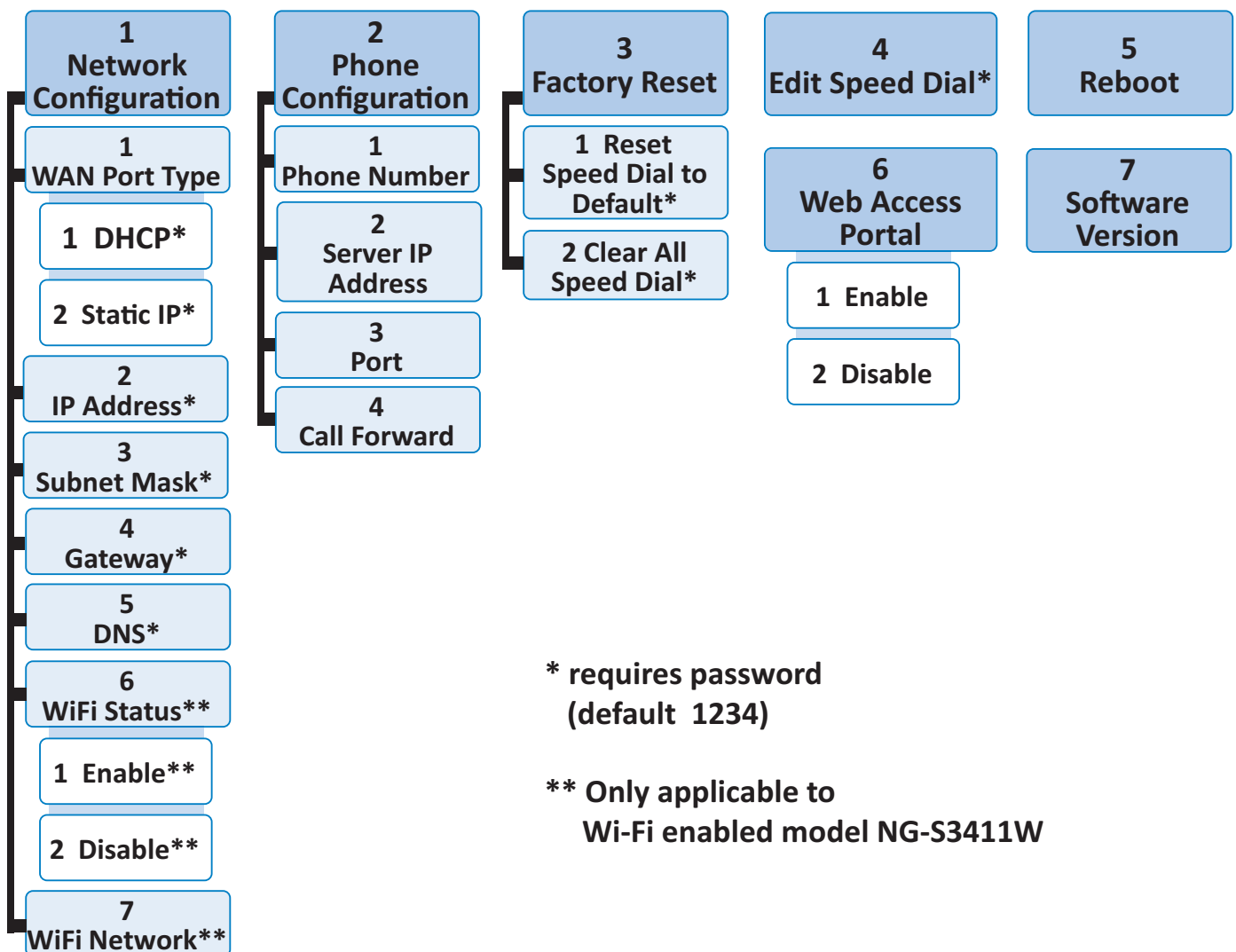

## Operation

### SIP Next Gen Cordless 1-line Hotel Telephone - NG-S3411

### SIP Next Gen Cordless 1-line Wi-Fi Enabled Hotel Telephone - NG-S3411W

### Next Gen Cordless 1-line Accessory Handset and Charging base - NG-C3411HC

#### USING THE CORDLESS HANDSET AND THE TELEPHONE BASE



The cordless handset and the telephone base speakerphone cannot be used at the same time on a call. However, calls can be switched between the cordless handset and the telephone base speakerphone.

#### RECEIVE A CALL

When there is an incoming call, the telephone rings and the message waiting LED flashes on the telephone base.



#### ANSWER A CALL USING THE CORDLESS HANDSET WHILE IT IS NOT ON THE TELEPHONE BASE OR CHARGING BASE

On the cordless handset, press  or .

- The  key illuminates when in use. The  key illuminates when in speakerphone mode.

#### ANSWER A CALL USING THE CORDLESS HANDSET WHILE IT IS CRADLED ON THE TELEPHONE BASE OR CHARGING BASE

Lift the cordless handset from the telephone base or charging base.

- The  key illuminates when in use. The  key illuminates when in speakerphone mode.



#### ANSWER A CALL USING THE TELEPHONE BASE



On the telephone base, press .

- The  key illuminates when in use.

#### PLACE A CALL

##### PLACE A CALL USING THE CORDLESS HANDSET

On the cordless handset, press  or . Listen for a dial tone and then dial the desired number, or press a Speed Dial key on the cordless handset to dial a programmed number.

- The  key illuminates when in use. The  key illuminates when in speakerphone mode.

##### PLACE A CALL USING THE TELEPHONE BASE

On the telephone base, press . Listen for a dial tone and then dial the desired number, or press a Speed Dial key on the telephone base to dial a programmed number.

- The  key illuminates when in use.

#### END A CALL



##### END A CALL WHEN USING THE CORDLESS HANDSET

Press  on the cordless handset or place it in the telephone base or charging base. The call ends when all handsets hang up.

##### END A CALL WHEN USING THE TELEPHONE BASE

Press .

#### SWITCH A CALL BETWEEN THE CORDLESS HANDSET AND THE TELEPHONE BASE SPEAKERPHONE

- To switch a call from the cordless handset to the telephone base speakerphone, press  on the telephone base.
- To switch a call from the telephone base speakerphone to the cordless handset which is not on the telephone base cradle, press  or  on the cordless handset.
- To switch a call from the telephone base speakerphone to the cordless handset which is cradled on the telephone base, lift the cordless handset from the



## SHARE A CALL

A maximum of two cordless handsets can be used at the same time on an external call.

## JOIN A CALL

During a call, press  or  on another cordless handset to join.



## HANDSET SPEAKERPHONE

During a call, press  on the cordless handset to switch between speakerphone mode and handset earpiece mode. The  key illuminates when in speakerphone mode.

## VOLUME

Listening volume can be adjusted on the cordless handset and the telephone base.



### ADJUST THE LISTENING VOLUME

- During a call on the handset, press  and  to adjust the listening volume. The next call returns to the default listening volume.
- During a call on the telephone base, press **VOL+** and **VOL-** to adjust the listening volume. The next call returns to the default listening volume.

### ADJUST THE RINGER VOLUME OF THE TELEPHONE BASE





Ringer volume of the telephone base can be adjusted. When the telephone base is idle, press **VOL+** and **VOL-** to adjust the ringer volume.

## CALL WAITING

1. When you hear a call waiting tone during a call, press  on the cordless handset to put the current call on hold and take the new incoming call.
2. Press  at any time to switch back and forth between calls.

## MUTE

### MUTE THE MICROPHONE

1. During a call, press **MUTE** / .
  - The **MUTE** /  key on the handset / telephone base illuminates when the mute function is turned on. You can hear the party on the other end, but they cannot hear you.
2. Press **MUTE** /  again to resume the conversation.
  - The light on the  key turns off.

### MESSAGE WAITING INDICATOR

When a voice message is received, the message waiting LED on the telephone base flashes.

### PLAY MESSAGES



Press **MESSAGE** /  in idle mode to play messages.

## HOLD

### TO PLACE A CALL ON HOLD:

During a call, press the **HOLD** /  key.

### TO TAKE THE CALL OFF HOLD:

Press  or  on the handset, OR press  on the telephone base.

# Appendix

## Troubleshooting

If you have difficulty with the telephones, please try the suggestions below. For customer service, visit our website at [www.vtechhotelphones.com](http://www.vtechhotelphones.com) or call 1-888-907-2007.

### FOR CORDLESS TELEPHONE

QUESTION	SUGGESTIONS
1. The telephone does not work at all.	<ul style="list-style-type: none"><li>• Make sure the Cat-5 network cable is plugged into the <b>LAN</b> port of the telephone base and the network wall jack with Power over Ethernet (PoE).</li><li>• Make sure the battery is installed and charged correctly. For optimum daily performance, return the cordless handset to the telephone base or charging base after use.</li><li>• Unplug the Cat-5 network cable from the network wall jack. Wait for approximately 15 seconds, then plug it back in.</li><li>• Charge the battery in the cordless handset for up to 11 hours.</li><li>• If the battery is completely depleted, charge the battery for at least 30 minutes before use.</li><li>• Remove the battery and then install it again. If that still does not work, it may be necessary to purchase a new battery.</li><li>• Disconnect the telephone base from the network wall jack and connect a different working SIP telephone. If the other SIP telephone does not work, the problem is probably in the wiring or network server. Check your SIP server settings. Refer to the <b>SIP Phone Configuration Guide</b> for details.</li><li>• Make sure the energy-saving charging mode is not activated. If this mode is activated, all telephone functions will be disabled, except battery charging.</li></ul>

## QUESTION

## SUGGESTIONS

2. here is no dial tone.

- Try all the above suggestions.
- The Cat-5 network cable may be defective. Install a new Cat-5 network cable.
- Make sure your network is providing Power over Ethernet (PoE).
- Disconnect the telephone base from the network wall jack and connect a different working SIP telephone. If there is no dial tone on this telephone either, the problem is in your wiring or network server. Check your SIP server settings and refer to the **SIP Phone Configuration Guide** for details.
- Make sure the initialization and system registration process completes. The speakerphone key blinks twice every second if there are errors with the initialization and system registration process. Check your SIP server settings. Refer to the **SIP Phone Configuration Guide** for details.
- Make sure the energy-saving charging mode is not activated. If this mode is activated, all telephone functions will be disabled, except battery charging.

3. I cannot dial out.

- Try all the above suggestions.
- Make sure there is a dial tone before dialing. It is normal if the cordless handset takes a second or two to synchronize with the telephone base before producing a dial tone. Wait an extra second before dialing.
- A prefix may be required for dialing some internal or external calls. Refer to the **SIP Phone Configuration Guide** for details.
- Check your SIP server settings. If other SIP telephones in your hotel are having the same problem, the problem is in the wiring or network server. Contact your telephone service provider (charges may apply).

QUESTION	SUGGESTIONS
4. The Speed Dial key does not work at all.	<ul style="list-style-type: none"> <li>The Speed Dial key may not be properly programmed. Refer to the <b>SIP Phone Configuration Guide</b> for details.</li> </ul>
5. The telephone cannot register to the SIP network server.	<ul style="list-style-type: none"> <li>Make sure your network is providing Power over Ethernet (PoE).</li> <li>Make sure the initialization and system registration process completes.</li> <li>If there is an error during the initialization and system registration process, the  key flashes twice every second. Disconnect the Cat-5 network cable from the network wall jack and connect it back into the network wall jack with Power over Ethernet (PoE) to start the initialization and system registration process again.</li> </ul>
6. The LOW BATTERY LED illuminates on the cordless handset.	<ul style="list-style-type: none"> <li>Place the cordless handset in the telephone base or charging base for recharging.</li> <li>Remove the battery and then install it again, and use it until fully depleted. Then charge the cordless handset in the telephone base or charging base for up to 11 hours.</li> <li>If the above measures do not correct the problem, replace the battery.</li> </ul>
7. The battery does not charge in the cordless handset or the battery does not accept charge.	<ul style="list-style-type: none"> <li>Make sure the cordless handset is placed in the telephone base or charging base correctly. The <b>CHARGE</b> LED should be on.</li> <li>Remove the battery and then install it again. Charge it for up to 11 hours.</li> <li>If the cordless handset is placed in the telephone base or charging base but the <b>CHARGE</b> LED is not on, refer to <b>The CHARGE LED is off</b> below.</li> <li>If the battery is completely depleted, charge the cordless handset for at least 30 minutes before use.</li> <li>If the above measures do not correct the problem, replace the battery.</li> </ul>



## QUESTION

## SUGGESTIONS

8. The **CHARGE** LED is off.

- Clean the charging contacts on the cordless handset, telephone base and/or charging base each month with a pencil eraser or a dry non-abrasive fabric.
- Make sure the Cat-5 network cable is plugged in correctly and securely.
- Unplug the Cat-5 network cable. Wait for 15 seconds before plugging it back in.

9. The telephone does not ring when there is an incoming call.

- Make sure the Cat-5 network cable is plugged into the **LAN** port of the telephone base and the network wall jack with Power over Ethernet (PoE).
- The cordless handset may be too far from the telephone base. Move it closer to the telephone base.
- Check your SIP server or telephone administrative settings. Refer to the **SIP Phone Configuration Guide** for details.
- If other SIP telephones in your hotel are having the same problem, the problem is in the wiring or network server. Contact your telephone service provider (charges may apply).
- Other electronic products such as HAM radios and other DECT telephones can cause interference with your cordless telephone. Try installing your telephone as far away as possible from these types of electronic devices.
- The Cat-5 network cable may be defective. Install a new Cat-5 network cable.
- Remove the battery and then install it again. Then place the cordless handset in the telephone base. Wait for the handset to synchronize with the telephone base. Allow up to one minute for this to take place.

10. The cordless handset beeps and is not performing normally.

- Make sure the Cat-5 network cable is plugged into the **LAN** port of the telephone base and the network wall jack with Power over Ethernet (PoE).
- Check your SIP server or telephone administrative settings. Refer to the **SIP Phone Configuration Guide** for details.
- Disconnect the telephone base from the network wall jack and connect a different working SIP telephone. If the other SIP telephone has the same problem, the problem is in the wiring or network server. Contact your telephone service provider (charges may apply).
- Other electronic products such as HAM radios and other DECT telephones can cause interference with your cordless telephone. Try installing your telephone as far away as possible from these types of electronic devices.

11. There is interference during a telephone conversation, or the call fades in and out when I am using the cordless handset.

- The cordless handset may be out of range. Move the handset closer to the telephone base or adjust the setting of RF transmission power. Refer **SIP Phone Configuration Guide** for details.
- Other electronic products such as HAM radios and other DECT telephones can cause interference with your cordless telephone. Try installing your telephone as far away as possible from these types of electronic devices.
- If other SIP telephones in your hotel are having the same problem, the problem is in the wiring or network server. Contact your telephone service provider (charges may apply).

QUESTION	SUGGESTIONS
12. I hear other calls when using the telephone.	<ul style="list-style-type: none"><li>• Disconnect the telephone base from the network wall jack and connect a different working SIP telephone. Check your SIP server settings. If calls are still not clear, the problem is probably in the wiring or network server. Contact your telephone service provider (charges may apply).</li></ul>
13. I hear noise on the cordless handset and the keys do not work.	<ul style="list-style-type: none"><li>• Make sure the Cat-5 network cable is plugged in correctly and securely.</li><li>• Unplug the Cat-5 network cable. Wait for 15 seconds before plugging it back in.</li></ul>
14. Common cure for electronic equipment.	<ul style="list-style-type: none"><li>• If the telephone is not responding normally, put the cordless handset in the telephone base. If it does not fix the problem, try the following (in the order listed):<ol style="list-style-type: none"><li>1. Disconnect the power to the telephone base.</li><li>2. Disconnect the battery on the cordless handset.</li><li>3. Wait a few minutes before connecting power to the telephone base.</li><li>4. Install the battery again and then place the cordless handset in the telephone base.</li><li>5. Wait for the cordless handset to synchronize with the telephone base. Allow up to one minute for this to take place.</li></ol></li></ul>

# Appendix

## VTech Hospitality Limited Warranty Program

VTech Communications, Inc., the manufacturer of VTech Hospitality Product ("Product"), warrants to the holder of a valid proof of purchase ("end user" or "you") that the Product and all accessories provided by VTech in the Product's package are free from defects in material and workmanship, pursuant to the following terms and conditions, when installed and used normally and in accordance with the Product's operating instructions. The limited warranty extends to the end user of this Product and applies only if such Product is purchased through a United States of America and/or Canadian distributor. The limited warranty period for this Product is determined based on the following:

### 5 YEARS – ANALOG MODELS

- All Classic Models - corded and cordless
- All Contemporary Models - corded and cordless
- All TrimStyle Models
- All Next Gen Models - corded and cordless

### 2 YEARS – SIP NON-DISPLAY MODELS

- All Classic Models - corded and cordless
- All Contemporary Models - corded and cordless
- All TrimStyle Models
- All Next Gen Models - corded and cordless

During the limited warranty period, VTech's authorized service representative will repair or replace, at VTech's option, without charge, a Product that is not free from defects in materials and workmanship. If VTech's authorized service representative repairs the Product, new or refurbished replacement parts may be used. If the Product is replaced, it may be replaced with a new or refurbished Product of the same or similar design. Repair or replacement of Product, at VTech's option, is the exclusive remedy.

The limited warranty period for the Product begins on the date that the end user takes possession of the Product. This limited warranty also applies to repaired or replacement Products for a period of either: (a) 90 days from the date the repaired or replacement Product is shipped to you; or (b) the time remaining on the original limited warranty as described above; whichever is longer.

This limited warranty does not cover:

1. Product or parts that have been subjected to misuse, accident, shipping or other physical damage, improper installation, abnormal operation or handling, neglect, inundation, fire, water or other liquid intrusion; or
2. Product that has been damaged due to repair, alteration or modification by anyone other than an authorized service representative of VTech; or
3. Product to the extent that the problem experienced is caused by signal conditions, network reliability or cable or antenna systems; or
4. Product to the extent that the problem is caused by use with non-VTech accessories; or

5. Product whose warranty/quality stickers, product serial number plates or electronic serial numbers have been removed, altered or rendered illegible; or
6. Product purchased, used, serviced, or shipped for repair from outside the United States or Canada, or used for non-approved commercial or institutional purposes (including but not limited to Products used for rental purposes); or
7. Product returned without valid proof of purchase; or
8. Charges or costs incurred by the end user, and risk of loss or damage, in removing and shipping the Product, or for installation or set up, adjustment of customer controls, and installation or repair of systems outside the unit.
9. Line cords or coil cords, plastic overlays, connectors, power adapters and batteries, if the Product is returned without them. VTech will charge the end user at then-current prices for each of the missing items.
10. NiCd, NiMH or Li-ion handset batteries, or power adapters, which, under all circumstances, are covered by a one (1) year warranty only.

Except as provided by applicable law, you assume the risk of loss or damage during transit and transportation and are responsible for delivery or handling charges incurred in the transport of Product(s) to the service location. VTech's authorized service representative will return repaired or replaced product under this limited warranty to you, transportation, delivery and handling charges prepaid. VTech assumes no risk for damage or loss of the Product in transit.

If the Product failure is not covered by this limited warranty, or proof of purchase does not meet the terms of this limited warranty, VTech will notify you and will request that you authorize

the cost of repair and return shipping costs for the repair of Products that not covered by this limited warranty. You must pay for the cost of repair and return shipping costs for the repair of Products that are not covered by this limited warranty.

#### OTHER LIMITATIONS

This warranty is the complete and exclusive agreement between you and VTech. It supersedes all other written or oral communications related to this Product. VTech provides no other warranties for this Product, whether express or implied, oral or written, or statutory. The warranty exclusively describes all of VTech's responsibilities regarding the Product. No one is authorized to make modifications to this warranty and you should not rely on any such modification.

VTech's liability to end user hereunder shall not exceed the purchase price of the Product. In no event shall VTech be liable for any indirect, special, incidental, consequential, or similar damages (including, but not limited to lost profits or revenue, inability to use the product, or other associated equipment, the cost of substitute equipment, and claims by third parties) resulting from the use of this Product. Some states/provinces do not allow the exclusion or limitation of incidental or consequential damages, so the above limitation or exclusion may not apply to you.

This warranty gives you specific legal rights, and you also have other rights which vary from state to state or province to province.

# Appendix

## Precautions for users of implanted cardiac pacemakers

Cardiac pacemakers (applies only to digital cordless telephones):

Wireless Technology Research, LLC (WTR), an independent research entity, led a multidisciplinary evaluation of the interference between portable wireless telephones and implanted cardiac pacemakers. Supported by the U.S. Food and Drug Administration, WTR recommends to physicians that:

Pacemaker patients

- Should keep wireless telephones at least six inches from the pacemaker.
- Should NOT place wireless telephones directly over the pacemaker, such as in a breast pocket, when it is turned ON.
- Should use the wireless telephone at the ear opposite the pacemaker.

WTR's evaluation did not identify any risk to bystanders with pacemakers from other persons using wireless telephones.

## Operating range

The cordless telephone operates with the maximum power allowed by the Federal Communications Commission (FCC). Even so, the cordless handset and telephone base can communicate over only a certain distance - which can vary with the locations of the telephone base, cordless handset, the weather, and the layout of the hotel.

When the cordless handset is out of range while on a call, the cordless handset rapidly beeps three times.

If there is a call while the handset is out of range, it may not ring, or if it does ring, the call may not connect well when you answer the call. Move closer to the telephone base to answer the call.

If the handset moves out of range during a telephone conversation, there may be interference.

To improve reception, move closer to the telephone base.

## About cordless telephones

**Privacy:** The same features that make a cordless telephone convenient create some limitations. Telephone calls are transmitted between the telephone base and the cordless handset by radio waves, so there is a possibility that the cordless telephone conversations could be intercepted by radio receiving equipment within range of the cordless handset. For this reason, you should not think of cordless telephone conversations as being as private as those on corded telephones.

**Electrical power:** The telephone base of the cordless telephone must be connected to a working electrical outlet. The electrical outlet should not be controlled by a wall switch. Calls cannot be made from the cordless handset if the telephone base is unplugged, switched off or if the electrical power is interrupted.

**Potential TV interference:** Some cordless telephones operate at frequencies that may cause interference to televisions and VCRs. To minimize or prevent such interference, do not place the telephone base of the cordless telephone near or on top of a TV or VCR. If interference is experienced, moving the cordless telephone farther away from the TV or VCR often reduces or eliminates the interference.

**Rechargeable batteries:** Exercise care in handling batteries in order not to create a short circuit with conducting material such as rings, bracelets and keys. The battery or conductor may overheat and cause harm. Observe proper polarity between the battery and the battery charger.

## Appendix

### FCC, ACTA and IC regulations

#### FCC PART 15

This equipment has been tested and found to comply with the limits for a Class A digital device, pursuant to part 15 of the FCC Rules. These limits are designed to provide reasonable protection against harmful interference when the equipment is operated in a commercial environment. This equipment generates, uses, and can radiate radio frequency energy and, if not installed and used in accordance with the instruction manual, may cause harmful interference to radio communications. Operation of this equipment in a residential area is likely to cause harmful interference in which case the user will be required to correct the interference at his own expense.

Changes or modifications to this equipment not expressly approved by the party responsible for compliance could void the user's authority to operate the equipment.

This device complies with Part 15 of the FCC rules. Operation is subject to the following two conditions: (1) this device may not cause harmful interference, and (2) this device must accept any interference received, including interference that may cause undesired operation.

This Class A digital apparatus complies with Canadian requirements: CAN ICES-3 (A) / NMB-3(A).

#### FCC PART 68 AND ACTA

This equipment complies with Part 68 of the FCC rules and with technical requirements adopted by the Administrative Council for Terminal Attachments (ACTA). The label on the back or bottom of this equipment contains, among other things, a product identifier in the format US: AAKXNANXXXX. This identifier must be provided to your telephone service provider upon request.

The plug and jack used to connect this equipment to premises wiring and the telephone network must comply with applicable Part 68 rules and technical requirements adopted by ACTA. A compliant telephone cord and modular plug is provided with this product. It is designed to be connected to a compatible modular jack that is also compliant. An RJ45 jack should normally be used for connecting to a single line. See the installation instructions in the user's manual.

The Ringer Equivalence Number (REN) is used to determine how many devices you may connect to your telephone line and still have them ring when you are called. The REN for this product is encoded as the 6th and 7th characters following the US: in the product identifier (e.g., if ## is 03, the REN is 0.3). In most, but not all areas, the sum of all RENs should be five (5.0) or less. For more information, please contact your telephone service provider.

This equipment may not be used with Party Lines. If you have specially wired alarm dialing equipment connected to your telephone line, ensure the connection of this equipment does not disable your alarm equipment. If you have questions about what will disable alarm equipment, consult your telephone service provider or a qualified installer.

If this equipment is malfunctioning, it must be unplugged from the modular jack until the problem has been corrected. Repairs to this telephone equipment can only be made by the manufacturer or its authorized agents. For repair procedures, follow the instructions outlined under

**VTech Hospitality limited warranty program** in the user's manual.

To ensure safety of users, the FCC/ISED has established criteria for the amount of radio frequency energy of the product. This product has been tested and found to comply with the FCC/ISED criteria. The handset may be safely held against the ear of the user. The telephone base shall be installed and used such that parts of the user's body other than the hands are maintained at a distance of approximately 20 cm (8 inches) or more.

Pour assurer la sécurité des utilisateurs, la FCC/ISED a établi des critères pour la quantité d'énergie radiofréquence qui peut être absorbée en toute sécurité par un utilisateur ou un spectateur en fonction de l'utilisation prévue du produit. Ce produit a été testé et déclaré conforme aux critères FCC/ISED. Le combiné peut être maintenu en toute sécurité contre l'oreille de l'utilisateur. Le socle du téléphone doit être installé et utilisé de façon à ce que les parties du corps de l'utilisateur autres que les mains soient maintenues à une distance d'environ 20 cm (8 pouces) ou plus.

If this equipment is causing harm to the telephone network, your telephone service provider may temporarily discontinue your telephone service. Your telephone service provider is required to notify you before interrupting service. If advance notice is not practical, you will be notified as soon as possible. You will be given the opportunity to correct the problem and your telephone service provider is required to inform you of your right to file a complaint with the FCC. Your telephone service provider may make changes in its facilities, equipment, operation, or procedures that could affect the proper functioning of this product. Your telephone service provider is required to notify you if such changes are planned.

If this product is equipped with a corded or cordless handset, it is hearing aid compatible.

If this product has memory dialing locations, you may choose to store emergency telephone

numbers (e.g., police, fire, medical) in these locations. If you do store or test emergency numbers, please:

Remain on the line and briefly explain the reason for the call before hanging up.

Perform such activities in off-peak hours, such as early morning or late evening.

When the adjunct is used with a leased system, permission of the owner of the equipment must be obtained for connection of the adjunct because modification of the host system is often required.

This product can only be connected to the host equipment and never directly to the network.

## INDUSTRY CANADA

This product meets the applicable Innovation, Science and Economic Development Canada technical specifications.

The Ringer Equivalence Number (REN) is an indication of the maximum number of devices allowed to be connected to a telephone interface. The termination of an interface may consist of any combination of devices subject only to the requirement that the sum of the RENs of all the devices not exceed five.

Le présent matériel est conforme aux spécifications techniques applicables d'Innovation, Sciences et Développement économique Canada.

L'indice d'équivalence de la sonnerie (IES) sert à indiquer le nombre maximal de terminaux qui peuvent être raccordés à une interface téléphonique. La terminaison d'une interface peut consister en une combinaison quelconque de dispositifs, à la seule condition que la somme d'indices d'équivalence de la sonnerie de tous les dispositifs n'excède pas cinq.

## ISED WARNING

This device complies with Innovation, Science, and Economic Development Canada licence exempt RSS standard(s). Operation is subject to the following two conditions:

1. This device may not cause interference, and



2. This device must accept any interference, including interference that may cause undesired operation of the device. Privacy of communications may not be ensured when using this telephone.

Operation of 5150-5350 MHz is restricted to indoor use only.

#### AVERTISSEMENT ISEDC

Cet appareil est compatible avec la licence de l'Innovation, la Science et le développement économique du Canada à l'exemption des normes RSS. Le fonctionnement est sujet aux deux (2) conditions suivantes :

(1) Cet appareil peut ne pas causer de l'interférence, et

(2) Cet appareil doit accepter l'interférence, incluant de l'interférence qui peut causer un mauvais fonctionnement de cet appareil.

La confidentialité des communications peut ne pas être garantie lors de l'utilisation de ce téléphone.

Le fonctionnement de 5150-5350 MHz est limité à une utilisation en intérieur uniquement.

## Appendix

### Energy-saving charging mode

When this mode is activated, all telephone functions, except handset battery charging, will be disabled.

TO ACTIVATE THE ENERGY-SAVING CHARGING MODE IN NG-S3411 & NG-S3411W:

1. Remove the plastic cover from the back of the telephone base.

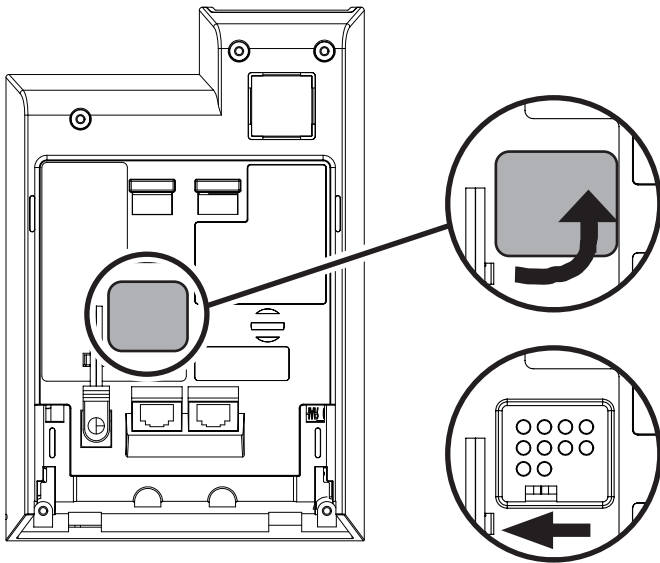

2. Slide the base power switch to the off position.

When the telephone base and handset successfully enters the energy-saving charging mode, all keys on the telephone base should not respond.

If the telephone fails to enter this mode, slide the base power switch to the on position, and then back to the off position.

#### NOTE

- Make sure the telephone base is connected to a network wall jack by an Ethernet cable (for PoE), or a power adapter plugged in the power outlet.
- Make sure the battery is installed in the handset, and the handset is cradled in the telephone base.

TO DEACTIVATE THE ENERGY-SAVING CHARGING MODE:

1. Slide the base power switch back to the on position. Then plug the power adapter or the Ethernet cable back in the telephone base to reconnect the power.
2. Register the handsets back to the telephone base. See "Handset registration" on page 16 for instructions.

## Maintenance

### TAKING CARE OF YOUR TELEPHONE

Your telephone contains sophisticated electronic parts, so it must be treated with care.

### AVOID ROUGH TREATMENT

Place the handset down gently. Save the original packing materials to protect your telephone if you ever need to ship it.

### AVOID WATER

Your telephone can be damaged if it gets wet. Do not use the handset outdoors in the rain, or handle it with wet hands. Do not install the telephone base near a sink, bathtub or shower.

### ELECTRICAL STORMS

Electrical storms can sometimes cause power surges harmful to electronic equipment. For your own safety, take caution when using electrical appliances during storms.

### CLEANING YOUR TELEPHONE

Your telephone has a durable plastic casing that should retain its luster for many years. Clean it only with a soft cloth slightly dampened with water or mild soap. Do not use excess water or cleaning solvents of any kind.

## Disclaimer and Limitation of Liability

VTech Communications, Inc. and its suppliers assume no responsibility for any damage or loss resulting from the use of this user's manual. VTech Communications, Inc. and its suppliers assume no responsibility for any loss or claims by third parties that may arise through the use of this product. VTech Communications, Inc. and its suppliers assume no responsibility for any damage or loss caused by deletion of data as a result of malfunction, dead battery, or repairs. Be sure to make backup copies of important data on other media to protect against data loss.

**Company:** VTech Communications, Inc.

**Address:** 9020 SW Washington Square Road., Suite 555, Tigard, OR 97223, United States

**Phone:** 1 (888) 907-2007

REMEMBER THAT ELECTRICAL APPLIANCES CAN CAUSE SERIOUS INJURY IF USED WHEN YOU ARE WET OR STANDING IN WATER. IF THE TELEPHONE BASE SHOULD FALL INTO WATER, DO NOT RETRIEVE IT UNTIL YOU UNPLUG THE POWER CORD AND/OR ETHERNET CABLE FROM THE WALL. THEN REMOVE THE TELEPHONE BY THE UNPLUGGED CORDS/CABLES.

## Technical specifications

### SIP Next Gen Cordless 1-line Hotel Telephone - NG-S3411

### SIP Next Gen Cordless 1-line Wi-Fi Enabled Hotel Telephone - NG-S3411W

### Next Gen Cordless 1-line Accessory Handset and Charging Base - NG-C3411HC

Frequency control	Crystal controlled PLL synthesizer
Transmit frequency (USA)	Handset: 1921.536-1928.448 MHz Telephone base: 1921.536-1928.448 MHz For Wi-Fi enabled model (NG-S3411W): 2.4 GHz WiFi: 2412-2462 MHz 5 GHz WiFi: 5180-5240 MHz, 5260-5320 MHz, 5500-5700 MHz, 5745-5825 MHz
Transmit frequency (Canada)	Handset: 1921.536-1928.448 MHz Telephone base: 1921.536-1928.448 MHz For Wi-Fi enabled model (NG-S3411W): 2.4 GHz WiFi: 2412-2462 MHz 5 GHz WiFi: 5180-5240 MHz, 5260-5320 MHz, 5500-5580 MHz, 5660-5700 MHz, 5745-5825 MHz
Channels	5
Nominal effective range	Maximum power allowed by FCC and IC. Actual operating range may vary according to environmental conditions at the time of use.
Power requirement	Telephone base: <ul style="list-style-type: none"><li>• Power over Ethernet (PoE): IEEE 802.3at supported, class 2</li><li>• If PoE not available, power adapter (sold separately for NG-S3411 model):<ul style="list-style-type: none"><li>• Input: 100-240V AC 50/60Hz Output: 5.0V DC @ 2.0A</li><li>• Manufacturer: VT-PLII</li><li>• Model identifier: VT07EUS05200</li><li>• Use only the power adapter indicated above for the telephone base</li></ul></li></ul> Handset: <ul style="list-style-type: none"><li>• Battery: 3.7V 1000mAH, Li-ion (Model No. 523450AR1000)</li><li>• Use only the supplied battery or the battery indicated above</li></ul> Charging base power adapter (sold separately): <ul style="list-style-type: none"><li>• Input: 100-120V AC 60 Hz Output: 6V DC @ 400 mA</li><li>• Manufacturer: VT-PLII</li><li>• Model identifier: VT05UUS06040</li><li>• Use only the power adapter indicated above for the charging base</li></ul>
Message waiting signal	SIP messaging RFC 3261
Speed Dial memory	Telephone base: 8 dedicated speed dial hard keys, with 2 additional hard keys (MESSAGE, EMERGENCY) that can be programmed as speed dial keys Handset: 3 dedicated speed dial hard keys, with one additional hard key (✉) that can be programmed as speed dial keys



Specifications are subject to change without notice.

Copyright © 2022

VTech Communications, Inc.

All rights reserved. 08/22.

NG-S3411\_NG-S3411W\_NG-C3411HC\_UG\_V4\_CEC\_US\_2022.08.08