

# TEST REPORT

Applicant Name : FCC: VTech Telecommunications Ltd  
 ISEDC: VTECH TELECOMMUNICATIONS LIMITED  
 Address : FCC: 23/F Tai Ping Ind Center Block 1 57 Ting Kok Rd Tai Po  
 NT, Hong Kong  
 ISEDC: BL.1 23/F Tai Ping Industr Ctr. 57 Ting Kok Road Tai  
 Po, NT Hongkong  
 Report Number : SZNS211213-64525E-RFA  
 FCC ID: EW780-H0FH-13  
 IC: 1135B-80H0FH13

## Test Standard (s)

FCC PART 15D; RSS-GEN ISSUE 5, FEBRUARY 2021 AMENDMENT 2; RSS-213, ISSUE 3, MARCH 2015

## Sample Description

Product Type: SIP Cordless Hotel Telephone  
 Model No.: NG-S3411W  
 Multiple Model(s) No.: N/A  
 Trade Mark: vtech  
 Date Received: 2021/12/31  
 Report Date: 2022/03/03

Test Result:	Pass*
--------------	-------

\* In the configuration tested, the EUT complied with the standards above.

## Prepared and Checked By:

*Black Ding*

Black Ding  
EMC Engineer

## Approved By:

*Candy Li*

Candy Li  
EMC Engineer

Note: This report may contain data that are not covered by the A2LA accreditation and are marked with an asterisk "\*" .

Shenzhen Accurate Technology Co., Ltd. is not responsible for the authenticity of any test data provided by the applicant. Data included from the applicant that may affect test results are marked with an asterisk "\*\*". Customer model name, addresses, names, trademarks etc. are not considered data.

This report cannot be reproduced except in full, without prior written approval of the Company. Unless otherwise stated the results shown in this test report refer only to the sample(s) tested. This report is valid only with a valid digital signature. The digital signature may be available only under the Adobe software above version 7.0.

## Shenzhen Accurate Technology Co., Ltd.

1/F., Building A, Changyuan New Material Port, Science & Industry Park, Nanshan District, Shenzhen, Guangdong, P.R. China  
 Tel: +86 755-26503290 Fax: +86 755-26503396 Web: www.atc-lab.com

## TABLE OF CONTENTS

<b>GENERAL INFORMATION</b> .....	<b>4</b>
PRODUCT DESCRIPTION FOR EQUIPMENT UNDER TEST (EUT).....	4
OBJECTIVE .....	4
TEST METHODOLOGY .....	4
MEASUREMENT UNCERTAINTY.....	5
TEST FACILITY .....	5
<b>SYSTEM TEST CONFIGURATION</b> .....	<b>6</b>
DESCRIPTION OF TEST CONFIGURATION .....	6
EQUIPMENT MODIFICATIONS .....	6
BLOCK DIAGRAM OF TEST SETUP .....	7
<b>TEST EQUIPMENT LIST</b> .....	<b>11</b>
<b>FCC §15.247 (I) &amp; §1.1307 (B) (3) &amp; §2.1091- MAXIMUM PERMISSIBLE EXPOSURE (MPE)</b> .....	<b>13</b>
APPLICABLE STANDARD .....	13
RESULT .....	14
<b>RSS-102 § 4 –EXPOSURE LIMITS</b> .....	<b>15</b>
APPLICABLE STANDARD .....	15
RESULT .....	15
<b>§ 15.317, § 15.203 &amp; RSS-GEN §6.8 ANTENNA REQUIREMENT</b> .....	<b>17</b>
APPLICABLE STANDARD .....	17
ANTENNA CONNECTOR CONSTRUCTION .....	17
<b>§ 15.315, § 15.207 &amp; RSS-213 §5.4 CONDUCTED EMISSIONS</b> .....	<b>18</b>
APPLICABLE STANDARD .....	18
EUT SETUP .....	18
EMI TEST RECEIVER SETUP.....	19
TEST PROCEDURE .....	19
FACTOR & MARGIN CALCULATION .....	19
TEST DATA .....	19
<b>§ 15.323 (A) &amp; RSS-213 §5.5 EMISSION BANDWIDTH</b> .....	<b>24</b>
APPLICABLE STANDARD .....	24
TEST PROCEDURE .....	24
TEST DATA .....	25
<b>§ 15.319 (C) &amp; RSS-213 §5.6 PEAK TRANSMIT POWER</b> .....	<b>27</b>
APPLICABLE STANDARD .....	27
TEST PROCEDURE .....	27
TEST DATA .....	28
<b>§ 15.319 (D) &amp; RSS-213 §5.7 POWER SPECTRAL DENSITY</b> .....	<b>33</b>
APPLICABLE STANDARD .....	33
TEST PROCEDURE .....	33
TEST DATA .....	33
<b>§ 15.323 (D) &amp; RSS-213 §5.8 EMISSION INSIDE AND OUTSIDE THE SUB-BAND</b> .....	<b>38</b>
APPLICABLE STANDARD .....	38
TEST PROCEDURE .....	39
TEST DATA .....	39

**§ 15.323 (F) & RSS-213 §5.3 FREQUENCY STABILITY.....60**  
 APPLICABLE STANDARD .....60  
 TEST PROCEDURE .....60  
 TEST DATA .....61

**§ 15.323 (C)(E)§ 15.319 (F) & RSS-213 §5.1&§5.2 SPECIFIC REQUIREMENTS FOR UPCS DEVICE .....62**  
 APPLICABLE STANDARD .....62  
 TEST PROCEDURE .....62  
 TEST DATA .....62  
 1) AUTOMATIC DISCONTINUATION OF TRANSMISSION.....63  
 2) MONITORING TIME .....63  
 3) LOWER MONITORING THRESHOLD.....63  
 4) MAXIMUM TRANSMIT PERIOD .....64  
 5) SYSTEM ACKNOWLEDGEMENT .....64  
 6) LEAST INTERFERED CHANNEL (LIC) .....65  
 7) RANDOM WAITING .....67  
 8) MONITORING BANDWIDTH AND REACTION TIME .....68  
 9) MONITORING ANTENNA.....69  
 10) MONITORING THRESHOLD RELAXATION .....69  
 11) DUPLEX CONNECTIONS.....69  
 12) ALTERNATIVE MONITORING INTERVAL .....71  
 13) FAIR ACCESS .....72  
 14) FRAME REPETITION STABILITY FRAME PERIOD AND JITTER .....72

## GENERAL INFORMATION

### Product Description for Equipment under Test (EUT)

HVIN	35-400346BS
FVIN	2.10.58.707d/1v13
Frequency Range	1921.536-1928.448 MHz
Maximum conducted peak output power	20.35dBm
Modulation Technique	GFSK
Antenna Specification*	ANT 0: -0.43dBi ANT 1: -0.23dBi (It is provided by the applicant)
Voltage Range	DC 5.0V from adapter
Sample serial number	SZNS211213-64525E-RF-S1 for Conducted and Radiated Emissions SZNS211213-64525E-RF-S3 for RF Conducted Test (Assigned by ATC)
Sample/EUT Status	Good condition
Adapter information	Model: VT07EUS05200 Input: AC 100-120V~50-60Hz, 0.5A Output: DC 5.0V, 2.0A, 10.0W

### Objective

The tests were performed in order to determine the compliance of the EUT with FCC Part 15-Subpart D, section 15.207, 15.315, 15.317, 15.319 and 15.323 rules. The EMI measurements were performed according to the measurement procedure described in ANSI C63.17 – 2013 and RSS-213 Issue 3, 2GHz License-Exempt Personal Communications Service Devices (PCS) OF THE Canadian Department of Industry rules and RSS-GEN ISSUE 5, FEBRUARY 2021 AMENDMENT 2 of the Innovation, Science and Economic Development Canada rules.

### Test Methodology

All measurements contained in this report were conducted with ANSI C63.17 - 2013, American National Standard Methods of Measurement of the Electromagnetic and Operational Compatibility of Unlicensed Personal Communications Services (UPCS) Devices.

All emissions measurement was performed at Shenzhen Accurate Technology Co., Ltd. The radiated testing was performed at an antenna-to-EUT distance of 3 meters.

## Measurement Uncertainty

Parameter		Uncertainty
Occupied Channel Bandwidth		5%
RF output power, conducted		0.73dB
Unwanted Emission, conducted		1.6dB
Emissions, Radiated	30MHz - 1GHz	4.28dB
	1GHz- 18GHz	4.98dB
	18GHz- 26.5GHz	5.06dB
Temperature		1°C
Humidity		6%
Supply voltages		0.4%

*Note: The extended uncertainty given in this report is obtained by combining the standard uncertainty times the coverage factor K with the 95% confidence interval. Otherwise required by the applicant or Product Regulations, Decision Rule in this report did not consider the uncertainty.*

## Test Facility

The test site used by Shenzhen Accurate Technology Co., Ltd. to collect test data is located on the 1/F., Building A, Changyuan New Material Port, Science & Industry Park, Nanshan District, Shenzhen, Guangdong, P.R. China.

The test site has been approved by the FCC under the KDB 974614 D01 and is listed in the FCC Public Access Link (PAL) database, FCC Registration No.: 708358, the FCC Designation No.: CN1189. Accredited by American Association for Laboratory Accreditation (A2LA) The Certificate Number is 429 7.01.

Listed by Innovation, Science and Economic Development Canada (ISED), the Registration Number is 5077A.

## SYSTEM TEST CONFIGURATION

### Description of Test Configuration

The system was configured to testing mode which is provided by the manufacturer.

### Equipment Modifications

No modification was made to the EUT tested.

### Support Equipment List and Details

Manufacturer	Description	Model	Serial Number
Rohde & Schwarz	Digital Radio Communication Tester	CMD60	830861/029
HUAWEI	Router	WS5100	A4933FEF1D01
Unknown	IP PBX	MY PBX	M02YS09010133
VTech	Handset	NG-S3411W	Unknown
YEALINK	POE	YLPOE30	SU10551

### External I/O Cable

Cable Description	Length (m)	From Port	To
Unshielded un-detachable DC cable	2.0	Adapter	EUT
Unshielded detachable RJ11 cable	8.0	IP PBX	EUT
Un-shielded detachable RJ45 cable	8.0	EUT/POE	Router
Unshielded un-detachable DC cable	1.5	Router	Adapter
Unshielded un-detachable AC cable	1.5	IP PBX	AC mains
Un-shielded detachable RJ45 cable	1.0	POE	EUT

### Block Diagram of Test Setup

Conducted Emission:

*Adapter:*

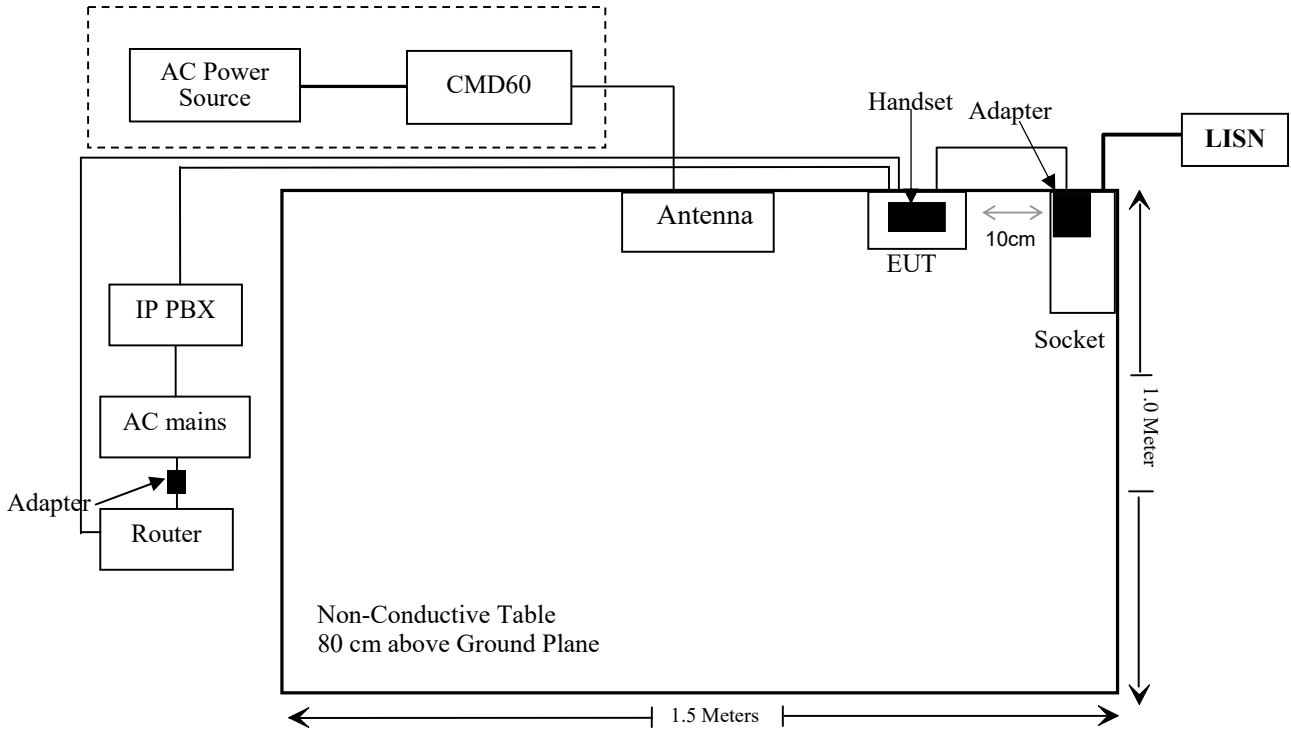

*POE:*

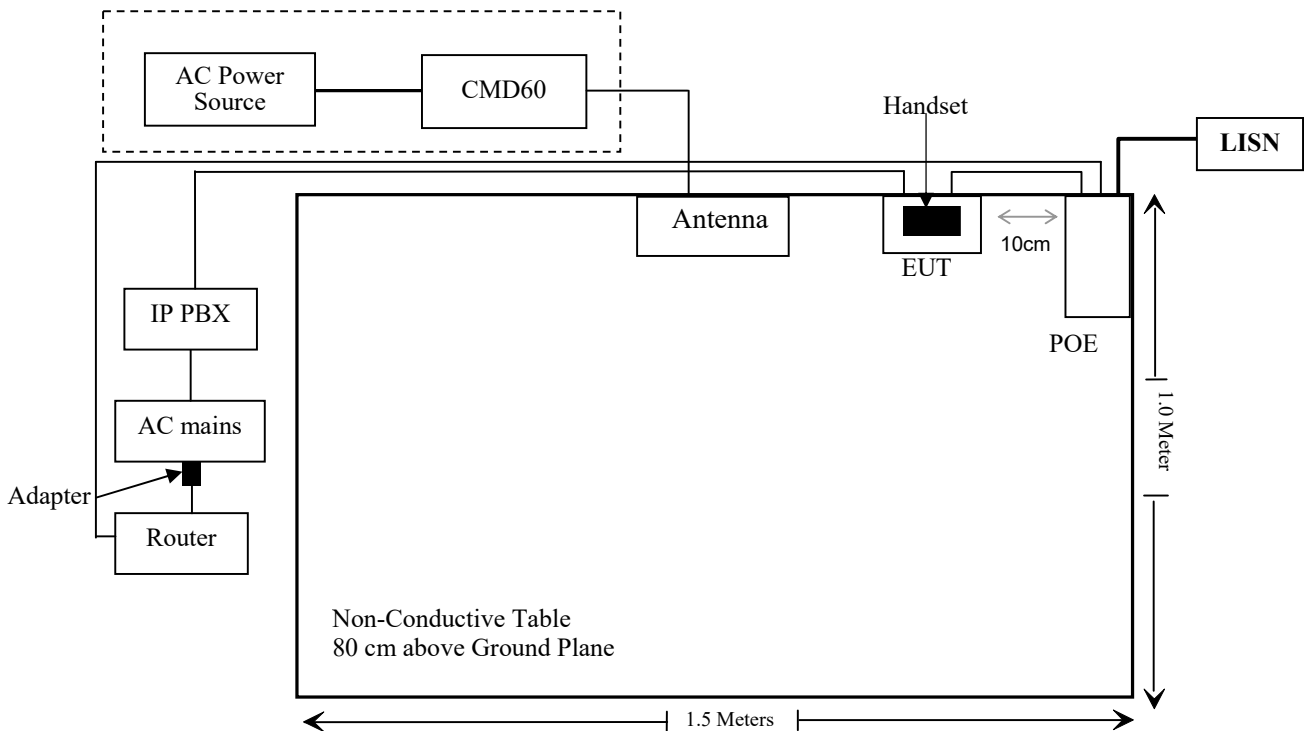

Radiated Emission(below 1GHz):

Adapter:

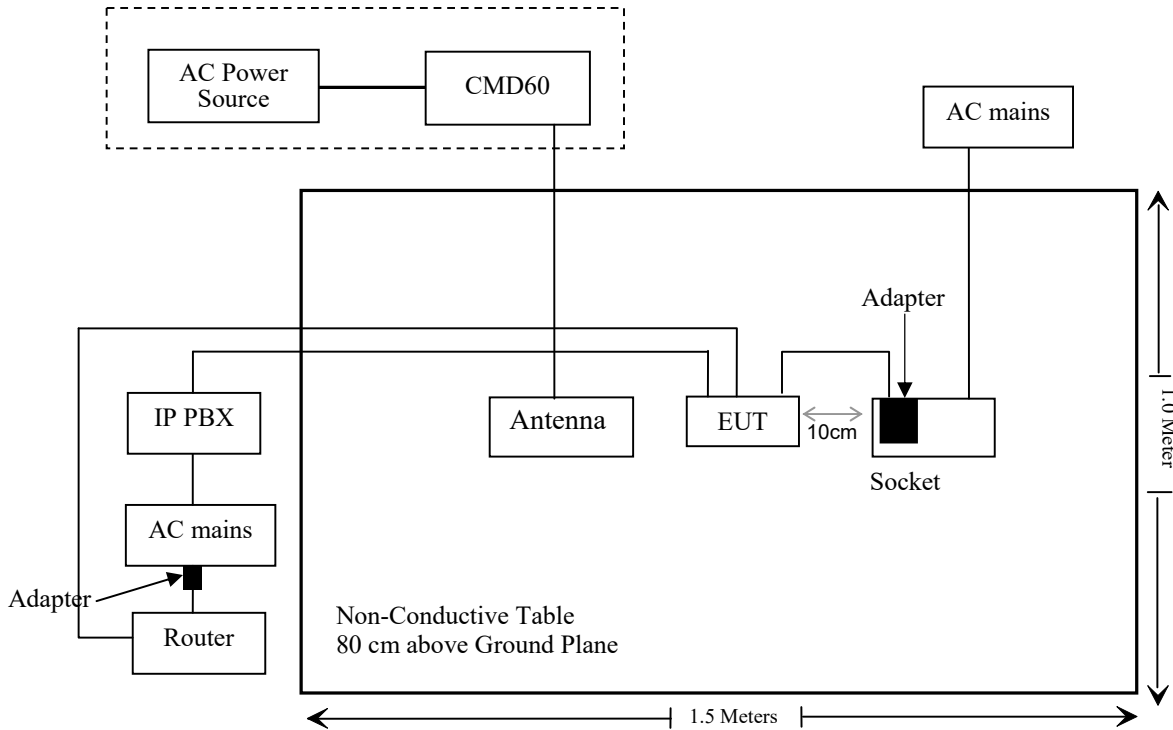

POE:

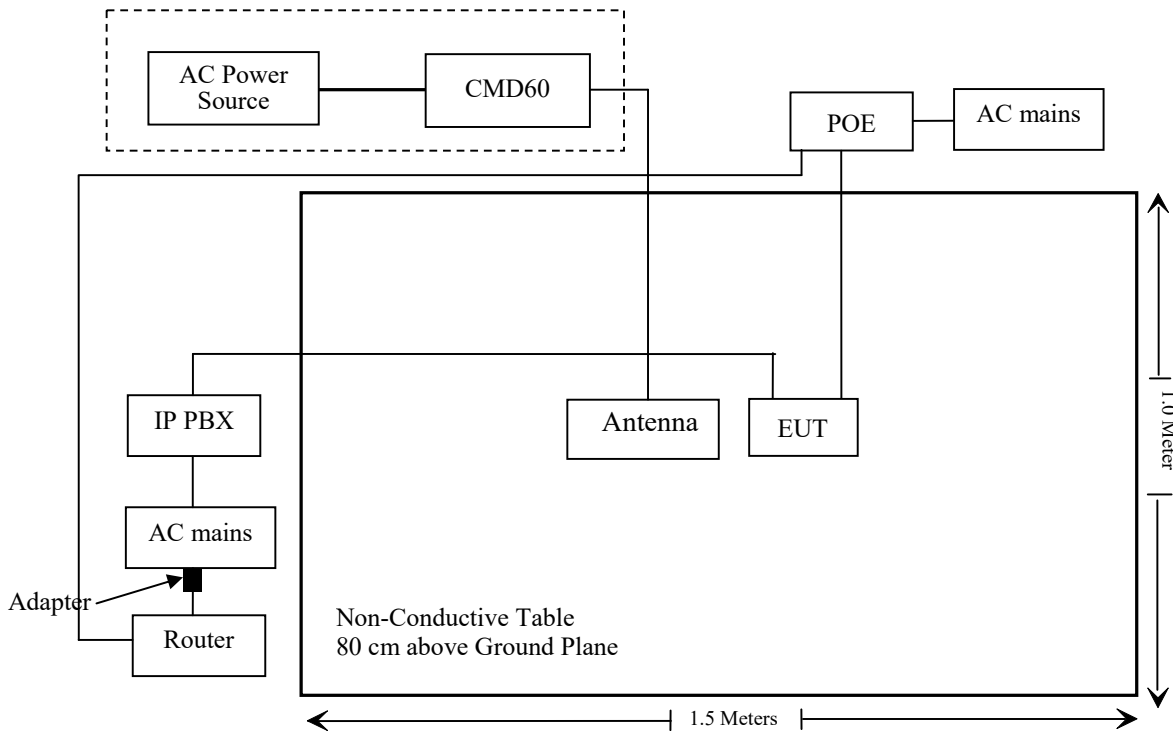



Radiated Emission(above 1GHz):

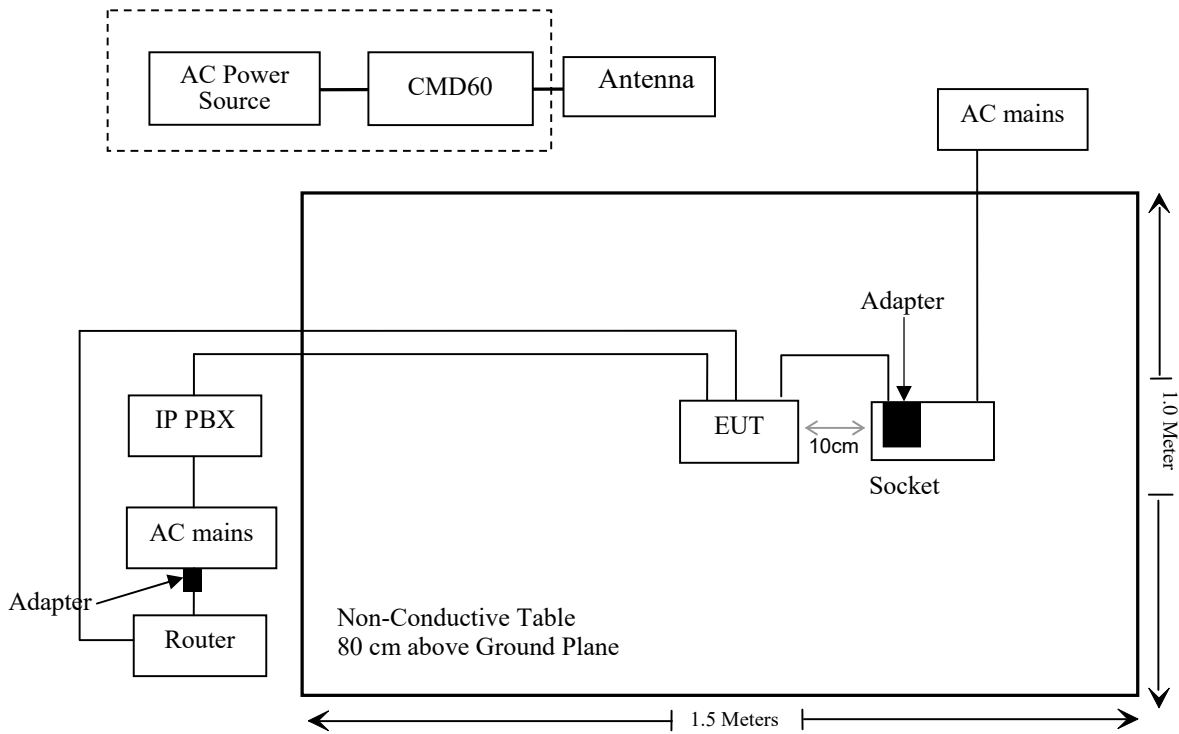

**SUMMARY OF TEST RESULTS**

<b>FCC Rules</b>	<b>ISED Rules</b>	<b>Description of Test</b>	<b>Result</b>
§ 15.319 (i) & 2.1091	RSS-102 § 4	Maximum Permissible Exposure(MPE) & EXPOSURE LIMITS	Compliant
§ 15.317, § 15.203	RSS-Gen §6.8	Antenna Requirement	Compliant
§ 15.315, § 15.207	RSS-213 §5.4	Conducted Emission	Compliant
§ 15.323 (a)	RSS-213 §5.5	Emission Bandwidth	Compliant
§ 15.319 (c)	RSS-213 §5.6	Peak Transmit Power	Compliant
§ 15.319 (d)	RSS-213 §5.7	Power Spectral Density	Compliant
§ 15.323 (d)	RSS-213 §5.8	Emission Inside and Outside the sub-band	Compliant
/	RSS-213 §5.8	Radiated Emission	Compliant
§ 15.323 (f)	RSS-213 §5.3	Frequency Stability	Compliant
§ 15.323 (c)(e) § 15.319 (f)	RSS-213 §5.1&§5.2	Specific Requirements for UPCS	Compliant

Note: EUT has two antennas, pre-scan the output power, antenna 0 is higher, so antenna 0 is chosen for the full test.

**TEST EQUIPMENT LIST**

Manufacturer	Description	Model	Serial Number	Calibration Date	Calibration Due Date
Conducted Emissions Test					
Rohde& Schwarz	EMI Test Receiver	ESCI	100784	2021/12/13	2022/12/12
Rohde & Schwarz	L.I.S.N.	ENV216	101314	2021/12/13	2022/12/12
Anritsu Corp	50 Coaxial Switch	MP59B	6100237248	2021/12/13	2022/12/12
Unknown	RF Coaxial Cable	No.17	N0350	2021/12/14	2022/12/13
Conducted Emission Test Software: e3 19821b (V9)					
Radiated Emission Test					
Rohde& Schwarz	Test Receiver	ESR	102725	2021/12/13	2022/12/12
Rohde&Schwarz	Spectrum Analyzer	FSV40	101949	2021/12/13	2022/12/12
SONOMA INSTRUMENT	Amplifier	310 N	186131	2021/11/09	2022/11/08
A.H. Systems, inc.	Preamplifier	PAM-0118P	135	2021/11/09	2022/11/08
Quinstar	Amplifier	QLW-18405536-J0	15964001002	2021/11/11	2022/11/10
Schwarzbeck	Bilog Antenna	VULB9163	9163-323	2021/07/06	2024/07/05
Schwarzbeck	Horn Antenna	BBHA9120D	9120D-1067	2020/01/05	2023/01/04
Schwarzbeck	HORN ANTENNA	BBHA9170	9170-359	2020/01/05	2023/01/04
Radiated Emission Test Software: e3 19821b (V9)					
Unknown	RF Coaxial Cable	No.10	N050	2021/12/14	2022/12/13
Unknown	RF Coaxial Cable	No.11	N1000	2021/12/14	2022/12/13
Unknown	RF Coaxial Cable	No.12	N040	2021/12/14	2022/12/13
Unknown	RF Coaxial Cable	No.13	N300	2021/12/14	2022/12/13
Unknown	RF Coaxial Cable	No.14	N800	2021/12/14	2022/12/13
Unknown	RF Coaxial Cable	No.15	N600	2021/12/14	2022/12/13
Unknown	RF Coaxial Cable	No.16	N650	2021/12/14	2022/12/13
Wainwright	High Pass Filter	WHKX3.6/18 G-10SS	5	2021/12/14	2022/12/13

Manufacturer	Description	Model	Serial Number	Calibration Date	Calibration Due Date
RF Conducted test					
Rohde & Schwarz	SPECTRUM ANALYZER	FSU26	200982	2021/07/06	2022/07/05
Rohde & Schwarz	Digital Radio Communication Tester	CMD60	830861/029	2021/07/09	2022/07/08
Mini-Circuits	Power Splitter	DC-18000MHz	SF10944151S	2021/12/14	2022/12/13
Gongwen	Temp. & Humid. Chamber	HSD-500	109	2021/10/14	2022/10/13
Rohde & Schwarz	Signal Generator	SMB100A	108362	2021/12/13	2022/12/12
AGILENT	Vector Signal Generator	N5182A	MY50143401	2021/12/13	2022/12/12
Fluke	Multi Meter	45	7664009	2021/12/14	2022/12/13
Manson	DC Power Source	KPS-6604	ATCS-205	NCR	NCR
Unknown	RF Coaxial Cable	No.31	RF-01	Each time	

\* **Statement of Traceability:** Shenzhen Accurate Technology Co., Ltd. attests that all calibrations have been performed in accordance to requirements that traceable to National Primary Standards and International System of Units (SI).

## FCC §15.247 (i) & §1.1307 (b) (3) & §2.1091- MAXIMUM PERMISSIBLE EXPOSURE (MPE)

### Applicable Standard

According to subpart 15.247 (i) and subpart 2.1091 systems operating under the provisions of this section shall be operated in a manner that ensures the public is not exposed to RF energy level in excess of the communication guidelines.

According to KDB 447498 D04 Interim General RF Exposure Guidance

MPE-Based Exemption:

General frequency and separation-distance dependent MPE-based effective radiated power(ERP) thresholds are in Table B.1 [Table 1 of § 1.1307(b)(1)(i)(C)] to support an exemption from further evaluation from 300 kHz through 100 GHz.

Table 1 to § 1.1307(b)(3)(i)(C) - Single RF Sources Subject to Routine Environmental Evaluation

RF Source frequency (MHz)	Threshold ERP (watts)
0.3-1.34	$1,920 R^2$ .
1.34-30	$3,450 R^2/f^2$ .
30-300	$3.83 R^2$ .
300-1,500	$0.0128 R^2f$ .
1,500-100,000	$19.2R^2$ .

$R$  is the minimum separation distance in meters  
 $f$  = frequency in MHz

For multiple RF sources: Multiple RF sources are exempt if:

in the case of fixed RF sources operating in the same time-averaging period, or of multiple mobile or portable RF sources within a device operating in the same time averaging period, if the sum of the fractional contributions to the applicable thresholds is less than or equal to 1 as indicated in the following equation:

$$\sum_{i=1}^a \frac{P_i}{P_{th,i}} + \sum_{j=1}^b \frac{ERP_j}{ERP_{th,j}} + \sum_{k=1}^c \frac{Evaluated_k}{Exposure Limit_k} \leq 1$$

**Result**

Mode	Frequency (MHz)	Tune up conducted power	Antenna Gain		ERP		Evaluation Distance (m)	ERP Limit (W)
		(dBm)	(dBi)	(dBd)	(dBm)	(W)		
DECT	1920- 1930	20.4	-0.23	-2.38	18.02	0.063	0.2	0.768
2.4G Wi-Fi	2412-2462	18.0	2	-0.15	17.85	0.061	0.2	0.768
5G Wi-Fi	5150-5250	14.5	2	-0.15	14.35	0.027	0.2	0.768
5G Wi-Fi	5250-5350	15.5	2	-0.15	15.35	0.034	0.2	0.768
5G Wi-Fi	5470-5725	15.0	2	-0.15	14.85	0.031	0.2	0.768
5G Wi-Fi	5725-5850	14.0	2	-0.15	13.85	0.024	0.2	0.768

Note: 1. The antenna gain and tune up conducted power was declared by the applicant.  
 2. The Wi-Fi and DECT can transmit at same time, the 2.4G Wi-Fi & 5G Wi-Fi cannot transmit Simultaneously

Simultaneous transmitting consideration (worst case):

The ratio= $ERP_{DECT}/limit+ERP_{Wi-Fi}/limit=0.063/0.768+0.061/0.768=0.161 < 1.0$ , so simultaneous exposure is compliant.

To maintain compliance with the FCC's RF exposure guidelines, place the equipment at least 20cm from nearby persons.

**Result: Compliant.**

## RSS-102 § 4 –EXPOSURE LIMITS

### Applicable Standard

According to RSS-102 § 4:

**Table 4: RF Field Strength Limits for Devices Used by the General Public (Uncontrolled Environment)**

Frequency Range (MHz)	Electric Field (V/m rms)	Magnetic Field (A/m rms)	Power Density (W/m <sup>2</sup> )	Reference Period (minutes)
0.003-10 <sup>21</sup>	83	90	-	Instantaneous*
0.1-10	-	0.73/ f	-	6**
1.1-10	87/ f <sup>0.5</sup>	-	-	6**
10-20	27.46	0.0728	2	6
20-48	58.07/ f <sup>0.25</sup>	0.1540/ f <sup>0.25</sup>	8.944/ f <sup>0.5</sup>	6
48-300	22.06	0.05852	1.291	6
300-6000	3.142 f <sup>0.3417</sup>	0.008335 f <sup>0.3417</sup>	0.02619 f <sup>0.6834</sup>	6
6000-15000	61.4	0.163	10	6
15000-150000	61.4	0.163	10	616000/ f <sup>1.2</sup>
150000-300000	0.158 f <sup>0.5</sup>	4.21 x 10 <sup>-4</sup> f <sup>0.5</sup>	6.67 x 10 <sup>-5</sup> f	616000/f <sup>1.2</sup>

**Note:** f is frequency in MHz.

\* Based on nerve stimulation (NS).

\*\* Based on specific absorption rate (SAR).

### Result

#### Calculated Formulary:

Predication of MPE limit at a given distance

$$S = \frac{PG}{4\pi R^2}$$

S = power density (in appropriate units, e.g. W/m<sup>2</sup>)

P = power input to the antenna (in appropriate units, e.g., W).

G = power gain of the antenna in the direction of interest relative to an isotropic radiator, the power gain factor, is normally numeric gain.

R = distance to the center of radiation of the antenna (appropriate units, e.g., cm)

**For simultaneously transmit system, the calculated power density should comply with:**

$$\sum_i \frac{S_i}{S_{Limit,i}} \leq 1$$

Mode	Frequency (MHz)	Antenna Gain		Max Tune Up Conducted Power		Evaluation Distance (m)	Power Density (W/m <sup>2</sup> )	MPE Limit (W/m <sup>2</sup> )
		(dBi)	(numeric)	(dBm)	(W)			
DECT	1920- 1930	-0.23	0.95	20.4	0.110	0.2	0.208	4.591
2.4G Wi-Fi	2412-2462	2	1.58	18.0	0.063	0.2	0.198	5.366
5G Wi-Fi	5150-5250	2	1.58	14.5	0.028	0.2	0.088	9.011
5G Wi-Fi	5250-5350	2	1.58	15.5	0.035	0.2	0.110	9.130
5G Wi-Fi	5470-5725	2	1.58	15.0	0.032	0.2	0.101	9.390
5G Wi-Fi	5725-5850	2	1.58	14.0	0.025	0.2	0.079	9.687

- Note: 1. The antenna gain and tune up conducted power was declared by the applicant.  
 2. The Wi-Fi and DECT can transmit at same time, the 2.4G Wi-Fi & 5G Wi-Fi cannot transmit Simultaneously

Simultaneous transmitting consideration (worst case):

$$\text{The ratio} = \text{MPE}_{2.4\text{G Wi-Fi}}/\text{limit} + \text{MPE}_{\text{DECT}}/\text{limit} = 0.198/5.366 + 0.208/4.591 = 0.082 < 1.0$$

To maintain compliance with the ISED's RF exposure guidelines, place the equipment at least 20cm from nearby persons.

**Result: Compliant**



## § 15.317, § 15.203 & RSS-Gen §6.8 ANTENNA REQUIREMENT

### Applicable Standard

According to FCC § 15.203, an intentional radiator shall be designed to ensure that no antenna other than that furnished by the responsible party shall be used with the device. The use of a permanently attached antenna or of an antenna that uses a unique coupling to the intentional radiator shall be considered sufficient to comply with the provisions of this Section. The manufacturer may design the unit so that a broken antenna can be replaced by the user, but the use of a standard antenna jack or electrical connector is prohibited.

The applicant for equipment certification shall provide a list of all antenna types that may be used with the transmitter, where applicable (i.e. for transmitters with detachable antenna), indicating the maximum permissible antenna gain (in dBi) and the required impedance for each antenna. The test report shall demonstrate the compliance of the transmitter with the limit for maximum equivalent isotropically radiated power (e.i.r.p.) specified in the applicable RSS, when the transmitter is equipped with any antenna type, selected from this list.

For expediting the testing, measurements may be performed using only the antenna with highest gain of each combination of transmitter and antenna type, with the transmitter output power set at the maximum level. However, the transmitter shall comply with the applicable requirements under all operational conditions and when in combination with any type of antenna from the list provided in the test report (and in the notice to be included in the user manual, provided below).

When measurements at the antenna port are used to determine the RF output power, the effective gain of the device's antenna shall be stated, based on a measurement or on data from the antenna's manufacturer.

The test report shall state the RF power, output power setting and spurious emission measurements with each antenna type that is used with the transmitter being tested.

For licence-exempt equipment with detachable antennas, the user manual shall also contain the following notice in a conspicuous location:

This radio transmitter [enter the device's ISED certification number] has been approved by Innovation, Science and Economic Development Canada to operate with the antenna types listed below, with the maximum permissible gain indicated. Antenna types not included in this list that have a gain greater than the maximum gain indicated for any type listed are strictly prohibited for use with this device. Immediately following the above notice, the manufacturer shall provide a list of all antenna types which can be used with the transmitter, indicating the maximum permissible antenna gain (in dBi) and the required impedance for each antenna type.

### Antenna Connector Construction

The EUT has two integral antenna arrangements which were permanently attached, fulfill the requirement of this section. Please refer to the EUT photos.

ANT	Type	Antenna Gain	Impedance
ANT 0	PCB	-0.43dBi	50 Ω
ANT 1	Monopole	-0.23dBi	50 Ω

## § 15.315, § 15.207 & RSS-213 §5.4 CONDUCTED EMISSIONS

### Applicable Standard

FCC§15.315, an unlicensed PCS device that is designed to be connected to the public utility (AC) power line must meet the limits specified in §15.207.

A radio apparatus that is designed to be connected to the public utility (AC) power line shall ensure that the radio frequency voltage, which is conducted back onto the AC power line on any frequency or frequencies within the band 150 kHz-30 MHz, shall not exceed the limits in the below table.

Unless the requirements applicable to a given device state otherwise, for any radio apparatus equipped to operate from the public utility AC power supply either directly or indirectly (such as with a battery charger), the radio frequency voltage of emissions conducted back onto the AC power lines in the frequency range of 0.15 MHz to 30 MHz shall not exceed the limits shown in below table. The more stringent limit applies at the frequency range boundaries.

Table - AC Power Lines Conducted Emission Limits		
Frequency range (MHz)	Conducted limit (dB $\mu$ V)	
	Quasi-Peak	Average**
0.15 – 0.5	66 to 56*	56 to 46*
0.5 – 5	56	46
5 – 30	60	50

Note: \*Decreases with the logarithm of the frequency  
\*\* A linear average detector is required

### EUT Setup

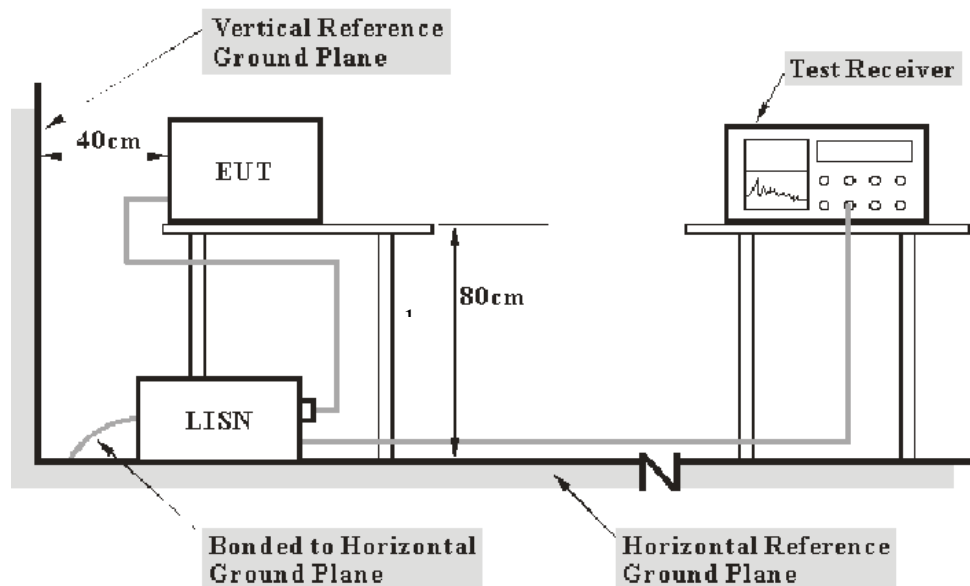

- Note: 1. Support units were connected to second LISN.  
2. Both of LISNs (AMN) 80 cm from EUT and at the least 80 cm from other units and other metal planes support units.

The setup of EUT is according with per ANSI C63.10-2013 measurement procedure. The specification used was with the FCC 15.315, FCC 15.207 and RSS-Gen limits.

The external I/O cables were draped along the test table and formed a bundle 30 to 40 cm long in the middle.

The spacing between the peripherals was 10 cm.

### EMI Test Receiver Setup

The EMI test receiver was set to investigate the spectrum from 150 kHz to 30 MHz.

During the conducted emission test, the EMI test receiver was set with the following configurations:

Frequency Range	IF B/W
150 kHz – 30 MHz	9 kHz

### Test Procedure

During the conducted emission test, adapter was connected to the outlet of the LISN.

Maximizing procedure was performed on the six (6) highest emissions of the EUT.

All final data was recorded in the Quasi-peak and average detection mode.

### Factor & Margin Calculation

The Factor is calculated by adding the LISN Insertion Loss, Cable Loss. The basic equation is as follows:

$$\text{Factor} = \text{LISN Insertion Loss} + \text{Cable Loss}$$

The “**Over Limit**” column of the following data tables indicates the degree of compliance with the applicable limit. For example, a over limit of -7 dB means the emission is 7 dB below the limit. The equation for margin calculation is as follows:

$$\begin{aligned} \text{Over Limit} &= \text{Level} - \text{Limit} \\ \text{Level} &= \text{Read level} + \text{Factor} \end{aligned}$$

### Test Data

#### Environmental Conditions

Temperature:	22 °C
Relative Humidity:	57 %
ATM Pressure:	101.0 kPa

*The testing was performed by Bin Duan on 2022-01-04.*

*EUT operation mode: Transmitting (worst case is Low channel)*

**Powered by Adapter:**

**AC 120V/60 Hz, Line**

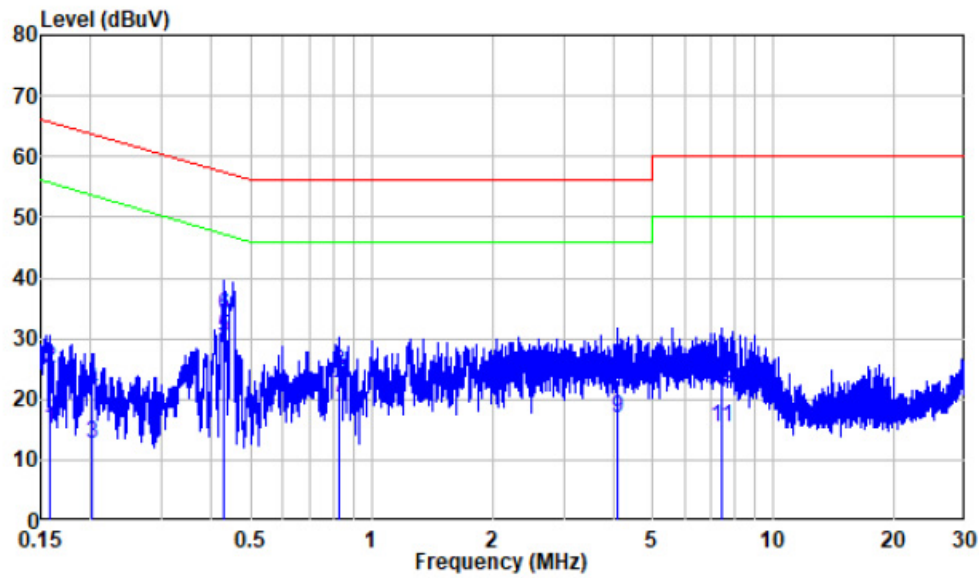

	Freq	Factor	Read Level	Level	Limit Line	Over Limit	Remark
	MHz	dB	dBuV	dBuV	dBuV	dB	
1	0.158	9.88	5.34	15.22	55.55	-40.33	Average
2	0.158	9.88	15.32	25.20	65.55	-40.35	QP
3	0.201	9.80	2.92	12.72	53.56	-40.84	Average
4	0.201	9.80	11.48	21.28	63.56	-42.28	QP
5	0.430	9.80	20.31	30.11	47.25	-17.14	Average
6	0.430	9.80	24.13	33.93	57.25	-23.32	QP
7	0.832	9.81	10.50	20.31	46.00	-25.69	Average
8	0.832	9.81	14.76	24.57	56.00	-31.43	QP
9	4.097	9.94	7.10	17.04	46.00	-28.96	Average
10	4.097	9.94	13.22	23.16	56.00	-32.84	QP
11	7.417	10.07	5.28	15.35	50.00	-34.65	Average
12	7.417	10.07	11.79	21.86	60.00	-38.14	QP

AC 120V/60 Hz, Neutral

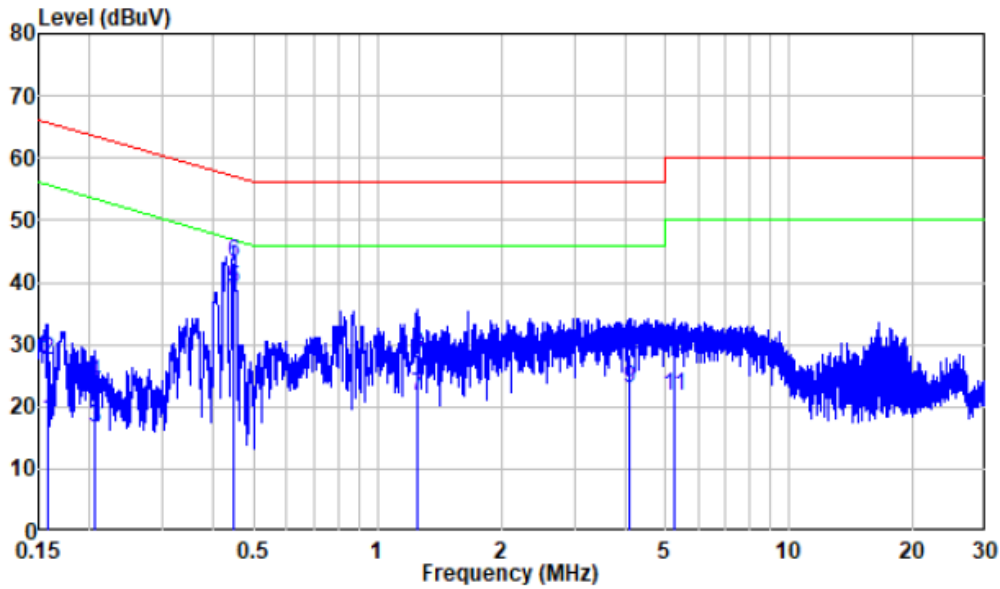

	Freq	Factor	Read Level	Level	Limit Line	Over Limit	Remark
	MHz	dB	dBuV	dBuV	dBuV	dB	
1	0.157	9.92	7.81	17.73	55.60	-37.87	Average
2	0.157	9.92	17.61	27.53	65.60	-38.07	QP
3	0.205	10.00	6.49	16.49	53.41	-36.92	Average
4	0.205	10.00	13.75	23.75	63.41	-39.66	QP
5	0.446	9.91	29.03	38.94	46.94	-8.00	Average
6	0.446	9.91	33.12	43.03	56.94	-13.91	QP
7	1.253	9.91	11.81	21.72	46.00	-24.28	Average
8	1.253	9.91	18.58	28.49	56.00	-27.51	QP
9	4.070	10.04	12.89	22.93	46.00	-23.07	Average
10	4.070	10.04	18.32	28.36	56.00	-27.64	QP
11	5.232	10.05	11.81	21.86	50.00	-28.14	Average
12	5.232	10.05	18.16	28.21	60.00	-31.79	QP

**Powered by POE:**

**AC 120V/60 Hz, Line**

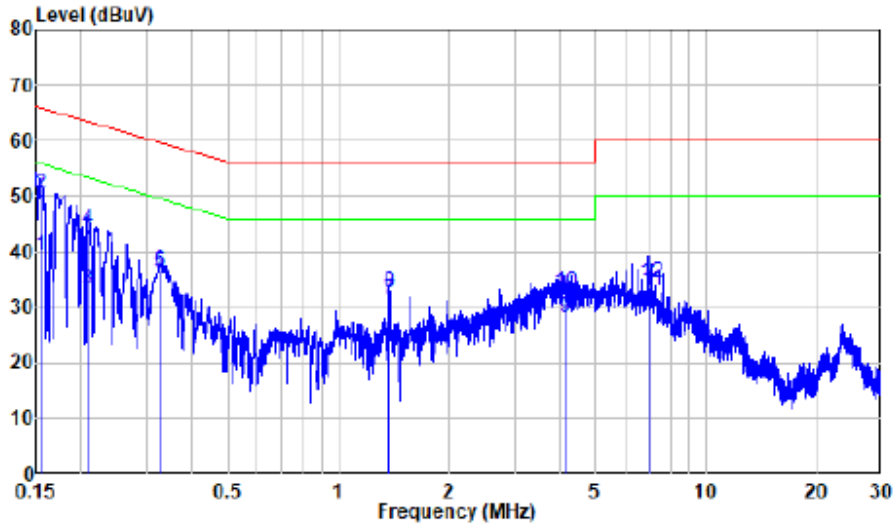

	Freq	Factor	Read Level	Level	Limit Line	Over Limit	Remark
	MHz	dB	dBuV	dBuV	dBuV	dB	
1	0.154	9.80	29.39	39.19	55.76	-16.57	Average
2	0.154	9.80	40.50	50.30	65.76	-15.46	QP
3	0.207	9.80	23.53	33.33	53.31	-19.98	Average
4	0.207	9.80	34.21	44.01	63.31	-19.30	QP
5	0.327	9.80	26.34	36.14	49.52	-13.38	Average
6	0.327	9.80	26.65	36.45	59.52	-23.07	QP
7	1.377	9.81	21.73	31.54	46.00	-14.46	Average
8	1.377	9.81	22.80	32.61	56.00	-23.39	QP
9	4.133	9.84	18.22	28.06	46.00	-17.94	Average
10	4.133	9.84	22.70	32.54	56.00	-23.46	QP
11	7.086	9.87	23.15	33.02	50.00	-16.98	Average
12	7.086	9.87	24.66	34.53	60.00	-25.47	QP

**AC 120V/60 Hz, Neutral**

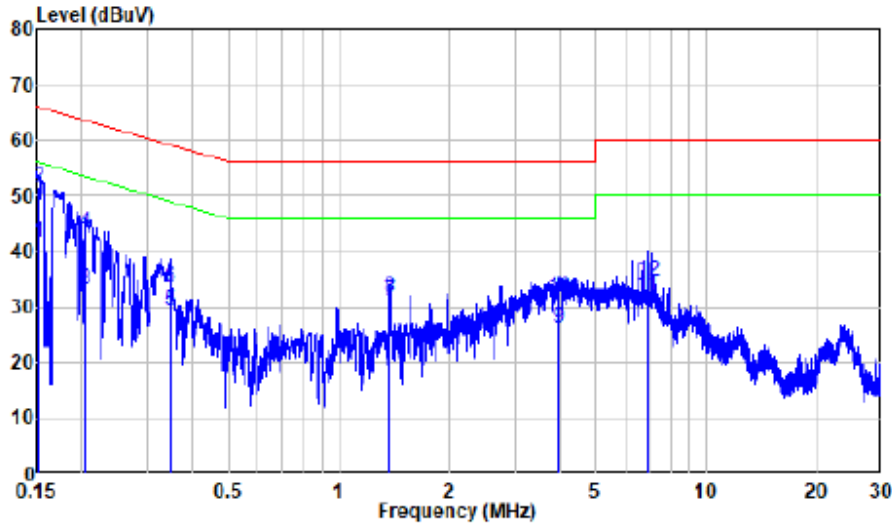

	Freq	Factor	Read Level	Limit Level	Limit Line	Over Limit	Remark
	MHz		dBuV	dBuV	dBuV	dB	
1	0.151	9.80	31.76	41.56	55.93	-14.37	Average
2	0.151	9.80	41.75	51.55	65.93	-14.38	QP
3	0.203	9.80	23.32	33.12	53.48	-20.36	Average
4	0.203	9.80	33.65	43.45	63.48	-20.03	QP
5	0.346	9.80	19.35	29.15	49.05	-19.90	Average
6	0.346	9.80	23.70	33.50	59.05	-25.55	QP
7	1.379	9.81	21.25	31.06	46.00	-14.94	Average
8	1.379	9.81	21.97	31.78	56.00	-24.22	QP
9	3.953	9.84	16.42	26.26	46.00	-19.74	Average
10	3.953	9.84	21.96	31.80	56.00	-24.20	QP
11	6.896	9.97	22.08	32.05	50.00	-17.95	Average
12	6.896	9.97	24.78	34.75	60.00	-25.25	QP

## § 15.323 (a) & RSS-213 §5.5 EMISSION BANDWIDTH

### Applicable Standard

Operation shall be contained within the 1920–1930 MHz band. The emission bandwidth shall be less than 2.5 MHz and greater than 50 kHz.

The emission bandwidth is measured in accordance with ANSI C63.17 sub-clause 6.1.3 using the setup below:

Test Setup 1:

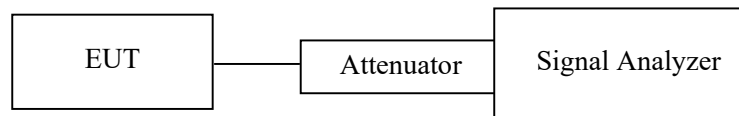

The width, in Hz, of the signal between two points, one below the carrier center frequency and one above the carrier center frequency, that is 26 dB down relative to the maximum level of the modulated carrier. It is based on the use of measurement instrumentation employing a peak detector function with an instrument resolution bandwidth approximately equal to 1% of the emission band-width of the device under measurement. [Extraction from 47 CFR 15, subpart D, 15.303 (C)].

### Test Procedure

Using the manufacturer's information on occupied bandwidth set the spectrum analyzer as follows:

Resolution bandwidth	1.0% of the emission bandwidth (as close as possible)
Video bandwidth	>3 times the resolution bandwidth
Number of sweeps	sufficient to stability the trace
Detection mode	peak detection with maximum hold

EBW:

The emission bandwidth (x dB) is defined as the frequency range between two points, one above and one below the carrier frequency, at which the spectral density of the emission is attenuated x dB below the maximum in-band spectral density of the modulated signal. Spectral density (power per unit bandwidth) is to be measured with a detector of resolution bandwidth in the range of 1% to 5% of the anticipated emission bandwidth, and a video bandwidth at least 3x the resolution bandwidth.

OBW:

- The transmitter shall be operated at its maximum carrier power measured under normal test conditions.
- The span of the analyzer shall be set to capture all products of the modulation process, including the emission skirts.
- The resolution bandwidth (RBW) shall be in the range of 1% to 5% of the occupied bandwidth (OBW) and video bandwidth (VBW) shall be approximately 3x RBW.



**Test Data**

**Environmental Conditions**

<b>Temperature:</b>	27.4 °C
<b>Relative Humidity:</b>	56 %
<b>ATM Pressure:</b>	101.0 kPa

The testing was performed by Black Ding on 2021-12-16.

Test mode: Transmitting

Channel	Frequency (MHz)	99% Emission Bandwidth (MHz)	26 dB Emission Bandwidth (MHz)	Limit
Low	1921.536	1.207	1.383	50 kHz ~ 2.5 MHz
Middle	1924.992	1.207	1.367	50 kHz ~ 2.5 MHz
High	1928.448	1.207	1.376	50 kHz ~ 2.5 MHz

**Test Result: Pass**

Please refer to the following plots.

**Low Channel**

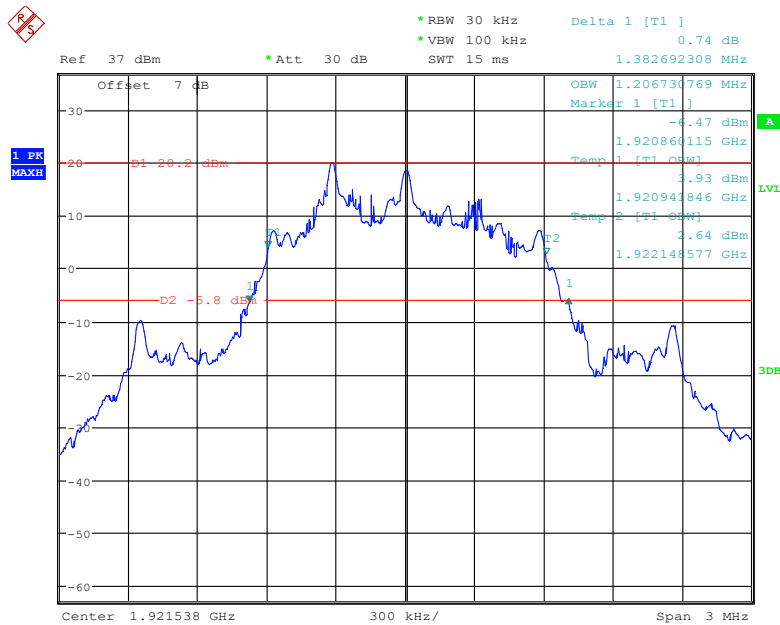

Date: 16.DEC.2021 22:34:11

### Middle Channel

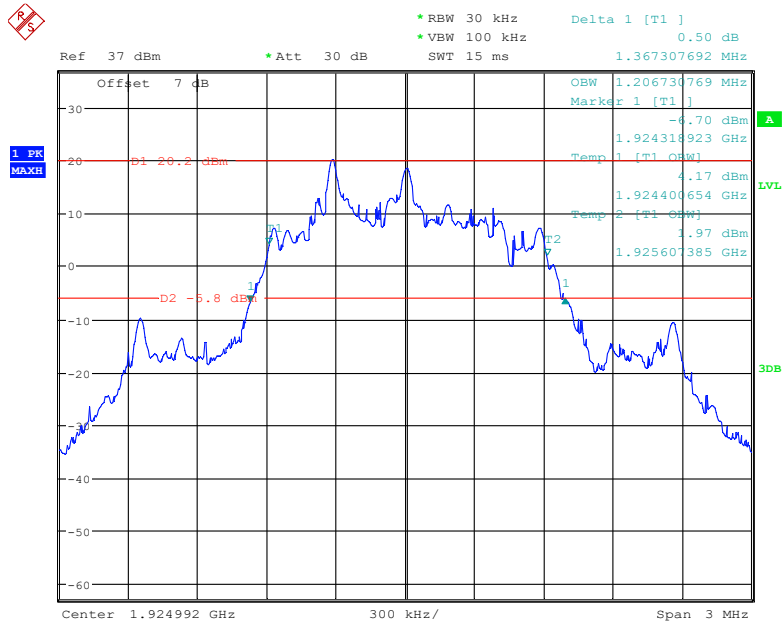

Date: 16.DEC.2021 22:37:13

### High Channel

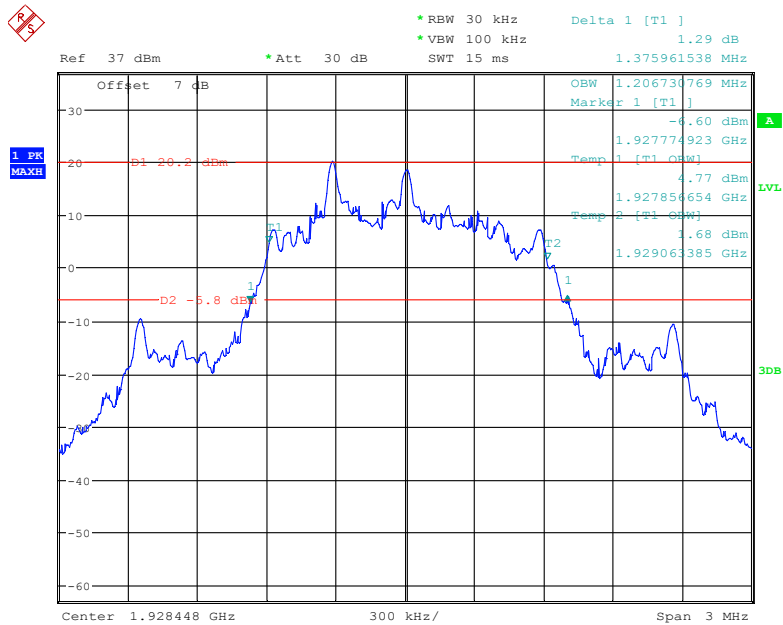

Date: 16.DEC.2021 22:39:25

## § 15.319 (c) & RSS-213 §5.6 PEAK TRANSMIT POWER

### Applicable Standard

The peak power output as measured over an interval of time equal to the frame rate or transmission burst of the device under all conditions of modulation. Usually this parameter is measured as a conducted emission by direct connection of a calibrated test instrument to the equipment under test. If the device cannot be connected directly, alternative techniques acceptable to the Commission may be used [47 CFR 15, subpart D, 15.303].

The peak transmit power is according to ANSI C63.17-2013 §6.1.2

Per FCC Part 15.319 (c) Peak transmit power shall not exceed 100 microwatts multiplied by the square root of the emission bandwidth in hertz. Peak transmit power must be measured over any interval of continuous transmission using instrumentation calibrated in terms of an rms-equivalent voltage. The measurement results shall be properly adjusted for any instrument limitations, such as detector response times, limited resolution bandwidth capability when compared to the emission bandwidth, sensitivity, etc., so as to obtain a true peak measurement for the emission in question over the full bandwidth of the channel.

Per FCC Part 15.319 (e), the peak transmit power shall be reduced by the amount in decibels that the maximum directional gain of the antenna exceeds 3 dBi.

Calculation of Peak Transmit Power Limit:

$$\text{Peak Transmit Power Limit} = 100\mu\text{W} \times (\text{EBW})^{1/2}$$

EBW is the transmit emission bandwidth in Hz determined in the other test item:

Peak transmit power shall not exceed 100  $\mu\text{W}$  multiplied by the square root of the occupied bandwidth in hertz. The peak transmit power shall be reduced by the amount in decibels that the maximum directional gain of the antenna exceeds 3 dBi.

### Test Procedure

Using the manufacturer's information on occupied bandwidth set the spectrum analyzer as follows:

RBW	$\geq$ Emission bandwidth
Video bandwidth	$\geq$ RBW
Span	Zero
Center frequency	Nominal center frequency of channels
Amplitude scale	Log (linear may be used if analyzer has sufficient linear dynamic range and accuracy)
Detection	Peak detection
Trigger	Video
Sweep rate	Sufficiently rapid to permit the transmit pulse to be resolved accurately

**Test Data****Environmental Conditions**

<b>Temperature:</b>	27.4 °C
<b>Relative Humidity:</b>	56 %
<b>ATM Pressure:</b>	101.0 kPa

*The testing was performed by Black Ding on 2021-12-17.*

*Test mode: Transmitting:*

**Test Result: Pass**

*Please refer to the following table and plots.*

**Antenna 0**

Channel	Frequency (MHz)	Peak Transmit Power (dBm)	FCC Limit (dBm)	ISED Limit (dBm)
Low	1921.536	20.35	20.70	20.41
Middle	1924.992	20.33	20.68	20.41
High	1928.448	20.35	20.69	20.41
FCC: EBW <sub>Low channel</sub> = 1383000Hz, EBW <sub>Middle channel</sub> = 1367000 Hz, EBW <sub>High channel</sub> = 1376000 Hz Peak Transmit Power Limit = $100(\text{EBW})^{1/2} \mu\text{W}$				
ISED:EBW <sub>Low channel</sub> = 120700 Hz, EBW <sub>Middle channel</sub> = 1207000 Hz, EBW <sub>High channel</sub> = 1207000Hz Peak Transmit Power Limit = $100(\text{EBW})^{1/2} \mu\text{W}$				

### Low Channel

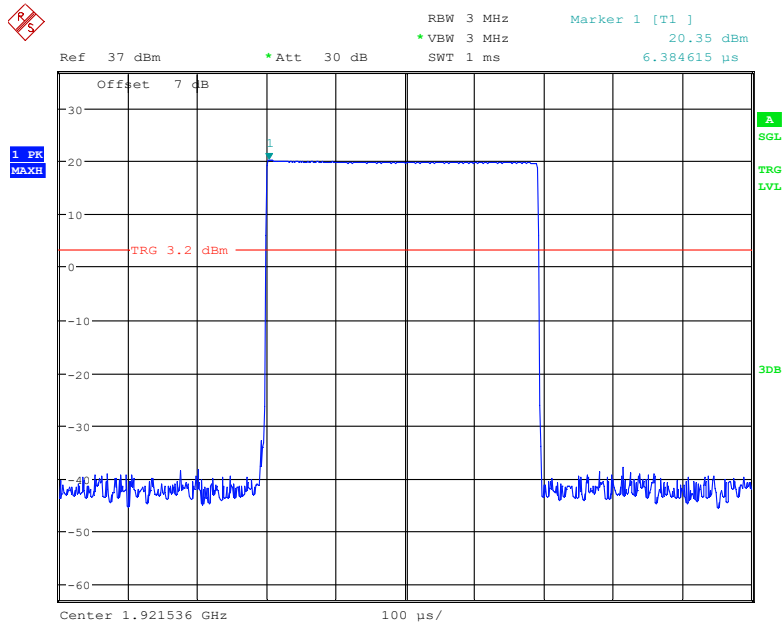

Date: 17.DEC.2021 00:35:10

### Middle Channel

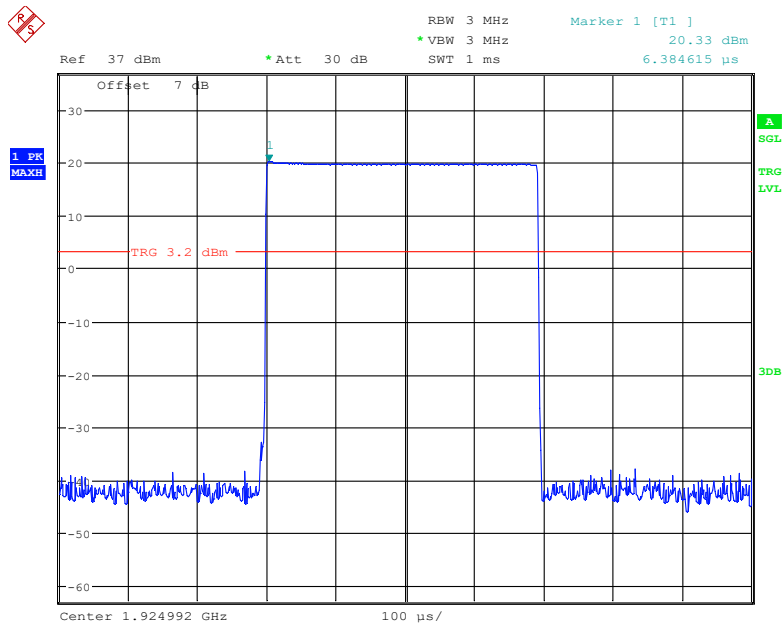

Date: 17.DEC.2021 00:33:31

### High Channel

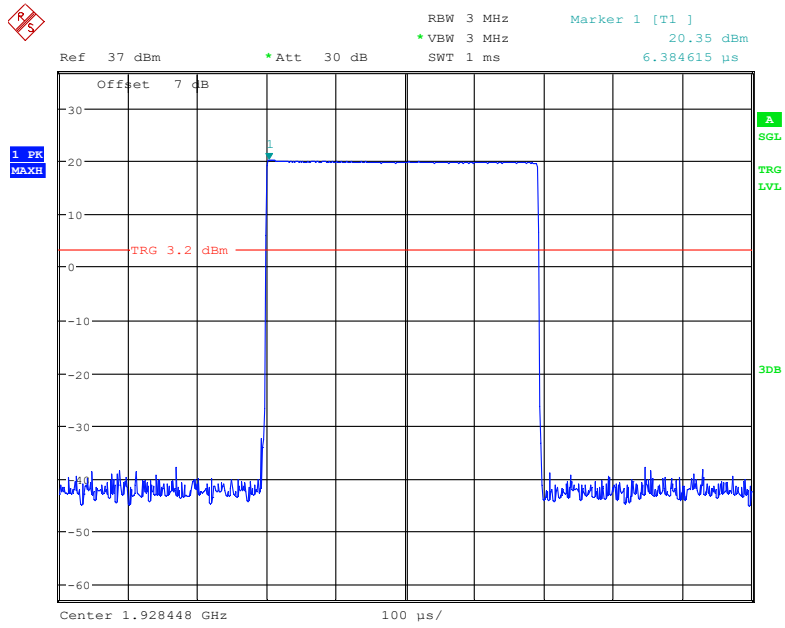

Date: 17.DEC.2021 00:35:54

**Antenna 1**

Channel	Frequency (MHz)	Peak Transmit Power (dBm)	FCC Limit (dBm)	ISED Limit (dBm)
Low	1921.536	20.19	20.70	20.41
Middle	1924.992	20.11	20.68	20.41
High	1928.448	20.05	20.69	20.41
FCC: EBW <sub>Low channel</sub> = 1383000Hz, EBW <sub>Middle channel</sub> = 1367000 Hz, EBW <sub>High channel</sub> = 1376000 Hz Peak Transmit Power Limit = $100(\text{EBW})^{1/2} \mu\text{W}$				
ISED: EBW <sub>Low channel</sub> = 120700 Hz, EBW <sub>Middle channel</sub> = 1207000 Hz, EBW <sub>High channel</sub> = 1207000Hz Peak Transmit Power Limit = $100(\text{EBW})^{1/2} \mu\text{W}$				

**Low Channel**

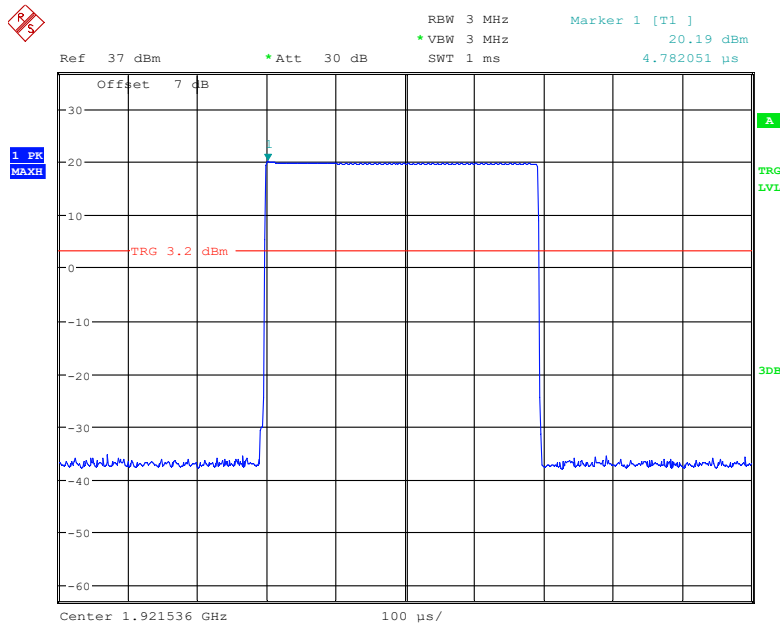

Date: 17.DEC.2021 00:18:14

### Middle Channel

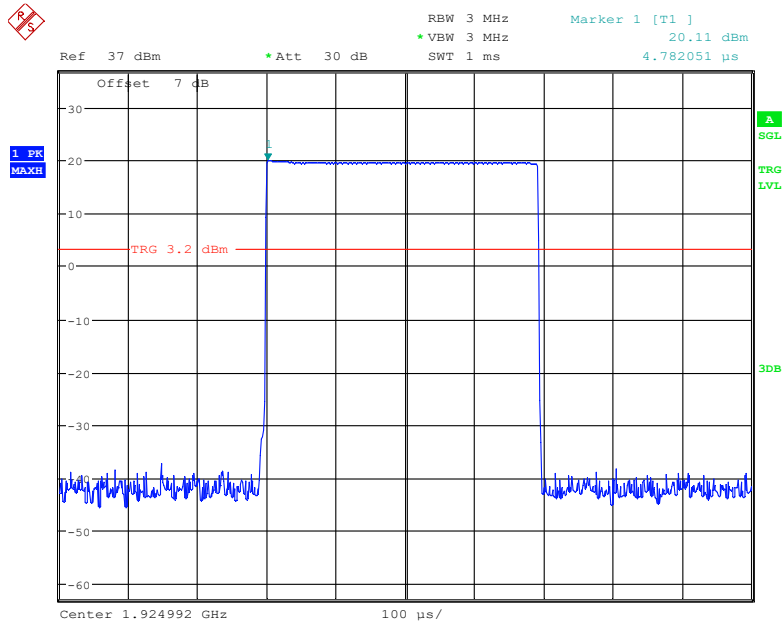

Date: 17.DEC.2021 00:17:39

### High Channel

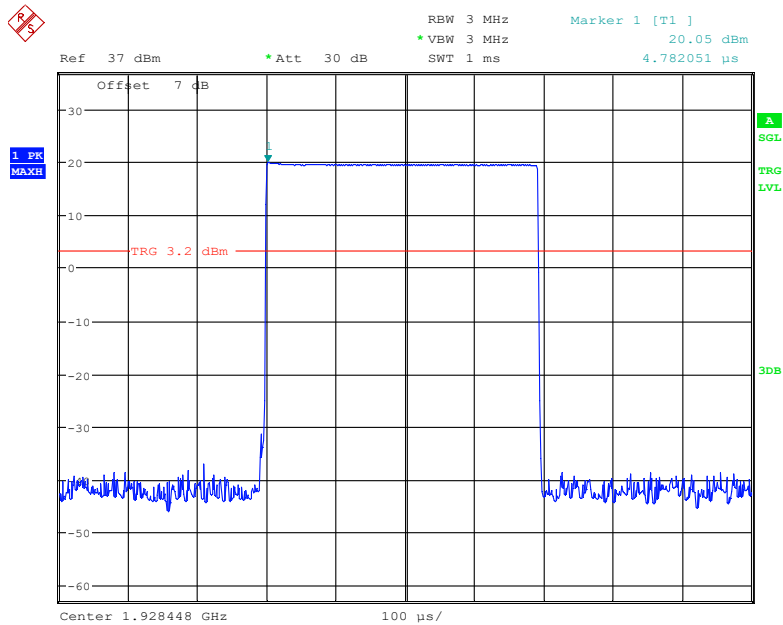

Date: 17.DEC.2021 00:16:09



## § 15.319 (d) & RSS-213 §5.7 POWER SPECTRAL DENSITY

### Applicable Standard

The average pulse energy in a 3 kHz bandwidth is divided by the pulse duration.

The power spectral density shall not exceed 3mW in any 3 kHz bandwidth as measured with a spectrum analyzer having a resolution bandwidth of 3 kHz.

The power spectral density is measured in accordance with ANSI C63.17-2013 Clause 6.1.5.

The peak-hold power spectral density of transmitters shall not exceed 12 mW per any 3 kHz bandwidth. As an alternative to the peak-hold power spectral density, the time-averaged power spectral density may be measured and it shall not exceed 3 mW per any 3 kHz bandwidth.

### Test Procedure

Using the manufacturer's information on occupied bandwidth set the spectrum analyzer as follows:

RBW	3 kHz
Video bandwidth	$\geq 3 \times \text{RBW}$
Span	Zero span at frequency with the maximum level (frequency determined in 6.1.3 if the same type of signal (continuous versus burst) was used in 6.1.3)
Center frequency	Spectral peak as determined in 6.1.3
Sweep time	For burst signals, sufficient to include essentially all of the maximum length burst at the output of a 3 kHz filter (e.g., maximum input burst duration plus 600 $\mu\text{s}$ ). For continuous signals, 20 ms.
Amplitude scale	Log power
Detection	Sample detection and averaged for a minimum of 100 sweeps
Trigger	External or internal

### Test Data

#### Environmental Conditions

<b>Temperature:</b>	27.4 °C
<b>Relative Humidity:</b>	56 %
<b>ATM Pressure:</b>	101.0 kPa

*The testing was performed by Black Ding on 2021-12-17.*

**Test Result: Pass**

*Please refer to following table and plots*

*Test mode: Transmitting*

Channel	Frequency (MHz)	Power Spectral Density		Limit (mW/3kHz)
		(dBm/3kHz)	(mW/3kHz)	
Low	1921.536	1.21	1.32	3
Middle	1924.992	1.04	1.27	3
High	1928.448	1.31	1.35	3

### Low Channel

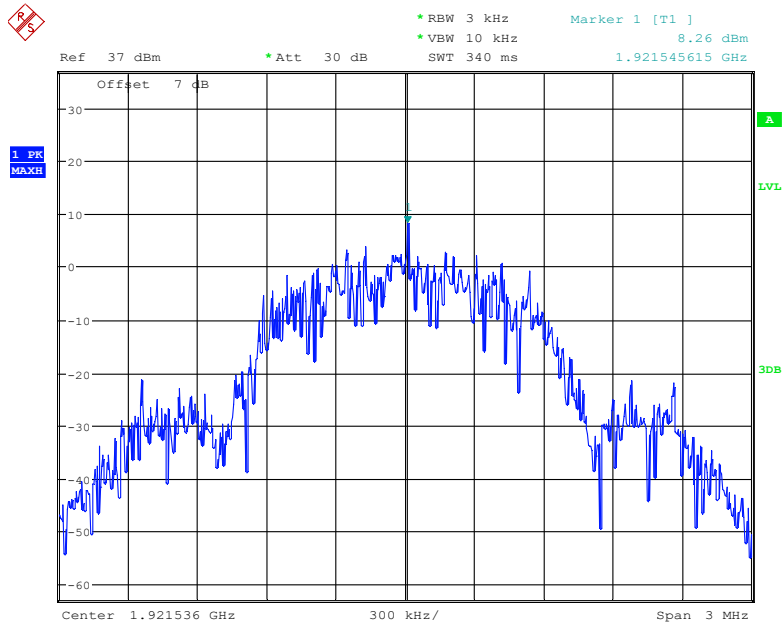

Date: 17.DEC.2021 00:09:36

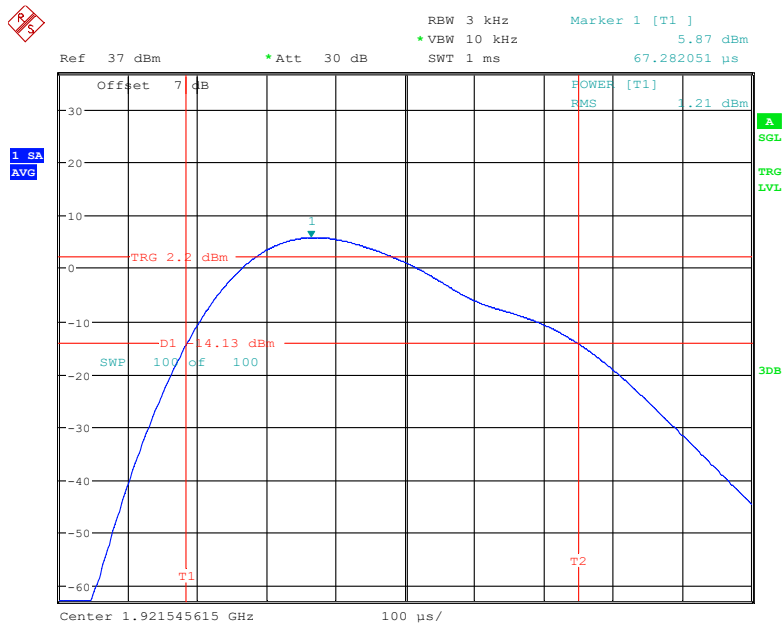

Date: 17.DEC.2021 00:13:02

Middle Channel

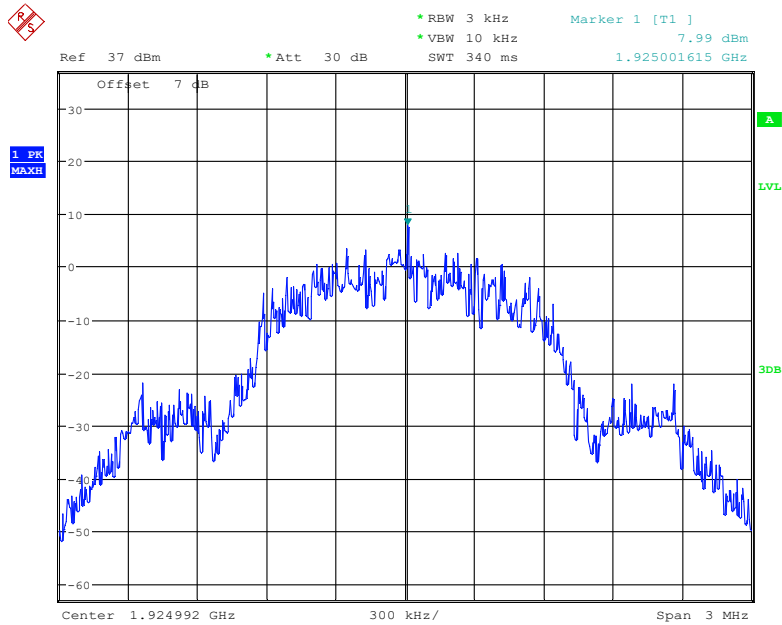

Date: 17.DEC.2021 00:06:28

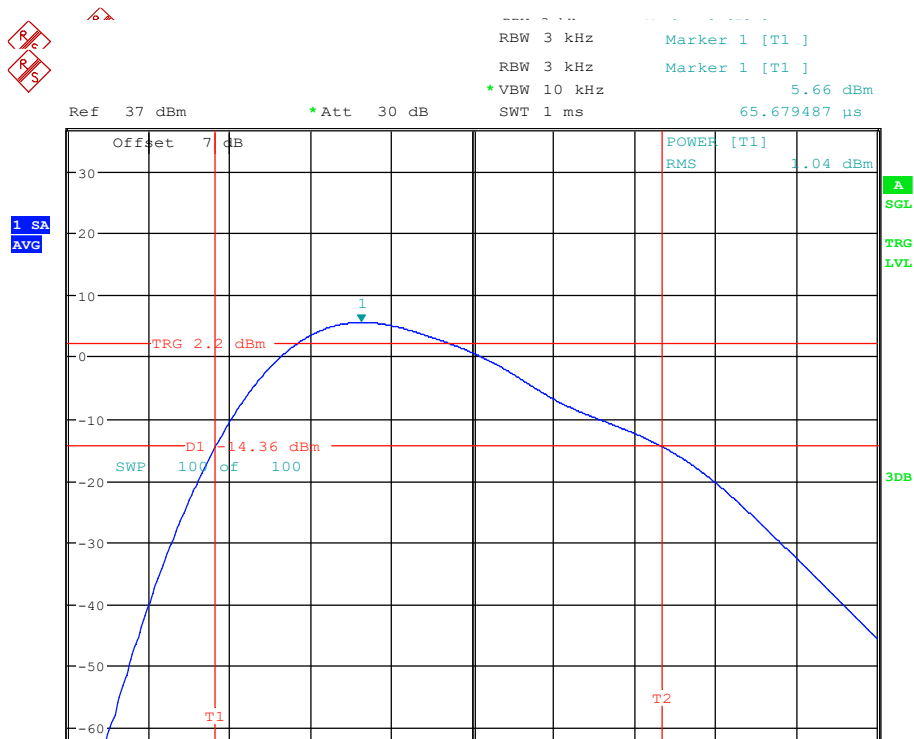

### High Channel

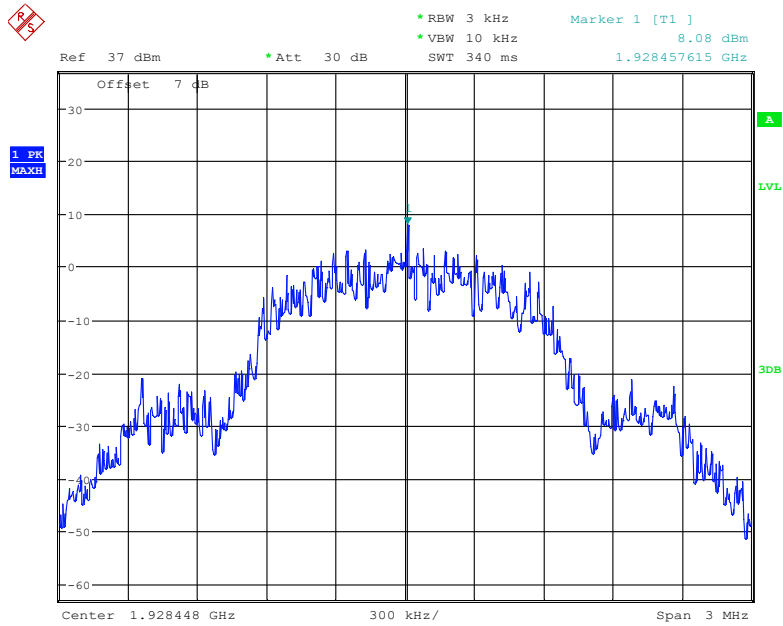

Date: 17.DEC.2021 00:01:24

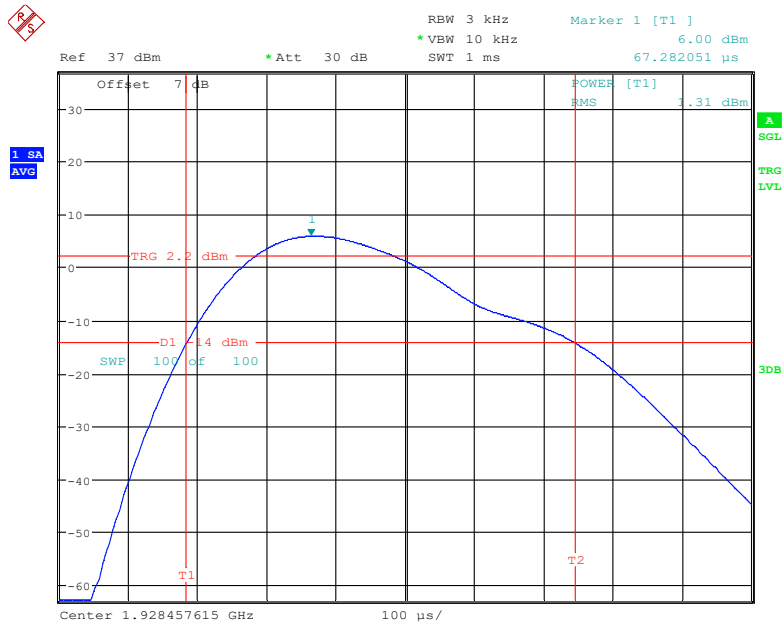

Date: 17.DEC.2021 00:04:50

---

## **§ 15.323 (d) & RSS-213 §5.8 EMISSION INSIDE AND OUTSIDE THE SUB-BAND**

---

### **Applicable Standard**

Emissions inside the sub-band must comply with the following emission mask:

1. In the bands between 1B and 2B measured from the center of the emission bandwidth the total power emitted by the device shall be at least 30 dB below the transmit power permitted for that device;
2. in the bands between 2B and 3B measured from the center of the emission bandwidth the total power emitted by an intentional radiator shall be at least 50 dB below the transmit power permitted for that radiator;
3. in the bands between 3B and the sub-band edge the total power emitted by an intentional radiator in the measurement bandwidth shall be at least 60 dB below the transmit power permitted for that radiator.

Where B = emission bandwidth

Emission Outside the sub-band shall be attenuated below a reference power of 112 mw (20.5 dBm) as follows:

1. 30 dB between the sub-band and 1.25 MHz above or below the sub-band;
2. 50 dB between 1.25 and 2.5 MHz above or below the sub-band;
3. 60 dB at 2.5 MHz or greater above or below the sub-band.

### **Emissions outside the 1920-1930 MHz Band**

Emissions outside the 1920-1930 MHz band shall be attenuated below a reference power of 112 milliwatts (-9.5 dBW) by at least:

- 30 dB between the band edges and 1.25 MHz above and below the band edges;
- 50 dB between 1.25 MHz and 2.5 MHz above or below the band edges; and
- 60 dB at 2.5 MHz or greater above or below the band edges.

### **Emissions inside the 1920-1930 MHz Band**

Emissions inside the 1920-1930 MHz band shall be attenuated below the transmit power permitted for that device, as follows:

- 30 dB between the frequencies 1B and 2B measured from the centre of the occupied bandwidth;
- 50 dB between the frequencies 2B and 3B measured from the centre of the occupied bandwidth; and
- 60 dB between the frequencies 3B and band edge, where B is the occupied bandwidth in hertz.

## Test Procedure

According to ANSI C63.17.2013 Clause 6.1.6.

### In-band emission:

#### Spectrum analyzer settings for measuring in-band emission

RBW	Approximately 1% of the emission bandwidth ( $B$ )
Video bandwidth	$3 \times \text{RBW}$
Sweep time	The sweep time shall be sufficiently slow that the swept frequency rate shall not exceed one RBW per three transmit bursts.
Number of sweeps	Sufficient to stabilize the trace
Amplitude scale	Log
Detection	Peak detection and max hold enabled
Span	Approximately equal to $3.5 B$

### Out-band emission:

RBW	30kHz
Video bandwidth	100kHz
Center frequency	Nominal center frequency of channels
Amplitude scale	Log (linear may be used if analyzer has sufficient linear dynamic range and accuracy)
Detection	Peak detection

## Test Data

### Environmental Conditions

Temperature:	19~27.4°C
Relative Humidity:	56 ~58%
ATM Pressure:	101.0 kPa

*The testing was performed by Chao Mo on 2022-02-10 for below 1GHz, Chao Mo on 2022-02-12 for above 1GHz and Black Ding on 2021-12-16 for RF conducted.*

*Test mode: Transmitting*

### Test Result: Pass

*Please refer to following plots*

FCC:

Low Channel (Unwanted Emission inside the Sub-band)

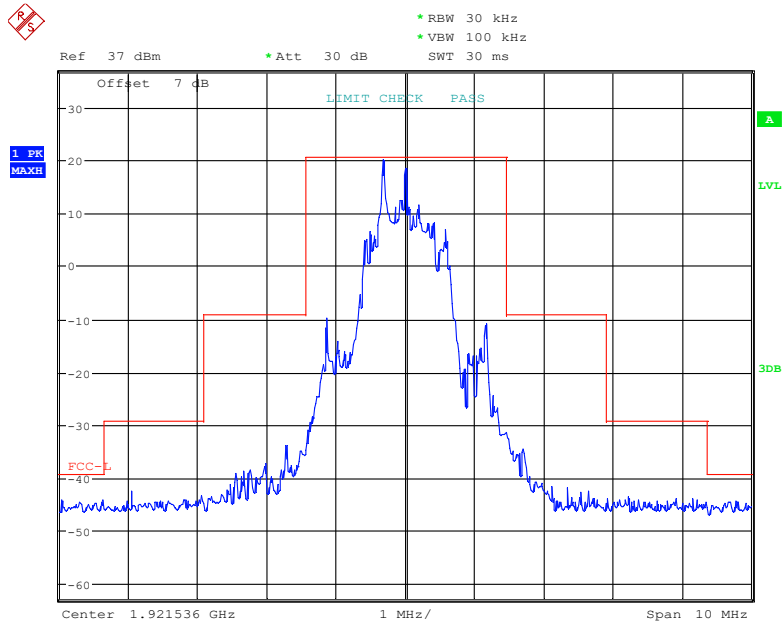

Date: 16.DEC.2021 23:15:25

Middle Channel (Unwanted Emission inside the Sub-band)

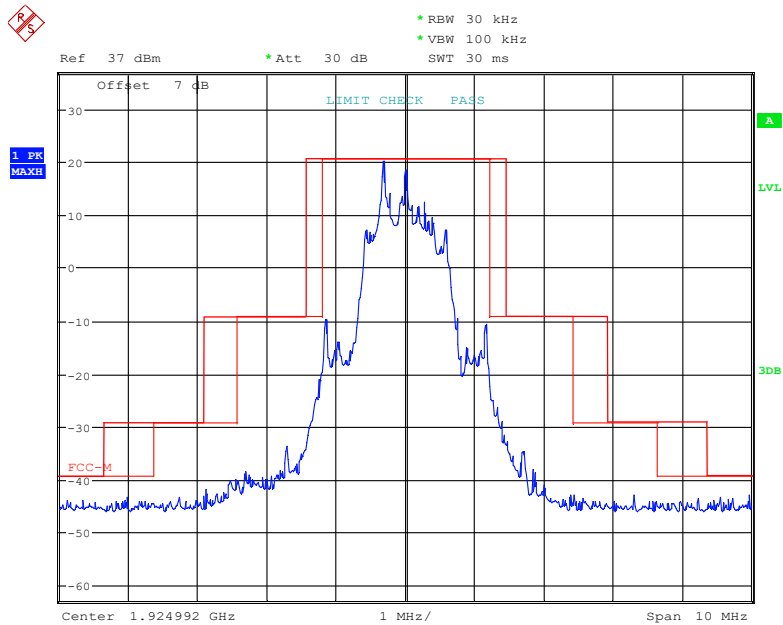

Date: 16.DEC.2021 23:07:44



### High Channel (Unwanted Emission inside the Sub-band)

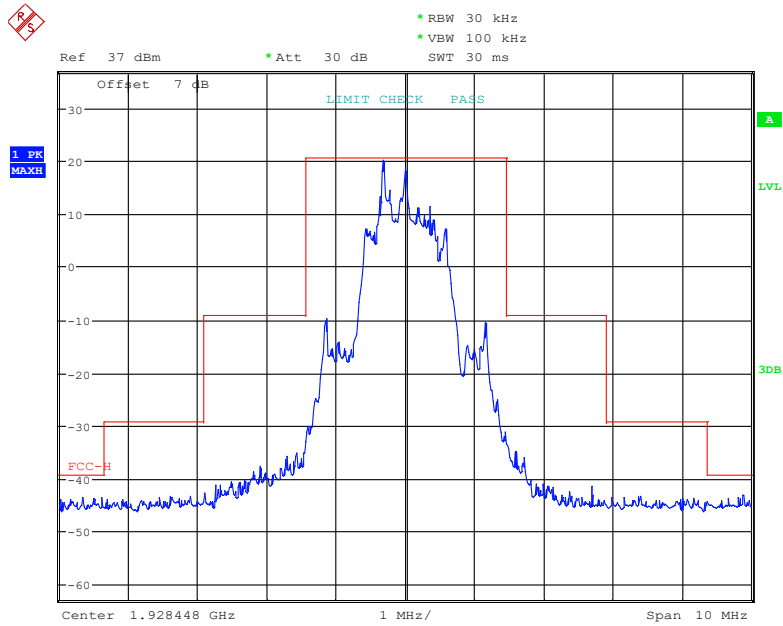

Date: 16.DEC.2021 23:21:37

### ISED:

### Low Channel (Unwanted Emission inside the Sub-band)

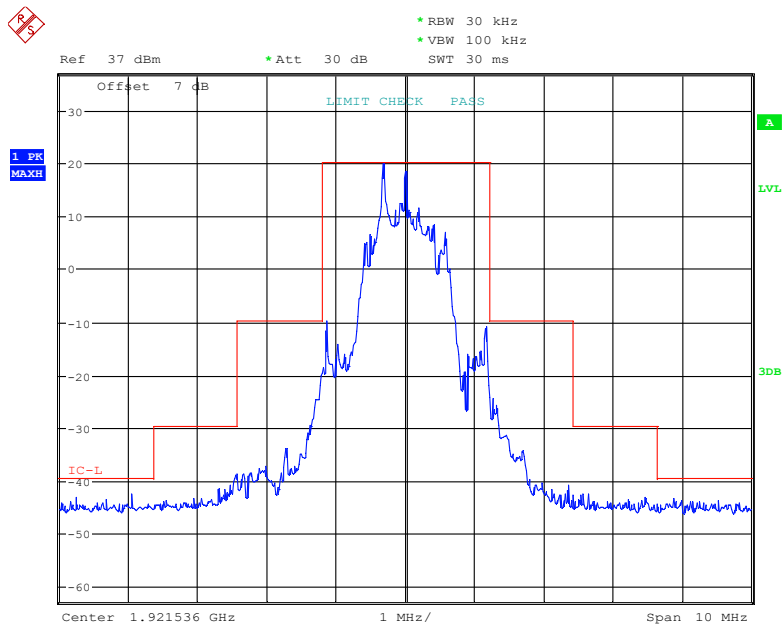

Date: 16.DEC.2021 23:15:48

### Middle Channel (Unwanted Emission inside the Sub-band)

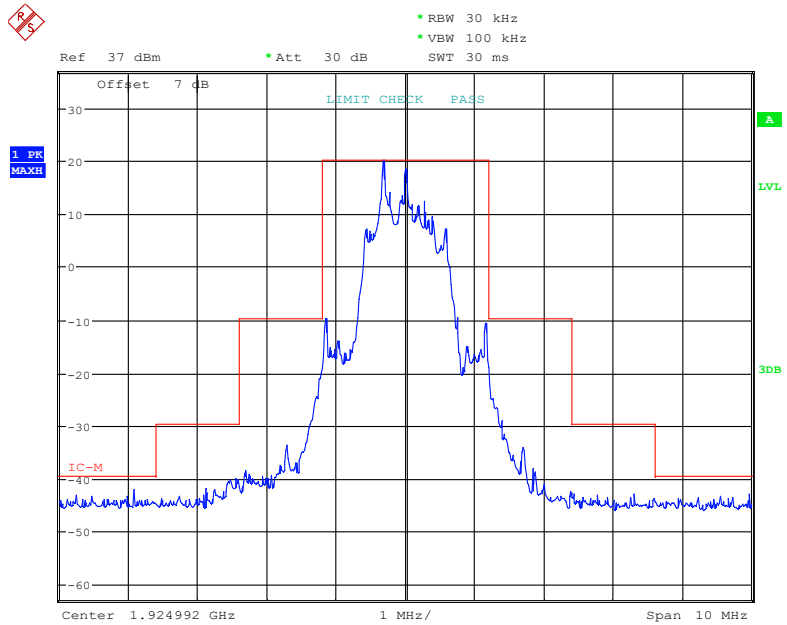

Date: 16.DEC.2021 23:08:10

### High Channel (Unwanted Emission inside the Sub-band)

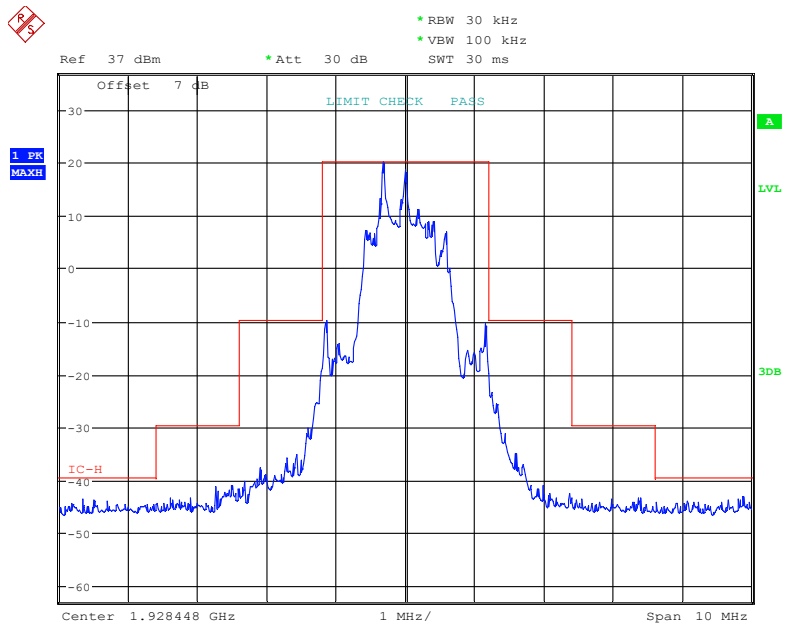

Date: 16.DEC.2021 23:21:14

### Low Channel (Unwanted Emission outside the Sub-band)

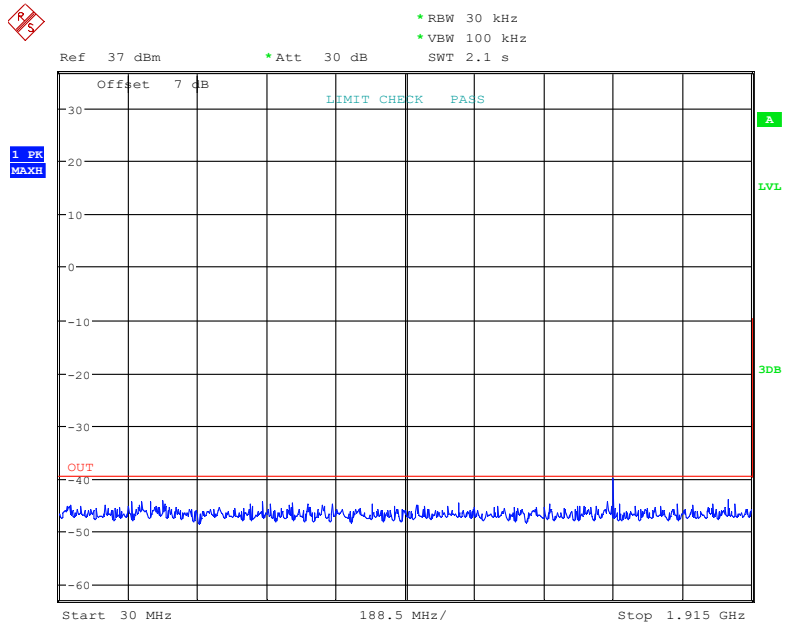

Date: 16.DEC.2021 23:17:00

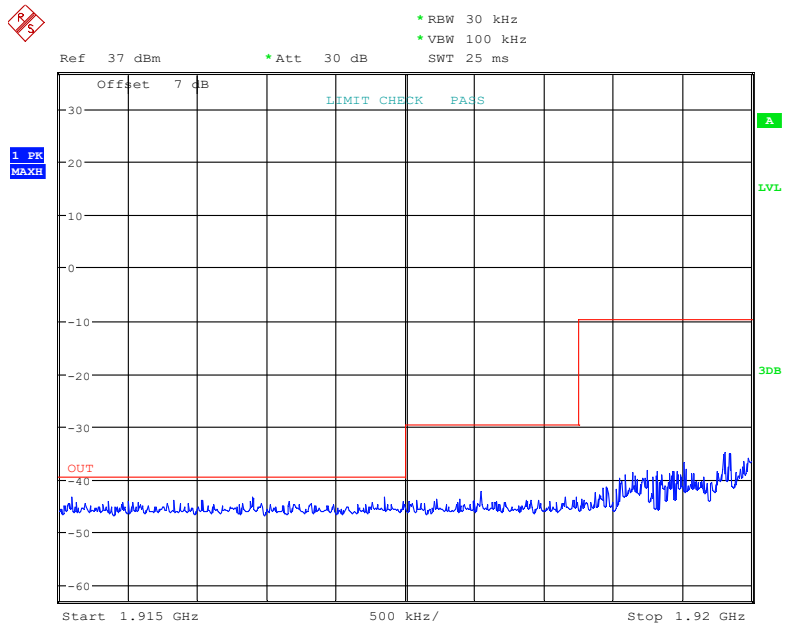

Date: 16.DEC.2021 23:18:12

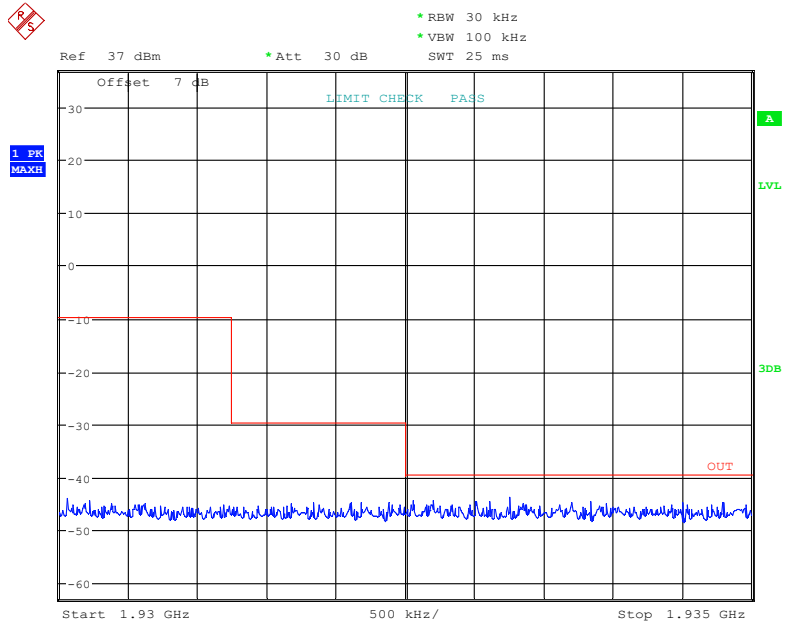

Date: 16.DEC.2021 23:18:45

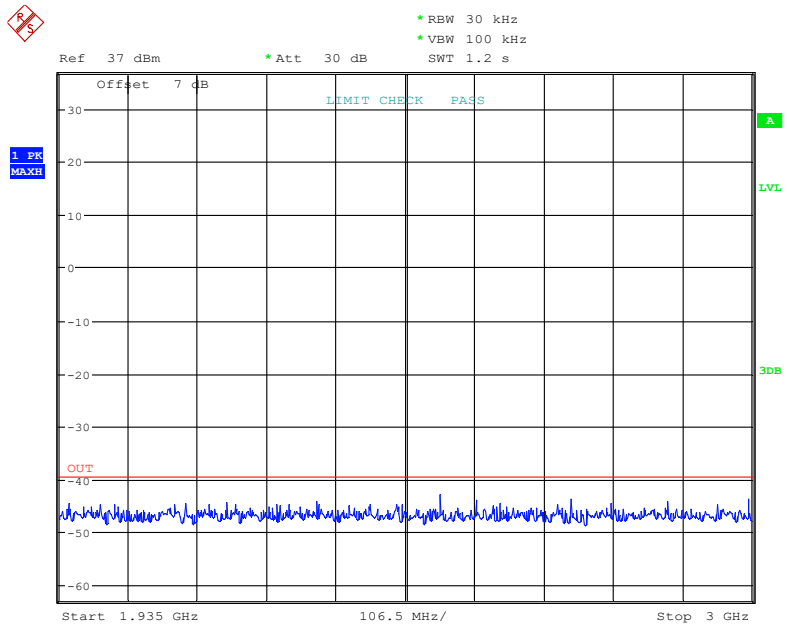

Date: 16.DEC.2021 23:19:11

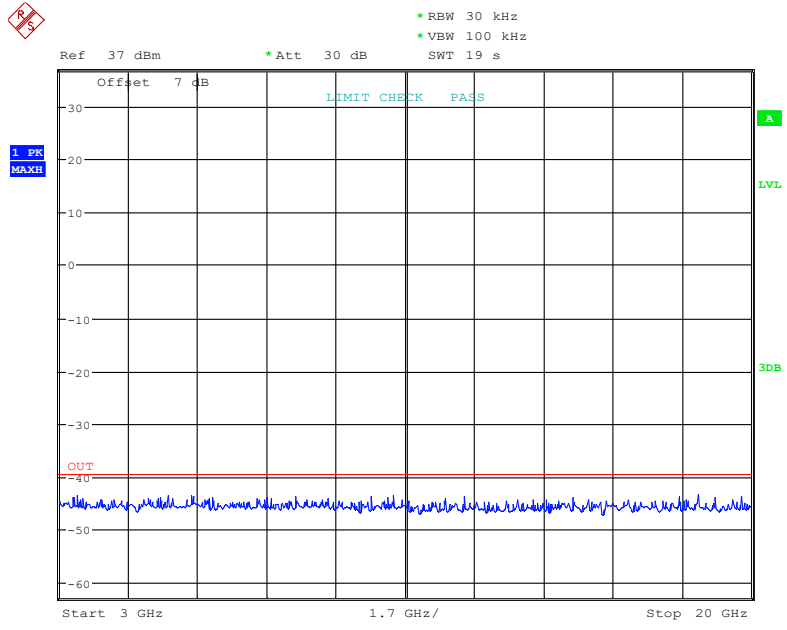

Date: 16.DEC.2021 23:20:04

### Middle Channel (Unwanted Emission outside the Sub-band)

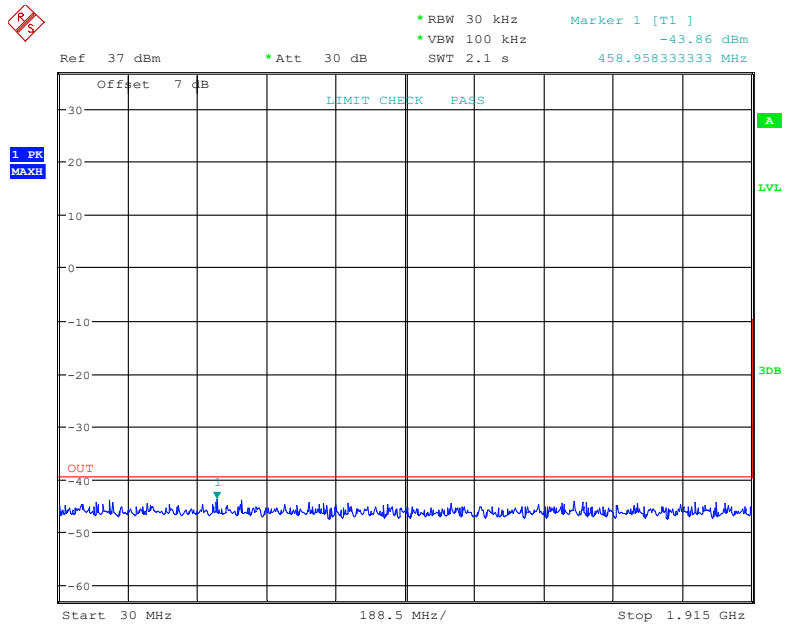

Date: 16.DEC.2021 23:10:20

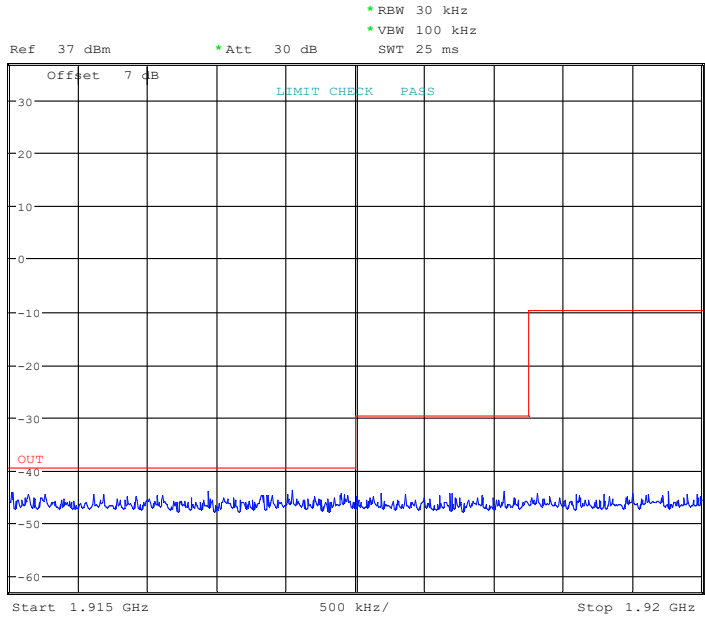

Date: 16.DEC.2021 23:11:53

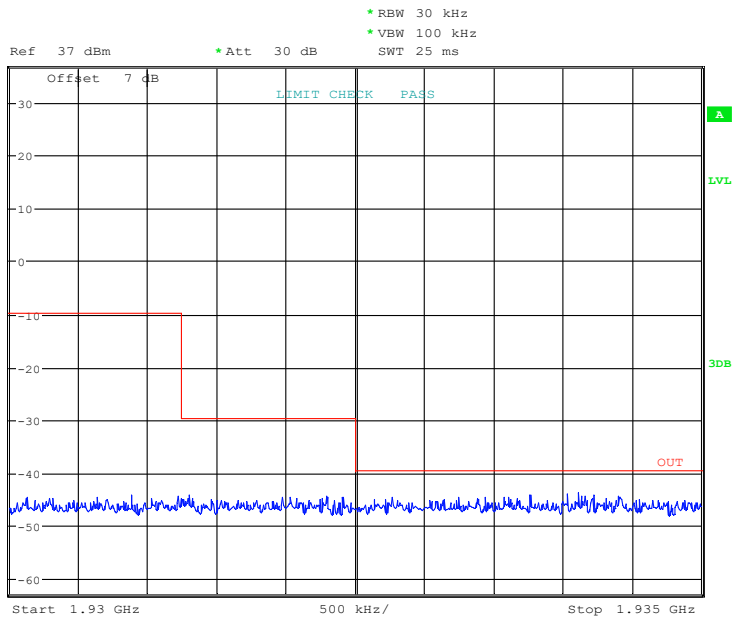

Date: 16.DEC.2021 23:12:17

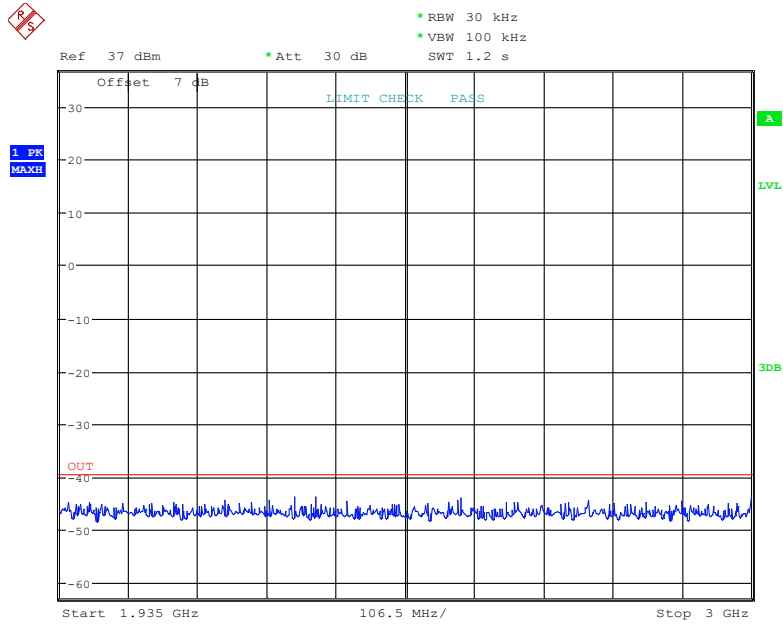

Date: 16.DEC.2021 23:12:44

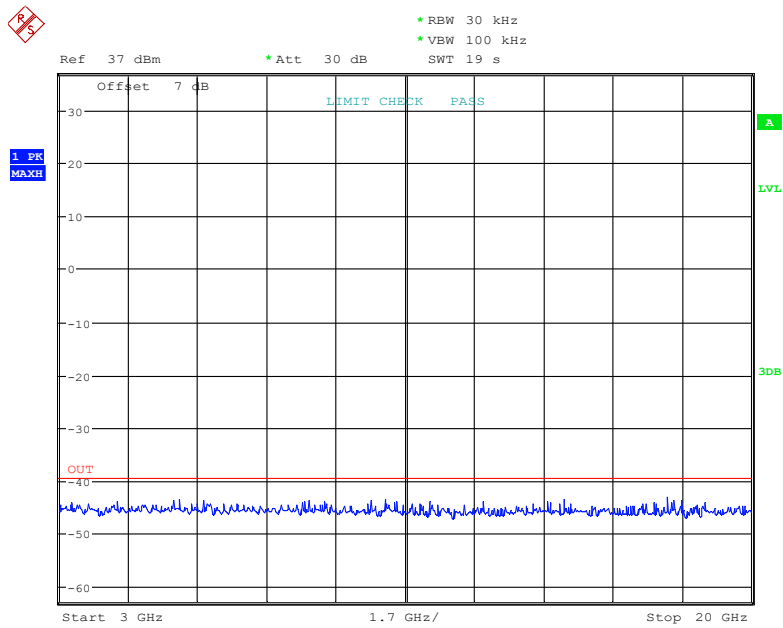

Date: 16.DEC.2021 23:13:37

### High Channel (Unwanted Emission outside the Sub-band)

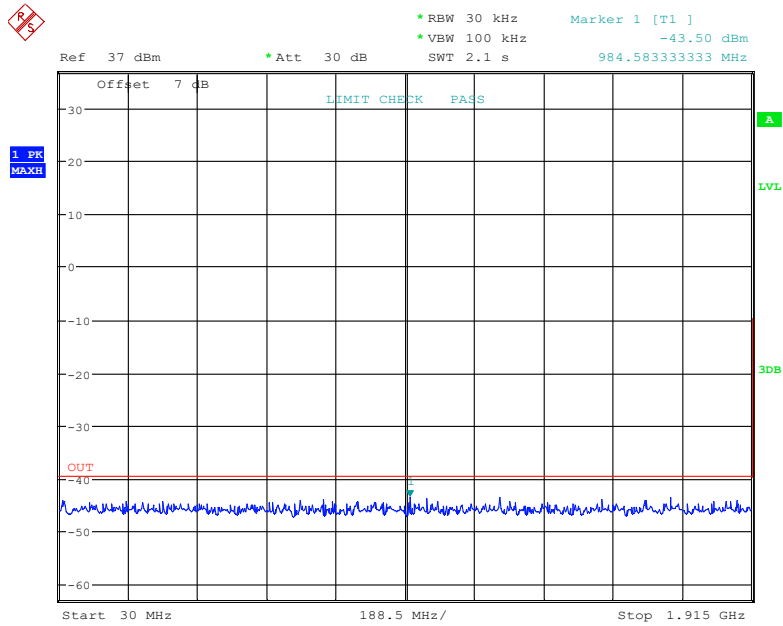

Date: 16.DEC.2021 22:57:50

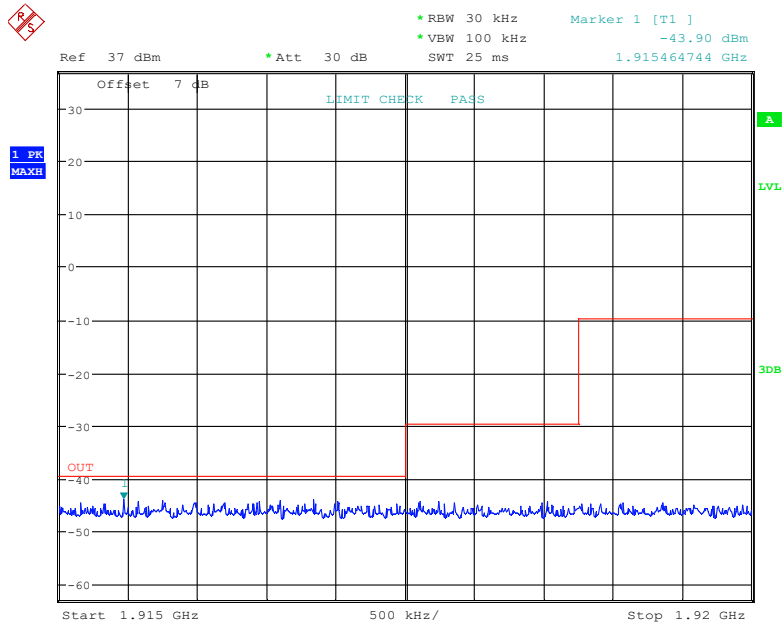

Date: 16.DEC.2021 22:58:29



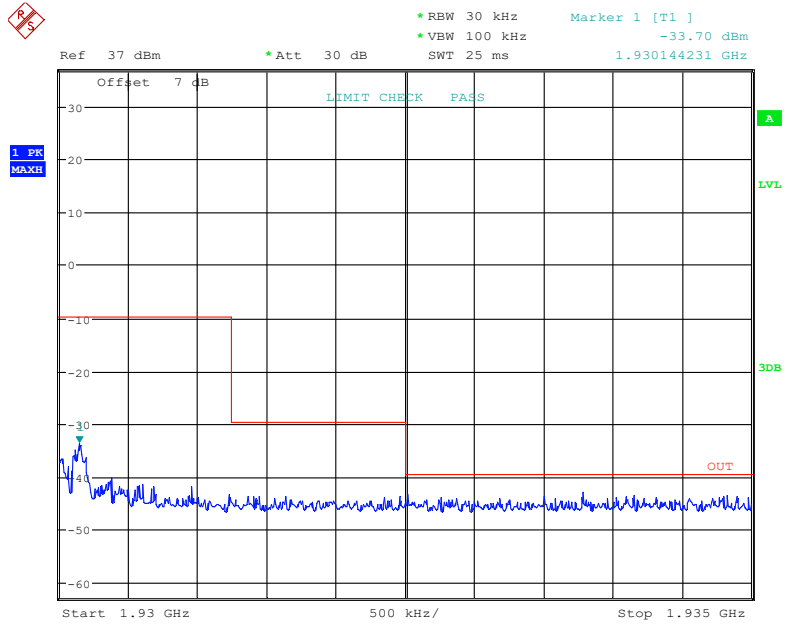

Date: 16.DEC.2021 22:59:22

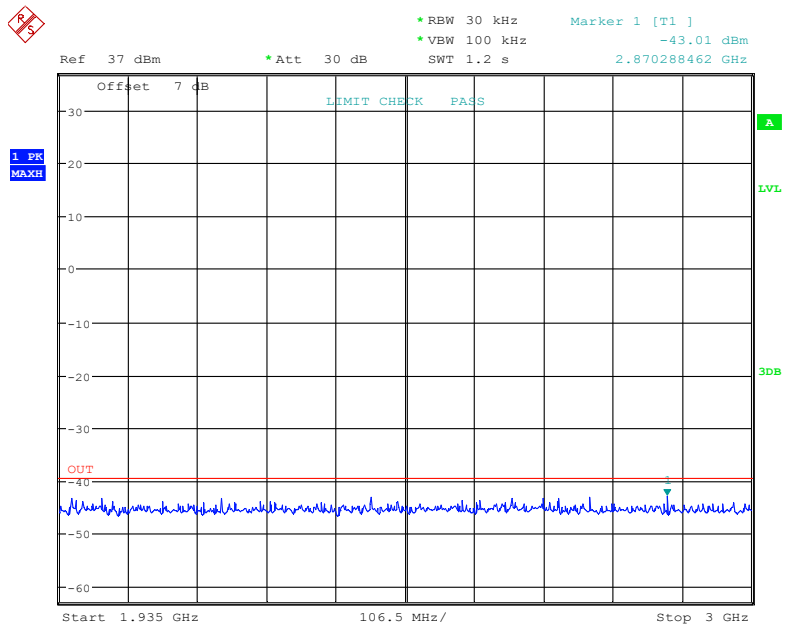

Date: 16.DEC.2021 23:00:37

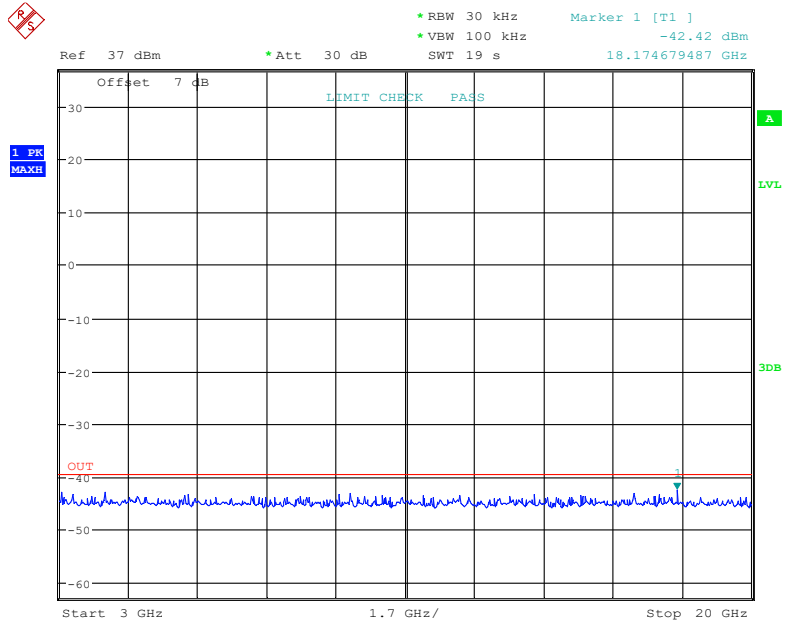

Date: 16.DEC.2021 23:05:40

**30MHz-1GHz: (Low channel was worst case)**

Note: When the test result of peak was less than the limit of QP more than 6dB, just peak value were recorded.

Powered by adapter:

Horizontal

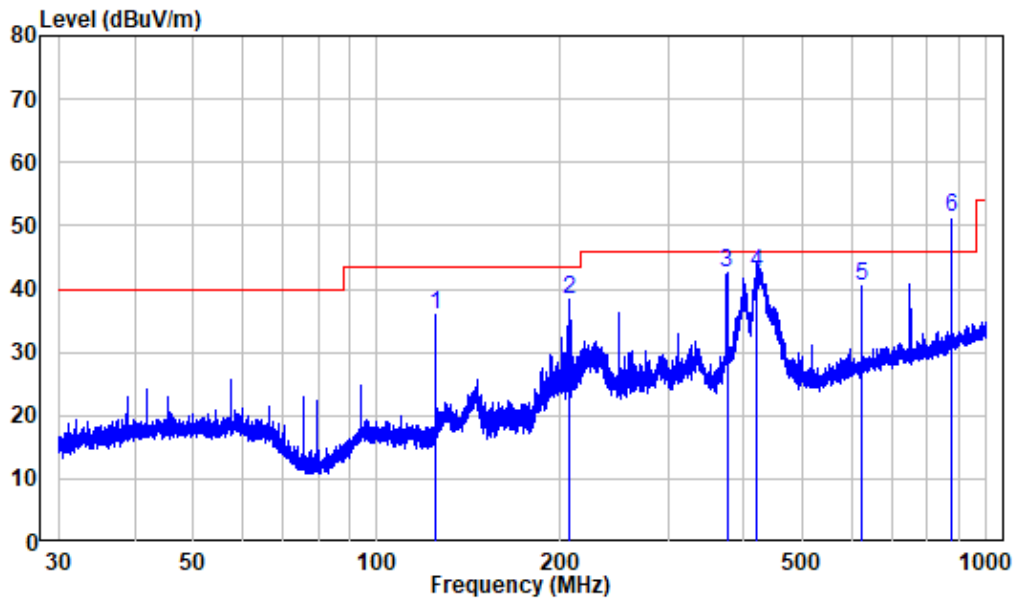

Site : chamber  
 Condition: 3m HORIZONTAL  
 Job No. : SZNS211213-64525E-RF  
 Test Mode: FP

	Freq	Factor	Read Level	Level	Limit Line	Over Limit	Remark
	MHz	dB/m	dBuV	dBuV/m	dBuV/m	dB	
1	125.007	-14.31	50.35	36.04	43.50	-7.46	Peak
2	207.395	-11.85	50.22	38.37	43.50	-5.13	QP
3	375.116	-7.28	49.96	42.68	46.00	-3.32	QP
4	419.476	-6.14	48.69	42.55	46.00	-3.45	QP
5	625.078	-2.35	42.86	40.51	46.00	-5.49	QP
6	875.247	1.18	50.10	51.28	46.00	5.28	QP *

Vertical

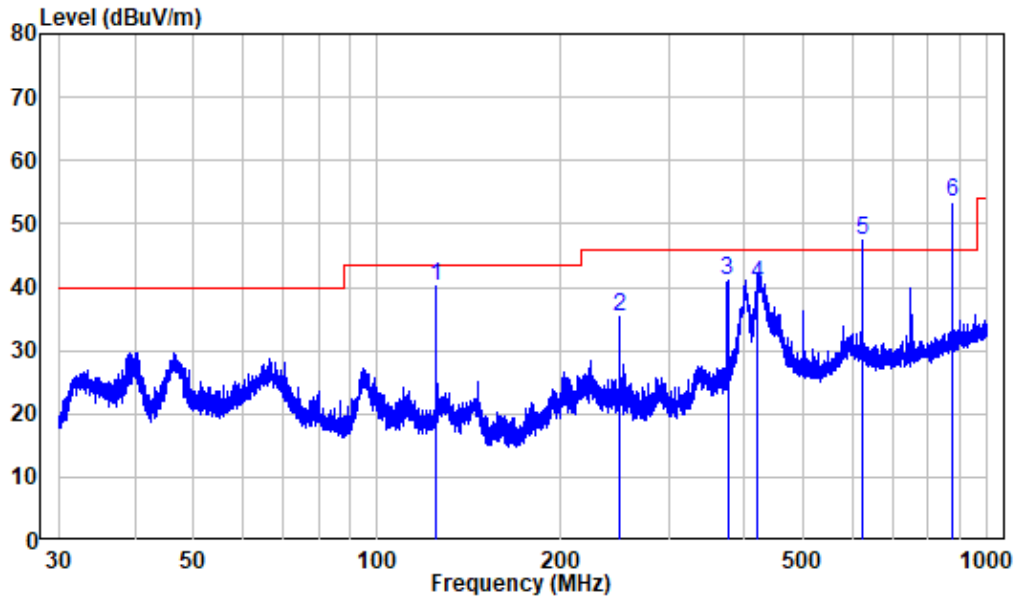

Site : chamber  
 Condition: 3m VERTICAL  
 Job No. : SZNS211213-64525E-RF  
 Test Mode: FP

	Freq	Factor	Read Level	Level	Limit	Over	Remark
	MHz	dB/m	dBuV	dBuV/m	dBuV/m	dB	
1	125.007	-14.31	54.57	40.26	43.50	-3.24	QP
2	250.082	-10.75	46.20	35.45	46.00	-10.55	Peak
3	375.116	-7.28	48.46	41.18	46.00	-4.82	QP
4	420.765	-6.09	46.59	40.50	46.00	-5.50	QP
5	625.078	-2.35	49.83	47.48	46.00	1.48	QP *
6	875.247	1.18	52.40	53.58	46.00	7.58	QP *

Powered by POE:

Horizontal

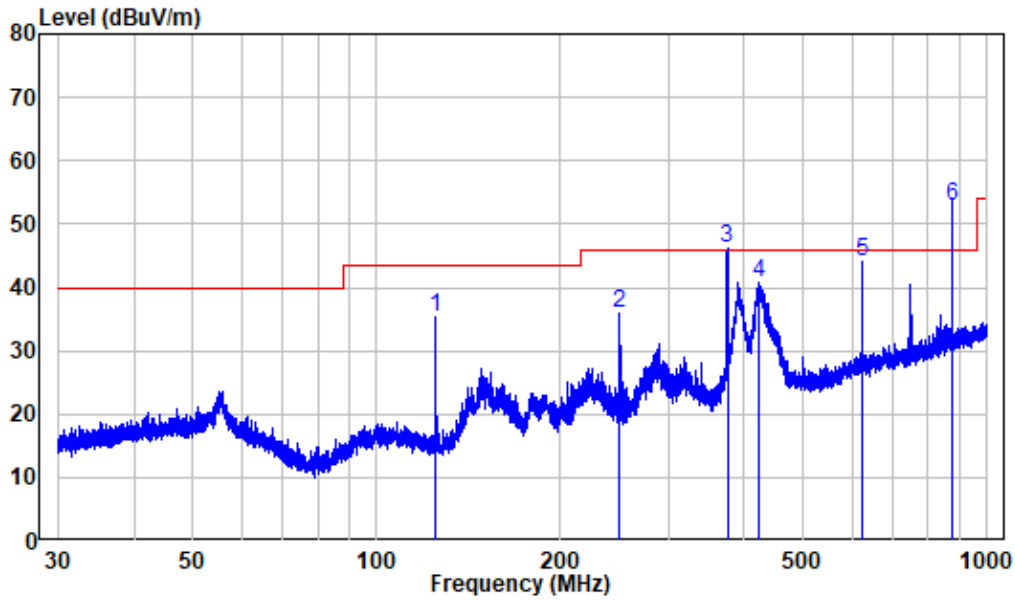

Site : chamber  
 Condition: 3m HORIZONTAL  
 Job No. : SZNS211213-64525E-RF  
 Test Mode: Transmitting  
 Note : FP

	Freq	Factor	Read Level	Level	Limit	Over	Remark
	MHz	dB/m	dBuV	dBuV/m	dBuV/m	dB	
1	125.007	-14.31	49.60	35.29	43.50	-8.21	Peak
2	250.082	-10.75	46.67	35.92	46.00	-10.08	Peak
3	375.116	-7.28	53.48	46.20	46.00	0.20	QP *
4	423.169	-5.96	46.74	40.78	46.00	-5.22	QP
5	625.078	-2.35	46.46	44.11	46.00	-1.89	QP
6	875.247	1.18	51.80	52.98	46.00	6.98	QP *

Vertical

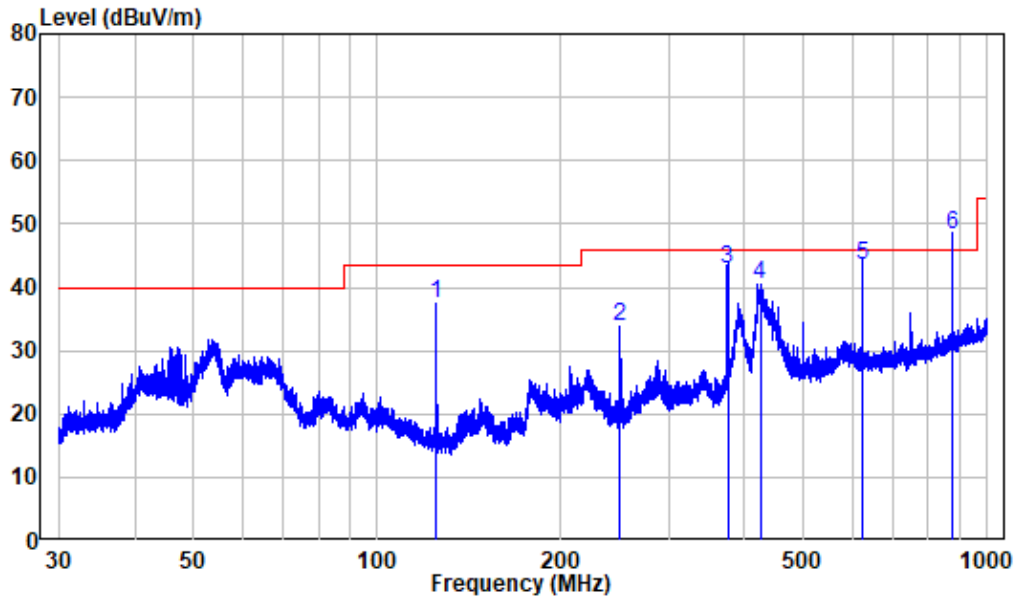

Site : chamber  
 Condition: 3m VERTICAL  
 Job No. : SZNS211213-64525E-RF  
 Test Mode: Transmitting  
 Note : FP

	Freq	Factor	Read Level	Level	Limit Line	Over Limit	Remark
	MHz	dB/m	dBuV	dBuV/m	dBuV/m	dB	
1	125.007	-14.31	51.79	37.48	43.50	-6.02	Peak
2	249.972	-10.74	44.45	33.71	46.00	-12.29	Peak
3	375.116	-7.28	50.27	42.99	46.00	-3.01	QP
4	424.098	-5.91	46.47	40.56	46.00	-5.44	QP
5	625.078	-2.35	45.76	43.41	46.00	-2.59	QP
6	875.247	1.18	47.20	48.38	46.00	2.38	QP *

Note \*: The data recorded above represents the worst case for all supported operating modes, there were no spurious emission in the range 30MHz -1GHz over the limit in §15.209/RSS-Gen caused by radio, the emission list at above table was investigated and was not caused by the radio, the emission was present when the radio was disabled, so those emission not judged under the radio regulation.

**Above 1GHz:**

Frequency (MHz)	Receiver		Turntable Degree	Rx Antenna		Substituted Factor (dB/m)	Absolute Level (dBμV/m)	Limit (dBμV/m)	Margin (dB)
	Reading (dBμV)	PK/Ave		Height (m)	Polar (H/V)				
Low Channel									
1921.54	120.24	PK	279	1.3	H	-7.85	112.39	/	/
1921.54	111.31	PK	302	1.4	V	-7.85	103.46	/	/
3843.07	60.87	PK	243	1.4	H	-5.60	55.27	74	-18.73
3843.07	57.06	PK	40	2.1	V	-5.60	51.46	74	-22.54
Middle Channel									
1924.99	119.84	PK	61	2.3	H	-7.82	112.02	/	/
1924.99	111.38	PK	85	1.7	V	-7.82	103.56	/	/
3849.98	62.46	PK	270	1.3	H	-5.58	56.88	74	-17.12
3849.98	57.76	PK	138	1.8	V	-5.58	52.18	74	-21.82
High Channel									
1928.45	119.81	PK	196	1.3	H	-7.79	112.02	/	/
1928.45	111.59	PK	296	1.1	V	-7.79	103.8	/	/
3856.90	61.08	PK	336	1.3	H	-5.58	55.5	74	-18.5
3856.90	57.06	PK	103	1	V	-5.58	51.48	74	-22.52

Field Strength of Average							
Frequency (MHz)	Peak Measurement @3m (dBμV/m)	Polar (H/V)	Duty Cycle Correction Factor (dB)	Corrected Amplitude (dBμV/m)	Part 15D		
					Limit (dBμV/m)	Margin (dB)	Comment
1921.536MHz							
1921.536	112.39	H	-26.34	86.05	\	\	Fundamental
1921.536	103.46	V	-26.34	77.12	\	\	Fundamental
3843.07	55.27	H	-26.34	28.93	54	-25.07	Harmonic
3843.07	51.46	V	-26.34	25.12	54	-28.88	Harmonic
1924.992MHz							
1924.992	112.02	H	-26.34	85.68	\	\	Fundamental
1924.992	103.56	V	-26.34	77.22	\	\	Fundamental
3849.98	56.88	H	-26.34	30.54	54	-23.46	Harmonic
3849.98	52.18	V	-26.34	25.84	54	-28.16	Harmonic
1928.448MHz							
1928.448	112.02	H	-26.34	85.68	\	\	Fundamental
1928.448	103.8	V	-26.34	77.46	\	\	Fundamental
3856.90	55.5	H	-26.34	29.16	54	-24.84	Harmonic
3856.90	51.48	V	-26.34	25.14	54	-28.86	Harmonic

**Note:**

Corrected Factor = Antenna factor (RX) + Cable Loss – Amplifier Factor

Corrected Amplitude = Corrected Factor + Reading

Margin = Corrected. Amplitude - Limit

Average level= Peak level+ Duty Cycle Corrected Factor

**Dutycycle:**

Ton1 =0.481ms

Tp = 9.981ms

Duty cycle = Ton/Tp = 0.481/9.981=0.0482

Duty Cycle Corrected Factor = 20lg (Duty cycle) = 20lg0.0482 = -26.34



### Duty cycle

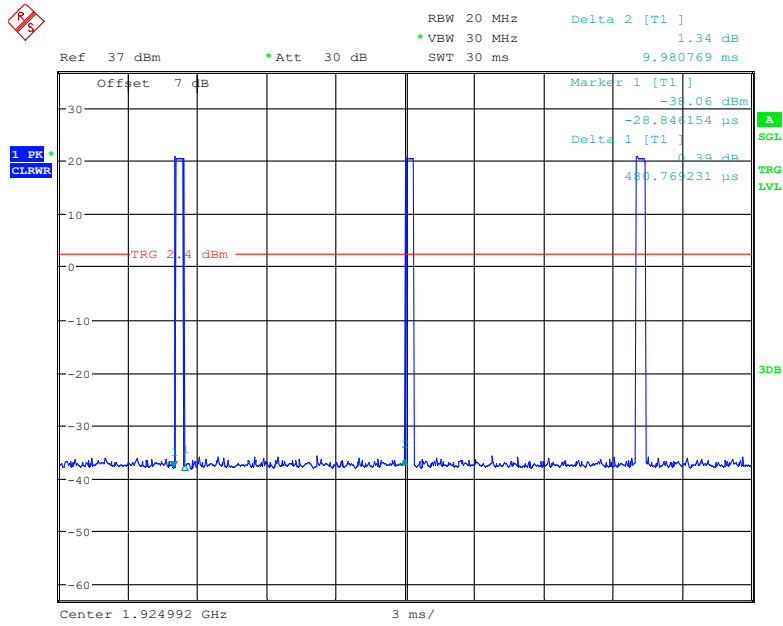

Date: 16.DEC.2021 23:28:16

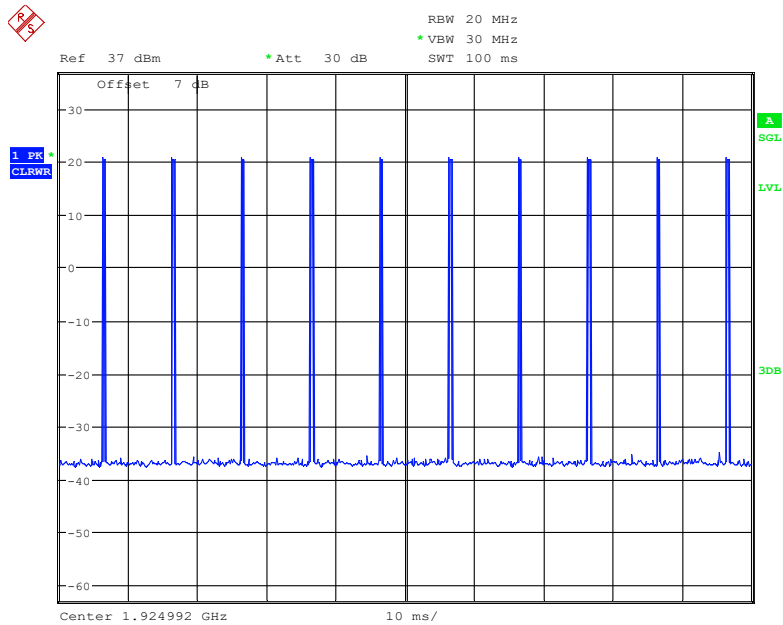

Date: 16.DEC.2021 23:28:41

1 GHz - 18 GHz: (Pre-Scan plots)

Middle channel

Horizontal

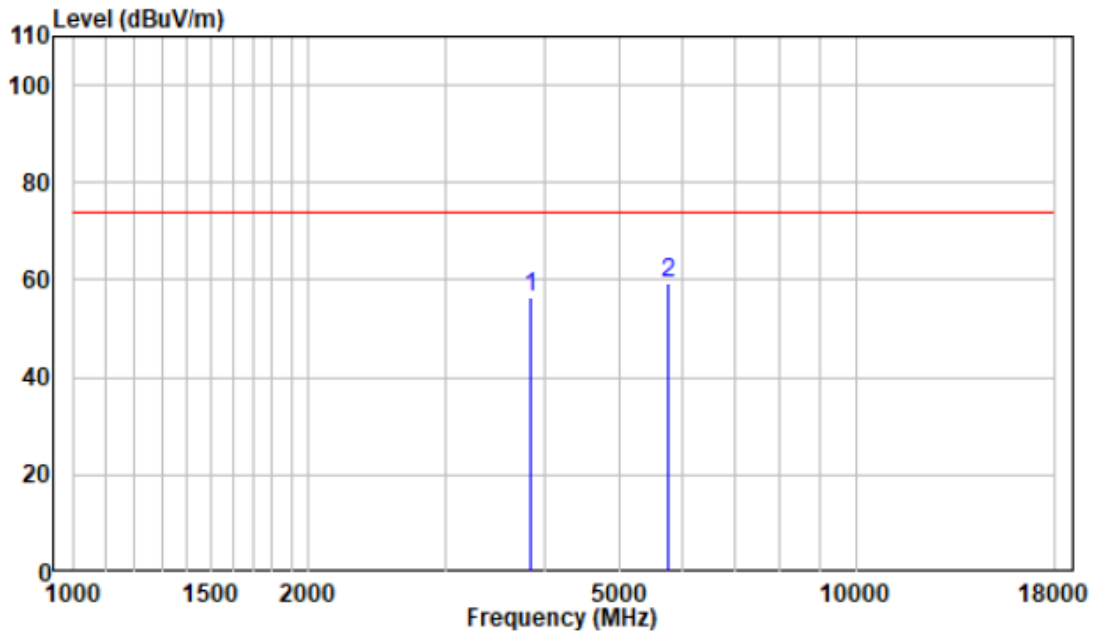

Vertical

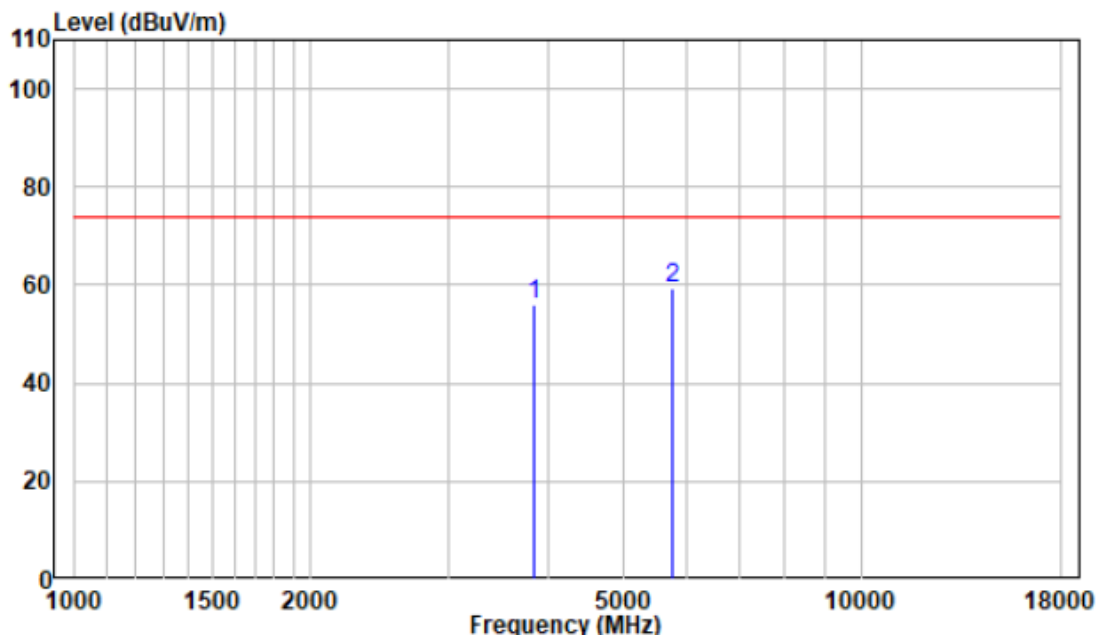

18-20GHz: (Pre-Scan plots)

Middle channel

Horizontal

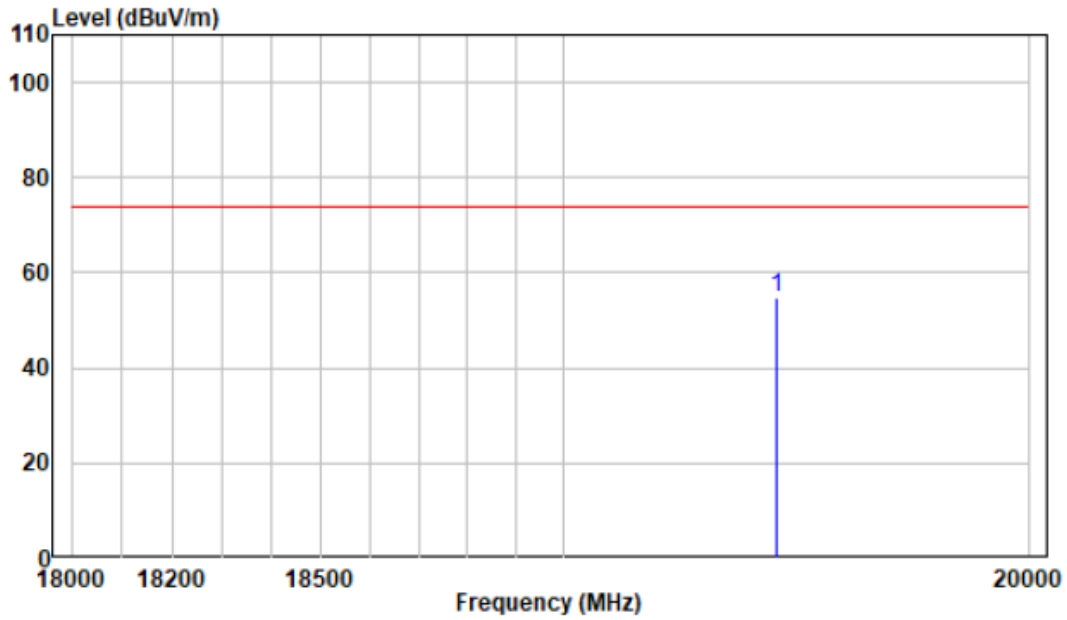

Vertical

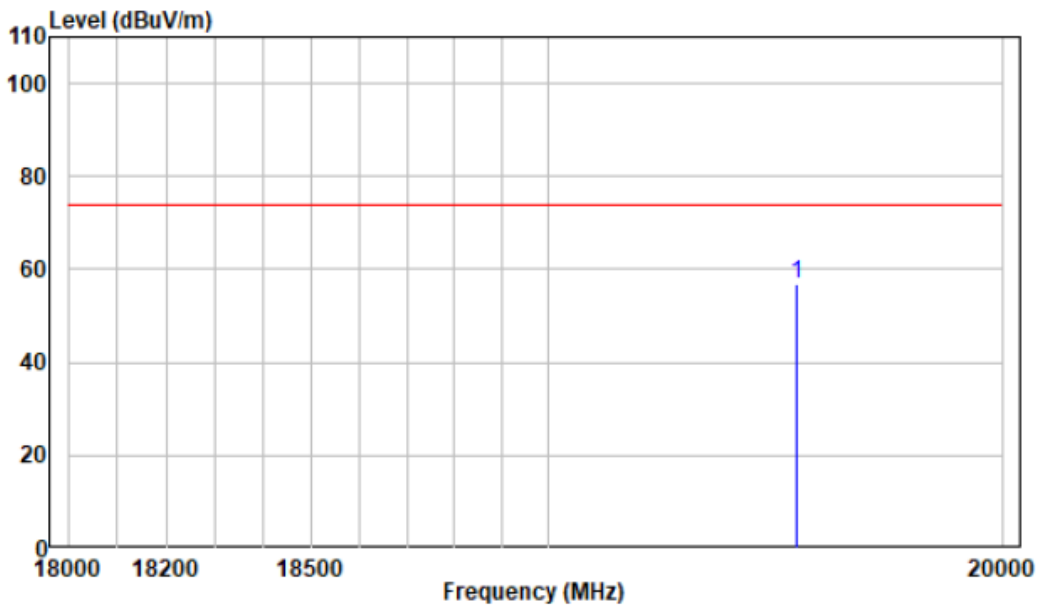

## § 15.323 (f) & RSS-213 §5.3 FREQUENCY STABILITY

### Applicable Standard

Per §15.323(f), the frequency stability of the carrier frequency of the intentional radiator shall be maintained within  $\pm 10$  ppm over 1 hour or the interval between channel access monitoring, whichever is shorter. The frequency stability shall be maintained over a temperature variation of  $-20^{\circ}\text{C}$  to  $+50^{\circ}\text{C}$  at normal supply voltage, and over a variation in the primary supply voltage of 85 percent to 115 percent of the rated supply voltage at a temperature of  $20^{\circ}\text{C}$ . For equipment that is capable only of operating from a battery, the frequency stability tests shall be performed using a new battery without any further requirement to vary supply voltage

According to RSS-213 Issue 3 (2015-03) § (5.3):

The carrier frequency stability shall be maintained within  $\pm 10$  ppm ( $\pm 0.001\%$ ).

According to RSS-Gen Issue 4 (2014-11) § (8.11):

Transmitter frequency stability for licence-exempt radio apparatus shall be measured in accordance with Section 6.11. For licence-exempt radio apparatus, the frequency stability shall be measured at temperatures of  $-20^{\circ}\text{C}$  ( $-4^{\circ}\text{F}$ ),  $+20^{\circ}\text{C}$  ( $+68^{\circ}\text{F}$ ) and  $+50^{\circ}\text{C}$  ( $+122^{\circ}\text{F}$ ) instead of at the temperatures specified in Section 6.11.

### Test Procedure

This procedure should be carried out for each of the following test cases:

Temperature	Supply Voltage
$20^{\circ}\text{C}$	85-115% or new batteries
$-20^{\circ}\text{C}$	Normal
$+50^{\circ}\text{C}$	Normal

During test, the equipment shall be placed in the boxes and set the temperature to the specified requirement until the thermal balance has been reached.

Using the mean carrier frequency at  $20^{\circ}\text{C}$  and at nominal supply voltage as the reference, the mean carrier frequency shall be maintained within  $\pm 10$  ppm at the two extreme temperatures (or as declared by the manufacturer) and at normal temperature (typically  $20^{\circ}\text{C}$ ) at the two extreme supply voltages. This test does not apply to a EUT that is capable only of operating from a battery.

**Test Data****Environmental Conditions**

<b>Temperature:</b>	27.4 °C
<b>Relative Humidity:</b>	56 %
<b>ATM Pressure:</b>	101.0 kPa

*The testing was performed by Black Ding on 2021-12-16.*

**Test Result: Pass**

*Test mode: Transmitting*

<b>Temperature (°C)</b>	<b>Voltage (V<sub>AC</sub>)</b>	<b>Frequency (MHz)</b>	<b>Measured Frequency Offset (kHz)</b>	<b>Measured Frequency Offset (ppm)</b>	<b>Limit (ppm)</b>
-20	120	1924.992	4	2.08	±10
20	102	1924.992	6	3.12	±10
	138	1924.992	5	2.60	±10
50	120	1924.992	6	3.12	±10

## § 15.323 (c)(e) § 15.319 (f) & RSS-213 §5.1&§5.2 SPECIFIC REQUIREMENTS FOR UPCS DEVICE

### Applicable Standard

FCC§15.323(c)(e) & §15.319(f) Specific Requirements for UPCS device.

ANSI C63.17 2013 §6.2 Frequency and time stability and §7.Monitoring tests and §8.Time and spectrum window access procedure.

According to RSS-213 §5.1&§5.2 type of modulation and access protocol

Equipment certified under this standard shall use digital modulation.

In order to provide equitable access to the radio frequency spectrum, the licence-exempt PCS device must possess an access protocol.

### Test Procedure

Measurement method according to ANSI C63.17- 2013

Test configuration as below

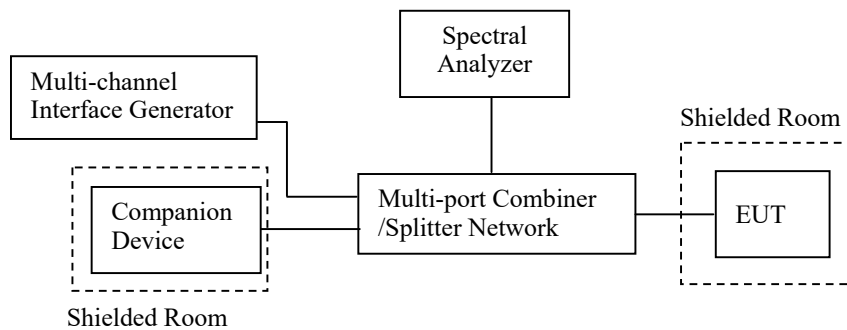

### Test Data

#### Environmental Conditions

<b>Temperature:</b>	27.4 °C
<b>Relative Humidity:</b>	56 %
<b>ATM Pressure:</b>	101.0 kPa

*The testing was performed by Black Ding on 2021-12-16.*

#### Test Result: Pass

*Please see the below data*

## 1) Automatic Discontinuation of Transmission

The device shall automatically discontinue transmission in case of either absence of information to transmit or operational failure. The provisions in this section are not intended to preclude transmission of control and signaling information or use of repetitive codes used by certain digital technologies to complete frame or burst intervals.

### Test result:

The following tests were performed after a connection had been established with Handset.

Test condition	Reaction of EUT	Pass/Fail
Adapter removed from EUT	Connection break down	Pass
Battery remove from Handset	Connection break down	Pass

## 2) Monitoring Time

Immediately prior to initiating transmission, devices must monitor the combined time and spectrum window in which they intend to transmit. For a period of at least 10 milliseconds for systems designed to use a 10 milliseconds or shorter frame period or at least 20 milliseconds for systems designed to use a 20 milliseconds frame period

### Test procedure:

Measurement method is in according to ANSI C63.17 -2013 clause 7.3.3. RF signal generators apply uniform CW interference on all system carriers except two carriers (designated  $f_1$  and  $f_2$ ), each at level  $T_L + U_M$ . EUT can only transmit on these two carriers.

### Test result:

This requirement is covered by the results of Least Interfered Channel (LIC).

Interference (Refer to ANSI C63.17 clause 7.3.3)	Reaction of EUT	Results
a) Apply the interference on $f_1$ at level $T_L + U_M + 20\text{dB}$ and no interference on $f_2$ . Initiate transmission and verify the transmission only on $f_2$ . Then terminate it.	EUT transmits on $f_2$	Pass
b) Apply the interference on $f_2$ at level $T_L + U_M + 20\text{dB}$ and immediately remove all interference from $f_1$ . The EUT should immediately attempt transmission on $f_1$ (but at least 20 ms after the interference on $f_2$ is applied), verify the transmission only on $f_1$ .	EUT transmission $f_1$	Pass

## 3) Lower Monitoring Threshold

The monitoring threshold must not be more than 30 dB above the thermal noise power for a bandwidth equivalent to the emission bandwidth used by the device.

### Test procedure:

Measurement method according to ANSI C63.17 -2013 clause 7.3.1

**Test result:**

Not applicable because the EUT has more 40 defined duplex system access channels and meet the provision of the Least Interfered Channel (LIC).

**4) Maximum Transmit Period**

If no signal above the threshold level is detected, transmission may commence and continue with the same emission bandwidth in the monitored time and spectrum windows without further monitoring. However, occupation of the same combined time and spectrum windows by a device or group of cooperating devices continuously over a period of time longer than 8 hours is not permitted without repeating the access criteria.

**Test procedure:**

The test procedure is as follows:

- a) Activate the EUT and initiate a communication channel with the companion device, and start a timer or frame counter.
- b) The centre frequency of spectrum analyzer was set to the carrier frequency and SPAN was set to ZERO. The spectrum analyzer was used to monitor the time and spectrum window of the communication channel.
- c) Stop the timer at the end of the EUT transmission on the current time and frequency window (measure the time until the EUT changes to a different slot).

**Test result:**

Repetition of Access Criteria	Measured Maximum Transmission Time (Second)	Limit (Second)	Results
First	17680	28,800	Pass
Second	17680	28,800	Pass

**5) System Acknowledgement**

Once access to specific combined time and spectrum windows is obtained an acknowledgment from a system participant must be received by the initiating transmitter within one second or transmission must cease.

Periodic acknowledgments must be received at least every 30 seconds or transmission must cease. Channels used exclusively for control and signaling information may transmit continuously for 30 seconds without receiving an acknowledgment, at which time the access criteria must be repeated.



**Test procedure:**

Measurement method according to ANSI C63.17 2013 clause 8.1, 8.2, 8.2.1

During testing initial transmission without acknowledgement, the signal from the EUT to the companion device is blocked by the circulator.

The test of the transmission time after loss of acknowledgements is performed by cutting off the signal from the companion device by a RF switch and measuring the time until the EUT stops transmitting.

**Test result:**

Test	Time taken (second)	Limit (second)	Result
Initial Connection acknowledgement	0.35	1	Pass
Change of access criteria for control information	N/A	30	N/A
Transmission cease time after loss of acknowledgement	4.11	30	Pass

Note: N/A=Not Applicable

**6) Least Interfered Channel (LIC)**

If access to spectrum is not available as determined by the above, and a minimum of 20 duplex system access channels are defined for the system, the time and spectrum windows with the lowest power level may be accessed.

A device utilizing the provisions of this paragraph (5) must have monitored all access channels defined for its system within the last 10 seconds and must verify, within the 20 milliseconds (40 milliseconds for devices designed to use a 20 millisecond frame period) immediately preceding actual channel access, that the detected power of the selected time and spectrum windows is no higher than the previously detected value.

The power measurement resolution bandwidth for this comparison must be accurate to within 6 dB. No device or group of cooperating devices located within 1 metre of each other shall during any frame period occupy more than 6 MHz of aggregate bandwidth, or alternatively, more than one third of the time and spectrum windows defined by the system.

Calculation of monitoring threshold limits for isochroous devices:

Lower threshold:  $T_L = -174 + 10 \log_{10} B + M_L + P_{MAX} - P_{EUT}$  (dBm)

Where: B=Emission bandwidth (Hz)

$M_L$  = dB the threshold may exceed thermal noise (30 for  $T_L$ )

$P_{MAX} = 5 \log_{10} B - 10$  (dBm)

$P_{EUT}$  = Transmitted power (dBm)

**Calculated thresholds:**

Monitor Threshold	B(MHz)	M <sub>L</sub> (dB)	P <sub>MAX</sub> (dBm)	P <sub>EUT</sub> (dBm)	Threshold (dBm)
Lower threshold	1.383	30	20.70	20.35	-82.24

Note: 1. The upper threshold is applicable as the EUT utilizes more than 20 duplex system channels

**Test procedure:**

Measurement method according to ANSI C63.17 clause 7.3.2, 7.3.3

**C63.17 clause 7.3.2, LIC procedure test:**

4. Allow EUT transmission on only two carrier frequencies, which will be designated  $f_1$  and  $f_2$ .
  5. Apply interference to the EUT on  $f_1$  at a level of  $TL + UM + 7$  dB and on  $f_2$  at a level of  $TL + UM$ . Initiate transmission. The EUT should transmit on  $f_2$ . Terminate the connection. Repeat five times. If the EUT transmits once on  $f_1$ , the test failed.
  6. Apply interference to the EUT on  $f_1$  at a level of  $TL + UM$  and on  $f_2$  at a level of  $TL + UM + 7$  dB. Initiate transmission. The EUT should transmit on  $f_1$ . Terminate the connection. Repeat five times. If the EUT transmits once on  $f_2$ , the test failed.
  7. Apply interference to the EUT on  $f_1$  at a level of  $TL + UM + 1$  dB and on  $f_2$  at a level of  $TL + UM - 6$  dB. Initiate transmission. If the EUT transmits on  $f_2$ , terminate the connection. Repeat five times. If the EUT transmits once on  $f_1$ , the test failed.
- e) Apply interference to the EUT on  $f_1$  at a level of  $TL + UM - 6$  dB and on  $f_2$  at a level of  $TL + UM + 1$  dB. Initiate transmission. If the EUT transmits on  $f_1$ , terminate the connection. Repeat five times. If the EUT transmits once on  $f_2$ , the test failed.

**C63.17 clause 7.3.3, Selected channel confirmation:**

- a) Allow EUT transmission on only two carrier frequencies, which will be designated  $f_1$  and  $f_2$ . This limitation to carriers  $f_1$  and  $f_2$  is performed preferably by administration commands for the EUT, or alternatively by applying by a multicarrier interference generator uniform interference on all system carriers except  $f_1$  and  $f_2$ , at a level of  $TL + UM + 20$  dB in-band per carrier. Set the interference level to the EUT on  $f_1$  to a level of  $TL + UM + 20$ dB, and let there be no interference applied on  $f_2$ .
- b) Initiate transmission and verify that the EUT transmits on  $f_2$ . If a connection was made, terminate it.
- c) Apply interference on  $f_2$  at a level of  $TL + UM + 20$  dB in-band, and immediately remove all interference from  $f_1$  and immediately (but not sooner than 20 ms after the interference on  $f_2$  is applied) cause the EUT to attempt transmission. The EUT should now transmit on  $f_1$ , if it transmits.
- d) If the EUT transmits on  $f_2$ , it fails.

**Test result:****1) LIC procedure test:**

Interference (Refer to ANSI C63.17 clause 7.3.3)	Reaction of EUT	Results
a) Apply the interference on $f_1$ at level $T_L+U_M+7\text{dB}$ and the interference on $f_2$ at level $T_L+U_M$ . Initiate transmission and verify the transmission only on $f_2$ . Repeat 5 times.	EUT transmits on $f_2$	Pass
b) Apply the interference on $f_1$ at level $T_L+U_M$ and the interference on $f_2$ at level $T_L+U_M+7\text{dB}$ . Initiate transmission and verify the transmission only on $f_1$ . Repeat 5 times.	EUT transmits on $f_1$	Pass
c) Apply the interference on $f_1$ at level $T_L+U_M+1\text{dB}$ the interference on $f_2$ at level $T_L+U_M-6\text{dB}$ . Initiate transmission and verify the transmission only on $f_2$ . Repeat 5 times.	EUT transmits on $f_2$	Pass
d) Apply the interference on $f_1$ at level $T_L+U_M-6\text{dB}$ and the interference on $f_2$ at level $T_L+U_M+1\text{dB}$ . Initiate transmission and verify the transmission only on $f_1$ . Repeat 5 times.	EUT transmits on $f_1$	Pass

**2) Selected channel confirmation:**

Interference (Refer to ANSI C63.17 clause 7.3.4)	Reaction of EUT	Results
a) Apply the interference on $f_1$ at level $T_U+U_M$ and no interference on $f_2$ . Initiate transmission and verify the transmission only on $f_2$ . Then terminate it.	EUT transmits on $f_2$	Pass
b) Apply the interference on $f_2$ at level $T_L+U_M$ and immediately remove all interference from $f_1$ . The EUT should immediately attempt transmission on $f_1$ (but at least 20 ms after the interference on $f_2$ is applied), verify the transmission only on $f_1$ .	EUT transmission $f_1$	Pass

**7) Random waiting**

If the selected combined time and spectrum windows are unavailable, the device may either monitor and select different windows or seek to use the same window after waiting an amount of time, randomly chosen from a uniform random distribution between 10 and 150 milliseconds, commencing when the channel becomes available.

**Test procedure:**

This test is for EUTs that transmit control and signaling channels and that use the provisions of FCC §15.323(c)(6) & IC RSS-213 5.2(6), thus to verify that the EUT (if in deferral) waits for a channel to go clear, then implements a 10 ms to 150 ms hold off prior to using the channel. FCC §15.323(c)(6) is not restrictive for EUTs that use the LIC and offer 20 or more duplex communications channels, as a combined time and spectrum window cannot become unavailable as there is no threshold limit. Test method according to ANSI C63.17 2013 clause 8.1.2 or 8.1.3

8. Restrict operation of the EUT to a single carrier designated  $f_1$ . For TDMA system, further restrict EUT transmission to a single timeslot of the usable timeslots available in the TDMA frame structure and synchronize the interference so as to occur centered within the timeslot.

9. Activate the EUT with no interference present. The EUT must transmit on  $f_1$ . Then apply CW interference on  $f_1$ . The interference level shall be at  $TL + UM$  as appropriate for EUTs that do or do not meet the requirements for using the upper threshold. The EUT must stop transmitting within 30 s.
10. Cancel the interference. Measure the time interval between the end of the interference transmission and the beginning of transmission by the EUT.
- d) Repeat step b) and step c) 100 times. If the measured time intervals vary uniformly between 10 ms and 150 ms, the EUT passes the test.

Note: This is Not Applicable

## 8) Monitoring Bandwidth and Reaction Time

The monitoring system bandwidth must be equal to or greater than the emission bandwidth of the intended transmission and have a maximum reaction time less than  $50 \times \text{SQRT}(1.25/\text{emission bandwidth in MHz})$  microseconds for signals at the applicable threshold level but shall not be required to be less than 50 microseconds.

**Note:** Testing of the monitoring system bandwidth is not required if the designed bandwidth from the manufacturer is available and given in the test report.

The maximum reaction time of the monitor shall be less than  $50 \sqrt{1.25/\text{occupied bandwidth in MHz}}$   $\mu\text{s}$  for signals at the applicable threshold level but shall not be required to be less than 50  $\mu\text{s}$ .

If a signal of 6 dB or more above the threshold level is detected, the maximum reaction time shall be  $35 \sqrt{1.25/\text{occupied bandwidth in MHz}}$   $\mu\text{s}$  but shall not be required to be less than 35  $\mu\text{s}$ .

### Test procedure:

Measurement method according to ANSI C63.17 2013 clause 7.4 & 7.5

11. Restrict the EUT to a single transmit carrier frequency  $f_1$ , and verify that the EUT can establish a connection with no interference applied on  $f_1$ .
12. Apply time-synchronized, pulsed interference on  $f_1$  at the pulsed level  $TL + UM$ , verify that the EUT does not establish a connection when the width of the interference pulse exceeds the largest of 50  $\mu\text{s}$  and  $50 \sqrt{1.25/B}$   $\mu\text{s}$ , where  $B$  is the emission bandwidth of the EUT in megahertz.
- c) With the channel interference level 6 dB above  $TL + UM$ , verify that the EUT does not establish a connection when the width of the interference pulse exceeds the largest of 35  $\mu\text{s}$  and  $35 \sqrt{1.25/B}$   $\mu\text{s}$ , where  $B$  is the emission bandwidth of the EUT in megahertz.

Test Pulse width Equation ( $\mu\text{s}$ )	B(bandwidth) (MHz)	Pulse width ( $\mu\text{s}$ )	Limit ( $\mu\text{s}$ )
$50 (1.25/B)^{1/2}$	1.382	47.55	50
$35 (1.25/B)^{1/2}$	1.383	33.27	35

**Test result:****1) Monitoring Bandwidth:**

The antenna of the EUT used for monitoring is the same interior antenna that used for transmission, so the monitoring system bandwidth is equal to the emission bandwidth of the intended transmission

**2) Reaction Time Test:**

No.	Interference Pulse width (μs)	Reaction of EUT	Observing time (μs)	Result
1	50μs with level $T_L+U_M$	No transmission	25.35	Pass
2	35μs with level $T_L+U_M+6dB$	No transmission	20.20	Pass

**9) Monitoring Antenna**

The monitoring system shall use the same antenna used for transmission, or an antenna that yields equivalent reception at that location.

**Test procedure:**

Measurement method according to ANSI C63.17 -2013 paragraph 4

**Test result:**

The antenna of the EUT used for transmission is the same interior antenna that used for monitoring.

**10) Monitoring threshold relaxation**

Devices that have a power output lower than the maximum permitted under the rules can increase their monitoring detection threshold by one decibel for each one decibel that the transmitter power is below the maximum permitted.

**Test procedure:**

Measurement method according to ANSI C63.17 -2013 clause 7.4 & paragraph 4

**Test result:**

This requirement is covered by the results of Least Interfered Channel (LIC).

**11) Duplex Connections**

An initiating device may attempt to establish a duplex connection by monitors both its intended transmit and receive time and spectrum windows. If both the intended transmit and receive time and spectrum windows meet the access criteria, then the initiating device can initiate a transmission in the intended transmit time and spectrum window. If the power detected by the responding device can be decoded as a duplex connection signal from the initiating device, then the responding device may immediately begin transmitting on the receive time and spectrum window monitored by the initiating device.

**Test procedure:**

This test validates proper operation of an EUT that operates according to the provisions of FCC §15.323(c)(10) using a check of both transmit and receive channels on one end of the link to qualify both ends of the link for transmissions. Test method according to ANSI C63.17 clause 8.3.2 Validation of dual access criteria check for EUTs that implement the upper threshold

13. Adjust the path loss between the EUT and its companion device such that the received signal to the EUT from the companion device is at least 40 dB above  $TL + UM$ .
  14. Restrict the EUT and its companion device to operation at a single carrier  $f_1$  for TDMA systems and on  $f_1$  and  $f_2$  and corresponding duplex carriers for FDMA systems. Verify that the EUT and its companion device can establish a connection on a time/spectrum window on the enabled carrier(s). Terminate the connection.
- c) Apply interference to the EUT on the EUT's *transmit* time/spectrum windows at  $TL + UM$  per carrier on all time/spectrum windows except for one, which has interference at least 10 dB below  $TL$ . Adjust the interference to the EUT on its *receive* time/spectrum windows such that a single time/spectrum window has interference at least 10 dB below  $TL$ , and the interference on the other time/spectrum windows is at  $TL + UM + 7$  dB. The interference to the companion device should be at least 10 dB below  $TL$  on all active time/spectrum windows. The interference-free *receive* time/spectrum window must not be the duplex mate of the interference-free *transmit* time/spectrum window.
- d) Cause the EUT to attempt to establish a connection. The connection should be made on the interference-free *receive* time/spectrum window and its duplex mate. Otherwise, the EUT fails the test.
- e) If a connection exists, terminate it. Reduce the interference on the EUT's *receive* time/spectrum windows to a level of  $TL + UM$  per carrier on all time/spectrum windows except for one, which has interference at least 10 dB below  $TL$ . Raise the interference on the EUT's *transmit* time/spectrum windows to a level of  $TL + UM + 7$  dB, maintaining one time/spectrum window with interference at least 10 dB below  $TL$ . The interference to the companion device should be at least 10 dB below  $TL$  on all active time/spectrum windows. Again, the interference-free *transmit* and *receive* time/spectrum windows should not constitute a duplex pair if the system designates a specific duplex pairing for time/spectrum windows.
- f) Cause the EUT to attempt to establish a connection. The connection should be made on the interference-free *transmit* time/spectrum window and its duplex mate. Otherwise, the system fails the test.
- g) Terminate the connection and raise the interference to the EUT on all of the EUT's *transmit* and *receive* time/spectrum windows to  $TU + UM$  per carrier on all time/spectrum windows except for a single *transmit* time/spectrum window and a single *receive* time/spectrum window, which shall have interference at least 10 dB below  $TL$ . The low-interference *transmits* and *receives* time/spectrum windows shall not constitute a duplex pair. Adjust the path loss between the EUT and its companion device such that the received signal to the EUT from the companion device is at least 30 dB above  $TU$ . Cause the EUT to attempt to establish a connection. If a connection is established, the test fails.

**Test result:**

Not applicable for FP

**12) Alternative monitoring interval**

An initiating device that is prevented from monitoring during its intended transmit window due to monitoring system blocking from the transmissions of a co-located (within one meter) transmitter of the same system, may monitor the portions of the time and spectrum windows in which they intend to receive over a period of at least 10 milliseconds. The monitored time and spectrum window must total at least 50 percent of the 10 millisecond frame interval and the monitored spectrum must be within 1.25 MHz of the center frequency of channel(s) already occupied by that device or co-located co-operating devices. If the access criteria is met for the intended receive time and spectrum window under the above conditions, then transmission in the intended transmit window by the initiating device may commence.

**Test procedure:**

This test validates the ability of the EUT to distinguish between same-system and other-system interference for purposes of satisfying the requirement of 47CFR15.323(c) (11). Test method according to ANSI C63.17 2013 clause 8.4

15. Adjust the path loss between the EUT and its companion device such that the received signal to the EUT from the companion device is at least 30 dB above  $TL$ .
  16. Restrict the EUT and its companion device to operation at a single carrier  $f_1$  for TDMA systems and on  $f_1$  and  $f_2$  and corresponding duplex carriers for FDMA systems. Verify that the EUT and its companion device can establish a connection.
  17. Apply interference at  $TL + UM$  per carrier to the EUT on all *transmit* time/spectrum windows on the enabled carrier(s). The interference must use the same physical layer parameters (modulation, frame format, etc.) as the EUT transmissions, but with a system identifier different from that used by the EUT and the companion device. Ensure that the interference level at the companion device is at least 10 dB below  $TL$ . Apply no interference to the *receive* time/spectrum windows on the enabled carriers.
- d) Cause the EUT to attempt to establish a connection. If a connection is established, the test fails.

**Test result:**

Interference (Refer to ANSI C63.17 § 8.4)	Reaction of EUT	Results
a) Only a single carrier $f_1$ for EUT TDMA systems and on $f_1$ and $f_2$ and corresponding duplex carriers for FDMA systems.	EUT can transmit	Pass
b) Apply interference with same parameters as EUT transmissions on all Tx windows with level $TL+UM$ on the enabled carrier(s) and no interference on the Rx windows on the enabled carriers.	No connection is established	Pass

IC:

Not appropriate, as the system always monitor both the transmit and receive time/spectrum windows, it is not a co-located device.

**13) Fair Access**

The provisions of FCC §15.323 (c) & paragraphs 5.2 (10) or (11) shall not be used to extend the range of spectrum occupied over space or time for the purpose of denying fair access to spectrum to other devices.

**Test result:**

The manufacturer declares that this device does not use any mechanisms as provided by FCC §15.323(c)(10) or (11) & IC RSS-213 5.2(10) and (11) to extend the range of spectrum occupied over space or time for the purpose of denying fair access to spectrum to other device.

**14) Frame Repetition Stability Frame Period and Jitter**

The frame period (a set of consecutive time slots in which the position of each time slot can be identified by reference to a synchronizing source) of an intentional radiator operating in these sub-bands shall be 20 milliseconds or 10 milliseconds/X where X is a positive whole number. Each device that implements time division for the purposes of maintaining a duplex connection on a given frequency carrier shall maintain a frame repetition rate with a frequency stability of at least 50 parts per million (ppm). Each device which further divides access in time in order to support multiple communication links on a given frequency carrier shall maintain a frame repetition rate with a frequency stability of at least 10 ppm. The jitter (time-related, abrupt, spurious variations in the duration of the frame interval) introduced at the two ends of such a communication link shall not exceed 25 microseconds for any two consecutive transmissions. Transmissions shall be continuous in every time and spectrum window during the frame period defined for the device.

**Test procedure:**

Measurement method according to ANSI C63.17 2013 clause 6.2.2, 6.2.3

**Test result:**

Frame Period and Jitter:

Max. pos. Jitter ( $\mu$ s)	Max. neg. Jitter ( $\mu$ s)	Frame period (ms)	Limit	
			Frame Period (ms)	Jitter ( $\mu$ s)
0.02	-0.04	9.98	20 or 10/X	25

Note: X is a positive whole number.

**\*\*\*\*\* END OF REPORT \*\*\*\*\***