

SIP CONTEMPORARY SERIES

CTM-S2315

SIP Corded Trimstyle 1-line Hotel Phone

vtech[®]

Master User 's Guide

IMPORTANT SAFETY INSTRUCTIONS

When using your telephone equipment, basic safety precautions should always be followed to reduce the risk of fire, electric shock and injury, including the following:

1. This product should be installed by a qualified technician.
2. This product should only be connected to the host equipment and never directly to the network such as Public Switch Telephone Network (PSTN) or Plain Old Telephone Services (POTS).
3. Read and understand all instructions.
4. Follow all warnings and instructions marked on the product.
5. Unplug this product from the wall outlet before cleaning. Do not use liquid or aerosol cleaners. Use a damp cloth for cleaning.
6. Do not use this product near water such as near a bath tub, wash bowl, kitchen sink, laundry tub or swimming pool, or in a wet basement or shower.
7. Do not place this product on an unstable table, shelf, stand or other unstable surfaces.
8. Slots and openings in the back or bottom of the telephone base and handset are provided for ventilation. To protect them from overheating, these openings must not be blocked by placing the product on a soft surface such as a bed, sofa or rug. This product should never be placed near or over a radiator or heat register. This product should not be placed in any area where proper ventilation is not provided.
9. This product should be operated only from the type of power source indicated on the marking label. If you are not sure of the type of power supply on the premises, consult your dealer or local power company.
10. Do not allow anything to rest on the power cord. Do not install this product where the cord may be walked on.
11. Never push objects of any kind into this product through the slots in the telephone base or handset because they may touch dangerous voltage points or create a short circuit. Never spill liquid of any kind on the product.
12. To reduce the risk of electric shock, do not disassemble this product, but take it to an authorized service facility. Opening or removing parts of the telephone base or handset other than specified access doors may expose you to dangerous voltages or other risks. Incorrect reassembling can cause electric shock when the product is subsequently used.
13. Do not overload wall outlets and extension cords.
14. Unplug this product from the wall outlet and refer servicing to an authorized service facility under the following conditions:
 - When the power supply cord or plug is damaged or frayed.
 - If liquid has been spilled onto the product.
 - If the product has been exposed to rain or water.
 - If the product does not operate normally by following the operating instructions. Adjust only those controls that are covered by the operation instructions. Improper adjustment of other controls may result in damage and often requires extensive work by an authorized technician to restore the product to normal operation.

- If the product has been dropped and the telephone base and/or handset has been damaged.

- If the product exhibits a distinct change in performance.

15. Avoid using a telephone (other than cordless) during an electrical storm. There is a remote risk of electric shock from lightning.

16. Do not use the telephone to report a gas leak in the vicinity of the leak. Under certain circumstances, a spark may be created when the adapter is plugged into the power outlet, or when the handset is replaced in its cradle. This is a common event associated with the closing of any electrical circuit. The user should not plug the phone into a power outlet, and should not put a charged handset into the cradle, if the phone is located in an environment containing concentrations of flammable or flame-supporting gases, unless there is adequate ventilation. A spark in such an environment could create a fire or explosion. Such environments might include: medical use of oxygen without adequate ventilation; industrial gases (cleaning solvents; gasoline vapors; etc.); a leak of natural gas; etc.

17. Only put the handset of your telephone next to your ear when it is in normal talk mode.

18. The power adapters are intended to be correctly oriented in a vertical or floor mount position. The prongs are not designed to hold the plug in place if it is plugged into a ceiling, under-the-table or cabinet outlet.

19. Use only the power cord and batteries indicated in this manual. Do not dispose of batteries in a fire. They may explode. Check with local codes for possible special disposal instructions.

20. In wall mounting position, make sure to mount the telephone base on the wall by aligning the eyelets with the mounting studs of the wall plate. Then slide the telephone base down on both mounting studs until it locks into place. Refer to the full instructions in Installation in the user's manual.

⚠ CAUTIONS

- Keep small metallic objects such as pins and staples away from the handset receiver.

SAVE THESE INSTRUCTIONS

Do not install the product at a height above 2 meters.

Name plate label marked on the bottom of base unit.



Use only supplied adapter, manufacturer TEN PAO INDUSTRIAL CO LTD model S012CDU0500200.

For PLUGGABLE EQUIPMENT, the socket-outlet shall be installed near the equipment and shall be easily accessible.

INSTRUCTIONS DE SÉCURITÉ IMPORTANTES

Lorsque vous utilisez votre équipement téléphonique, des précautions de base doivent toujours être prises pour réduire les risques d'incendie, d'électrocution et de blessure, notamment les suivantes :

1. Ce produit doit être installé par un technicien qualifié.
2. Ce produit ne doit être connecté qu'à l'équipement hôte et jamais directement au réseau tel que le réseau téléphonique public commuté (RTPC) ou les services téléphoniques classiques (POTS).
3. Lire et comprendre toutes les instructions.
4. Respecter tous les avertissements et instructions figurant sur le produit.
5. Débranchez ce produit de la prise murale avant de le nettoyer. N'utilisez pas de nettoyeurs liquides ou en aérosol. Utilisez un chiffon humide pour le nettoyage.
6. N'utilisez pas ce produit près de l'eau, par exemple près d'une baignoire, d'une cuvette de lavage, d'un évier de cuisine, d'une cuve de lavage ou d'une piscine, ou dans un sous-sol ou une douche humide.
7. Ne pas placer ce produit sur une table, une étagère, un support ou toute autre surface instable.
8. Des fentes et des ouvertures à l'arrière ou en-dessous du socle du téléphone et du combiné sont prévues pour la ventilation. Afin de les protéger contre la surchauffe, ces ouvertures ne doivent pas être obstruées en plaçant le produit sur une surface souple comme un lit, un divan ou un tapis. Ce produit ne doit jamais être placé à proximité ou au-dessus d'un radiateur ou d'un registre de chaleur. Ce produit ne doit pas être placé dans un endroit où une ventilation adéquate n'est pas assurée.
9. Ce produit ne doit être utilisé qu'avec le type de source d'énergie indiqué sur l'étiquette de marquage. Si vous n'êtes pas sûr du type d'alimentation électrique sur place, consultez votre revendeur ou votre compagnie d'électricité locale.
10. Ne laissez rien reposer sur le cordon d'alimentation. N'installez pas ce produit à un endroit où l'on pourrait marcher sur le cordon.
11. N'introduisez jamais d'objets de quelque nature que ce soit dans ce produit par les fentes du socle du téléphone ou du combiné, car ils pourraient toucher des points de tension dangereux ou créer un court-circuit. Ne jamais renverser de liquide de quelque nature que ce soit sur le produit.
12. Pour réduire le risque d'électrocution, ne démontez pas ce produit, mais confiez-le à un service après-vente agréé. Ouvrir ou retirer des parties du socle du téléphone ou du combiné autres que les portes d'accès spécifiées peut vous exposer à des tensions dangereuses ou à d'autres risques. Un remontage incorrect peut provoquer une électrocution lors de l'utilisation ultérieure du produit.
13. Ne surchargez pas les prises murales et les rallonges électriques.
14. Débranchez ce produit de la prise murale et confiez l'entretien à un centre de service agréé dans les conditions suivantes :
 - Lorsque le cordon d'alimentation ou la fiche est endommagé ou effiloché.
 - Si du liquide a été renversé sur le produit.





- Si le produit a été exposé à la pluie ou à l'eau.
 - Si le produit ne fonctionne pas normalement en suivant les instructions d'utilisation. Ne réglez que les commandes qui sont couvertes par le mode d'emploi. Un mauvais réglage des autres commandes peut entraîner des dommages et nécessite souvent un travail important de la part d'un technicien autorisé pour remettre le produit en état de fonctionnement.
 - Si le produit est tombé et que le socle du téléphone et/ou le combiné ont été endommagés.
 - Si le produit présente un changement distinct de performance.
15. Évitez d'utiliser un téléphone (autre que sans fil) pendant un orage électrique. Il existe un risque d'électrocution dû à la foudre.
16. N'utilisez pas le téléphone pour signaler une fuite de gaz à proximité de la fuite. Dans certaines circonstances, une étincelle peut se produire lorsque l'adaptateur est branché dans la prise de courant, ou lorsque le combiné est replacé dans son berceau. Il s'agit d'un événement courant associé à la fermeture de tout circuit électrique. L'utilisateur ne doit pas brancher le téléphone dans une prise de courant, ni placer un combiné chargé dans son socle, si le téléphone est situé dans un environnement contenant des concentrations de gaz inflammables ou propices aux flammes, à moins qu'il n'y ait une ventilation adéquate. Une étincelle dans un tel environnement pourrait créer un incendie ou une explosion. Ces environnements peuvent comprendre : l'utilisation médicale de l'oxygène sans ventilation adéquate; les gaz industriels (solvants de nettoyage; vapeurs d'essence; etc.); une fuite de gaz naturel; etc.
17. Ne placez le combiné de votre téléphone près de votre oreille que lorsqu'il est en mode de conversation normal.
18. Les adaptateurs d'alimentation sont destinés à être correctement orientés en position verticale ou au sol. Les broches ne sont pas conçues pour maintenir la fiche en place si elle est branchée au plafond, sous la table ou dans une prise de courant d'armoire.
19. Utilisez uniquement le cordon d'alimentation et les piles indiqués dans ce manuel. Ne jetez pas les piles au feu. Elles risquent d'exploser. Vérifiez auprès des autorités locales les éventuelles instructions spéciales d'élimination.
20. En position de montage mural, veillez à monter le socle du téléphone sur le mur en alignant les oeilletons avec les montants de fixation de la plaque murale. Ensuite, faites glisser le socle téléphonique vers le bas sur les deux montants de montage jusqu'à ce qu'il se verrouille en place. Reportez-vous aux instructions complètes dans la section Installation du guide d'utilisation.
-  MISE EN GARDE
- Gardez les petits objets métalliques tels que les épingles et les agrafes loin du combiné.
- ## CONSERVEZ CES INSTRUCTIONS
- N'installez pas du produit à une hauteur supérieure à 2 mètres.
- Étiquette de la plaque signalétique marquée au bas de l'unité de base.
-   Utilisez uniquement l'adaptateur fourni, fabricant TEN PAO INDUSTRIAL CO LTD ELECTRONIC CO., LTD modèle S012CDU050020.
- Pour les équipements enfichables, le prix de courant (adaptateur de courant) devra être installé près de l'équipement et être accessible.

TABLE OF CONTENTS

Important safety instructions	2
Instructions de sécurité importantes	4
Parts check list	7
Telephone layout	8
Installation	9
Telephone settings	12
Telephone operation	13
Appendix	14
Troubleshooting	14
VTech Hospitality Limited Warranty Program	17
FCC, ACTA and IC regulations	19
Operating range	22
Precautions for users of implanted cardiac pacemakers	22
Maintenance	23
Disclaimer and Limitation of Liability	23
Technical specification	25

Parts check list

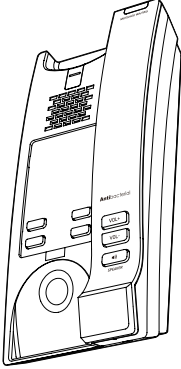
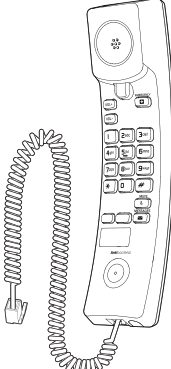
Items contained in the **corded telephone** package:

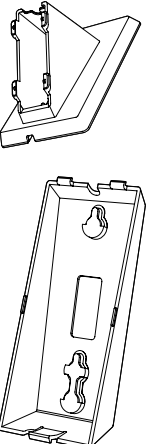
MODEL NAME	MODEL NUMBER	PARTS INCLUDED			
		TELEPHONE BASE WITH FACEPLATE AND OVERLAY	CORDED HANDSET	ETHERNET CABLE	BASE STAND MOUNTING BRACKET
Trimstyle SIP corded 1-Line	CTM-S2315				

Telephone layout

SIP Corded Trimstyle 1-line CTM-S2315

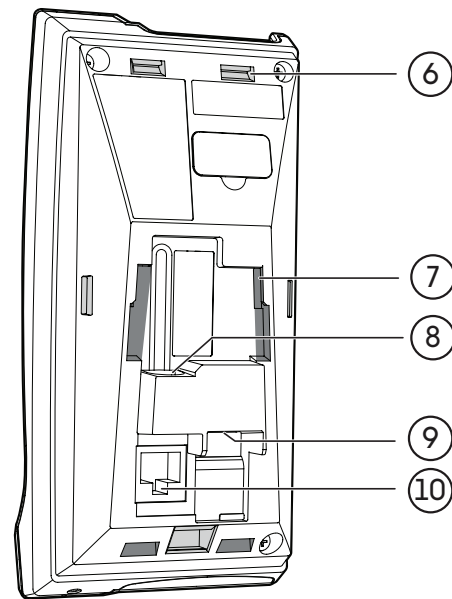
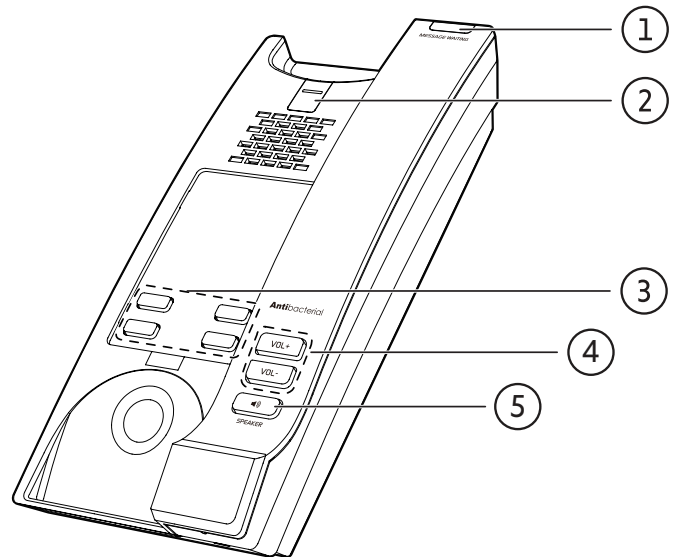
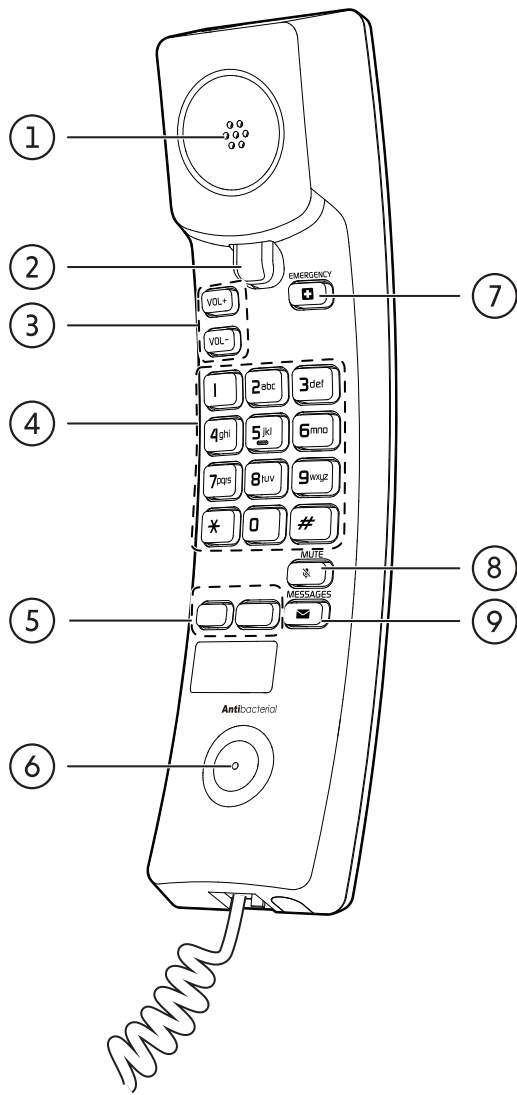

1	Corded handset earpiece
2	Switch hook
3	VOLUME + VOLUME -
4	Numeric dial keys
5	Speed dial keys Programmable key #1 Programmable key #2
6	Microphone
7	EMERGENCY
8	MUTE
9	MESSAGES

1	MESSAGE WAITING LED
2	Wall mount clip
3	Speed dial keys Programmable key #5 Programmable key #6 Programmable key #7 Programmable key #8
4	VOLUME + VOLUME -
5	SPEAKER
6	Grooves for mounting bracket
7	Grooves for base stand
8	Power adapter
9	Coiled handset cord jack
10	Ethernet cable

Installation

SIP Corded Trimstyle 1-line CTM-S2315

TELEPHONE BASE INSTALLATION

INSTALLATION OPTION - DESKTOP POSITION

1. Turn the telephone base over with the bottom side facing up. Insert the base stand into the lower grooves on the telephone base until they lock securely as shown below.

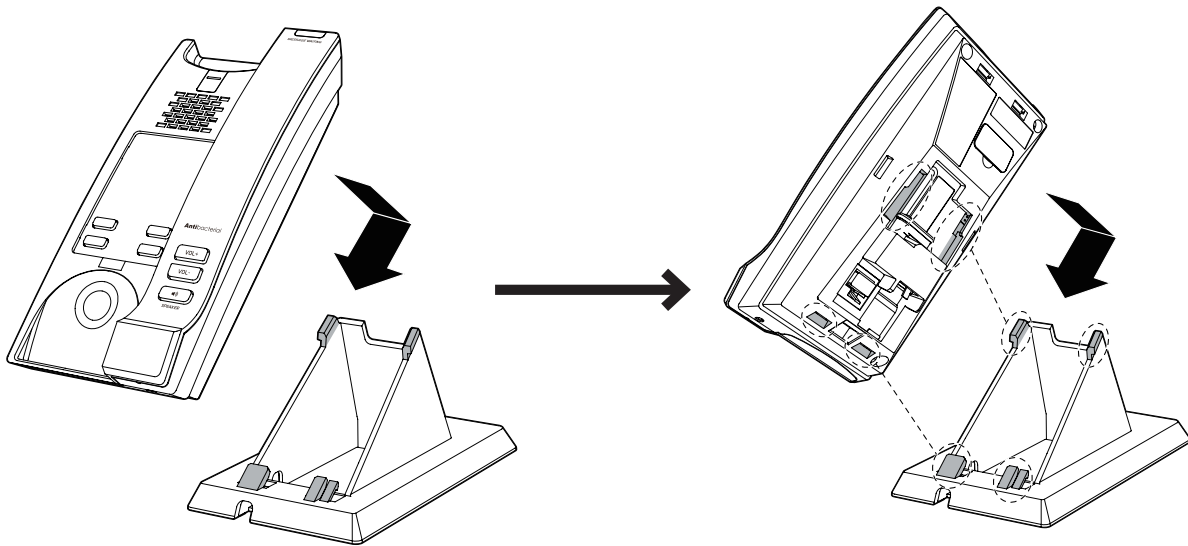

2. Connect both the ethernet cable and coiled handset cord to the telephone base and route them along the wire ducts accordingly. Install the telephone base as shown below.

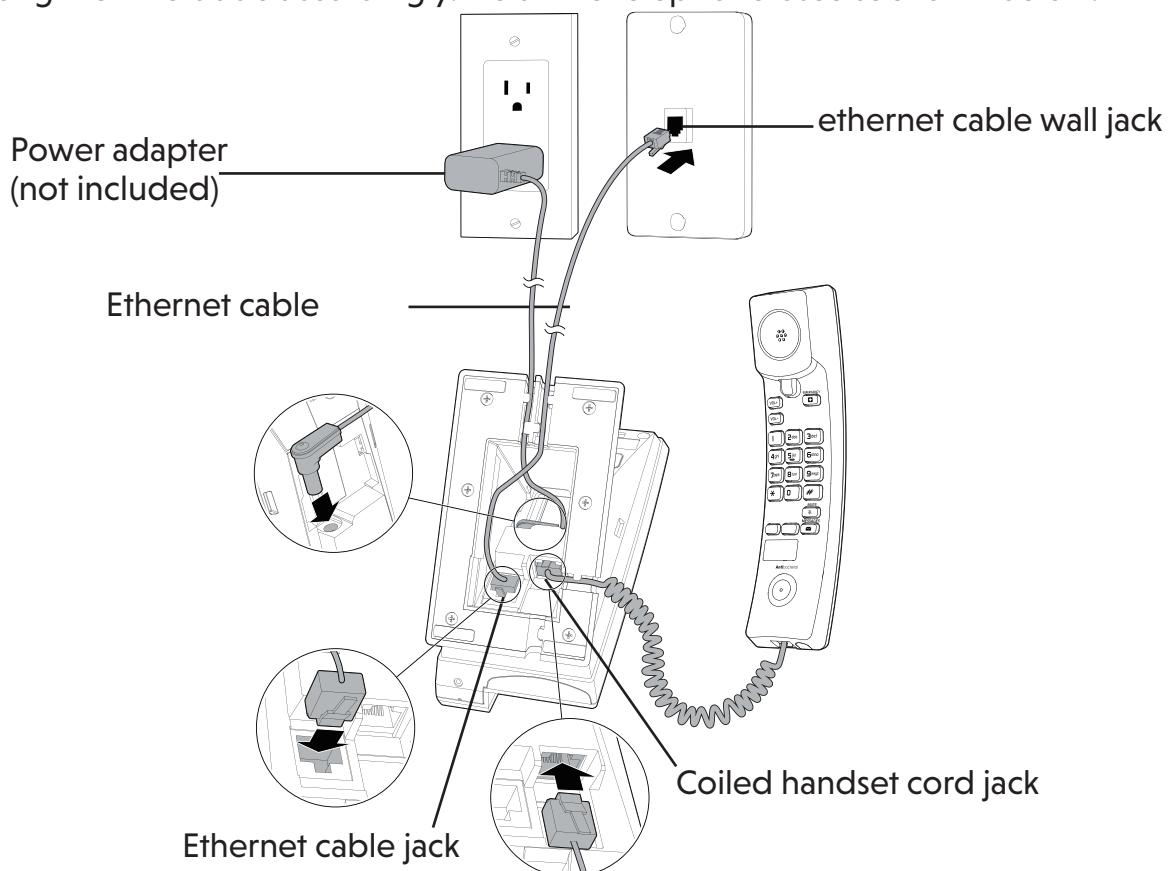

SIP Corded Trimstyle 1-line CTM-S2315

TELEPHONE BASE INSTALLATION

INSTALLATION OPTION - WALL MOUNT POSITION

TO MOUNT THE TELEPHONE BASE ON THE WALL

1. Install the telephone base as shown below.

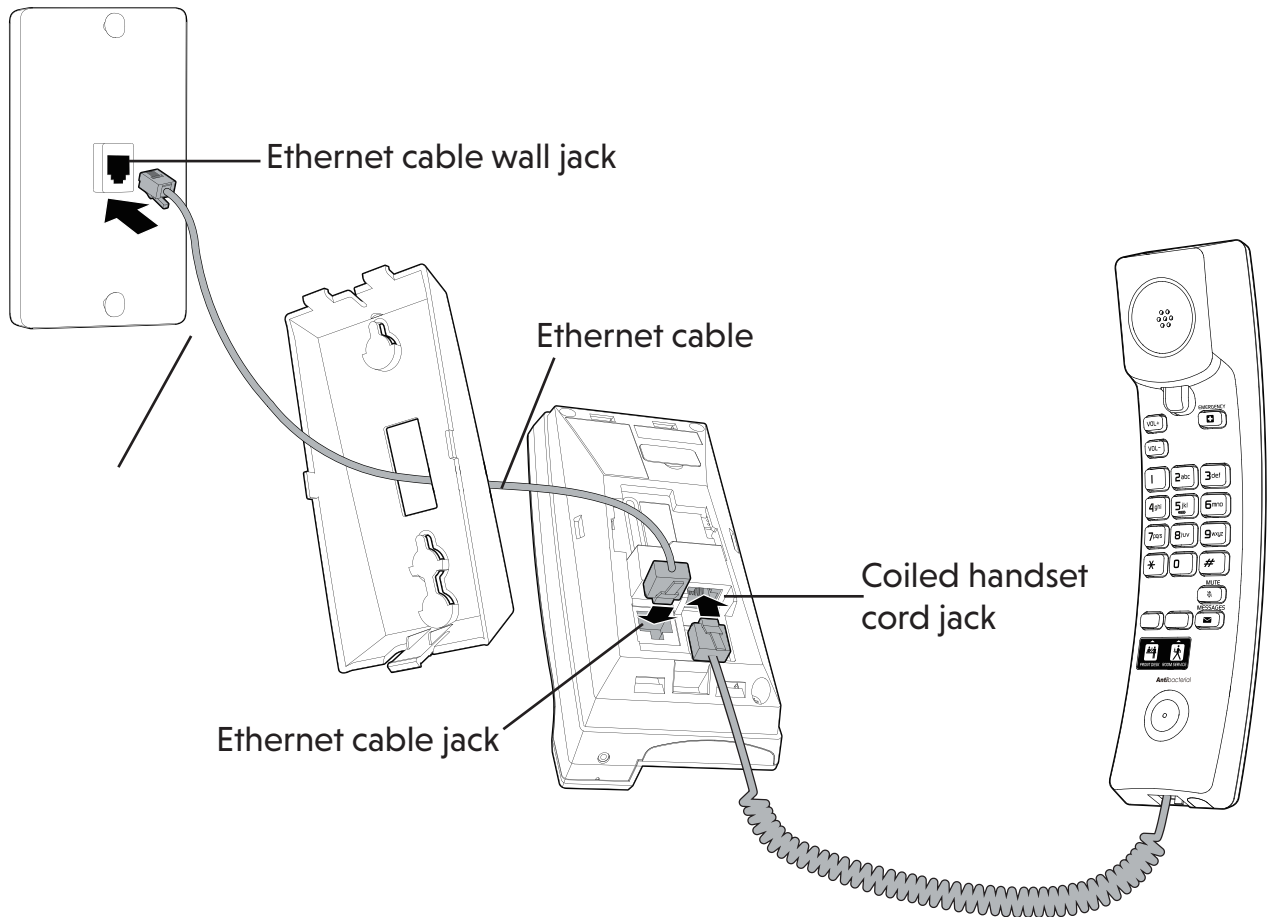

2. Put the corded handset aside. On the telephone base, place a coin in the slit of the wall mount clip and rotate a half turn (180°).

- It locks into place with the protruding edge pointing towards the upper edge of the telephone base. This protruding edge holds the corded handset when the phone is mounted on the wall.

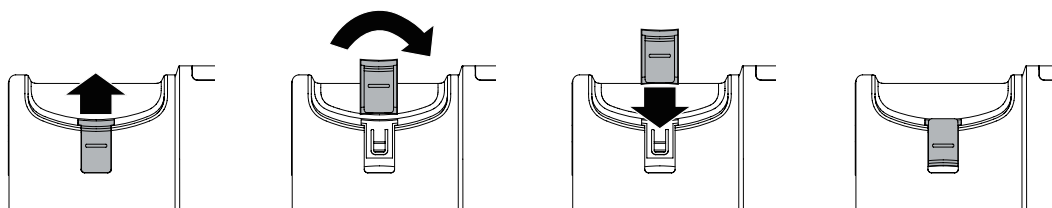

3. Turn the telephone base over with the bottom side facing up. Insert the mounting bracket into the two upper grooves and a lower groove on the telephone base until they lock securely. In the meantime, the ethernet cable sticks out from the rectangular hole. Besides, affix coil handset cord by fitting it in the circular hole at the bottom of the mounting bracket as shown below.

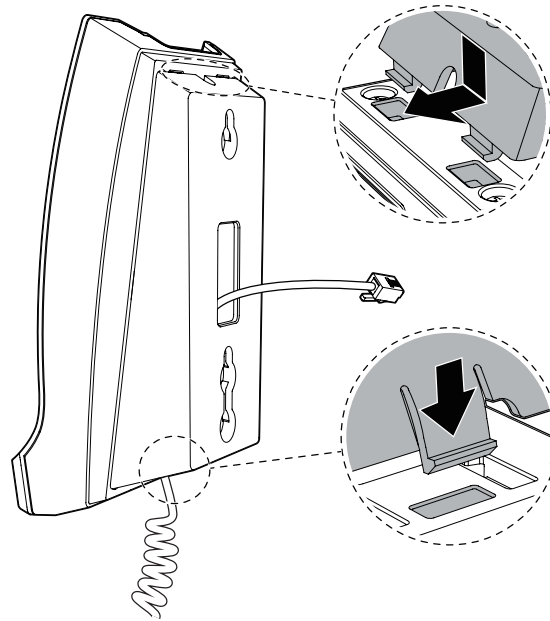

4. Mount the telephone base on the wall by positioning the eyelets on the mounting bracket against the mounting studs. Then, slide the telephone base down on both mounting studs until it locks into place.

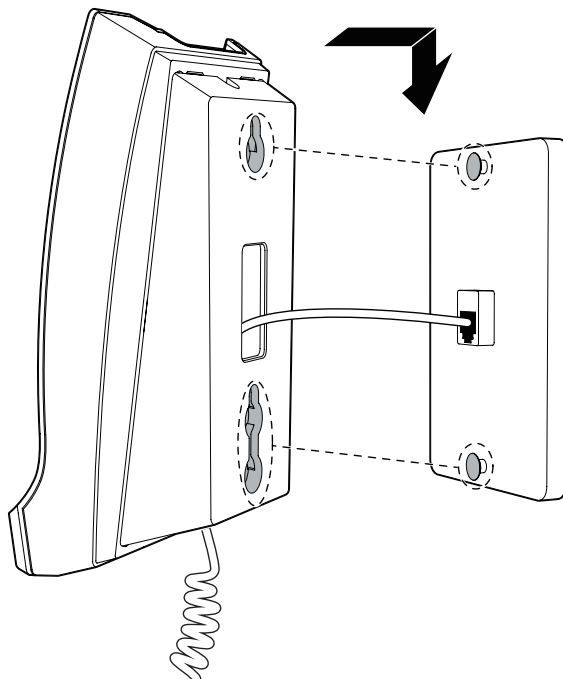

5. Place the corded handset on the telephone base cradle.

Telephone settings

SIP Corded Trimstyle 1-line CTM-S2315

Default settings are indicated by asterisks (*).

SETTING	OPTIONS	ADJUSTABLE BY
Handset earpiece volume	1, 2, 3, 4, 5, 6*, 7, 8	User and administrator
Speakerphone volume	1, 2, 3, 4, 5, 6*, 7, 8	User and administrator
Ringer tone	Tone 1*, Tone 2, Tone 3	Administrator only

All telephone settings are programmed through the administrative web portal.

Please refer to the SIP Phone Configuration Guide for details.



Telephone operation

SIP Corded Trimstyle 1-line CTM-S2315



RECEIVE A CALL

When there is an incoming call, the telephone rings and the **MESSAGE WAITING** LED flashes.

TO ANSWER A CALL:

Press **SPEAKER**  or lift the corded handset from the telephone base to answer. The **MESSAGE WAITING** LED illuminates when the phone line is in use. The **SPEAKER**  key illuminates when in speakerphone mode.





PLACE A CALL

Press **SPEAKER**  or lift the corded handset from the telephone base. Listen for a dial tone and then dial the desired number. The **MESSAGE WAITING** LED illuminates when the phone line is in use. The **SPEAKER**  key illuminates when in speakerphone mode.

END A CALL

Place the corded handset on the telephone base or press **SPEAKER**  if you are in speakerphone mode.

SPEAKERPHONE

1. During a call, press **SPEAKER**  to switch a call between the corded handset earpiece and the speakerphone. The **SPEAKER**  key illuminates when in use.
2. In idle mode, press **SPEAKER**  to activate the speakerphone mode and **SPEAKER**  key illuminates when in speakerphone mode.

VOLUME

Listening volume can be adjusted from the corded handset and ringer volume can be adjusted from the telephone base.

TO ADJUST THE LISTENING VOLUME:

During a call, press **VOL+ / VOL-** to adjust the listening volume. The next call returns to the default listening volume.

TO ADJUST THE RINGER VOLUME:

In idle mode, press **VOL+ / VOL-** to adjust the ringer volume.

MESSAGE WAITING INDICATOR





When a voice message is received, the **MESSAGE WAITING LED** on the telephone base flashes.

PLAY MESSAGES

Press **MESSAGES**  in idle mode to play messages.

MUTE

MUTE THE MICROPHONE

1. During a call, press **MUTE** .
 - The **MUTE**  key illuminates when the mute function is turned on. You can hear the party on the other end but they cannot hear you.
2. Press **MUTE**  again to resume the conversation.
 - The light on the **MUTE**  key turns off.

HOLD

TO PLACE A CALL ON HOLD:

During a call, press the switch hook then release it to hold a call or place a new call.

Appendix

Troubleshooting

If you have difficulty with the telephones, please try the suggestions below. For customer service, visit our website at www.vtechhotelphones.com or call 1-888-907-2007.

FOR CORDED TELEPHONE

QUESTION	SUGGESTION
The telephone does not work at all.	<ul style="list-style-type: none">• Make sure a Cat-5 network cable is plugged into the LAN port of the telephone base and the network wall jack with Power over Ethernet (PoE).• Unplug the Cat-5 network cable from the network wall jack. Wait for approximately 15 seconds, then plug it back in.• Disconnect the telephone base from the network wall jack and connect a different working telephone. If the other telephone does not work, the problem is probably in the wiring or network server.
There is no dial tone.	<ul style="list-style-type: none">• Try all the above suggestions.• The Cat-5 network cable may be defective. Install a new Cat-5 network cable.• Make sure your network is providing Power over Ethernet (PoE).• Disconnect the telephone base from the network wall jack and connect a different working telephone. If there is no dial tone on this telephone either, the problem is in your wiring or network server.• Make sure the initialization and system registration process completes. The speakerphone key blinks twice every second if there are errors with the initialization and system registration process.
I hear other calls when using the telephone.	<ul style="list-style-type: none">• Disconnect the telephone base from the network wall jack and connect a different working telephone. Check your server settings. If calls are still not clear, the problem is probably in the wiring or network server. Contact your telephone service provider (charges may apply).
The Speed Dial key does not work at all.	<ul style="list-style-type: none">• The Speed Dial key may not be properly programmed.

I cannot dial out.

- Try all the above suggestions.
- A prefix may be required for dialing some internal or external calls
- Make sure there is a dial tone before dialing. It is normal if the cordless handset takes a second or two to synchronize with the telephone base before producing a dial tone. Wait an extra second before dialing.
- Check your server settings. If other telephones in your hotel are having the same problem, the problem is in the wiring or network server. Contact your telephone service provider (charges may apply).

The telephone cannot register to the network server.

- Make sure your network is providing Power over Ethernet (PoE).
- Make sure the initialization and system registration process completes.
- If there is an error during the initialization and system registration process, the / **SPEAKER** key flashes twice every second. Disconnect the Cat-5 network cable from the network wall jack and connect it back into the network wall jack with Power over Ethernet (PoE) to start the initialization and system registration process again.

The telephone does not ring when there is an incoming call.

- Make sure the Cat-5 network cable is plugged into the LAN port of the telephone base and the network wall jack with Power over Ethernet (PoE).
- Check your server or telephone administrative settings.
- If other telephone in your hotel are having the same problem, the problem is in the wiring or network server. Contact your telephone service provider (charges may apply).
- Other electronic products such as HAM radios and other DECT phones can cause interference with your cordless phone. Try installing your phone as far away as possible from these types of electronic devices.
- The Cat-5 network cable may be defective. Install a new Cat-5 network cable.

QUESTION	SUGGESTION
<p>I hear other calls when using the telephone.</p>	<ul style="list-style-type: none"> • Disconnect the telephone base from the network wall jack and connect and connect a different working telephone. Check your server settings. If calls are still not clear, the problem is probably in the wiring or network server. Contact your telephone service provider (charges may apply).
<p>There is interference during a telephone conversation.</p>	<ul style="list-style-type: none"> • If your telephone is plugged in with a modem or a surge protector, plug the telephone (or modem/surge protector) into a different location. If this doesn't solve the problem, relocate your telephone or modem farther apart from each other, or use a different surge protector. • Disconnect the telephone base from the telephone wall jack. Plug in a different telephone. If calls are still not clear, the problem is probably in the wiring or telephone service. Contact your telephone service provider (charges may apply). • If other telephones in your hotel are having the same problem, the problem is in the wiring or telephone service. Contact your telephone service provider (charges may apply).
<p>The cordless handset beeps and is not performing normally.</p>	<ul style="list-style-type: none"> • Make sure the Cat-5 network cable is plugged into the LAN port of the telephone base and the network wall jack with Power over Ethernet (PoE). • Check your server or telephone administrative settings. • Disconnect the telephone base from the network wall jack and connect a different working telephone. If the other telephone has the same problem, the problem is in the wiring or network server. Contact your telephone service provider (charges may apply). • Other electronic products such as HAM radios and other DECT phones can cause interference with your cordless phone. Try installing your phone as far away as possible from these types of electronic devices.

VTech Hospitality Limited Warranty Program

VTech Communications, Inc., the manufacturer of VTech Hospitality Product ("Product"), warrants to the holder of a valid proof of purchase ("end user" or "you") that the Product and all accessories provided by VTech in the Product's package are free from defects in material and workmanship, pursuant to the following terms and conditions, when installed and used normally and in accordance with the Product's operating instructions. The limited warranty extends to the end user of this Product and applies only if such Product is purchased through a United States of America and/or Canadian distributor. The limited warranty period for this Product is determined based on the following:

5 YEARS – ANALOG MODELS

- All Classic Models – corded and cordless
- All Contemporary Models – corded and cordless
- All TrimStyle Models

2 YEARS – SIP NON-DISPLAY MODELS

- All Classic Models – corded and cordless
- All Contemporary Models – corded and cordless
- All TrimStyle Models

During the limited warranty period, VTech's authorized service representative will repair or replace, at VTech's option, without charge, a Product that is not free from defects in materials and workmanship. If VTech's authorized service representative repairs the Product, new or refurbished replacement parts may be used. If the Product is replaced, it may be replaced with a new or refurbished Product of the same or similar design. Repair

or replacement of Product, at VTech's option, is the exclusive remedy.

The limited warranty period for the Product begins on the date that the end user takes possession of the Product. This limited warranty also applies to repaired or replacement Products for a period of either: (a) 90 days from the date the repaired or replacement Product is shipped to you; or (b) the time remaining on the original limited warranty as described above; whichever is longer.

This limited warranty does not cover:

1. Product or parts that have been subjected to misuse, accident, shipping or other physical damage, improper installation, abnormal operation or handling, neglect, inundation, fire, water or other liquid intrusion; or
2. Product that has been damaged due to repair, alteration or modification by anyone other than an authorized service representative of VTech; or
3. Product to the extent that the problem experienced is caused by signal conditions, network reliability or cable or antenna systems; or
4. Product to the extent that the problem is caused by use with non-VTech accessories; or
5. Product whose warranty/quality stickers, product serial number plates or electronic serial numbers have been removed, altered or rendered illegible; or
6. Product purchased, used, serviced, or shipped for repair from outside the United States or Canada, or used for non-approved commercial or institutional purposes (including but not limited to Products used for rental purposes); or
7. Product returned without valid proof of purchase; or
8. Charges or costs incurred by the end user, and risk of loss or damage, in removing and shipping the Product, or for installation or

set up, adjustment of customer controls, and installation or repair of systems outside the unit.

9. Line cords or coil cords, plastic overlays, connectors, power adapters and batteries, if the Product is returned without them. VTech will charge the end user at then-current prices for each of the missing items.

10. NiCd or NiMH handset batteries, or power adapters, which, under all circumstances, are covered by a one (1) year warranty only.

Except as provided by applicable law, you assume the risk of loss or damage during transit and transportation and are responsible for delivery or handling charges incurred in the transport of Product(s) to the service location. VTech's authorized service representative will return repaired or replaced product under this limited warranty to you, transportation, delivery and handling charges prepaid. VTech assumes no risk for damage or loss of the Product in transit.

If the Product failure is not covered by this limited warranty, or proof of purchase does not meet the terms of this limited warranty, VTech will notify you and will request that you authorize the cost of repair and return shipping costs for the repair of Products that not covered by this limited warranty. You must pay for the cost of repair and return shipping costs for the repair of Products that are not covered by this limited warranty.

OTHER LIMITATIONS

This warranty is the complete and exclusive agreement between you and VTech. It supersedes all other written or oral communications related to this Product. VTech provides no other warranties for this Product, whether express or implied, oral or written, or statutory. The warranty exclusively describes all of VTech's responsibilities regarding the Product. No one is authorized to make modifications to this warranty and you should not rely on any such modification.

VTech's liability to end user hereunder shall not exceed the purchase price of the Product. In no event shall VTech be liable for any indirect, special, incidental, consequential, or similar damages (including, but not limited to lost profits or revenue, inability to use the product, or other associated equipment, the cost of substitute equipment, and claims by third parties) resulting from the use of this Product. Some states/provinces do not allow the exclusion or limitation of incidental or consequential damages, so the above limitation or exclusion may not apply to you.

This warranty gives you specific legal rights, and you also have other rights which vary from state to state or province to province.

Appendix

FCC, ACTA and IC regulations

FCC PART 15

This equipment has been tested and found to comply with the limits for a Class B digital device, pursuant to part 15 of the FCC Rules.

These limits are designed to provide reasonable protection against harmful interference in a residential installation.

This equipment generates, uses and can radiate radio frequency energy and, if not installed and used in accordance with the instructions, may cause harmful interference to radio communications. However, there is no guarantee that interference will not occur in a particular installation. If this equipment does cause harmful interference to radio or television reception, which can be determined by turning the equipment off and on, the user is encouraged to try to correct the interference by one or more of the following measures:

- Reorient or relocate the receiving antenna.
- Increase the separation between the equipment and receiver.
- Connect the equipment into an outlet on a circuit different from that to which the receiver is connected.
- Consult the dealer or an experienced radio/TV technician for help.

Changes or modifications to this equipment not expressly approved by the party responsible for compliance could void the user's authority to operate the equipment.

This device complies with Part 15 of the FCC rules. Operation is subject to the following two conditions: (1) this device may not cause harmful interference, and (2) this device must accept any interference received, including interference that may cause undesired operation.

This Class B digital apparatus complies with Canadian ICES-003. CAN ICES-3 (B)/NMB-3(B)

FCC PART 68 AND ACTA

This equipment complies with Part 68 of the FCC rules and with technical requirements adopted by the Administrative Council for Terminal Attachments (ACTA). The label on the back or bottom of this equipment contains, among other things, a product identifier in the format US:AAAKXNANXXXX. This identifier must be provided to your telephone service provider upon request.

The plug and jack used to connect this equipment to premises wiring and the telephone network must comply with applicable Part 68 rules and technical requirements adopted by ACTA. A compliant telephone cord and modular plug is provided with this product. It is designed to be connected to a compatible modular jack that is also compliant. An RJ45 jack should normally be used for connecting to a single line. See the installation instructions in the user's manual.

The Ringer Equivalence Number (REN) is used to determine how many devices you may connect to your telephone line and still have them ring when you are called. The REN for this product is encoded as the 6th and 7th characters following the US: in the product identifier (e.g., if ## is 03, the REN is 0.3). In most, but not all areas, the sum of all RENs should be five (5.0) or less. For more information, please contact your telephone service provider.

This equipment may not be used with Party Lines. If you have specially wired alarm dialing equipment connected to your telephone line, ensure the connection of this equipment does not disable your alarm equipment. If you have questions about what will disable alarm equipment, consult your telephone service provider or a qualified installer.

If this equipment is malfunctioning, it must be unplugged from the modular jack until the problem has been corrected. Repairs to this telephone equipment can only be made

by the manufacturer or its authorized agents. For repair procedures, follow the instructions outlined under **VTech Hospitality limited warranty program** in the user's manual.

To ensure safety of users, the FCC has established criteria for the amount of radio frequency energy of the product. This product has been tested and found to comply with the FCC criteria. The handset may be safely held against the ear of the user. The telephone base shall be installed and used such that parts of the user's body other than the hands are maintained at a distance of approximately 20 cm (8 inches) or more.

If this equipment is causing harm to the telephone network, your telephone service provider may temporarily discontinue your telephone service. Your telephone service provider is required to notify you before interrupting service. If advance notice is not practical, you will be notified as soon as possible. You will be given the opportunity to correct the problem and your telephone service provider is required to inform you of your right to file a complaint with the FCC. Your telephone service provider may make changes in its facilities, equipment, operation, or procedures that could affect the proper functioning of this product. Your telephone service provider is required to notify you if such changes are planned.

If this product is equipped with a corded or cordless handset, it is hearing aid compatible.

If this product has memory dialing locations, you may choose to store emergency telephone numbers (e.g., police, fire, medical) in these locations. If you do store or test emergency numbers, please:

Remain on the line and briefly explain the reason for the call before hanging up.

Perform such activities in off-peak hours, such as early morning or late evening.

When the adjunct is used with a leased system, permission of the owner of the equipment

must be obtained for connection of the adjunct because modification of the host system is often required.

This product can only be connected to the host equipment and never directly to the network.

INDUSTRY CANADA

This product meets the applicable Innovation, Science and Economic Development Canada technical specifications.

The Ringer Equivalence Number (REN) is an indication of the maximum number of devices allowed to be connected to a telephone interface. The termination of an interface may consist of any combination of devices subject only to the requirement that the sum of the RENs of all the devices not exceed five.

Le présent matériel est conforme aux spécifications techniques applicables d'Innovation, Sciences et Développement économique Canada.

L'indice d'équivalence de la sonnerie (IES) sert à indiquer le nombre maximal de terminaux qui peuvent être raccordés à une interface téléphonique. La terminaison d'une interface peut consister en une combinaison quelconque de dispositifs, à la seule condition que la somme d'indices d'équivalence de la sonnerie de tous les dispositifs n'excède pas cinq.

ISED WARNING

This device complies with Innovation, Science, and Economic Development Canada licence-exempt RSS standard(s). Operation is subject to the following two conditions:

- (1) this device may not cause interference, and
- (2) this device must accept any interference, including interference that may cause undesired operation of the device.

Privacy of communications may not be ensured when using this telephone.

The device is in compliance with RF exposure guidelines. Users can obtain Canadian information on RF exposure and compliance. The minimum distance from body to use the device is 20cm.

Avertissement ISED

Cet appareil est compatible avec la licence de l'Innovation, la Science et le développement économique du Canada à l'exemption des normes RSS. Le fonctionnement est sujet aux deux (2) conditions suivantes :

- (1) Cet appareil peut ne pas causer de l'interférence, et
- (2) Cet appareil doit accepter l'interférence, incluant de l'interférence qui peut causer un mauvais fonctionnement de cet appareil.

La confidentialité des communications peut ne pas être garantie lors de l'utilisation de ce téléphone.

Le présent appareil est conforme aux directives d'exposition aux RF. Après examen de ce matériel aux conformité ou aux limites d'intensité de champ RF, les utilisateurs peuvent sur l'exposition aux radiofréquences et la conformité and compliance d'acquérir les informations correspondantes. La distance minimale du corps à utiliser le dispositif est de 20cm.

Appendix

Operating range

The cordless telephone operates with the maximum power allowed by the Federal Communications Commission (FCC). Even so, the cordless handset and telephone base can communicate over only a certain distance - which can vary with the locations of the telephone base, cordless handset, the weather, and the layout of the hotel.

When the cordless handset is out of range while on a call, the cordless handset rapidly beeps three times.

If there is a call while the handset is out of range, it may not ring, or if it does ring, the call may not connect well when you answer the call. Move closer to the telephone base to answer the call.

If the handset moves out of range during a telephone conversation, there may be interference.

To improve reception, move closer to the telephone base.

Precautions for users of implanted cardiac pacemakers

Cardiac pacemakers (applies only to digital cordless telephones):

Wireless Technology Research, LLC (WTR), an independent research entity, led a multidisciplinary evaluation of the interference between portable wireless telephones and implanted cardiac pacemakers. Supported by the U.S. Food and Drug Administration, WTR recommends to physicians that:

Pacemaker patients

- Should keep wireless telephones at least six inches from the pacemaker.
- Should NOT place wireless telephones directly over the pacemaker, such as in a breast pocket, when it is turned ON.
- Should use the wireless telephone at the ear opposite the pacemaker.

WTR's evaluation did not identify any risk to bystanders with pacemakers from other persons using wireless telephones.

Appendix

Maintenance

TAKING CARE OF YOUR TELEPHONE

Your telephone contains sophisticated electronic parts, so it must be treated with care.

AVOID ROUGH TREATMENT

Place the handset down gently. Save the original packing materials to protect your telephone if you ever need to ship it.

AVOID WATER

Your telephone can be damaged if it gets wet. Do not use the handset outdoors in the rain, or handle it with wet hands. Do not install the telephone base near a sink, bathtub or shower.

ELECTRICAL STORMS

Electrical storms can sometimes cause power surges harmful to electronic equipment. For your own safety, take caution when using electrical appliances during storms.

CLEANING YOUR TELEPHONE

Your telephone has a durable plastic casing that should retain its luster for many years. Clean it only with a soft cloth slightly dampened with water or mild soap. Do not use excess water or cleaning solvents of any kind.

Remember that electrical appliances can cause serious injury if used when you are wet or standing in the water. If the telephone base should fall into the water, DO NOT RETRIEVE IT UNTIL YOU UNPLUG THE NETWORK CABLE FROM THE WALL. Then remove the telephone by the unplugged cords.

Disclaimer and Limitation of Liability

VTech Communications, Inc. and its suppliers assume no responsibility for any damage or loss resulting from the use of this user's manual. VTech Communications, Inc. and its suppliers assume no responsibility for any loss or claims by third parties that may arise through the use of this product. VTech Communications, Inc. and its suppliers assume no responsibility for any damage or loss caused by deletion of data as a result of malfunction, or repairs. Be sure to make backup copies of important data on other media to protect against data loss.

Company: VTech Communications, Inc.

Address: 9020 SW Washington Square Road., Suite 555, Tigard, OR 97223, United States

Phone: 1 (888) 907-2007

REMEMBER THAT ELECTRICAL APPLIANCES CAN CAUSE SERIOUS INJURY IF USED WHEN YOU ARE WET OR STANDING IN WATER. IF THE TELEPHONE BASE SHOULD FALL INTO WATER, DO NOT RETRIEVE IT UNTIL YOU UNPLUG THE POWER CORD AND/OR ETHERNET CABLE FROM THE WALL. THEN REMOVE THE TELEPHONE BY THE UNPLUGGED CORDS.

Appendix

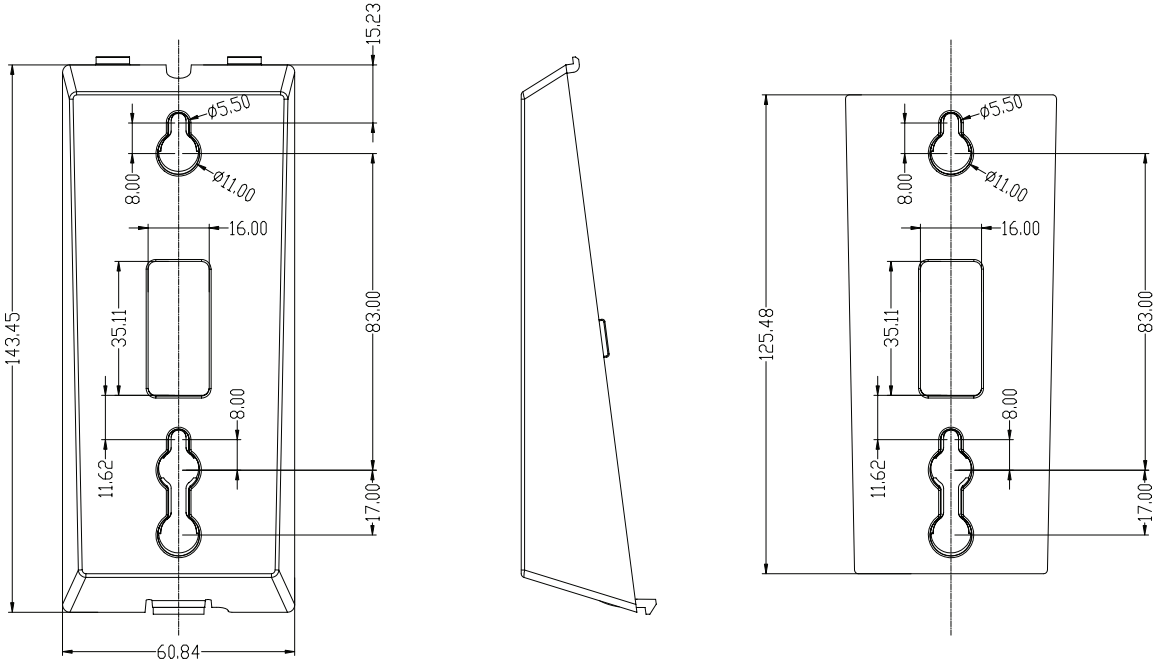

Single Drawing(Scale 1:1)

Technical specification

SIP Corded Trimstyle - CTM-S2315

Power requirement	PoE class 2 powered (48V)
Message waiting signal	Steady/periodic high voltage pulse or periodic low voltage pulse
Speed Dial memory	Telephone handset: up to 8 memory locations; up to 16 digits
Size	Telephone base: 175.27 x 74.15 x 162.95
	Corded handset: 211.79 x 74.14 x 69.43

Index

C

Cardiac pacemakers 22

E

End a call 13

F

FCC, ACTA and IC regulations 19

H

Hold a call 13

I

Important safety instructions 2

Installation 9, 10

L

Limited Warranty 17

Listening volume 13

M

Messages 13

Message Waiting LED 13

Mute 13

P

Place a call 13

R

Receive a call 13

Ringer tone 12

Ringer volume 13

S

Speakerphone 13

T

Technical specification 25

Troubleshooting 14

V

Volume 13

Listening 13

Ringer 13

W

Wall mount 10



Specifications are subject to change without notice.
Copyright © 2020
VTech Telecommunications, Inc.
All rights reserved. 10/20.
CTM-S2315_MUG_V1_CEC_20201013