



Valued Quality. Delivered.

TEST REPORT

Report Number: 16080588HKG-001

Application
for
Original Grant of 47 CFR Part 15 Certification
New Family of RSS-247 Issue 1 Equipment Certification

Video Monitor

FCC ID: EW780-9899-00

IC: 1135B-80989900

Prepared and Checked by:

Approved by:

Signed On File

Yao Xin Lu, Josie
Engineer

Koo Wai Ip
Assistant Supervisor
December 20, 2016

- Intertek's standard Terms and Conditions can be obtained at our website: <http://www.intertek.com/terms/>.
- The test report only allows to be revised within the retention period unless further standard or the requirement was noticed.
- This report is for the exclusive use of Intertek's Client and is provided pursuant to the agreement between Intertek and its Client. Intertek's responsibility and liability are limited to the terms and conditions of the agreement. Intertek assumes no liability to any party, other than to the Client in accordance with the agreement, for any loss, expense or damage occasioned by the use of this report. Only the Client is authorized to permit copying or distribution of this report and then only in its entirety. Any use of the Intertek name or one of its marks for the sale or advertisement of the tested material, product or service must first be approved in writing by Intertek. The observations and test results in this report are relevant only to the sample tested. This report by itself does not imply that the material, product, or service is or has ever been under an Intertek certification program.
- © 2016 Intertek

Intertek Testing Services Hong Kong Ltd.

2/F., Garment Centre, 576 Castle Peak Road, Kowloon, Hong Kong.
Tel: (852) 2173 8888 Fax: (852) 2785 5487 Website: www.hk.intertek-etlsemko.com

INTERTEK TESTING SERVICES

GENERAL INFORMATION

Applicant Name:	VTech Telecommunications Ltd.
Applicant Address:	23/F., Tai Ping Industrial Centre, Block 1, 57 Ting Kok Road, Tai Po, Hong Kong.
FCC Specification Standard:	FCC Part 15, October 1, 2015 Edition
FCC ID:	EW780-9899-00
FCC Model(s):	VM981 PU, VM981-abc PU, VM991 PU, VM991-abc PU
IC Specification Standard:	RSS-247 Issue 1, May 2015 RSS-Gen Issue 4, December 2014
IC:	1135B-80989900
PMN:	VM981 PU, VM991 PU
HVIN:	VM981 PU, VM991 PU
Type of EUT:	Spread Spectrum Transmitter
Description of EUT:	Video Monitor
Serial Number:	N/A
Sample Receipt Date:	August 10, 2016
Date of Test:	December 09, 2016
Report Date:	December 20, 2016
Environmental Conditions:	Temperature: +10 to 40°C Humidity: 10 to 90%

INTERTEK TESTING SERVICES

Table of Contents

1.0 Test Results Summary & Statement of Compliance	4
1.1 Summary of Test Results	4
1.2 Statement of Compliance	4
2.0 General Description	6
2.1 Product Description	6
2.2 Test Methodology	7
2.3 Test Facility	7
2.4 Related Submittal(s) Grants	7
3.0 System Test Configuration	9
3.1 Justification	9
3.2 EUT Exercising Software	10
3.3 Details of EUT and Description of Accessories	11
3.4 Measurement Uncertainty	11
4.0 Test Results	13
4.1 Maximum Conducted Output Power at Antenna Terminals	13
4.2 Minimum 6dB RF Bandwidth	15
4.3 Maximum Power Spectral Density	24
4.4 Out of Band Conducted Emissions	33
4.5 Field Strength Calculation	46
4.6 Transmitter Radiated Emissions in Restricted Bands and Spurious Emissions	47
4.6.1 Radiated Emission Configuration Photograph	47
4.6.2 Radiated Emission Data	47
4.6.3 Radiated Emission Test Setup	67
4.6.4 Transmitter Duty Cycle Calculation	68
4.7 AC Power Line Conducted Emission	69
4.7.1 AC Power Line Conducted Emission Configuration Photograph	69
4.7.2 AC Power Line Conducted Emission Data	69
4.7.3 Conducted Emission Test Setup	82
5.0 Equipment List	84

INTERTEK TESTING SERVICES

**EXHIBIT 1
TEST RESULTS SUMMARY & STATEMENT OF COMPLIANCE**

INTERTEK TESTING SERVICES

1.0 Test Results Summary & Statement of Compliance

1.1 Summary of Test Results

Test Items	FCC Part 15 Section	RSS-247/ RSS-Gen# Section	Results	Details see section
Antenna Requirement	15.203	7.1.2#	Pass	2.1
Max. Conducted Output Power (average)	15.247(b)(3)&(4)	5.4(4)	Pass	4.1
Min. 6dB RF Bandwidth	15.247(a)(2)	5.2(1)	Pass	4.2
Max. Power Density (average)	15.247(e)	5.2(2)	Pass	4.3
Out of Band Antenna Conducted Emission	15.247(d)	5.5	Pass	4.4
Radiated Emission in Restricted Bands and Spurious Emissions	15.247(d), 15.209 & 15.109	5.5	Pass	4.6
AC Power Line Conducted Emission	15.207 & 15.107	7.2.4#	Pass	4.7

Note: Pursuant to FCC Part 15 Section 15.215(c), the 20dB bandwidth of the emission was contained within the frequency band designated (mentioned as above) which the EUT operated. The effects, if any, from frequency sweeping, frequency hopping, other modulation techniques and frequency stability over expected variations in temperature and supply voltage were considered.

1.2 Statement of Compliance

The equipment under test is found to be complying with the following standard:

FCC Part 15, October 1, 2015 Edition
RSS-247 Issue 1, May 2015
RSS-Gen Issue 4, November 2014

INTERTEK TESTING SERVICES

**EXHIBIT 2
GENERAL DESCRIPTION**

INTERTEK TESTING SERVICES

2.0 General Description

2.1 Product Description

The VM981 PU is a Video Monitor.

The Equipment Under Test (EUT) operates at frequency range of 2412MHz to 2462MHz with 11 channels. For 802.11g mode, it operates at frequency range of 2412.000MHz to 2462.000MHz with 11 channels. It transmits via Orthogonal Frequency Division Multiplexing (OFDM) modulation. Maximum bit rate can be up to 54Mbps. For 802.11n (with 20MHz bandwidth) mode, it operates at frequency range of 2412.000MHz to 2462.000MHz with 11 channels. It transmits via Orthogonal Frequency Division Multiplexing (OFDM) modulation. Maximum bit rate can support up to 65Mbps. For 802.11n (with 40MHz bandwidth) mode, it operates at frequency range of 2422.000MHz to 2452.000MHz with 7 channels. It transmits via Orthogonal Frequency Division Multiplexing (OFDM) modulation. Maximum bit rate can support up to 65Mbps.

The EUT is power by a 100-240VAC to 5VDC 1.5A adaptor.

For FCC, the Model(s): VM981-abc PU, VM991 PU and VM991-abc PU are the same as the Model: VM981 PU in electronics/electrical designs including software & firmware, PCB layout and construction design/physical design/enclosure. The only differences between these models are color and model number to be sold for marketing purpose. Suffix (a,b,c) indicates any alphanumeric character or blank is presenting no. of IP camera, color of the enclosure and packing type or additional different ID of IP camera respectively.

For IC, the Model(s): VM991 PU is the same as the Model: VM981 PU in electronics/electrical designs including software & firmware, PCB layout and construction design/physical design/enclosure. The only differences between these models are color and model number to be sold for marketing purpose.

The antenna(s) used in the EUT is integral, and the test sample is a prototype.

The circuit description is saved with filename: descri.pdf.

INTERTEK TESTING SERVICES

2.2 Test Methodology

Both AC power line-conducted and radiated emission measurements were performed according to the procedures in ANSI C63.10 (2013). Preliminary radiated scans and all radiated measurements were performed in radiated emission test sites. All Radiated tests were performed at an antenna to EUT distance of 3 meters, unless stated otherwise in the "**Justification Section**" of this Application. Antenna port conducted measurements were performed according to ANSI C63.10 (2013) and KDB Publication No.558074 D01 v03r05 (08-April-2016) and 662911 D01 Multiple Transmitter Output v02r01 (31-October-2013). All other measurements were made in accordance with the procedures in 47 CFR Part 2 and RSS-Gen Issue 4 (2014).

2.3 Test Facility

The radiated emission test site and antenna port conducted measurement facility used to collect the radiated data and conductive data are at Workshop No. 3, G/F., World-Wide Industrial Centre, 43-47 Shan Mei Street, Fo Tan, Sha Tin, N.T., Hong Kong. This test facility and site measurement data have been fully placed on file with the FCC and Industry Canada No.: 2042V-1.

2.4 Related Submittal(s) Grants

This is a single application for certification of a transceiver (WiFi portion)

INTERTEK TESTING SERVICES

**EXHIBIT 3
SYSTEM TEST CONFIGURATION**

INTERTEK TESTING SERVICES

3.0 System Test Configuration

3.1 Justification

For radiated emissions testing, the equipment under test (EUT) was setup to transmit / receive continuously to simplify the measurement methodology. Care was taken to ensure proper power supply voltages during testing. During testing, all cables (if any) were manipulated to produce worst case emissions.

The EUT was powered by a 100-240VAC to 5VDC 1.5A adaptor.

For the measurements, the EUT was attached to a plastic stand if necessary and placed on the wooden turntable. If the base unit attached to peripherals, they were connected and operational (as typical as possible).

The signal was maximized through rotation and placement in the three orthogonal axes. The antenna height and polarization were varied during the search for maximum signal level. The antenna height was varied from 1 to 4 meters. Radiated emissions were taken at three meters unless the signal level was too low for measurement at that distance. If necessary, a pre-amplifier was used and/or the test was conducted at a closer distance.

For any intentional radiator powered by AC power line, measurements of the radiated signal level of the fundamental frequency component of the emission was performed with the supply voltage varied between 85% and 115% of the nominal rated supply voltage.

Radiated emission measurement for transmitter were performed from the lowest radio frequency signal generated in the device which is greater than 9 kHz to the tenth harmonic of the highest fundamental frequency or to 40 GHz, whichever is lower.

Emission that are directly caused by digital circuits in the transmit path and transmitter portion were measured, and the limit are according to FCC Part 15 Section 15.209. Digital circuitries used to control additional functions other than the operation of the transmitter are subject to FCC Part 15 Section 15.109.

INTERTEK TESTING SERVICES

3.1 Justification – Cont'd

Detector function for radiated emissions was in peak mode. Average readings, when required, were taken by measuring the duty cycle of the equipment under test and subtracting the corresponding amount in dB from the measured peak readings. A detailed description for the calculation of the average factor can be found in section 4.8.3.

Determination of pulse desensitization was made according to *Hewlett Packard Application Note 150-2, Spectrum Analysis... Pulsed RF*. The effective period (Teff) was referred to Exhibit 4.8.3. With the resolution bandwidth 1MHz and spectrum analyzer IF bandwidth 3dB, the pulse desensitization factor was 0dB.

For AC line conducted emission test, the EUT along with its peripherals were placed on a 1.0m(W)x1.5m(L) and 0.8m in height wooden table and the EUT was adjusted to maintain a 0.4 meter space from a vertical reference plane. The EUT was connected to power mains through a line impedance stabilization network (LISN), which provided 50ohm coupling impedance for measuring instrument. The LISN housing, measuring instrument case, reference ground plane, and vertical ground plane were bounded together. The excess power cable between the EUT and the LISN was bundled.

All connecting cables of EUT and peripherals were manipulated to find the maximum emission.

Different data rates have been tested. Worst case is reported only.

All relevant operation modes have been tested, and the worst case data is included in this report.

All data rates were tested under normal mode of WiFi. Only the worst-case data is shown in the report for DSSS and OFDM

3.2 EUT Exercising Software

The EUT exercise program (if any) used during radiated and conducted testing was designed to exercise the various system components in a manner similar to a typical use.

INTERTEK TESTING SERVICES

3.3 Details of EUT and Description of Accessories

Details of EUT:

An AC adaptor (provided with the unit) was used to power the device. Their description are listed below.

- (1) An AC adaptor (100-240VAC to 5VDC 1.5A, Model: S012BEU0500150)
(Supplied by Client)

Description of Accessories:

- (1) Baby Units, Model no. : VM981 BU, VM991 BU (Provided by Client)
- (2) 1 X USB cable of 1m in length (Supplied by Client)
- (3) Notebook (HP Probook 430) (Provided by Intertek)
- (4) 1 X 4GB SD Card (Provided by Intertek)

3.4 Measurement Uncertainty

When determining of the test conclusion, the Measurement Uncertainty of test at a level of confidence of 95% has been considered. The values of the Measurement uncertainty for radiated emission test and RF conducted measurement test are $\pm 5.3\text{dB}$ and $\pm 0.99\text{dB}$ respectively. The value of the Measurement uncertainty for conducted emission test is $\pm 4.2\text{dB}$.

Uncertainty and Compliance - Unless the standard specifically states that measured values are to be extended by the measurement uncertainty in determining compliance, all compliance determinations are based on the actual measured value.

INTERTEK TESTING SERVICES

**EXHIBIT 4
TEST RESULTS**

INTERTEK TESTING SERVICES

4.0 Test Results

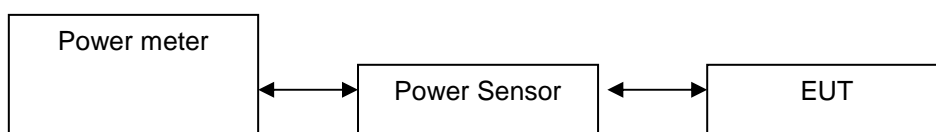

4.1 Maximum Conducted (peak) Output Power at Antenna Terminals

The antenna port of the EUT was connected to the input of a spectrum analyzer.

- The antenna power of the EUT was connected to the input of a power meter. Power was read directly and cable loss correction was added to the reading to obtain power at the EUT antenna terminals. The measurement procedure 9.1.2 was used.
- The EUT should be configured to transmit continuously (at a minimum duty cycle of 98%) at full power over the measurement duration. The measurement procedure AVG1 was used.

IEEE 802.11b (DSSS, 1 Mbps) Antenna Gain = 2 dBi		
Frequency (MHz)	Output in dBm	Output in mWatt
Low Channel: 2412	16.0	39.811
Middle Channel: 2437	16.1	40.738
High Channel: 2462	16.2	41.687

IEEE 802.11g (OFDM, 6 Mbps) Antenna Gain = 2 dBi		
Frequency (MHz)	Output in dBm	Output in mWatt
Low Channel: 2412	23.5	223.872
Middle Channel: 2437	23.6	229.087
High Channel: 2462	23.5	223.872

IEEE 802.11n (20MHz) (OFDM, MCS0) Antenna Gain = 2 dBi		
Frequency (MHz)	Output in dBm	Output in mWatt
Low Channel: 2412	22.5	177.828
Middle Channel: 2437	22.6	181.970
High Channel: 2462	22.4	173.780

INTERTEK TESTING SERVICES

4.1 Maximum Conducted Output Power at Antenna Terminals – Cont'd

IEEE 802.11n (40MHz) (OFDM, MCS0) Antenna Gain = 2 dBi		
Frequency (MHz)	Output in dBm	Output in mWatt
Low Channel: 2422	22.6	181.970
Middle Channel: 2437	22.6	181.970
High Channel: 2452	22.3	169.824

Cable loss : 0.5 dB External Attenuation : 0 dB

Cable loss, external attenuation: included in OFFSET function
 added to SA raw reading

IEEE 802.11b (DSSS, 1 Mbps)
max. conducted (average) output level = 16.2 dBm

IEEE 802.11g (OFDM, 9 Mbps)
max. conducted (average) output level = 23.6 dBm

IEEE 802.11n (20MHz) (OFDM, MCS0)
max. conducted (average) output level = 22.6 dBm

IEEE 802.11n (40MHz) (OFDM, MCS0)
max. conducted (average) output level = 22.6 dBm

Limits:

1W (30dBm) for antennas with gains of 6dBi or less

___W (___dBm) for antennas with gains more than 6dBi

The plots of conducted output power are saved as below.

INTERTEK TESTING SERVICES

4.2 Minimum 6dB RF Bandwidth

The antenna port of the EUT was connected to the input of a spectrum analyzer. The EBW measurement procedure was used. A PEAK output reading was taken, a DISPLAY line was drawn 6dB lower than PEAK level. The 6dB bandwidth was determined from where the channel output spectrum intersected the display line.

IEEE 802.11b (DSSS, 1 Mbps)	
Frequency (MHz)	6dB Bandwidth (MHz)
Low Channel: 2412	10.24
Middle Channel: 2437	10.24
High Channel: 2462	10.24

IEEE 802.11g (OFDM, 6 Mbps)	
Frequency (MHz)	6dB Bandwidth (MHz)
Low Channel: 2412	16.8
Middle Channel: 2437	16.8
High Channel: 2462	16.8

IEEE 802.11n (20MHz) (OFDM, MCS0)	
Frequency (MHz)	6dB Bandwidth (MHz)
Low Channel: 2412	18.0
Middle Channel: 2437	18.0
High Channel: 2462	18.0

IEEE 802.11n (40MHz) (OFDM, MCS0)	
Frequency (MHz)	6dB Bandwidth (MHz)
Low Channel: 2422	36.72
Middle Channel: 2437	36.72
High Channel: 2452	36.72

Limits

6 dB bandwidth shall be at least 500kHz

The plots of 6dB RF bandwidth and occupied bandwidth are saved as below.

INTERTEK TESTING SERVICES

Plots of 6dB RF bandwidth

802.11b, Lowest Channel

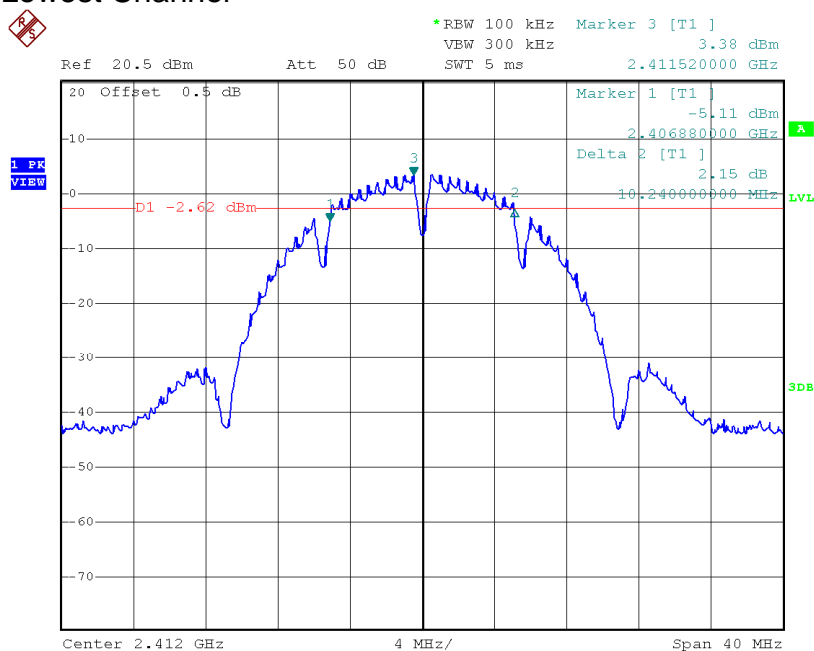

802.11b, Middle Channel

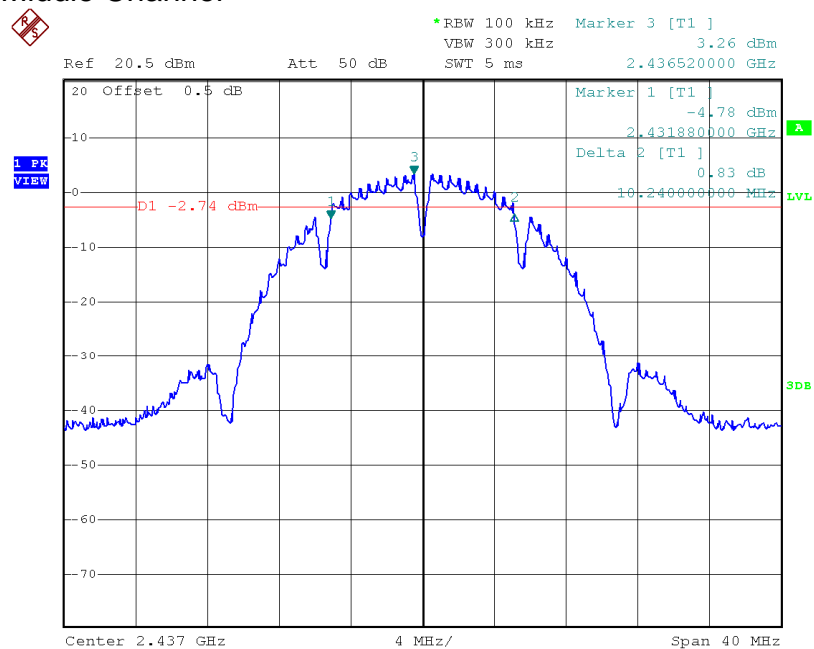

INTERTEK TESTING SERVICES

Plots of 6dB RF bandwidth

802.11b, Highest Channel

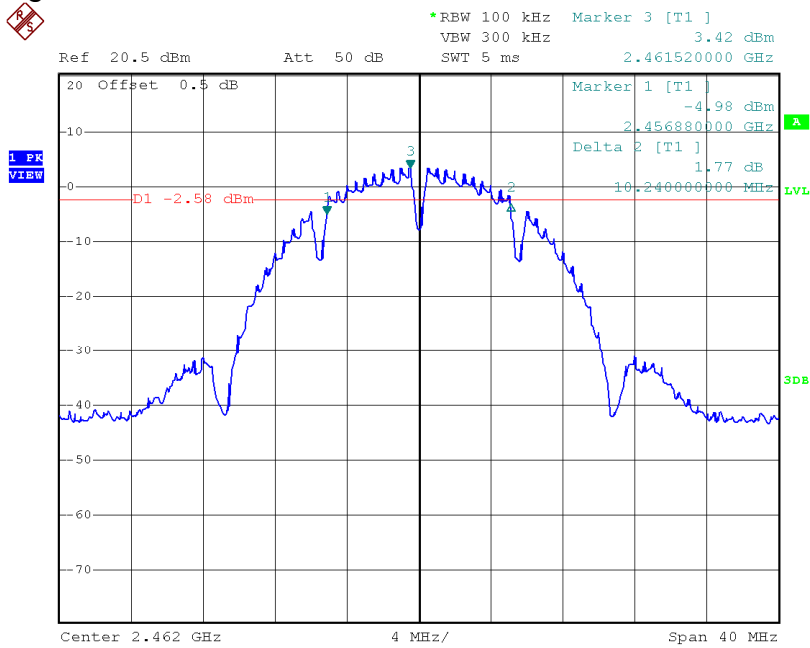

INTERTEK TESTING SERVICES

Plots of 6dB RF bandwidth

802.11g, Lowest Channel

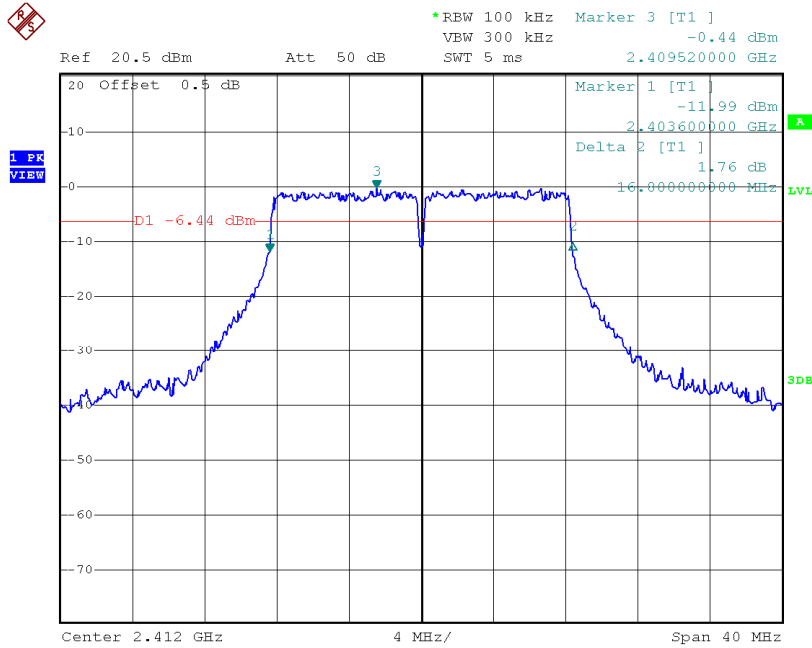

802.11g, Middle Channel

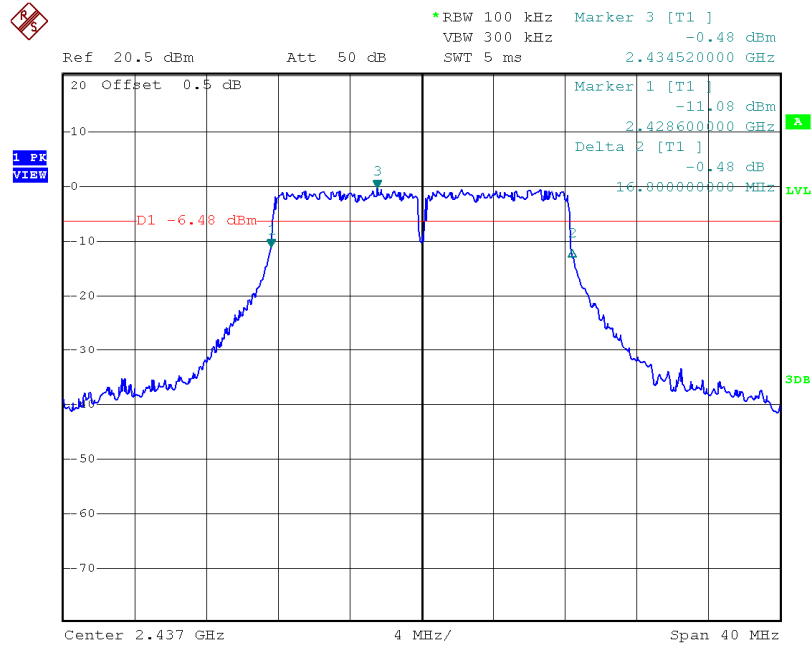

INTERTEK TESTING SERVICES

Plots of 6dB RF bandwidth

802.11g, Highest Channel

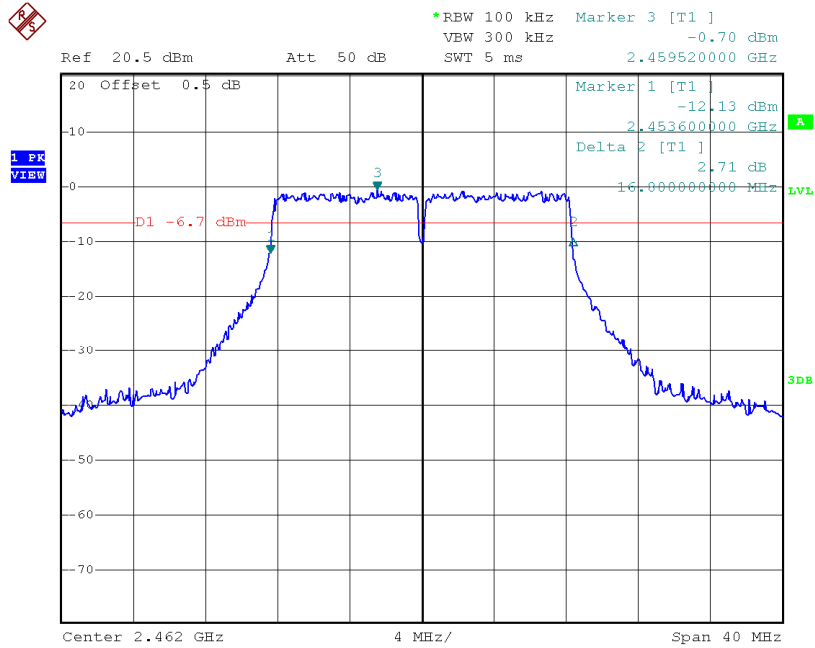

INTERTEK TESTING SERVICES

Plots of 6dB RF bandwidth 802.11n(20M), Lowest Channel

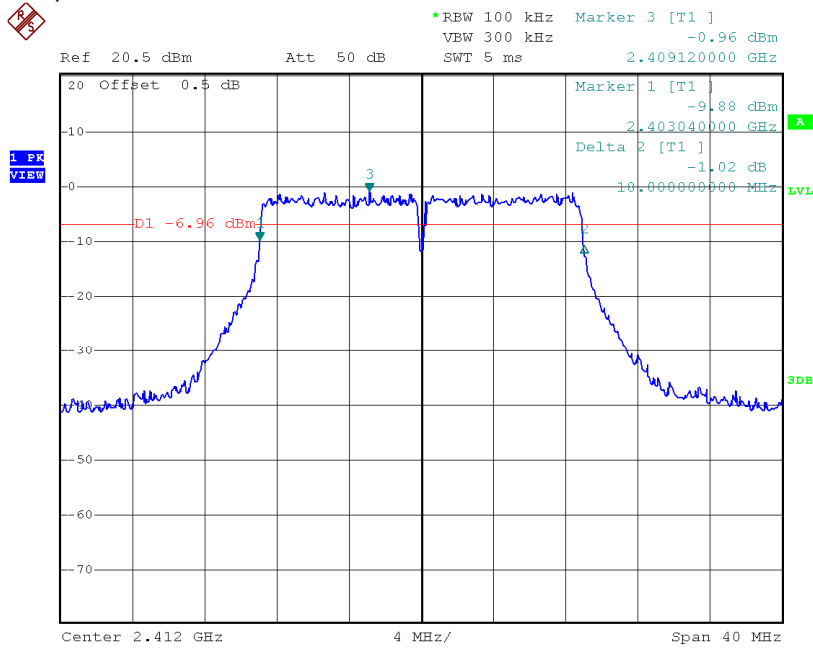

802.11n(20M), Middle Channel

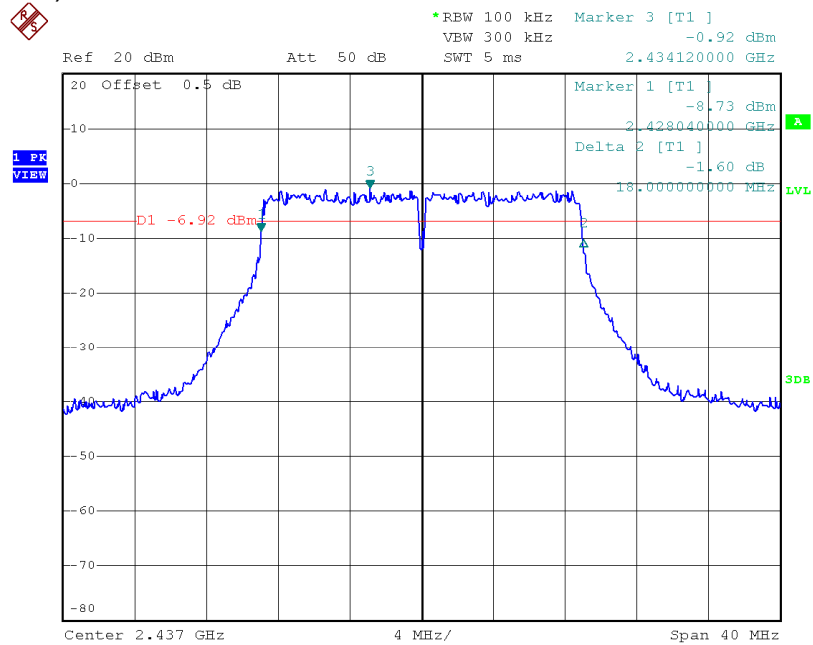

INTERTEK TESTING SERVICES

Plots of 6dB RF bandwidth 802.11n(20M), Highest Channel

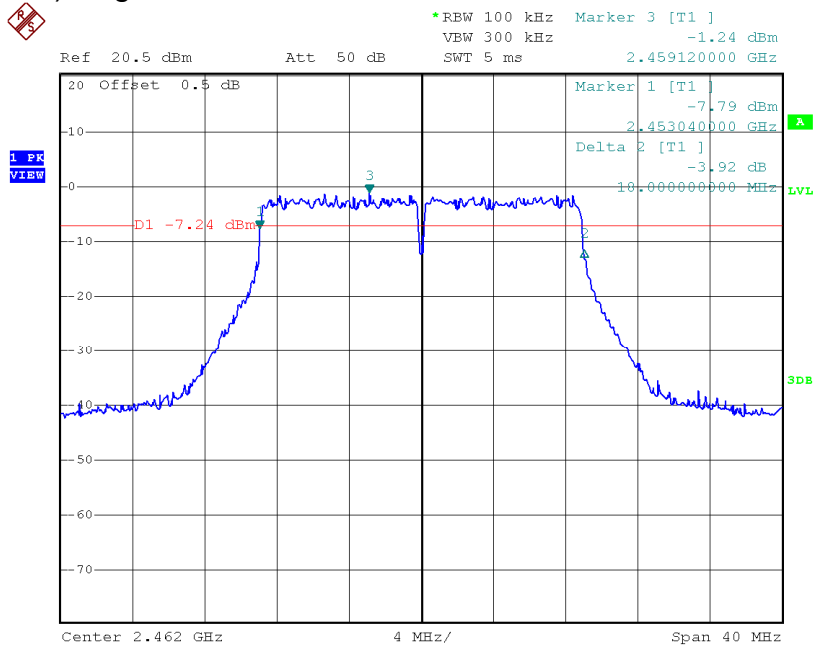

INTERTEK TESTING SERVICES

Plots of 6dB RF bandwidth 802.11n(40M), Lowest Channel

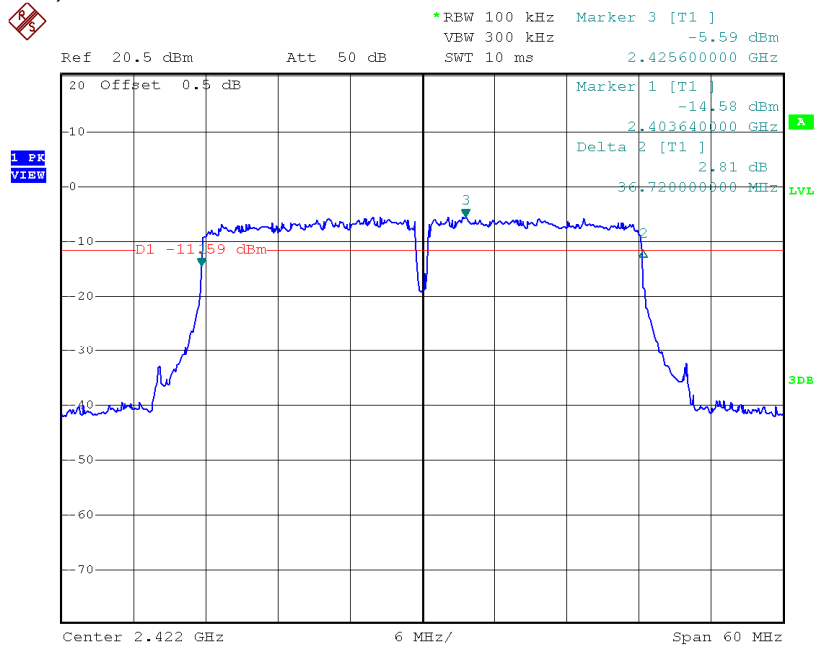

802.11n(40M), Middle Channel

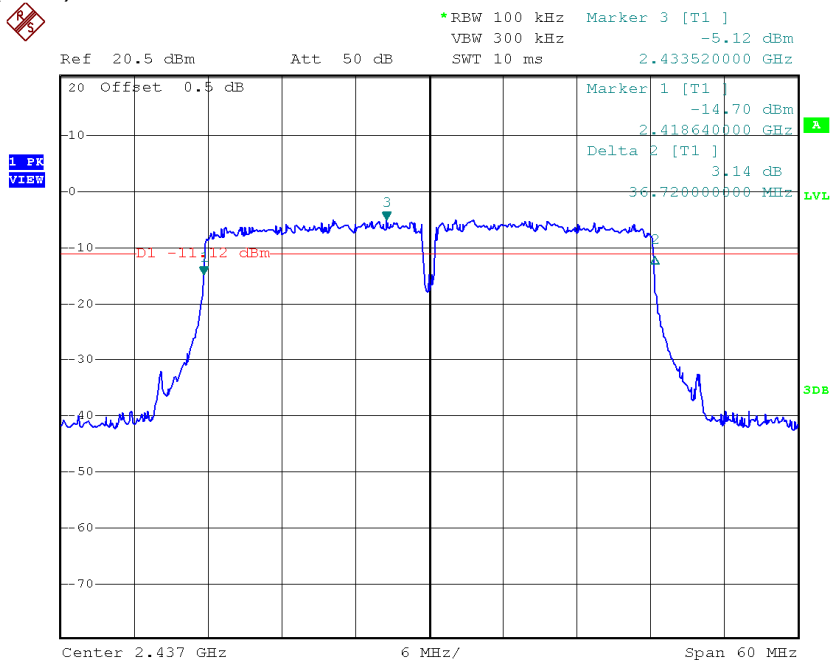

INTERTEK TESTING SERVICES

Plots of 6dB RF bandwidth 802.11n(40M), Highest Channel

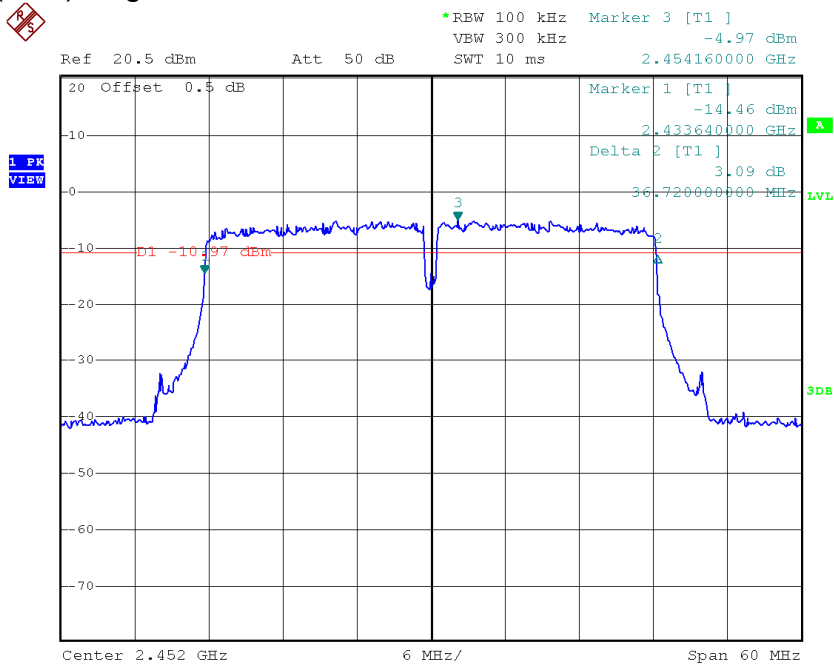

INTERTEK TESTING SERVICES

4.3 Maximum Power Spectral Density

Antenna output of the EUT was coupled directly to spectrum analyzer. The measurement procedure 10.2 PKPSD was used. If an external attenuator and/or cable was used, these losses are compensated for using the OFFSET function of the analyser.

IEEE 802.11b (DSSS, 1 Mbps)	
Frequency (MHz)	PSD in 100kHz (dBm)
Low Channel: 2412	2.79
Middle Channel: 2437	2.92
High Channel: 2462	3.09

IEEE 802.11g (OFDM, 6 Mbps)	
Frequency (MHz)	PSD in 100kHz (dBm)
Low Channel: 2412	-0.84
Middle Channel: 2437	-0.72
High Channel: 2462	-1.16

IEEE 802.11n (20MHz) (OFDM, MCS0)	
Frequency (MHz)	PSD in 100kHz (dBm)
Low Channel: 2412	-1.83
Middle Channel: 2437	-0.63
High Channel: 2462	-0.75

IEEE 802.11n (40MHz) (OFDM, MCS0)	
Frequency (MHz)	PSD in 100kHz (dBm)
Low Channel: 2422	-5.04
Middle Channel: 2437	-5.10
High Channel: 2452	-5.12

Cable Loss: 0.5 dB

Limit:
8dBm

The plots of power spectral density are as below.

INTERTEK TESTING SERVICES

Plots of power spectral density

802.11b, Lowest channel

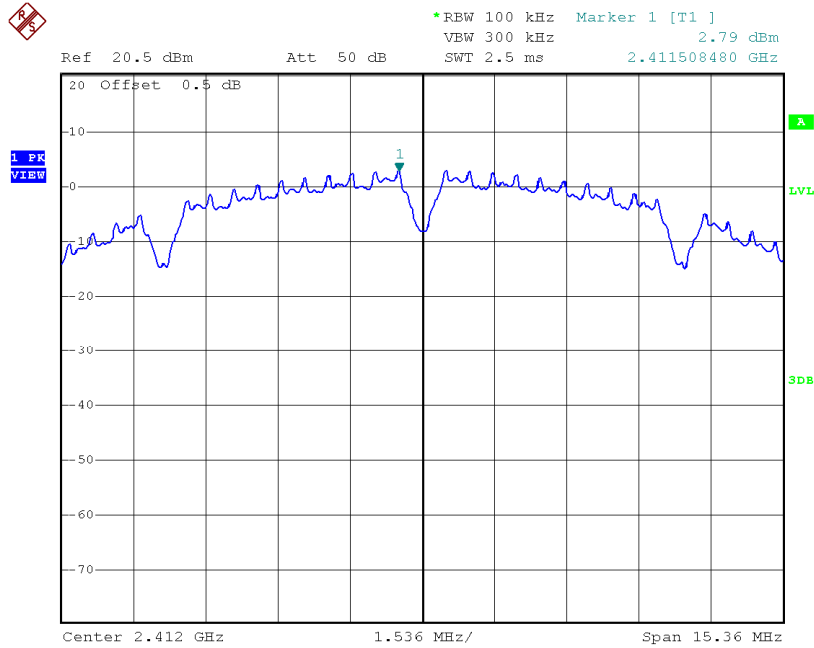

802.11b, Middle channel

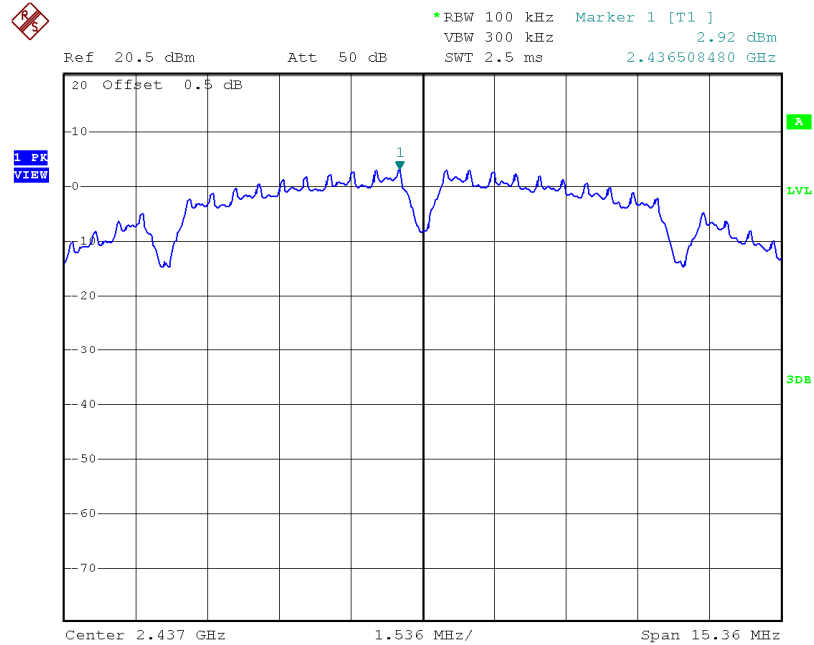

INTERTEK TESTING SERVICES

Plots of power spectral density

802.11b, Highest channel

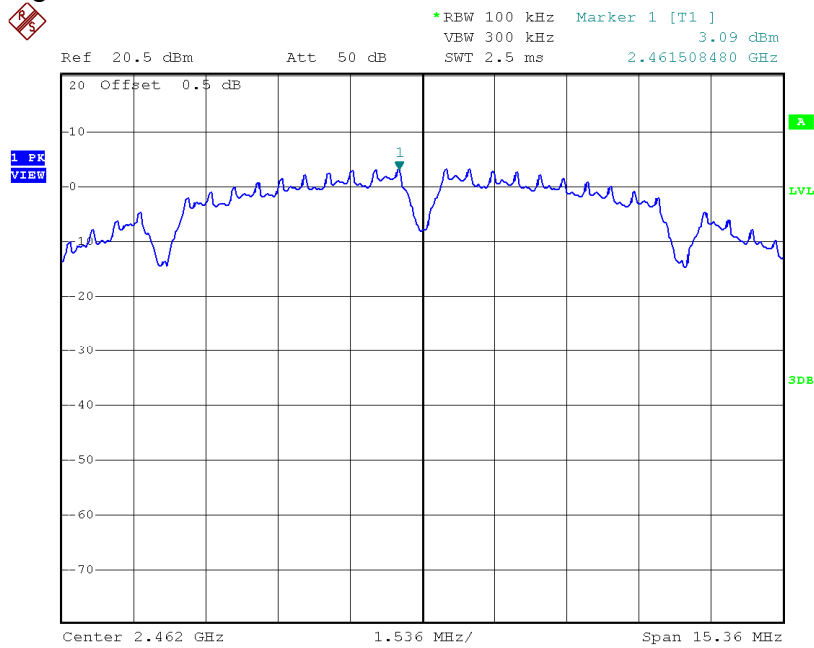

Plots of power spectral density

802.11g, Lowest channel

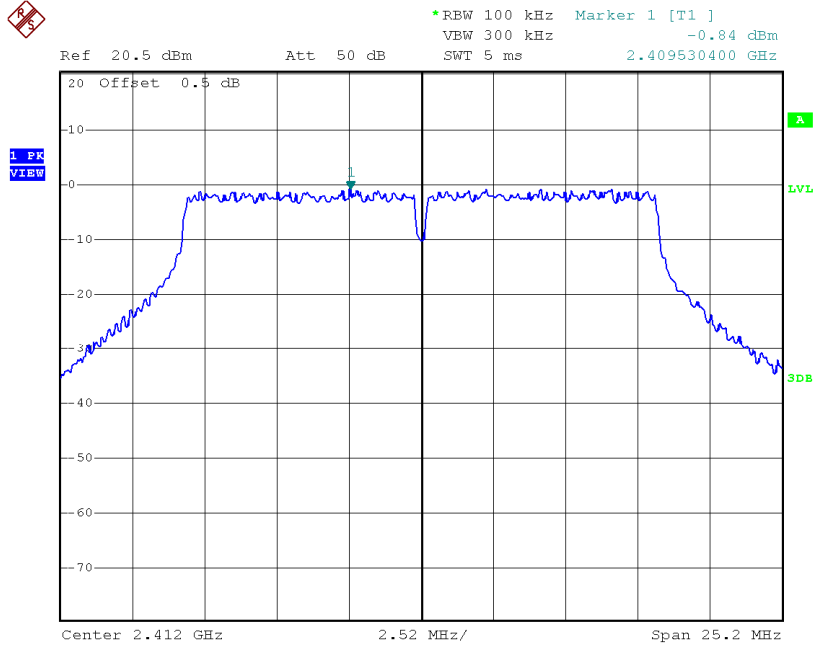

802.11g, Middle channel

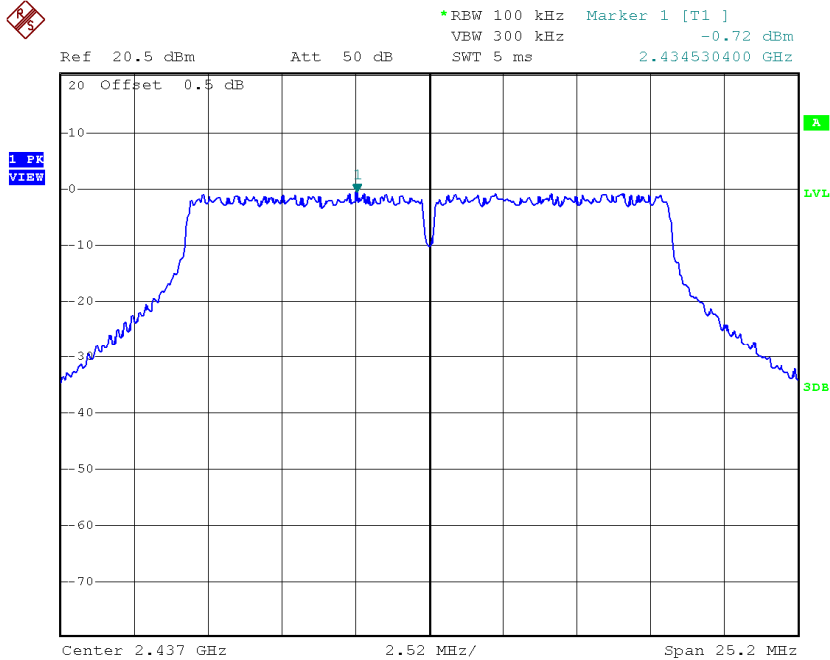

INTERTEK TESTING SERVICES

Plots of power spectral density

802.11g, Highest channel



*RBW 100 kHz Marker 1 [T1]
VBW 300 kHz -1.16 dBm
SWT 5 ms 2.459530400 GHz

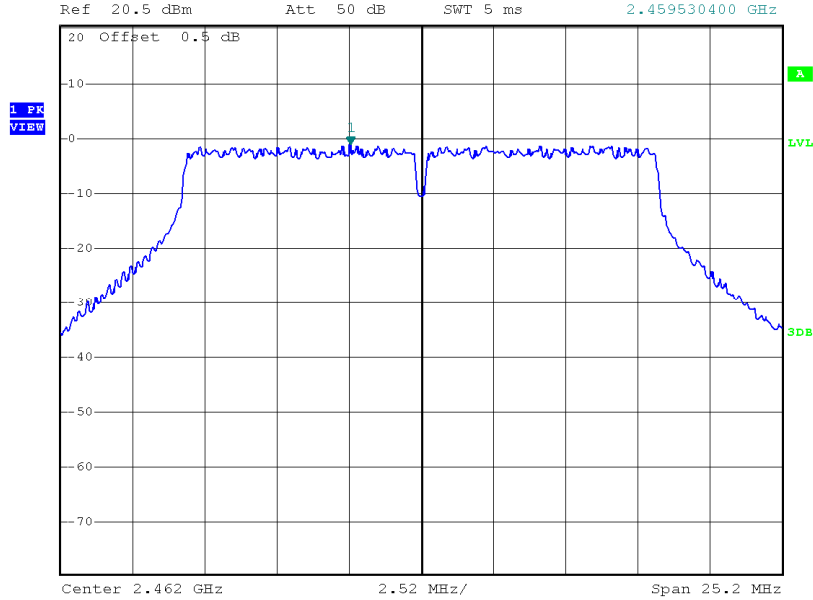

INTERTEK TESTING SERVICES

Plots of power spectral density

802.11n(20M), Lowest channel

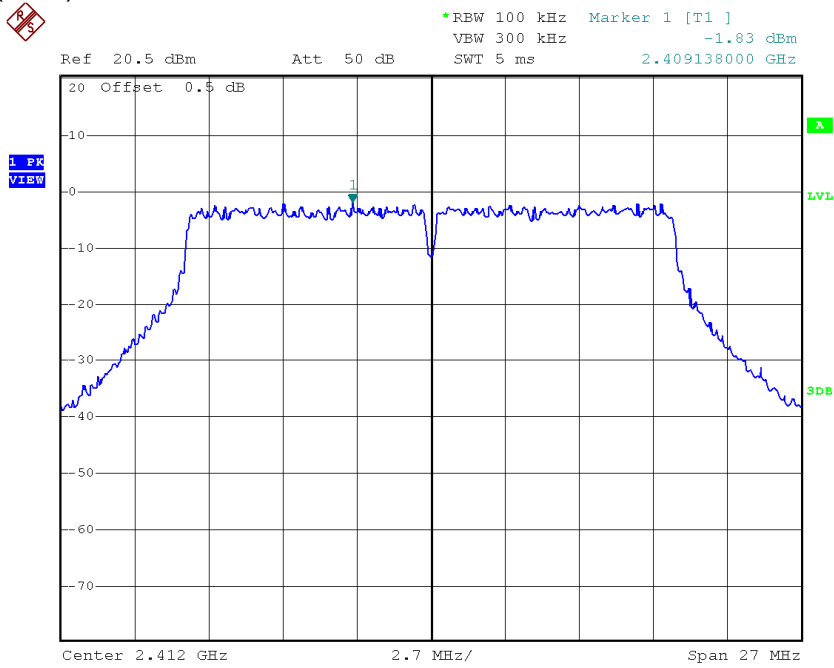

802.11n(20M), Middle channel

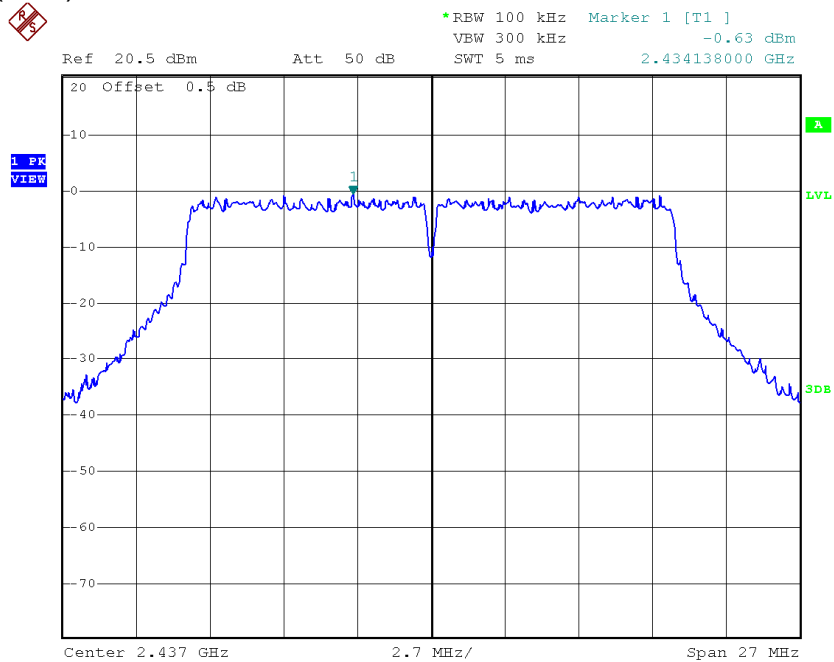

INTERTEK TESTING SERVICES

Plots of power spectral density

802.11n(20M), Highest channel



*RBW 100 kHz Marker 1 [T1]
VBW 300 kHz -0.75 dBm
SWT 5 ms 2.459138000 GHz

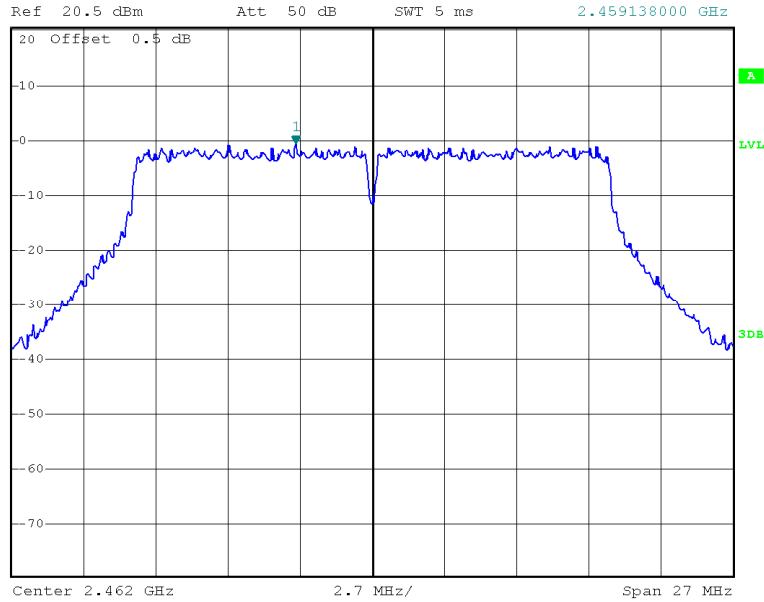

INTERTEK TESTING SERVICES

Plots of power spectral density

802.11n(40M), Lowest channel

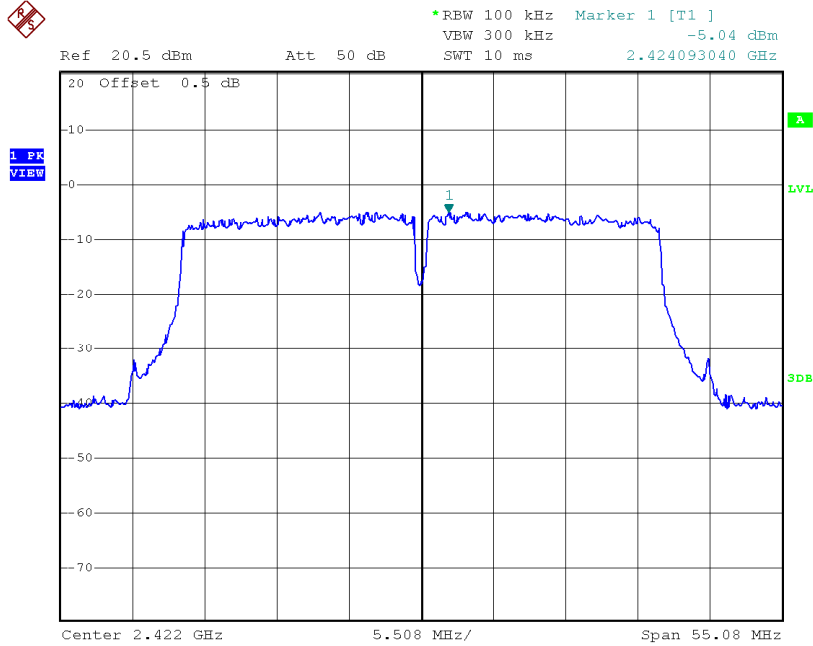

802.11n(40M), Middle channel

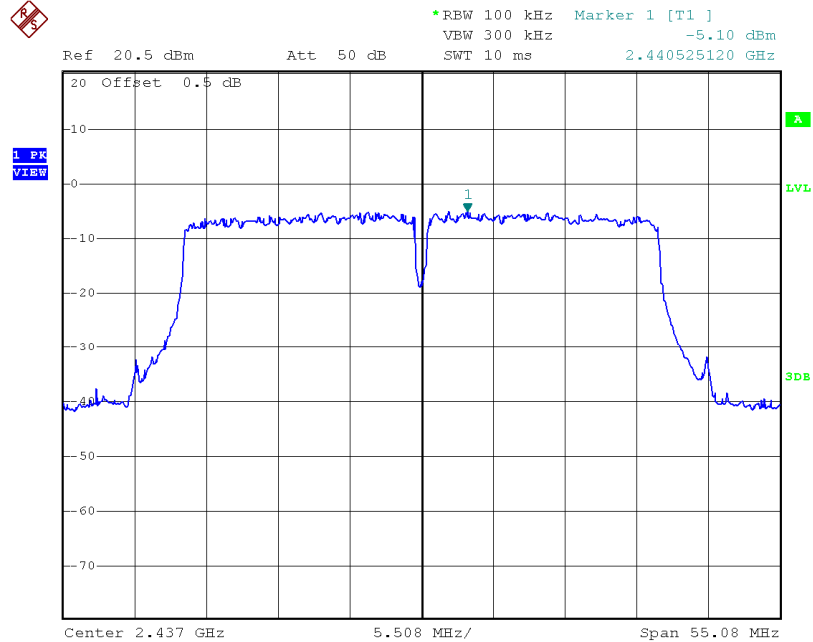

INTERTEK TESTING SERVICES

Plots of power spectral density

802.11n(40M), Highest channel

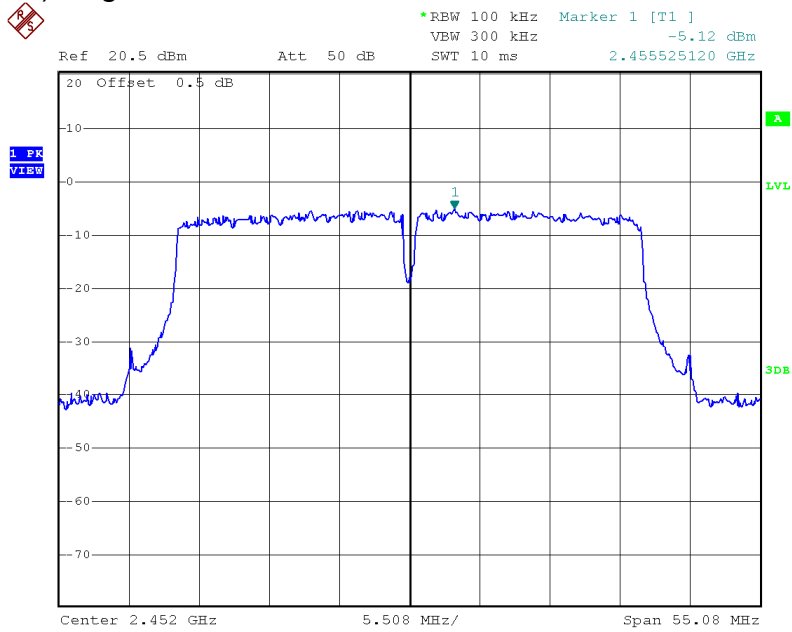

INTERTEK TESTING SERVICES

4.4 Out of Band Conducted Emissions

For 802.11b/g/n20/n40MHz, the maximum conducted (peak) output power was used to demonstrate compliance as described in 9.1. Then the display line (in red) shown in the following plots denotes the limit at 20dB below maximum measured in-band peak PSD level in 100 KHz bandwidth.

The measurement procedures under sections 11 of KDB558074 D01 v03r03 (08-April-2016) were used.

Furthermore, delta measurement technique for measuring bandedge emissions was incorporated in the test of the edge at 2483.5MHz.

Limits:

All spurious emission and up to the tenth harmonic was measured and they were found to be at least 20 dB for 802.11b,g,n20,n40MHz below the maximum measured in-band peak PSD level.

The plots of reference level measurement and out of band conducted emissions are as below.

INTERTEK TESTING SERVICES

Plots of out of band conducted emissions

802.11b, Lowest Channel, Plot A

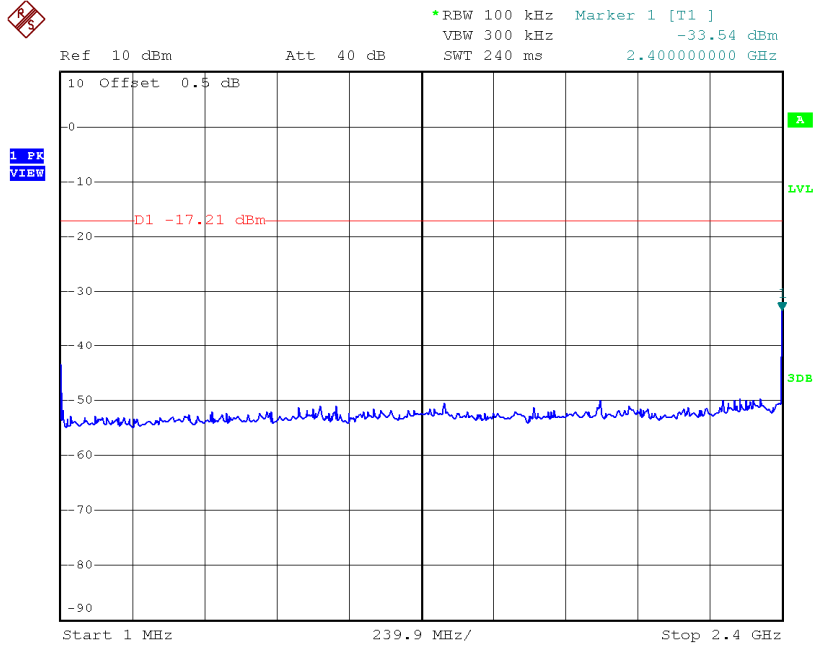

802.11b, Lowest Channel, Plot B

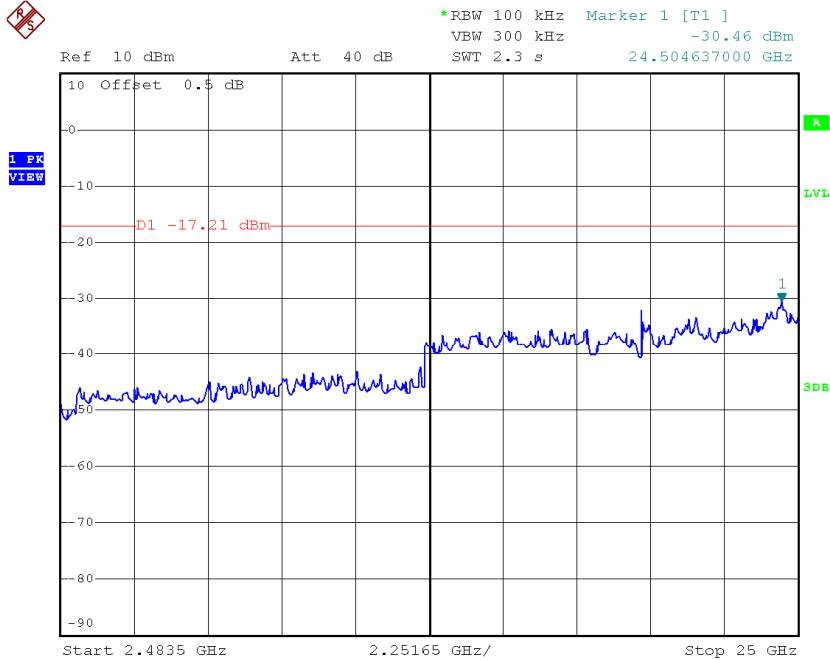

INTERTEK TESTING SERVICES

Plots of out of band conducted emissions

802.11b, Middle Channel, Plot A

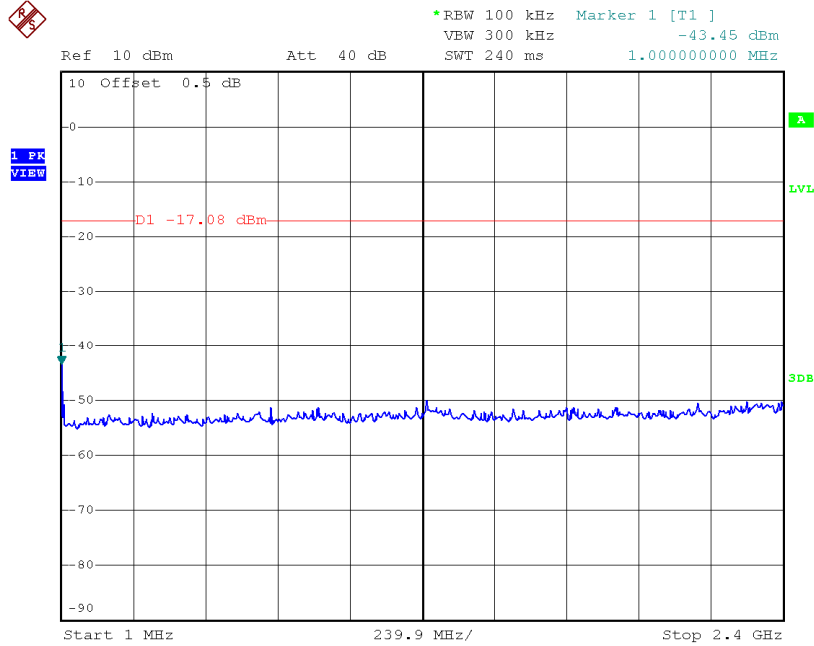

802.11b, Middle Channel, Plot B

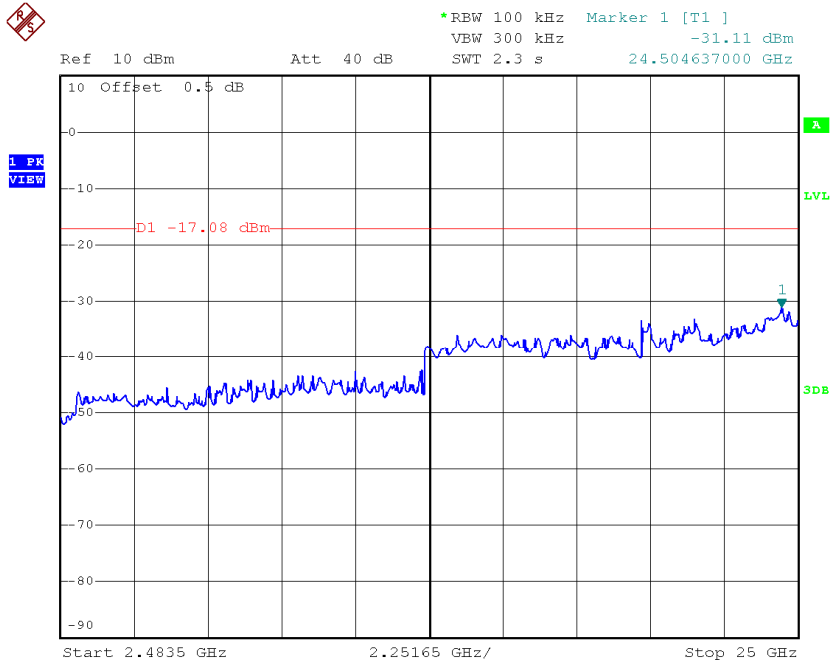

INTERTEK TESTING SERVICES

Plots of out of band conducted emissions

802.11b, Highest Channel, Plot A

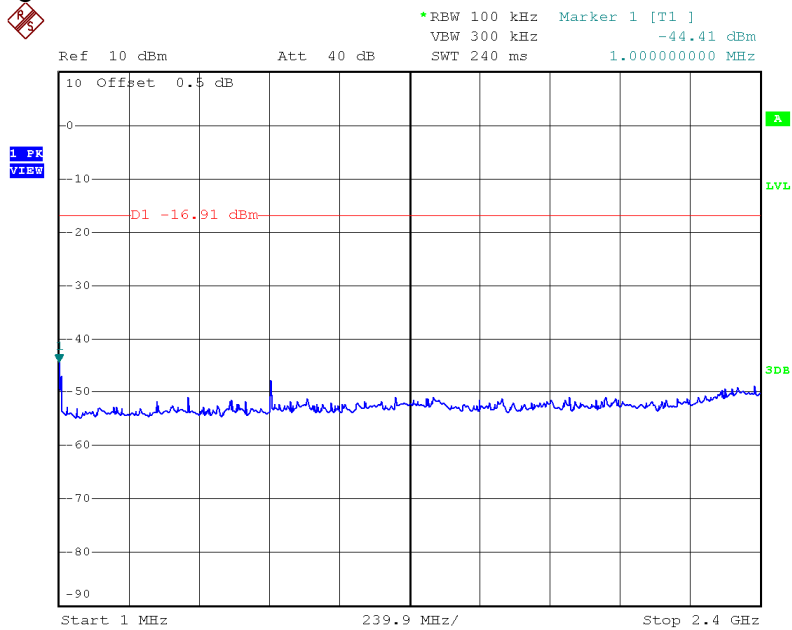

802.11b, Highest Channel, Plot B

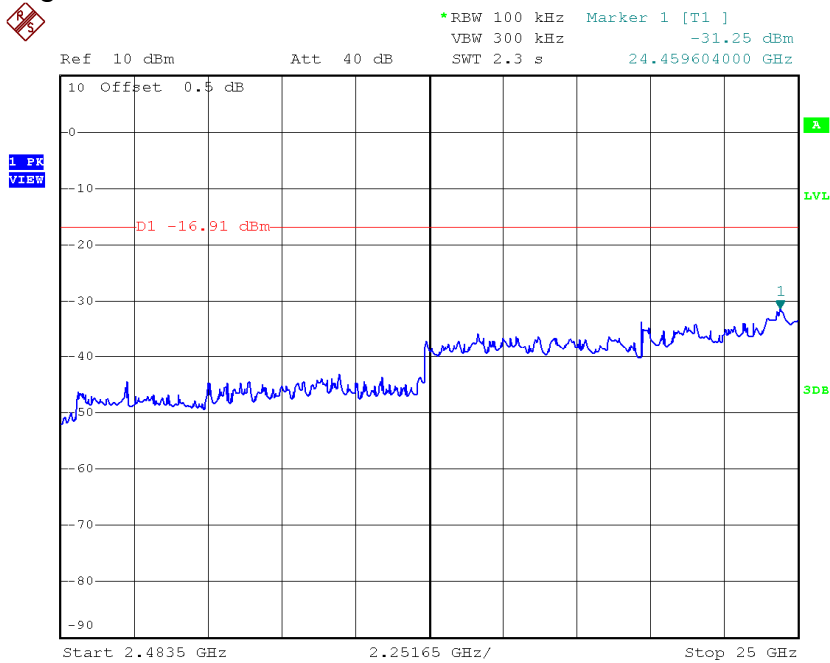

INTERTEK TESTING SERVICES

Plots of out of band conducted emissions

802.11g, Lowest Channel, Plot A

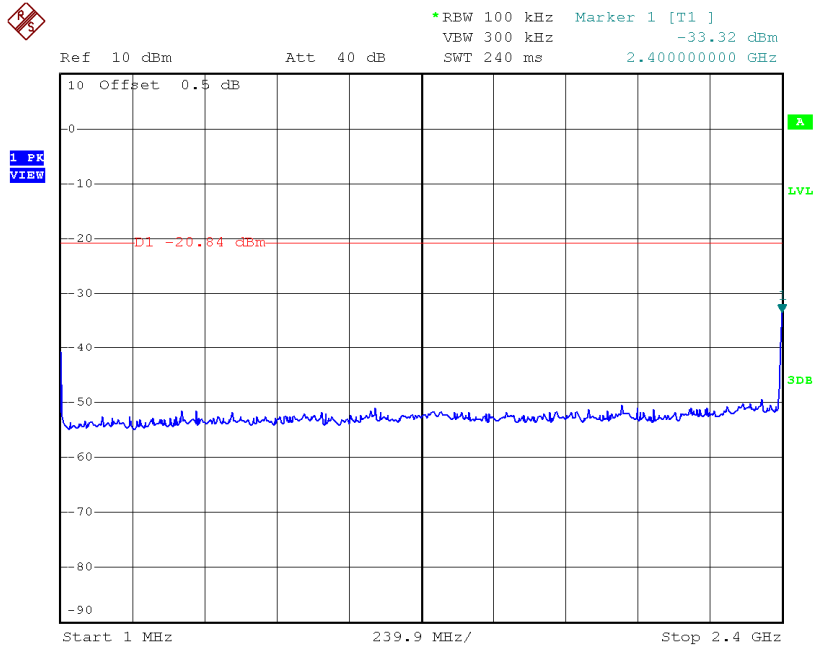

802.11g, Lowest Channel, Plot B

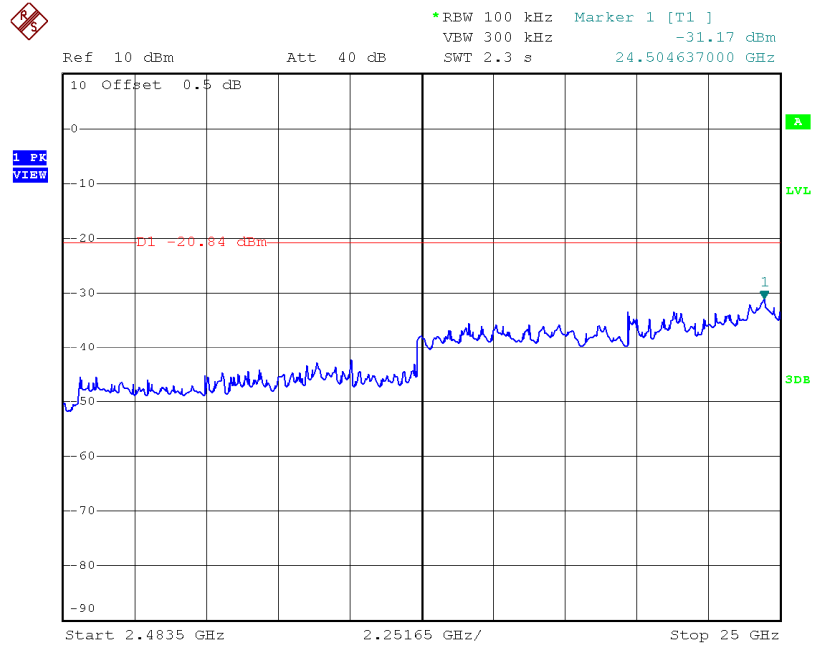

INTERTEK TESTING SERVICES

Plots of out of band conducted emissions

802.11g, Middle Channel, Plot A

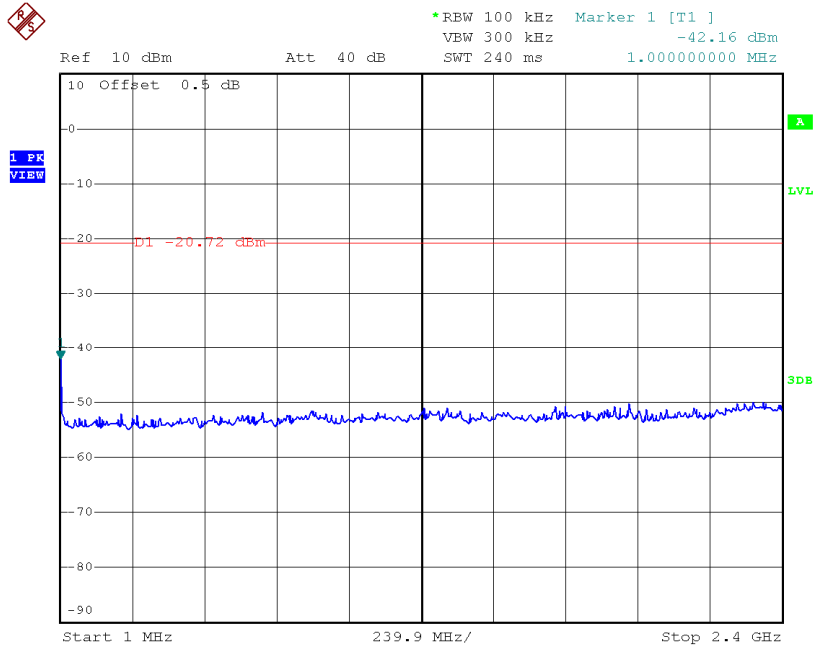

802.11g, Middle Channel, Plot B

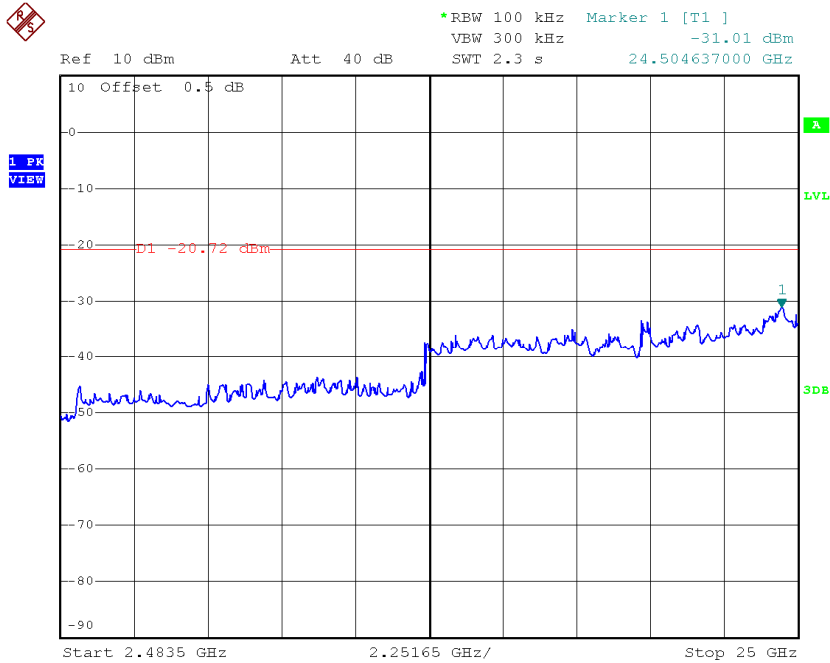

INTERTEK TESTING SERVICES

Plots of out of band conducted emissions

802.11g, Highest Channel, Plot A

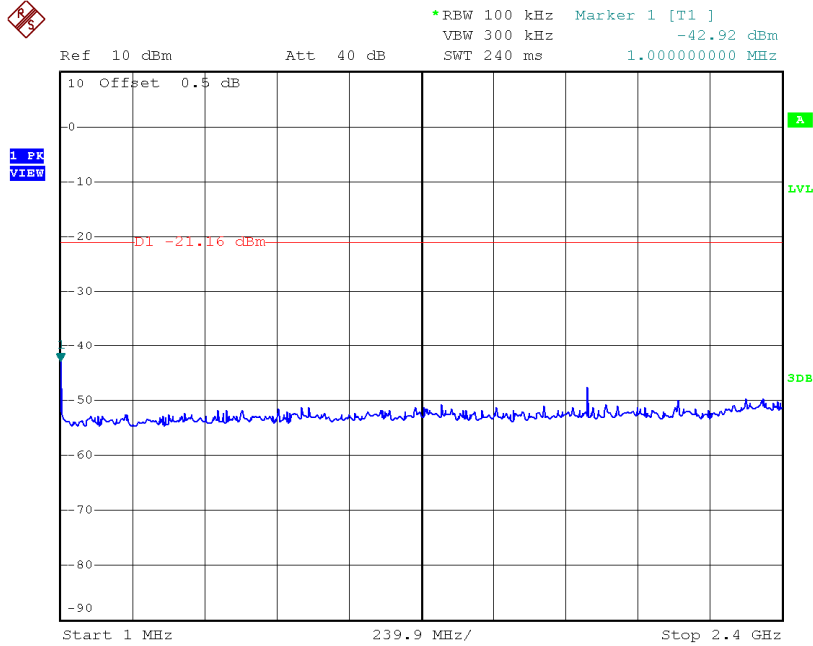

802.11g, Highest Channel, Plot B

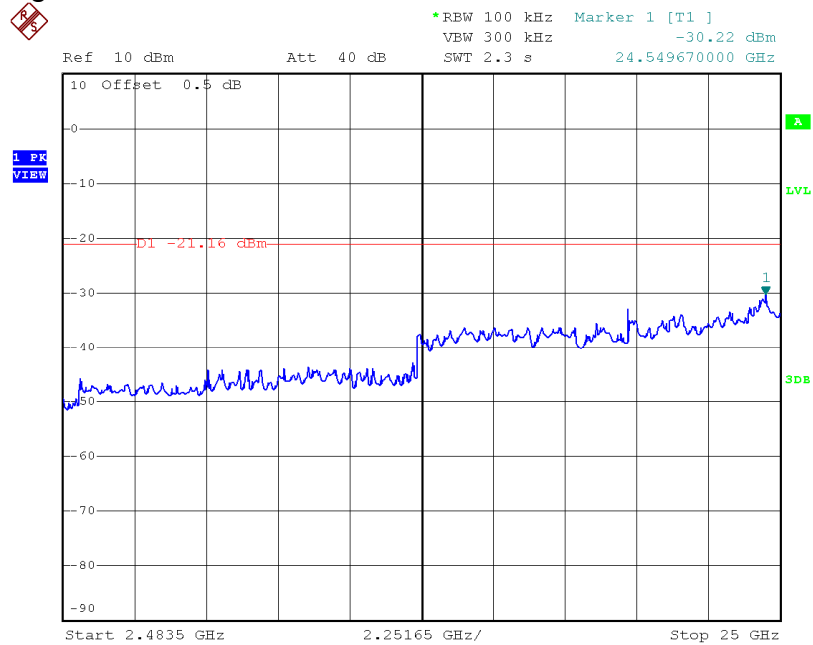

INTERTEK TESTING SERVICES

Plots of out of band conducted emissions

802.11n (20M), Lowest Channel, Plot A

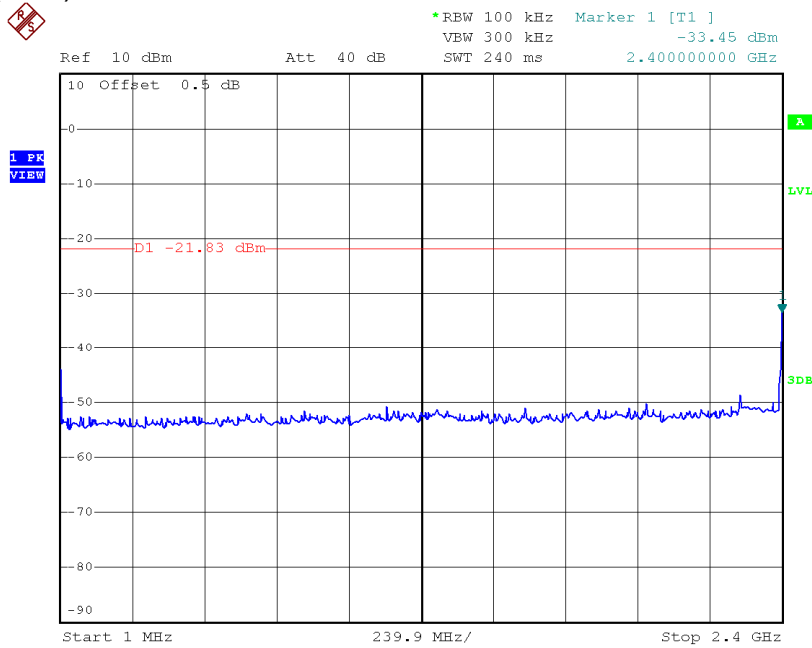

802.11n (20M), Lowest Channel, Plot B

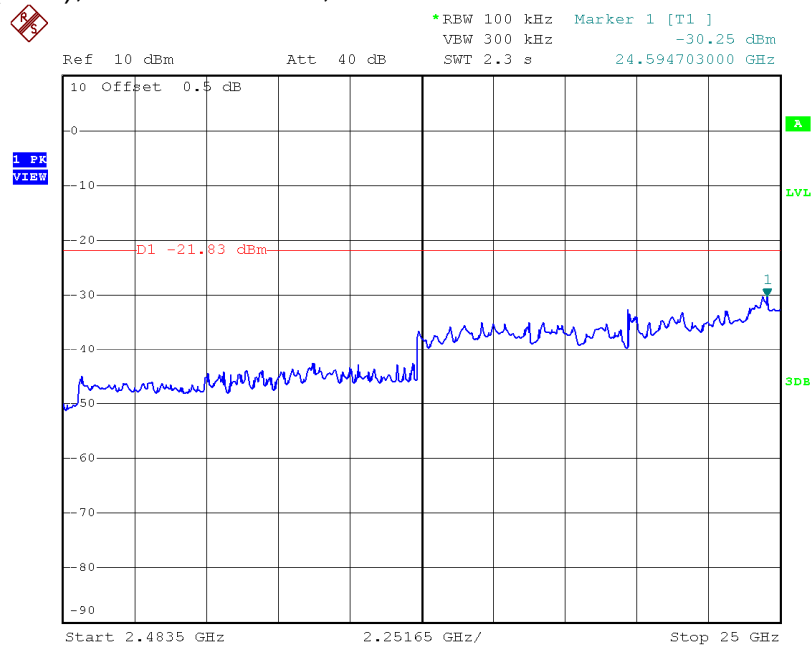

INTERTEK TESTING SERVICES

Plots of out of band conducted emissions

802.11n (20M), Middle Channel, Plot A

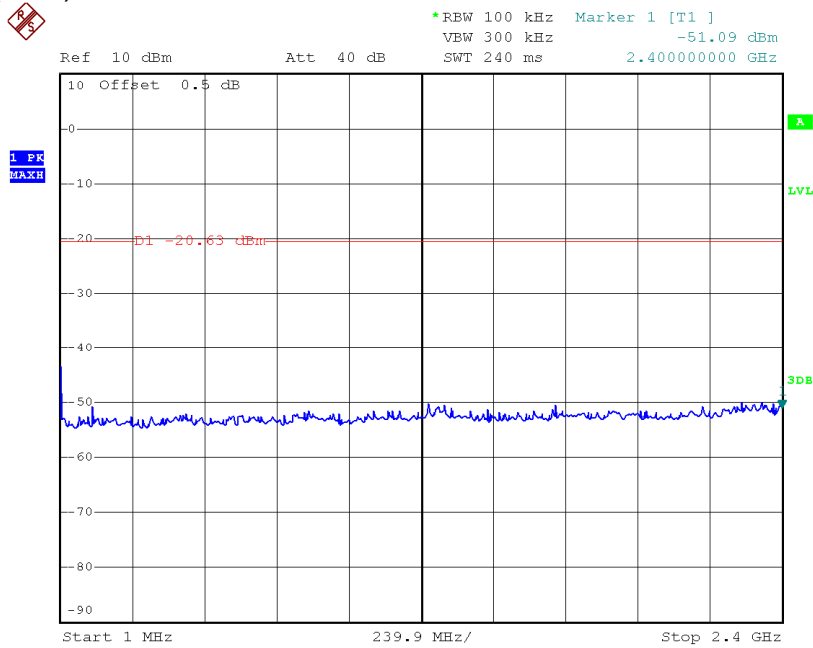

802.11n (20M), Middle Channel, Plot B

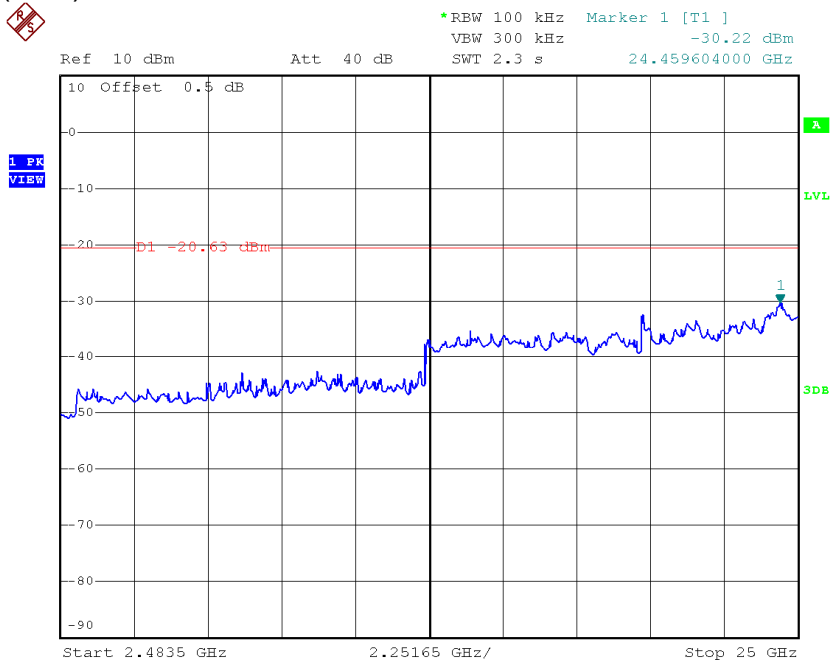

INTERTEK TESTING SERVICES

Plots of out of band conducted emissions

802.11n (20M), Highest Channel, Plot A

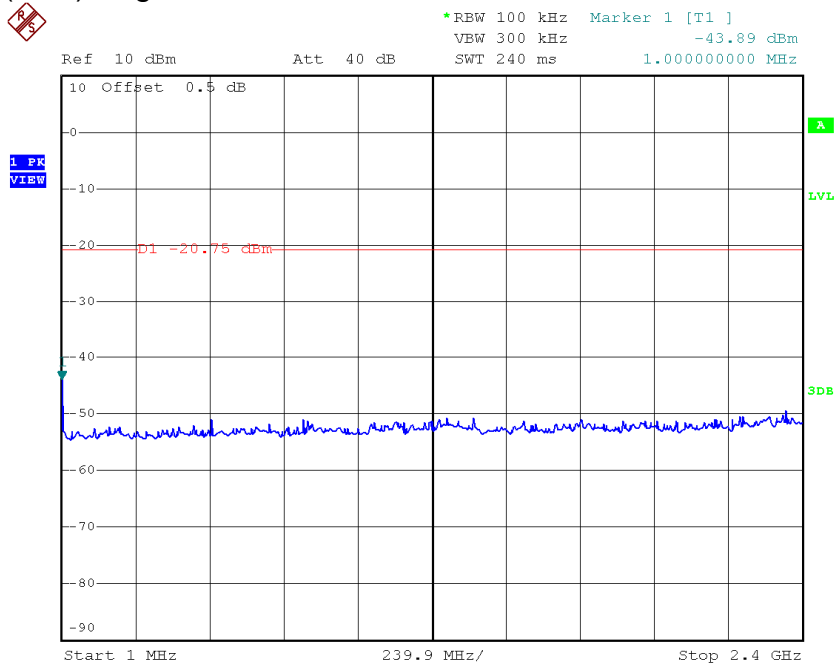

802.11n (20M), Highest Channel, Plot B

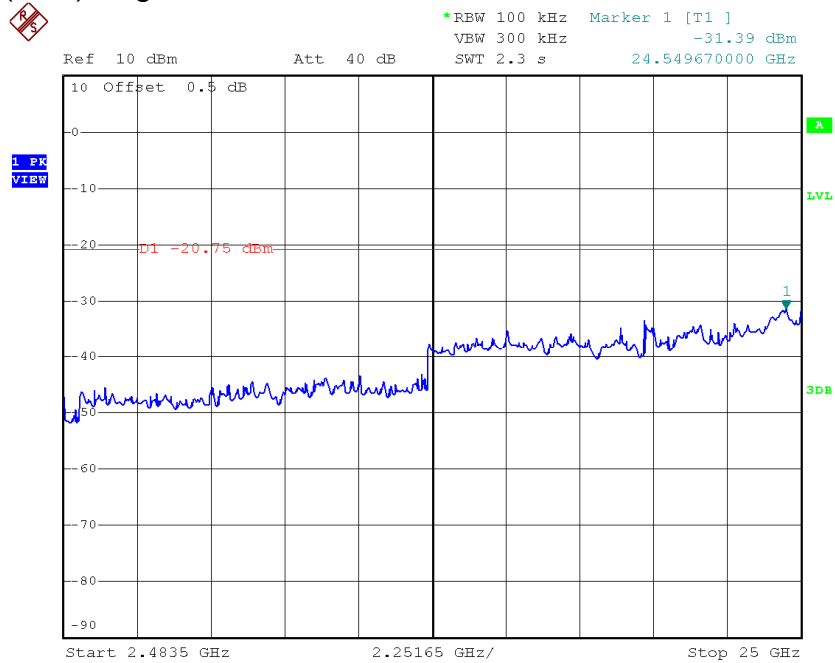

INTERTEK TESTING SERVICES

Plots of out of band conducted emissions

802.11n (40M), Lowest Channel, Plot A

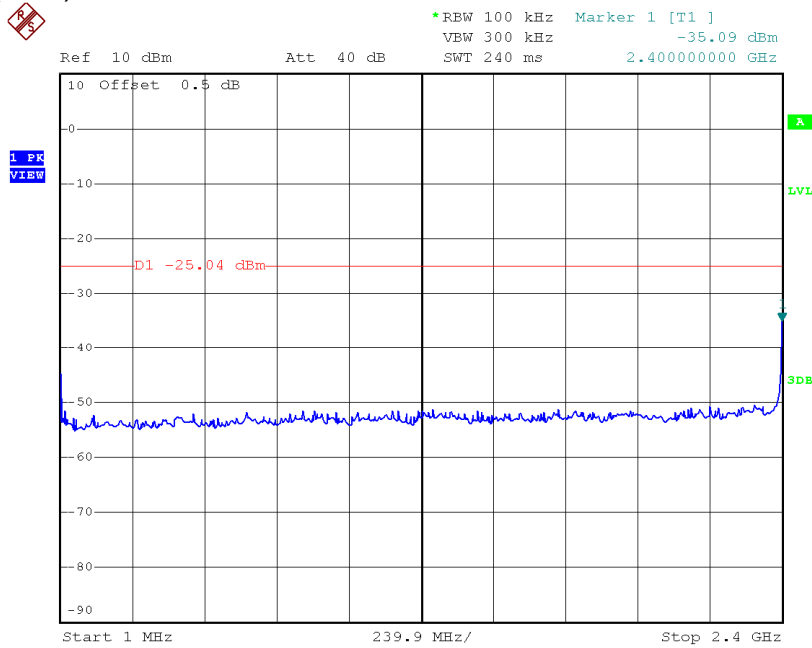

802.11n (40M), Lowest Channel, Plot B

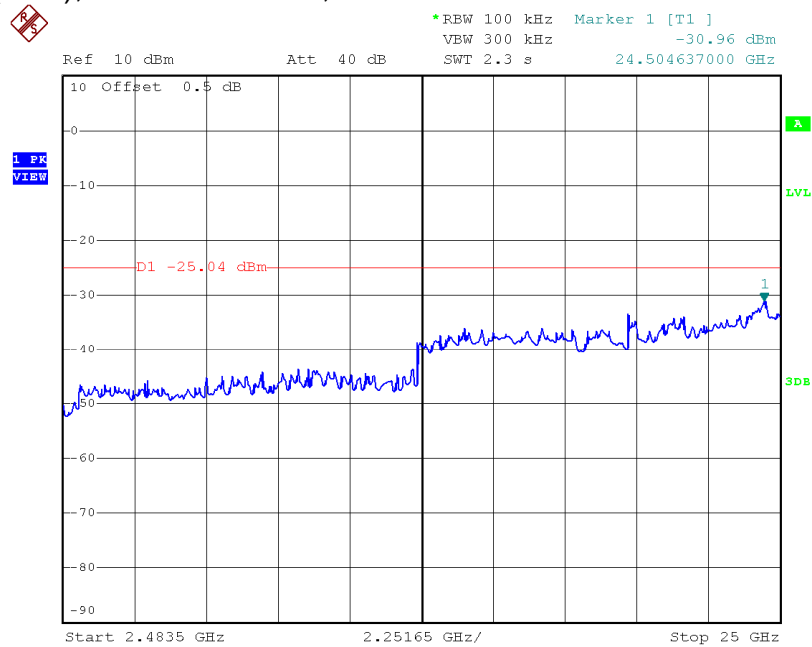

INTERTEK TESTING SERVICES

Plots of out of band conducted emissions

802.11n (40M), Middle Channel, Plot A

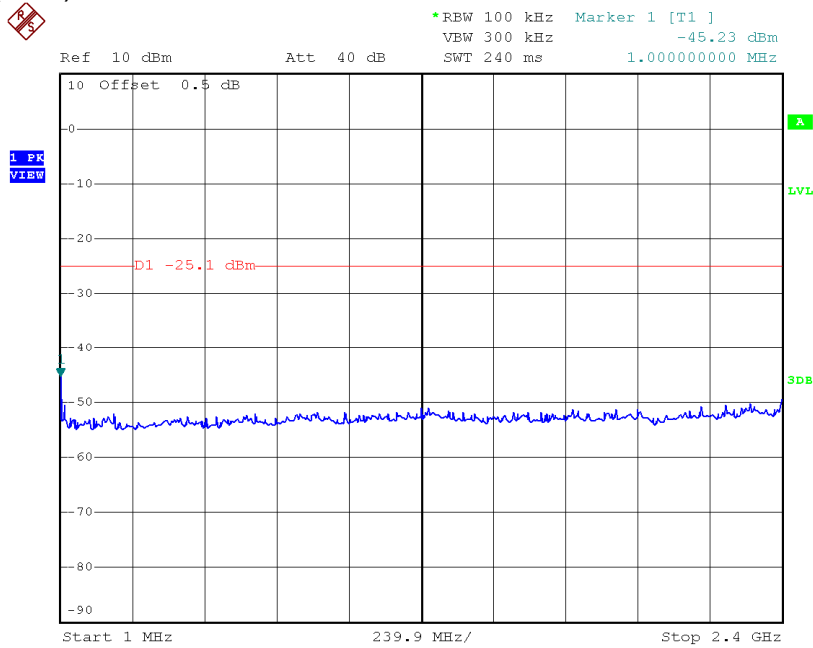

802.11n (40M), Middle Channel, Plot B

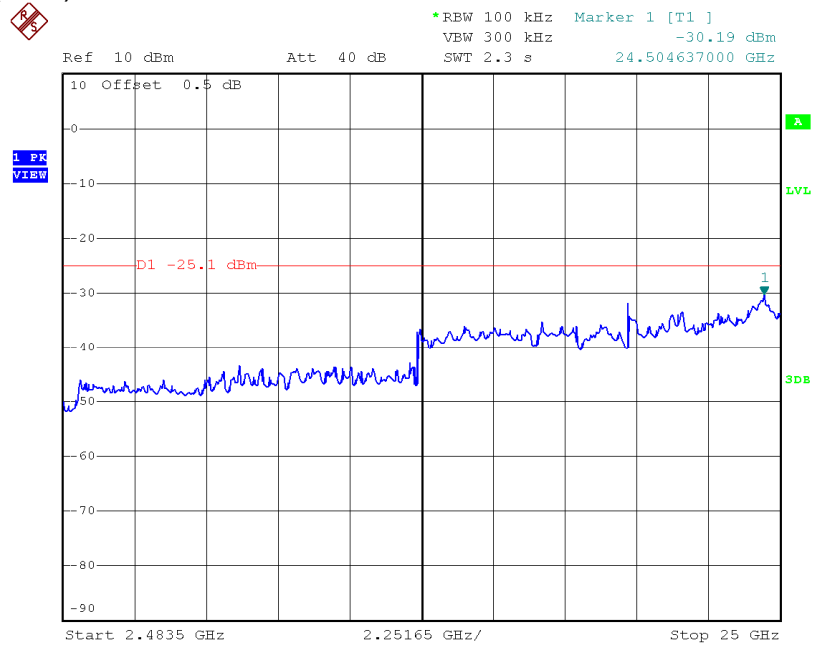

INTERTEK TESTING SERVICES

Plots of out of band conducted emissions

802.11n (40M), Highest Channel, Plot A

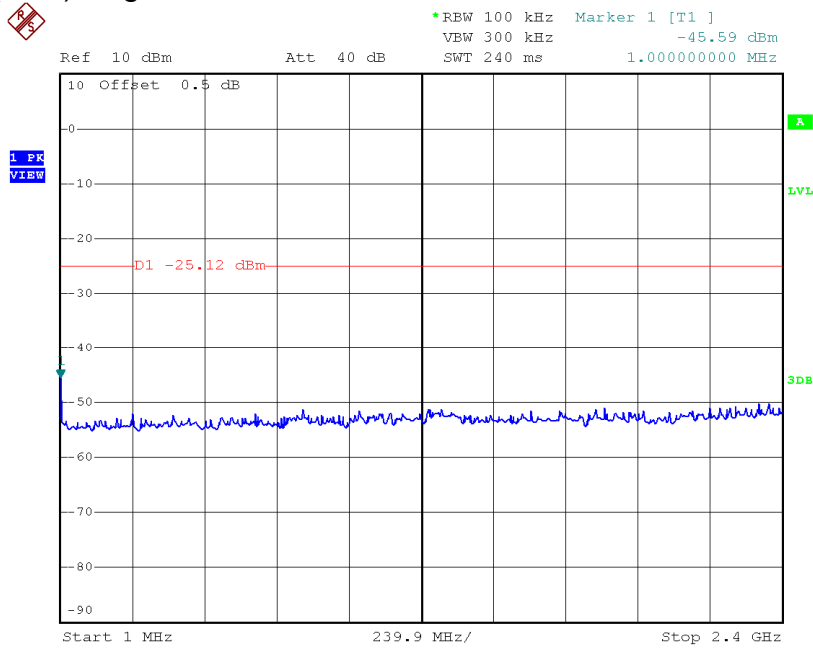

802.11n (40M), Highest Channel, Plot B

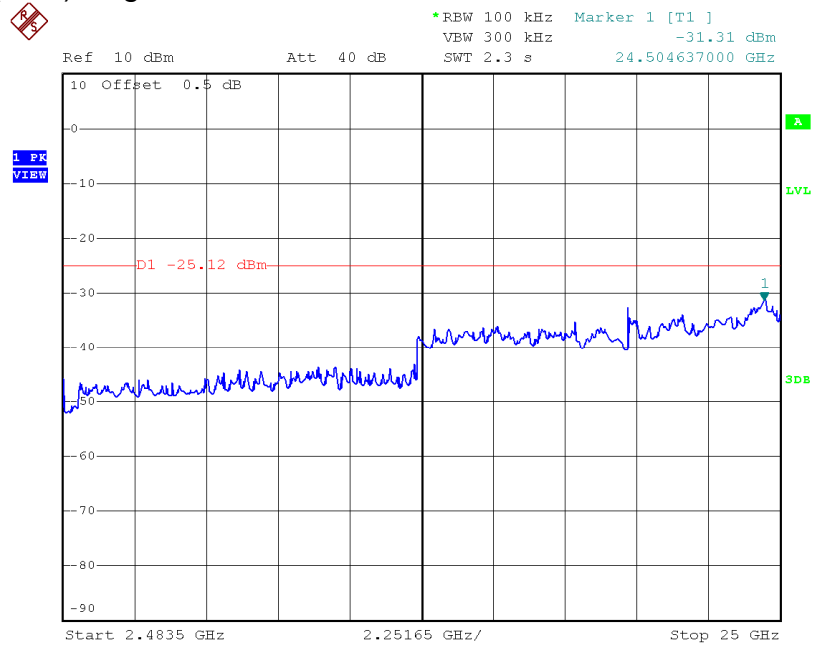

INTERTEK TESTING SERVICES

4.5 Field Strength Calculation

The field strength is calculated by adding the reading on the Spectrum Analyzer to the factors associated with preamplifiers (if any), antennas, cables, pulse desensitization and average factors (when specified limit is in average and measurements are made with peak detectors). A sample calculation is included below.

$$FS = RA + AF + CF - AG + PD + AV$$

Where

- FS = Field Strength in dB μ V/m
- RA = Receiver Amplitude (including preamplifier) in dB μ V
- CF = Cable Attenuation Factor in dB
- AF = Antenna Factor in dB
- AG = Amplifier Gain in dB
- PD = Pulse Desensitization in dB
- AV = Average Factor in -dB

In the radiated emission table which follows, the reading shown on the data table may reflect the preamplifier gain. An example of the calculations, where the reading does not reflect the preamplifier gain, follows:

$$FS = RA + AF + CF - AG + PD + AV$$

Example

Assume a receiver reading of 62.0 dB μ V is obtained. The antenna factor of 7.4 dB and cable factor of 1.6 dB is added. The amplifier gain of 29.0 dB is subtracted. The pulse desensitization factor of the spectrum analyzer is 0.0 dB, and the resultant average factor is -10.0 dB. The net field strength for comparison to the appropriate emission limit is 32.0 dB μ V/m. This value in dB μ V/m is converted to its corresponding level in μ V/m.

RA = 62.0 dB μ V
AF = 7.4 dB
CF = 1.6 dB
AG = 29.0 dB
PD = 0.0 dB
AV = -10 dB

$$FS = 62.0 + 7.4 + 1.6 - 29.0 + 0.0 + (-10.0) = 32.0 \text{ dB}\mu\text{V/m}$$

$$\text{Level in } \mu\text{V/m} = \text{Common Antilogarithm} [(32.0 \text{ dB}\mu\text{V/m})/20] = 39.8 \mu\text{V/m}$$

INTERTEK TESTING SERVICES

4.6 Transmitter Radiated Emissions in Restricted Bands and Spurious Emissions

Data is included of the worst case configuration (the configuration which resulted in the highest emission levels). A sample calculation, configuration photographs and data tables of the emissions are included.

The data on the following pages list the significant emission frequencies, the limit and the margin of compliance.

4.6.1 Radiated Emission Configuration Photograph

Worst Case Restricted Band Radiated Emission
at

7311.000MHz

The worst case radiated emission configuration photographs are saved with filename:
config photos.pdf

4.6.2 Radiated Emission Data

The data in tables 1-19 list the significant emission frequencies, the limit and the margin of compliance.

Judgement -

Passed by 0.2 dB margin compare with average limit

INTERTEK TESTING SERVICES

Mode: TX-Channel 01

Table 1
IEEE 802.11b (DSSS, 1 Mbps)

Radiated Emission Data

Polarization	Frequency (MHz)	Reading (dB μ V)	Pre-Amp Gain (dB)	Antenna Factor (dB)	Net at 3m (dB μ V/m)	Average Limit at 3m (dB μ V/m)	Margin (dB)
<i>V</i>	<i>2390.000</i>	<i>52.4</i>	<i>33</i>	<i>29.4</i>	<i>48.8</i>	<i>54.0</i>	<i>-5.2</i>
<i>H</i>	<i>4824.000</i>	<i>50.0</i>	<i>33</i>	<i>34.9</i>	<i>51.9</i>	<i>54.0</i>	<i>-2.1</i>
<i>V</i>	<i>12060.000</i>	<i>34.6</i>	<i>33</i>	<i>40.5</i>	<i>42.1</i>	<i>54.0</i>	<i>-11.9</i>
<i>V</i>	<i>14472.000</i>	<i>36.1</i>	<i>33</i>	<i>40.0</i>	<i>43.1</i>	<i>54.0</i>	<i>-10.9</i>

Polarization	Frequency (MHz)	Reading (dB μ V)	Pre-Amp Gain (dB)	Antenna Factor (dB)	Net at 3m - Peak (dB μ V/m)	Peak Limit at 3m (dB μ V/m)	Margin (dB)
<i>V</i>	<i>2390.000</i>	<i>63.9</i>	<i>33</i>	<i>29.4</i>	<i>60.3</i>	<i>74.0</i>	<i>-13.7</i>
<i>H</i>	<i>4824.000</i>	<i>53.4</i>	<i>33</i>	<i>34.9</i>	<i>55.3</i>	<i>74.0</i>	<i>-18.7</i>
<i>V</i>	<i>12060.000</i>	<i>47.8</i>	<i>33</i>	<i>40.5</i>	<i>55.3</i>	<i>74.0</i>	<i>-18.7</i>
<i>V</i>	<i>14472.000</i>	<i>49.5</i>	<i>33</i>	<i>40.0</i>	<i>56.5</i>	<i>74.0</i>	<i>-17.5</i>

- NOTES:
1. Peak detector is used for the emission measurement.
 2. Average detector is used for the average data of emission measurement
 3. All measurements were made at 3 meters. Radiated emissions not detected at the 3-meter distance were measured at 0.3-meter and an inverse proportional extrapolation was performed to compare the signal level to the 3-meter limit. No other radiated emissions than those reported were detected at a test distance of 0.3-meter.
 4. Negative value in the margin column shows emission below limit.
 5. Horn antenna is used for the emission over 1000MHz.
 6. Emission (the row indicated by ***bold italic***) within the restricted band meets the requirement of FCC Part 15 Section 15.205 / RSS-Gen Section 8.10.
 7. For the measurement of radiated emission, summation method was used which numerical integrating (in terms of linear power) over the transmitter occupied bandwidth.
 8. For the linear power measurement, data in 1MHz spacing was collected by spectrum analyzer with 1MHz resolution bandwidth.

INTERTEK TESTING SERVICES

Mode: TX-Channel 06

Table 2
IEEE 802.11b (DSSS, 1 Mbps)

Radiated Emission Data

Polarization	Frequency (MHz)	Reading (dB μ V)	Pre-Amp Gain (dB)	Antenna Factor (dB)	Net at 3m (dB μ V/m)	Average Limit at 3m (dB μ V/m)	Margin (dB)
<i>H</i>	<i>4874.000</i>	<i>49.7</i>	<i>33</i>	<i>34.9</i>	<i>51.6</i>	<i>54.0</i>	<i>-2.4</i>
<i>V</i>	<i>7311.000</i>	<i>48.9</i>	<i>33</i>	<i>37.9</i>	<i>53.8</i>	<i>54.0</i>	<i>-0.2</i>
<i>V</i>	<i>12185.000</i>	<i>34.4</i>	<i>33</i>	<i>40.5</i>	<i>41.9</i>	<i>54.0</i>	<i>-12.1</i>

Polarization	Frequency (MHz)	Reading (dB μ V)	Pre-Amp Gain (dB)	Antenna Factor (dB)	Net at 3m - Peak (dB μ V/m)	Peak Limit at 3m (dB μ V/m)	Margin (dB)
<i>H</i>	<i>4874.000</i>	<i>53.2</i>	<i>33</i>	<i>34.9</i>	<i>55.1</i>	<i>74.0</i>	<i>-18.9</i>
<i>V</i>	<i>7311.000</i>	<i>55.4</i>	<i>33</i>	<i>37.9</i>	<i>60.3</i>	<i>74.0</i>	<i>-13.7</i>
<i>V</i>	<i>12185.000</i>	<i>47.7</i>	<i>33</i>	<i>40.5</i>	<i>55.2</i>	<i>74.0</i>	<i>-18.8</i>

- NOTES:
1. Peak detector is used for the emission measurement.
 2. Average detector is used for the average data of emission measurement
 3. All measurements were made at 3 meters. Radiated emissions not detected at the 3-meter distance were measured at 0.3-meter and an inverse proportional extrapolation was performed to compare the signal level to the 3-meter limit. No other radiated emissions than those reported were detected at a test distance of 0.3-meter.
 4. Negative value in the margin column shows emission below limit.
 5. Horn antenna is used for the emission over 1000MHz.
 6. Emission (the row indicated by ***bold italic***) within the restricted band meets the requirement of FCC Part 15 Section 15.205 / RSS-Gen Section 8.10.
 7. For the measurement of radiated emission, summation method was used which numerical integrating (in terms of linear power) over the transmitter occupied bandwidth.
 8. For the linear power measurement, data in 1MHz spacing was collected by spectrum analyzer with 1MHz resolution bandwidth.

INTERTEK TESTING SERVICES

Mode: TX-Channel 11

Table 3
IEEE 802.11b (DSSS, 1 Mbps)

Radiated Emission Data

Polarization	Frequency (MHz)	Reading (dB μ V)	Pre-Amp Gain (dB)	Antenna Factor (dB)	Net at 3m (dB μ V/m)	Average Limit at 3m (dB μ V/m)	Margin (dB)
<i>V</i>	<i>2483.500</i>	<i>52.1</i>	<i>33</i>	<i>29.4</i>	<i>48.5</i>	<i>54.0</i>	<i>-5.5</i>
<i>H</i>	<i>4924.000</i>	<i>49.9</i>	<i>33</i>	<i>34.9</i>	<i>51.8</i>	<i>54.0</i>	<i>-2.2</i>
<i>V</i>	<i>7386.000</i>	<i>48.8</i>	<i>33</i>	<i>37.9</i>	<i>53.7</i>	<i>54.0</i>	<i>-0.3</i>
<i>V</i>	<i>12310.000</i>	<i>34.5</i>	<i>33</i>	<i>40.5</i>	<i>42.0</i>	<i>54.0</i>	<i>-12.0</i>

Polarization	Frequency (MHz)	Reading (dB μ V)	Pre-Amp Gain (dB)	Antenna Factor (dB)	Net at 3m - Peak (dB μ V/m)	Peak Limit at 3m (dB μ V/m)	Margin (dB)
<i>V</i>	<i>2483.500</i>	<i>63.7</i>	<i>33</i>	<i>29.4</i>	<i>60.1</i>	<i>74.0</i>	<i>-13.9</i>
<i>H</i>	<i>4924.000</i>	<i>53.3</i>	<i>33</i>	<i>34.9</i>	<i>55.2</i>	<i>74.0</i>	<i>-18.8</i>
<i>V</i>	<i>7386.000</i>	<i>55.3</i>	<i>33</i>	<i>37.9</i>	<i>60.2</i>	<i>74.0</i>	<i>-13.8</i>
<i>V</i>	<i>12310.000</i>	<i>47.7</i>	<i>33</i>	<i>40.5</i>	<i>55.2</i>	<i>74.0</i>	<i>-18.8</i>

- NOTES:
1. Peak detector is used for the emission measurement.
 2. Average detector is used for the average data of emission measurement
 3. All measurements were made at 3 meters. Radiated emissions not detected at the 3-meter distance were measured at 0.3-meter and an inverse proportional extrapolation was performed to compare the signal level to the 3-meter limit. No other radiated emissions than those reported were detected at a test distance of 0.3-meter.
 4. Negative value in the margin column shows emission below limit.
 5. Horn antenna is used for the emission over 1000MHz.
 6. Emission (the row indicated by ***bold italic***) within the restricted band meets the requirement of FCC Part 15 Section 15.205 / RSS-Gen Section 8.10.
 7. For the measurement of radiated emission, summation method was used which numerical integrating (in terms of linear power) over the transmitter occupied bandwidth.
 8. For the linear power measurement, data in 1MHz spacing was collected by spectrum analyzer with 1MHz resolution bandwidth.

INTERTEK TESTING SERVICES

Mode: TX-Channel 01

Table 4
IEEE 802.11g (OFDM, 6 Mbps)

Radiated Emission Data

Polarization	Frequency (MHz)	Reading (dBμV)	Pre-Amp Gain (dB)	Antenna Factor (dB)	Net at 3m - Peak (dBμV/m)	Average Limit at 3m (dBμV/m)	Margin (dB)
<i>V</i>	<i>2390.000</i>	<i>54.1</i>	<i>33</i>	<i>29.4</i>	<i>50.5</i>	<i>54.0</i>	<i>-3.5</i>
<i>H</i>	<i>4824.000</i>	<i>39.9</i>	<i>33</i>	<i>34.9</i>	<i>41.8</i>	<i>54.0</i>	<i>-12.2</i>
<i>V</i>	<i>12060.000</i>	<i>34.6</i>	<i>33</i>	<i>40.5</i>	<i>42.1</i>	<i>54.0</i>	<i>-11.9</i>
<i>V</i>	<i>14472.000</i>	<i>36.2</i>	<i>33</i>	<i>40.0</i>	<i>43.2</i>	<i>54.0</i>	<i>-10.8</i>

Polarization	Frequency (MHz)	Reading (dBμV)	Pre-Amp Gain (dB)	Antenna Factor (dB)	Net at 3m - Peak (dBμV/m)	Peak Limit at 3m (dBμV/m)	Margin (dB)
<i>V</i>	<i>2390.000</i>	<i>69.5</i>	<i>33</i>	<i>29.4</i>	<i>65.9</i>	<i>74.0</i>	<i>-8.1</i>
<i>H</i>	<i>4824.000</i>	<i>51.5</i>	<i>33</i>	<i>34.9</i>	<i>53.4</i>	<i>74.0</i>	<i>-20.6</i>
<i>V</i>	<i>12060.000</i>	<i>47.7</i>	<i>33</i>	<i>40.5</i>	<i>55.2</i>	<i>74.0</i>	<i>-18.8</i>
<i>V</i>	<i>14472.000</i>	<i>49.7</i>	<i>33</i>	<i>40.0</i>	<i>56.7</i>	<i>74.0</i>	<i>-17.3</i>

- NOTES:
1. Peak detector is used for the emission measurement.
 2. Average detector is used for the average data of emission measurement
 3. All measurements were made at 3 meters. Radiated emissions not detected at the 3-meter distance were measured at 0.3-meter and an inverse proportional extrapolation was performed to compare the signal level to the 3-meter limit. No other radiated emissions than those reported were detected at a test distance of 0.3-meter.
 4. Negative value in the margin column shows emission below limit.
 5. Horn antenna is used for the emission over 1000MHz.
 6. Emission (the row indicated by ***bold italic***) within the restricted band meets the requirement of FCC Part 15 Section 15.205 / RSS-247 Section 3.3.
 7. For the measurement of radiated emission, summation method was used which numerical integrating (in terms of linear power) over the transmitter occupied bandwidth.
 8. For the linear power measurement, data in 1MHz spacing was collected by spectrum analyzer with 1MHz resolution bandwidth.

INTERTEK TESTING SERVICES

Mode: TX-Channel 06

Table 5
IEEE 802.11g (OFDM, 6 Mbps)

Radiated Emission Data

Polarization	Frequency (MHz)	Reading (dB μ V)	Pre-Amp Gain (dB)	Antenna Factor (dB)	Net at 3m - Peak (dB μ V/m)	Average Limit at 3m (dB μ V/m)	Margin (dB)
<i>H</i>	<i>4874.000</i>	<i>40.0</i>	<i>33</i>	<i>34.9</i>	<i>41.9</i>	<i>54.0</i>	<i>-12.1</i>
<i>V</i>	<i>7311.000</i>	<i>40.1</i>	<i>33</i>	<i>37.9</i>	<i>45.0</i>	<i>54.0</i>	<i>-9.0</i>
<i>V</i>	<i>12185.000</i>	<i>34.4</i>	<i>33</i>	<i>40.5</i>	<i>41.9</i>	<i>54.0</i>	<i>-12.1</i>

Polarization	Frequency (MHz)	Reading (dB μ V)	Pre-Amp Gain (dB)	Antenna Factor (dB)	Net at 3m - Peak (dB μ V/m)	Peak Limit at 3m (dB μ V/m)	Margin (dB)
<i>H</i>	<i>4874.000</i>	<i>51.7</i>	<i>33</i>	<i>34.9</i>	<i>53.6</i>	<i>74.0</i>	<i>-20.4</i>
<i>V</i>	<i>7311.000</i>	<i>55.2</i>	<i>33</i>	<i>37.9</i>	<i>60.1</i>	<i>74.0</i>	<i>-13.9</i>
<i>V</i>	<i>12185.000</i>	<i>47.5</i>	<i>33</i>	<i>40.5</i>	<i>55.0</i>	<i>74.0</i>	<i>-19.0</i>

- NOTES:
1. Peak detector is used for the emission measurement.
 2. Average detector is used for the average data of emission measurement
 3. All measurements were made at 3 meters. Radiated emissions not detected at the 3-meter distance were measured at 0.3-meter and an inverse proportional extrapolation was performed to compare the signal level to the 3-meter limit. No other radiated emissions than those reported were detected at a test distance of 0.3-meter.
 4. Negative value in the margin column shows emission below limit.
 5. Horn antenna is used for the emission over 1000MHz.
 6. Emission (the row indicated by ***bold italic***) within the restricted band meets the requirement of FCC Part 15 Section 15.205 / RSS-Gen Section 8.10.
 7. For the measurement of radiated emission, summation method was used which numerical integrating (in terms of linear power) over the transmitter occupied bandwidth.
 8. For the linear power measurement, data in 1MHz spacing was collected by spectrum analyzer with 1MHz resolution bandwidth.

INTERTEK TESTING SERVICES

Mode: TX-Channel 11

Table 6
IEEE 802.11g (OFDM, 6 Mbps)

Radiated Emission Data

Polarization	Frequency (MHz)	Reading (dBμV)	Pre-Amp Gain (dB)	Antenna Factor (dB)	Net at 3m - Peak (dBμV/m)	Average Limit at 3m (dBμV/m)	Margin (dB)
<i>V</i>	<i>2483.500</i>	<i>52.6</i>	<i>33</i>	<i>29.4</i>	<i>49.0</i>	<i>54.0</i>	<i>-5.0</i>
<i>H</i>	<i>4924.000</i>	<i>39.7</i>	<i>33</i>	<i>34.9</i>	<i>41.6</i>	<i>54.0</i>	<i>-12.4</i>
<i>V</i>	<i>7386.000</i>	<i>39.8</i>	<i>33</i>	<i>37.9</i>	<i>44.7</i>	<i>54.0</i>	<i>-9.3</i>
<i>V</i>	<i>12310.000</i>	<i>34.3</i>	<i>33</i>	<i>40.5</i>	<i>41.8</i>	<i>54.0</i>	<i>-12.2</i>

Polarization	Frequency (MHz)	Reading (dBμV)	Pre-Amp Gain (dB)	Antenna Factor (dB)	Net at 3m - Peak (dBμV/m)	Peak Limit at 3m (dBμV/m)	Margin (dB)
<i>V</i>	<i>2483.500</i>	<i>66.8</i>	<i>33</i>	<i>29.4</i>	<i>63.2</i>	<i>74.0</i>	<i>-10.8</i>
<i>H</i>	<i>4924.000</i>	<i>51.4</i>	<i>33</i>	<i>34.9</i>	<i>53.3</i>	<i>74.0</i>	<i>-20.7</i>
<i>V</i>	<i>7386.000</i>	<i>55.0</i>	<i>33</i>	<i>37.9</i>	<i>59.9</i>	<i>74.0</i>	<i>-14.1</i>
<i>V</i>	<i>12310.000</i>	<i>47.3</i>	<i>33</i>	<i>40.5</i>	<i>54.8</i>	<i>74.0</i>	<i>-19.2</i>

- NOTES:
1. Peak detector is used for the emission measurement.
 2. Average detector is used for the average data of emission measurement
 3. All measurements were made at 3 meters. Radiated emissions not detected at the 3-meter distance were measured at 0.3-meter and an inverse proportional extrapolation was performed to compare the signal level to the 3-meter limit. No other radiated emissions than those reported were detected at a test distance of 0.3-meter.
 4. Negative value in the margin column shows emission below limit.
 5. Horn antenna is used for the emission over 1000MHz.
 6. Emission (the row indicated by ***bold italic***) within the restricted band meets the requirement of FCC Part 15 Section 15.205 / RSS-Gen Section 8.10.
 7. For the measurement of radiated emission, summation method was used which numerical integrating (in terms of linear power) over the transmitter occupied bandwidth.
 8. For the linear power measurement, data in 1MHz spacing was collected by spectrum analyzer with 1MHz resolution bandwidth.

INTERTEK TESTING SERVICES

Mode: TX-Channel 01

Table 7
IEEE 802.11n (20MHz) (OFDM, MCS0)

Radiated Emission Data

Polarization	Frequency (MHz)	Reading (dBμV)	Pre-Amp Gain (dB)	Antenna Factor (dB)	Net at 3m - Peak (dBμV/m)	Average Limit at 3m (dBμV/m)	Margin (dB)
V	2390.000	54.7	33	29.4	51.1	54.0	-2.9
H	4824.000	40.6	33	34.9	42.5	54.0	-11.5
V	12060.000	34.7	33	40.5	42.2	54.0	-11.8
V	14472.000	36.4	33	40.0	43.4	54.0	-10.6

Polarization	Frequency (MHz)	Reading (dBμV)	Pre-Amp Gain (dB)	Antenna Factor (dB)	Net at 3m - Peak (dBμV/m)	Peak Limit at 3m (dBμV/m)	Margin (dB)
V	2390.000	69.6	33	29.4	66.0	74.0	-8.0
H	4824.000	52.0	33	34.9	53.9	74.0	-20.1
V	12060.000	47.9	33	40.5	55.4	74.0	-18.6
V	14472.000	49.6	33	40.0	56.6	74.0	-17.4

- NOTES:
1. Peak detector is used for the emission measurement.
 2. Average detector is used for the average data of emission measurement
 3. All measurements were made at 3 meters. Radiated emissions not detected at the 3-meter distance were measured at 0.3-meter and an inverse proportional extrapolation was performed to compare the signal level to the 3-meter limit. No other radiated emissions than those reported were detected at a test distance of 0.3-meter.
 4. Negative value in the margin column shows emission below limit.
 5. Horn antenna is used for the emission over 1000MHz.
 6. Emission (the row indicated by **bold italic**) within the restricted band meets the requirement of FCC Part 15 Section 15.205 / RSS-Gen Section 8.10.
 7. For the measurement of radiated emission, summation method was used which numerical integrating (in terms of linear power) over the transmitter occupied bandwidth.
 8. For the linear power measurement, data in 1MHz spacing was collected by spectrum analyzer with 1MHz resolution bandwidth.

INTERTEK TESTING SERVICES

Mode: TX-Channel 06

Table 8
IEEE 802.11n (20MHz) (OFDM, MCS0)

Radiated Emission Data

Polarization	Frequency (MHz)	Reading (dB μ V)	Pre-Amp Gain (dB)	Antenna Factor (dB)	Net at 3m - Peak (dB μ V/m)	Average Limit at 3m (dB μ V/m)	Margin (dB)
<i>H</i>	<i>4874.000</i>	<i>40.6</i>	<i>33</i>	<i>34.9</i>	<i>42.5</i>	<i>54.0</i>	<i>-11.5</i>
<i>V</i>	<i>7311.000</i>	<i>38.8</i>	<i>33</i>	<i>37.9</i>	<i>43.7</i>	<i>54.0</i>	<i>-10.3</i>
<i>V</i>	<i>12185.000</i>	<i>34.5</i>	<i>33</i>	<i>40.5</i>	<i>42.0</i>	<i>54.0</i>	<i>-12.0</i>

Polarization	Frequency (MHz)	Reading (dB μ V)	Pre-Amp Gain (dB)	Antenna Factor (dB)	Net at 3m - Peak (dB μ V/m)	Peak Limit at 3m (dB μ V/m)	Margin (dB)
<i>H</i>	<i>4874.000</i>	<i>52.1</i>	<i>33</i>	<i>34.9</i>	<i>54.0</i>	<i>74.0</i>	<i>-20.0</i>
<i>V</i>	<i>7311.000</i>	<i>52.4</i>	<i>33</i>	<i>37.9</i>	<i>57.3</i>	<i>74.0</i>	<i>-16.7</i>
<i>V</i>	<i>12185.000</i>	<i>47.7</i>	<i>33</i>	<i>40.5</i>	<i>55.2</i>	<i>74.0</i>	<i>-18.8</i>

- NOTES:
1. Peak detector is used for the emission measurement.
 2. Average detector is used for the average data of emission measurement
 3. All measurements were made at 3 meters. Radiated emissions not detected at the 3-meter distance were measured at 0.3-meter and an inverse proportional extrapolation was performed to compare the signal level to the 3-meter limit. No other radiated emissions than those reported were detected at a test distance of 0.3-meter.
 4. Negative value in the margin column shows emission below limit.
 5. Horn antenna is used for the emission over 1000MHz.
 6. Emission (the row indicated by ***bold italic***) within the restricted band meets the requirement of FCC Part 15 Section 15.205 / RSS-Gen Section 8.10.
 7. For the measurement of radiated emission, summation method was used which numerical integrating (in terms of linear power) over the transmitter occupied bandwidth.
 8. For the linear power measurement, data in 1MHz spacing was collected by spectrum analyzer with 1MHz resolution bandwidth.

INTERTEK TESTING SERVICES

Mode: TX-Channel 11

Table 9
IEEE 802.11n (20MHz) (OFDM, MCS0)

Radiated Emission Data

Polarization	Frequency (MHz)	Reading (dB μ V)	Pre-Amp Gain (dB)	Antenna Factor (dB)	Net at 3m - Peak (dB μ V/m)	Average Limit at 3m (dB μ V/m)	Margin (dB)
<i>V</i>	<i>2483.500</i>	<i>52.8</i>	<i>33</i>	<i>29.4</i>	<i>49.2</i>	<i>54.0</i>	<i>-4.8</i>
<i>H</i>	<i>4924.000</i>	<i>40.0</i>	<i>33</i>	<i>34.9</i>	<i>41.9</i>	<i>54.0</i>	<i>-12.1</i>
<i>V</i>	<i>7386.000</i>	<i>38.4</i>	<i>33</i>	<i>37.9</i>	<i>43.3</i>	<i>54.0</i>	<i>-10.7</i>
<i>V</i>	<i>12310.000</i>	<i>34.4</i>	<i>33</i>	<i>40.5</i>	<i>41.9</i>	<i>54.0</i>	<i>-12.1</i>

Polarization	Frequency (MHz)	Reading (dB μ V)	Pre-Amp Gain (dB)	Antenna Factor (dB)	Net at 3m - Peak (dB μ V/m)	Peak Limit at 3m (dB μ V/m)	Margin (dB)
<i>V</i>	<i>2483.500</i>	<i>66.9</i>	<i>33</i>	<i>29.4</i>	<i>63.3</i>	<i>74.0</i>	<i>-10.7</i>
<i>H</i>	<i>4924.000</i>	<i>51.7</i>	<i>33</i>	<i>34.9</i>	<i>53.6</i>	<i>74.0</i>	<i>-20.4</i>
<i>V</i>	<i>7386.000</i>	<i>52.0</i>	<i>33</i>	<i>37.9</i>	<i>56.9</i>	<i>74.0</i>	<i>-17.1</i>
<i>V</i>	<i>12310.000</i>	<i>47.6</i>	<i>33</i>	<i>40.5</i>	<i>55.1</i>	<i>74.0</i>	<i>-18.9</i>

- NOTES:
1. Peak detector is used for the emission measurement.
 2. Average detector is used for the average data of emission measurement
 3. All measurements were made at 3 meters. Radiated emissions not detected at the 3-meter distance were measured at 0.3-meter and an inverse proportional extrapolation was performed to compare the signal level to the 3-meter limit. No other radiated emissions than those reported were detected at a test distance of 0.3-meter.
 4. Negative value in the margin column shows emission below limit.
 5. Horn antenna is used for the emission over 1000MHz.
 6. Emission (the row indicated by ***bold italic***) within the restricted band meets the requirement of FCC Part 15 Section 15.205 / RSS-Gen Section 8.10.
 7. For the measurement of radiated emission, summation method was used which numerical integrating (in terms of linear power) over the transmitter occupied bandwidth.
 8. For the linear power measurement, data in 1MHz spacing was collected by spectrum analyzer with 1MHz resolution bandwidth.

INTERTEK TESTING SERVICES

Mode: TX-Channel 03

Table 10
IEEE 802.11n (40MHz) (OFDM, MCS0)

Radiated Emission Data

Polarization	Frequency (MHz)	Reading (dBμV)	Pre-Amp Gain (dB)	Antenna Factor (dB)	Net at 3m - Peak (dBμV/m)	Average Limit at 3m (dBμV/m)	Margin (dB)
V	2390.000	54.8	33	29.4	51.2	54.0	-2.8
H	4844.000	39.7	33	34.9	41.6	54.0	-12.4
V	7266.000	38.8	33	37.9	43.7	54.0	-10.3
V	12110.000	34.6	33	40.5	42.1	54.0	-11.9

Polarization	Frequency (MHz)	Reading (dBμV)	Pre-Amp Gain (dB)	Antenna Factor (dB)	Net at 3m - Peak (dBμV/m)	Peak Limit at 3m (dBμV/m)	Margin (dB)
V	2390.000	69.3	33	29.4	65.7	74.0	-8.3
H	4844.000	50.8	33	34.9	52.7	74.0	-21.3
V	7266.000	52.4	33	37.9	57.3	74.0	-16.7
V	12110.000	47.8	33	40.5	55.3	74.0	-18.7

- NOTES:
1. Peak detector is used for the emission measurement.
 2. Average detector is used for the average data of emission measurement
 3. All measurements were made at 3 meters. Radiated emissions not detected at the 3-meter distance were measured at 0.3-meter and an inverse proportional extrapolation was performed to compare the signal level to the 3-meter limit. No other radiated emissions than those reported were detected at a test distance of 0.3-meter.
 4. Negative value in the margin column shows emission below limit.
 5. Horn antenna is used for the emission over 1000MHz.
 6. Emission (the row indicated by **bold italic**) within the restricted band meets the requirement of FCC Part 15 Section 15.205 / RSS-Gen Section 8.10.
 7. For the measurement of radiated emission, summation method was used which numerical integrating (in terms of linear power) over the transmitter occupied bandwidth.
 8. For the linear power measurement, data in 1MHz spacing was collected by spectrum analyzer with 1MHz resolution bandwidth.

INTERTEK TESTING SERVICES

Mode: TX-Channel 06

Table 11
IEEE 802.11n (40MHz) (OFDM, MCS0)

Radiated Emission Data

Polarization	Frequency (MHz)	Reading (dB μ V)	Pre-Amp Gain (dB)	Antenna Factor (dB)	Net at 3m - Peak (dB μ V/m)	Average Limit at 3m (dB μ V/m)	Margin (dB)
<i>H</i>	<i>4874.000</i>	<i>39.8</i>	<i>33</i>	<i>34.9</i>	<i>41.7</i>	<i>54.0</i>	<i>-12.3</i>
<i>V</i>	<i>7311.000</i>	<i>38.9</i>	<i>33</i>	<i>37.9</i>	<i>43.8</i>	<i>54.0</i>	<i>-10.2</i>
<i>V</i>	<i>12185.000</i>	<i>34.8</i>	<i>33</i>	<i>40.5</i>	<i>42.3</i>	<i>54.0</i>	<i>-11.7</i>

Polarization	Frequency (MHz)	Reading (dB μ V)	Pre-Amp Gain (dB)	Antenna Factor (dB)	Net at 3m - Peak (dB μ V/m)	Peak Limit at 3m (dB μ V/m)	Margin (dB)
<i>H</i>	<i>4874.000</i>	<i>50.9</i>	<i>33</i>	<i>34.9</i>	<i>52.8</i>	<i>74.0</i>	<i>-21.2</i>
<i>V</i>	<i>7311.000</i>	<i>52.6</i>	<i>33</i>	<i>37.9</i>	<i>57.5</i>	<i>74.0</i>	<i>-16.5</i>
<i>V</i>	<i>12185.000</i>	<i>47.9</i>	<i>33</i>	<i>40.5</i>	<i>55.4</i>	<i>74.0</i>	<i>-18.6</i>

- NOTES:
1. Peak detector is used for the emission measurement.
 2. Average detector is used for the average data of emission measurement
 3. All measurements were made at 3 meters. Radiated emissions not detected at the 3-meter distance were measured at 0.3-meter and an inverse proportional extrapolation was performed to compare the signal level to the 3-meter limit. No other radiated emissions than those reported were detected at a test distance of 0.3-meter.
 4. Negative value in the margin column shows emission below limit.
 5. Horn antenna is used for the emission over 1000MHz.
 6. Emission (the row indicated by ***bold italic***) within the restricted band meets the requirement of FCC Part 15 Section 15.205 / RSS-Gen Section 8.10.
 7. For the measurement of radiated emission, summation method was used which numerical integrating (in terms of linear power) over the transmitter occupied bandwidth.
 8. For the linear power measurement, data in 1MHz spacing was collected by spectrum analyzer with 1MHz resolution bandwidth.

INTERTEK TESTING SERVICES

Mode: TX-Channel 09

Table 12
IEEE 802.11n (40MHz) (OFDM, MCS0)

Radiated Emission Data

Polarization	Frequency (MHz)	Reading (dB μ V)	Pre-Amp Gain (dB)	Antenna Factor (dB)	Net at 3m - Peak (dB μ V/m)	Average Limit at 3m (dB μ V/m)	Margin (dB)
<i>V</i>	<i>2483.500</i>	<i>52.4</i>	<i>33</i>	<i>29.4</i>	<i>48.8</i>	<i>54.0</i>	<i>-5.2</i>
<i>H</i>	<i>4904.000</i>	<i>39.5</i>	<i>33</i>	<i>34.9</i>	<i>41.4</i>	<i>54.0</i>	<i>-12.6</i>
<i>V</i>	<i>7356.000</i>	<i>38.2</i>	<i>33</i>	<i>37.9</i>	<i>43.1</i>	<i>54.0</i>	<i>-10.9</i>
<i>V</i>	<i>12260.000</i>	<i>34.7</i>	<i>33</i>	<i>40.5</i>	<i>42.2</i>	<i>54.0</i>	<i>-11.8</i>

Polarization	Frequency (MHz)	Reading (dB μ V)	Pre-Amp Gain (dB)	Antenna Factor (dB)	Net at 3m - Peak (dB μ V/m)	Peak Limit at 3m (dB μ V/m)	Margin (dB)
<i>V</i>	<i>2483.500</i>	<i>66.7</i>	<i>33</i>	<i>29.4</i>	<i>63.1</i>	<i>74.0</i>	<i>-10.9</i>
<i>H</i>	<i>4904.000</i>	<i>50.6</i>	<i>33</i>	<i>34.9</i>	<i>52.5</i>	<i>74.0</i>	<i>-21.5</i>
<i>V</i>	<i>7356.000</i>	<i>51.9</i>	<i>33</i>	<i>37.9</i>	<i>56.8</i>	<i>74.0</i>	<i>-17.2</i>
<i>V</i>	<i>12260.000</i>	<i>47.8</i>	<i>33</i>	<i>40.5</i>	<i>55.3</i>	<i>74.0</i>	<i>-18.7</i>

- NOTES:
1. Peak detector is used for the emission measurement.
 2. Average detector is used for the average data of emission measurement
 3. All measurements were made at 3 meters. Radiated emissions not detected at the 3-meter distance were measured at 0.3-meter and an inverse proportional extrapolation was performed to compare the signal level to the 3-meter limit. No other radiated emissions than those reported were detected at a test distance of 0.3-meter.
 4. Negative value in the margin column shows emission below limit.
 5. Horn antenna is used for the emission over 1000MHz.
 6. Emission (the row indicated by ***bold italic***) within the restricted band meets the requirement of FCC Part 15 Section 15.205 / RSS-Gen Section 8.10.
 7. For the measurement of radiated emission, summation method was used which numerical integrating (in terms of linear power) over the transmitter occupied bandwidth.
 8. For the linear power measurement, data in 1MHz spacing was collected by spectrum analyzer with 1MHz resolution bandwidth.

INTERTEK TESTING SERVICES

Mode: WiFi Tx Other

Table 13

Radiated Emission Data

Polarization	Frequency (MHz)	Reading (dB μ V)	Pre-amp (dB)	Antenna Factor (dB)	Net at 3m (dB μ V/m)	Limit at 3m (dB μ V/m)	Margin (dB)
V	349.978	31.0	16	24.0	39.0	46.0	-7.0
H	399.930	30.2	16	25.0	39.2	46.0	-6.8
H	450.000	34.2	16	26.0	44.2	46.0	-1.8
H	499.988	31.6	16	26.0	41.6	46.0	-4.4
H	650.074	29.7	16	29.0	42.7	46.0	-3.3
H	668.263	32.3	16	29.0	45.3	46.0	-0.7
H	925.400	23.2	16	33.0	40.2	46.0	-5.8

- NOTES:
1. Peak detector is used for the emission measurement.
 2. All measurements were made at 3 meters. Radiated emissions not detected at the 3-meter distance were measured at 0.3-meter and an inverse proportional extrapolation was performed to compare the signal level to the 3-meter limit. No other radiated emissions than those reported were detected at a test distance of 0.3-meter.
 3. Negative value in the margin column shows emission below limit.
 4. Emission (the row indicated by **bold italic**) within the restricted band meets the requirement of FCC Part 15 Section 15.205 / RSS-247 Section 2.2.

INTERTEK TESTING SERVICES

Mode: WIFI Online & Connect to Baby Unit & Adaptor Charging (4GRAM)

Table 14

Radiated Emission Data

Polarization	Frequency (MHz)	Reading (dB μ V)	Pre-amp (dB)	Antenna Factor (dB)	Net at 3m (dB μ V/m)	Limit at 3m (dB μ V/m)	Margin (dB)
H	222.784	36.5	16	18.0	38.5	46.0	-7.5
V	349.976	31.3	16	24.0	39.3	46.0	-6.7
H	399.935	35.1	16	25.0	44.1	46.0	-1.9
V	450.015	31.9	16	26.0	41.9	46.0	-4.1
V	500.080	29.9	16	26.0	39.9	46.0	-6.1
V	599.991	26.2	16	29.0	39.2	46.0	-6.8
V	650.074	30.9	16	29.0	43.9	46.0	-2.1
V	668.262	32.0	16	29.0	45.0	46.0	-1.0

- NOTES:
1. Peak detector is used for the emission measurement.
 2. All measurements were made at 3 meters. Radiated emissions not detected at the 3-meter distance were measured at 0.3-meter and an inverse proportional extrapolation was performed to compare the signal level to the 3-meter limit. No other radiated emissions than those reported were detected at a test distance of 0.3-meter.
 3. Negative value in the margin column shows emission below limit.
 4. Emission (the row indicated by **bold italic**) within the restricted band meets the requirement of FCC Part 15 Section 15.205 / RSS-247 Section 2.2.

INTERTEK TESTING SERVICES

Mode: WIFI Online & Connect to Baby Unit & Adaptor Charging (8GRAM)

Table 15

Radiated Emission Data

Polarization	Frequency (MHz)	Reading (dB μ V)	Pre-amp (dB)	Antenna Factor (dB)	Net at 3m (dB μ V/m)	Limit at 3m (dB μ V/m)	Margin (dB)
V	47.338	39.9	16	11.0	34.9	40.0	-5.1
V	74.620	41.2	16	6.0	31.2	40.0	-8.8
V	117.785	38.3	16	14.0	36.3	43.5	-7.2
V	160.465	41.7	16	16.0	41.7	43.5	-1.8
V	187.988	40.6	16	16.0	40.6	43.5	-2.9
H	349.995	37.0	16	24.0	45.0	46.0	-1.0
H	399.933	33.8	16	25.0	42.8	46.0	-3.2
H	449.994	35.5	16	26.0	45.5	46.0	-0.5
H	599.996	24.1	16	29.0	37.1	46.0	-8.9
V	857.410	25.6	16	31.0	40.6	46.0	-5.4

- NOTES:
1. Peak detector is used for the emission measurement.
 2. All measurements were made at 3 meters. Radiated emissions not detected at the 3-meter distance were measured at 0.3-meter and an inverse proportional extrapolation was performed to compare the signal level to the 3-meter limit. No other radiated emissions than those reported were detected at a test distance of 0.3-meter.
 3. Negative value in the margin column shows emission below limit.
 4. Emission (the row indicated by **bold italic**) within the restricted band meets the requirement of FCC Part 15 Section 15.205 / RSS-247 Section 2.2.

INTERTEK TESTING SERVICES

Mode: WIFI Online & Connect to Baby Unit & REC & Adaptor Charging (4GRAM)

Table 16

Radiated Emission Data

Polarization	Frequency (MHz)	Reading (dB μ V)	Pre-amp (dB)	Antenna Factor (dB)	Net at 3m (dB μ V/m)	Limit at 3m (dB μ V/m)	Margin (dB)
V	31.212	35.1	16	10.0	29.1	40.0	-10.9
V	79.470	41.9	16	6.0	31.9	40.0	-8.1
V	175.378	34.6	16	19.0	37.6	43.5	-5.9
V	249.947	37.6	16	20.0	41.6	46.0	-4.4
V	375.077	32.0	16	24.0	40.0	46.0	-6.0
H	449.990	35.5	16	26.0	45.5	46.0	-0.5
H	456.012	30.0	16	26.0	40.0	46.0	-6.0
V	500.086	30.3	16	26.0	40.3	46.0	-5.7
H	668.236	31.1	16	29.0	44.1	46.0	-1.9
V	715.183	28.9	16	30.0	42.9	46.0	-3.1
V	855.955	27.0	16	31.0	42.0	46.0	-4.0
V	960.230	26.7	16	33.0	43.7	54.0	-10.3

- NOTES:
1. Peak detector is used for the emission measurement.
 2. All measurements were made at 3 meters. Radiated emissions not detected at the 3-meter distance were measured at 0.3-meter and an inverse proportional extrapolation was performed to compare the signal level to the 3-meter limit. No other radiated emissions than those reported were detected at a test distance of 0.3-meter.
 3. Negative value in the margin column shows emission below limit.
 4. Emission (the row indicated by **bold italic**) within the restricted band meets the requirement of FCC Part 15 Section 15.205 / RSS-247 Section 2.2.

INTERTEK TESTING SERVICES

Mode: WIFI Online & Connect to Baby Unit & REC & Adaptor Charging (8GRAM)

Table 17

Radiated Emission Data

Polarization	Frequency (MHz)	Reading (dB μ V)	Pre-amp (dB)	Antenna Factor (dB)	Net at 3m (dB μ V/m)	Limit at 3m (dB μ V/m)	Margin (dB)
V	249.986	37.7	16	20.0	41.7	46.0	-4.3
H	350.017	37.5	16	24.0	45.5	46.0	-0.5
V	375.028	33.5	16	24.0	41.5	46.0	-4.5
H	399.985	35.2	16	25.0	44.2	46.0	-1.8
H	450.000	35.4	16	26.0	45.4	46.0	-0.6
V	500.049	31.8	16	26.0	41.8	46.0	-4.2
V	650.182	30.9	16	29.0	43.9	46.0	-2.1
V	712.471	28.2	16	30.0	42.2	46.0	-3.8

- NOTES:
1. Peak detector is used for the emission measurement.
 2. All measurements were made at 3 meters. Radiated emissions not detected at the 3-meter distance were measured at 0.3-meter and an inverse proportional extrapolation was performed to compare the signal level to the 3-meter limit. No other radiated emissions than those reported were detected at a test distance of 0.3-meter.
 3. Negative value in the margin column shows emission below limit.
 4. Emission (the row indicated by ***bold italic***) within the restricted band meets the requirement of FCC Part 15 Section 15.205 / RSS-247 Section 2.2.

INTERTEK TESTING SERVICES

Mode: WIFI Online Video Playing & Adaptor Charging (4GRAM)

Table 18

Radiated Emission Data

Polarization	Frequency (MHz)	Reading (dB μ V)	Pre-amp (dB)	Antenna Factor (dB)	Net at 3m (dB μ V/m)	Limit at 3m (dB μ V/m)	Margin (dB)
V	179.380	25.4	16	20.0	29.4	43.5	-14.1
H	222.787	36.7	16	18.0	38.7	46.0	-7.3
H	462.590	32.4	16	26.0	42.4	46.0	-3.6
V	557.195	27.6	16	28.0	39.6	46.0	-6.4
V	599.996	28.3	16	29.0	41.3	46.0	-4.7
V	650.072	28.4	16	29.0	41.4	46.0	-4.6
V	668.260	30.8	16	29.0	43.8	46.0	-2.2
H	925.432	24.8	16	33.0	41.8	46.0	-4.2

- NOTES:
1. Peak detector is used for the emission measurement.
 2. All measurements were made at 3 meters. Radiated emissions not detected at the 3-meter distance were measured at 0.3-meter and an inverse proportional extrapolation was performed to compare the signal level to the 3-meter limit. No other radiated emissions than those reported were detected at a test distance of 0.3-meter.
 3. Negative value in the margin column shows emission below limit.
 4. Emission (the row indicated by ***bold italic***) within the restricted band meets the requirement of FCC Part 15 Section 15.205 / RSS-247 Section 2.2.

INTERTEK TESTING SERVICES

Mode: WIFI Online Video Playing & Adaptor Charging (8GRAM)

Table 19

Radiated Emission Data

Polarization	Frequency (MHz)	Reading (dB μ V)	Pre-amp (dB)	Antenna Factor (dB)	Net at 3m (dB μ V/m)	Limit at 3m (dB μ V/m)	Margin (dB)
V	142.989	34.5	16	14.0	32.5	43.5	-11.0
V	250.285	35.2	16	20.0	39.2	46.0	-6.8
V	280.517	35.3	16	22.0	41.3	46.0	-4.7
H	350.002	34.3	16	24.0	42.3	46.0	-3.7
V	450.014	32.2	16	26.0	42.2	46.0	-3.8
H	468.439	33.8	16	26.0	43.8	46.0	-2.2
H	650.024	28.6	16	29.0	41.6	46.0	-4.4
H	920.247	25.0	16	33.0	42.0	46.0	-4.0

- NOTES:
1. Peak detector is used for the emission measurement.
 2. All measurements were made at 3 meters. Radiated emissions not detected at the 3-meter distance were measured at 0.3-meter and an inverse proportional extrapolation was performed to compare the signal level to the 3-meter limit. No other radiated emissions than those reported were detected at a test distance of 0.3-meter.
 3. Negative value in the margin column shows emission below limit.
 4. Emission (the row indicated by ***bold italic***) within the restricted band meets the requirement of FCC Part 15 Section 15.205 / RSS-247 Section 2.2.

INTERTEK TESTING SERVICES

4.6.3 Radiated Emission Test Setup

The figure below shows the test setup, which is utilized to make these measurements.

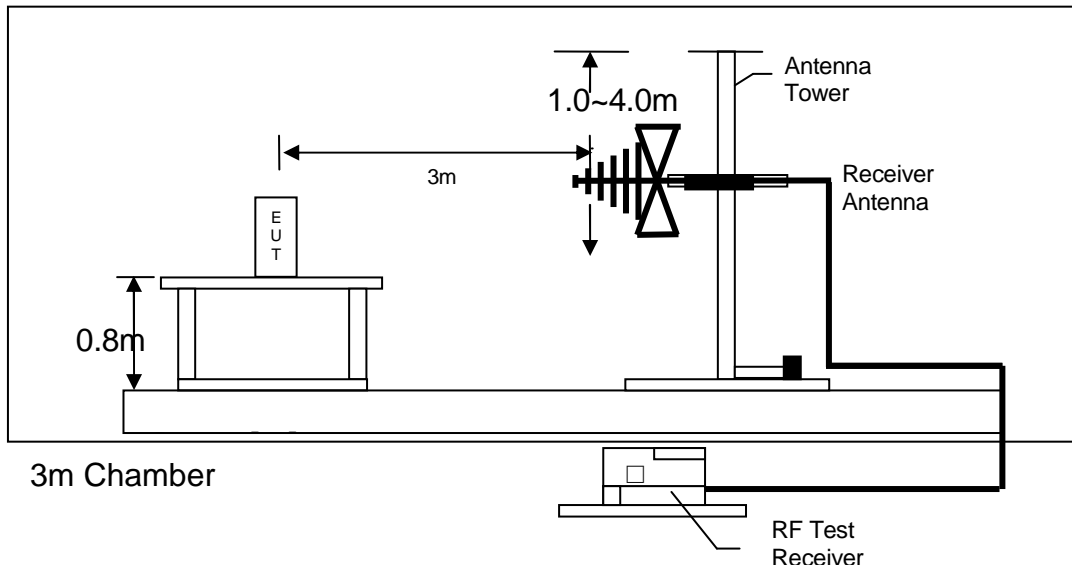

Test setup of radiated emissions up to 1GHz

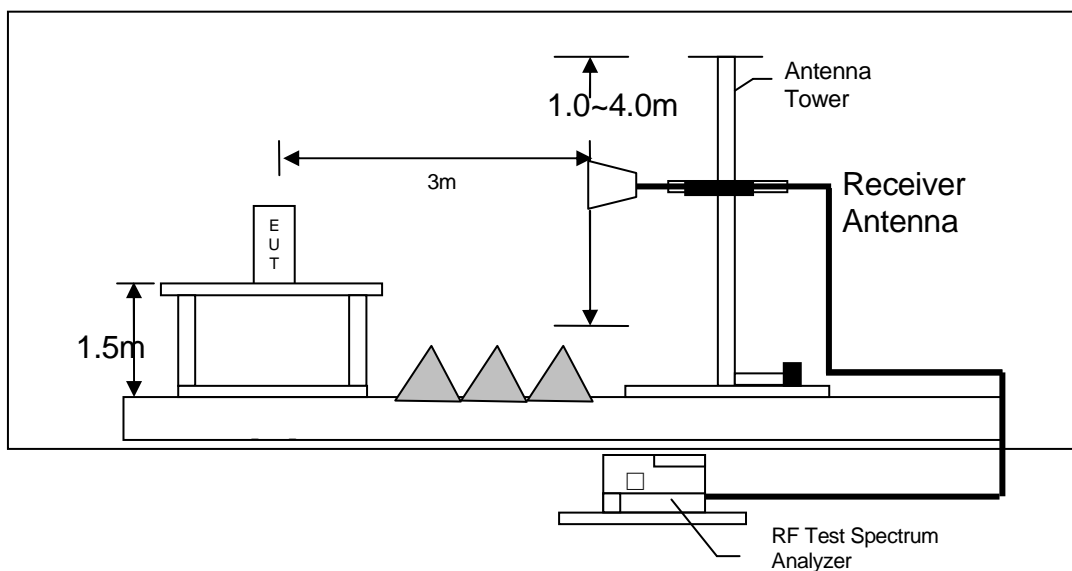

Test setup of radiated emissions above 1GHz

INTERTEK TESTING SERVICES

4.6.4 Transmitter Duty Cycle Calculation

Not applicable – No average factor is required.

INTERTEK TESTING SERVICES

4.7 AC Power Line Conducted Emission

- Not applicable – EUT is only powered by battery for operation.
- EUT connects to AC power line. Emission Data is listed in following pages.

- Base Unit connects to AC power line and has transmission. Handset connects to AC power line but has no transmission. Emission Data of Base Unit is listed in following pages.

4.7.1 AC Power Line Conducted Emission Configuration Photograph

Worst Case Line-Conducted Configuration
at
501 kHz

The worst case line conducted configuration photographs are attached in the Appendix and saved with filename: config photos.pdf

4.7.2 AC Power Line Conducted Emission Data

The plot(s) and data in the following pages list the significant emission frequencies, the limit and the margin of compliance.

Passed by 7.65 dB margin compare with CISPR Average limit

INTERTEK TESTING SERVICES

Worst Case: WIFI Online & Connect to Baby Unit & Adaptor Charging (4GRAM)

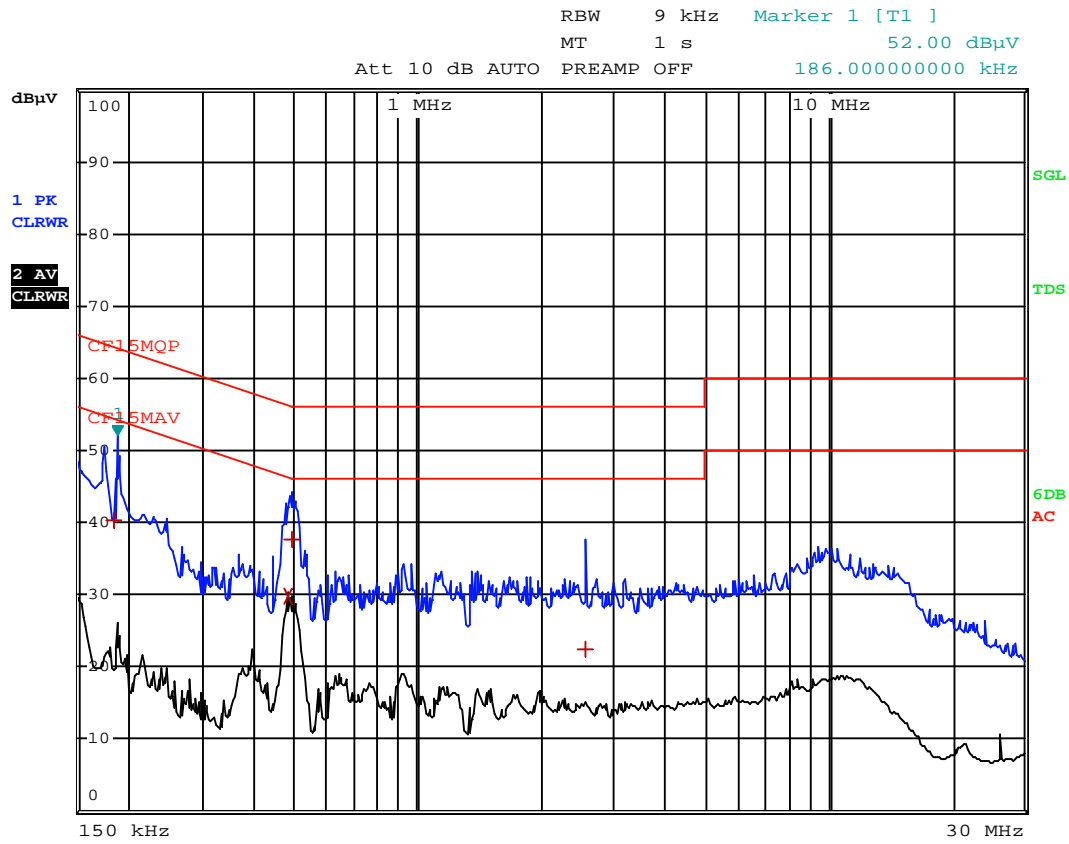

INTERTEK TESTING SERVICES

Worst Case: WIFI Online & Connect to Baby Unit & Adaptor Charging (4GRAM)

EDIT PEAK LIST (Final Measurement Results)				
Trace1:		CF15MQP		
Trace2:		CF15MAV		
Trace3:		---		
TRACE	FREQUENCY	LEVEL dBµV		DELTA LIMIT dB
1 Quasi Peak	186 kHz	40.18	N	-24.02
2 CISPR Average	483 kHz	29.80	L1	-16.48
1 Quasi Peak	492 kHz	37.77	N	-18.36
1 Quasi Peak	2.562 MHz	22.37	L1	-33.62

INTERTEK TESTING SERVICES

Worst Case: WIFI Online & Connect to Baby Unit & Adaptor Charging (8GRAM)



RBW 9 kHz
MT 1 s

Att 10 dB AUTO PREAMP OFF

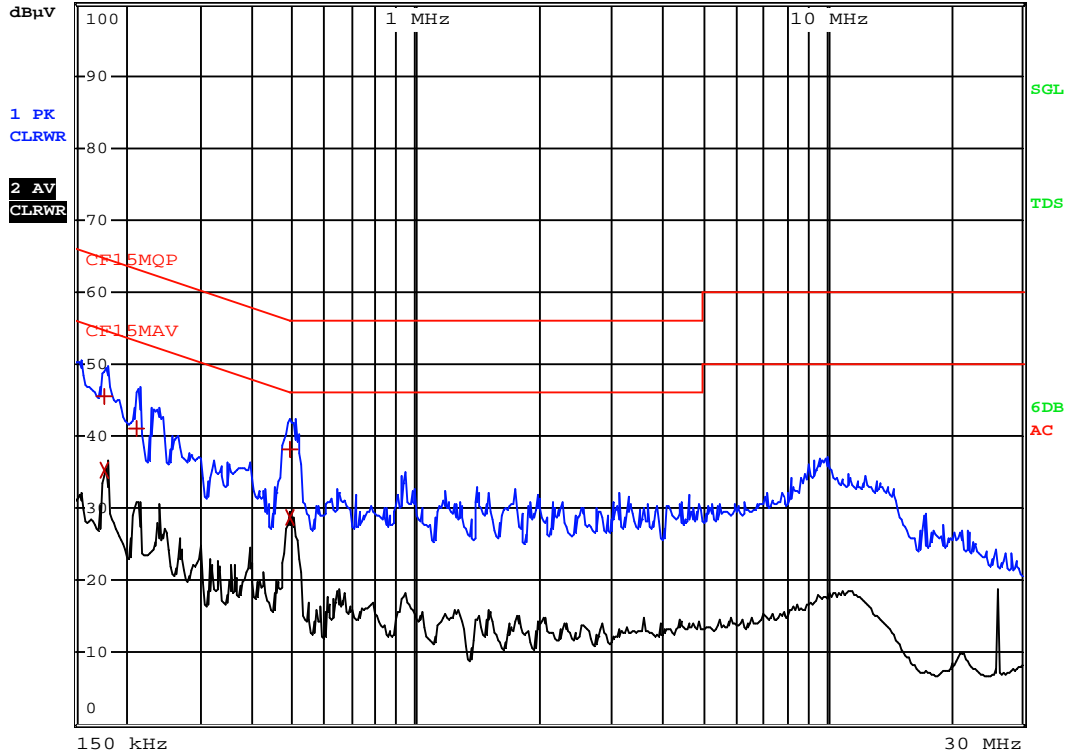

INTERTEK TESTING SERVICES

Worst Case: WIFI Online & Connect to Baby Unit & Adaptor Charging (8GRAM)

EDIT PEAK LIST (Final Measurement Results)				
Trace1:		CF15MQP		
Trace2:		CF15MAV		
Trace3:		---		
TRACE	FREQUENCY	LEVEL dBµV		DELTA LIMIT dB
1 Quasi Peak	177 kHz	45.58 L1		-19.04
2 CISPR Average	177 kHz	35.39 N		-19.23
1 Quasi Peak	213 kHz	41.13 L1		-21.94
1 Quasi Peak	492 kHz	38.19 L1		-17.94
2 CISPR Average	492 kHz	28.73 L1		-17.40

INTERTEK TESTING SERVICES

Worst Case: WIFI Online & Connect to Baby Unit & REC & Adaptor Charging (4GRAM)

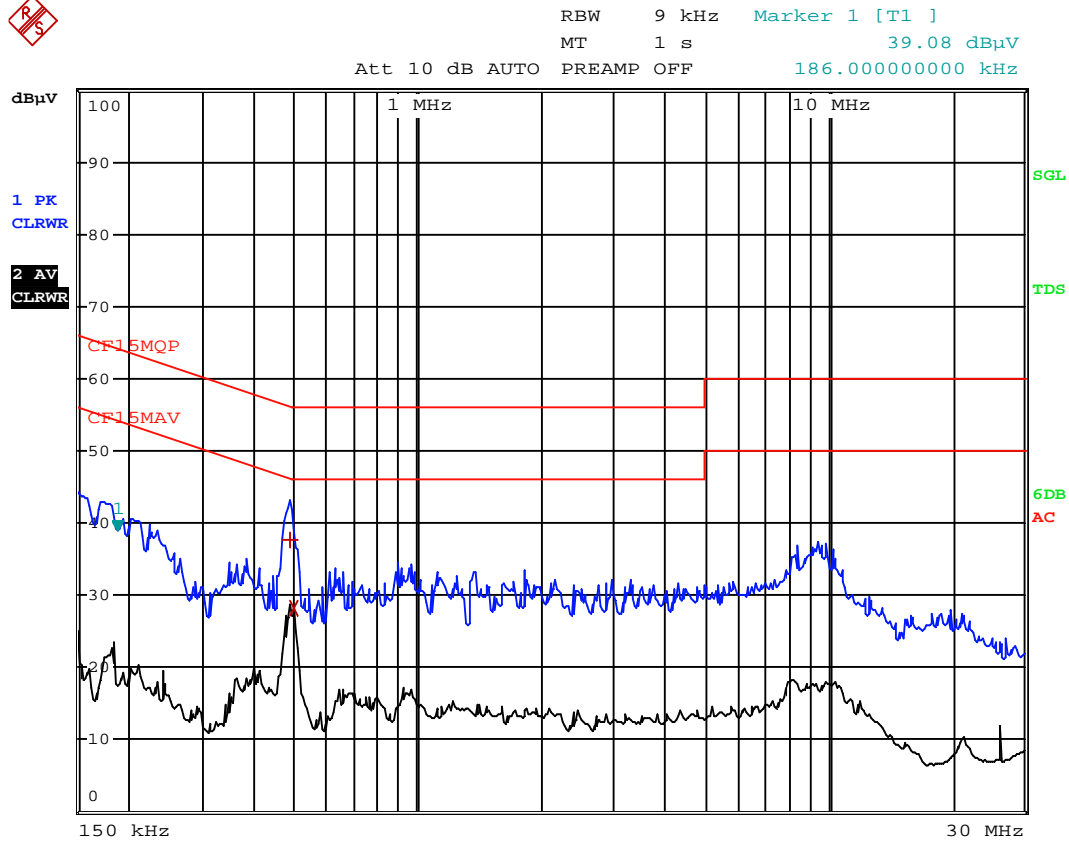

INTERTEK TESTING SERVICES

Worst Case: WIFI Online & Connect to Baby Unit & REC & Adaptor Charging (4GRAM)

EDIT PEAK LIST (Final Measurement Results)				
TRACE		FREQUENCY	LEVEL dB μ V	DELTA LIMIT dB
1	Quasi Peak	487.5 kHz	37.64 L1	-18.56
2	CISPR Average	496.5 kHz	28.19 N	-17.86

INTERTEK TESTING SERVICES

Worst Case: WIFI Online & Connect to Baby Unit & REC & Adaptor Charging (8GRAM)



RBW 9 kHz
MT 1 s

Att 10 dB AUTO PREAMP OFF

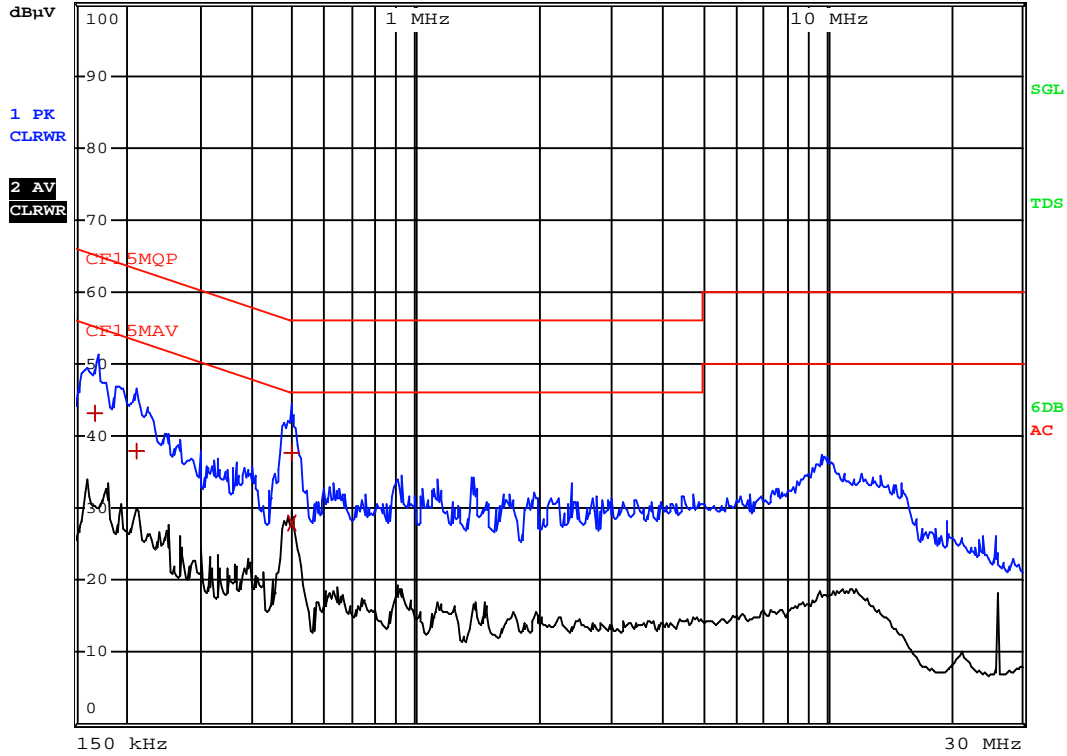

INTERTEK TESTING SERVICES

Worst Case: WIFI Online & Connect to Baby Unit & REC & Adaptor Charging (8GRAM)

EDIT PEAK LIST (Final Measurement Results)				
Trace1:		CF15MQP		
Trace2:		CF15MAV		
Trace3:		---		
TRACE	FREQUENCY	LEVEL dB μ V		DELTA LIMIT dB
1 Quasi Peak	168 kHz	43.27	N	-21.78
1 Quasi Peak	213 kHz	37.99	N	-25.09
1 Quasi Peak	496.5 kHz	37.60	L1	-18.45
2 CISPR Average	496.5 kHz	28.02	L1	-18.03

INTERTEK TESTING SERVICES

Worst Case: WIFI Online Video Playing & Adaptor Charging (4GRAM)



RBW 9 kHz

MT 1 s

Att 10 dB AUTO PREAMP OFF

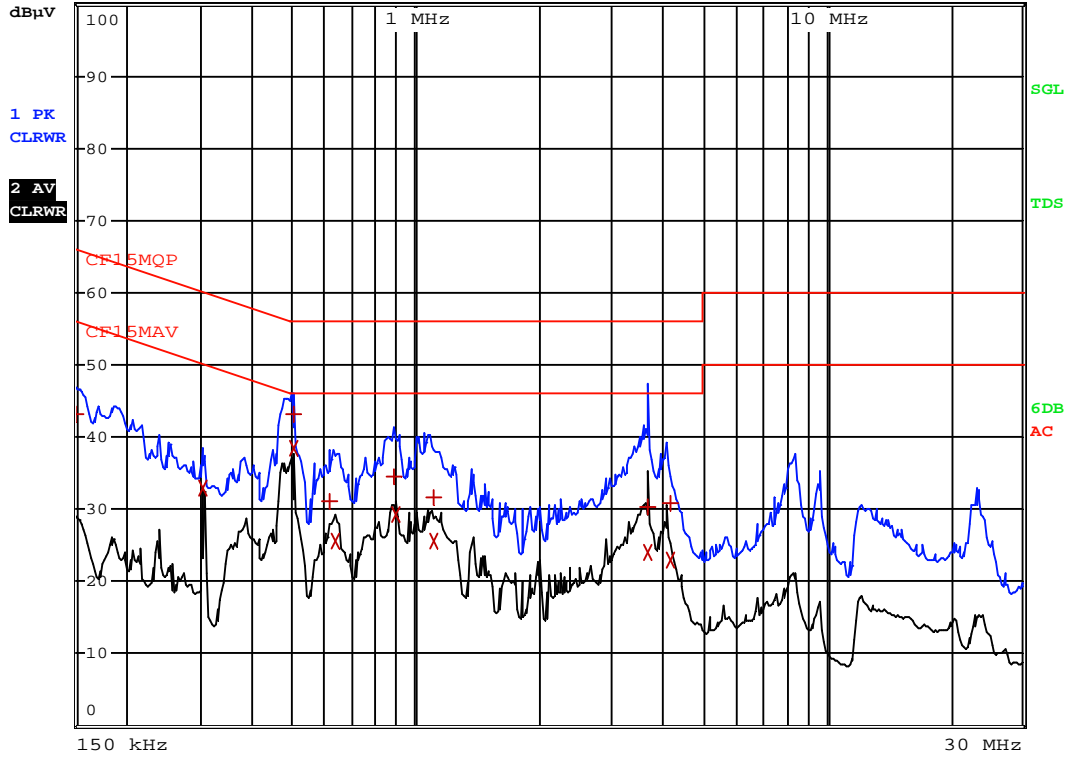

INTERTEK TESTING SERVICES

Worst Case: WIFI Online Video Playing & Adaptor Charging (4GRAM)

EDIT PEAK LIST (Final Measurement Results)				
Trace1:	CF15MQP			
Trace2:	CF15MAV			
Trace3:	---			
TRACE	FREQUENCY	LEVEL dBµV		DELTA LIMIT dB
1 Quasi Peak	150 kHz	43.06	N	-22.93
2 CISPR Average	303 kHz	33.03	N	-17.12
1 Quasi Peak	501 kHz	43.27	N	-12.73
2 CISPR Average	501 kHz	38.34	L1	-7.65
1 Quasi Peak	613.5 kHz	31.18	N	-24.81
2 CISPR Average	636 kHz	25.69	N	-20.30
1 Quasi Peak	888 kHz	34.41	L1	-21.59
2 CISPR Average	892.5 kHz	29.14	L1	-16.85
1 Quasi Peak	1.0995 MHz	31.55	L1	-24.44
2 CISPR Average	1.0995 MHz	25.61	N	-20.38
1 Quasi Peak	3.6825 MHz	30.35	L1	-25.64
2 CISPR Average	3.6825 MHz	23.97	N	-22.02
1 Quasi Peak	4.146 MHz	30.87	L1	-25.12
2 CISPR Average	4.146 MHz	22.99	L1	-23.00

INTERTEK TESTING SERVICES

Worst Case: WIFI Online Video Playing & Adaptor Charging (8GRAM)



RBW 9 kHz
MT 1 s

Att 10 dB AUTO PREAMP OFF

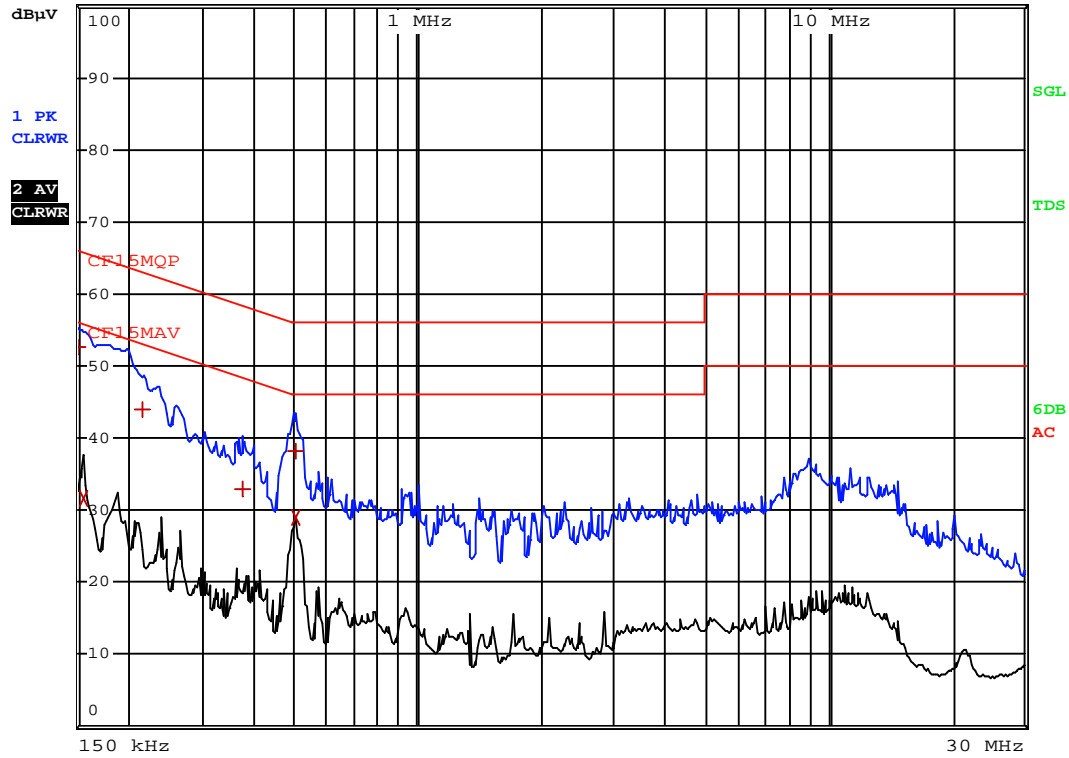

INTERTEK TESTING SERVICES

Worst Case: WIFI Online Video Playing & Adaptor Charging (8GRAM)

EDIT PEAK LIST (Final Measurement Results)				
Trace1:	CF15MQP			
Trace2:	CF15MAV			
Trace3:	---			
TRACE	FREQUENCY	LEVEL	dB μ V	DELTA LIMIT dB
1 Quasi Peak	150 kHz	52.60	N	-13.39
2 CISPR Average	154.5 kHz	31.61	L1	-24.14
1 Quasi Peak	217.5 kHz	43.84	N	-19.07
1 Quasi Peak	375 kHz	33.01	N	-25.37
2 CISPR Average	501 kHz	28.91	L1	-17.08
1 Quasi Peak	505.5 kHz	38.15	L1	-17.84

INTERTEK TESTING SERVICES

4.7.3 Conducted Emission Test Setup

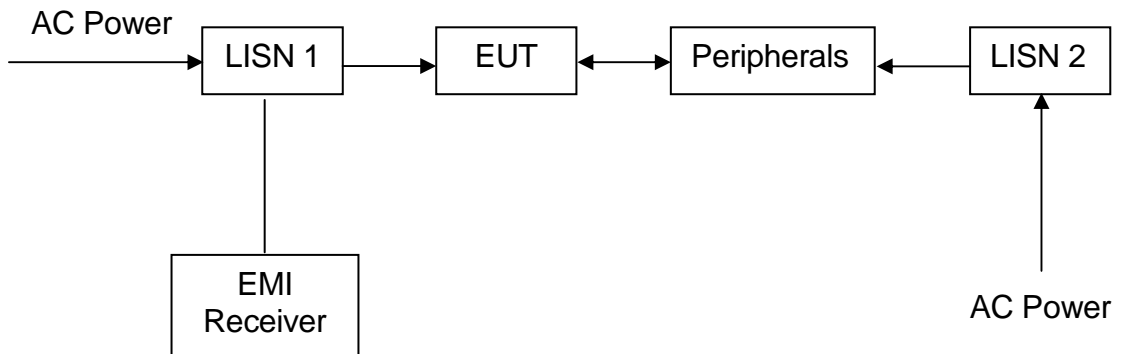

INTERTEK TESTING SERVICES

**EXHIBIT 5
EQUIPMENT LIST**

INTERTEK TESTING SERVICES

5.0 Equipment List

1) Radiated Emissions Test

Equipment	EMI Test Receiver	Spectrum Analyzer	Broad-Band Horn Antenna with frequency range 14G - 40GHz
Registration No.	EW-3095	EW-2466	EW-1679
Manufacturer	R&S	R&S	SCHWARZBECK
Model No.	ESCI	FSP30	BBHA9170
Calibration Date	Oct. 25, 2016	Oct. 03, 2016	June. 28, 2016
Calibration Due Date	Oct. 25, 2017	Aug. 20, 2017	June. 28, 2017

Equipment	Biconical Antenna	Log Periodic Antenna	Double Ridged Guide Antenna
Registration No.	EW-0571	EW-0447	EW-1133
Manufacturer	EMCO	EMCO	EMCO
Model No.	3104C	3146	3115
Calibration Date	May. 18, 2016	May. 18, 2016	Nov. 05, 2015
Calibration Due Date	Nov. 18, 2017	Nov. 18, 2017	May 05, 2017

2) Conducted Emissions Test

Equipment	EMI Test Receiver	LISN
Registration No.	EW-2500	EW-2501
Manufacturer	R&S	R&S
Model No.	ESCI	ENV-216
Calibration Date	Jan. 28, 2016	Jan. 28, 2016
Calibration Due Date	Jan. 28, 2017	Jan. 28, 2017

3) Conductive Measurement Test

Equipment	RF Power Meter with Power Sensor	Spectrum Analyzer
Registration No.	EW-2270	EW-2466
Manufacturer	AGILENTTECH	R&S
Model No.	N1911A	FSP30
Calibration Date	Jan. 19, 2016	Oct. 03, 2016
Calibration Due Date	Jan. 19, 2017	Aug. 20, 2017

END OF TEST REPORT