



User's manual

AWX22104

DECT 6.0 cordless telephone/
answering system with
caller ID/call waiting



Congratulations

on purchasing your new AT&T product. Before using this AT&T product, please read **Important safety information** on pages 84-86 of this user's manual. Please thoroughly read the user's manual for all the feature operations and troubleshooting information you need to install and operate your new AT&T product. You can also visit our website at **www.telephones.att.com** or call **1 (800) 222-3111**. In Canada, dial **1 (866) 288-4268**.

This telephone meets the California Energy Commission regulations for energy consumption. Your telephone is set up to comply with the energy-conserving standards right out of the box. No further action is necessary.

Model number: AWX22104

Type: DECT 6.0 cordless telephone/answering system with caller ID/call waiting

Serial number: _____

Purchase date: _____

Place of purchase: _____

Both the model and serial numbers of your AT&T product can be found on the bottom of the telephone base.



Telephones identified with this logo have reduced noise and interference when used with most T-coil equipped hearing aids and cochlear implants. The TIA-1083 Compliant Logo is a trademark of the Telecommunications Industry Association. Used under license.



The ENERGY STAR® program (www.energystar.gov) recognizes and encourages the use of products that save energy and help protect our environment. We are proud to mark this product with the ENERGY STAR® label indicating it meets the latest energy efficiency guidelines.

Parts checklist

Your telephone package contains the following items. Save your sales receipt and original packaging in the event warranty service is necessary.

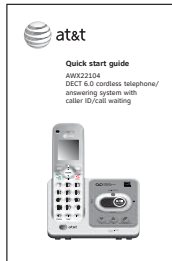

Quick start guide



Telephone base



Power adapter for telephone base



Cordless handset



Wall-mount bracket



Battery for cordless handset



Battery compartment cover



Telephone line cord

User's manual

AWX22104

DECT 6.0 cordless telephone/
answering system with
caller ID/call waiting



Table of contents

Getting started

Installation	1
Quick reference guide - handset.....	2
Quick reference guide - telephone base.....	5
Telephone base installation.....	6
Battery installation and charging.....	7
Battery installation.....	7
Battery charging.....	8
Wall-mount installation.....	9
Tabletop to wall-mount installation	9
Wall-mount to tabletop installation.....	11

Telephone settings

Menu overview.....	12
Handset settings.....	13
Ringer volume.....	13
Ringer tone.....	13
LCD language.....	14
Set speed dial voicemail number.....	14
Clear voicemail indication	15
Key tone.....	15
Set date/time.....	16
Home area code.....	17
Dial mode.....	17
QUIET mode.....	18
Telephone base ringer volume.....	19

Telephone operation

Making, answering and ending calls.....	20
Making a call.....	20
Temporary ringer silencing.....	20
Answering a call.....	21
Handset speakerphone	21
Ending a call.....	21
Redial.....	22
View numbers in the redial list.....	22
Call a number from the redial list.....	22
Copy a number from the redial list to the directory.....	23
Delete a number in the redial list	23
Options while on calls.....	24
Volume control.....	24
Mute.....	24
Flash/call waiting	24
Temporary tone dialing.....	25
Chain dialing.....	25
Join a call in progress	26
Handset locator.....	27
Web address.....	27
Intercom.....	28
Make and answer an intercom call.....	28
Answer an incoming call during an intercom call.....	28
Call transfer using intercom.....	29

Directory

Directory overview.....	30
Shared directory.....	30
Directory memory capacity.....	30
Exiting the directory.....	30
Create directory entries.....	31
Create a new directory entry.....	31
Add a predialed telephone number to the directory.....	33
Review the directory.....	34
Review directory entries.....	34
Search by name.....	35
Dial, delete and edit a directory entry.....	36
Dial a directory number.....	36
Delete a directory entry.....	36
Edit a directory entry.....	36
Speed dial.....	38
Assign a speed dial number.....	38
Reassign a speed dial number.....	39
Clear a speed dial location.....	39
Assign your speed dial voicemail number.....	39
Make a call using speed dial.....	40
Check your voicemail using speed dial.....	40

Caller ID

About caller ID.....	41
Information about caller ID with call waiting.....	41
About home area code.....	41
Caller ID log.....	42
How caller ID log works.....	42
Memory match.....	42
Caller ID operation.....	43
Missed (new) calls indicator.....	43
Review the caller ID log.....	43
View dialing options.....	44
Dial a caller ID log entry.....	45
Delete caller ID log entries.....	45
Save a caller ID log entry to the directory.....	46
Reasons for missing caller ID information.....	47

Answering system

Answering system settings.....	48
Announcement.....	48
Answer on/off.....	50
Call screening.....	51
Number of rings.....	52
Remote access code.....	53
Message alert tone.....	54
Recording time.....	55
Answering system overview.....	56
Answering system and voicemail indicators.....	56
Using the answering system and voicemail together.....	56
Message capacity.....	57
Voice prompts.....	57
Call screening.....	58
Call intercept.....	59
Temporarily turn off the message alert tone.....	59
Message playback.....	60
Options during playback.....	61
Delete all old messages.....	62
Recording and playing memos.....	63
Record a memo.....	63
Play back memos.....	63
Message window displays.....	64
Remote access.....	65
Remotely access the answering system.....	65

Appendix

Adding and registering handsets.....	67
Deregistering handsets.....	68
Screen icons, indicator lights and alert tones.....	69
Screen icons.....	69
Handset indicator lights.....	69
Telephone base indicator lights.....	70
Handset alert tones.....	70
Telephone base alert tones.....	70
Handset display screen messages.....	71
Troubleshooting.....	73

Maintenance.....	83
Important safety information	84
Safety information	84
Precautions for users of implanted cardiac pacemakers	86
Pacemaker patients	86
ECO mode.....	86
Especially about telephone answering systems	86
FCC Part 68 and ACTA.....	87
FCC Part 15.....	88
California Energy Commission battery charging testing instructions.....	89
Limited warranty.....	90
Technical specifications	93
DECT 6.0 digital technology	93
Telephone operating range.....	93

Index

Index.....	94
------------	----

Getting started
Installation

You must install and charge the battery before using the cordless handset.

A large black octagonal sign with a thick black border and the word "STOP!" in bold, black, sans-serif capital letters in the center.

See pages 7 and 8 for easy instructions.

Install the telephone base close to a telephone wall jack and an electrical outlet not controlled by a wall switch. The telephone base can be placed on a flat surface or vertically mounted on the wall (page 9-10). For optimum range and better reception, place the telephone base in a central and open location. If you subscribe to high-speed Internet service (DSL- digital subscriber line) through your telephone line, you must install a DSL filter between the telephone line cord and the telephone wall jack (page 6). The filter prevents noise and caller ID problems caused by DSL interference. Please contact your DSL service provider for more information about DSL filters.

Your product may be shipped with a protective sticker covering the handset or telephone base display - remove it before use.

For customer service or product information, visit our website at **www.telephones.att.com** or call **1 (800) 222-3111**. In Canada, dial **1 (866) 288-4268**.

Avoid placing the telephone base too close to:

- Communication devices such as television sets, VCRs, or other cordless telephones.
- Excessive heat sources.
- Noise sources such as a window with traffic outside, motors, microwave ovens, refrigerators, or fluorescent lighting.
- Excessive dust sources such as a workshop or garage.
- Excessive moisture.
- Extremely low temperature.
- Mechanical vibration or shock such as on top of the washing machine or work bench.

Getting started

Quick reference guide - handset

CHARGE light

On when the handset is charging in the telephone base or charger.

▲DIR/VOLUME

- Press to scroll up while in menus (page 12).
- Press to increase the listening volume (pages 24 and 61).
- Press to show directory entries when the handset is not in use (page 34).
- While entering names or numbers in the directory, press to move the cursor to the right (page 31).

MUTE/DELETE

- During a call, press to mute the microphone (page 24).
- While predialing, press to erase digits (page 20).
- While reviewing the redial list, directory, speed dial list or caller ID log, press to delete an individual entry (pages 23, 36, 39 and 45).

PHONE/FLASH

- Press to make or answer a call (page 20 or 21).
- During a call, press to answer an incoming call when you receive a call waiting alert (page 24).

1

- While reviewing a caller ID log entry, press repeatedly to add or remove 1 in front of the entry before dialing or saving it to the directory (page 44).
- Press and hold to set or dial your voicemail number (page 14).

TONEX

Press to switch to tone dialing temporarily during a call if you have pulse service (page 25).

🔊/SPEAKER

Press to turn on the handset speakerphone, press again to resume normal handset use (page 21).



Getting started
Quick reference guide - handset



▼CID/VOLUME

- Press to scroll down while in menus.
- Press to decrease the listening volume (pages 24 and 61).
- Press to show the caller ID log when the handset is not in use (page 43).
- While entering names or numbers in the directory, press to move the cursor to the left (page 31).

MENU/SELECT

- Press to display the menu (page 12).
- Once in the menu, press to select an item or save an entry or setting (page 12).

☎OFF/CANCEL

- During a call, press to hang up (page 21).
- While using menus, press to cancel an operation, back up to the previous menu, or exit the menu display (page 12); or press and hold to exit to idle mode.
- Press and hold while the handset is not in use to erase the missed call indicator (page 43).

(pound key)

- Press and hold to set and turn on the **QUIET** mode, or turn it off.
- When reviewing a caller ID log entry, press repeatedly to view other dialing options.

INT

Press to initiate an intercom conversation or transfer a call.

REDIAL/PAUSE

- Press repeatedly to review the last 10 numbers dialed (page 22).
- While entering numbers, press and hold to insert a dialing pause (pages 20 and 31).

Getting started

Quick reference guide - handset

MAIN MENU



- Play messages (page 60)
- Answering sys (page 48)
- Directory (page 30)
- Caller ID log (page 43)
- Ringers (page 13)
- Set date/time (page 16)
- Settings (page 12)
- Web address (page 27)

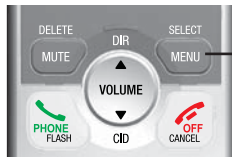

Using menus

- Press **MENU/SELECT** to enter the main menu.
- Press **▼CID** or **▲DIR** to scroll through menu items.
- Press **MENU/SELECT** to select or modify an item.
- Press **OFF/CANCEL** to cancel an operation, back up to the previous menu, or exit the menu display.

Getting started

Quick reference guide - telephone base

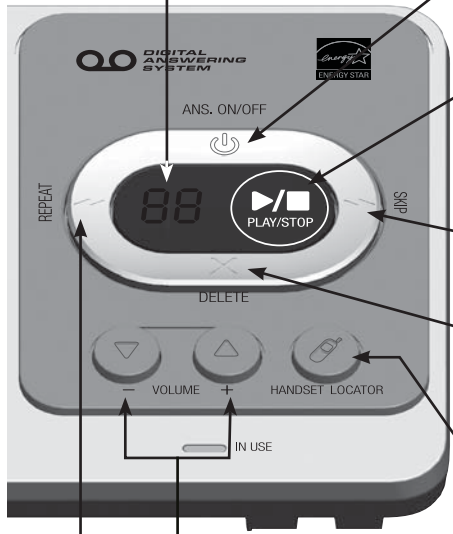

Message window
Displays the number of messages or other answering system information.

⏻/ANS ON/OFF
Press to turn the built-in answering system on or off.

▶/PLAY/STOP
• Press to start or stop message playback (page 60).
• During call screening, press to temporarily turn the call screening on or off (page 58).

▶/SKIP
Press to skip a message (page 61).

X/DELETE
• Press to delete the message currently playing (page 61).
• Press twice to delete all old messages when the telephone is not in use (page 62).

📞/HANDSET LOCATOR
Press to page all handsets (page 27).

▼/▲/-VOLUME+
• When the telephone is not in use, press to adjust the telephone base ringer volume (page 19).
• During call screening or message playback, press to adjust the listening volume (page 58 and 61).

◀/REPEAT
• Press to repeat a message (page 61).
• Press twice to play the previous message (page 61).

Getting started

Telephone base installation

Install the telephone base, as shown below. If you subscribe to high-speed Internet service (DSL - digital subscriber line) through your telephone line, you must install a DSL filter between the telephone line cord and the telephone wall jack. The filter prevents noise and caller ID problems caused by DSL interference. Please contact your DSL service provider for more information about DSL filters.

The telephone base comes ready for tabletop use. If you want to mount your telephone on a wall, refer to **Wall-mount installation** on pages 9-11 for details.

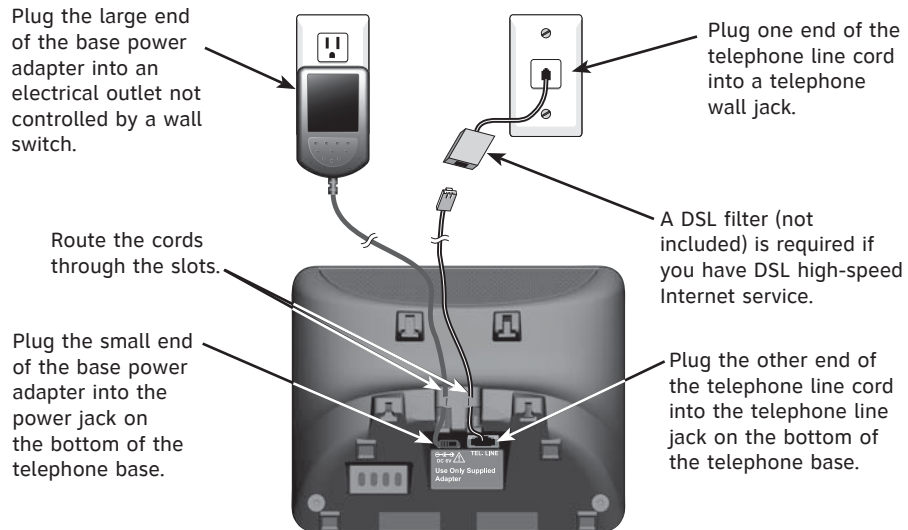

IMPORTANT INFORMATION:

Use only the power adapter(s) provided with this product. To obtain a replacement, visit our website at www.telephones.att.com or call **1 (800) 222-3111**. In Canada, dial **1 (866) 288-4268**.

Getting started

Battery installation and charging

Battery installation

Install the battery, as shown below.

1. Plug the battery connector securely into the socket inside the handset battery compartment. Insert the supplied battery with the label **THIS SIDE UP** facing up, as indicated.



2. Align the cover flat against the battery compartment, then slide it upwards until it clicks into place.



3. Charge the handset by placing it face up in the telephone base or charger. The **CHARGE** light is on when charging.

To replace the battery, press the tab and slide the battery compartment cover downwards. Lift out the old battery and disconnect it from the handset. Follow the instructions to install and charge the new battery.

IMPORTANT INFORMATION:

Use only the supplied rechargeable battery or replacement battery (model BT162342/BT262342). To order, visit our website at www.telephones.att.com or call **1 (800) 222-3111**. In Canada, dial **1 (866) 288-4268**.



Getting started

Battery installation and charging

Battery charging

Once you have installed the battery, the screen indicates the battery status (see the following table). If necessary, place the handset in the telephone base or charger to charge the battery. For best performance, keep the handset in the telephone base or charger when not in use. The battery is fully charged after 16 hours of continuous charging. See **Technical specifications** on page 93 for battery operating times.

If the screen is blank, you need to charge the handset without interruption for at least 30 minutes to give the handset enough charge to use the telephone for a short time. The screen shows **Low battery** until you have charged the battery without interruption for at least 30 minutes. The following table summarizes the battery charge indicators and actions to take.

Battery indicators	Battery status	Action
The screen is blank or shows Put in charger .	Battery has no or very little charge. The handset cannot be used.	Charge without interruption (at least 30 minutes).
The screen shows Low battery and  flashes.	Battery has enough charge to be used for a short time.	Charge without interruption (at least 30 minutes).
The screen shows HANDSET X and the battery icon shows  .	Battery is charged.	To keep the battery charged, place it in the telephone base or charger when not in use.

NOTES:

- If you are on a call in low battery mode, you hear 4 short beeps every 50 seconds.
- If no battery is installed in the handset when you place it in the telephone base or charger, the screen shows **No battery**. Follow the instructions in **Battery installation** on page 7 to install the battery.

After you install your telephone or power returns following a power outage, the handset will prompt you to set the date and time (see page 16). To skip setting the date and time, press  **OFF/CANCEL**.

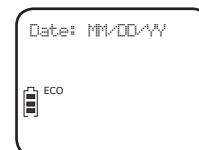

Getting started

Wall-mount installation

The telephone base comes ready for tabletop use. If you want to mount your telephone on a wall, use the provided wall-mount bracket to connect with a standard dual-stud telephone wall-mounting plate. If you do not have this mounting plate, you can purchase one from many hardware or consumer electronics retailers. Professional assistance may be required to install the mounting plate.

Tabletop to wall-mount installation

To change the telephone base from tabletop installation to wall-mount installation, make sure you first unplug the power adapter from the electrical outlet and the telephone line cord from the telephone wall jack.

1. Plug the power cord and telephone line into the telephone base. If you are using a DSL filter, plug the other end of the telephone line into the filter. Route the telephone line cord (or DSL filter) through the wall-mount bracket hole.
2. Position the telephone base, as shown below. Insert the extended tabs (see illustration 2) of the wall-mount bracket into the slots on the back of the telephone base (marked **B**). Push the telephone base down until it is securely in place.

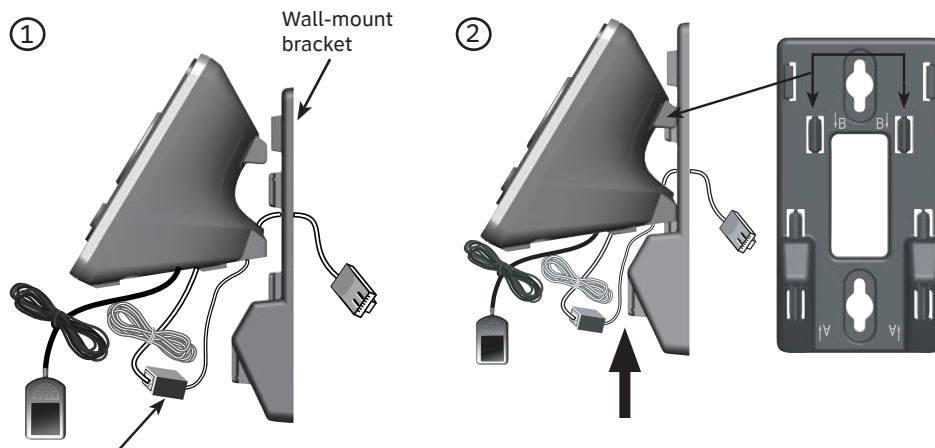

A DSL filter (not included) is required if you have DSL high-speed Internet service.

Getting started

Wall-mount installation

3. Plug the telephone line cord (or DSL filter) into the wall jack. Plug the power adapter into a power outlet not controlled by a wall switch.
4. Align the holes on the wall-mount bracket with the standard wall plate and slide the wall-mount bracket down until it locks securely. Bundle the telephone line cord and power adapter cord neatly with twist ties.

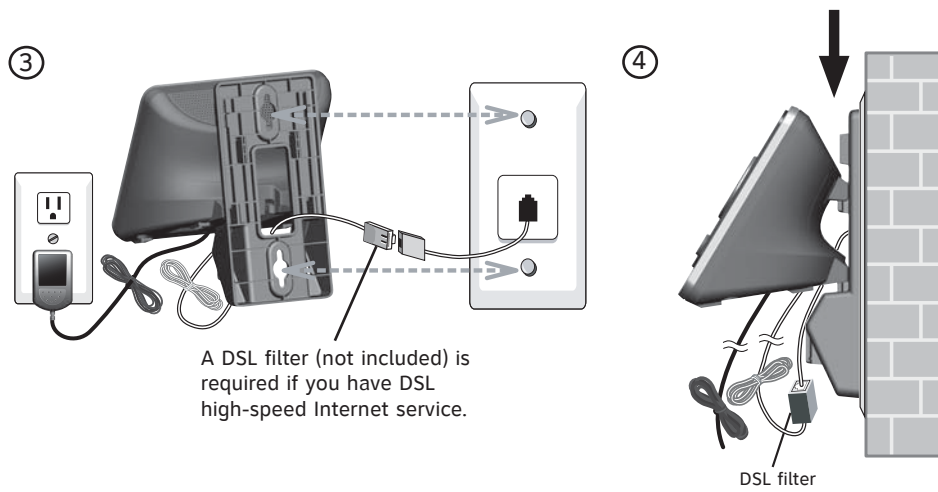

Getting started

Wall-mount installation

Wall-mount to tabletop installation

To change the telephone base from wall-mount installation to tabletop installation, follow the steps, as mentioned below.

1. If the telephone line cord and power adapter cord are bundled, untie them first.
2. Push the telephone base up to detach it from the wall-mount bracket. Unplug the telephone line cord (or DSL filter) from the wall. Unplug the power adapter from the power outlet.
3. Push the wall-mount bracket up to remove it from the wall.
4. Refer to **Telephone base installation** on page 6 to install the telephone base.

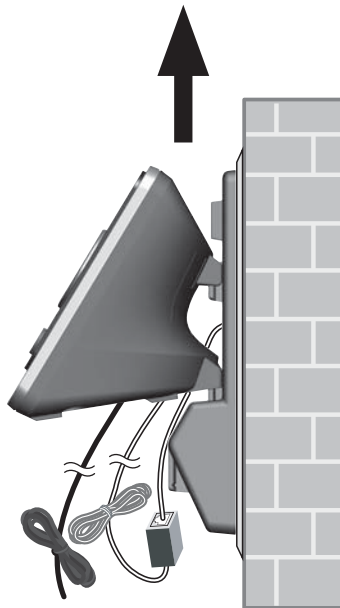

Telephone settings

Menu overview

Use the menu to change the telephone settings.

1. Press **MENU/SELECT** in idle mode (when handset is not in use) to enter the main menu.
2. Press **▼CID** or **▲DIR** to scroll through menu items.
3. Press **MENU/SELECT** to select or save the indicated item.

-OR-

Press **OFF/CANCEL** to cancel an operation, back up to the previous menu or exit the menu display. Press and hold **OFF/CANCEL** to cancel an operation and return to idle mode.

Telephone settings
Handset settings

Ringer volume

You can set the handset ringer volume level (1-6), or turn the ringer off. When the ringer is off,  and **Ringer off** appears on the handset screen.

1. Press **MENU/SELECT** in idle mode to enter the main menu.
2. Press **▼CID** or **▲DIR** to scroll to **Ringers**, then press **MENU/SELECT**.
3. Press **MENU/SELECT** to select **Ringer volume**.
4. Press **▼CID** or **▲DIR** to sample each volume level.
5. Press **MENU/SELECT** to save your preference.

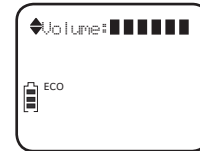
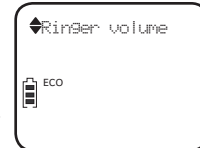

NOTES:

- Changing the handset ringer volume does not affect the base ringer volume. For more information on the base ringer volume, see **Telephone base ringer volume** on page 19.
- The handset ringer volume also determines the ringer volume of intercom calls and paging tones.
- If the handset ringer volume is off, that handset ringer is silenced for all incoming calls. However, that handset still plays the paging tone when responding to the handset locator feature (see **Handset locator** on page 27).
- While the telephone is ringing, press  **OFF/CANCEL** or **MUTE/DELETE** to silence the ringer temporarily on that handset only (see **Temporary ringer silencing** on page 20).

Ringer tone

You can choose one of 10 ringer tones for the handset.

1. Press **MENU/SELECT** in idle mode to enter the main menu.
2. Press **▼CID** or **▲DIR** to scroll to **Ringers**, then press **MENU/SELECT**.
3. Press **▼CID** or **▲DIR** to scroll to **Ringer tone**, then press **MENU/SELECT**.
4. Press **▼CID** or **▲DIR** to sample each tone.
5. Press **MENU/SELECT** to save your preference.

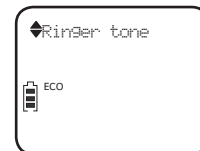

- #### **NOTE:** If you turn off the handset ringer volume, you will not hear ringer tone samples.

Telephone settings
Handset settings

LCD language

You can select the language used for all screen displays.

1. Press **MENU/SELECT** in the idle mode to enter the main menu.
2. Press **▼CID** or **▲DIR** to scroll to **Settings**, then press **MENU/SELECT**.
3. Press **MENU/SELECT** to select **LCD language**.
4. Press **▼CID** or **▲DIR** to select **English, Français** or **Español**.
5. Press **MENU/SELECT** twice to save your preference.



i NOTE: If you accidentally change the LCD language to French or Spanish, you can reset it back to English without going through the French or Spanish menus. Press **MENU/SELECT** in idle mode, then enter ***364#** using the dialing keys. You hear a confirmation tone.

Set speed dial voicemail number

If you subscribe to a voicemail service offered by your telephone service provider, you can save the voicemail number to **1** on each handset for easy access. When you want to retrieve voicemail messages, **press and hold 1**. Contact your telephone service provider for more information and assistance about your voicemail service.

To set your voicemail number:

1. Press **MENU/SELECT** in idle mode to enter the main menu.
2. Press **▼CID** or **▲DIR** to scroll to **Settings**, then press **MENU/SELECT**.
3. Press **▼CID** or **▲DIR** to scroll to **Voicemail #**, then press **MENU/SELECT**.
4. Use the dialing keys to enter the voicemail number (up to 30 digits).
5. Press **MENU/SELECT** to save. The handset shows **VM # saved** and the stored number.



-OR-

If it is your first time to set the voicemail number:

1. Press and hold 1 in idle mode.
2. Use the dialing keys to enter the voicemail number (up to 30 digits).
3. Press **MENU/SELECT** to save. The handset dials the saved voicemail number.

Telephone settings
Handset settings

Clear voicemail indication

Use this feature when the telephone indicates there is a new voicemail message but there is none. This may occur, for example, when you have accessed your voicemail while away from home. This feature only turns off the displayed **New voicemail** message and  icon; it does not delete your voicemail messages. As long as you have new voicemail messages, your telephone service provider continues to send the signal to turn on the indicators.

To manually turn off the new voicemail indicators:

1. Press **MENU/SELECT** when in idle mode to enter the main menu.
2. Press **▼CID** or **▲DIR** to scroll to **Settings**, then press **MENU/SELECT**.
3. Press **▼CID** or **▲DIR** to scroll to **Clr voicemail**, then press **MENU/SELECT**. The screen shows **Reset VM Icon?**
4. Press **MENU/SELECT** to turn the voicemail indication off.



 **NOTE:** For more information about using your voicemail service, contact your telephone service provider for assistance.

Key tone

The handset is programmed to beep with each key press. You can turn the key tone off, so there are no beeps when you press keys.

1. Press **MENU/SELECT** in idle mode to enter the main menu.
2. Press **▼CID** or **▲DIR** to scroll to **Settings**, then press **MENU/SELECT**.
3. Press **▼CID** or **▲DIR** to scroll to **Key tone**, then press **MENU/SELECT**.
4. Press **▼CID** or **▲DIR** to select **On** or **Off**.
5. Press **MENU/SELECT** to save your preference.



Telephone settings
Handset settings

Set date/time

The answering system announces the day of the week and time of each message received prior to playing it. If you subscribe to caller ID service, the day, month and time are set automatically with each incoming call (see **About caller ID** on page 41). However, the year must be set so that the day of the week can be calculated from the caller ID information.

Follow the steps, as mentioned below, to set the month, date, year and time.

1. Press **MENU/SELECT** in idle mode to enter the main menu.
2. Press **▼CID** or **▲DIR** to scroll to **Set date/time**, and then press **MENU/SELECT**.
3. Press **▼CID** or **▲DIR** to select the month, then press **MENU/SELECT**, or enter the 2-digit number (**01-12**) using the dialing keys (**0-9**).
4. Press **▼CID** or **▲DIR** to select the day, then press **MENU/SELECT**, or enter the 2-digit number (**01-31**) using the dialing keys (**0-9**).
5. Press **▼CID** or **▲DIR** to select the year, or enter the 2-digit number (**00-99**) using the dialing keys (**0-9**), then press **MENU/SELECT**.
6. Press **▼CID** or **▲DIR** to select the hour, then press **MENU/SELECT**, or enter the 2-digit number (**00-23**) using the dialing keys (**0-9**).
7. Press **▼CID** or **▲DIR** to select the minute, then press **MENU/SELECT**, or enter the 2-digit number (**00-59**) using the dialing keys (**0-9**).
8. Press **▼CID** or **▲DIR** to choose **AM** or **PM**. Press **MENU/SELECT** to save.

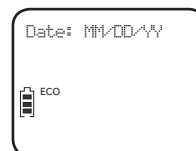

i NOTE: If the date and time is not set when the message is recorded, the system announces "Time and date not set" before it plays the message.

Telephone settings
Handset settings

Home area code

If you dial 7 digits to make a local call (no area code required), enter your area code into the telephone as home area code. When you receive a call from within your home area code, the caller ID log only displays the 7 digits of the telephone number.

This feature makes it easy for you to make a call from the caller ID log. If you dial 10 digits to make a local call, do not use this home area code feature. If you do, you will not be able to place calls from your caller ID log because they have only 7 digits.

1. Press **MENU/SELECT** in idle mode to enter the main menu.
2. Press **▼CID** or **▲DIR** to scroll to **Settings**, then press **MENU/SELECT**.
3. Press **▼CID** or **▲DIR** to scroll to **Home area code**, then press **MENU/SELECT**.
4. Use the dialing keys to enter your 3-digit area code. Press **MUTE/DELETE** to erase digits while editing.
5. Press **MENU/SELECT** to save the setting.

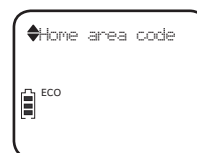

i NOTE: If, in the future, your telephone service provider requires you to dial 10 digits to make a local call (area code + telephone number), you need to delete your home area code. While the home area code is displaying in Step 4, press and hold **MUTE/DELETE**. The home area code is now restored to its default setting of _ _ _ (empty).

Dial mode

The dial mode is preset to tone dialing. If you have pulse (rotary) service, you must change the dial mode to pulse dialing before using the telephone.

1. Press **MENU/SELECT** in the idle mode to enter the main menu.
2. Press **▼CID** or **▲DIR** to scroll to **Settings**, then press **MENU/SELECT**.
3. Press **▼CID** or **▲DIR** to scroll to **Dial mode**, then press **MENU/SELECT**.
4. Press **▼CID** or **▲DIR** to choose between **Touch-tone**, and **Pulse**.
5. Press **MENU/SELECT** to save the setting.

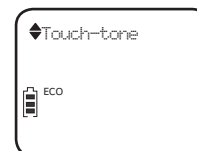

i NOTE: If you have dial pulse (rotary) dialing service only, refer to **Temporary tone dialing** on page 25 to temporarily switch from pulse to touch-tone dialing during a call.

Handset settings

QUIET mode

When **QUIET** mode is turned on, the telephone silences all sounds during the set period of time (1-12 hours). However, the handset locator paging tone and any sound-generating operations initiated by users, such as making calls using the speakerphone or setting ringer volume, will sound as normal. After you turn on **QUIET** mode, this feature activates immediately and the answering system turns on automatically. When **QUIET** mode is on, the answering system takes calls and records messages without broadcasting them.

To turn QUIET mode on:

1. Press and hold # (pound key) in idle mode to enter the **QUIET** mode setting screen. The screen shows **Quiet: _ _ hours [1-12]**.
2. Use the dialing keys to enter the desired number of hours (1-12) you would like to turn on **QUIET** mode, then press **MENU/SELECT**. Your screen briefly shows **Quiet mode on**.

To turn QUIET mode off:

- While **QUIET** mode is on, press and hold # (pound key). The screen shows **Quiet mode off** briefly and then returns to idle.

NOTES:

- If you change the base ringer, handset ringer, ringer volume, or key tone when **QUIET** mode is on, the sample plays but the feature is still muted after saving the setting.
- After **QUIET** mode is turned off or the set period of time has expired, all muted features will be activated again.
- When **QUIET** mode is on, the handset does not ring when there is an incoming intercom call, but the handset which initiates the intercom call does have the calling tone as normal.

Telephone settings

Telephone base ringer volume

When the telephone base is not in use, press **▼/▲/-VOLUME+** on the telephone base to set the ringer volume level (1-6), or turn the ringer off. A sample of the ringer sounds as you adjust the volume. The telephone base announces, "*Base ringer is off*" when you set the volume to 0.



i NOTE: If a handset is on an outside call, the telephone base volume cannot be changed.

Making, answering and ending calls

Making a call

To make a call:

- Press **PHONE/FLASH** or **SPEAKER**, then enter the telephone number.

The screen displays the elapsed time as you talk (in hours, minutes and seconds).

On-hook dialing (predialing):

1. Use the dialing keys to enter the telephone number (up to 30 digits).
 - Press and hold **REDIAL/PAUSE** to insert a 3-second dialing pause (a **P** appears).
 - Press **MUTE/DELETE** or **OFF/CANCEL** to erase digits.
2. Press **PHONE/FLASH** or **SPEAKER** to call.



i NOTES:

- Pressing **PHONE/FLASH** to access services from your telephone service provider does not affect the elapsed time.
- When a handset is on a call and there is another handset attempts to access the directory, speed dial list or caller ID log, the screen of the other handset shows **Not available**.

Temporary ringer silencing

To silence the ringer temporarily on that handset only:

- While the telephone is ringing, press **OFF/CANCEL** or **MUTE/DELETE**.



To silence the ringer temporarily on the telephone base:

- While the telephone is ringing, press **VOLUME** on the telephone base.

This turns off the ringer without disconnecting the call. The next incoming call rings normally at the preset volume.

- **i NOTE:** Unless the ringer volume is turned off on that handset, each handset rings when there is an incoming call.

Telephone operation

Making, answering and ending calls

Answering a call

Press any dialing key (**0-9**, ***** or **#**) or  **PHONE/FLASH**.

-OR-

Press  **SPEAKER** to answer using the speakerphone.



Handset speakerphone

During a call, press  **SPEAKER** to switch between speakerphone and normal handset use.

Press  **OFF/CANCEL** or return the handset to the telephone base or charger to hang up.

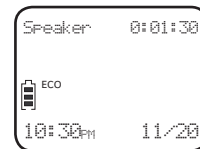

 **NOTE:** After installing the battery in the handset, the screen may show **Low battery**. If you use the speakerphone at this time, the battery may become depleted. Follow the instructions in **Battery charging** on page 8.

Ending a call

Press  **OFF/CANCEL**.

-OR-

Put the handset in the telephone base or charger to end the call.



Telephone operation

Redial

Each handset stores the 10 most recently called numbers in the redial list.

View numbers in the redial list

1. Press **REDIAL/PAUSE** in idle mode.
2. Press **▲DIR**, **▼CID** or **REDIAL/PAUSE** repeatedly to scroll through the 10 most recently called numbers (up to 30 digits each). The handset beeps twice at the beginning or end of the list.
3. Press **OFF/CANCEL** to exit the redial list.



i **NOTE:** If you access an empty redial list, the handset sounds an error tone.

Call a number from the redial list

1. Press **REDIAL/PAUSE** in idle mode.
2. Press **▲DIR**, **▼CID** or **REDIAL/PAUSE** repeatedly to scroll through the 10 most recently called numbers (up to 30 digits each). The handset beeps twice at the beginning or end of the list.
3. When the number you want to call is displayed, press **PHONE/FLASH** or **SPEAKER** to dial.



-OR-

1. Press **PHONE/FLASH** or **SPEAKER**.
2. Press **REDIAL/PAUSE**, then press **▲DIR**, **▼CID** or **REDIAL/PAUSE** repeatedly until the number you want to call is displayed.
3. Press **MENU/SELECT**. The handset dials the desired number.

i **NOTE:** If you press **REDIAL/PAUSE** when the redial list is empty, the handset sounds an error tone.

Redial

Copy a number from the redial list to the directory

1. Press **REDIAL/PAUSE**.
2. Press **▼CID** or **▲DIR** to scroll to the number you want to save into the directory. Press **MENU/SELECT** twice. The screen shows **Enter number**.
 - Press **▼CID** or **▲DIR** to move the cursor to the left or right.
 - Press and hold REDIAL/PAUSE to enter a 3-second dialing pause (a **P** appears).
 - Press **MUTE/DELETE** to erase a digit.
 - Press and hold MUTE/DELETE to erase all digits.
3. Press **MENU/SELECT** again to save the number and edit the name. The screen shows **Enter name**.
 - Use the dialing keys (**0-9**) to edit the name.
 - Press **0** to add a space.
 - Press **MUTE/DELETE** to erase a character.
 - Press and hold MUTE/DELETE to erase all characters.
4. Press **MENU/SELECT** to store your new directory entry. The handset shows **Saved** and sounds a confirmation tone.



Delete a number in the redial list

While reviewing a number in the redial list, press **MUTE/DELETE** to delete the displayed number from the redial list.

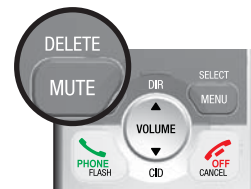

Telephone operation

Options while on calls

Volume control

While on a call, press ▲**DIR/VOLUME** to increase or ▼**CID/VOLUME** to decrease the listening volume.

When the volume reaches the minimum or maximum setting, you hear 2 beeps.

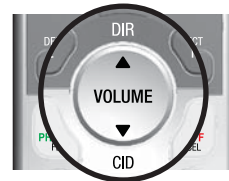

i NOTE: The handset volume setting and speakerphone volume setting are independent.

Mute

Use the mute function to turn off the microphone while on a call. You can hear the caller, but the caller cannot hear you.

To turn mute on:

- Press **MUTE/DELETE**. When mute is on, the handset screen shows **Muted** until the mute function is turned off.

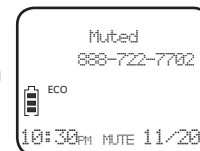

To turn mute off:

- Press **MUTE/DELETE** and then resume speaking. When mute is off, **Microphone on** appears temporarily on the handset screen.

-OR-

Mute is automatically turned off when you end the call.



Flash/call waiting

If you subscribe to call waiting service provided by your telephone service provider, and someone calls while you are already on a call, you hear a beep.

- Press **PHONE/FLASH** to put your current call on hold and take the new call.
- Press **PHONE/FLASH** anytime to switch back and forth between calls.



i NOTE: For more information on caller ID with call waiting, refer to **About caller ID** on page 41.

Options while on calls

Temporary tone dialing

If you have dial-pulse (rotary) dialing service only, you can temporarily switch from pulse-tone dialing to touch-tone dialing during a call.

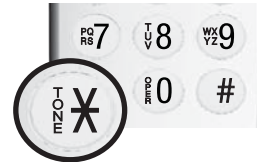

1. During a call, press **TONEX**.
2. Use the dialing keys to enter the desired number.
The telephone sends touch-tone signals.
3. The telephone automatically returns to pulse dial mode after you end the call.

Chain dialing

While on a call, you can initiate a dialing sequence from numbers stored in the directory, caller ID log or redial list. Doing this can be useful if you need to access numbers other than telephone numbers (such as account numbers or access codes).

To access the directory while on a call:

1. Press **MENU/SELECT**.
2. Press **MENU/SELECT** to choose **Directory**.
3. Press **▼CID** or **▲DIR** to scroll or use the dialing keys (**0-9**) to find the desired entry (see **Search by name** on page 35).
4. Press **MENU/SELECT**. The telephone automatically dials the displayed number.



To access the caller ID log while on a call:

1. Press **MENU/SELECT**.
2. Press **▼CID** or **▲DIR** to scroll to **Caller ID log**, then press **MENU/SELECT**.
3. Press **▼CID** or **▲DIR** to scroll to the desired entry. Press **#** (pound key) to view other dialing options, if necessary. See **View the dialing options** on page 44 for more details.
4. Press **MENU/SELECT**. The telephone automatically dials the displayed number.



Telephone operation

Options while on calls

To access the redial list while on a call:

1. Press **REDIAL/PAUSE**. The screen shows the number most recently called. To view up to 10 recently called numbers, press **▲DIR**, **▼CID** or **REDIAL/PAUSE** repeatedly to scroll to the desired number.
2. Press **MENU/SELECT**. The handset dials the displayed number.



NOTES:

- While on a call, you cannot edit a directory entry or redial entry, or copy a caller ID entry into the directory.
- If the directory, speed dial list, caller ID log or answering system is being used and you attempt to access one of them, the screen shows **Not available**.
- Press  **OFF/CANCEL** to exit directory, caller ID log or redial list and return to the call without dialing the displayed number.

Join a call in progress

If a handset is already on a call and you would like to join the call:

Press  **PHONE/FLASH** or  **SPEAKER** on another system handset.

To end the call:

Press  **OFF/CANCEL** or place the handset in the telephone base or charger.

The call does not end until all handsets hang up.

NOTES:

- This feature is only applicable to models with more than one handset.
- For models with two to four handsets, all handsets can be used at the same time on an outside call. For models with five handsets, you can use a maximum of four handsets. If the fifth handset attempts to join the call, the handset screen shows **Unable to call**.

Telephone operation
Handset locator

You can use the handset locator feature to find misplaced handsets.

To start the paging tone:

- Press **PHONE/FLASH** on the telephone base to start the paging tone on all handsets for 60 seconds.

To stop the paging tone:

- Press **PHONE/FLASH**, **SPEAKER**, **OFF/CANCEL** or any dialing key (0-9, * or #) on the handset(s).
- OR-
- Press **PHONE/FLASH** on the telephone base.
- OR-
- Place the handset in the telephone base or charger.



NOTES:

- If you press **MUTE/DELETE** on a handset, the ringer of that handset is silenced but the paging tone continues on the other handsets.
- If a handset is accessing the answering system, on a call (intercom call or outside call), or out of range, that handset does not beep when paged.
- You cannot use the handset locator feature while the telephone base is playing messages or the answering system is being accessed remotely.

Web address

You can use the web address feature to view the AT&T website address.

1. Press **MENU/SELECT** in idle mode.
2. Press **▼CID** or **▲DIR** to scroll to **Web address**, then press **MENU/SELECT**. The screen shows the AT&T Website address.

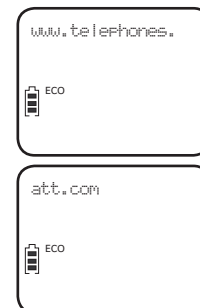

Intercom

Make and answer an intercom call

Use the intercom feature for conversations between handsets. This feature is only available if you have at least two system handsets.

1. Press **INT** on your handset when not in use.
 - If you have 2 handsets, your originating handset screen shows **Calling HS X**. The other handset rings and its screen shows **HS X is calling**.
 - If you have more than 2 handsets, your originating handset screen shows **Intercom to**. Use the dialing key to select the destination handset. The originating handset screen shows **Calling HS X** (X represents the handset number). The destination handset rings and its screen shows **HS X is calling**.
2. To answer the intercom call, press any dialing key (**0-9**, ***** or **#**), **PHONE/FLASH**, **SPEAKER** or **INT** on the other handset. Both handset screens now show **Intercom**.
3. To end an intercom call, press **OFF/CANCEL** or place the handset back in the telephone base or charger. Both handset screens now show **Intercom ended**.

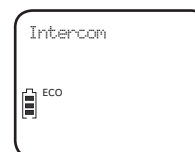

NOTES:

- Before the intercom call is answered, you can cancel it by pressing **OFF/CANCEL** or **INT** on your originating handset.
- If the other handset is not answered within 100 seconds, or if the handset is in use, on a call, or out of range, your originating handset shows **Unable to call**.
- If you have four handsets, of which two handsets are on an intercom call, the other two handsets can be used on an outside call (see **Join a call in progress** on page 26) or a separate intercom call.

Answer an incoming call during an intercom call

If you receive an incoming outside call during an intercom call, there is an alert tone.

To answer the incoming outside call:

- Press **PHONE/FLASH**. The intercom call ends automatically.

To end the intercom call without answering the incoming outside call:

- Press **OFF/CANCEL**. The intercom call ends and the handsets ring for the incoming call.

To let the answering system answer the incoming outside call:

- Do nothing. Continue with the intercom call. If the answering system is on, it answers the incoming call after the number of rings you have set.

Call transfer using intercom

Use the intercom feature to transfer an outside call to another system handset.

1. During a call, press **INT**.
 - If you have 2 handsets, the outside call is put on hold and your originating handset screen shows **Calling HS X**. The other handset rings and its screen shows **HS X is calling**.
 - If you have more than 2 handsets, your originating handset screen shows **Intercom to**. Use the dialing key to enter a handset number. The outside call is put on hold and your originating handset screen shows **Calling HS X**. The destination handset rings and its screen shows **HS X is calling**.
2. To answer the intercom call on the other handset, press any dialing key (**0-9, *** or **#**), **PHONE/FLASH**, **SPEAKER** or **INT**. The outside call is still on hold and both handset screens now show **Intercom**. You can now have a private conversation between system handsets.



NOTES:

- To cancel the intercom call and return to the external call before the intercom call is answered, press **OFF/CANCEL**, **PHONE/FLASH** or **INT** on your originating handset.
 - If the called party does not answer within 100 seconds, or if the device is in use, on a call, or out of range, the calling handset shows **Unable to call** on its screen and automatically returns to the outside call.
3. From the intercom call, you have the following options:
 - You can let the other handset join you on the outside call in a three-way conversation. Press and hold **INT** on the originating handset.
 - You can transfer the call. Press **OFF/CANCEL**, or place your handset back in the telephone base or charger. Your originating handset screen shows **Transferred**. The other handset automatically connects to the outside call.
 - You can switch between the outside call (**Outside call** appears on the screen) and the intercom call (**Intercom** appears on the screen). Press **INT** on the originating handset to switch.
 - The called party can end the intercom call by **OFF/CANCEL** or placing the other handset back in the telephone base or charger. The outside call continues with the originating handset.

Directory

Directory overview

Shared directory

The directory is stored in the telephone base, and is shared by all handsets. Changes made to the directory on any one handset apply to all.

 **NOTE:** Only one handset can review the directory at one time. If another handset attempts to enter the directory, the screen shows **Not available**.



Directory memory capacity



The directory can store up to 50 entries, with a maximum of 15 alphanumeric characters (including spaces) for the names and 30 digits for the telephone numbers.

If there are already 50 entries, the screen shows **Directory full**. You cannot store a new number until you delete one.

If the directory is empty, when you access it, the screen shows **Directory empty**.



Exiting the directory

Press  **OFF/CANCEL** to cancel an operation, back up to the previous menu, or exit the menu display. Press and hold  **OFF/CANCEL** to return to idle mode.

Directory

Create directory entries

Create a new directory entry

1. Press **MENU/SELECT** in idle mode.
2. Press **▼CID** or **▲DIR** to scroll to **Directory**, then press **MENU/SELECT**.
3. Press **MENU/SELECT** to choose **Add contact**.
4. Enter the telephone number when prompted.

- Use the dialing keys to enter a number (up to 30 digits).
 - Press **▼CID** or **▲DIR** to move the cursor to the left or right.
 - Press and hold **REDIAL/PAUSE** to enter a 3-second dialing pause (a **P** appears).
 - Press **MUTE/DELETE** to erase a digit.
 - Press and hold **MUTE/DELETE** to erase all digits.



-OR-

- Copy a number from the redial list by pressing **REDIAL/PAUSE** and then **▼CID** or **▲DIR**, or pressing **REDIAL/PAUSE** repeatedly to locate the desired number. Press **MENU/SELECT** to copy the number.
5. Press **MENU/SELECT** to save the number in the display.
 6. Enter the name when prompted. Use the dialing keys and refer to **Character chart** on page 32 to enter a name (up to 15 characters). Each time you press a key, the character on that key appears. Additional key presses produce other characters on that key.

- Press **0** to add a space.
- Press **▼CID** or **▲DIR** to move the cursor to the left or right.
- Press **MUTE/DELETE** to erase a character.
- Press and hold **MUTE/DELETE** to erase all characters.

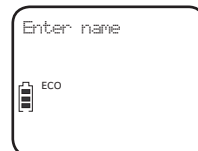

Directory

Create directory entries

Character chart:

Dialing key	Characters by number of key press										
	1	2	3	4	5	6	7	8	9	10	11
1	1	.	-	'	()	*	#	&	/	,
2	a	b	c	A	B	C	2				
3	d	e	f	D	E	F	3				
4	g	h	i	G	H	I	4				
5	j	k	l	J	K	L	5				
6	m	n	o	M	N	O	6				
7	p	q	r	s	P	Q	R	S	7		
8	t	u	v	T	U	V	8				
9	w	x	y	z	W	X	Y	Z	9		
0	space	0									

7. Press **MENU/SELECT** to store your new directory entry. The handset shows **Saved** and a confirmation tone sounds.

 **NOTE:** The screen shows **Number repeated** if the number is already in the directory. You cannot save the same number more than once.

Directory

Create directory entries

Add a predialed telephone number to the directory

1. While the handset is in idle mode, use the dialing keys to enter the telephone number (up to 30 digits).
 - Press and hold REDIAL/PAUSE to insert a 3-second dialing pause (a **P** appears).
 - Press **MUTE/DELETE** to erase a digit.
 - Press and hold MUTE/DELETE to erase all digits.
2. Press **MENU/SELECT** twice to move on to edit the name. Refer to Step 6 in **Create a new directory entry** on page 31.
3. Press **MENU/SELECT** to store your new directory entry. The handset shows **Saved** and sounds a confirmation tone.

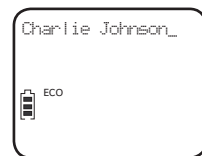

Directory

Review the directory

Review directory entries

1. Press **▲DIR** when in idle mode. The screen shows a summary briefly, then the first entry in the directory. **Directory empty** appears if there are no directory entries.



2. Press **▼CID** or **▲DIR** to browse through the directory. Entries appear alphabetically by the first letter in the name.

-OR-

1. Press **MENU/SELECT** when in idle mode.
2. Press **▼CID** or **▲DIR** to scroll to **Directory**, then press **MENU/SELECT**.
3. Press **▼CID** or **▲DIR** to scroll to **Review**, then press **MENU/SELECT**. The screen shows a summary briefly, then the first entry in the directory.
4. Press **▼CID** or **▲DIR** to browse through the directory. Entries appear alphabetically by the first letter in the name.



i NOTE: If the telephone number in the directory exceeds 15 digits, a dash appears after the 14th digit, and the remaining digits are displayed after two seconds beginning with a dash.

Directory

Review the directory

Search by name

1. Press **▲DIR** when the handset is in idle mode.
2. When an entry appears, use the dialing keys (**0-9**) to start a name search (alphabetical search).

The directory shows the first name beginning with the first letter associated with the dialing key, if there is an entry in the directory that begins with that letter. Press

▼CID or **▲DIR** to scroll through the entries beginning with that letter.

3. To see other names that start with the letters on the same dialing key, keep pressing the key until the desired letter is shown. The names appear in alphabetical order.

For example, if you have the names Jennifer, Jessie, Kevin and Linda in your directory:

- If you press **5 (JKL)** once, **J** and then **Jennifer** displays.
- If you press **5 (JKL)** once, **J** displays. Press **▼CID**. **Jessie** displays.
- If you press **5 (JKL)** twice, **K** and then **Kevin** displays.
- If you press **5 (JKL)** three times, **L** and then **Linda** displays.
- If you press **5 (JKL)** four times, **5** displays.
- If you press **5 (JKL)** five times, **J** displays and then **Jennifer** displays again.

i NOTE: If you press a dialing key (**0-9**) and no name starts with any letter on that key, the directory shows the entry that matches the next letter in the directory.



Directory

Dial, delete and edit a directory entry

You can dial, delete or edit a displayed directory entry.

See **Review directory entries** on page 34 or **Search by name** on page 35 to show an entry from the directory.

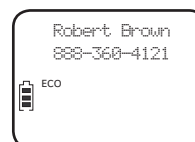

Dial a directory number

While reviewing a directory entry, press **PHONE/FLASH** or **Ⓜ/SPEAKER** to dial the displayed telephone number from the directory.



Delete a directory entry

1. While reviewing a directory entry, press **MUTE/DELETE**. The screen shows **Delete contact?**
2. Press **MENU/SELECT** to delete the displayed entry from the directory. The handset shows **Deleting...** and then **Contact deleted** with a confirmation tone. Once deleted, you cannot retrieve that entry.



i NOTE: If the directory entry you deleted is also in the speed dial location, the telephone will automatically clear the number stored in that speed dial location.

Edit a directory entry

1. While reviewing a directory entry, press **MENU/SELECT**. The screen shows **Edit number** with the current number of the entry.
 2. Edit the telephone number.
 - Use the dialing keys to enter a number (up to 30 digits).
 - Press **▼CID** or **▲DIR** to move the cursor to the left or right.
 - Press and hold **REDIAL/PAUSE** to enter a 3-second dialing pause (a **P** appears).
 - Press **MUTE/DELETE** to erase a digit.
 - Press and hold **MUTE/DELETE** to erase all digits.
- OR-**
- Copy a number from the redial list by pressing **REDIAL/PAUSE** and then **▼CID** or **▲DIR**, or pressing **REDIAL/PAUSE** repeatedly to locate the number. Press **MENU/SELECT** to copy the number.

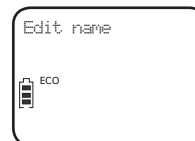
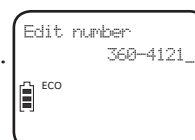

Directory

Dial, delete and edit a directory entry

3. Press **MENU/SELECT** to save the number. The screen shows **Edit name** with the current name of the entry.
4. Edit the characters.
 - Press **0** to add a space.
 - Press **▼CID** or **▲DIR** to move the cursor to the left or right.
 - Press **MUTE/DELETE** to erase a character.
 - Press and hold **MUTE/DELETE** to erase all characters.
5. Press **MENU/SELECT** to save. The handset shows **Saved**, then the updated entry.

Directory

Speed dial

The telephone system has nine speed dial locations (**2-9, 0**) and a voicemail access location **1** where you can store the telephone numbers you wish to dial more quickly. You can store up to 30 digits in each location. Speed dial assignments can only be selected from the existing directory entries. The voicemail access number must be manually entered.

Assign a speed dial number

1. Press **MENU/SELECT** when the handset is in idle mode.
2. Press **▼CID** or **▲DIR** to scroll to **Directory**, then press **MENU/SELECT**.
3. Press **▼CID** or **▲DIR** to scroll to **Speed dial**, then press **MENU/SELECT**.
4. Press **▼CID** or **▲DIR** to choose your desired speed dial location, or press the dialing key (**2-9, 0**) corresponding to the location you wish to assign, then press **MENU/SELECT**. The handset briefly shows **Copy from DIR..** and then enters the directory.
5. Press **▼CID** or **▲DIR** to scroll to the phone number you wish to assign to the selected speed dial location.
6. Press **MENU/SELECT** to save. The name (up to 12 characters) of the desired directory entry appears in the selected speed dial location.



Speed dial

Reassign a speed dial number

1. Press **MENU/SELECT** when the handset is in idle mode.
2. Press **▼CID** or **▲DIR** to scroll to **Directory**, then press **MENU/SELECT**.
3. Press **▼CID** or **▲DIR** to scroll to **Speed dial**, then press **MENU/SELECT**.
4. Press **▼CID** or **▲DIR**, or the dialing key (**2-9, 0**) corresponding to the location you wish to reassign.
5. Press **MENU/SELECT** twice. The screen shows **Reassign SD**.
6. Press **MENU/SELECT**. The handset briefly shows **Copy from DIR..** and then enters your directory list.
7. Press **▼CID** or **▲DIR** to scroll to the phone number you wish to reassign to the selected speed dial location.
8. Press **MENU/SELECT** to save. The name (up to 12 characters) of the desired directory entry appears in the selected speed dial location.

Clear a speed dial location

1. Follow Steps 1-3 in **Reassign a speed dial number** to enter the speed dial list.
2. Press **▼CID** or **▲DIR** to scroll to the desired speed dial location.
3. Press **MUTE/DELETE**. The screen displays **Clear SD #X?** (**X** represents the speed dial location number).
4. Press **MENU/SELECT** to confirm.

 **NOTE:** Clearing the speed dial locations does not affect the entries in the directory.

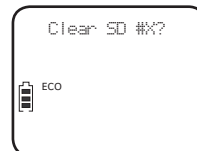

Assign your speed dial voicemail number

See the **Set speed dial voicemail number** section on page 14 for instructions on assigning your speed dial voicemail number.

Directory

Speed dial

Make a call using speed dial

When in idle mode, press and hold the dialing key (**0** or **2-9**) corresponding to the assigned speed dial number you wish to call.

-OR-

1. Press **MENU/SELECT** when the handset is in idle mode.
2. Press **▼CID** or **▲DIR** to scroll to **Directory**, then press **MENU/SELECT**.
3. Press **▼CID** or **▲DIR** to scroll to **Speed dial**, then press **MENU/SELECT**.
4. Press **▼CID** or **▲DIR** to scroll to the desired location (**0** or **2-9**) and then press **☎PHONE/FLASH** or **🔊/SPEAKER** to call.

Check your voicemail using speed dial

Press and hold the **1** key on your handset to dial your voicemail number.

Caller ID

About caller ID

This product supports caller ID services offered by most telephone service providers. Caller ID allows you to see the name, number, date and time of calls. The available caller ID information will appear after the first or second ring.

Information about caller ID with call waiting

Caller ID with call waiting lets you see the name and telephone number of the caller before answering the call, even while on another call.

It may be necessary to change your telephone service to use this feature. Contact your telephone service provider if:

- You have both caller ID and call waiting, but as separate services (you may need to combine these services).
- You have only caller ID, or only call waiting service.
- You don't subscribe to caller ID or call waiting services.

There may be fees for caller ID services. In addition, services may not be available in all areas.

This product can provide information only if both you and the caller are in areas offering caller ID services and if both telephone service providers use compatible equipment. The time and date are sent by the telephone service provider along with the call information.

The caller ID information may not be available for every incoming call. The callers may intentionally block their names and/or telephone numbers.

i NOTE: You can use this product with regular caller ID service, or you can use this product's other features without subscribing to either caller ID or combined caller ID with call waiting service.

About home area code

See **Home area code** on page 17 to determine if you should enter your area code. Entering the area code changes how numbers are displayed in the caller ID log and how to return a call from the caller ID log (see **View dialing options** on page 44).

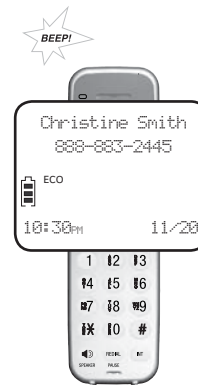

Caller ID log

How caller ID log works

The telephone stores caller ID information about the last 50 incoming calls in the telephone base. Each entry may have up to 24 digits for the telephone number and 15 characters for the name. Entries are stored in reverse chronological order. The telephone deletes the oldest entry when the log is full to make room for new calls. This information is common to all handsets, so changes made to any handset are reflected in all other handsets. If you answer a call before the information appears on the screen, it does not show in the caller ID log.

i NOTE: The caller ID information might not be available for every incoming call. The callers might intentionally block their names and/or telephone numbers (see **Reasons for missing caller ID information** on page 47).

Memory match

If the incoming telephone number matches the last seven digits of a telephone number in your directory, the name that appears on the screen matches the corresponding name in your directory.

For example, if Christine Smith calls, her name appears as **Chris** if this is what you entered into your directory.



i NOTE: The number shown by your caller ID is in the format sent by the telephone service provider. The telephone service provider usually delivers 10-digit telephone numbers (area code plus telephone number). If the telephone number of the caller does not match a number in your directory, the name appears as it is delivered by the telephone service provider. For example, if the telephone service provider includes the area code but the number in your directory does not, the name appears as delivered by the telephone service provider.

Caller ID operation

Missed (new) calls indicator

When you have calls that have not been reviewed, all handset screens show **XX missed calls** when in idle mode.

All entries that have not been reviewed are counted as missed (new) calls. Each time you review a caller ID log entry marked as **NEW**, the number of missed calls decreases by one.

If you do not want to review the missed (new) calls one by one, but you still want to keep them in the caller ID log, you can press and hold  **OFF/CANCEL** for 4 seconds when the handset is idle. All the entries in the caller ID log will be considered old (reviewed), and the missed call(s) message goes away.



Review the caller ID log

Review the caller ID log to find out who called, to return the call or to copy the caller's name and number into your directory. **Call log empty** appears if there are no records in the caller ID log.

1. When a handset is in idle mode, press **▼CID** to view the caller ID log in reverse chronological order starting with the most recent call.

-OR-

You can also review the caller ID log by pressing **MENU/SELECT**, then **▼CID** or **▲DIR** to scroll to **Caller ID log**. Press **MENU/SELECT** twice to select **Review**.

2. Press **▼CID** or **▲DIR** to scroll through the list. The handset beeps twice when you reach the beginning or end of the caller ID log.

3. Press  **OFF/CANCEL** to exit the caller ID log.

NOTES:

- If the telephone number has more than 15 digits, only the last 15 digits appear in the caller ID log.
- Only one handset can review the caller ID log at a time. If another handset attempts to enter the caller ID log, it shows **Not available**.

Caller ID operation

View dialing options

Although the caller ID log entries received typically have 10 digits (the area code plus the 7-digit number), in some areas, you may need to dial only the seven digits, 1 plus the seven digits, or 1 plus area code plus the seven digits. You can follow the steps, as mentioned below, to change the number of digits that you dial in the caller ID log.

1. When a handset is in idle mode, press **▼CID** to view the caller ID log in reverse chronological order starting with the most recent call.
2. Before dialing or saving the telephone number in the directory, press **#** (pound key) repeatedly to show different dialing options for local and long distance numbers.

-OR-

Press **1** repeatedly if you need to add or remove **1** in front of the telephone number.

3. When the number is in the correct format for dialing, press **PHONE/FLASH** or **SPEAKER** to call the number.

To save the number to the directory, see **Save a caller ID log entry to the directory** on page 46.

i NOTE: If you do not need to dial the area code for local calls, make sure to program your home area code (see **Home area code** on page 17).

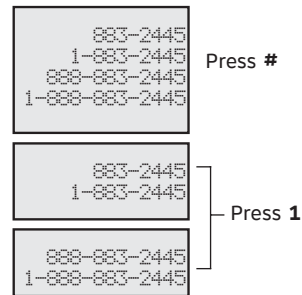

Caller ID operation

Dial a caller ID log entry

1. While reviewing the caller ID log entry, press ▼**CID** or ▲**DIR** to browse through the caller ID log.
2. Press **PHONE/FLASH** or **SPEAKER** to dial the displayed entry.

Delete caller ID log entries

To delete a caller ID log entry:

1. While reviewing the caller ID log, press ▼**CID** or ▲**DIR** to browse through the caller ID log.
2. Press **MUTE/DELETE** to delete the displayed entry from the caller ID log. The screen shows **Deleting...** with a confirmation tone. Once deleted, you cannot retrieve that entry.

To delete all caller ID log entries:

1. Press **MENU/SELECT** in idle mode.
2. Press ▼**CID** or ▲**DIR** to scroll to **Caller ID log**, then press **MENU/SELECT**.
3. Press ▼**CID** or ▲**DIR** to scroll to **Del all calls**, then press **MENU/SELECT**. The screen shows **Delete all?**
4. Press **MENU/SELECT** to delete all entries from the caller ID log. The screen shows **Deleting...** with a confirmation tone. Once deleted, you cannot retrieve that entry.



Caller ID operation

Save a caller ID log entry to the directory

1. While reviewing the caller ID log, press ▼**CID** or ▲**DIR** to browse through the caller ID log.
2. Press **MENU/SELECT**. The screen shows **Edit number**.
3. Use the dialing keys to modify the telephone number (up to 30 digits).
 - Press ▼**CID** or ▲**DIR** to move the cursor to the left or right.
 - Press and hold **REDIAL/PAUSE** to enter a 3-second dialing pause (a **P** appears).
 - Press **MUTE/DELETE** to erase a digit.
 - Press and hold **MUTE/DELETE** to erase all digits.
4. Press **MENU/SELECT** to save the number in the display. The screen shows **Edit name**.
5. Use the dialing keys and refer to **Character chart** on page 32 to modify the name (up to 15 characters).
 - Press **0** to add a space.
 - Press ▼**CID** or ▲**DIR** to move the cursor to the left or right.
 - Press **MUTE/DELETE** to erase a character.
 - Press and hold **MUTE/DELETE** to erase all characters.
6. Press **MENU/SELECT** to save. The screen shows **Saved** with a confirmation tone.

NOTES:

- The screen shows **Number repeated** if the number is already in the directory. You cannot save the same number more than once.
- If the directory is full, the screen shows **Directory full**.
- If you try to save a caller ID log entry to the directory without a number, **Unable to save** displays.
- If the telephone number has more than 15 digits, only the last 15 digits appear in the caller ID log. However, the telephone can still save all digits (up to 24 digits) of that telephone number from the caller ID log in the directory.
- You might need to change how a caller ID number is saved in the directory if the entry does not appear in the correct format. Caller ID numbers might appear with an area code that is not necessary for local calls, or without a **1** that is necessary for long distance calls. For details, see **View dialing options** on page 44.

Caller ID

Reasons for missing caller ID information

There are occasions when other information or no information shows for various reasons:

Screen message	Reason
PRIVATE NAME	The caller prefers not to show the name.
PRIVATE NUMBER	The caller prefers not to show the telephone number.
PRIVATE CALLER	The caller prefers not to show the name and telephone number.
UNKNOWN NAME	Your telephone service provider cannot determine the caller's name.
UNKNOWN NUMBER	Your telephone service provider cannot determine the caller's telephone number.
UNKNOWN CALLER	Your telephone service provider cannot determine the caller's name and telephone number. Calls from other countries may also generate this message.

Answering system

Answering system settings

Use the answering system menu in the handset to turn the answering system on or off or change the settings for the outgoing announcement, call screening, number of rings, remote access code and the message alert tone.

Announcement

The announcement is the greeting callers hear when calls are answered by the answering system.

The telephone has a default announcement, *"Hello. Please leave a message after the tone."* You can use this announcement, or record your own announcement.

You can record an announcement up to 90 seconds. The system does not record any announcement shorter than 2 seconds.

To play the current announcement:

1. Press **MENU/SELECT** in idle mode.
2. Press **▼CID** or **▲DIR** to scroll to **Answering sys**, then press **MENU/SELECT**.
3. Press **MENU/SELECT** to select **Announcement**.
The system announces, *"To play, press 2. To record, press 7."*
4. Press **2** to play the current announcement from the speakerphone.
 - Press **▲DIR/VOLUME** to increase or press **▼CID/VOLUME** to decrease the message playback volume.
 - Press **🔊/SPEAKER** to switch between speakerphone and handset.

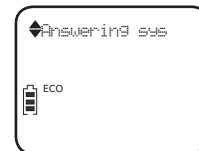

Answering system

Answering system settings

To record a new announcement:

1. Press **MENU/SELECT** in idle mode.
2. Press **▼CID** or **▲DIR** to scroll to **Answering sys**, then press **MENU/SELECT**.
3. Press **MENU/SELECT** to select **Announcement**. The system announces, *"To play, press 2. To record, press 7."*
4. Press **7**. The system announces *"Record after the tone. Press 5 when you are done."*
5. Face the handset and speak towards the microphone to record your announcement.
6. Press **5** when you finish the recording. The handset plays back the recorded announcement.



i NOTE: If the answering system memory is full, when you press **7** in Step 4, the answering system announces, *"Memory is full."* You must delete some messages before you can record a new announcement. Refer to **Message playback** on pages 60-62.

To delete your announcement:

1. Press **MENU/SELECT** in idle mode.
2. Press **▼CID** or **▲DIR** to scroll to **Answering sys**, then press **MENU/SELECT**.
3. Press **MENU/SELECT** to select **Announcement**. The system announces, *"To play, press 2. To record, press 7."*
4. Press **2** to play the current announcement from the speakerphone.
5. Press **3** during playback to delete your recorded announcement. The system announces, *"Announcement deleted."*

If your announcement is deleted, calls are answered with the default announcement, *"Hello. Please leave a message after the tone."*

Answering system settings

Answer on/off

Unless you change it, the answering system is on and ready to record messages. If the answering system is on, the **ANS ON** icon displays on the handset screen and the **ANS ON/OFF** light on the telephone base is on. You can turn the answering system off, but if you do so, the answering system does not answer calls and record incoming messages.

Using the handset:

1. Press **MENU/SELECT** in idle mode to enter the main menu.
2. Press **▼CID** or **▲DIR** to scroll to **Answering sys**, then press **MENU/SELECT**.
3. Press **▼CID** or **▲DIR** to scroll to **Answer on/off**, then press **MENU/SELECT**.
4. Press **▼CID** or **▲DIR** to select between **On** and **Off**, then press **MENU/SELECT** to save the setting.

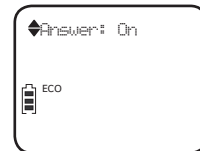

Using the telephone base:

- Press **ANS ON/OFF** to turn the answering system on or off. If the answering system is turned on, it announces, "Calls will be answered." If the answering system is turned off, it announces, "Calls will not be answered."



NOTES:

- If the answering system is off and there is an incoming call, the system answers after 10 rings and announces to the caller, "Please enter your remote access code." For more information about remote access, see **Remote access code** on page 53.
- You can turn the answering system on or off from either the handset or the telephone base, but you can only use the handset to change the other answering system settings.
- You cannot turn the answering system on or off while a handset is on a call or the telephone base is playing messages.

Answering system settings

Call screening

You can choose whether or not incoming messages are played through the speaker on the telephone base while they are being recorded. However, whether the call screening is on or off, the incoming messages can always be played through the handset.

To change the settings:

1. Press **MENU/SELECT** when in idle mode to enter the main menu.
2. Press **▼CID** or **▲DIR** to scroll to **Answering sys**, then press **MENU/SELECT**.
3. Press **▼CID** or **▲DIR** to scroll to **Ans sys setup**, then press **MENU/SELECT**.
4. Press **MENU/SELECT** to select **Call screening**.
5. Press **▼CID** or **▲DIR** to choose **On** or **Off**.
6. Press **MENU/SELECT** to save your setting.

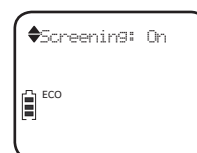

 **NOTE:** For more details about the features of call screening, see **Call screening** on page 58.

Answering system settings

Number of rings

You can set the answering system to answer an incoming call after **2, 3, 4, 5,** or **6** rings. You can also select **Toll saver**, which is explained below. Unless you change it, the answering system answers an incoming call after three rings.

To set the number of rings:

1. Press **MENU/SELECT** in idle mode to enter the main menu.
2. Press **▼CID** or **▲DIR** to scroll to **Answering sys**, then press **MENU/SELECT**.
3. Press **▼CID** or **▲DIR** to scroll to **Ans sys setup**, then press **MENU/SELECT**.
4. Press **▼CID** or **▲DIR** to scroll to **# of rings**, then press **MENU/SELECT**.
5. Press **▼CID** or **▲DIR** to scroll and choose among **2, 3, 4, 5, 6** or **Toll saver**.
 - Toll saver- the answering system answers a call after two rings if you have new messages, and after four rings when there are no new messages. This feature allows you to check for new messages and avoid paying long distance charges if you are calling from out of your local area.
6. Press **MENU/SELECT** to save your setting.



i NOTE: If you subscribe to a voicemail service offered through your telephone service provider, see **Answering system and voicemail indicators** on page 56.

Answering system settings

Remote access code

To access your answering system remotely from any touch-tone telephone, you need to enter a 2-digit number (**00-99**). Unless you change it, the remote access code is **19**.

To change the remote access code:

1. Press **MENU/SELECT** in idle mode to enter the main menu.
2. Press **▼CID** or **▲DIR** to scroll to **Answering sys**, then press **MENU/SELECT**.
3. Press **▼CID** or **▲DIR** to scroll to **Ans sys setup**, then press **MENU/SELECT**.
4. Press **▼CID** or **▲DIR** to scroll to **Remote code**, then press **MENU/SELECT**.
5. Press **▼CID** or **▲DIR** to select the remote access code, or use the dialing keys to enter the correct number (**00-99**).
6. Press **MENU/SELECT** to save your setting.

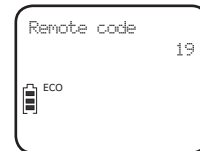
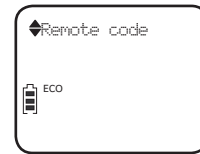

 **NOTE:** For more details about the remote access feature, refer to **Remote access** on page 65.

Answering system settings

Message alert tone

When the message alert tone is on, and there is at least one new message, the telephone base beeps every 10 seconds. By default, the message alert tone is set to **OFF**.

To change the setting:

1. Press **MENU/SELECT** in idle mode to enter the main menu.
2. Press **▼CID** or **▲DIR** to scroll to **Answering sys**, then press **MENU/SELECT**.
3. Press **▼CID** or **▲DIR** to scroll to **Ans sys setup**, then press **MENU/SELECT**.
4. Press **▼CID** or **▲DIR** to scroll to **Msg alert tone**, then press **MENU/SELECT**.
5. Press **▼CID** or **▲DIR** to choose **On** or **Off**.
6. Press **MENU/SELECT** to save your setting.

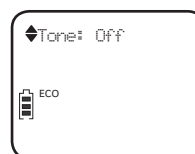

i NOTES:

- The message alert tone beeps only if all the following conditions are met:
 - The answering system is on.
 - The message alert tone is on.
 - There are new messages.
- To temporarily turn off the message alert tone, see **Temporarily turn off the message alert tone** on page 59.

Answering system settings

Recording time

You can set the recording time allowed for incoming messages. The message length is three minutes by default.

To change the setting:

1. Press **MENU/SELECT** in idle mode to enter the main menu.
2. Press **▼CID** or **▲DIR** to scroll to **Answering sys**, then press **MENU/SELECT**.
3. Press **▼CID** or **▲DIR** to scroll to **Ans sys setup**, then press **MENU/SELECT**.
4. Press **▼CID** or **▲DIR** to scroll to **Recording time**, then press **MENU/SELECT**.
5. Press **▼CID** or **▲DIR** to scroll and choose **3 minutes**, **2 minutes**, or **1 minute**.
6. Press **MENU/SELECT** to save your setting.



Answering system overview

Answering system and voicemail indicators

Your telephone has separate indicators for two different types of voice messages: those left on its built-in answering system and those left on your service provider's voicemail (fees may apply). Your telephone's built-in answering system messages and voicemail messages are separate. Each alerts you to new messages differently.

- If **XX new messages** displays on the handset and the message window on the telephone base flashes, there are new messages recorded on the built-in answering system. To listen to your message(s), press **MENU/SELECT** twice on the handset (page 60) or press **▶/■/PLAY/STOP** on the telephone base (page 60).
- If  and **New voicemail** display on the handset, your telephone service provider is indicating that it has new voicemail for you. To listen to your voicemail, dial an access number provided by your telephone service provider, followed by a security code or PIN.

Some service providers bundle or combine multiple services like voicemail and call waiting, so you may not be aware that you have voicemail. To check what services you have and how to access them, contact your telephone service provider.

To use your voicemail service rather than the answering system, turn off the answering system. To use the answering system rather than your voicemail service, contact your telephone service provider to deactivate your voicemail service.

Using the answering system and voicemail together

You can also use your telephone answering system and voicemail together by setting your built-in answering system to answer before voicemail answers, as described below. To learn how to program your voicemail settings, contact your telephone service provider. If you are on a call, or if the answering system is busy recording a message and you receive another call, the second caller can leave a voicemail message.

If you have voicemail provided by your telephone service provider, we recommend setting your answering system to answer calls at least 2 rings earlier than your voicemail is set to answer. For example, if your voicemail answers after 6 rings, set your answering system to answer after 4 rings. Some voicemail providers may program the delay before answering calls in seconds instead of rings. In this case, allow 6 seconds per ring when determining the appropriate setting.

Answering system

Answering system overview

Message capacity

The answering system can record up to 99 messages, depending on the length of each message. The maximum recording time (including message, announcement and memo) is 14 minutes and the recording time for individual messages can be set to 3 minutes, 2 minutes or 1 minute (page 55). The actual recording time depends on individual message characteristics. Messages remain available for replay until you delete them.

If the answering system has less than 3 minutes of recording time left, *"Less than 3 minutes to record"* is announced before the message playback and **Rec mem full** appears on the handset screen.

If the memory is full, the answering system announces, *"Memory is full."* The number of messages and **F** flash alternatively in the message window, and **Rec mem full** appears on the handset screen. You must delete some messages before recording new ones.

Voice prompts

The system provides voice prompts to guide you to operate the answering system.

Answering system overview

Call screening

Call screening at the base:

If the answering system and call screening are on, the announcement and the incoming message can be broadcast at the telephone base when a call arrives.

You can turn call screening on or off using the handset (see **Call screening** on page 51). When call screening is off, you can temporarily turn on the call screening by pressing **▶/■/PLAY/STOP** or **▲/VOLUME+** on the telephone base. The call screening will automatically be off for the next incoming call.

If call screening is on and you want to silence the telephone base while it is recording messages, press **▶/■/PLAY/STOP** on the telephone base. The call screening will be on for the next incoming call.

Call screening at the handset:

If the answering system is turned on, when there is an incoming call and it is answered by the answering system, the handset screen shows

To screen call, press [SELECT]. By pressing **MENU/SELECT**, you can screen the call at the handset.



Answering system

Answering system overview

Call intercept

While call screening, you can stop the recording and speak to the caller.

- If the call is screened at the base, press **PHONE/FLASH** or **SPEAKER** on the handset to stop recording and speak to the caller.
- If the call is screened at the handset, press **PHONE/FLASH** on the handset to stop recording and speak to the caller. You can press **SPEAKER** to switch between the speakerphone and the handset.

Temporarily turn off the message alert tone

If the message alert tone is turned on, the telephone base beeps every ten seconds when there are new messages. Pressing any telephone base key (except **HANDSET LOCATOR**) temporarily silences the message alert tone.

If you press **X/DELETE** when in idle mode to temporarily turn off the message alert tone, there is a voice prompt directing you to press **X/DELETE** again to delete all old messages. The message alert tone is temporarily off. Only press **X/DELETE** a second time if you wish to erase all old messages in your answering system.

The message alert tone resumes when you receive another message.

Answering system

Message playback

You can listen to messages at the telephone base or on a cordless handset. When playback begins, the total number of messages is announced. Before each message, you hear the day and time of the recording. If the date and time are not set, you hear, *"Time and date not set,"* before playback. After the last message, you hear, *"End of messages."* If the recording time is less than three minutes, you hear, *"Less than three minutes to record,"* (see **Message capacity** on page 57).

To listen to messages at the telephone base:

1. Press **▶/■/PLAY/STOP** on the telephone base to listen to the messages.
2. The system announces the number of messages, then begins playback. The message sequence is shown on the message window.
3. Press **▶/■/PLAY/STOP** to stop the playback.

i NOTE: If there are no messages in the answering system, the system announces, *"You have no message."* when you attempt to listen to messages.

To listen to messages at the handset:

1. Press **MENU/SELECT** when the handset is in idle mode.
2. Press **MENU/SELECT** to select **Play messages**.
3. The system announces the number of messages, then begins playback. The message sequence is shown on the handset's screen.
4. Press **OFF/CANCEL** to stop the playback.

i NOTE: If there are no messages in the answering system, the handset shows **No message** and announces, *"You have no message."* when you attempt to listen to messages.

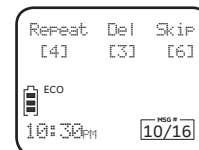

Answering system

Message playback

Options during playback

When a message is playing, you can adjust the playback volume, skip, repeat, or delete the message.

When messages are playing on the telephone base:

- Press **▼/▲/-VOLUME+** to adjust the message playback volume (1-8).
- Press **◀/REPEAT** to repeat the playing message.
- Press **◀/REPEAT** twice to listening to the previous message.
- Press **▶/SKIP** to skip to the next message.
- Press **X/DELETE** to delete the message. The telephone base announces, *"Message deleted."*
- Press **▶/■/PLAY/STOP** to stop the playback.

When messages are playing on the handset:

- Press **▲DIR/VOLUME** to increase or press **▼CID/VOLUME** to decrease the message playback volume.
- Press **📞/SPEAKER** to switch between speakerphone and handset.
- Press **4** to repeat the playing message.
- Press **4** twice to listening to the previous message.
- Press **6** to skip to the next message.
- Press **3** to delete the message. The handset announces, *"Message deleted."*
- Press **🔴 OFF/CANCEL** to stop playback.

Answering system

Message playback

Delete all old messages

Use this feature to delete all old messages. Once deleted, you cannot retrieve the deleted messages. New messages cannot be deleted until you have listened to them.

To delete all old messages on the telephone base:

1. Press **X/DELETE** on the telephone base when the answering system is not in use. The system announces, *"To delete all old messages, press **DELETE** again."*
2. Press **X/DELETE** again. The system announces, *"All old messages deleted."*

To delete all old messages on the handset:

1. Press **MENU/SELECT** when in idle mode to enter the main menu.
2. Press **▼CID** or **▲DIR** to scroll to **Answering sys**, then press **MENU/SELECT**.
3. Press **▼CID** or **▲DIR** to scroll to **Delete all old**, then press **MENU/SELECT**. The screen shows **Delete all msg?**
4. Press **MENU/SELECT** to confirm. The screen shows **Deleting...** and then **No old messages** with a confirmation tone.



Answering system

Recording and playing memos

Memos are your own recorded messages used as reminders for yourself or others using the same answering system. Play and delete them in the same way as incoming messages.

Record a memo

1. Press **MENU/SELECT** when in idle mode to enter the main menu.
2. Press **▼CID** or **▲DIR** to scroll to **Answering sys**, then press **MENU/SELECT**.
3. Press **▼CID** or **▲DIR** to scroll to **Record memo**.
4. Press **MENU/SELECT**. The system announces, *"Record after the tone. Press 5 when you are done."*
5. Speak towards the microphone on the handset after a long beep. You can record a memo up to 3 minutes. Memos shorter than 2 seconds are not recorded.
6. Press **5** to stop recording. The system announces *"Recorded"*.



Play back memos

Memos are stored as messages. See **Message playback** on pages 60-62 for instructions on playback and deletion.

Answering system

Message window displays

The message window on the telephone base displays the total number of messages. See the following table for other message window displays.

0	There are no messages in the answering system.
0 (flashing)	After a power failure, the number in the message window flashes to indicate that the date and time need to be set.
1-99	<ul style="list-style-type: none">• Total number of messages and memos.• Current message number during old message playback.
1-99 (flashing)	<ul style="list-style-type: none">• Total number of new messages and memos. The number flashes when there are new messages that have not been reviewed.• Current message number during new message playback.• After a power failure, the number in the message window flashes to indicate that the date and time need to be set.
1-99 and F (alternating)	Memory is full. Messages must be deleted before new messages can be recorded.
--	<ul style="list-style-type: none">• The answering system is being programmed by a system handset.• The answering system is answering a call or recording a memo or announcement.• The answering system is being accessed remotely.• The directory or caller ID log is being accessed by a system handset.
0-6	Telephone base ringer volume while adjusting.
1-8	Speaker volume level of the telephone base while adjusting.

Answering system

Remote access

You can access the answering system remotely by dialing your home telephone number from any touch-tone telephone.

Remotely access the answering system

1. Dial your telephone number from any touch-tone telephone.
2. When the answering system answers, enter the 2-digit remote access code (**19**, by default; refer to **Remote access code** on page 53). The answering system automatically announces the number of messages (new or old) if there are any.
3. If there are new messages, the answering system automatically begins to play all new messages only.

-OR-

If there are no new messages, the answering system automatically begins to play all old messages.

4. You can also enter the remote commands:

1	Press to listen to all messages. If there are new messages, the system plays only the new messages (in chronological order). If there are no new messages, the system plays all old messages (in chronological order).
2	Press to listen to new messages only.
3	Press during message playback to delete the current message.
33	Press to delete all old messages.
4	Press 4 to repeat the playing message. Press 4 twice to listen to the previous message.
5	Press to stop playback and recording.
*5	Press to listen to a list of remote commands.
6	Press during playback to skip the current message and advance to the next message.
*7	Press to record a new announcement. Begin speaking after the long beep.
8	Press to end remote access (the call ends).
0	Press to turn the answering system on or off.

Answering system

Remote access

5. Hang up to end the call and save all messages.

Cut out and carry the remote access wallet card at the back of this user's manual for quick reference.

 **NOTES:**

- If you do not enter a valid remote access code, the system answers the call automatically.
- Once the messages have played, the telephone announces the help menu options. If you do not press any key within 20 seconds, the remote access call ends automatically.
- If the memory is full, the answering system answers after 10 rings and announces, *"Memory is full. Enter the remote access code."* Enter your remote access code to access the messages and announcements.
- When the answering system is turned off, the telephone answers after 10 rings, and announces, *"Please enter your remote access code."*

Adding and registering handsets

Your telephone system can support up to five handsets. The handsets provided within your product package are already registered as **HANDSET 1**, and so forth. You can purchase additional handsets AT&T **AWX20004/AWX20014/AWX20024/AWX20034** to expand your telephone system. Additional handsets are assigned numbers in the sequential order they are registered (up to **HANDSET 5**). Each handset must be registered to the telephone base before use.

Register a handset to the telephone base

1. Before you begin registration, make sure the handset is out of the telephone base or charger and shows **To register HS...** and **...see manual**, alternately.
2. Put the handset you wish to register on the telephone base cradle.
3. The **IN USE** light on the telephone base turns on. After about 10 seconds, the handset shows **Registering...** The handset shows **Registered** and you hear a confirmation tone if the registration was successful. The **IN USE** light turns off. The handset is now registered with the telephone base.



For registration, put the handset on the telephone base, not the handset charger.

If the registration fails, the handset displays **Failed** and then **To register HS...** and **...see manual**, alternately. Try the registration again by removing the handset from the telephone base and then placing it back in.

i **NOTES:**

- You cannot register a handset if any other system handset is in use.
- You can only register one handset to the telephone base at a time.



Appendix

Deregistering handsets

If you want to replace a handset, or reassign the designated handset number of a registered handset, you must deregister all handsets that are registered to the telephone base, and then register each handset individually.

To make deregistration easier, read all of the instructions on this page before you begin.

Deregister all handsets from the telephone base

1. Press and hold /HANDSET LOCATOR on the telephone base for about 10 seconds until the **IN USE** light on the telephone base turns on and starts to flash.
2. Immediately press /HANDSET LOCATOR again. You must press /HANDSET LOCATOR while the **IN USE** light is still flashing. The **IN USE** light flashes for approximately five seconds.
3. The deregistration takes about 10 seconds to complete. All handsets display **To register HS...** and **...see manual**, alternately, if the deregistration was successful.

To register the handset(s) to the telephone base again, follow the registration instructions on the previous page.

NOTES:





- If the deregistration fails, you may need to reset the system and try again. To reset, unplug the power from the telephone base and plug it back in.
- You cannot deregister the handsets if any other system handset is in use.
- Even if the battery is depleted, you can still deregister the handsets by following the step mentioned above. After the handset is charged for at least ten minutes, the screen shows **To register HS...** and **...see manual**, alternately.

Appendix

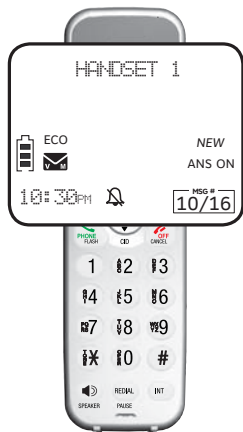
Screen icons, indicator lights and alert tones

Screen icons

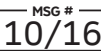

 (flashing)	The battery icon flashes when the battery is low and needs charging.
 (animated display)	The battery icon animates when the battery is charging.
	The battery icon becomes solid when the battery is fully charged.
	The handset ringer is turned off.
	There are new voicemail received from the telephone service provider.
ANS ON	The answering system is turned on.
ECO	The ECO mode activates automatically to reduce power consumption when the handset is within range from the telephone base.
NEW	The entry you are reviewing is new in the caller ID log.
	The message number currently playing and total number of new/old messages recorded.

Handset indicator lights



CHARGE light

On when the handset is charging in the telephone base or charger.

Extra large display

Lighted big buttons

SPEAKER light

On when the speakerphone is in use.

Screen icons, indicator lights and alert tones

Telephone base indicator lights

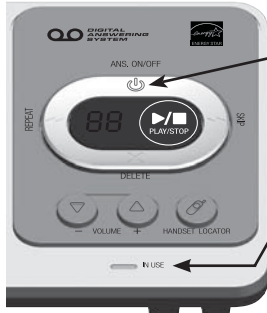

⏻/ANS ON/OFF light

On when the built-in answering system is on.

IN USE light

- On when the handset is in use, when the answering system is answering an incoming call or when the answering system is being accessed remotely.
- On when a handset is being registered.
- Flashes slowly when another telephone on the same line is in use, or when all handsets are being deregistered.
- Flashes quickly when there is an incoming call.

Handset alert tones

1 short beep	<ul style="list-style-type: none"> • A key is pressed. • Plays at the end of each message playback.
1 long beep	<ul style="list-style-type: none"> • Beginning or end of recording. • Plays at the end of all messages playback.
2 short beeps	<ul style="list-style-type: none"> • Error tone. The command has failed. • You have reached the beginning or end of the list. • You have reached the minimum or maximum listening volume.
3 short beeps	The handset is out of range or there is no power at the telephone base.
3 short high-pitched beeps	Confirmation tone. The telephone has completed the command successfully.
4 short beeps	Low battery warning.

Telephone base alert tones

One short beep	Plays at the end of each message playback.
Beeps every 10 seconds	Message alert tone is on and there are new messages.
One long beep	<ul style="list-style-type: none"> • Call screening is on and the answering system is about to record a message. • Plays at the end of all messages playback.

Appendix

Handset display screen messages

Call log empty	You are accessing an empty caller ID log.
Calling HS X (For models with two or more handsets only)	The handset is calling another handset (for intercom calls).
Directory empty	There are no directory entries.
Directory full	The directory is full. You cannot save any new entries unless you delete some current entries.
Ended	You have just ended a call.
HS X is calling (For models with two or more handsets only)	Another handset is calling.
Incoming call	There is an incoming call.
Intercom	The handset is on an intercom call.
Intercom ended	The intercom call has just ended.
Intercom to (For models with two or more handsets only)	You have started the intercom process, and need to enter the number of the handset you wish to call.
Line in use	An extension telephone on the same line or one of the handsets is in use.
Low battery	The battery needs to be charged.
Microphone on	Mute is off so the other party can hear your voice.
Muted	The microphone is off.
New voicemail	There are new voicemail messages from your telephone service provider.
No battery	The handset in the telephone base or charger does not have a battery properly installed.
No line	There is no telephone line connected.
No message	There are no messages in the answering system.
Not available	Someone else is already using the directory, speed dial list, caller ID log or answering system.

Appendix

Handset display screen messages

Number repeated	The telephone number you have entered is already stored in the directory.
Out of range or no pwr at base	The handset has lost communication with the telephone base.
Outside call	You switched to an external call during an intercom call.
** Paging **	The telephone base is paging all handsets.
Phone	The handset is on a call.
Put in charger	The battery is very low. The handset should be placed in the telephone base or charger.
Quiet mode off	The quiet mode is turned off.
Quiet mode on	The quiet mode is turned on.
Rec mem low	The answering system has less than 3 minutes to record.
Rec mem full	The answering system memory is full.
Ringer muted	The ringer is muted temporarily during an incoming call.
Saved	An entry has been successfully saved in the directory.
Speaker	The handset speakerphone is in use.
To register HS... ...see manual	The handset is not registered to any telephone base.
To screen call press [SELECT]	The system is recording a message. Press SELECT to screen a call on a handset.
Transferred	You have transferred an outside call to another cordless handset.
Unable to call	<ul style="list-style-type: none"> • Intercom failed. • You try to join a call when there are already four handsets on that call. • You try to make a call when the handset is out of range.
Unable to save	You cannot save a caller ID log entry to the directory without a number.
XX missed calls	There are XX new calls in the caller ID log.
XX new messages	There are XX new messages in the answering system.

Troubleshooting

If you have difficulty with your telephone, please try the following suggestions. For customer service, or to purchase accessories or replacement parts, visit our website at **www.telephones.att.com**, or call **1 (800) 222-3111**. In Canada, dial **1 (866) 288-4268**.

My telephone doesn't work at all.

- Make sure the power cord is securely plugged in.
- Make sure that the battery connector is securely plugged into the cordless handset.
- Make sure the telephone line cord is securely and firmly plugged into the telephone base and the telephone wall jack.
- Charge the battery in the cordless handset for at least 16 hours. For optimum daily performance, return the cordless handset to the telephone base or charger when not in use.
- If the battery is depleted, charge the handset for at least 30 minutes before you use it. Refer to **Battery charging** on page 8 for details.
- Reset the telephone base. Unplug the electrical power. Wait for approximately 15 seconds, then plug it back in. Allow up to one minute for the cordless handset and telephone base to reset.
- You may need to purchase a new battery. Please refer to **Battery installation** on page 7.

The display shows No line. I cannot get a dial tone.

- First try all of the suggestions, as mentioned above.
- If the previous suggestions do not work, disconnect the telephone line cord from your telephone and connect the telephone line cord to another telephone.
 - If there is no dial tone on that other telephone either, your telephone line cord may be defective. Install a new telephone line cord.
 - If changing the telephone line cord does not help, the wall jack (or the wiring to this wall jack) may be defective. Try using a different wall jack in your home to connect your **AWX22104** telephone, or **contact your telephone service provider** (charges may apply).

Troubleshooting

I cannot dial out.

- First try all the suggestions in the item **The display shows No line. I cannot get a dial tone.**
- Make sure you have a dial tone before dialing. The cordless handset may take a second or two to find the telephone base and produce a dial tone. This is normal. Wait an extra second before dialing.
- Check that all the telephones connected to the same telephone line are hung up.
- Make sure to set the dial mode to the correct setting (pulse dialing or tone dialing) for the service in your area.
- Eliminate any background noise. Noise from a television, radio or other appliances may cause the telephone not to dial out properly. If you cannot eliminate the background noise, first try muting the cordless handset before dialing, or dialing from another room with less background noise.
- If other telephones in your home are having the same problem, the problem is in your wiring or telephone service. Contact your telephone service provider (charges may apply).

My cordless handset isn't performing normally.

- Make sure the power cord is securely plugged into the telephone base. Plug the power adapter into a different, working electrical outlet not controlled by a wall switch.
- Move the cordless handset closer to the telephone base. You might have moved out of range.
- Reset the telephone base. Unplug the electrical power. Wait for 15 seconds, then plug it back in. Allow up to one minute for the cordless handset and telephone base to reset.
- Other electronic products such as HAM radios and other DECT phones, can cause interference to your cordless telephone. Try installing your telephone as far away as possible from these types of electronic devices.

Troubleshooting

Out of range or no pwr at base appears on my cordless handset.

- Ensure that the telephone base is powered on.
- Place the cordless handset in the telephone base for one minute to allow the cordless handset and base to synchronize.
- Move the cordless handset closer to the telephone base. You might have moved out of range.
- Reset the telephone base. Unplug the electrical power. Wait for 15 seconds, then plug it back in. Allow up to one minute for the cordless handset and telephone base to reset.
- Other electronic products such as HAM radios and other DECT phones, can cause interference to your cordless telephone. Try installing your telephone as far away as possible from these types of electronic devices.

The batteries do not hold a charge.

- If the cordless handset is in the telephone base or charger and the charge light does not come on, refer to the item **The charge light is off** on this page.
- Charge the battery in the cordless handset for at least 16 hours. For optimum daily performance, return the cordless handset to the telephone base or charger when not in use.
- If the battery is depleted, it may take approximately 30 minutes to charge the handset before it shows **LOW BATTERY**. Refer to **Battery charging** on page 8 for details.
- You may need to purchase a new battery. Please refer to **Battery installation** on page 7.

The charge light is off.

- Make sure the power cord is plugged in correctly and securely.
- Make sure the battery is installed correctly in the handset. Follow the instruction in **Battery installation** on page 7 to install the battery.
- Unplug the electrical power. Wait for 15 seconds, then plug it back in. Allow up to one minute for the cordless handset and telephone base to reset.
- Clean the cordless handset and telephone base charging contacts each month using a pencil eraser or cloth.

Troubleshooting

I get noise, static, or weak signals even when I'm near the telephone base.

- If you subscribe to high-speed Internet service (DSL - digital subscriber line) through your telephone line, you must install a DSL filter between the telephone line cord and the telephone wall jack (see **Telephone base installation** on page 6). The filter prevents noise and caller ID problems caused by DSL interference. Please contact your DSL service provider for more information about DSL filters.
- Other electronic products such as HAM radios and other DECT phones, can cause interference to your cordless telephone. Try installing your telephone as far away as possible from these types of electronic devices.
- Do not install this telephone near a microwave oven or on the same electrical outlet. You may experience decreased performance while the microwave oven is operating.
- If your telephone is plugged in with a modem or a surge protector, plug the telephone (or modem/surge protector) into a different location. If this doesn't solve the problem, relocate your telephone or modem farther apart from one another, or use a different surge protector.
- Relocate your telephone to a higher location. The telephone will likely have better reception when installed in a high area.
- If the other telephones in your home are having the same problem, the problem is in your wiring or telephone service. Contact your telephone service provider (charges may apply).

I experience poor sound quality when using the speakerphone.

- For increased sound quality while using the speakerphone, place the handset on a flat surface with the dial pad facing up.
- When using a speakerphone, controlling background noise in your environment is essential. While you are listening to your party, press **MUTE/DELETE** to temporarily turn your microphone off. When it is your turn to speak, remember to press **MUTE/DELETE** again to turn the microphone on.
- Excessive background noise will cause a speakerphone to fade in and out. Try controlling the background noise by turning off any audio devices near the speakerphone. Also, try to avoid interrupting the person at the other end of the conversation while they are speaking. If background noise cannot be controlled, you should terminate speakerphone operation and return to normal handset mode.

Troubleshooting

I hear other calls while using my telephone.

- Disconnect the telephone base from the telephone wall jack, and plug in a different telephone. If you still hear other calls, the problem is probably in your wiring or telephone service. Call your telephone service provider (charges may apply).

My calls cut in and out while I'm using my cordless handset.

- Other electronic products such as HAM radios and other DECT phones, can cause interference to your cordless telephone. Try installing your telephone as far away as possible from these types of electronic devices.
- Move the handset closer to the base. The operating range may vary with environmental conditions and time of use. There may be places within your environment that a cordless telephone will not work well. If the problem only occurs in certain areas of your environment, you can conclude that there is nothing wrong with the telephone.
- Do not install this telephone near a microwave oven or on the same electrical outlet. You may experience decreased performance while the microwave oven is operating.
- If your telephone is plugged in with a modem or surge protector, plug the telephone (or modem/surge protector) into a different location. If this doesn't solve the problem, relocate your telephone or modem farther apart from one another, or use a different surge protector.
- Relocate your telephone base to a higher location. The telephone will have better reception when installed in a high area.
- If the other telephones in your home are having the same problem, the problem is in your wiring or telephone service. Contact your telephone service provider (charges may apply).
- If you subscribe to high-speed Internet service (DSL - digital subscriber line) through your telephone line, you must install a DSL filter between the telephone line cord and the telephone wall jack (see **Telephone base installation** on page 6). The filter prevents noise and caller ID problems caused by DSL interference. Please contact your DSL service provider for more information about DSL filters.

Troubleshooting

My cordless handset does not ring when I receive a call.

- Make sure that the ringer is not turned off. Refer to **Ringer volume** on page 13.
- Make sure the telephone line cord is plugged securely into the telephone base and the telephone wall jack. Make sure the power cord is securely plugged in.
- The cordless handset may be too far from the telephone base.
- Charge the battery in the cordless handset for at least 16 hours. For optimum daily performance, return the cordless handset to the telephone base or charger when not in use.
- You may have too many extension telephones on your telephone line to allow all of them to ring simultaneously. Try unplugging one telephone at a time until the telephone start ringing.
- The layout of your home or office might be limiting the operating range. Try moving the telephone base to another location, preferably on an upper floor.
- If the other telephones in your home are having the same problem, the problem is in your wiring or telephone service. Contact your telephone service provider (charges may apply).
- Test a working telephone at the telephone wall jack. If another telephone has the same problem, the problem is the telephone wall jack. Contact your telephone service provider (charges may apply).
- Other electronic products such as HAM radios and other DECT phones, can cause interference to your cordless telephone. Try installing your telephone as far away as possible from these types of electronic devices.
- Completely remove and then replace the battery. Place the cordless handset in the telephone base. Wait for the cordless handset to reestablish its connection with the telephone base. Allow up to one minute for this to take place.
- Your telephone line cord might be defective. Try installing a new telephone line cord.

Troubleshooting

My caller ID isn't working.

- Caller ID is a subscription service. You must subscribe to this service from your telephone service provider for this feature to work on your telephone.
- Your caller must be calling from an area that supports caller ID.
- Both your and your caller's telephone service providers must use caller ID compatible equipment.
- Make sure the home area code is set correctly in the telephone (see **Home area code** on page 17).
- If you subscribe to high-speed Internet service (DSL - digital subscriber line) through your telephone line, you must install a DSL filter between the telephone line and the telephone wall jack (see **Telephone base installation** on page 6). The filter prevents noise and caller ID problems caused by DSL interference. Please contact your DSL service provider for more information about DSL filters.

My telephone does not receive caller ID when on a call.

- Make sure you subscribe to caller ID with call waiting features provided by your telephone service provider. Caller ID features work only if both you and the caller are in areas offering caller ID service, and if both telephone service providers use compatible equipment.

A icon shows on the display and I don't know why.

- Your telephone has voicemail indication that is separate from the built-in answering system. If  appears on the display, then your telephone has received a signal from your telephone service provider that you have a voicemail message waiting for you to retrieve from your telephone service provider. Contact your telephone service provider for more information on how to access your voicemail.

I cannot retrieve voicemail messages.

- Your telephone has both a built-in answering system and voicemail indication. They are independent features and each alerts you to new messages differently (see **Answering system and voicemail indicators** on page 56). If you subscribe to voicemail service from your telephone service provider (charges may apply), contact your telephone service provider for more information on how to access your voicemail.

Troubleshooting

Incomplete messages.

- If a caller leaves a very long message, part of it may be lost when the system disconnects the call after the maximum recording time you have set (see **Message alert tone** on page 54).
- If the caller pauses for longer than 7 seconds, the answering system stops recording and disconnects the call.
- If the answering system's memory becomes full during a message, the answering system stops recording and disconnects the call.
- If the caller's voice is very soft, the answering system may stop recording and disconnects the call.
- If someone picks up the call at a telephone on the same line during a message, the answering system stops recording and disconnects the call. Part of the message may be lost.

Difficulty hearing messages.

- Press **▼/▲/-VOLUME+** to adjust the speaker volume on the telephone base.
- Press **▲DIR/VOLUME** to increase the message playback volume on a handset.

The answering system does not answer after correct number of rings.

- Make sure the answering system is on. When the answering system is on, **ANS ON** should show on the handset and the **📞/ANS. ON/OFF** light is lit on the telephone base (see **Answer on/off** on page 50).
- If toll saver is selected, the number of rings changes to 2 when there are new messages (see **Number of rings** on 52).
- If the memory is full or the answering system is off, the answering system answers after 10 rings.
- In some cases, the answering system is affected by the ringing system used by the telephone service provider.
- If you subscribe to voicemail service, change the number of rings so that your answering system answers before your voicemail (see **Answering system and voicemail indicators** on page 56). To determine how many rings activate your voicemail, contact your telephone service provider.
- If there is a fax machine connected to the same telephone line, try disconnecting the fax machine. If that solves the problem, consult your fax machine documentation for information on compatibility with answering systems.

Troubleshooting

The answering system announces “Time and date not set.”

- You need to reset the date and time (see **Set date/time** on page 16).

The answering system does not respond to the remote commands.

- Make sure to enter your remote access code correctly (see **Remote access code** on page 53).
- Make sure you are calling from a touch-tone telephone. When you dial a number, you should hear tones. If you hear clicks, the telephone is not a touch-tone telephone and cannot activate the answering system.
- The answering system may not detect the remote access code while your announcement is playing. Try waiting until the announcement is over before entering the code.
- There may be interference on the telephone line you are using. Press dialing keys firmly.

The answering system does not record messages.

- Make sure the answering system is on (see **Answer on/off** on page 50).
- Make sure the memory of the answering system is not full. When the answering machine memory is full, it does not record new messages until some old messages are deleted.
- If you subscribe to voicemail service, change the number of rings so that your answering system answers before your voicemail (see **Answering system and voicemail indicators** on page 56). To determine how many rings activate your voicemail, contact your telephone service provider.
- If there is a fax machine connected to the same telephone line, try disconnecting the fax machine. If that solves the problem, consult your fax machine documentation for information on compatibility with answering systems.

Announcement is not clear.

- When you record your announcement, make sure you speak in a normal tone of voice, toward the microphone on the handset.
- Make sure there is no background noise (TV, music, etc.) while recording.

Troubleshooting

I subscribe to a nontraditional telephone service that uses my computer to establish connections, and my telephone doesn't work.

- Make sure your computer is powered on.
- Make sure your Internet connection is working properly.
- Make sure that the software is installed and running for your nontraditional telephone service.
- Make sure to plug your USB port adapter into a dedicated USB port on your computer. Do not plug into a multiple port USB hub (USB splitter) that is not powered.
- In a few rare instances, the USB port on your computer may not have enough power. In these instances, try using a USB hub with its own external power supply.
- If you are using a firewall, it may prevent access to your nontraditional telephone service. Contact your service provider for more information.

I've set my LCD language to Spanish or French and I don't know how to change it back to English.

- Press **MENU/SELECT** in idle mode. Enter ***364#** using the dialing keys. You hear a confirmation tone.

Common cure for electronic equipment:

If the telephone is not responding normally, try resetting the telephone. Do the following in the order listed.

1. Disconnect the power to the telephone base.
2. Disconnect the cordless handset battery, and spare battery, if applicable.
3. Wait a few minutes.
4. Connect power to the telephone base.
5. Completely remove and then replace the battery. Place the cordless handset into the telephone base.
6. Wait for the cordless handset to reestablish its connection with the telephone base. Allow up to one minute for this to take place.

Maintenance

Taking care of your telephone

- Your cordless telephone contains sophisticated electronic parts, so it must be treated with care.
- Avoid rough treatment.
- Place the handset down gently.
- Save the original packing materials to protect your telephone if you ever need to ship it.

Avoid water

- Your telephone can be damaged if it gets wet. Do not use the handset in the rain, or handle it with wet hands. Do not install the telephone base near a sink, bathtub or shower.

Electrical storms

- Electrical storms can sometimes cause power surges harmful to electronic equipment. For your own safety, take caution when using electric appliances during storms.

Cleaning your telephone

- Your telephone has durable plastic casing that should retain its luster for many years. Clean it only with a soft cloth slightly dampened with water or mild soap.
- Do not use excess water or cleaning solvents of any kind.

Remember that electrical appliances can cause serious injury if used when you are wet or standing in water. If the telephone base should fall into water, DO NOT RETRIEVE IT UNTIL YOU UNPLUG THE POWER CORD AND TELEPHONE LINE CORDS FROM THE WALL. Pull the telephone out by the unplugged cords.

Important safety information



This symbol is to alert you to important operating or servicing instructions that may appear in this user's manual. Always follow basic safety precautions when using this product to reduce the risk of injury, fire, or electric shock.

Safety information

- **Read and understand all instructions in the user's manual. Observe all markings on the product.**
- **Avoid using a telephone during a thunderstorm.** There might be a slight chance of electric shock from lightning.
- **Do not use a telephone in the vicinity of a gas leak.** Under certain circumstances, a spark may be created when the adapter is plugged into the power outlet, or when the handset is replaced in its cradle. This is a common event associated with the closing of any electrical circuit. The user should not plug the phone into a power outlet, and should not put a charged handset into the cradle, if the phone is located in an environment containing concentrations of flammable or flame-supporting gases, unless there is adequate ventilation. A spark in such an environment could create a fire or explosion. Such environments might include: medical use of oxygen without adequate ventilation; industrial gases (cleaning solvents; gasoline vapors; etc.); a leak of natural gas; etc.
- **Do not use this product near water, or when you are wet.** For example, do not use it in a wet basement or shower, or next to a swimming pool, bathtub, kitchen sink, or laundry tub. Do not use liquids or aerosol sprays for cleaning. If the product comes in contact with any liquids, unplug any line or power cord immediately. Do not plug the product back in until it has dried thoroughly.
- **Install this product in a protected location** where no one can trip over any line or power cords. Protect cords from damage or abrasion.
- **If this product does not operate normally, read Troubleshooting on pages 73-82 in this user's manual.** If you cannot solve the problem, or if the product is damaged, refer to **Limited warranty** on pages 90-92. Do not open this product except as may be directed in your user's manual. Opening the product or reassembling it incorrectly may expose you to hazardous voltages or other risks.
- **Replace batteries only as described in Battery installation and charging on pages 7-8 in your user's manual.** Do not burn or puncture batteries — they contain caustic chemicals.
- **The power adapters are intended to be correctly oriented in a vertical or floor mount position.** The prongs are not designed to hold the plug in place if they are plugged into a ceiling or an under-the-table or cabinet outlet.



CAUTION: Use only the power adapters provided with this product. To obtain a replacement, visit our website at www.telephones.att.com, or call **1 (800) 222-3111**. In Canada, dial **1 (866) 288-4268**.

Important safety information

Especially about cordless telephones

- **Privacy:** The same features that make a cordless telephone convenient create some limitations. Telephone calls are transmitted between the telephone base and the handset by radio waves, so there is a possibility that your cordless telephone conversations could be intercepted by radio receiving equipment within range of the cordless handset. **For this reason, you should not think of cordless telephone conversations as being as private as those on corded telephones.**
- **Electrical power:** The telephone base of this cordless telephone must be connected to a working electrical outlet which is not controlled by a wall switch. **Calls cannot be made from the handset if the telephone base is unplugged, switched off or if the electrical power is interrupted.**
- **Potential TV interference:** Some cordless telephones operate at frequencies that may cause interference to TVs and VCRs. To minimize or prevent such interference, do not place the telephone base of the cordless telephone near or on top of a TV or VCR. If interference is experienced, moving the cordless telephone farther away from the TV or VCR will often reduce or eliminate the interference.
- **Rechargeable batteries:** This product contains nickel-metal hydride rechargeable batteries. Exercise care in handling batteries in order not to create a short circuit with conductive material such as rings, bracelets, and keys. The battery or conductor may overheat and cause harm. Observe proper polarity between the battery and the battery charger.
- **Nickel-metal hydride rechargeable batteries:** Dispose of these batteries in a safe manner. Do not burn or puncture. Like other batteries of this type, if burned or punctured, they could release caustic material which could cause injury.



The RBRC™ Seal means that the manufacturer is voluntarily participating in an industry program to collect and recycle nickel-metal hydride rechargeable batteries when taken out of service within the United States. These batteries may be taken to a participating local retailer of replacement batteries or recycling center. Or you may call 1 (800) 8-BATTERY for locations accepting spent Ni-MH batteries.

Important safety information

Precautions for users of implanted cardiac pacemakers

Cardiac pacemakers (applies only to digital cordless telephones): Wireless Technology Research, LLC (WTR), an independent research entity, led a multidisciplinary evaluation of the interference between portable wireless telephones and implanted cardiac pacemakers. Supported by the U.S. Food and Drug Administration, WTR recommends to physicians that:

Pacemaker patients

- Should keep wireless telephones at least six inches from the pacemaker.
- Should NOT place wireless telephones directly over the pacemaker, such as in a breast pocket, when it is turned ON.
- Should use the wireless telephone at the ear opposite the pacemaker.

WTR's evaluation did not identify any risk to bystanders with pacemakers from other persons using wireless telephones.

ECO mode

This power conserving technology reduces power consumption for optimal battery performance. The ECO mode activates automatically whenever the handset is synchronized with the telephone base.

Especially about telephone answering systems

Two-way recording: This unit does not sound warning beeps to inform the other party that the call is being recorded. To ensure that you are in compliance with any federal or state regulations regarding recording a telephone call, you should start the recording process and then inform the other party that you are recording the conversation.

SAVE THESE INSTRUCTIONS

Appendix

FCC Part 68 and ACTA

This equipment complies with Part 68 of the FCC rules and with technical requirements adopted by the Administrative Council for Terminal Attachments (ACTA). The label on the back or bottom of this equipment contains, among other things, a product identifier in the format US: AAAEQ##TXXXX. This identifier must be provided to your telephone service provider upon request.

The plug and jack used to connect this equipment to premises wiring and the telephone network must comply with the applicable Part 68 rules and technical requirements adopted by ACTA. A compliant telephone cord and modular plug is provided with this product. It is designed to be connected to a compatible modular jack that is also compliant. An RJ11 jack should normally be used for connecting to a single line and an RJ14 jack for two lines. See Installation Instructions in the user's manual.

The Ringer Equivalence Number (REN) is used to determine how many devices you may connect to your telephone line and still have them ring when you are called. The REN for this product is encoded as the 6th and 7th characters following the US: in the product identifier (e.g., if ## is 03, the REN is 0.3). In most, but not all areas, the sum of all RENs should be five (5.0) or less. For more information, please contact your telephone service provider.

This equipment may not be used with Party Lines. If you have specially wired alarm dialing equipment connected to your telephone line, ensure the connection of this equipment does not disable your alarm equipment. If you have questions about what will disable the alarm equipment, consult your telephone service provider or a qualified installer.

If this equipment is malfunctioning, it must be unplugged from the modular jack until the problem has been corrected. Repairs to this telephone equipment can only be made by the manufacturer or its authorized agents. For repair procedures, follow the instructions outlined under the Limited Warranty.

If this equipment is causing harm to the telephone network, the telephone service provider may temporarily discontinue your telephone service. The telephone service provider is required to notify you before interrupting service. If advance notice is not practical, you will be notified as soon as possible. You will be given the opportunity to correct the problem and the telephone service provider is required to inform you of your right to file a complaint with the FCC. Your telephone service provider may make changes in its facilities, equipment, operation, or procedures that could affect the proper functioning of this product. The telephone service provider is required to notify you if such changes are planned.

If this product is equipped with a corded or cordless handset, it is hearing aid compatible.

If this product has memory dialing locations, you may choose to store emergency telephone numbers (e.g., police, fire, medical) in these locations. If you do store or test emergency numbers, please:

- Remain on the line and briefly explain the reason for the call before hanging up.
- Perform such activities in off-peak hours, such as early morning or late evening.

Appendix

FCC Part 68 and ACTA

Industry Canada

This device complies with Industry Canada license-exempt RSS standard(s).

Operation is subject to the following two conditions: (1) this device may not cause harmful interference, and (2) this device must accept any interference received, including interference that may cause undesired operation.

Privacy of communications may not be ensured when using this telephone.

The term "IC:" before the certification/registration number only signifies that the Industry Canada technical specifications were met.

The Ringer Equivalence Number (REN) for this terminal equipment is 1.0. The REN is an indication of the maximum number of devices allowed to be connected to a telephone interface. The termination on an interface may consist of any combination of devices subject only to the requirement that the sum of the RENs of all the devices does not exceed five.

This product meets the applicable Industry Canada technical specifications.

FCC Part 15

This equipment has been tested and found to comply with the requirements for a Class B digital device under Part 15 of the Federal Communications Commission (FCC) rules.

These requirements are intended to provide reasonable protection against harmful interference in a residential installation. This equipment generates, uses and can radiate radio frequency energy and, if not installed and used in accordance with the instructions, may cause harmful interference to radio communications. However, there is no guarantee that interference will not occur in a particular installation.

If this equipment does cause harmful interference to radio or television reception, which can be determined by turning the equipment off and on, the user is encouraged to try to correct the interference by one or more of the following measures:

- Reorient or relocate the receiving antenna.
- Increase the separation between the equipment and receiver.
- Connect the equipment into an outlet on a circuit different from that to which the receiver is connected.
- Consult the dealer or an experienced radio/TV technician for help.

Changes or modifications to this equipment not expressly approved by the party responsible for compliance could void the user's authority to operate the equipment.

This device complies with Part 15 of the FCC rules. Operation is subject to the following two conditions: (1) this device may not cause harmful interference, and (2) this device must accept any interference received, including interference that may cause undesired operation. Privacy of communications may not be ensured when using this telephone.

To ensure safety of users, the FCC has established criteria for the amount of radio frequency energy that can be safely absorbed by a user or bystander according to the intended usage of the product. This product has been tested and found to comply with the FCC criteria. The handset may be safely held against the ear of the user. The telephone base shall be installed and used such that parts of the user's body other than the hands are maintained at a distance of approximately 20cm (8 inches) or more.

This Class B digital apparatus complies with Canadian requirement:



CAN ICES-3 (B)/NMB-3(B)

Appendix

California Energy Commission battery charging testing instructions

This telephone is set up to comply with the energy-conserving standards right out of the box. These instructions are intended for California Energy Commission (CEC) compliance testing only. When the CEC battery charging testing mode is activated, all telephone functions, except battery charging, will be disabled.

To activate the CEC battery charging testing mode:

1. Unplug the telephone base power adapter from the power outlet. Make sure all handsets are plugged with charged batteries before proceeding.
2. While you press and hold /HANDSET LOCATOR, plug the telephone base power adapter back to the power outlet.
3. After about 20 seconds, when the **IN USE** light starts flashing, release /HANDSET LOCATOR and then press it again within two seconds.



When the phone successfully enters the CEC battery charging testing mode, the **IN USE** light turns off and all handsets display **To register HS...** and **...see manual**, alternately.

When the phone fails to enter this mode, repeat all the steps mentioned above.

To deactivate the CEC battery charging testing mode:

1. Unplug the telephone base power adapter from the power outlet, then plug it back in. The telephone base is powered up as normal.
2. Register your handsets back to the telephone base. See page 67 for handset registration instructions.



Appendix

Limited warranty

The AT&T brand is used under license - any repair, replacement or warranty service, and all questions about this product should be directed to our website at

www.telephones.att.com or call **1 (800) 222-3111**. In Canada, dial **1 (866) 288-4268**.

1. What does this limited warranty cover?

The manufacturer of this AT&T branded product warrants to the holder of a valid proof of purchase ("CONSUMER" or "you") that the product and all accessories provided in the sales package ("PRODUCT") are free from defects in material and workmanship, pursuant to the following terms and conditions, when installed and used normally and in accordance with the PRODUCT operating instructions. This limited warranty extends only to the CONSUMER for products purchased and used in the United States of America and Canada.

2. What will be done if the PRODUCT is not free from defects in materials and workmanship during the limited warranty period ("materially defective PRODUCT")?

During the limited warranty period, the manufacturer's authorized service representative repairs or replaces at the manufacturer's option, without charge, a materially defective PRODUCT. If the manufacturer repairs the PRODUCT, they may use new or refurbished replacement parts. If the manufacturer chooses to replace the PRODUCT, they may replace it with a new or refurbished PRODUCT of the same or similar design. The manufacturer retains the defective parts, modules, or equipment. Repair or replacement of the PRODUCT, at the manufacturer's option, is your exclusive remedy. The manufacturer returns the repaired or replacement products to you in working condition. You should expect the repair or replacement to take approximately 30 days.

3. How long is the limited warranty period?

The limited warranty period for the PRODUCT extends for ONE (1) YEAR from the date of purchase. If the manufacturer repairs or replaces a materially defective PRODUCT under the terms of this limited warranty, this limited warranty also applies to repaired or replacement PRODUCT for a period of either (a) 90 days from the date the repaired or replacement PRODUCT is shipped to you or (b) the time remaining on the original one-year limited warranty; whichever is longer.

Limited warranty

4. What is not covered by this limited warranty?

This limited warranty does not cover:

- PRODUCT that has been subjected to misuse, accident, shipping or other physical damage, improper installation, abnormal operation or handling, neglect, inundation, fire, water, or other liquid intrusion; or
- PRODUCT that has been damaged due to repair, alteration, or modification by anyone other than an authorized service representative of the manufacturer; or
- PRODUCT to the extent that the problem experienced is caused by signal conditions, network reliability or cable or antenna systems; or
- PRODUCT to the extent that the problem is caused by use with non-AT&T accessories; or
- PRODUCT whose warranty/quality stickers, PRODUCT serial number plates or electronic serial numbers have been removed, altered or rendered illegible; or
- PRODUCT purchased, used, serviced, or shipped for repair from outside the United States of America or Canada, or used for commercial or institutional purposes (including but not limited to products used for rental purposes); or
- PRODUCT returned without a valid proof of purchase (see item 6); or
- Charges for installation or setup, adjustment of customer controls, and installation or repair of systems outside the unit.

5. How do you get warranty service?

To obtain warranty service in the United States of America, visit

www.telephones.att.com or call **1 (800) 222-3111**. In Canada, dial **1 (866) 288-4268**.

NOTE: Before calling for service, please review the user's manual. A check of the PRODUCT's controls and features might save you a service call.

Except as provided by applicable law, you assume the risk of loss or damage during transit and transportation and are responsible for delivery or handling charges incurred in the transport of the PRODUCT(s) to the service location. The manufacturer will return repaired or replaced PRODUCT under this limited warranty. Transportation, delivery or handling charges are prepaid. The manufacturer assumes no risk for damage or loss of the PRODUCT in transit. If the PRODUCT failure is not covered by this limited warranty, or proof of purchase does not meet the terms of this limited warranty, the manufacturer notifies you and requests that you authorize the cost of repair prior to any further repair activity. You must pay for the cost of repair and return shipping costs for the repair of products that are not covered by this limited warranty.

Appendix

Limited warranty

6. What must you return with the PRODUCT to get warranty service?

You must:

- a. Return the entire original package and contents including the PRODUCT to the service location along with a description of the malfunction or difficulty; and
- b. Include a "valid proof of purchase" (sales receipt) identifying the PRODUCT purchased (PRODUCT model) and the date of purchase or receipt; and
- c. Provide your name, complete and correct mailing address, and telephone number.

7. Other limitations

This warranty is the complete and exclusive agreement between you and the manufacturer of this AT&T branded PRODUCT. It supersedes all other written or oral communications related to this PRODUCT. The manufacturer provides no other warranties for this PRODUCT. The warranty exclusively describes all of the manufacturer's responsibilities regarding the PRODUCT. There are no other express warranties. No one is authorized to make modifications to this limited warranty and you should not rely on any such modification.

State/Provincial Law Rights: This warranty gives you specific legal rights, and you might also have other rights that vary from state to state or province to province.

Limitations: Implied warranties, including those of fitness for a particular purpose and merchantability (an unwritten warranty that the PRODUCT is fit for ordinary use) are limited to one year from date of purchase. Some states/provinces do not allow limitations on how long an implied warranty lasts, so the above limitation might not apply to you. In no event shall the manufacturer be liable for any indirect, special, incidental, consequential, or similar damages (including, but not limited to lost profits or revenue, inability to use the PRODUCT or other associated equipment, the cost of substitute equipment, and claims by third parties) resulting from the use of this PRODUCT. Some states/provinces do not allow the exclusion or limitation of incidental or consequential damages, so the above limitation or exclusion might not apply to you.

Please retain your original sales receipt as proof of purchase.

Appendix

Technical specifications

RF frequency band	1921.536MHz — 1928.448MHz
Channels	5
Operating temperature	32°F — 122°F 0°C — 50°C
Telephone base voltage (AC voltage, 60Hz)	96 — 130Vrms
Telephone base voltage (DC adapter output)	DC6V @ 400mA
Handset voltage	2.4VDC — 3.2VDC
Charger voltage (AC adapter output)	DC6V @ 400mA
Operating times*	Talk time (handset): up to 7 hours Talk time (speakerphone): up to 3.5 hours Standby: up to 5 days

*Operating time varies depending on your actual use and the age of battery.

DECT 6.0 digital technology

Digitally Enhanced Cordless Telecommunications (DECT) 6.0 is a new frequency band that transmits your voice across multiple channels. This technology provides superior quality of voice and sound, high protection against wiretapping and better range than 2.4GHz and 5.8GHz phone systems, while not interfering with wireless routers.

Telephone operating range

This cordless telephone operates within the maximum power allowed by the Federal Communications Commission (FCC). Even so, this handset and telephone base can communicate over a certain distance — which can vary with the locations of the telephone base and handset, the weather, and the construction of your home or office.

Simulated full-duplex handset speakerphone

The simulated full-duplex speakerphone on your handset allows both ends of a call to speak and be heard at the same time. Optimal performance is subject to external factors and individual usage.

Index
Index

A

Alert tones, 70
Alphabetical search, 35
Announcement, 48
Answer a call, 21
Answer an incoming call during an intercom call, 28
Answering mode, 50
Answering system, 48–66
Area code, 17, 41

B

Base ringer volume (ringer volume control), 19
Base volume control, 19
Battery charging, 8
Battery installation, 7

C

Call intercept, 59
Call screening, 51
Call transfer (intercom transfer), 29
Call waiting, 24, 41
Caller ID, 41
Caller ID log (call log), 41–46
Chain dialing, 25
Character chart, 32
Clock, 16

D

Date and time, 16
Delete all caller ID log, 45
Delete messages, 62
Dial a number from caller ID log, 45
Dial a speed dial number, 40
Dialing options, 44
Dial mode, 17
Directory, 30–34

Directory storage, 30
DSL filter, 1

E

Elapsed time, 20
End a call, 21

F

Flash, 24

H

Handset locator, 27
Handset ringer tone (selectable ringer tone), 13
Handset ringer volume (ringer volume control), 13

I

Important safety information, 84–86
Intercom call (intercom between handsets), 28

K

Key tone, 16

L

LCD language, 14
Limited warranty, 90–92

M

Maintenance, 83
Making a call, 20
Memo, 63
Memory match, 42
Menu, 12
Message playback, 60–62
Message window displays, 64
Missed (new) calls indicator, 43
Mute, 24

Index
Index

N

Number of rings, 52

P

Pause, 20

Predialing (on-hook dialing), 20

R

Reasons for missing caller ID
information, 47

Recording time, 55

Redial, 22–23

Remote access, 65

Remote access code, 53

Remote commands, 65

Repeat messages, 61, 65

Ringer tone, 13

S

Screen icons, 69

Skip messages, 61

Speakerphone switching, 21

Speed dial, 38–40

T

Tabletop installation, 11

Technical specifications, 93

Temporary ringer silencing, 20

Temporary tone dialing, 25

Troubleshooting, 73–82

V

Voicemail, 14

Voice prompts, 57

Volume, 13, 19, 24

W

Wall-mount installation, 9

Remote access wallet card

The wallet card below lists the commands needed to control your answering system from any touch-tone telephone.

Cut along dotted line.



Call your telephone number, then enter your 2-digit remote access code (preset to **19**).

Action	Remote command
Play all messages	1
Play new messages.....	2
Delete the message.....	3 (during message playback)
Delete all old messages	33
Repeat or go back.....	4
Stop.....	5
Help menu	*5
Skip the message.....	6
Record announcement	*7
Turn system on or off	0
End remote access call.....	8 (or hang up)

AWX22104 DECT 6.0 cordless telephone/answering system with caller ID/call waiting

© 2014 Advanced American Telephones. All Rights Reserved. AT&T and the AT&T logo are trademarks of AT&T Intellectual Property licensed to Advanced American Telephones, San Antonio, TX 78219. Printed in China.

Fold here.



www.telephones.att.com

© 2014 Advanced American Telephones. All Rights Reserved.
AT&T and the AT&T logo are trademarks of AT&T Intellectual Property licensed to
Advanced American Telephones, San Antonio, TX 78219.
Printed in China. Issue 1.0 AT&T 07/14.