

Issuing Laboratory:
Intertek Testing Services Hong Kong Limited

Hong Kong Accreditation Service (HKAS) has accredited this laboratory under the Hong Kong Laboratory Accreditation Scheme (HOKLAS) for specific laboratory activities as listed in the HOKLAS directory of accredited laboratories. The results shown in this report were determined by this laboratory in accordance with its terms of accreditation.



TEST REPORT

Report Number: 13100669HKG-001

Application
For
Original Grant of 47 CFR Part 15 Certification
Single New of RSS-213 Issue 2 Equipment Certification

Unlicensed Personal Communication Service Devices/
2 GHz License-exempt Personal Communications Service Devices

FCC ID: EW780-9496-00

**IC: 1135B-80949600
(Pendant)**

Prepared and Checked by:

Approved by:

A handwritten signature in black ink, appearing to read 'Benny Lau', written over a horizontal line.

Lau Chin Yu, Benny
Lead Engineer

A handwritten signature in black ink, appearing to read 'Melvin Nip', written over a horizontal line.

Nip Ming Fung, Melvin
Assistant Manager
November 26, 2013

- The test report only allows to be revised within the retention period unless further standard or the requirement was noticed.
- This report is for the exclusive use of Intertek's Client and is provided pursuant to the agreement between Intertek and its Client. Intertek's responsibility and liability are limited to the terms and conditions of the agreement. Intertek assumes no liability to any party, other than to the Client in accordance with the agreement, for any loss, expense or damage occasioned by the use of this report. Only the Client is authorized to permit copying or distribution of this report and then only in its entirety. Any use of the Intertek name or one of its marks for the sale or advertisement of the tested material, product or service must first be approved in writing by Intertek. The observations and test results in this report are relevant only to the sample tested. This report by itself does not imply that the material, product, or service is or has ever been under an Intertek certification program.

Intertek Testing Services Hong Kong Ltd.

2/F., Garment Centre, 576 Castle Peak Road, Kowloon, Hong Kong.
Tel: (852) 2173 8888 Fax: (852) 2785 5487 Website: www.hk.intertek-etlsemko.com

Issuing Laboratory:
Intertek Testing Services Hong Kong Limited

Hong Kong Accreditation Service (HKAS) has accredited this laboratory under the Hong Kong Laboratory Accreditation Scheme (HOKLAS) for specific laboratory activities as listed in the HOKLAS directory of accredited laboratories. The results shown in this report were determined by this laboratory in accordance with its terms of accreditation.



GENERAL INFORMATION

VTech Telecommunications Ltd.:	VTech Telecommunications Ltd.
Applicant Address:	23/F, Tai Ping Industrial Centre, Block 1, 57 Ting Kok Road, Tai Po, Hong Kong.
FCC Specification Standard:	FCC Part 15, October 1, 2012 Edition
FCC ID:	EW780-9496-00
FCC Model(s):	OOMA-HWSP01
IC Specification Standard:	RSS-213 Issue 2, December 2005 RSS-Gen Issue 3, December 2010
IC:	1135B-80949600
IC Model(s):	OOMA-HWSP01
Type of EUT:	Unlicensed Personal Communications Service Devices
Description of EUT:	1.9GHz Digital Modulation Cordless Speaker
Serial Number:	N/A
Sample Receipt Date:	September 30, 2013
Date of Test:	October 28, 2013 to November 1, 2013
Report Date:	November 26, 2013
Environmental Conditions:	Temperature: +10 to 40°C Humidity: 10 to 90%

Table of Contents

1.0 Test Results Summary & Statement of Compliance	5
1.1 Summary of Test Results	5
1.2 Statement of Compliance	6
2.0 General Description	8
2.1 Product Description	8
2.2 Technical Description	8
2.3 Test Methodology	8
2.4 Test Facility	8
3.0 System Test Configuration	10
3.1 Justification	10
3.2 Conducted Emission Test Configuration	11
3.3 Conducted Monitoring and Operational Test Configuration	11
3.4 EUT Exercising Software.....	11
3.5 Details of EUT and Description of Accessories	12
3.6 Measurement Uncertainty	12
4.0 Measurement Results	14
4.1 Antenna Requirement	14
4.2 Digital Modulation Techniques.....	14
4.3 Emission Bandwidth	15
4.4 Directional Gain of the Antenna	18
4.5 Peak Transmit Power	19
4.6 Power Spectral Density	22
4.7 Automatic Discontinuation of Transmission.....	25
4.8 Unwanted Emission Inside the Sub-Band	26
4.9 Emissions Outside the Sub-Band	30
4.9.1 Radiated Emissions Configuration Photographs	31
4.9.2 Radiated Emissions Data	31
4.9.3 Field Strength Calculation.....	37
4.9.4 Average Factor Calculation and Transmitter ON Time Measurements	38
4.10 AC Power Line Conducted Emissions	39
4.10.1 AC Power Line Conducted Emissions Configuration Photographs	40
4.10.2 AC Power Line Conducted Emissions Data	40
4.11 Frame Repetition Stability	44
4.12 Frame Period and Jitter	45
4.13 Carrier Frequency Stability	46
4.14 Monitoring Threshold.....	47
4.14.1 Lower Monitoring Threshold	48
4.14.2 Least Interfered Channel	49
4.14.2.1 Upper Monitoring Threshold	49
4.14.2.2 Least Interfered Channel (LIC) Selection	50
4.14.2.3 Least Interfered Channel (LIC) Confirmation.....	52

Issuing Laboratory:
Intertek Testing Services Hong Kong Limited

Hong Kong Accreditation Service (HKAS) has accredited this laboratory under the Hong Kong Laboratory Accreditation Scheme (HOKLAS) for specific laboratory activities as listed in the HOKLAS directory of accredited laboratories. The results shown in this report were determined by this laboratory in accordance with its terms of accreditation.



Table of Contents

4.14.2.4 Maximum Spectrum Occupance	52
4.15 Monitoring Time.....	53
4.16 Maximum Transmit Period.....	54
4.17 System Acknowledgement	55
4.18 Random Waiting.....	56
4.19 Monitoring Bandwidth	57
4.20 Maximum Reaction Time.....	58
4.21 Monitoring Antenna	58
4.22 Duplex Connections	59
4.23 Alternative Monitoring Interval for Co-located Device.....	61
4.24 Fair Access.....	61
5.0 Equipment List	63

Issuing Laboratory:
Intertek Testing Services Hong Kong Limited

Hong Kong Accreditation Service (HKAS) has accredited this laboratory under the Hong Kong Laboratory Accreditation Scheme (HOKLAS) for specific laboratory activities as listed in the HOKLAS directory of accredited laboratories. The results shown in this report were determined by this laboratory in accordance with its terms of accreditation.



EXHIBIT 1
TEST RESULTS SUMMARY & STATEMENT OF COMPLIANCE

Issuing Laboratory:
Intertek Testing Services Hong Kong Limited

Hong Kong Accreditation Service (HKAS) has accredited this laboratory under the Hong Kong Laboratory Accreditation Scheme (HOKLAS) for specific laboratory activities as listed in the HOKLAS directory of accredited laboratories. The results shown in this report were determined by this laboratory in accordance with its terms of accreditation.



1.0 **Test Results Summary & Statement of Compliance**

1.1 Summary of Test Results

General Technical Requirements					
Test Items	RSS-213 / RSS-Gen[#] Clause	FCC Part 15 Section	Test Procedure ANSI C63.17 / ANSI C63.4[*]	Results	Details see section
Antenna Requirement	7.1.2 [#]	15.317	---	Pass	4.1
Digital Modulation Techniques	6.1	15.319(b)	6.1.4	Pass	4.2
Occupied/Emission Bandwidth	6.4	15.323(a)	6.1.3	Pass	4.3
Directional Gain of the Antenna	4.1(e)	15.319(e)	4.3.1	Pass	4.4
Peak Transmit Power	6.5	15.319(c)	6.1.2	Pass	4.5
Power Spectral Density	6.6	15.319(d)	6.1.5	Pass	4.6
Automatic Discontinuation of Transmission	4.3.4(a)	15.319(f)	---	Pass	4.7
AC Power Line Conducted Emissions from EUT	6.3	15.315	7 [*]	Pass	4.10
Security Code Information	5	---	---	Pass	2.2

1.1 Summary of Test Results (continued)

Specific Requirements for UPCS Device					
Test Items	RSS-213 Clause	FCC Part 15 Section	Test Procedure ANSI C63.17	Results	Details see section
Unwanted Emission Inside the Sub-Band	6.7.2	15.323(d)	6.1.6.1	Pass	4.8
Emissions Outside the Sub-Band	6.7.1	15.323(d)	6.1.6.2	Pass	4.9
Frame Repetition Stability	4.3.4(c)	15.323(e)	6.2.2	Pass	4.11
Frame Period and Jitter	4.3.4(c)	15.323(e)	6.2.3	Pass	4.12
Carrier Frequency Stability	6.2	15.323(f)	6.2.1	Pass	4.13
Lower Monitoring Threshold	4.3.4(b2&b9)	15.323(c2&c9)	7.3.1	NA	4.14.1
Upper Monitoring Threshold	4.3.4(c5&c9)	15.323(c5.1&c9)	7.3.2	Pass	4.14.2.1
Least Interfered Channel (LIC) Selection	4.3.4(b5)	15.323(c)(5)	7.3.3	Pass	4.14.2.2
Least Interfered Channel (LIC) Confirmation	4.3.4(b5)	15.323(c)(5)	7.3.3	Pass	4.14.2.3
Maximum Spectrum Occupancy	4.3.4(b5)	15.323(c)(5)	---	Pass	4.14.2.4
Monitoring Time	4.3.4(b1)	15.323(c)(1)	7.3.4	Pass	4.15
Maximum Transmit Period	4.3.4(b3)	15.323(c)(3)	---	Pass	4.16
System Acknowledgement	4.3.4(b4)	15.323(c4)	8.1 or 8.2	Pass	4.17
Random Waiting	4.3.4(b6)	15.323(c)(6)	8.1.2 or 8.1.3	NA	4.18
Monitoring Bandwidth	4.3.4(b7)	15.323(c)(7)	7.4	Pass	4.19
Maximum Reaction Time	4.3.4(b7)	15.323(c)(7)	7.5	Pass	4.20
Monitoring Antenna	4.3.4(b8)	15.323(c)(8)	4	Pass	4.21
Duplex Connections	4.3.4(b10)	15.323(c)(10)	8.3	Pass	4.22
Alternative Monitoring Interval for Co-located Device	4.3.4(b11)	15.323(c)(11)	8.4	NA	4.23
Fair Access	4.3.4(b12)	15.323(c)(12)	---	Pass	4.24

1.2 Statement of Compliance

The equipment under test is found to be complying with the following standards:

FCC Part 15, October 1, 2012 Edition
RSS-213 Issue 2, December 2005
RSS-Gen Issue 3, December 2010

Issuing Laboratory:
Intertek Testing Services Hong Kong Limited

Hong Kong Accreditation Service (HKAS) has accredited this laboratory under the Hong Kong Laboratory Accreditation Scheme (HOKLAS) for specific laboratory activities as listed in the HOKLAS directory of accredited laboratories. The results shown in this report were determined by this laboratory in accordance with its terms of accreditation.



EXHIBIT 2
GENERAL DESCRIPTION

Issuing Laboratory:
Intertek Testing Services Hong Kong Limited

Hong Kong Accreditation Service (HKAS) has accredited this laboratory under the Hong Kong Laboratory Accreditation Scheme (HOKLAS) for specific laboratory activities as listed in the HOKLAS directory of accredited laboratories. The results shown in this report were determined by this laboratory in accordance with its terms of accreditation.



2.0 General Description

2.1 Product Description

The OOMA-HWSP01 is a 1.9GHz Digital Modulation Cordless Speaker. It operates at frequency range of 1921.536MHz to 1928.448MHz with 5 channels (1921.536MHz, 1923.264MHz, 1924.992MHz, 1926.720MHz and 1928.448MHz). The EUT is powered by a "Ni-MH" type rechargeable battery pack (3.7V 450mAh).

The antenna used in speaker is integral, and the test sample is a prototype.

2.2 Technical Description

The circuit description and digital modulation techniques description are saved with filename: descri.pdf.

2.3 Test Methodology

The radiated emission measurements for unintentional radiator (if any) and AC power line-conducted emission measurements were performed according to the test procedures specified in ANSI C63.4 (2009). The radiated emission measurements for intentional radiator contained in UPCS device, conducted emission measurements, Listen Before Transmit (LBT) tests, Time Frame and Frequency Stability tests were performed according to the test procedures specified in ANSI C63.17 (2006). All radiated measurements were performed in Open Area Test Sites. Preliminary scans were performed in the Open Area Test Sites only to determine worst case modes. All radiated tests were performed at an antenna to EUT distance of 3 meters, unless stated otherwise in the "Justification Section" of this Application. All other measurements were made in accordance with the procedures in 47 CFR Part 2 / RSS-Gen Issue 3 (2010).

2.4 Test Facility

The open area test site, AC power line conducted measurement facility and antenna port conducted measurement facility used to collect the radiated data, AC Power Line conducted data, and conductive data are at Rooftop, 2nd Floor and 5th Floor respectively of Intertek Testing Services Hong Kong Ltd., which is located at Garment Centre, 576 Castle Peak Road, Kowloon, Hong Kong. This test facility and site measurement data have been fully placed on file with FCC and Industry Canada.

Issuing Laboratory:
Intertek Testing Services Hong Kong Limited

Hong Kong Accreditation Service (HKAS) has accredited this laboratory under the Hong Kong Laboratory Accreditation Scheme (HOKLAS) for specific laboratory activities as listed in the HOKLAS directory of accredited laboratories. The results shown in this report were determined by this laboratory in accordance with its terms of accreditation.



EXHIBIT 3
SYSTEM TEST CONFIGURATION

3.0 System Test Configuration

3.1 Justification

For emissions testing, the equipment under test (EUT) was set up to transmit continuously in burst mode with pseudo-random data to simplify the measurement methodology. Care was taken to ensure proper power supply voltages during testing. During testing, all cables (if any) were manipulated to produce worst-case emissions.

The EUT was powered by a fully charged battery.

For the measurements, the EUT was attached to a plastic stand if necessary and placed on the wooden turntable. If the EUT is attached to accessories, they were connected and operational (as typical as possible).

The signal was maximized through rotation and placement in the three orthogonal axes. The antenna height and polarization were varied during the search for maximum signal level. The antenna height was varied from 1 to 4 meters. Detector function was in peak mode. Radiated emissions are taken at three meters unless the signal level was too low for measurement at that distance. If necessary, a pre-amplifier was used and/or the test was conducted at a closer distance.

For UPCS transmitter radiated measurement, the spectrum analyzer resolution bandwidth was approximately 1% of EUT emission bandwidth, unless otherwise specified.

Radiated emission measurements for UPCS transmitter were performed from the lowest radio frequency signal generated in the device which is greater than 9 kHz to the tenth harmonic of the highest fundamental frequency or to 40 GHz, whichever is lower.

For AC line conducted emission test, the EUT along with its peripherals were placed on a 1.0m(W)x1.5m(L) and 0.8m in height wooden table and the EUT was adjusted to maintain a 0.4 meter space from a vertical reference plane. The EUT was connected to power mains through a line impedance stabilization network (LISN), which provided 50ohm coupling impedance for measuring instrument. The LISN housing, measuring instrument case, reference ground plane, and vertical ground plane were bounded together. The excess power cable between the EUT and the LISN was bundled.

All connecting cables of EUT and peripherals were manipulated to find the maximum emission.

3.2 Conducted Emission Test Configuration

The setup and equipment setting were made in accordance with ANSI C63.17. The antenna of EUT transmitter was replaced by a coaxial cable. The impedance matching of connection, cable loss and external RF attenuator are taken into account. The EUT was arranged to communicate via a fixed carrier frequency between its transmitter and a companion device. The transmission was configured in burst mode with pseudo-random data as typical as normal operation.

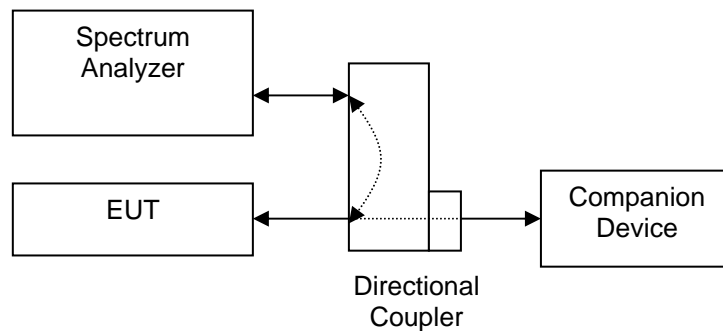

Figure 3.2.1

3.3 Conducted Monitoring and Operation Test Configuration

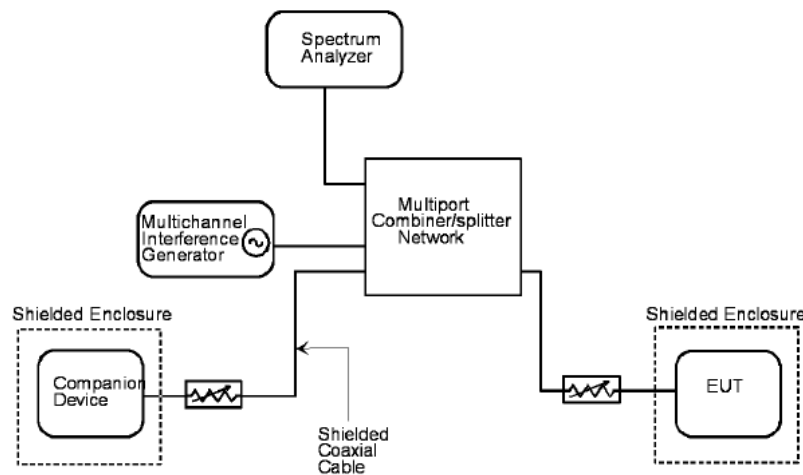

Figure 3.3.1

3.4 EUT Exercising Software

The EUT exercise program (if any) used during radiated and conducted testing was designed to exercise the various system components in a manner similar to a typical use.

Issuing Laboratory:
Intertek Testing Services Hong Kong Limited

Hong Kong Accreditation Service (HKAS) has accredited this laboratory under the Hong Kong Laboratory Accreditation Scheme (HOKLAS) for specific laboratory activities as listed in the HOKLAS directory of accredited laboratories. The results shown in this report were determined by this laboratory in accordance with its terms of accreditation.



3.5 Details of EUT and Description of Accessories

Details of EUT:

A battery (provided with the unit) were used to power the device. Their descriptions are listed below.

- (1) A "Ni-MH" type rechargeable battery (3.7V 450mAh, Model: VT-02, Brand: BYD) (Supplied by Client)

Description of Accessories:

- (1) AC Adaptor for an Extra Charger, 100-120VAC to 6VDC 400mA, Model: S005IU0600040, Brand: Ten Pao (Supplied by Client)
- (2) AC Adaptor for an Extra Charger, 100-120VAC to 6VDC 400mA, Model: CS2A0600040LUF, Brand: Cesc (Supplied by Client)
- (3) Base Unit, Model: CRL32102, FCC ID: EW780-8564-00 (Supplied by Client)
- (4) Telephone Line Simulator, Model: TLS-5D-01, S/N: 115101 (Supplied by Intertek)
- (5) 3m Telephone Line (Supplied by Intertek)

3.6 Measurement Uncertainty

When determining of the test conclusion, the Measurement Uncertainty of test has been considered.

Uncertainty and Compliance - Unless the standard specifically states that measured values are to be extended by the measurement uncertainty in determining compliance, all compliance determinations are based on the actual measured value.

Issuing Laboratory:
Intertek Testing Services Hong Kong Limited

Hong Kong Accreditation Service (HKAS) has accredited this laboratory under the Hong Kong Laboratory Accreditation Scheme (HOKLAS) for specific laboratory activities as listed in the HOKLAS directory of accredited laboratories. The results shown in this report were determined by this laboratory in accordance with its terms of accreditation.



EXHIBIT 4
TEST RESULTS

Issuing Laboratory:
Intertek Testing Services Hong Kong Limited

Hong Kong Accreditation Service (HKAS) has accredited this laboratory under the Hong Kong Laboratory Accreditation Scheme (HOKLAS) for specific laboratory activities as listed in the HOKLAS directory of accredited laboratories. The results shown in this report were determined by this laboratory in accordance with its terms of accreditation.



4.0 Measurement Results

4.1 Antenna Requirement, FCC Rule 15.317 / RSS-Gen Clause 7.1.2:

EUT must meet the antenna requirement of FCC Rule 15.203 / RSS-Gen Clause 7.1.2.

- [×] EUT uses permanently attached antenna(s) which is considered sufficient to comply with the provisions of this rule. Please refer to internal photos.pdf for more details.

- [] EUT uses unique antenna jack(s) or electrical connector(s) which is considered sufficient to comply with the provisions of this rule. Please refer to internal photos.pdf for more details.

4.2 Digital Modulation Techniques, FCC Rule 15.319(b) / RSS-213 Clause 6.1:

All transmissions must use only digital modulation techniques.

The requirements are made in accordance with ANSI C63.17 sub-clause 6.1.4.

Attestation:

Please refer to the technical description(descr.pdf) or relevant DECT standards for more details.

Issuing Laboratory:
Intertek Testing Services Hong Kong Limited

Hong Kong Accreditation Service (HKAS) has accredited this laboratory under the Hong Kong Laboratory Accreditation Scheme (HOKLAS) for specific laboratory activities as listed in the HOKLAS directory of accredited laboratories. The results shown in this report were determined by this laboratory in accordance with its terms of accreditation.



4.3 Emission Bandwidth, FCC Rule 15.323(a) /
Occupied Bandwidth, RSS-213 Clause 6.4:

Operation shall be contained within the 1920 – 1930 MHz band. The emission bandwidth (B) shall be less than 2.5 MHz and greater than 50 kHz.

Measurements are made in accordance with ANSI C63.17 sub-clause 6.1.3 and RSS-Gen clause 4.6.1. Test setup is shown in section 3.2 Figure 3.2.1.

Test Results:

I. Traffic Carrier

Channel	Channel Frequency (MHz)	Measuring Signal Level	Measured Emission Bandwidth (MHz)	Results
Lowest	1921.536	26 dB down	1.50	Pass
Middle	1924.992	99% Bandwidth	1.22	Pass
Highest	1928.448	26 dB down	1.50	Pass

The plots of emission bandwidth and occupied bandwidth are saved as below.

Plots of emission bandwidth (FCC)

Lowest channel, Traffic carrier

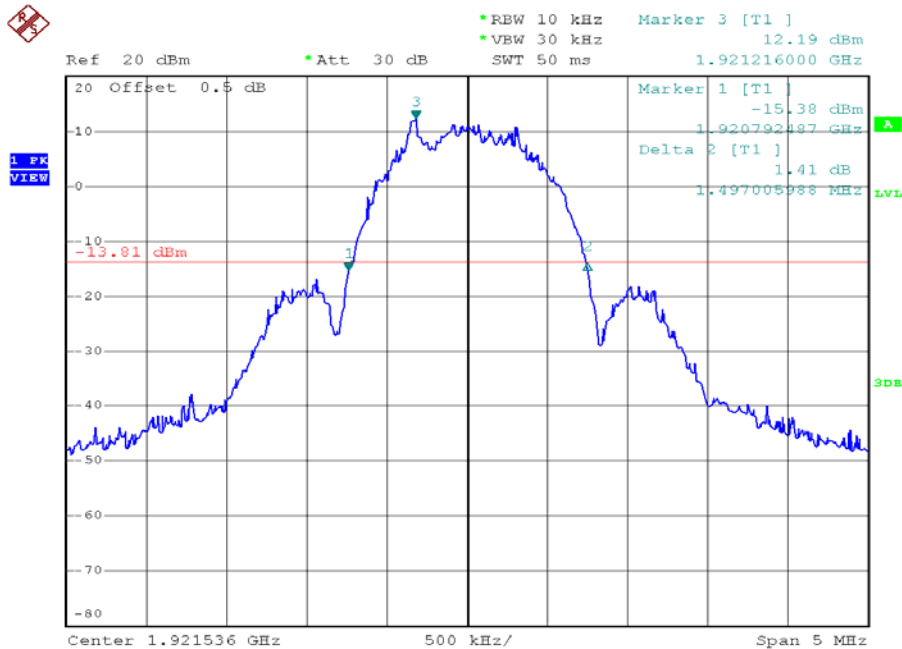

Highest channel, Traffic carrier

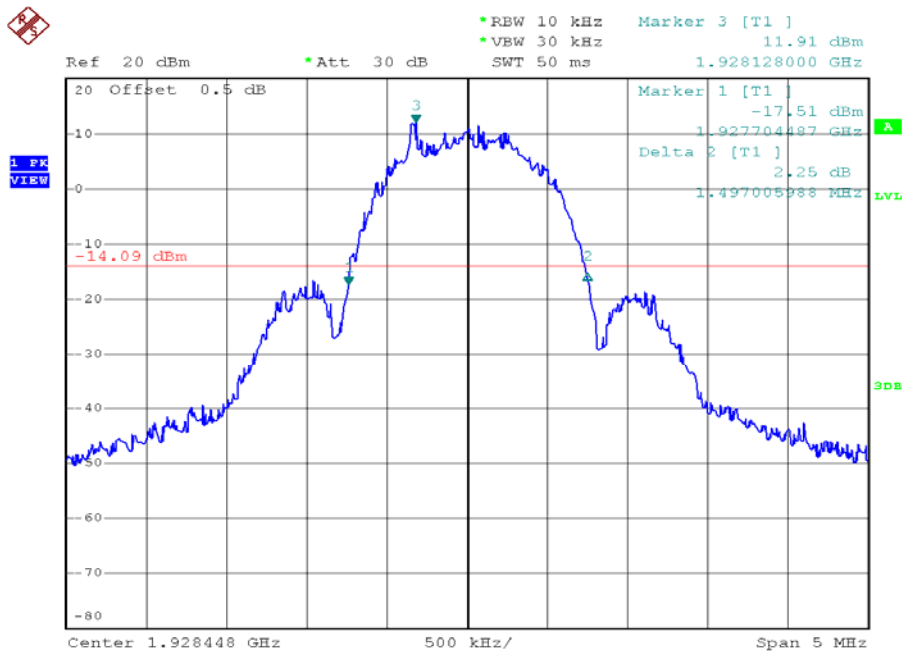

Issuing Laboratory:
Intertek Testing Services Hong Kong Limited

Hong Kong Accreditation Service (HKAS) has accredited this laboratory under the Hong Kong Laboratory Accreditation Scheme (HOKLAS) for specific laboratory activities as listed in the HOKLAS directory of accredited laboratories. The results shown in this report were determined by this laboratory in accordance with its terms of accreditation.



Plots of occupied bandwidth (IC)

Middle channel, Traffic carrier

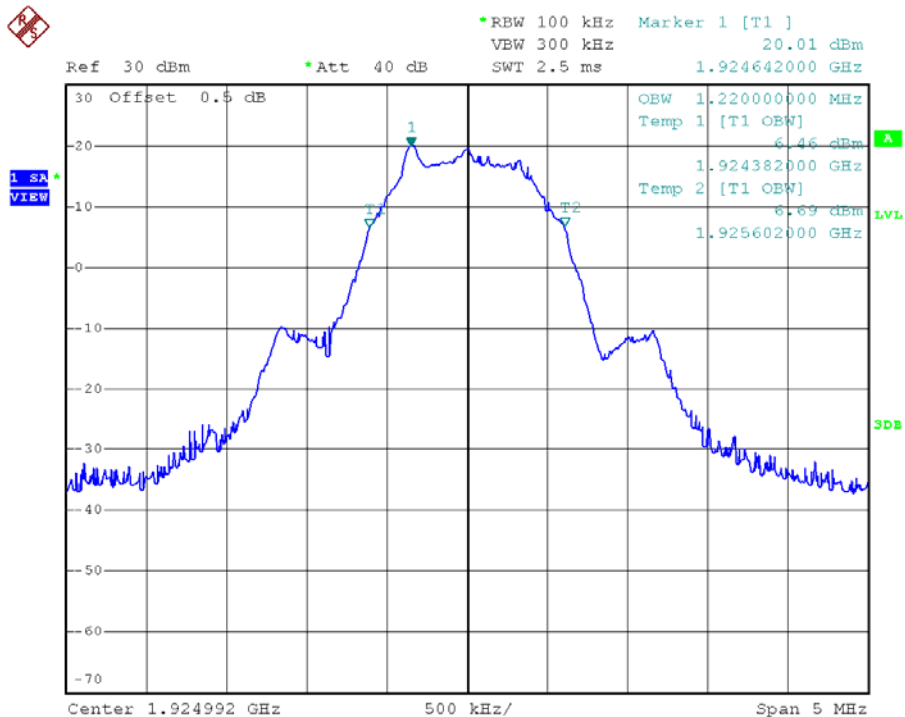

Issuing Laboratory:
Intertek Testing Services Hong Kong Limited

Hong Kong Accreditation Service (HKAS) has accredited this laboratory under the Hong Kong Laboratory Accreditation Scheme (HOKLAS) for specific laboratory activities as listed in the HOKLAS directory of accredited laboratories. The results shown in this report were determined by this laboratory in accordance with its terms of accreditation.



4.4 Directional Gain of the Antenna, FCC Rule FCC 15.319(e) /
RSS-213 Clause 4.1(e):

The peak transmit power shall be reduced by the amount in dB that the maximum directional gain of the antenna exceeds 3 dBi.

The requirements are made in accordance with ANSI C63.17 sub-clause 4.3.1 / RSS-213 Clause 4.1(e).

- [x] Manufacturer declares that the directional gain of the antenna is less than or equal to 3dBi. No peak transmit power reduction is required.
- [] Manufacturer declares that the directional gain of the antenna is greater than 3dBi. The peak transmit power shall be reduced by ____ dB.

4.5 Peak Transmit Power, FCC Rule 15.319(c) / RSS-213 Clause 6.5:

The peak transmit power (P_{EUT}) shall not exceed $100\mu W$ multiplied by the square root of the emission bandwidth / occupied bandwidth (B) in Hz or $5 \log_{10} B - 10$ dBm. The peak transmit power shall be reduced by the amount in dB that the maximum directional gain of the antenna exceeds 3 dBi.

Measurements are made in accordance with ANSI C63.17 sub-clause 6.1.2. Test setup is shown in section 3.2 Figure 3.2.1. The cable loss and/or external attenuation are included in OFFSET function of spectrum analyzer.

Calculation of Peak Transmit Power Limit (P_{max}):

$$\begin{aligned} [\times] \quad P_{max} &= 5 \log_{10} B - 10 \text{ dBm} && \text{when } G_A \leq 3\text{dBi} \\ [] \quad P_{max} &= 5 \log_{10} B - 10 \text{ dBm} - (G_A - 3\text{dBi}) && \text{when } G_A > 3\text{dBi} \end{aligned}$$

Where G_A = EUT Antenna Gain: 0 dBi
 B = Measured Emission Bandwidth / Occupied Bandwidth

Test Results:

I. Traffic Carrier

Channel	Channel Frequency (MHz)	Measured Peak Transmit Power (dBm)	Limit (dBm)	Results
Lowest	1921.536	19.96	20.88	Pass
Middle	1924.992	19.87	20.43	Pass
Highest	1928.448	19.65	20.88	Pass

The plots of peak transmit power are saved as below.

Plots of peak transmit power (FCC)

Lowest channel, Traffic carrier

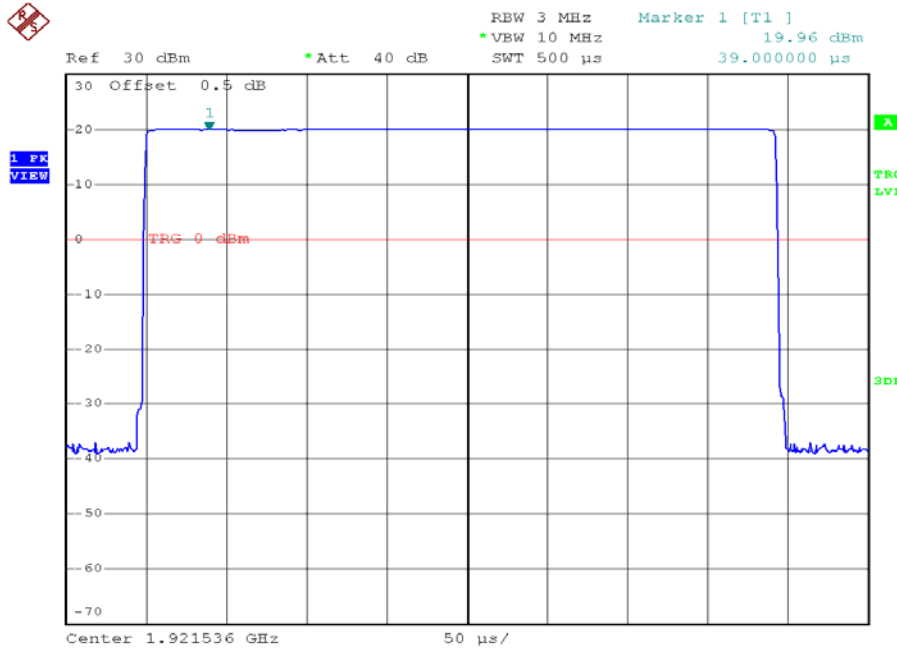

Highest channel, Traffic carrier

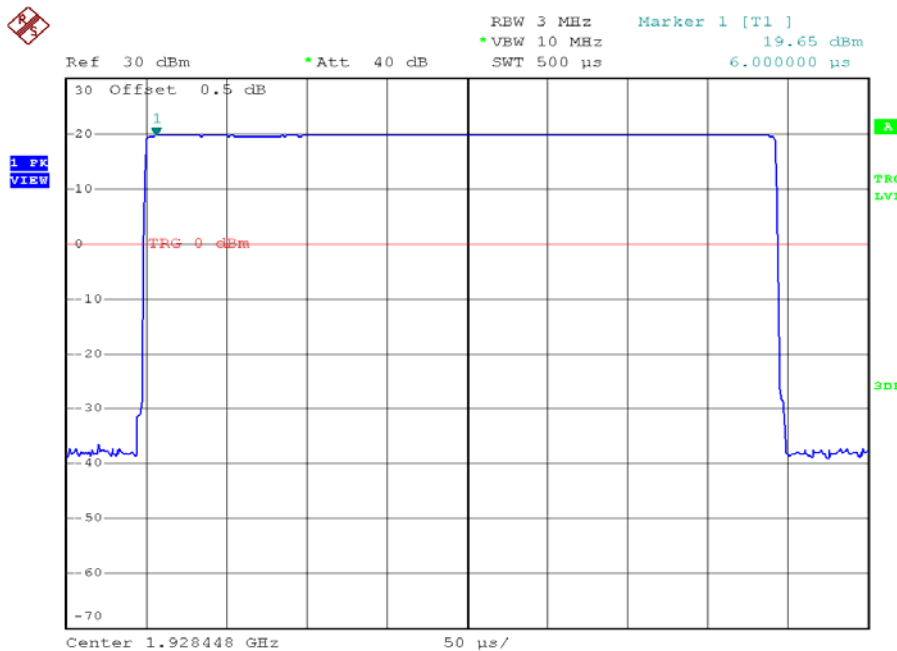

Issuing Laboratory:
Intertek Testing Services Hong Kong Limited

Hong Kong Accreditation Service (HKAS) has accredited this laboratory under the Hong Kong Laboratory Accreditation Scheme (HOKLAS) for specific laboratory activities as listed in the HOKLAS directory of accredited laboratories. The results shown in this report were determined by this laboratory in accordance with its terms of accreditation.



Plots of peak transmit power (IC)

Middle channel, Traffic carrier

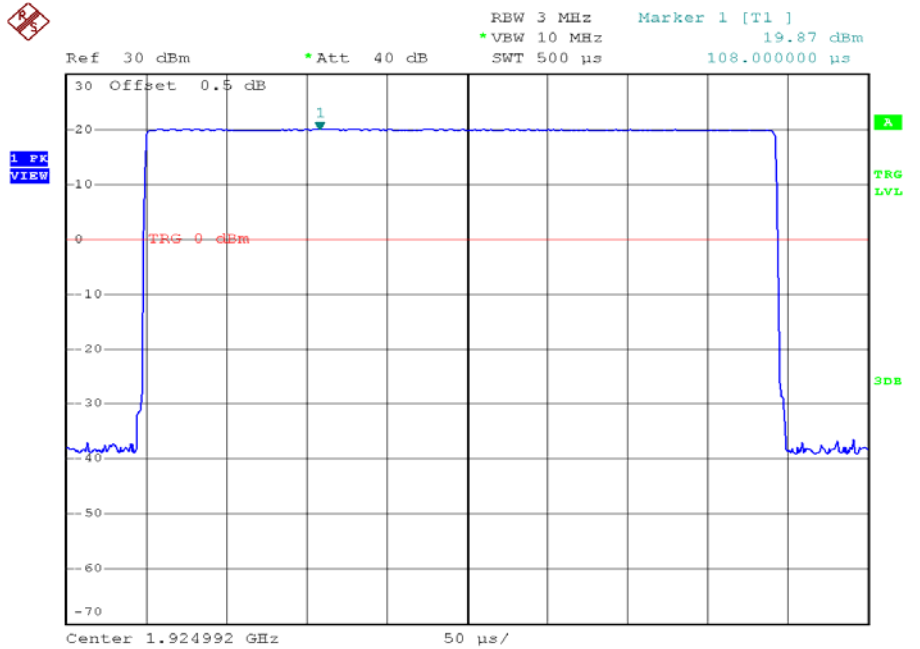

Issuing Laboratory:
Intertek Testing Services Hong Kong Limited

Hong Kong Accreditation Service (HKAS) has accredited this laboratory under the Hong Kong Laboratory Accreditation Scheme (HOKLAS) for specific laboratory activities as listed in the HOKLAS directory of accredited laboratories. The results shown in this report were determined by this laboratory in accordance with its terms of accreditation.



4.6 Power Spectral Density, FCC Rule 15.319(d) / RSS-213 Clause 6.6:

Power spectral density shall not exceed 3 mW (4.8dBm) in any 3 kHz bandwidth as measured with a spectrum analyzer having a resolution bandwidth of 3 kHz.

Measurements are made in accordance with ANSI C63.17 sub-clause 6.1.5. Test setup is shown in section 3.2 Figure 3.2.1.

Test Results:

I. Traffic Carrier

Channel	Channel Frequency (MHz)	Measured Power Spectral Density (dBm/3kHz)	Limit (dBm/3 kHz)	Results
Lowest	1921.536	-4.4	4.8	Pass
Middle	1924.992	-3.7	4.8	Pass
Highest	1928.448	-4.7	4.8	Pass

The plots of the power spectral density are as below.

Issuing Laboratory:
Intertek Testing Services Hong Kong Limited

Hong Kong Accreditation Service (HKAS) has accredited this laboratory under the Hong Kong Laboratory Accreditation Scheme (HOKLAS) for specific laboratory activities as listed in the HOKLAS directory of accredited laboratories. The results shown in this report were determined by this laboratory in accordance with its terms of accreditation.



Plots of the power spectral density (FCC)

Lowest channel, Traffic carrier

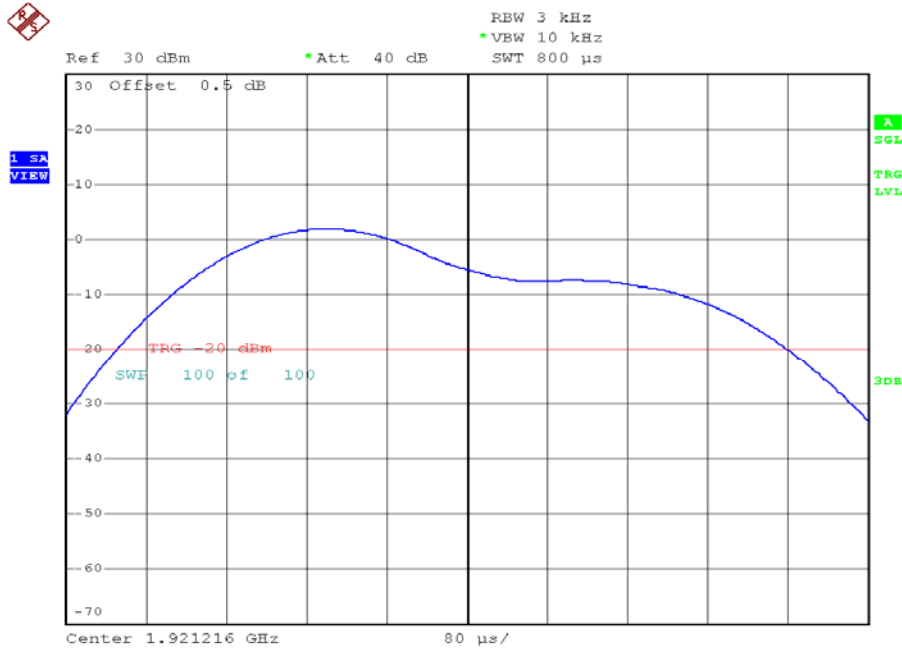

Highest channel, Traffic carrier

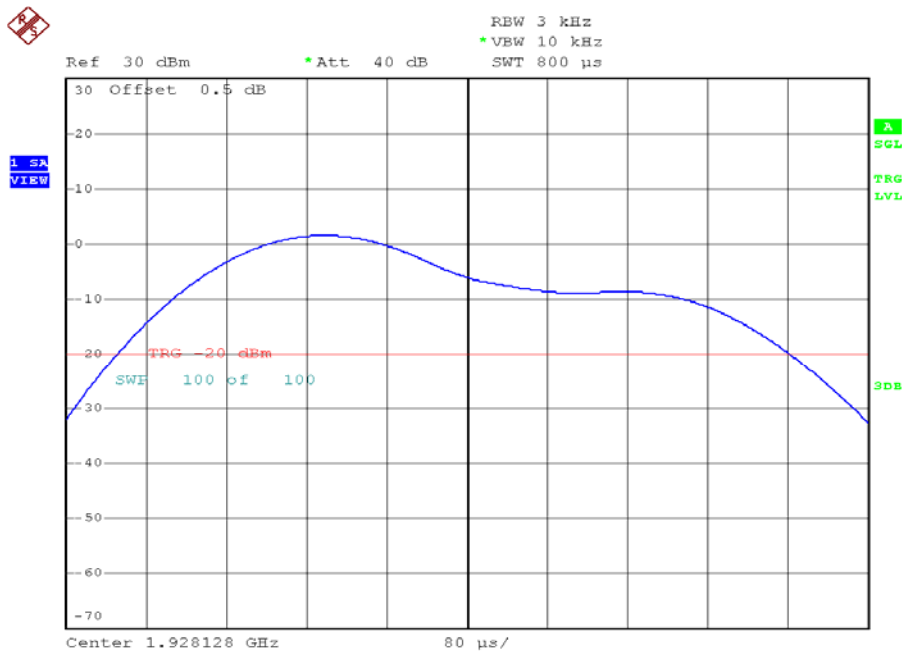

Issuing Laboratory:
Intertek Testing Services Hong Kong Limited

Hong Kong Accreditation Service (HKAS) has accredited this laboratory under the Hong Kong Laboratory Accreditation Scheme (HOKLAS) for specific laboratory activities as listed in the HOKLAS directory of accredited laboratories. The results shown in this report were determined by this laboratory in accordance with its terms of accreditation.



Plots of the power spectral density (IC)

Middle channel, Traffic carrier

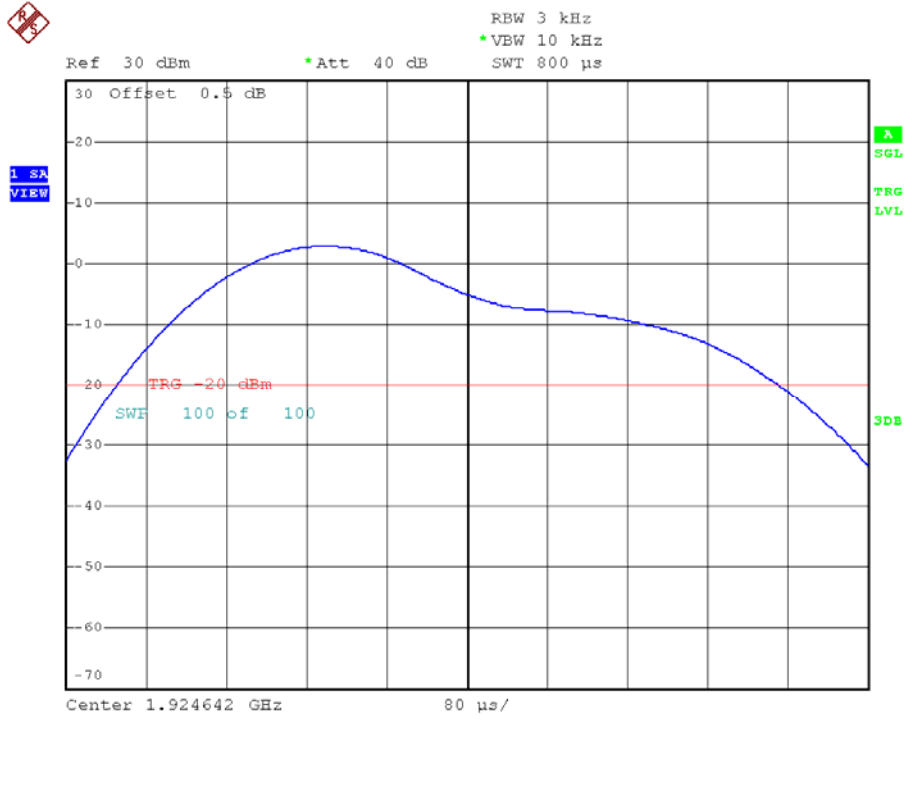

Issuing Laboratory:
Intertek Testing Services Hong Kong Limited

Hong Kong Accreditation Service (HKAS) has accredited this laboratory under the Hong Kong Laboratory Accreditation Scheme (HOKLAS) for specific laboratory activities as listed in the HOKLAS directory of accredited laboratories. The results shown in this report were determined by this laboratory in accordance with its terms of accreditation.



4.7 Automatic Discontinuation of Transmission, FCC Rule 15.319(f) /
RSS-213 Clause 4.3.4(a):

The EUT shall automatically discontinue transmission in case of either absence of information to transmit or operational failure. These provisions are not intended to preclude transmission of control and signaling information or use of repetitive codes used by certain digital technologies to complete frame or burst intervals.

The manufacturer declares that the EUT can automatically discontinue transmission in case of either absent information to transmit or operational failure. Please refer to the declaration letter for details, which is saved with filename: declaration.pdf.

Issuing Laboratory:
Intertek Testing Services Hong Kong Limited

Hong Kong Accreditation Service (HKAS) has accredited this laboratory under the Hong Kong Laboratory Accreditation Scheme (HOKLAS) for specific laboratory activities as listed in the HOKLAS directory of accredited laboratories. The results shown in this report were determined by this laboratory in accordance with its terms of accreditation.



4.8 Unwanted Emission Inside the Sub-Band, FCC Rule 15.323(d) /
RSS-213 Clause 6.7.2:

Emissions inside the sub-band must comply with the following emission mask:

1. In the bands between $1B$ and $2B$ measured from the center of the emission bandwidth, emission shall be at least 30 dB below the permitted peak transmit power.
2. In the bands between $2B$ and $3B$ measured from the center of the emission bandwidth, emission shall be at least 50 dB below the permitted peak transmit power.
3. In the bands between $3B$ and the band edge, emission shall be at least 60 dB below the permitted peak transmit power.

Where B = emission bandwidth or occupied bandwidth in Hz

Measurements are made in accordance with ANSI C63.17 sub-clause 6.1.6.1. Test setup is shown in section 3.2 Figure 3.2.1.

Test Results:

I. Traffic Carrier

Channel	Channel Frequency (MHz)	Results
Lowest	1921.536	Pass
Middle	1924.992	Pass
Highest	1928.448	Pass

The plots of the unwanted emission inside the sub-band are as below.

Plots of the unwanted emission inside the sub-band (FCC)

Lowest channel, Traffic carrier

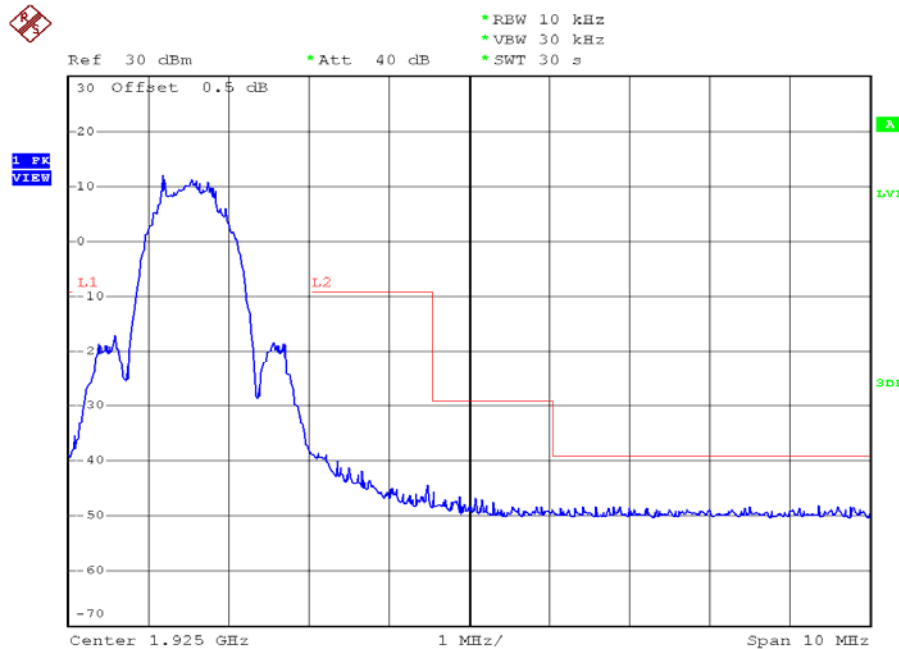

Highest channel, Traffic carrier

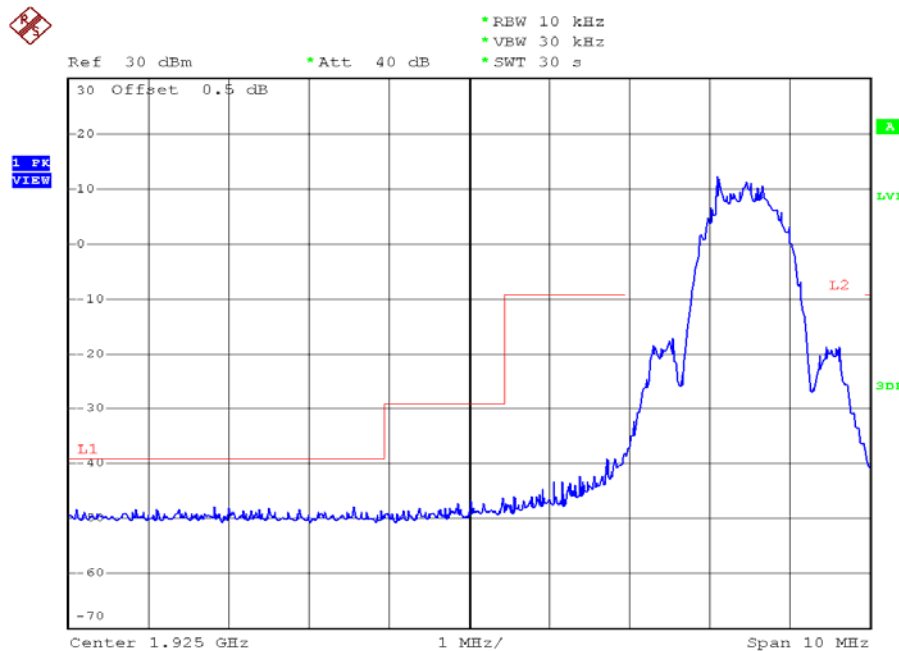

Plots of the unwanted emission inside the sub-band (IC)

Lowest channel, Traffic carrier

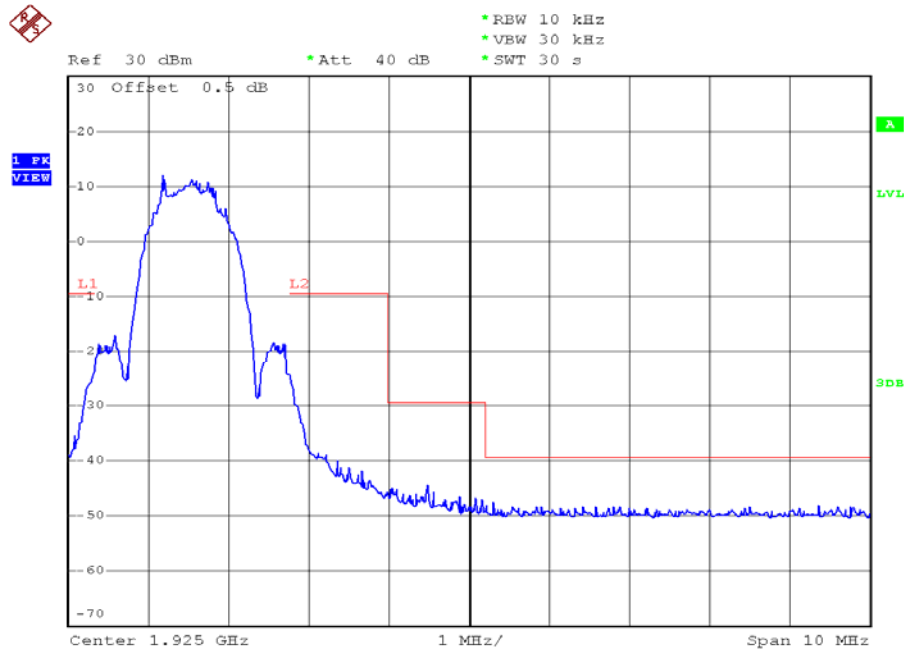

Middle channel, Traffic carrier

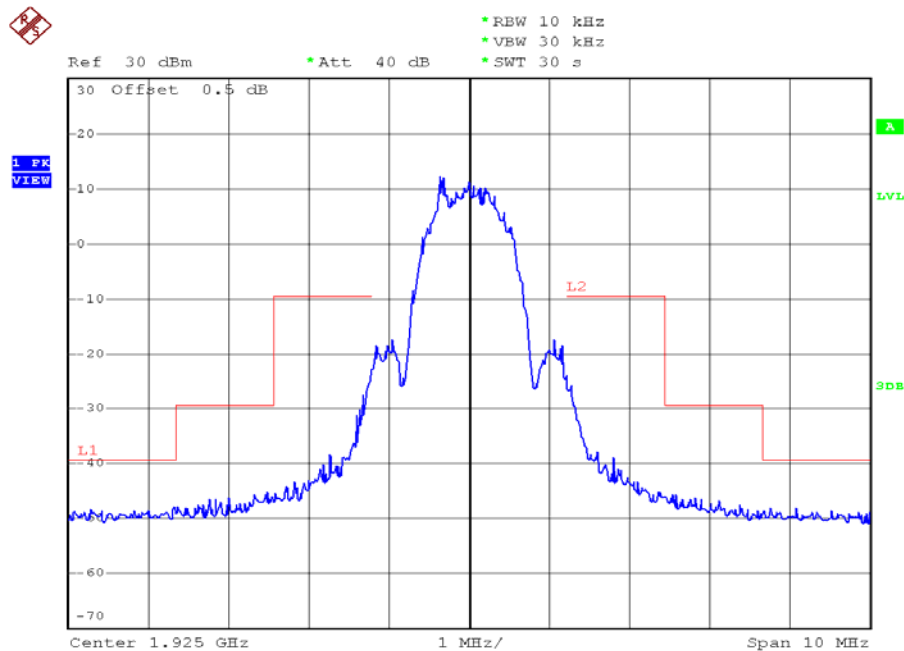

Issuing Laboratory:
Intertek Testing Services Hong Kong Limited

Hong Kong Accreditation Service (HKAS) has accredited this laboratory under the Hong Kong Laboratory Accreditation Scheme (HOKLAS) for specific laboratory activities as listed in the HOKLAS directory of accredited laboratories. The results shown in this report were determined by this laboratory in accordance with its terms of accreditation.



Plots of the unwanted emission inside the sub-band (IC)

Highest channel, Traffic carrier

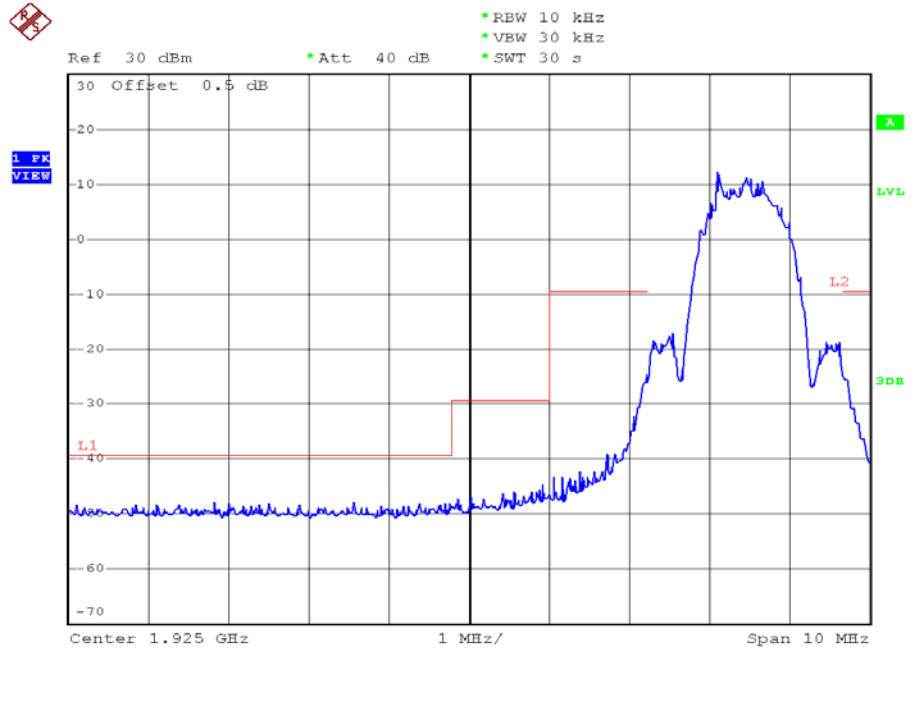

Issuing Laboratory:
Intertek Testing Services Hong Kong Limited

Hong Kong Accreditation Service (HKAS) has accredited this laboratory under the Hong Kong Laboratory Accreditation Scheme (HOKLAS) for specific laboratory activities as listed in the HOKLAS directory of accredited laboratories. The results shown in this report were determined by this laboratory in accordance with its terms of accreditation.



4.9 Emissions Outside the Sub-Band, FCC Rule 15.323(d) / RSS-213 Clause 6.7.1:

Emissions outside the sub-band shall be attenuated below a reference power of 112 mW (20.5 dBm) as follows:

1. 30 dB between the band edge and 1.25 MHz above or below the band;
2. 50 dB between 1.25 and 2.5 MHz above or below the band; and
3. 60 dB at 2.5 MHz or greater above or below the band, or shall meet the requirement of FCC Rule 15.319(g) which shall not exceed the limits of FCC Rule 15.209 / RSS-210 Clause 2.5.

Example: Calculation of Limit for emissions between the band edge and 1.25 MHz (1920.000 – 1918.750 MHz)

The emissions shall not exceed the Limit: 20.5 dBm – 30 dB = -9.5 dBm

Measurements are made in accordance with ANSI C63.17 sub-clause 6.1.6.2. Radiated emissions test method is used. Emissions that are directly caused by digital circuits in the transmit path and transmitter portion are measured.

Test Results:

Channel	Carrier Frequency (MHz)	Measured Band (MHz)	Limit (dBm)	Results
Lowest	1921.536	1920.000 - 1918.750	-9.5	Pass
		1918.750 - 1917.500	-29.5	Pass
		0.009 - 1917.500 & 1932.500 - 19300.000	-39.5 / FCC Rule 15.209 / RSS-210 Clause 2.5	Pass
Highest	1928.448	1930.000 - 1931.250	-9.5	Pass
		1931.250 - 1932.500	-29.5	Pass
		0.009 – 1917.500 & 1932.500 - 19300.000	-39.5 / FCC Rule 15.209 / RSS-210 Clause 2.5	Pass

Issuing Laboratory:
Intertek Testing Services Hong Kong Limited

Hong Kong Accreditation Service (HKAS) has accredited this laboratory under the Hong Kong Laboratory Accreditation Scheme (HOKLAS) for specific laboratory activities as listed in the HOKLAS directory of accredited laboratories. The results shown in this report were determined by this laboratory in accordance with its terms of accreditation.



4.9.1 Radiated Emissions Configuration Photographs:

Worst Case Radiated Emission
at

3843.072 MHz

The worst case radiated emission configuration photographs are saved with filename: config photos.pdf

4.9.2 Radiated Emissions Data:

Data are included of the worst case configuration (the configuration which resulted in the highest emission levels). A sample calculation, configuration photographs and data tables of the emissions are included. All measurements were performed with peak detection unless otherwise specified.

The data in table 1-5 list the significant emission frequencies, the limit and the margin of compliance.

Judgement:

Passed by 5.0 dB margin compared with peak limit

Issuing Laboratory:
Intertek Testing Services Hong Kong Limited

Hong Kong Accreditation Service (HKAS) has accredited this laboratory under the Hong Kong Laboratory Accreditation Scheme (HOKLAS) for specific laboratory activities as listed in the HOKLAS directory of accredited laboratories. The results shown in this report were determined by this laboratory in accordance with its terms of accreditation.



Mode: Bandedge

Table 1

**Radiated Emissions Data
Pursuant To FCC Part 15 Section 15.323 (d) / RSS-213 Clause 6.7.1
Emissions Requirements**

Lowest Channel

Polarization	Frequency (MHz)	Measured Power (dBm)	Power Limit (dBm)	Margin (dB)
H	1919.850	-41.4	-9.5	-31.9
H	1917.869	-46.7	-29.5	-17.2
H	1917.101	-51.8	-39.5	-12.3

NOTES:

1. Peak detector is used for the emission measurement.
2. All measurements were made at 3 meters.
3. Negative value in the margin column shows emission below limit.

Mode: Transmission

Table 2

**Radiated Emissions Data
Pursuant To FCC Part 15 Section 15.209 / RSS-210 Clause 2.5
Emissions Requirements**

Lowest Channel

Polarization	Frequency (MHz)	Reading (dB μ V)	Pre-Amp Gain (dB)	Antenna Factor (dB)	Net at 3m - Peak (dB μ V/m)	Average Factor (dB)	Calculated at 3m (dB μ V/m)	Average Limit at 3m (dB μ V/m)	Margin (dB)
H	3843.072	68.7	33	33.3	69.0	27.6	41.4	54.0	-12.6
H	5764.608	52.2	33	36.6	55.8	27.6	28.2	54.0	-25.8
H	7686.144	49.4	33	38.9	55.3	27.6	27.7	54.0	-26.3
H	9607.680	47.8	33	40.4	55.2	27.6	27.6	54.0	-26.4
H	11529.216	46.5	33	40.5	54.0	27.6	26.4	54.0	-27.6

Polarization	Frequency (MHz)	Reading (dB μ V)	Pre-Amp Gain (dB)	Antenna Factor (dB)	Net at 3m - Peak (dB μ V/m)	Peak Limit at 3m (dB μ V/m)	Margin (dB)
H	3843.072	68.7	33	33.3	69.0	74.0	-5.0
H	5764.608	52.2	33	36.6	55.8	74.0	-18.2
H	7686.144	49.4	33	38.9	55.3	74.0	-18.7
H	9607.680	47.8	33	40.4	55.2	74.0	-18.8
H	11529.216	46.5	33	40.5	54.0	74.0	-20.0

NOTES:

1. Peak detector is used for the emission measurement.
2. The resolution bandwidth of the spectrum analyzer was set 100 kHz and 1 MHz for spurious emission measurements below 1 GHz and above 1 GHz respectively.
3. All measurements were made at 3 meters.
4. Negative value in the margin column shows emission below limit.

Issuing Laboratory:
Intertek Testing Services Hong Kong Limited

Hong Kong Accreditation Service (HKAS) has accredited this laboratory under the Hong Kong Laboratory Accreditation Scheme (HOKLAS) for specific laboratory activities as listed in the HOKLAS directory of accredited laboratories. The results shown in this report were determined by this laboratory in accordance with its terms of accreditation.



Mode: Bandedge

Table 3

Radiated Emissions Data
Pursuant To FCC Part 15 Section 15.323 (d) / RSS-213 Clause 6.7.1
Emissions Requirements

Highest Channel

Polarization	Frequency (MHz)	Measured Power (dBm)	Power Limit (dBm)	Margin (dB)
H	1930.013	-41.6	-9.5	-32.1
H	1931.686	-46.7	-29.5	-17.2
H	1933.471	-52.7	-39.5	-13.2

NOTES:

1. Peak detector is used for the emission measurement.
2. All measurements were made at 3 meters.
3. Negative value in the margin column shows emission below limit.

Mode: Transmission

Table 4

**Radiated Emissions Data
Pursuant To FCC Part 15 Section 15.209 / RSS-210 Clause 2.5
Emissions Requirements**

Highest Channel

Polarization	Frequency (MHz)	Reading (dB μ V)	Pre-Amp Gain (dB)	Antenna Factor (dB)	Net at 3m - Peak (dB μ V/m)	Average Factor (dB)	Calculated at 3m (dB μ V/m)	Average Limit at 3m (dB μ V/m)	Margin (dB)
H	3856.896	68.6	33	33.3	68.9	27.6	41.3	54.0	-12.7
H	5785.344	52.0	33	36.6	55.6	27.6	28.0	54.0	-26.0
H	7713.792	49.4	33	38.9	55.3	27.6	27.7	54.0	-26.3
H	9642.240	47.7	33	40.4	55.1	27.6	27.5	54.0	-26.5
H	11570.688	46.5	33	40.5	54.0	27.6	26.4	54.0	-27.6

Polarization	Frequency (MHz)	Reading (dB μ V)	Pre-Amp Gain (dB)	Antenna Factor (dB)	Net at 3m - Peak (dB μ V/m)	Peak Limit at 3m (dB μ V/m)	Margin (dB)
H	3856.896	68.6	33	33.3	68.9	74.0	-5.1
H	5785.344	52.0	33	36.6	55.6	74.0	-18.4
H	7713.792	49.4	33	38.9	55.3	74.0	-18.7
H	9642.240	47.7	33	40.4	55.1	74.0	-18.9
H	11570.688	46.5	33	40.5	54.0	74.0	-20.0

NOTES:

1. Peak detector is used for the emission measurement.
2. The resolution bandwidth of the spectrum analyzer was set 100 kHz and 1 MHz for spurious emission measurements below 1 GHz and above 1 GHz respectively.
3. All measurements were made at 3 meters.
4. Negative value in the margin column shows emission below limit.

Issuing Laboratory:
Intertek Testing Services Hong Kong Limited

Hong Kong Accreditation Service (HKAS) has accredited this laboratory under the Hong Kong Laboratory Accreditation Scheme (HOKLAS) for specific laboratory activities as listed in the HOKLAS directory of accredited laboratories. The results shown in this report were determined by this laboratory in accordance with its terms of accreditation.



Mode: Talk

Table 5

**Radiated Emissions Data
Pursuant To FCC Part 15 Section 15.323 (d) / RSS-213 Clause 6.7.1
Emissions Requirements**

Polarization	Frequency (MHz)	Measured Power (dBm)	Power Limit (dBm)	Margin (dB)
V	55.300	-63.9	-39.5	-24.4
V	110.600	-63.8	-39.5	-24.3
H	165.900	-62.9	-39.5	-23.4
H	221.200	-62.5	-39.5	-23.0
H	276.500	-63.0	-39.5	-23.5
H	331.800	-63.9	-39.5	-24.4

NOTES:

1. Peak detector is used for the emission measurement.
2. All measurements were made at 3 meters.
3. Negative value in the margin column shows emission below limit.

Issuing Laboratory:
Intertek Testing Services Hong Kong Limited

Hong Kong Accreditation Service (HKAS) has accredited this laboratory under the Hong Kong Laboratory Accreditation Scheme (HOKLAS) for specific laboratory activities as listed in the HOKLAS directory of accredited laboratories. The results shown in this report were determined by this laboratory in accordance with its terms of accreditation.



4.9.3 Field Strength Calculation

The field strength is calculated by adding the reading on the Spectrum Analyzer to the factors associated with preamplifiers (if any), antennas, cables, pulse desensitization and average factors (when specified limit is in average and measurements are made with peak detectors). A sample calculation is included below.

$$FS = RA + AF + CF - AG + PD + AV$$

Where

- FS = Field Strength in $\text{dB}\mu\text{V}/\text{m}$
- RA = Receiver Amplitude (including preamplifier) in $\text{dB}\mu\text{V}$
- CF = Cable Attenuation Factor in dB
- AF = Antenna Factor in dB
- AG = Amplifier Gain in dB
- PD = Pulse Desensitization in dB
- AV = Average Factor in -dB

In the radiated emission table which follows, the reading shown on the data table may reflect the preamplifier gain. An example of the calculations, where the reading does not reflect the preamplifier gain, follows:

$$FS = RA + AF + CF - AG + PD + AV$$

Example

Assume a receiver reading of $62.0 \text{ dB}\mu\text{V}$ is obtained. The antenna factor of 7.4 dB and cable factor of 1.6 dB is added. The amplifier gain of 29.0 dB is subtracted. The pulse desensitization factor of the spectrum analyzer is 0.0 dB , and the resultant average factor is -10.0 dB . The net field strength for comparison to the appropriate emission limit is $32.0 \text{ dB}\mu\text{V}/\text{m}$. This value in $\text{dB}\mu\text{V}/\text{m}$ is converted to its corresponding level in $\mu\text{V}/\text{m}$.

RA = $62.0 \text{ dB}\mu\text{V}$
AF = 7.4 dB
CF = 1.6 dB
AG = 29.0 dB
PD = 0.0 dB
AV = -10 dB

$$FS = 62.0 + 7.4 + 1.6 - 29.0 + 0.0 + (-10.0) = 32.0 \text{ dB}\mu\text{V}/\text{m}$$

$$\text{Level in } \mu\text{V}/\text{m} = \text{Common Antilogarithm } [(32.0 \text{ dB}\mu\text{V}/\text{m})/20] = 39.8 \mu\text{V}/\text{m}$$

Issuing Laboratory:
Intertek Testing Services Hong Kong Limited

Hong Kong Accreditation Service (HKAS) has accredited this laboratory under the Hong Kong Laboratory Accreditation Scheme (HOKLAS) for specific laboratory activities as listed in the HOKLAS directory of accredited laboratories. The results shown in this report were determined by this laboratory in accordance with its terms of accreditation.



4.9.4 Average Factor Calculation and Transmitter ON Time Measurements, FCC Rule 15.35(b, c) / RSS-Gen cl 4.5

Handset: (for single-slot operation)

$$\begin{aligned} \text{Duty Cycle (DC)} &= \text{Number of slot} / \text{Total time slot} \\ &= (1)/24 \end{aligned}$$

$$\begin{aligned} \text{Average Factor (AF)} &= 20 \log (\text{DC}) \\ &= 20 * \log (0.0417) \\ &= -27.6 \text{ dB} \end{aligned}$$

[] The EUT antenna output port was connected to the input of the spectrum analyzer. The analyzer center frequency was set to EUT RF channel carrier. The SPAN function on the analyzer was set to ZERO. The transmitter ON time was determined from the resultant time-amplitude display:

Please refer to the attached plots for more details:

The plots of Transmitter ON Time Measurements are as below.

- [] Please refer to the attached transmitter timing diagram that are provided by manufacturer
- [] Not applicable - No average factor is required.
- [x] Please refer to Technical Description (descri.pdf) for more details

Issuing Laboratory:
Intertek Testing Services Hong Kong Limited

Hong Kong Accreditation Service (HKAS) has accredited this laboratory under the Hong Kong Laboratory Accreditation Scheme (HOKLAS) for specific laboratory activities as listed in the HOKLAS directory of accredited laboratories. The results shown in this report were determined by this laboratory in accordance with its terms of accreditation.



4.10 AC Power Line Conducted Emissions, FCC Rule 15.315 / RSS-213 Clause 6.3:

The AC power line conducted emission shall not exceed the limits of FCC Rule 15.207 / Table 4 in RSS-Gen Clause 7.2.4.

Measurements are made in accordance with ANSI C63.4 sub-clause 7. Emissions that are directly caused by digital circuits in the transmit path and transmitter portion are measured.

- Not applicable – EUT is only powered by battery for operation.
- EUT connects to AC power line. Emission Data is listed in following pages.
- Base Unit connects to AC power line and has transmission. Handset connects to AC power line (indirectly) but has no transmission. Emission Data of Base Unit is listed in following pages.
- Handset connects to AC power line (indirectly) only during charging. Emission Data is listed in following pages.

Issuing Laboratory:
Intertek Testing Services Hong Kong Limited

Hong Kong Accreditation Service (HKAS) has accredited this laboratory under the Hong Kong Laboratory Accreditation Scheme (HOKLAS) for specific laboratory activities as listed in the HOKLAS directory of accredited laboratories. The results shown in this report were determined by this laboratory in accordance with its terms of accreditation.



4.10.1 AC Power Line Conducted Emissions Configuration Photographs:

The worst case AC power Line conducted emission configuration photographs are saved with filename: config photos.pdf

4.10.2 AC Power Line Conducted Emissions Data:

The plot(s) and data in the following pages list the significant emission frequencies, the limit and the worst case margin of compliance.

Judgment:

Passed by more than 20 dB margin

Issuing Laboratory:
Intertek Testing Services Hong Kong Limited

Hong Kong Accreditation Service (HKAS) has accredited this laboratory under the Hong Kong Laboratory Accreditation Scheme (HOKLAS) for specific laboratory activities as listed in the HOKLAS directory of accredited laboratories. The results shown in this report were determined by this laboratory in accordance with its terms of accreditation.



Worst Case: Talk with Charging (with extra charger adaptor "Cesc")

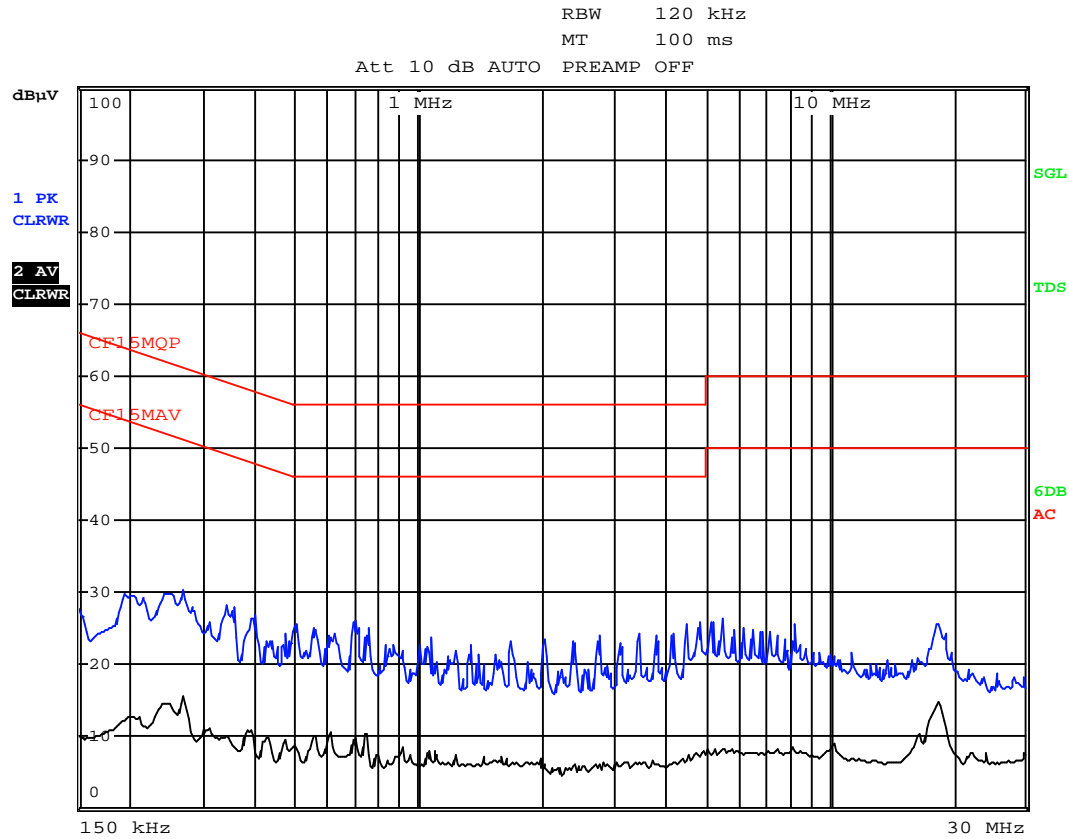

Date: 1.NOV.2013 09:39:35

Issuing Laboratory:
Intertek Testing Services Hong Kong Limited

Hong Kong Accreditation Service (HKAS) has accredited this laboratory under the Hong Kong Laboratory Accreditation Scheme (HOKLAS) for specific laboratory activities as listed in the HOKLAS directory of accredited laboratories. The results shown in this report were determined by this laboratory in accordance with its terms of accreditation.



Worst Case: Talk with Charging (with extra charger adaptor "Ten Pao")

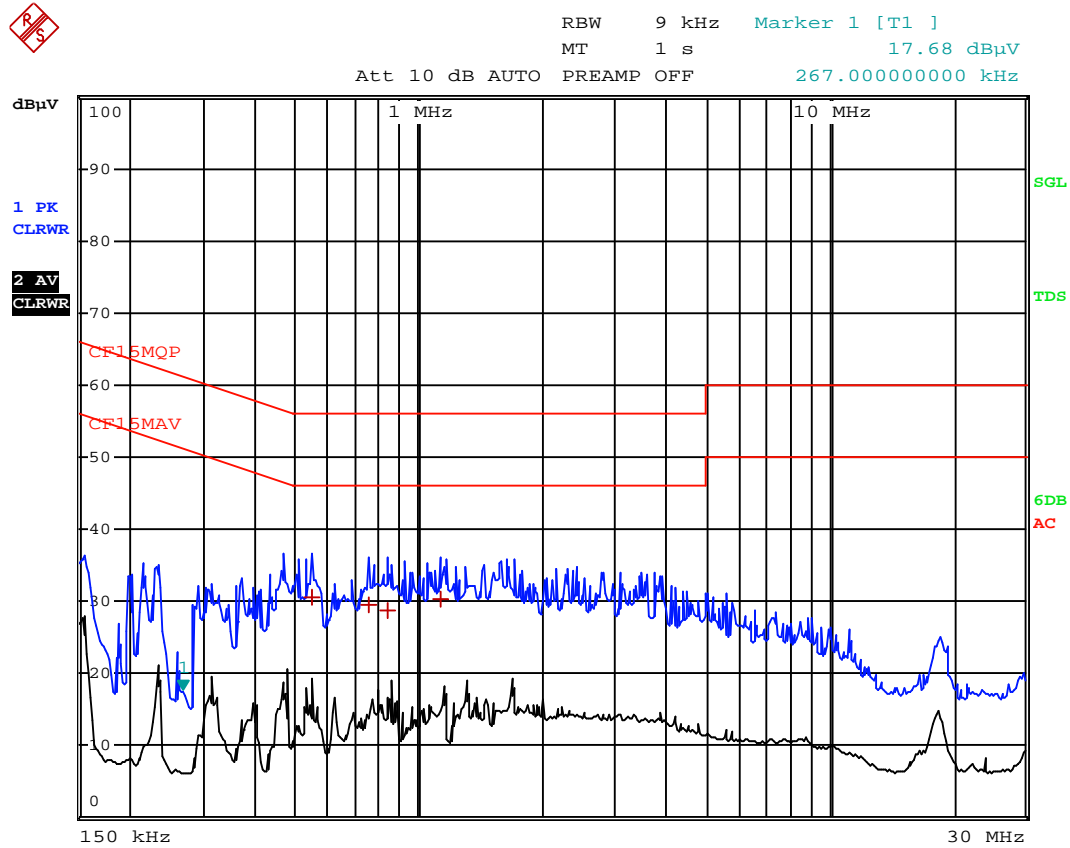

Date: 1.NOV.2013 09:51:00

Issuing Laboratory:
Intertek Testing Services Hong Kong Limited

Hong Kong Accreditation Service (HKAS) has accredited this laboratory under the Hong Kong Laboratory Accreditation Scheme (HOKLAS) for specific laboratory activities as listed in the HOKLAS directory of accredited laboratories. The results shown in this report were determined by this laboratory in accordance with its terms of accreditation.



Worst Case: Talk with Charging (with extra charger adaptor "Ten Pao")

EDIT PEAK LIST (Final Measurement Results)				
TRACE	FREQUENCY	LEVEL dB μ V		DELTA LIMIT dB
Trace1:	CF15MQP			
Trace2:	CF15MAV			
Trace3:	---			
1 Quasi Peak	550.5 kHz	30.59 N		-25.40
1 Quasi Peak	757.5 kHz	29.64 L1		-26.35
1 Quasi Peak	838.5 kHz	28.73 L1		-27.26
1 Quasi Peak	1.1355 MHz	30.42 L1		-25.57

Date: 1.NOV.2013 09:50:40

Issuing Laboratory:
Intertek Testing Services Hong Kong Limited

Hong Kong Accreditation Service (HKAS) has accredited this laboratory under the Hong Kong Laboratory Accreditation Scheme (HOKLAS) for specific laboratory activities as listed in the HOKLAS directory of accredited laboratories. The results shown in this report were determined by this laboratory in accordance with its terms of accreditation.



4.11 Frame Repetition Stability, FCC Rule 15.323(e) / RSS-213 Clause 4.3.4(c):

- [] EUT implements Time Division Duplex (TDD) (not include TDMA) in order to support duplex connection on a given frequency carrier shall maintain a frame repetition rate whereby 3 x standard deviation of the frequency stability shall not exceed 50 ppm, not including a shift of the mean.
- [x] EUT uses Time Division Multiple Access (TDMA) in order to support multiple communication links on a given frequency carrier shall maintain a frame repetition rate whereby 3 x standard deviation of the frequency stability shall not exceed 10 ppm, not including a shift of the mean.

Measurements are made in accordance with ANSI C63.17 sub-clause 6.2.2. Test setup is shown in section 3.2 Figure 3.2.1. A spectrum analyzer measures the time duration between rising edges of two consecutive frames over a time period of at least 1000 frame periods. These measurement values are used to compute the 3 x standard deviation of the frequency stability.

Test Results:

I.

Maximum Frame Repetition Stability (ppm)	Limit (ppm)	Results
0.0405	±10	Pass

Issuing Laboratory:
Intertek Testing Services Hong Kong Limited

Hong Kong Accreditation Service (HKAS) has accredited this laboratory under the Hong Kong Laboratory Accreditation Scheme (HOKLAS) for specific laboratory activities as listed in the HOKLAS directory of accredited laboratories. The results shown in this report were determined by this laboratory in accordance with its terms of accreditation.



4.12 Frame Period and Jitter, FCC Rule 15.323(e) / RSS-213 Clause 4.3.4(c):

The frame period (a set of consecutive time slots in which the position of each time slot can be identified by reference to a synchronizing source) of EUT operating in these sub-bands shall be 20 ms or 10 ms/X where X is a positive whole number.

The jitter (time-related, abrupt, spurious variations in the duration of the frame interval) introduced at the two ends of such a communication link shall not exceed 25 μ s for any two consecutive transmissions. Transmissions shall be continuous in every time and spectrum window during the frame period defined for EUT.

Measurements are made in accordance with ANSI C63.17 sub-clause 6.2.3. Test setup is shown in section 3.2 Figure 3.2.1. A spectrum analyzer measures the time duration between the rising edges of two consecutive frames. The measurements are taken over 100,000 frames. These measurement values are used to compute mean value and the difference between any two consecutive frame periods. The mean value is the frame period.

Test Results:

I.

Measured Maximum Jitter (μ s)	Limit (μ s)	Result
-0.2331	± 25	Pass

4.13 Carrier Frequency Stability, FCC Rule 15.323(f) / RSS-213 Clause 6.2:

The carrier frequency stability of EUT shall be maintained within +/-10 ppm at the following conditions:

1. Over 1 hour at nominal supply voltage and a temperature of +20 °C;
2. Over a variation in the primary supply voltage of 85 % to 115 % of nominal supply voltage at a temperature of +20 °C. This test does not apply to an EUT that is only powered by battery for operation;
3. Over a temperature variation of -20 °C to +50 °C or at extreme temperatures as declared by manufacturer, and at nominal supply voltage.

The nominal supply voltage: 3.7VDC and the extreme temperatures of -20°C to +50°C are/is declared by manufacturer.

Measurements are made in accordance with ANSI C63.17 sub-clause 6.2.1 The EUT and CMD60 is connected with shielded coaxial cable. The EUT is controlled by DECT Radio Communication Tester, CMD60, to use a fixed frequency channel during test as well as record the frequency offset. The transmission of EUT is in burst mode with pseudo-random data. Test setup is shown as follows.

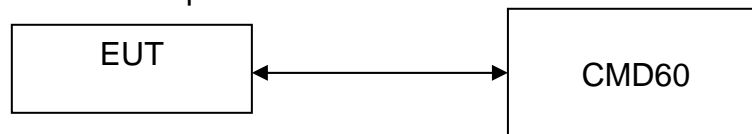

Test Results:

I a. Carrier Frequency Stability over time

Supply Voltage	Temperature (°C)	Measured Frequency Offset Over an hour (ppm)		Limit (ppm)	Result
		Max.	Min.		
Nominal	+20°C	0.73	-1.35	±10	Pass

I b. Carrier Frequency Stability over Power Supply Voltage

Supply Voltage	Temperature (°C)	Measured Frequency Offset (ppm)	Limit (ppm)	Results
85%	+20°C	1.26	±10	Pass
115%	+20°C	1.26	±10	Pass

I c. Carrier Frequency Stability over Temperature

Supply Voltage	Temperature (°C)	Measured Frequency Offset (ppm)	Limit (ppm)	Results
Nominal	-20°C	2.30	±10	Pass
Nominal	+50°C	-2.38	±10	Pass

Issuing Laboratory:
Intertek Testing Services Hong Kong Limited

Hong Kong Accreditation Service (HKAS) has accredited this laboratory under the Hong Kong Laboratory Accreditation Scheme (HOKLAS) for specific laboratory activities as listed in the HOKLAS directory of accredited laboratories. The results shown in this report were determined by this laboratory in accordance with its terms of accreditation.



4.14 Monitoring Threshold:

For FCC, upper monitoring threshold limit is declared by manufacturer, and lower monitoring threshold limit is calculated with 20dB difference of upper monitoring threshold limit.

For IC, monitoring threshold can be relaxed according to RSS-213 Clause 4.3.4(b)(9). EUT that has a power output lower than the maximum permitted under RSS-213 Clause 6.5 may increase their monitoring detection threshold by one decibel for each one decibel that the transmitter power is below the maximum permitted.

Calculation of Monitoring Threshold Limit:

$$\begin{aligned} \text{Monitoring Threshold (T)} &\leq -174 + 10 \log_{10} B + M + P_{\max} - P_{\text{EUT}} \text{ dBm} \\ &\leq 15 \log_{10} B - 184 + M - P_{\text{EUT}} \text{ dBm} \end{aligned}$$

- Where B = Measured Emission Bandwidth or Occupied Bandwidth - IC: 1.22MHz
 M = 30 dB for Lower Monitoring Threshold (T_L), or
 = 50 dB for Upper Monitoring Threshold (T_U)
 P_{\max} = $5 \log_{10} B - 10$ dBm
 P_{EUT} = Measured Peak Transmit Power - IC: 19.87dBm

Monitoring Threshold Limits:

I.

	FCC	IC
Lower Monitoring Threshold ($T_L + U_M$) in dBm	-75.3	-76.6
Upper Monitoring Threshold ($T_U + U_M$) in dBm	-55.3	-56.6

NA - Not applicable

Issuing Laboratory:
Intertek Testing Services Hong Kong Limited

Hong Kong Accreditation Service (HKAS) has accredited this laboratory under the Hong Kong Laboratory Accreditation Scheme (HOKLAS) for specific laboratory activities as listed in the HOKLAS directory of accredited laboratories. The results shown in this report were determined by this laboratory in accordance with its terms of accreditation.



4.14.1 Lower Monitoring Threshold, FCC Rule 15.323(c)(2) /
RSS-213 Clause 4.3.4(b)(2):

- Not applicable – EUT which supports at least of 20 duplex system access channels for FCC and 40 duplex system access channels for IC and implements Least Interfered Channel (LIC) algorithm is permitted to use an upper monitoring threshold. Please refer to the section 4.14.2 for more details.
- The lower monitoring threshold must not be more than 30 dB above the thermal noise power for a bandwidth equivalent to the emission bandwidth used by EUT.

Measurements are made in accordance with ANSI C63.17 sub-clause 7.3.1. Test setup is shown in section 3.3 Figure 3.3.1. The test is performed on the carrier closest to center of the band. RF signal generators apply uniform CW interference on all EUT carriers each at level $T_L + U_M + 10$ dB. Then, the interference level is reduced uniformly on all carriers until the EUT can transmit. The interference level shall be lower than or equal to the threshold limit.

Test Results:

I.

Measured Maximum Interference Level (dBm)	Lower Monitoring Threshold Limit (dBm) ($T_L + U_M$)		Results
	FCC	IC	
NA	-75.3	-76.6	NA

NA - Not applicable

Issuing Laboratory:
Intertek Testing Services Hong Kong Limited

Hong Kong Accreditation Service (HKAS) has accredited this laboratory under the Hong Kong Laboratory Accreditation Scheme (HOKLAS) for specific laboratory activities as listed in the HOKLAS directory of accredited laboratories. The results shown in this report were determined by this laboratory in accordance with its terms of accreditation.



4.14.2 Least Interfered Channel, LIC, FCC Rule 15.323(c)(5) /
RSS-213 Clause 4.3.4(b)(5):

- Not implemented – EUT met lower monitoring threshold requirements. Please refer to the section 4.15.1 for more details
- If access to spectrum is not available as determined by section 4.14.1 and a minimum of 20 duplex system access channels (FCC) and 40 duplex system access channels (IC) are defined for the EUT, the time and spectrum windows with the lowest power level below a monitoring threshold of 50 dB above the thermal noise power determined for the emission bandwidth may be accessed

Number of duplex channels per frequency channel = 12
 Number of frequency channel = 5
 Total Duplex Channels = 60

Hence, the time and spectrum windows below upper monitoring threshold may be accessed.

4.14.2.1 Upper Monitoring Threshold, FCC Rule 15.323(c)(5) /
RSS-213 Clause 4.3.4(b)(5):

Measurements are made in accordance with ANSI C63.17 sub-clause 7.3.2. Test setup is shown in section 3.3 Figure 3.3.1. The test is performed on the carrier closest to center of the band. RF signal generators apply uniform CW interference on all EUT carriers each at level $T_U + U_M + 10$ dB. Then, the interference level is reduced uniformly on all carriers until the EUT can transmit. The interference level shall be lower than or equal to the threshold limit.

Test Results:

I.

Measured Maximum Interference Level (dBm)	Upper Monitoring Threshold Limit (dBm) ($T_U + U_M$)		Results
	FCC	IC	
-62.3	-55.3	-56.6	Pass

NA - Not applicable

Issuing Laboratory:
Intertek Testing Services Hong Kong Limited

Hong Kong Accreditation Service (HKAS) has accredited this laboratory under the Hong Kong Laboratory Accreditation Scheme (HOKLAS) for specific laboratory activities as listed in the HOKLAS directory of accredited laboratories. The results shown in this report were determined by this laboratory in accordance with its terms of accreditation.



4.14.2.2 Least Interfered Channel (LIC) Selection, FCC Rule 15.323(c)(5) /
RSS-213 Clause 4.3.4(b)(5):

The criteria are specified in section 4.14.2. In addition, the power measurement resolution for this comparison must be accurate to within 6 dB.

Measurements are made in accordance with ANSI C63.17 sub-clause 7.3.3. Test setup is shown in section 3.3 Figure 3.3.1. RF signal generators apply uniform CW interference on all EUT carriers except two carriers (designated f_1 and f_2), each at level $T_U + U_M$. EUT can only transmit on these two carriers.

Issuing Laboratory:
Intertek Testing Services Hong Kong Limited

Hong Kong Accreditation Service (HKAS) has accredited this laboratory under the Hong Kong Laboratory Accreditation Scheme (HOKLAS) for specific laboratory activities as listed in the HOKLAS directory of accredited laboratories. The results shown in this report were determined by this laboratory in accordance with its terms of accreditation.



4.14.2.2 Least Interfered Channel (LIC) Selection, FCC Rule 15.323(c)(5) /
RSS-213 Clause 4.3.4(b)(5): - Continued

Test Descriptions and Results:

I. LIC Procedure

	Test Descriptions	EUT transmits on	Results
1	Apply interference on f_1 at level $T_L + U_M + 7$ dB. Apply interference on f_2 at level $T_L + U_M$. Initiate transmission. Verify transmission on f_2 . Terminate transmission. Repeat 5 times.	f_2	Pass
2	Apply interference on f_1 at level $T_L + U_M$. Apply interference on f_2 at level $T_L + U_M + 7$ dB. Initiate transmission. Verify transmission on f_1 . Terminate transmission. Repeat 5 times.	f_1	Pass
3	Apply interference on f_1 at level $T_L + U_M + 1$ dB. Apply interference on f_2 at level $T_L + U_M - 6$ dB. Initiate transmission. Verify transmission on f_2 . Terminate transmission. Repeat 5 times.	f_2	Pass
4	Apply interference on f_1 at level $T_L + U_M - 6$ dB. Apply interference on f_2 at level $T_L + U_M + 1$ dB. Initiate transmission. Verify transmission on f_1 . Terminate transmission. Repeat 5 times.	f_1	Pass

NA - Not applicable

Issuing Laboratory:
Intertek Testing Services Hong Kong Limited

Hong Kong Accreditation Service (HKAS) has accredited this laboratory under the Hong Kong Laboratory Accreditation Scheme (HOKLAS) for specific laboratory activities as listed in the HOKLAS directory of accredited laboratories. The results shown in this report were determined by this laboratory in accordance with its terms of accreditation.



4.14.2.3 Least Interfered Channel (LIC) Confirmation, FCC Rule 15.323(c)(5) / RSS-213 Clause 4.3.4(b)(5):

EUT utilizing the provision of FCC Rule 15.323(c)(5) / RSS-213 Clause 4.3.4(b)(5) must have monitored all access channels defined for its system within the last 10 s and must verify, within the 20 ms (40 ms for EUT designed to use a 20 ms frame period) immediately preceding actual channel access that the detected power of the selected time and spectrum windows is no higher than the previously detected value.

Measurements are made in accordance with ANSI C63.17 sub-clause 7.3.4. This test is performed in section 4.15 and 4.16.

Results:

The tests are reported in section 4.15 and 4.16.

4.14.2.4 Maximum Spectrum Occupancy, FCC Rule 15.323(c)(5) / RSS-213 Clause 4.3.4(b)(5):

No EUT or group of co-operating EUTs located within 1 meter of each other shall during any frame period occupy more than 6 MHz of aggregate bandwidth, or alternatively, more than one third of the time and spectrum windows defined by the EUT.

Attestation:

According to the technical description provided, the total number of the time and spectrum windows defined by the system is $5 \times 12 = 60$.

During any frame period, the maximum number of time and spectrum windows occupied by the system will be 12, which is less than one third of the time and spectrum windows defined by the system.

Issuing Laboratory:
Intertek Testing Services Hong Kong Limited

Hong Kong Accreditation Service (HKAS) has accredited this laboratory under the Hong Kong Laboratory Accreditation Scheme (HOKLAS) for specific laboratory activities as listed in the HOKLAS directory of accredited laboratories. The results shown in this report were determined by this laboratory in accordance with its terms of accreditation.



4.15 Monitoring Time, FCC Rule 15.323(c)(1) / RSS-213 Clause 4.3.4(b)(1):

Immediately prior to initiating transmission, EUT must monitor the combined time and spectrum windows in which they intend to transmit for a period of at least 10 ms for EUT designed to use a 10 ms or shorter frame period, or at least 20 ms for EUT designed to use a 20 ms frame period.

Measurements are made in accordance with ANSI C63.17 sub-clause 7.3.4. Test setup is shown in section 3.3 Figure 3.3.1. RF signal generators apply uniform CW interference on all system carriers except two carriers (designated f_1 and f_2), each at level $T_U + U_M$. EUT can only transmit on these two carriers.

Test Descriptions and Results:

I.

	Test Descriptions	EUT transmits on	Results
1	Apply interference on f_1 at level $T_U + U_M$, and no interference on f_2 . Initiate transmission. Verify transmission on f_2 . Then, terminate transmission.	f_2	Pass
2	Apply interference on f_2 at level $T_U + U_M$, and remove interference from f_1 immediately. Also immediately initiate transmission but is at least 20 ms after interference on f_2 is applied. Verify transmission on f_1 .	f_1	Pass

4.16 Maximum Transmit Period, FCC Rule 15.323(c)(3) / RSS-213 Clause 4.3.4(b)(3):

If no signal above the threshold level is detected, transmission may commence and continue with the same emission bandwidth in the monitored time and spectrum windows without further monitoring. However, occupation of the same combined time and spectrum windows by a EUT or group of co-operating EUTs continuously over a period of time longer than 8 hours is not permitted without repeating the access criteria.

EUT establishes a communication channel with its companion device, which occupies the duplex pair combined time and spectrum windows. Reference RF signal generator synchronized with the sample and then generated a pulse as a time frame reference. The centre frequency of spectrum analyzer was set to the carrier frequency and the SPAN was set to ZERO. The spectrum analyzer was used to monitor the time (reference to the time signal) and spectrum of the communication channel. The occupied time or spectrum of the communication channel shall be changed over a period of time no longer than 8 hours. For a EUT with a frame period of 10/X ms, no more than 2,880,000 X frames should be transmitted without a break.

Test setup is shown as follows:

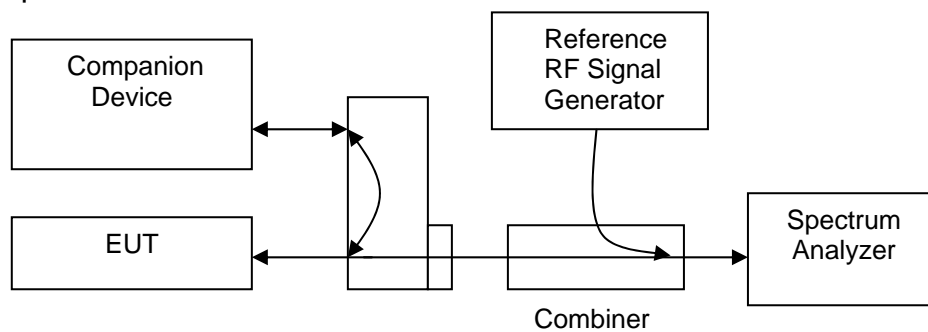

Test Results:

I.

Measured Maximum Transmission Duration (minutes)	Limit (minutes)	Results
240	480	Pass

Issuing Laboratory:
Intertek Testing Services Hong Kong Limited

Hong Kong Accreditation Service (HKAS) has accredited this laboratory under the Hong Kong Laboratory Accreditation Scheme (HOKLAS) for specific laboratory activities as listed in the HOKLAS directory of accredited laboratories. The results shown in this report were determined by this laboratory in accordance with its terms of accreditation.



4.17 System Acknowledgement, FCC Rule 15.323(c)(4) / RSS-213 Clause 4.3.4(b)(4):

Once access to specific combined time and spectrum windows is obtained an acknowledgment from a system participant must be received by the initiating transmitter within one second or transmission must cease. Periodic acknowledgments must be received at least every 30 seconds or transmission must cease. Channels used exclusively for control and signaling information may transmit continuously for 30 seconds without receiving an acknowledgment, at which time the access criteria must be repeated.

Measurements are made in accordance with ANSI C63.17 sub-clause 8.1.1 and 8.2.1. Test setup is shown in section 3.3 Figure 3.3.1.

Test Results:

I.

[] Timing for EUTs using control and signaling channel type transmissions:

Conditions	Transmission Duration (seconds)	Limit (seconds)	Results
Time needed to repeat access criteria	NA	30	NA

[x] Timing for EUTs using communications channel type transmissions:

Conditions	Transmission Duration (seconds)	Limit (seconds)	Results
Activate EUT w/ companion device off	0	1	Pass
Time needed to cease Traffic Channel	5	30	Pass

NA - Not applicable

Issuing Laboratory:
Intertek Testing Services Hong Kong Limited

Hong Kong Accreditation Service (HKAS) has accredited this laboratory under the Hong Kong Laboratory Accreditation Scheme (HOKLAS) for specific laboratory activities as listed in the HOKLAS directory of accredited laboratories. The results shown in this report were determined by this laboratory in accordance with its terms of accreditation.



4.18 Random Waiting, FCC Rule 15.323(c)(6) / RSS-213 Clause 4.3.4(b)(6):

If the selected combined time and spectrum windows are unavailable, the EUT may either monitor and select different windows or seek to use the same windows after waiting an amount of time, randomly chosen from a uniform random distribution between 10 and 150 ms, commencing when the channel becomes available.

Measurements are made in accordance with ANSI C63.17 sub-clause 8.1.2 or 8.1.3. Test setup is shown in section 3.3 Figure 3.3.1.

Test Results:

I.

Random Waiting is not implemented in the EUT:

Conditions	Transmit Channel	Results
Interference applied at operating Channel, f_1	NA	NA

Random Waiting is implemented in the EUT:

Maximum time interval from the end of interference to the start of the control channel	The distribution of the measured time intervals	Results
NA	NA	NA

NA - Not applicable

4.19 Monitoring Bandwidth, FCC Rule 15.323(c)(7).1 / RSS-213 Clause 4.3.4(b)(7).1:

The monitoring bandwidth must be equal to or greater than the emission bandwidth/occupied bandwidth of the intended transmission.

Measurements are made in accordance with ANSI C63.17 sub-clause 7.4. Test setup is shown in section 3.3 Figure 3.3.1.

Attestation:

Monitoring bandwidth of the EUT is equal to the occupied bandwidth of the intended transmission. Monitoring is made through the radio receiver used by the EUT for communication. Please refer to the section 2.2 Technical Description for more details. Designed bandwidth refers to section 4.3 Emission Bandwidth / Occupied Bandwidth.

Compliance is demonstrated by Monitoring Bandwidth Tests as shown below.

Test Results:

la. Simple Compliance Test Results

Interference from Carrier	Reaction of EUT	Results
-30% EBW / Occupied Bandwidth	NA	NA
+30% EBW / Occupied Bandwidth	NA	NA

lb. Detailed Compliance Test Results

CW Interference from Carrier	Reaction of EUT	Results
+ 6 dB	NA	NA
+ 12 dB	NA	NA
- 6 dB	NA	NA
- 12 dB	NA	NA

- A – Could Transmit
- B – Could not Transmit
- NA – Not applicable

*Remarks: Detailed Compliance Test was used to show the compliance of the EUT.

Issuing Laboratory:
Intertek Testing Services Hong Kong Limited

Hong Kong Accreditation Service (HKAS) has accredited this laboratory under the Hong Kong Laboratory Accreditation Scheme (HOKLAS) for specific laboratory activities as listed in the HOKLAS directory of accredited laboratories. The results shown in this report were determined by this laboratory in accordance with its terms of accreditation.



4.20 Maximum Reaction Time, FCC Rule 15.323(c)(7).2 /
RSS-213 Clause 4.3.4(b)(7).2:

The monitoring system bandwidth must have a maximum reaction time less than $50 \times \text{SQRT}(1.25/\text{emission bandwidth } B \text{ in MHz}) \mu\text{s}$ for signals at the applicable threshold level but shall not be required to be less than $50 \mu\text{s}$. If a signal is detected that is 6 dB or more above the applicable threshold level, the maximum reaction time shall be $35 \times \text{SQRT}(1.25/\text{emission bandwidth } B \text{ in MHz}) \mu\text{s}$ but shall not be required to be less than $35 \mu\text{s}$.

Measurements are made in accordance with ANSI C63.17 sub-clause 7.5. Test setup is shown in section 3.3 Figure 3.3.1.

Test Results:

	Test	Reaction of EUT	Results
1	With Interference Pulse = $50 \mu\text{s}$ (FCC), $50\sqrt{1.25/B}$ us (IC)	B	Pass
2	With Interference Pulse = $35 \mu\text{s}$ (FCC), $35\sqrt{1.25/B}$ us (IC)	B	Pass

- A – Could be connected in at least one channel
- B – Could not be connected in all channels
- NA – Not applicable

4.21 Monitoring Antenna, FCC Rule 15.323(c)(8) / RSS-213 Clause 4.3.4(b)(8):

The monitoring system shall use the same antenna used for transmission, or an antenna that yields equivalent reception at that location.

- [x] EUT uses the same antenna used for transmission and monitoring that is in compliance meet above provision.
- [] EUT uses difference antenna used for transmission and monitoring. It must be verified that the monitoring antenna provides coverage equivalent to that of the transmitting antenna. Measurements are made in accordance with ANSI C63.17 sub-clause 4.

Issuing Laboratory:
Intertek Testing Services Hong Kong Limited

Hong Kong Accreditation Service (HKAS) has accredited this laboratory under the Hong Kong Laboratory Accreditation Scheme (HOKLAS) for specific laboratory activities as listed in the HOKLAS directory of accredited laboratories. The results shown in this report were determined by this laboratory in accordance with its terms of accreditation.



4.22 Duplex Connections, FCC 15.323(c)(10) / RSS-213 Clause 4.3.4(b)(10):

An initiating device may attempt to establish a duplex connection by monitoring both its intended transmit (Tx) and receive (Rx) time and spectrum windows. If both the intended transmit and receive time and spectrum windows meet the access criteria, then the initiating device can initiate a transmission in the intended transmit time and spectrum window. If the power detected by the responding device can be decoded as a duplex connection signal from the initiating device, then the responding device may immediately begin transmitting on the receive time and spectrum window monitored by the initiating device.

Measurements are made in accordance with ANSI C63.17 sub-clause 8.3. Test setup is shown in section 3.3 Figure 3.3.1.

Attestation:

The Speaker is the initiating device of the duplex connection

Test Results:

la.

Dual Access Criteria Check for EUT not Implemented the Upper Threshold:

Interference	Reaction of EUT	Results
All Tx and Rx Window, except one for Rx Window	NA	NA
All Tx and Rx Window, except one for Tx Window	NA	NA

Issuing Laboratory:
Intertek Testing Services Hong Kong Limited

Hong Kong Accreditation Service (HKAS) has accredited this laboratory under the Hong Kong Laboratory Accreditation Scheme (HOKLAS) for specific laboratory activities as listed in the HOKLAS directory of accredited laboratories. The results shown in this report were determined by this laboratory in accordance with its terms of accreditation.



4.22 Duplex Connections, FCC 15.323(c)(10) /
RSS-213 Clause 4.3.4(b)(10): - Continued

Ib.

[x] Dual Access Criteria Check for EUT Implemented the Upper Threshold:

Interference	Reaction of EUT	Results
All Tx windows with level $T_L + U_M$ & Rx windows with level $T_L + U_M + 7\text{dB}$, except one for Tx window & one for Rx window, which are not duplex.	A	Pass
All Tx windows with level $T_L + U_M + 7\text{dB}$ & Rx windows with level $T_L + U_M$, except one for Tx window & one for Rx, which are not duplex	B	Pass
All Tx & Rx windows with level $T_U + U_M$, except one for Tx window & one for Rx Window, which are not duplex	D	Pass

- A – Could be connected on the target Rx window and its duplex mate
- B – Could be connected on the target Tx window and its duplex mate
- C – Connected on window which is not the target Tx/Rx window
- D – Could not be connected

- NA – Not applicable

Issuing Laboratory:
Intertek Testing Services Hong Kong Limited

Hong Kong Accreditation Service (HKAS) has accredited this laboratory under the Hong Kong Laboratory Accreditation Scheme (HOKLAS) for specific laboratory activities as listed in the HOKLAS directory of accredited laboratories. The results shown in this report were determined by this laboratory in accordance with its terms of accreditation.



4.23 Alternative Monitoring Interval for Co-located Device, FCC Rule 15.323(c)(11) / RSS-213 Clause 4.3.4(b)(11):

An initiating device that is prevented from monitoring during its intended transmit window due to monitoring system blocking from the transmissions of a co-located (within one meter) transmitter of the same system, may monitor the portions of the time and spectrum windows in which they intend to receive over a period of at least 10 ms. The monitored time and spectrum window must total at least 50 % of the 10 ms frame interval and the monitored spectrum must be within the 1.25 MHz frequency channel(s) already occupied by that device or co-located co-operating devices. If the access criteria is met for the intended receive time and spectrum window under the above conditions, then transmission in the intended transmit window by the initiating device may commence.

Measurements are made in accordance with ANSI C63.17 sub-clause 8.4.

Attestation:

- [] Appropriate as it is co-located device, in which the monitoring system will be blocked from the transmissions of a co-located (Within one meter) transmitter of the same system. Please refer to attachment, 15.323(c)(11).pdf / RSS-213(b)(11).pdf, for details.
- [x] Not appropriate, as the system always monitor both the transmit and receive time/spectrum windows, it is not a co-located device.

4.24 Fair Access, FCC Rule 15.323(c)(12) / RSS-213 Clause 4.3.4(b)(12):

The provisions of FCC Rule 15.323(c)(10) or (c)(11) / RSS-213 Clause 4.3.4(b)(10) or (b)(11) shall not be used to extend the range of spectrum occupied over space or time for the purpose of denying fair access to spectrum to other devices.

Attestation:

The manufacturer declares that the device does not use any mechanisms as provided by Part 15.323(c)(10) or (c)(11) / RSS-213 Clause 4.3.4(b)(10) or (b)(11) to extend the range of spectrum occupied over space or time for the purpose of denying fair access to spectrum to other devices.

Please refer to the declaration letter which is saved with filename: declaration.pdf.

Issuing Laboratory:
Intertek Testing Services Hong Kong Limited

Hong Kong Accreditation Service (HKAS) has accredited this laboratory under the Hong Kong Laboratory Accreditation Scheme (HOKLAS) for specific laboratory activities as listed in the HOKLAS directory of accredited laboratories. The results shown in this report were determined by this laboratory in accordance with its terms of accreditation.



**EXHIBIT 5
EQUIPMENT LIST**

Issuing Laboratory:
Intertek Testing Services Hong Kong Limited

Hong Kong Accreditation Service (HKAS) has accredited this laboratory under the Hong Kong Laboratory Accreditation Scheme (HOKLAS) for specific laboratory activities as listed in the HOKLAS directory of accredited laboratories. The results shown in this report were determined by this laboratory in accordance with its terms of accreditation.



5.0 Equipment List

1) Radiated Emissions Test

Equipment	EMI Test Receiver	Spectrum Analyzer	Double Ridged Guide Antenna
Registration No.	EW-2500	EW-2188	EW-1015
Manufacturer	R&S	AGILENTTECH	EMCO
Model No.	ESCI	E4407B	3115
Calibration Date	Mar. 22, 2013	Nov. 5, 2012	Mar. 5, 2013
Calibration Due Date	Feb. 28, 2014	Nov. 5, 2013	Sep. 5, 2014

Equipment	Biconical Antenna	Log Periodic Antenna
Registration No.	EW-2512	EW-0447
Manufacturer	EMCO	EMCO
Model No.	3104C	3146
Calibration Date	Jun. 25, 2013	Aug. 19, 2013
Calibration Due Date	Dec. 25, 2014	Feb. 19, 2015

2) Conducted Emissions Test

Equipment	EMI Test Receiver	Artificial Mains	Pulse Limiter
Registration No.	EW-2500	EW-0192	EW-0700
Manufacturer	R&S	R&S	R&S
Model No.	ESCI	ESH3-Z5	ESH3-Z2
Calibration Date	Mar. 22, 2013	May 15, 2013	Jul. 30, 2013
Calibration Due Date	Feb. 28, 2014	Apr. 15, 2014	Jan. 30, 2014

3) Conductive Measurement Test

Equipment	Coaxial directional coupler	Spectrum Analyzer	Digital Radiocommunication Tester for DECT
Registration No.	EW-2337	EW-2466	EW-1739
Manufacturer	MAGNA	R&S	R&S
Model No.	4222-16	FSP30	CMD60
Calibration Date	Nil*	Aug. 4, 2013	Aug. 8, 2013
Calibration Due Date	Nil*	Aug. 4, 2014	Jul. 6, 2014

Equipment	Vector Signal Generator	Temperature & Humidity Chamber	Digital Multimeter
Registration No.	EW-2411	EW-2134	EW-1017
Manufacturer	R&S	GIANT FORCE	FLUKE
Model No.	SMU200A	GTH-750-40-CP-SD	87-IV
Calibration Date	Apr. 12, 2013	Sep. 3, 2013	Jun. 6, 2013
Calibration Due Date	Apr. 12, 2014	Aug. 31, 2014	Jul. 6, 2014

END OF TEST REPORT