

INTERTEK TESTING SERVICES

For Maximum Permissible Exposure (MPE) evaluation of the base unit, the maximum power density at 20 cm from this mobile transmitter shall be less than the General Population / Uncontrolled MPE limit in OET Bulletin 65 and meet the requirement listed in KDB447498.

The setup and equipment setting were made in accordance with ANSI C63.17. The antenna of EUT transmitter was replaced by a coaxial cable. The impedance matching of connection, cable loss and external RF attenuator are taken into account. The EUT was arranged to communicate via a fixed carrier frequency between its transmitter and a companion device. The transmission was configured in burst mode with pseudo-random data as typical as normal operation.

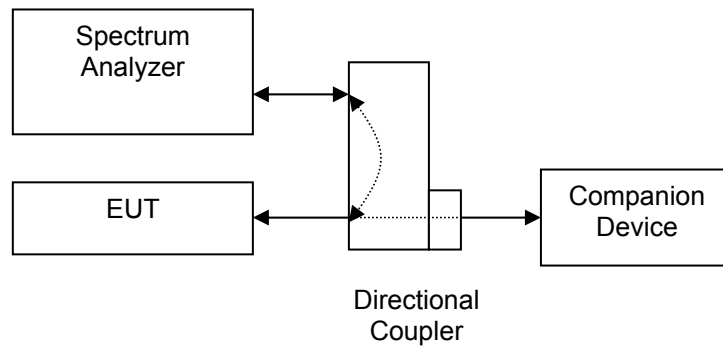

INTERTEK TESTING SERVICES

For the 1.9GHz DECT Transmission of tested model: DS6751-2, the measured powers among all the measured channels were within its production tolerance: +16 dBm (Minimum) and +21 dBm (Maximum). The antenna gain of DS6751-2 is 2 dBi = 1.58 (num gain) and its maximum source-based time-averaging duty factor is 25.0% (6/24 x100%). From these data and its operating configuration – Mobile device, the exposed power density at a distance (R) of 20cm from the center of radiation of the antenna can be calculated according to OET Bulletin 65 as follow:

$$\begin{aligned}\text{The Conducted Power} &= 21 \text{ dBm} \\ &= 125.9 \text{ mW}\end{aligned}$$

$$\begin{aligned}\text{The Conducted Power source-based time-averaging output power} & \\ &= (125.9 * 0.250) \text{ mW} \\ &= 31.47 \text{ mW}\end{aligned}$$

$$\begin{aligned}\text{The power density at 20cm} &= 31.47 * 1.58 / 4\pi R^2 \\ &= 0.0099 \text{ mW cm}^{-2}\end{aligned}$$

For the 2.4GHz Bluetooth Transmission of tested model: DS6751-2, the measured powers among all the measured channels were within its production tolerance: -6 dBm (Minimum) and +4 dBm (Maximum). The antenna gain of DS6751-2 is 0 dBi = 1.00 (num gain) and its maximum source-based time-averaging duty factor is 83.3% (5/6 x100%). From these data and its operating configuration – Mobile device, the exposed power density at a distance (R) of 20cm from the center of radiation of the antenna can be calculated according to OET Bulletin 65 as follow:

$$\begin{aligned}\text{The Conducted Power} &= 4 \text{ dBm} \\ &= 2.5 \text{ mW}\end{aligned}$$

$$\begin{aligned}\text{The Conducted Power source-based time-averaging output power} & \\ &= (2.5 * 0.833) \text{ mW} \\ &= 2.09 \text{ mW}\end{aligned}$$

$$\begin{aligned}\text{The power density at 20cm} &= 2.09 * 1.00 / 4\pi R^2 \\ &= 0.0004 \text{ mW cm}^{-2}\end{aligned}$$

INTERTEK TESTING SERVICES

Per KDB 447498 D01 v05, simultaneous transmission MPE test exclusion applies when the sum of the MPE ratios for all simultaneous transmitting antennas incorporated in a host device, based on calculated or measured field strengths or power density, is ≤ 1.0 .

The MPE ratio for DECT Transmission can be calculated as follow:

$$\begin{aligned} &= \text{The power density at 20cm} / \text{MPE limit} \\ &= 0.0099 \text{ mW cm}^{-2} / 1.0 \text{ mW cm}^{-2} \\ &= 0.0099 \end{aligned}$$

The MPE ratio for Bluetooth Transmission can be calculated as follow:

$$\begin{aligned} &= \text{The power density at 20cm} / \text{MPE limit} \\ &= 0.0004 \text{ mW cm}^{-2} / 1.0 \text{ mW cm}^{-2} \\ &= 0.0004 \end{aligned}$$

$$\begin{aligned} &\text{The sum of the MPE ratios for all simultaneous transmitting antennas} \\ &= 0.0099 + 0.0004 \\ &= 0.0103 \end{aligned}$$

As the sum of MPE ratios for all simultaneous transmitting antennas is ≤ 1.0 , simultaneous transmission MPE test exclusion will be applied.

Conclusion

In frequency range of 1,500 - 100,000MHz, the MPE limit is 1.0 mWcm^{-2} for general population and uncontrolled exposure. As simultaneous transmission MPE test exclusion is applied and the measured power density at 20cm from all the standalone transmissions is lower than the MPE limit, the compliance to the MPE limit can be ensured by indicating the minimum 20cm separation between the transmitter's radiating structures and body of the user or nearby persons.

The following RF exposure statement is proposed to be included in the user manual:

“ FCC RF Radiation Exposure Statement

Caution: To maintain compliance with the FCC's RF exposure guidelines, place the base unit at least 20cm from nearby persons.”