

Issuing Laboratory:
Intertek Testing Services Hong Kong Limited

Hong Kong Accreditation Service (HKAS) has accredited this laboratory under the Hong Kong Laboratory Accreditation Scheme (HOKLAS) for specific laboratory activities as listed in the HOKLAS directory of accredited laboratories. The results shown in this report were determined by this laboratory in accordance with its terms of accreditation.



TEST REPORT

Report Number: HK12070743-1

Application
For
Original Grant of 47 CFR Part 15 Certification
Unlicensed Personal Communication Service Devices

FCC ID: EW780-9041-00

Prepared and Checked by:

Approved by:



Koo Wai Ip
Senior Lead Engineer

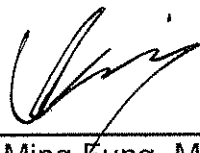

Nip Ming Fung, Melvin
Assistant Manager
August 03, 2012

- The test report only allows to be revised within the retention period unless further standard or the requirement was noticed.
- This report is for the exclusive use of Intertek's Client and is provided pursuant to the agreement between Intertek and its Client. Intertek's responsibility and liability are limited to the terms and conditions of the agreement. Intertek assumes no liability to any party, other than to the Client in accordance with the agreement, for any loss, expense or damage occasioned by the use of this report. Only the Client is authorized to permit copying or distribution of this report and then only in its entirety. Any use of the Intertek name or one of its marks for the sale or advertisement of the tested material, product or service must first be approved in writing by Intertek. The observations and test results in this report are relevant only to the sample tested. This report by itself does not imply that the material, product, or service is or has ever been under an Intertek certification program.

Intertek Testing Services Hong Kong Ltd.

2/F., Garment Centre, 576 Castle Peak Road, Kowloon, Hong Kong.
Tel: (852) 2173 8888 Fax: (852) 2785 5487 Website: www.hk.intertek-eltsemko.com

Issuing Laboratory:
Intertek Testing Services Hong Kong Limited

Hong Kong Accreditation Service (HKAS) has accredited this laboratory under the Hong Kong Laboratory Accreditation Scheme (HOKLAS) for specific laboratory activities as listed in the HOKLAS directory of accredited laboratories. The results shown in this report were determined by this laboratory in accordance with its terms of accreditation.



GENERAL INFORMATION

Applicant Name:	VTech Telecommunications Ltd.
Applicant Address:	23/F., Tai Ping Industrial Centre, Block 1, 57 Ting Kok Road, Tai Po, N.T., Hong Kong.
FCC Specification Standard:	FCC Part 15, October 1, 2010 Edition
FCC ID:	EW780-9041-00
FCC Model(s):	CS6199-4, CS619Z-XY
Type of EUT:	Unlicensed Personal Communications Service Devices
Description of EUT:	1.9GHz Digital Modulation Cordless Phone with Caller ID and Digital Answering Machine
Serial Number:	N/A
Sample Receipt Date:	July 17, 2012
Date of Test:	July 20 – 24, 2012
Report Date:	August 03, 2012
Environmental Conditions:	Temperature: +10 to 40°C Humidity: 10 to 90%

Issuing Laboratory:
Intertek Testing Services Hong Kong Limited

Hong Kong Accreditation Service (HKAS) has accredited this laboratory under the Hong Kong Laboratory Accreditation Scheme (HOKLAS) for specific laboratory activities as listed in the HOKLAS directory of accredited laboratories. The results shown in this report were determined by this laboratory in accordance with its terms of accreditation.



Table of Contents

1.0 Summary of Test Results & Statement of Compliance	5
1.1 Summary of Test Results	5
1.2 Statement of Compliance	6
2.0 General Description	8
2.1 Product Description	8
2.2 Technical Description	8
2.3 Test Methodology	9
2.4 Test Facility	9
3.0 System Test Configuration	11
3.1 Justification	11
3.1 Justification - Continued	12
3.2 Conducted Emission Test Configuration	13
3.3 Conducted Monitoring and Operational Test Configuration	13
3.4 EUT Exercising Software	13
3.5 Details of EUT and Description of Peripherals	14
3.6 Measurement Uncertainty	14
4.0 Measurement Results	16
4.1 Antenna Requirement	16
4.2 Digital Modulation Techniques	16
4.3 Emission Bandwidth	17
4.4 Directional Gain of the Antenna	20
4.5 Peak Transmit Power	21
4.6 Power Spectral Density	24
4.7 Automatic Discontinuation of Transmission	27
4.8 Unwanted Emission Inside the Sub-Band	28
4.9 Emissions Outside the Sub-Band	31
4.9.1 Radiated Emissions Configuration Photographs	32
4.9.2 Radiated Emissions Data	32
4.9.3 Field Strength Calculation	39
4.9.4 Average Factor Calculation and Transmitter ON Time Measurements	40
4.10 AC Power Line Conducted Emissions	41
4.10.1 AC Power Line Conducted Emissions Configuration Photographs	42
4.10.2 AC Power Line Conducted Emissions Data	42
4.11 Radio Frequency Radiation Exposure	45
4.12 Frame Repetition Stability	46
4.13 Frame Period and Jitter	47
4.14 Carrier Frequency Stability	48

Issuing Laboratory:
Intertek Testing Services Hong Kong Limited

Hong Kong Accreditation Service (HKAS) has accredited this laboratory under the Hong Kong Laboratory Accreditation Scheme (HOKLAS) for specific laboratory activities as listed in the HOKLAS directory of accredited laboratories. The results shown in this report were determined by this laboratory in accordance with its terms of accreditation.



Table of Contents

4.15 Monitoring Threshold.....	50
4.15.1 Lower Monitoring Threshold	51
4.15.2 Least Interfered Channel	52
4.15.2.1 Upper Monitoring Threshold.....	52
4.15.2.2 Least Interfered Channel (LIC) Selection	53
4.15.2.3 Least Interfered Channel (LIC) Confirmation.....	56
4.15.2.4 Maximum Spectrum Occupance	56
4.16 Monitoring Time.....	57
4.17 Maximum Transmit Period.....	58
4.18 System Acknowledgement	59
4.19 Random Waiting.....	61
4.20 Monitoring Bandwidth	62
4.21 Maximum Reaction Time.....	64
4.22 Monitoring Antenna	65
4.23 Duplex Connections	66
4.24 Alternative Monitoring Interval for Co-located Device.....	69
4.25 Fair Access.....	70
5.0 Equipment List	71

Issuing Laboratory:
Intertek Testing Services Hong Kong Limited

Hong Kong Accreditation Service (HKAS) has accredited this laboratory under the Hong Kong Laboratory Accreditation Scheme (HOKLAS) for specific laboratory activities as listed in the HOKLAS directory of accredited laboratories. The results shown in this report were determined by this laboratory in accordance with its terms of accreditation.



EXHIBIT 1

SUMMARY OF TEST RESULTS & STATEMENT OF COMPLIANCE

Issuing Laboratory:
Intertek Testing Services Hong Kong Limited

Hong Kong Accreditation Service (HKAS) has accredited this laboratory under the Hong Kong Laboratory Accreditation Scheme (HOKLAS) for specific laboratory activities as listed in the HOKLAS directory of accredited laboratories. The results shown in this report were determined by this laboratory in accordance with its terms of accreditation.



1.0 Summary of Test Results & Statement of Compliance

1.1 Summary of Test Results

General Technical Requirements				
Test Items	FCC Part 15 Section	Test Procedure ANSI C63.17 / ANSI C63.4 *	Results	Details see section
Antenna Requirement	15.317	---	Pass	4.1
Digital Modulation Techniques	15.319(b)	6.1.4	Pass	4.2
Occupied/Emission Bandwidth	15.323(a)	6.1.3	Pass	4.3
Directional Gain of the Antenna	15.319(e)	4.3.1	Pass	4.4
Peak Transmit Power	15.319(c)	6.1.2	Pass	4.5
Power Spectral Density	15.319(d)	6.1.5	Pass	4.6
Automatic Discontinuation of Transmission	15.319(f)	---	Pass	4.7
AC Power Line Conducted Emissions from EUT	15.315	7 *	Pass	4.10
Radio Frequency Radiation Exposure	15.319(i)	---	Pass	4.11
Security Code Information	15.214	---	Pass	2.2

Issuing Laboratory:
Intertek Testing Services Hong Kong Limited

Hong Kong Accreditation Service (HKAS) has accredited this laboratory under the Hong Kong Laboratory Accreditation Scheme (HOKLAS) for specific laboratory activities as listed in the HOKLAS directory of accredited laboratories. The results shown in this report were determined by this laboratory in accordance with its terms of accreditation.



1.1 Summary of Test Results (continued)

Specific Requirements for UPCS Device				
Test Items	FCC Part 15 Section	Test Procedure ANSI C63.17	Results	Details see section
Unwanted Emission Inside the Sub-Band	15.323(d)	6.1.6.1	Pass	4.8
Emissions Outside the Sub-Band	15.323(d)	6.1.6.2	Pass	4.9
Frame Repetition Stability	15.323(e)	6.2.2	Pass	4.12
Frame Period and Jitter	15.323(e)	6.2.3	Pass	4.13
Carrier Frequency Stability	15.323(f)	6.2.1	Pass	4.14
Lower Monitoring Threshold	15.323(c2&c9)	7.3.1	NA	4.15.1
Upper Monitoring Threshold	15.323(c5.1&c9)	7.3.2	Pass	4.15.2.1
Least Interfered Channel (LIC) Selection	15.323(c)(5)	7.3.3	Pass	4.15.2.2
Least Interfered Channel (LIC) Confirmation	15.323(c)(5)	7.3.3	Pass	4.15.2.3
Maximum Spectrum Occupancy	15.323(c)(5)	---	Pass	4.15.2.4
Monitoring Time	15.323(c)(1)	7.3.4	Pass	4.16
Maximum Transmit Period	15.323(c)(3)	---	Pass	4.17
System Acknowledgement	15.323(c4)	8.1 or 8.2	Pass	4.18
Random Waiting	15.323(c)(6)	8.1.2 or 8.1.3	Pass	4.19
Monitoring Bandwidth	15.323(c)(7)	7.4	Pass	4.20
Maximum Reaction Time	15.323(c)(7)	7.5	Pass	4.21
Monitoring Antenna	15.323(c)(8)	4	Pass	4.22
Duplex Connections	15.323(c)(10)	8.3	Pass	4.23
Alternative Monitoring Interval for Co-located Device	15.323(c)(11)	8.4	NA	4.24
Fair Access	15.323(c)(12)	---	Pass	4.25

1.2 Statement of Compliance

The equipment under test is found to be complying with the following standards:

FCC Part 15, October 1, 2010 Edition

Issuing Laboratory:
Intertek Testing Services Hong Kong Limited

Hong Kong Accreditation Service (HKAS) has accredited this laboratory under the Hong Kong Laboratory Accreditation Scheme (HOKLAS) for specific laboratory activities as listed in the HOKLAS directory of accredited laboratories. The results shown in this report were determined by this laboratory in accordance with its terms of accreditation.



EXHIBIT 2 GENERAL DESCRIPTION

Issuing Laboratory:
Intertek Testing Services Hong Kong Limited

Hong Kong Accreditation Service (HKAS) has accredited this laboratory under the Hong Kong Laboratory Accreditation Scheme (HOKLAS) for specific laboratory activities as listed in the HOKLAS directory of accredited laboratories. The results shown in this report were determined by this laboratory in accordance with its terms of accreditation.



2.0 General Description

2.1 Product Description

The CS6199-4 is a 1.9GHz Digital Modulation Cordless Phone with Caller ID and Digital Answering Machine. It operates at frequency range of 1921.536MHz to 1928.448MHz with 5 channels (1921.536MHz, 1923.264MHz, 1924.992MHz, 1926.720MHz and 1928.448MHz). The Base Unit is powered by an adaptor 100-120VAC to 6VDC 400mA. The Handset is powered by a "Ni-MH" type rechargeable battery pack (2.4V, 300mAh).

The antennas used in base unit and handset are integral, and the test sample is a prototype.

The Model(s): CS619Z-XY is the same as the Model: CS6199-4 in electrical designs, including software & firmware, PCB layout and construction design/Physical design/Enclosure. The only differences between these models are color, model number, package material and number of handset and extra charger, to be sold for marketing purpose. Suffix (X) indicates any alphanumeric character or blank is presenting number of Handset and extra Charger. Suffix (Y) indicates any alphanumeric character or blank is presenting different color of enclosure. Suffix (Z) indicates any alphanumeric character is presenting different package material.

Connection between the device and the telephone network is accomplished through the use of USOC RJ11C in the 2-wire loop calling central office line.

2.2 Technical Description

The circuit description and digital modulation techniques description are saved with filename: descri.pdf.

Issuing Laboratory:
Intertek Testing Services Hong Kong Limited

Hong Kong Accreditation Service (HKAS) has accredited this laboratory under the Hong Kong Laboratory Accreditation Scheme (HOKLAS) for specific laboratory activities as listed in the HOKLAS directory of accredited laboratories. The results shown in this report were determined by this laboratory in accordance with its terms of accreditation.



2.3 Test Methodology

The radiated emission measurements for unintentional radiator (if any) and AC power line-conducted emission measurements were performed according to the test procedures specified in ANSI C63.4 (2009). The radiated emission measurements for intentional radiator contained in UPCS device, conducted emission measurements, Listen Before Transmit (LBT) tests, Time Frame and Frequency Stability tests were performed according to the test procedures specified in ANSI C63.17 (2006). All radiated measurements were performed in Open Area Test Sites. Preliminary scans were performed in the Open Area Test Sites only to determine worst case modes. All radiated tests were performed at an antenna to EUT distance of 3 meters, unless stated otherwise in the "Justification Section" of this Application. All other measurements were made in accordance with the procedures in 47 CFR Part 2

2.4 Test Facility

The open area test site and conducted measurement facility used to collect the emission data is located at Garment Centre, 576 Castle Peak Road, Kowloon, Hong Kong. This test facility and site measurement data have been fully placed on file with the FCC.

Issuing Laboratory:
Intertek Testing Services Hong Kong Limited

Hong Kong Accreditation Service (HKAS) has accredited this laboratory under the Hong Kong Laboratory Accreditation Scheme (HOKLAS) for specific laboratory activities as listed in the HOKLAS directory of accredited laboratories. The results shown in this report were determined by this laboratory in accordance with its terms of accreditation.



EXHIBIT 3 SYSTEM TEST CONFIGURATION

Issuing Laboratory:
Intertek Testing Services Hong Kong Limited

Hong Kong Accreditation Service (HKAS) has accredited this laboratory under the Hong Kong Laboratory Accreditation Scheme (HOKLAS) for specific laboratory activities as listed in the HOKLAS directory of accredited laboratories. The results shown in this report were determined by this laboratory in accordance with its terms of accreditation.



3.0 **System Test Configuration**

3.1 Justification

For emissions testing, the equipment under test (EUT) was set up to transmit continuously in burst mode with pseudo-random data to simplify the measurement methodology. Care was taken to ensure proper power supply voltages during testing. During testing, all cables (if any) were manipulated to produce worst-case emissions.

The Base Unit was powered by a 100-120VAC to 6VDC 400mA adaptor. The handset was powered by a fully charged battery.

For the measurements, the EUT was attached to a plastic stand if necessary and placed on the wooden turntable. If the base unit attached to accessories, they were connected and operational (as typical as possible).

The signal was maximized through rotation and placement in the three orthogonal axes. The antenna height and polarization were varied during the search for maximum signal level. The antenna height was varied from 1 to 4 meters. Detector function was in peak mode. Radiated emissions are taken at three meters unless the signal level was too low for measurement at that distance. If necessary, a pre-amplifier was used and/or the test was conducted at a closer distance.

For UPCS transmitter radiated measurement, the spectrum analyzer resolution bandwidth was approximately 1% of EUT emission bandwidth, unless otherwise specified.

Radiated emission measurements for UPCS transmitter were performed from the lowest radio frequency signal generated in the device which is greater than 9 kHz to the tenth harmonic of the highest fundamental frequency or to 40 GHz, whichever is lower.

As the base unit has 2 antennas, both have been checked. While conducting the test on one of antennas, another one was being disabled its transmission. The data in this report represented the worst-case.

Issuing Laboratory:
Intertek Testing Services Hong Kong Limited

Hong Kong Accreditation Service (HKAS) has accredited this laboratory under the Hong Kong Laboratory Accreditation Scheme (HOKLAS) for specific laboratory activities as listed in the HOKLAS directory of accredited laboratories. The results shown in this report were determined by this laboratory in accordance with its terms of accreditation.



3.1 Justification - Continued

For AC line conducted emission test, the EUT along with its peripherals were placed on a 1.0m(W)x1.5m(L) and 0.8m in height wooden table and the EUT was adjusted to maintain a 0.4 meter space from a vertical reference plane. The EUT was connected to power mains through a line impedance stabilization network (LISN), which provided 50ohm coupling impedance for measuring instrument. The LISN housing, measuring instrument case, reference ground plane, and vertical ground plane were bounded together. The excess power cable between the EUT and the LISN was bundled.

All connecting cables of EUT and peripherals were manipulated to find the maximum emission.

3.2 Conducted Emission Test Configuration

The setup and equipment setting were made in accordance with ANSI C63.17. The antenna of EUT transmitter was replaced by a coaxial cable. The impedance matching of connection, cable loss and external RF attenuator are taken into account. The EUT was arranged to communicate via a fixed carrier frequency between its transmitter and a companion device. The transmission was configured in burst mode with pseudo-random data as typical as normal operation.

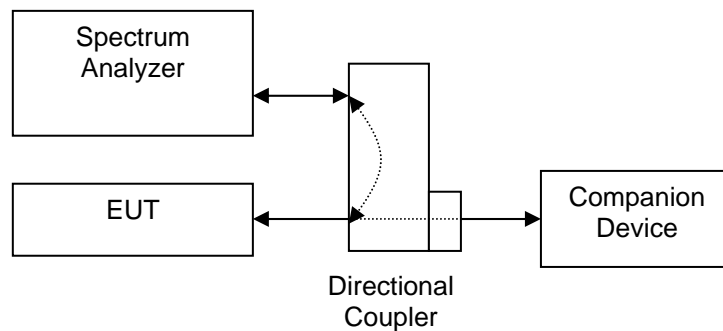

Figure 3.2.1

3.3 Conducted Monitoring and Operational Test Configuration

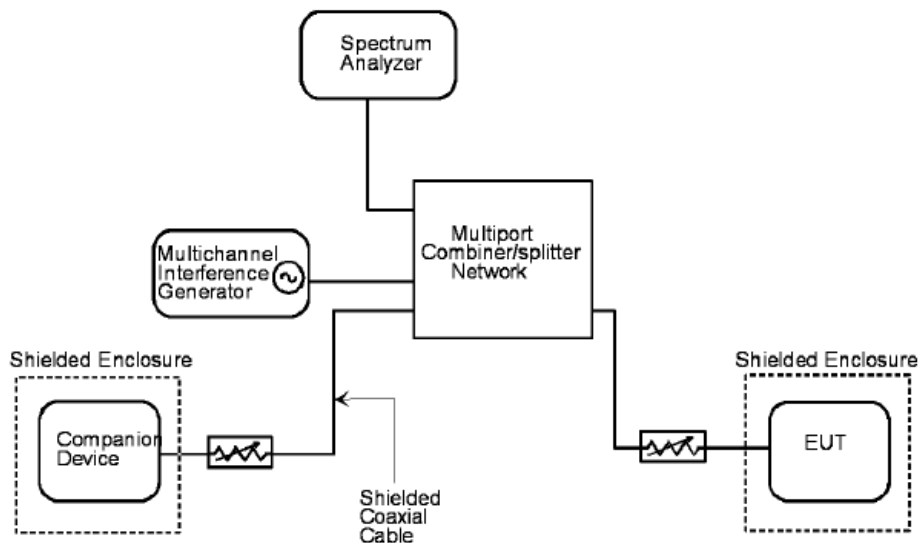

Figure 3.3.1

3.4 EUT Exercising Software

The EUT exercise program (if any) used during radiated and conducted testing was designed to exercise the various system components in a manner similar to a typical use.

Issuing Laboratory:
Intertek Testing Services Hong Kong Limited

Hong Kong Accreditation Service (HKAS) has accredited this laboratory under the Hong Kong Laboratory Accreditation Scheme (HOKLAS) for specific laboratory activities as listed in the HOKLAS directory of accredited laboratories. The results shown in this report were determined by this laboratory in accordance with its terms of accreditation.



3.5 Details of EUT and Description of Accessories

Details of EUT:

An AC adaptor and/or a battery (provided with the unit) were used to power the device. Their description are listed below.

- (1) Base Unit: An AC adaptor (100-120VAC to 6VDC 400mA, Model: S005IU0600040, Brand: Ten Pao) (Supplied by Client)
- (2) Handset: A "Ni-MH" type rechargeable battery pack (2.4V, 300mAh) (Supplied by Client)

Description of Accessories:

- (1) Telephone Line Simulator, Model: TLS-5D-01, S/N: 151101 (Supplied by Intertek)
- (2) 3m Telephone Line (Supplied by Intertek)
- (3) 1m Telephone Line with Termination (Supplied by Intertek)

3.6 Measurement Uncertainty

When determining of the test conclusion, the Measurement Uncertainty of test has been considered.

Issuing Laboratory:
Intertek Testing Services Hong Kong Limited

Hong Kong Accreditation Service (HKAS) has accredited this laboratory under the Hong Kong Laboratory Accreditation Scheme (HOKLAS) for specific laboratory activities as listed in the HOKLAS directory of accredited laboratories. The results shown in this report were determined by this laboratory in accordance with its terms of accreditation.



EXHIBIT 4 MEASUREMENT RESULTS

Issuing Laboratory:
Intertek Testing Services Hong Kong Limited

Hong Kong Accreditation Service (HKAS) has accredited this laboratory under the Hong Kong Laboratory Accreditation Scheme (HOKLAS) for specific laboratory activities as listed in the HOKLAS directory of accredited laboratories. The results shown in this report were determined by this laboratory in accordance with its terms of accreditation.



4.0 **Measurement Results**

4.1 Antenna Requirement, FCC Rule 15.317 :

EUT must meet the antenna requirement of FCC Rule 15.203.

EUT uses permanently attached antenna(s) which is considered sufficient to comply with the provisions of this rule. Please refer to internal photos for more details.

EUT uses unique antenna jack(s) or electrical connector(s) which is considered sufficient to comply with the provisions of this rule. Please refer to internal photos for more details.

4.2 Digital Modulation Techniques, FCC Rule 15.319(b):

All transmissions must use only digital modulation techniques.

The requirements are made in accordance with ANSI C63.17 sub-clause 6.1.4.

Attestation:

Please refer to the technical description (descri.pdf) or relevant DECT standards for more details.

Issuing Laboratory:
Intertek Testing Services Hong Kong Limited

Hong Kong Accreditation Service (HKAS) has accredited this laboratory under the Hong Kong Laboratory Accreditation Scheme (HOKLAS) for specific laboratory activities as listed in the HOKLAS directory of accredited laboratories. The results shown in this report were determined by this laboratory in accordance with its terms of accreditation.



4.3 Emission Bandwidth, FCC Rule 15.323(a) :

Operation shall be contained within the 1920 – 1930 MHz band. The emission bandwidth (*B*) shall be less than 2.5 MHz and greater than 50 kHz.

Measurements are made in accordance with ANSI C63.17 sub-clause 6.1.3. Test setup is shown in section 3.2 Figure 3.2.1.

Test Results:

I. Base unit - Traffic Carrier

Channel	Channel Frequency (MHz)	Measuring Signal Level	Measured Emission Bandwidth (MHz)	Results
Lowest	1921.536	26 dB down	1.51	Pass
Highest	1928.448	26 dB down	1.50	Pass

II. Handset - Traffic Carrier

Channel	Channel Frequency (MHz)	Measuring Signal Level	Measured Emission Bandwidth (MHz)	Results
Lowest	1921.536	26 dB down	1.51	Pass
Highest	1928.448	26 dB down	1.50	Pass

The plots of emission bandwidth are saved as below.

Issuing Laboratory:
Intertek Testing Services Hong Kong Limited

Hong Kong Accreditation Service (HKAS) has accredited this laboratory under the Hong Kong Laboratory Accreditation Scheme (HOKLAS) for specific laboratory activities as listed in the HOKLAS directory of accredited laboratories. The results shown in this report were determined by this laboratory in accordance with its terms of accreditation.



Plots of emission bandwidth

Base unit, Lowest channel, Traffic carrier

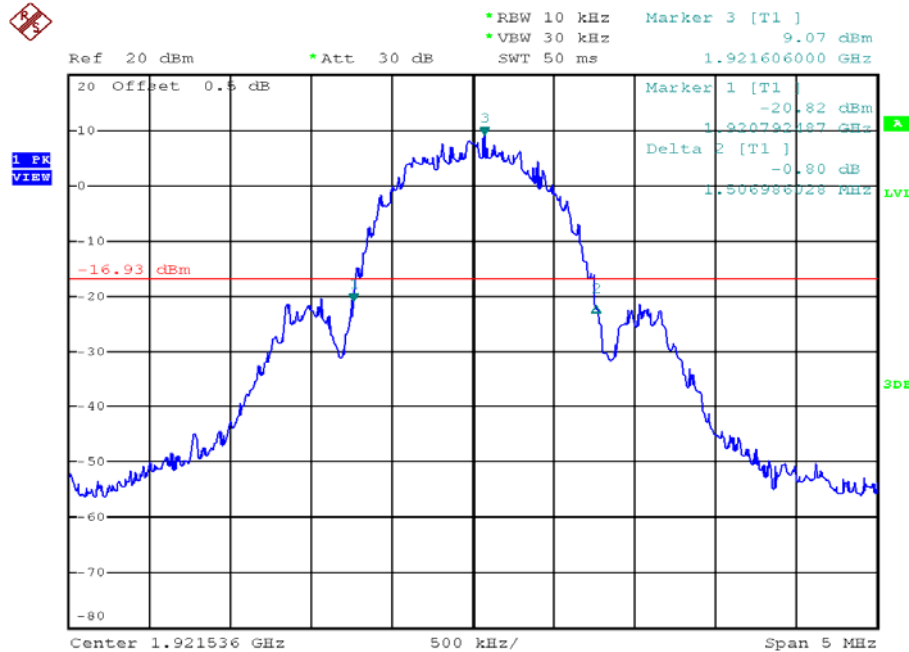

Base unit, Highest channel, Traffic carrier

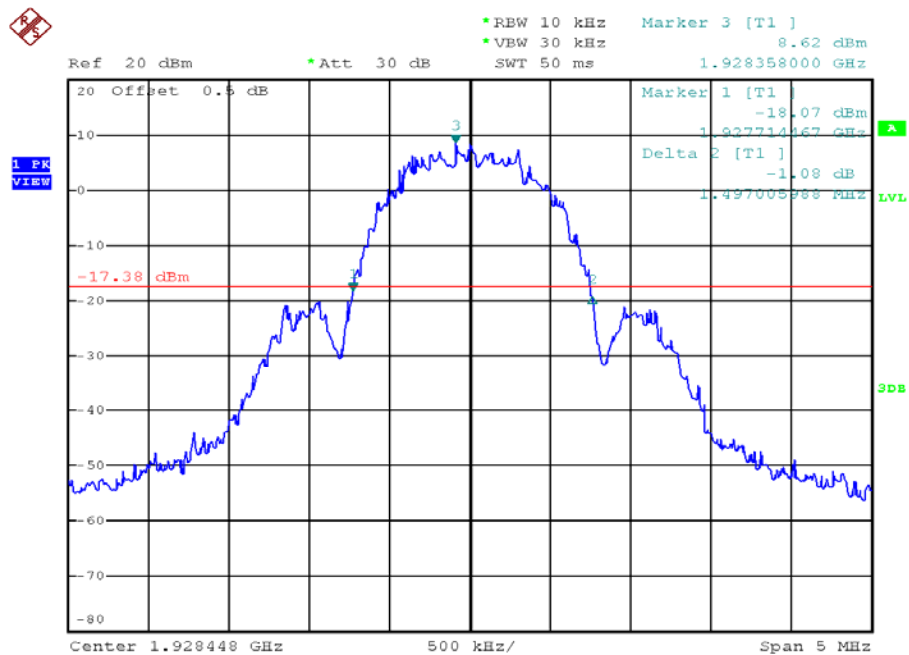

Issuing Laboratory:
Intertek Testing Services Hong Kong Limited

Hong Kong Accreditation Service (HKAS) has accredited this laboratory under the Hong Kong Laboratory Accreditation Scheme (HOKLAS) for specific laboratory activities as listed in the HOKLAS directory of accredited laboratories. The results shown in this report were determined by this laboratory in accordance with its terms of accreditation.



Handset unit, Lowest channel, Traffic carrier

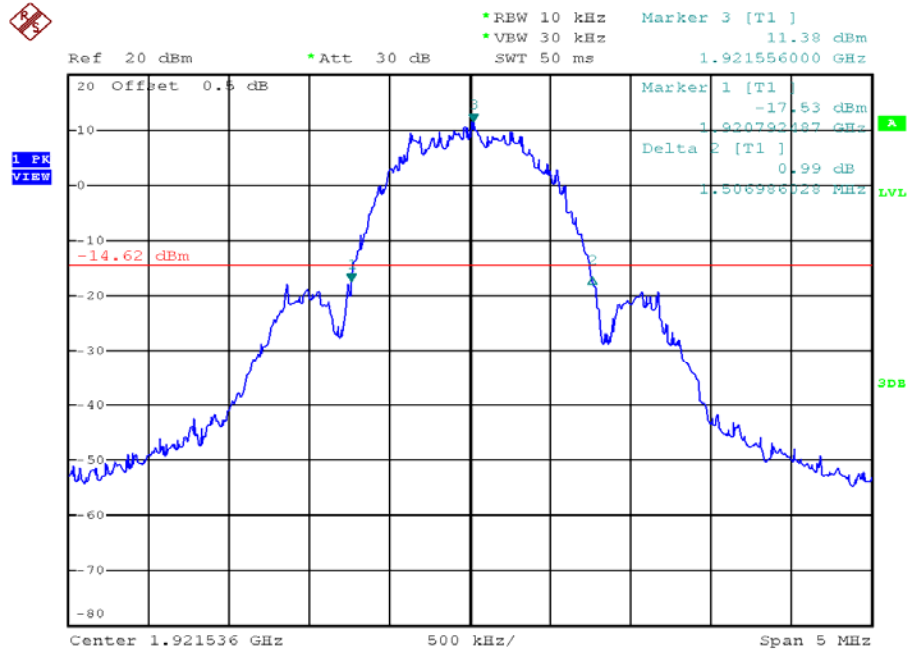

Handset unit, Highest channel, Traffic carrier

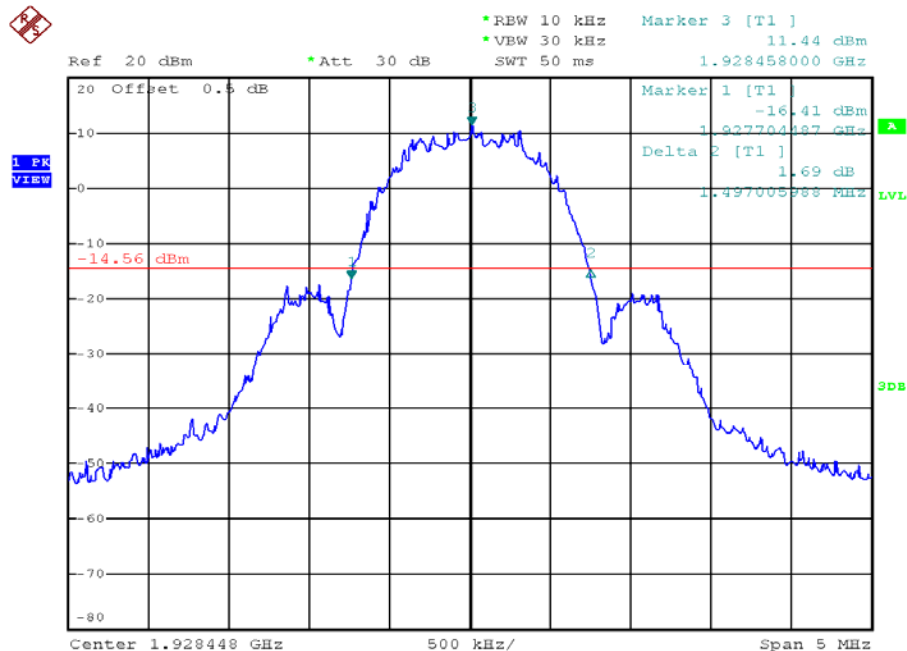

Issuing Laboratory:
Intertek Testing Services Hong Kong Limited

Hong Kong Accreditation Service (HKAS) has accredited this laboratory under the Hong Kong Laboratory Accreditation Scheme (HOKLAS) for specific laboratory activities as listed in the HOKLAS directory of accredited laboratories. The results shown in this report were determined by this laboratory in accordance with its terms of accreditation.



4.4 Directional Gain of the Antenna, FCC Rule FCC 15.319(e):

The peak transmit power shall be reduced by the amount in dB that the maximum directional gain of the antenna exceeds 3 dBi.

The requirements are made in accordance with ANSI C63.17 sub-clause 4.3.1.

- Manufacturer declares that the directional gain of the antenna is less than or equal to 3dBi. No peak transmit power reduction is required.
- Manufacturer declares that the directional gain of the antenna is greater than 3dBi. The peak transmit power shall be reduced by _____ dB.

4.5 Peak Transmit Power, FCC Rule 15.319(c):

The peak transmit power (P_{EUT}) shall not exceed $100\mu W$ multiplied by the square root of the emission bandwidth (B) in Hz or $5 \log_{10} B - 10$ dBm. The peak transmit power shall be reduced by the amount in dB that the maximum directional gain of the antenna exceeds 3 dBi.

Measurements are made in accordance with ANSI C63.17 sub-clause 6.1.2. Test setup is shown in section 3.2 Figure 3.2.1. The cable loss and/or external attenuation are included in OFFSET function of spectrum analyzer.

Calculation of Peak Transmit Power Limit (P_{max}):

$$\begin{aligned} [\times] \quad P_{max} &= 5 \log_{10} B - 10 \text{ dBm} && \text{when } G_A \leq 3\text{dBi} \\ [\quad] \quad P_{max} &= 5 \log_{10} B - 10 \text{ dBm} - (G_A - 3\text{dBi}) && \text{when } G_A > 3\text{dBi} \end{aligned}$$

Where G_A = EUT Antenna Gain: 0 dBi for Base Unit
 = EUT Antenna Gain: 0 dBi for Handset
 B = Measured Emission Bandwidth

Test Results:

I. Base unit - Traffic Carrier

Channel	Channel Frequency (MHz)	Measured Peak Transmit Power (dBm)	Limit (dBm)	Results
Lowest	1921.536	17.46	20.89	Pass
Highest	1928.448	17.70	20.88	Pass

II. Handset - Traffic Carrier

Channel	Channel Frequency (MHz)	Measured Peak Transmit Power (dBm)	Limit (dBm)	Results
Lowest	1921.536	19.96	20.89	Pass
Highest	1928.448	19.96	20.88	Pass

The plots of peak transmit power are saved as below.

Issuing Laboratory:
Intertek Testing Services Hong Kong Limited

Hong Kong Accreditation Service (HKAS) has accredited this laboratory under the Hong Kong Laboratory Accreditation Scheme (HOKLAS) for specific laboratory activities as listed in the HOKLAS directory of accredited laboratories. The results shown in this report were determined by this laboratory in accordance with its terms of accreditation.



Plots of peak transmit power

Base unit, Lowest channel, Traffic carrier

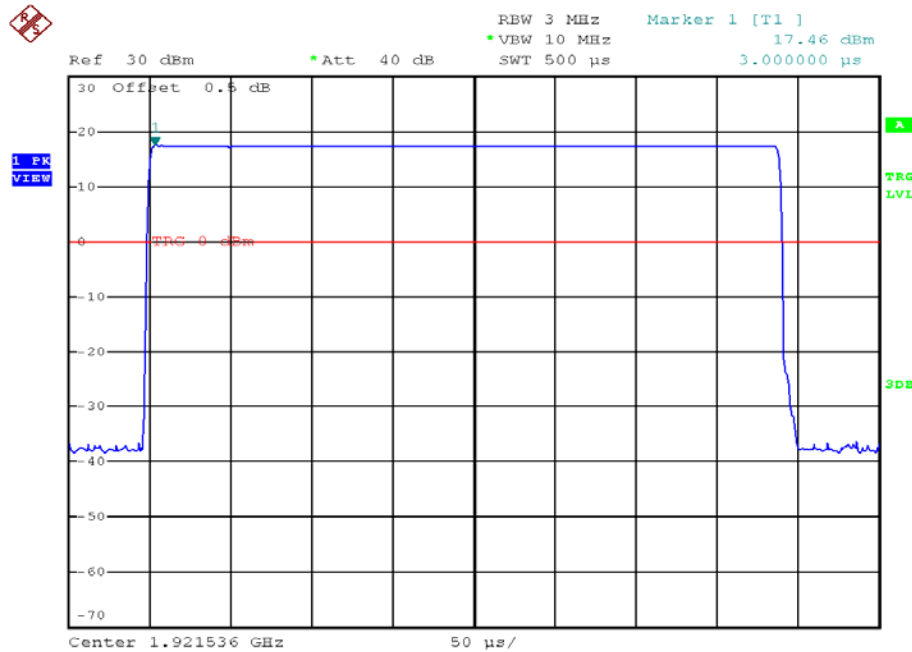

Base unit, Highest channel, Traffic carrier

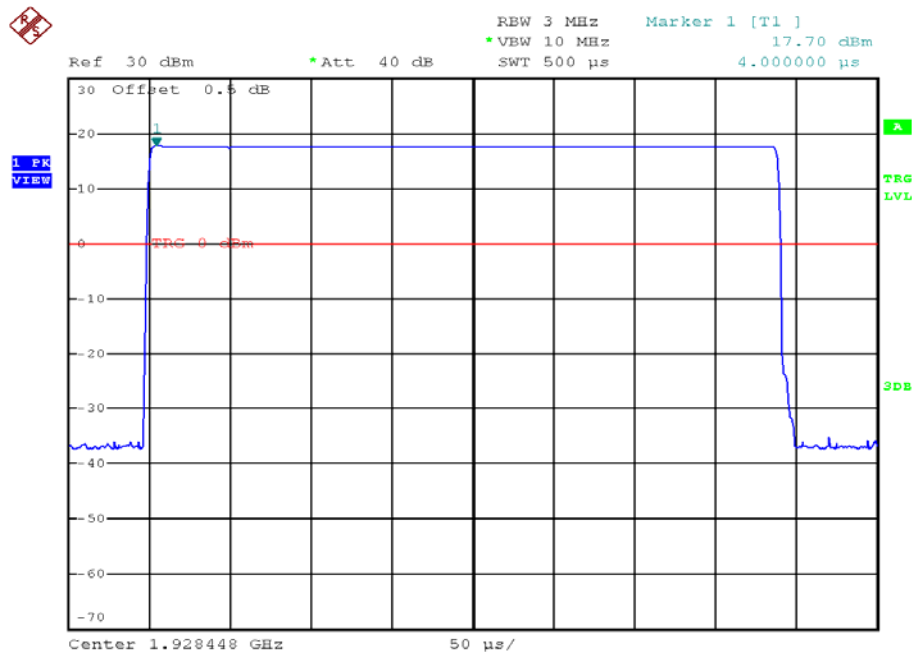

Issuing Laboratory:
Intertek Testing Services Hong Kong Limited

Hong Kong Accreditation Service (HKAS) has accredited this laboratory under the Hong Kong Laboratory Accreditation Scheme (HOKLAS) for specific laboratory activities as listed in the HOKLAS directory of accredited laboratories. The results shown in this report were determined by this laboratory in accordance with its terms of accreditation.



Handset unit, Lowest channel, Traffic carrier

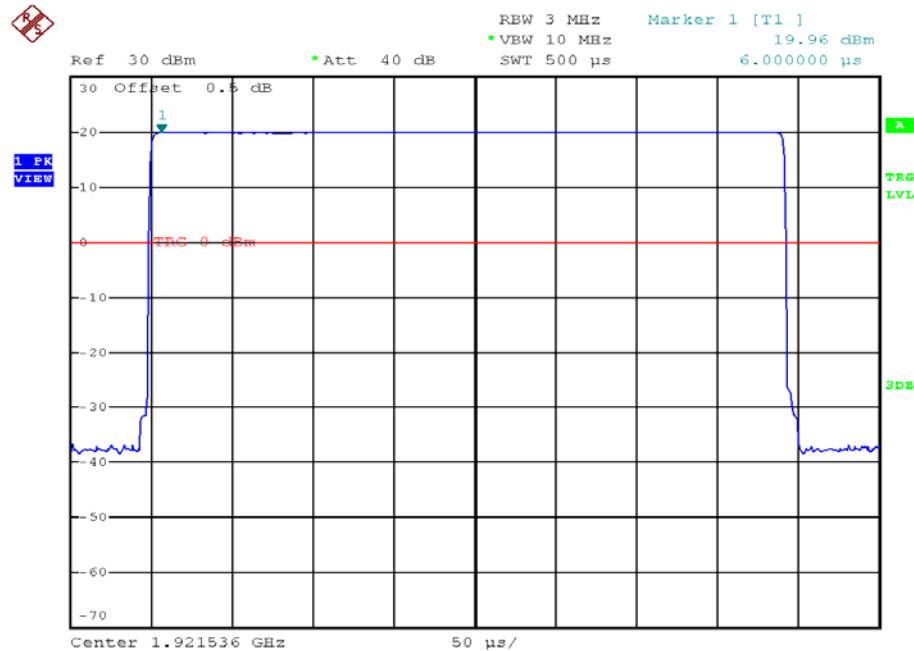

Handset unit, Highest channel, Traffic carrier



Issuing Laboratory:
Intertek Testing Services Hong Kong Limited

Hong Kong Accreditation Service (HKAS) has accredited this laboratory under the Hong Kong Laboratory Accreditation Scheme (HOKLAS) for specific laboratory activities as listed in the HOKLAS directory of accredited laboratories. The results shown in this report were determined by this laboratory in accordance with its terms of accreditation.



4.6 Power Spectral Density, FCC Rule 15.319(d):

Power spectral density shall not exceed 3 mW (4.8dBm) in any 3 kHz bandwidth as measured with a spectrum analyzer having a resolution bandwidth of 3 kHz.

Measurements are made in accordance with ANSI C63.17 sub-clause 6.1.5. Test setup is shown in section 3.2 Figure 3.2.1.

Test Results:

I. Base unit - Traffic Carrier

Channel	Channel Frequency (MHz)	Measured Power Spectral Density (dBm/3kHz)	Limit (dBm/3 kHz)	Results
Lowest	1921.536	-13.14	4.8	Pass
Highest	1928.448	-12.08	4.8	Pass

II. Handset - Traffic Carrier

Channel	Channel Frequency (MHz)	Measured Power Spectral Density (dBm/3kHz)	Limit (dBm/3 kHz)	Results
Lowest	1921.536	-6.54	4.8	Pass
Highest	1928.448	-3.77	4.8	Pass

The plots of the power spectral density are saved as below.

Issuing Laboratory:
Intertek Testing Services Hong Kong Limited

Hong Kong Accreditation Service (HKAS) has accredited this laboratory under the Hong Kong Laboratory Accreditation Scheme (HOKLAS) for specific laboratory activities as listed in the HOKLAS directory of accredited laboratories. The results shown in this report were determined by this laboratory in accordance with its terms of accreditation.



Plots of the power spectral density

Base unit, Lowest channel, Traffic carrier

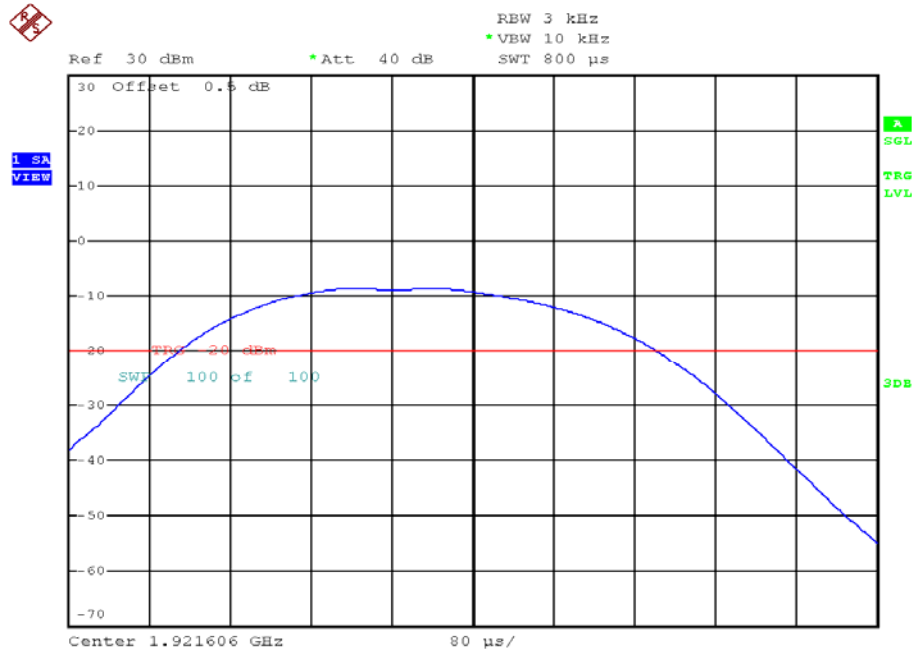

Base unit, Highest channel, Traffic carrier

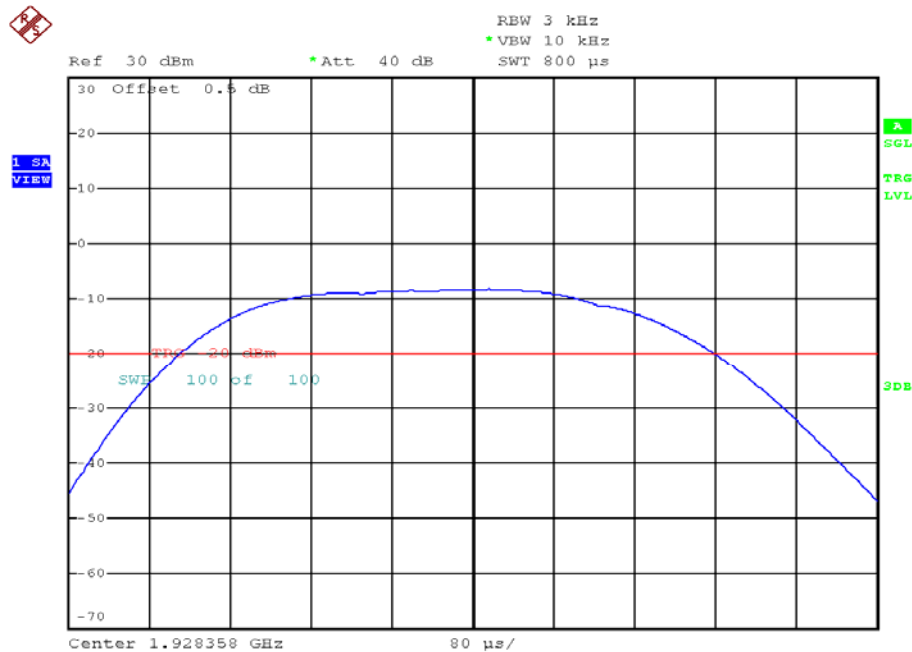

Issuing Laboratory:
Intertek Testing Services Hong Kong Limited

Hong Kong Accreditation Service (HKAS) has accredited this laboratory under the Hong Kong Laboratory Accreditation Scheme (HOKLAS) for specific laboratory activities as listed in the HOKLAS directory of accredited laboratories. The results shown in this report were determined by this laboratory in accordance with its terms of accreditation.



Handset unit, Lowest channel, Traffic carrier

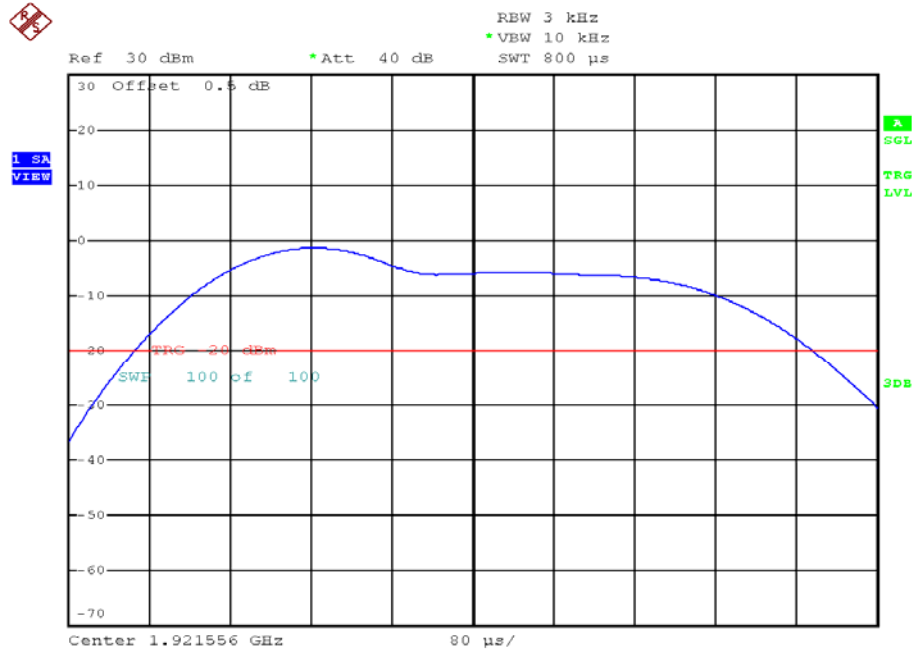

Handset unit, Highest channel, Traffic carrier

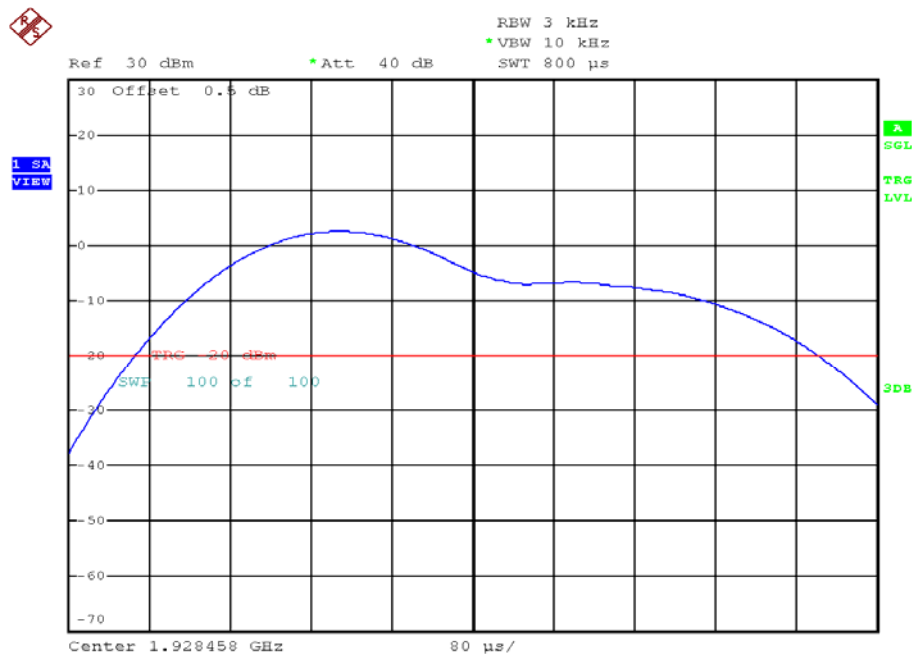

Issuing Laboratory:
Intertek Testing Services Hong Kong Limited

Hong Kong Accreditation Service (HKAS) has accredited this laboratory under the Hong Kong Laboratory Accreditation Scheme (HOKLAS) for specific laboratory activities as listed in the HOKLAS directory of accredited laboratories. The results shown in this report were determined by this laboratory in accordance with its terms of accreditation.



4.7 Automatic Discontinuation of Transmission, FCC Rule 15.319(f) :

The EUT shall automatically discontinue transmission in case of either absence of information to transmit or operational failure. These provisions are not intended to preclude transmission of control and signaling information or use of repetitive codes used by certain digital technologies to complete frame or burst intervals.

The manufacturer declares that the EUT can automatically discontinue transmission in case of either absent information to transmit or operational failure. Please refer to the declaration letter for details, which is saved with filename: declaration.pdf.

Issuing Laboratory:
Intertek Testing Services Hong Kong Limited

Hong Kong Accreditation Service (HKAS) has accredited this laboratory under the Hong Kong Laboratory Accreditation Scheme (HOKLAS) for specific laboratory activities as listed in the HOKLAS directory of accredited laboratories. The results shown in this report were determined by this laboratory in accordance with its terms of accreditation.



4.8 Unwanted Emission Inside the Sub-Band, FCC Rule 15.323(d):

Emissions inside the sub-band must comply with the following emission mask:

1. In the bands between $1B$ and $2B$ measured from the center of the emission bandwidth, emission shall be at least 30 dB below the permitted peak transmit power.
2. In the bands between $2B$ and $3B$ measured from the center of the emission bandwidth, emission shall be at least 50 dB below the permitted peak transmit power.
3. In the bands between $3B$ and the band edge, emission shall be at least 60 dB below the permitted peak transmit power.

Where B = emission bandwidth in Hz

Measurements are made in accordance with ANSI C63.17 sub-clause 6.1.6.1. Test setup is shown in section 3.2 Figure 3.2.1.

Test Results:

I. Base unit - Traffic Carrier

Channel	Channel Frequency (MHz)	Results
Lowest	1921.536	Pass
Highest	1928.448	Pass

II. Handset - Traffic Carrier

Channel	Channel Frequency (MHz)	Results
Lowest	1921.536	Pass
Highest	1928.448	Pass

The plots of the unwanted emission inside the sub-band are saved as below.

Issuing Laboratory:
Intertek Testing Services Hong Kong Limited

Hong Kong Accreditation Service (HKAS) has accredited this laboratory under the Hong Kong Laboratory Accreditation Scheme (HOKLAS) for specific laboratory activities as listed in the HOKLAS directory of accredited laboratories. The results shown in this report were determined by this laboratory in accordance with its terms of accreditation.



Plots of the unwanted emission inside the sub-band

Base unit, Lowest channel, Traffic carrier

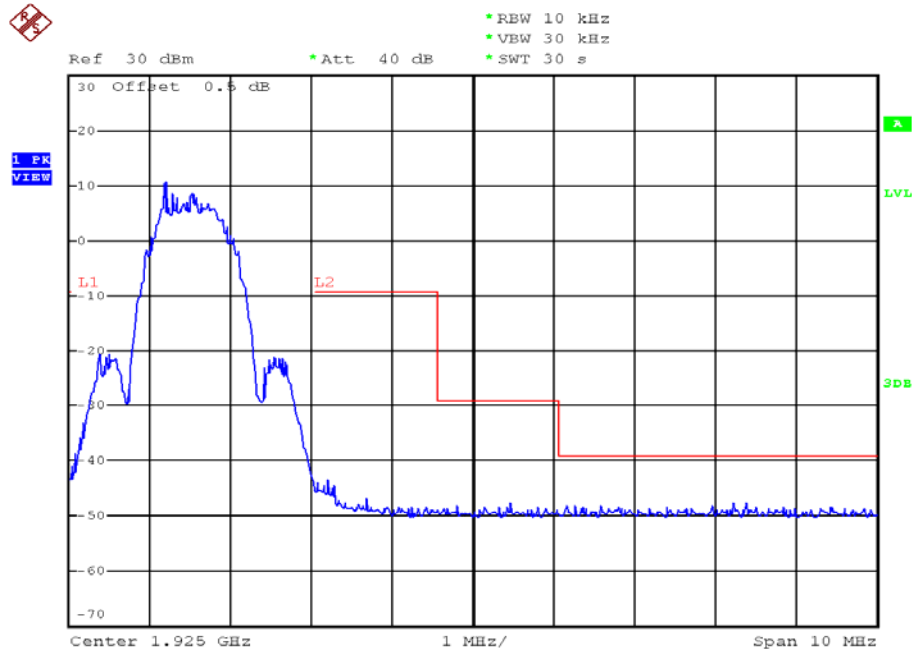

Base unit, Highest channel, Traffic carrier

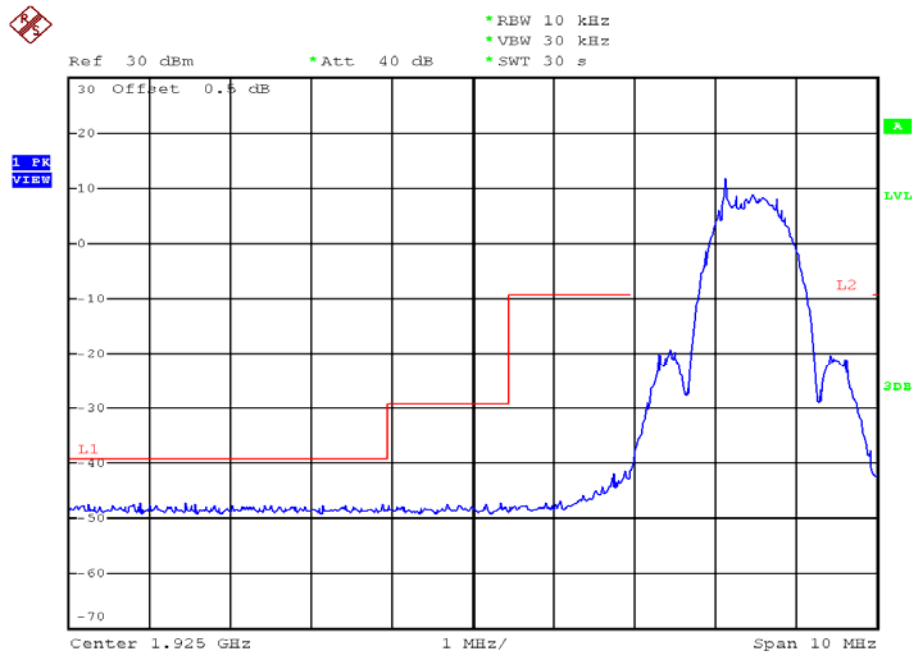

Issuing Laboratory:
Intertek Testing Services Hong Kong Limited

Hong Kong Accreditation Service (HKAS) has accredited this laboratory under the Hong Kong Laboratory Accreditation Scheme (HOKLAS) for specific laboratory activities as listed in the HOKLAS directory of accredited laboratories. The results shown in this report were determined by this laboratory in accordance with its terms of accreditation.



Handset unit, Lowest channel, Traffic carrier

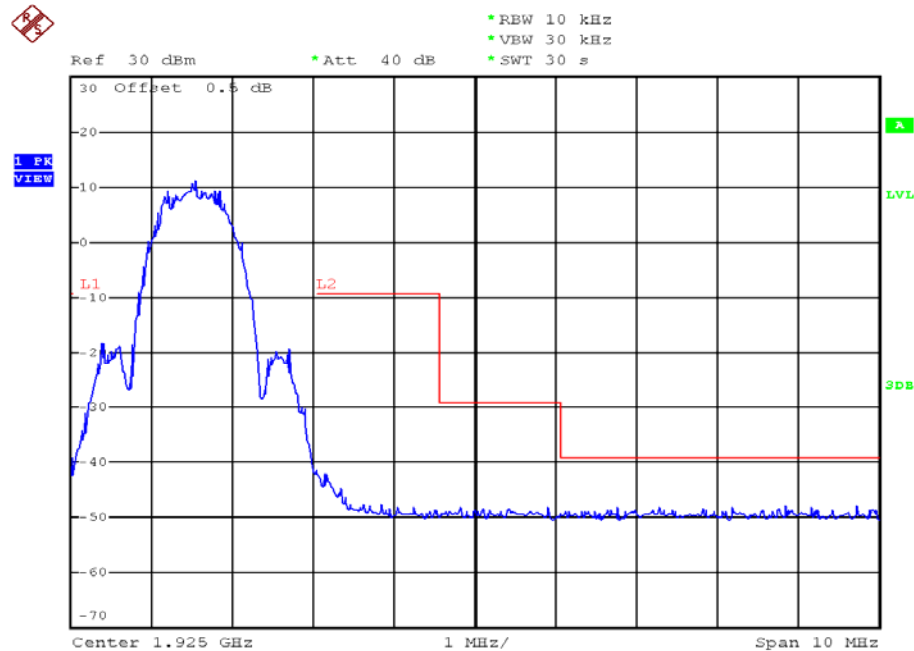

Handset unit, Highest channel, Traffic carrier

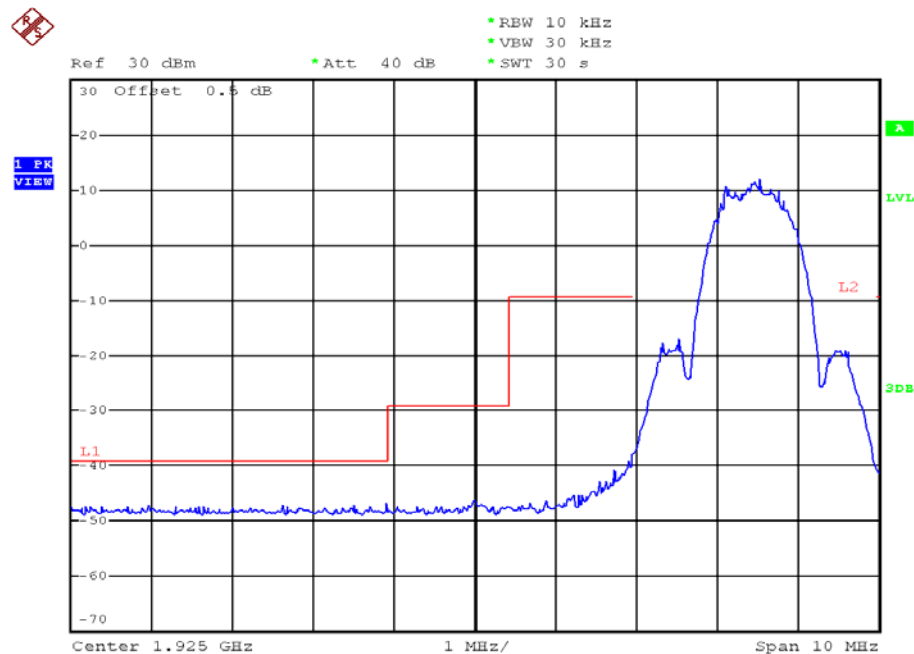

Issuing Laboratory:
Intertek Testing Services Hong Kong Limited

Hong Kong Accreditation Service (HKAS) has accredited this laboratory under the Hong Kong Laboratory Accreditation Scheme (HOKLAS) for specific laboratory activities as listed in the HOKLAS directory of accredited laboratories. The results shown in this report were determined by this laboratory in accordance with its terms of accreditation.



4.9 Emissions Outside the Sub-Band, FCC Rule 15.323(d):

Emissions outside the sub-band shall be attenuated below a reference power of 112 mW (20.5 dBm) as follows:

1. 30 dB between the band edge and 1.25 MHz above or below the band;
2. 50 dB between 1.25 and 2.5 MHz above or below the band; and
3. 60 dB at 2.5 MHz or greater above or below the band, or shall meet the requirement of FCC Rule 15.319(g) which shall not exceed the limits of FCC Rule 15.209.

Example: Calculation of Limit for emissions between the band edge and 1.25 MHz (1920.000 – 1918.750 MHz)

The emissions shall not exceed the Limit: 20.5 dBm – 30 dB = -9.5 dBm

Measurements are made in accordance with ANSI C63.17 sub-clause 6.1.6.2. Radiated emissions test method is used. Emissions that are directly caused by digital circuits in the transmit path and transmitter portion are measured.

Test Results:

Channel	Carrier Frequency (MHz)	Measured Band (MHz)	Limit (dBm)	Results
Lowest	1921.536	1920.000 - 1918.750	-9.5	Pass
		1918.750 - 1917.500	-29.5	Pass
		0.009 - 1917.500 & 1932.500 - 19300.000	-39.5 / FCC Rule 15.209	Pass
Highest	1928.448	1930.000 - 1931.250	-9.5	Pass
		1931.250 - 1932.500	-29.5	Pass
		0.009 – 1917.500 & 1932.500 - 19300.000	-39.5 / FCC Rule 15.209	Pass

Issuing Laboratory:
Intertek Testing Services Hong Kong Limited

Hong Kong Accreditation Service (HKAS) has accredited this laboratory under the Hong Kong Laboratory Accreditation Scheme (HOKLAS) for specific laboratory activities as listed in the HOKLAS directory of accredited laboratories. The results shown in this report were determined by this laboratory in accordance with its terms of accreditation.



4.9.1 Radiated Emissions Configuration Photographs:

Worst Case Radiated Emission
at

Base Unit: 3843.072 MHz

Handset: 3843.072 MHz

The worst case radiated emission configuration photographs are saved with filename: config photos.pdf

4.9.2 Radiated Emissions Data:

Data are included of the worst case configuration (the configuration which resulted in the highest emission levels). A sample calculation, configuration photographs and data tables of the emissions are included. All measurements were performed with peak detection unless otherwise specified.

The data in table 1-6 list the significant emission frequencies, the limit and the margin of compliance.

Judgement:

Base Unit - Passed by 5.1 dB margin

Handset - Passed by 5.5 dB margin

Issuing Laboratory:
Intertek Testing Services Hong Kong Limited

Hong Kong Accreditation Service (HKAS) has accredited this laboratory under the Hong Kong Laboratory Accreditation Scheme (HOKLAS) for specific laboratory activities as listed in the HOKLAS directory of accredited laboratories. The results shown in this report were determined by this laboratory in accordance with its terms of accreditation.



Mode: Transmission

Table 1, Base Unit

**Radiated Emissions Data
Pursuant To FCC Part 15 Section 15.323 (d)
Emissions Requirements**

Lowest Channel

Polarization	Frequency (MHz)	Measured Power (dBm)	Power Limit (dBm)	Margin (dB)
V	1921.536	15.3	--	--
V	1919.850	-41.8	-9.5	-32.3
V	1917.869	-46.6	-29.5	-17.1
V	1917.101	-51.7	-39.5	-12.2
H	3843.072	-44.6	-39.5	-5.1
H	5764.608	-44.8	-39.5	-5.3
H	7686.144	-45.6	-39.5	-6.1
H	9607.680	-45.8	-39.5	-6.3
H	11529.216	-47.0	-39.5	-7.5

NOTES:

1. Peak detector is used for the emission measurement.
2. All measurements were made at 3 meters.
3. Negative value in the margin column shows emission below limit.

Issuing Laboratory:
Intertek Testing Services Hong Kong Limited

Hong Kong Accreditation Service (HKAS) has accredited this laboratory under the Hong Kong Laboratory Accreditation Scheme (HOKLAS) for specific laboratory activities as listed in the HOKLAS directory of accredited laboratories. The results shown in this report were determined by this laboratory in accordance with its terms of accreditation.



Mode: Transmission

Table 2, Base Unit

**Radiated Emissions Data
Pursuant To FCC Part 15 Section 15.323 (d)
Emissions Requirements**

Highest Channel

Polarization	Frequency (MHz)	Measured Power (dBm)	Power Limit (dBm)	Margin (dB)
V	1928.448	15.4	--	--
V	1930.013	-41.6	-9.5	-32.1
V	1931.686	-46.8	-29.5	-17.3
V	1933.471	-49.8	-39.5	-10.3
H	3856.896	-44.8	-39.5	-5.3
H	5785.344	-45.0	-39.5	-5.5
H	7713.792	-45.3	-39.5	-5.8
H	9642.240	-45.6	-39.5	-6.1
H	11570.688	-46.0	-39.5	-6.5

NOTES:

1. Peak detector is used for the emission measurement.
2. All measurements were made at 3 meters.
3. Negative value in the margin column shows emission below limit.

Issuing Laboratory:
Intertek Testing Services Hong Kong Limited

Hong Kong Accreditation Service (HKAS) has accredited this laboratory under the Hong Kong Laboratory Accreditation Scheme (HOKLAS) for specific laboratory activities as listed in the HOKLAS directory of accredited laboratories. The results shown in this report were determined by this laboratory in accordance with its terms of accreditation.



Mode: Talk

Table 3, Base Unit

**Radiated Emissions Data
Pursuant To FCC Part 15 Section 15.323 (d)
Emissions Requirements**

Polarization	Frequency (MHz)	Measured Power (dBm)	Power Limit (dBm)	Margin (dB)
V	55.300	-63.6	-39.5	-24.1
V	110.600	-63.0	-39.5	-23.5
H	165.900	-62.8	-39.5	-23.3
H	221.200	-62.9	-39.5	-23.4
H	276.500	-63.6	-39.5	-24.1
H	331.800	-64.0	-39.5	-24.5

NOTES:

1. Peak detector is used for the emission measurement.
2. All measurements were made at 3 meters.
3. Negative value in the margin column shows emission below limit.

Issuing Laboratory:
Intertek Testing Services Hong Kong Limited

Hong Kong Accreditation Service (HKAS) has accredited this laboratory under the Hong Kong Laboratory Accreditation Scheme (HOKLAS) for specific laboratory activities as listed in the HOKLAS directory of accredited laboratories. The results shown in this report were determined by this laboratory in accordance with its terms of accreditation.



Mode: Transmission

Table 4, Handset

**Radiated Emissions Data
Pursuant To FCC Part 15 Section 15.323 (d)
Emissions Requirements**

Lowest Channel

Polarization	Frequency (MHz)	Measured Power (dBm)	Power Limit (dBm)	Margin (dB)
V	1921.536	13.4	--	--
V	1919.850	-41.8	-9.5	-32.3
V	1917.869	-46.8	-29.5	-17.3
V	1917.101	-52.0	-39.5	-12.5
H	3843.072	-45.0	-39.5	-5.5
H	5764.608	-45.8	-39.5	-6.3
H	7686.144	-45.6	-39.5	-6.1
H	9607.680	-46.0	-39.5	-6.5
H	11529.216	-46.7	-39.5	-7.2

NOTES:

1. Peak detector is used for the emission measurement.
2. All measurements were made at 3 meters.
3. Negative value in the margin column shows emission below limit.

Issuing Laboratory:
Intertek Testing Services Hong Kong Limited

Hong Kong Accreditation Service (HKAS) has accredited this laboratory under the Hong Kong Laboratory Accreditation Scheme (HOKLAS) for specific laboratory activities as listed in the HOKLAS directory of accredited laboratories. The results shown in this report were determined by this laboratory in accordance with its terms of accreditation.



Mode: Transmission

Table 5, Handset

**Radiated Emissions Data
Pursuant To FCC Part 15 Section 15.323 (d)
Emissions Requirements**

Highest Channel

Polarization	Frequency (MHz)	Measured Power (dBm)	Power Limit (dBm)	Margin (dB)
V	1928.448	13.7	--	--
V	1930.013	-42.1	-9.5	-32.6
V	1931.686	-46.7	-29.5	-17.2
V	1933.471	-51.8	-39.5	-12.3
H	3856.896	-45.2	-39.5	-5.7
H	5785.344	-45.7	-39.5	-6.2
H	7713.792	-45.8	-39.5	-6.3
H	9642.240	-46.0	-39.5	-6.5
H	11570.688	-46.6	-39.5	-7.1

NOTES:

1. Peak detector is used for the emission measurement.
2. All measurements were made at 3 meters.
3. Negative value in the margin column shows emission below limit.

Issuing Laboratory:
Intertek Testing Services Hong Kong Limited

Hong Kong Accreditation Service (HKAS) has accredited this laboratory under the Hong Kong Laboratory Accreditation Scheme (HOKLAS) for specific laboratory activities as listed in the HOKLAS directory of accredited laboratories. The results shown in this report were determined by this laboratory in accordance with its terms of accreditation.



Mode: Talk

Table 6, Handset

**Radiated Emissions Data
Pursuant To FCC Part 15 Section 15.323 (d)
Emissions Requirements**

Polarization	Frequency (MHz)	Measured Power (dBm)	Power Limit (dBm)	Margin (dB)
V	55.300	-63.8	-39.5	-24.3
V	110.600	-63.6	-39.5	-24.1
H	165.900	-63.0	-39.5	-23.5
H	221.300	-63.2	-39.5	-23.7
H	276.500	-63.6	-39.5	-24.1
H	331.800	-64.2	-39.5	-24.7

NOTES:

1. Peak detector is used for the emission measurement.
2. All measurements were made at 3 meters.
3. Negative value in the margin column shows emission below limit.

Issuing Laboratory:
Intertek Testing Services Hong Kong Limited

Hong Kong Accreditation Service (HKAS) has accredited this laboratory under the Hong Kong Laboratory Accreditation Scheme (HOKLAS) for specific laboratory activities as listed in the HOKLAS directory of accredited laboratories. The results shown in this report were determined by this laboratory in accordance with its terms of accreditation.



4.9.3 Field Strength Calculation

The field strength is calculated by adding the reading on the Spectrum Analyzer to the factors associated with preamplifiers (if any), antennas, cables, pulse desensitization and average factors (when specified limit is in average and measurements are made with peak detectors). A sample calculation is included below.

$$FS = RA + AF + CF - AG + PD + AV$$

Where

- FS = Field Strength in dB μ V/m
- RA = Receiver Amplitude (including preamplifier) in dB μ V
- CF = Cable Attenuation Factor in dB
- AF = Antenna Factor in dB
- AG = Amplifier Gain in dB
- PD = Pulse Desensitization in dB
- AV = Average Factor in -dB

In the radiated emission table which follows, the reading shown on the data table may reflect the preamplifier gain. An example of the calculations, where the reading does not reflect the preamplifier gain, follows:

$$FS = RA + AF + CF - AG + PD + AV$$

Example

Assume a receiver reading of 62.0 dB μ V is obtained. The antenna factor of 7.4 dB and cable factor of 1.6 dB is added. The amplifier gain of 29.0 dB is subtracted. The pulse desensitization factor of the spectrum analyzer is 0.0 dB, and the resultant average factor is -10.0 dB. The net field strength for comparison to the appropriate emission limit is 32.0 dB μ V/m. This value in dB μ V/m is converted to its corresponding level in μ V/m.

RA = 62.0 dB μ V
AF = 7.4 dB
CF = 1.6 dB
AG = 29.0 dB
PD = 0.0 dB
AV = -10 dB

$$FS = 62.0 + 7.4 + 1.6 - 29.0 + 0.0 + (-10.0) = 32.0 \text{ dB}\mu\text{V/m}$$
$$\text{Level in } \mu\text{V/m} = \text{Common Antilogarithm} [(32.0 \text{ dB}\mu\text{V/m})/20] = 39.8 \mu\text{V/m}$$

Issuing Laboratory:
Intertek Testing Services Hong Kong Limited

Hong Kong Accreditation Service (HKAS) has accredited this laboratory under the Hong Kong Laboratory Accreditation Scheme (HOKLAS) for specific laboratory activities as listed in the HOKLAS directory of accredited laboratories. The results shown in this report were determined by this laboratory in accordance with its terms of accreditation.



4.9.4 Average Factor Calculation and Transmitter ON Time Measurements, FCC Rule 15.35(b, c)

[] The EUT antenna output port was connected to the input of the spectrum analyzer. The analyzer center frequency was set to EUT RF channel carrier. The SPAN function on the analyzer was set to ZERO. The transmitter ON time was determined from the resultant time-amplitude display:

Please refer to the attached plots for more details:

The plots of Transmitter ON Time Measurements are saved as

[] Please refer to the attached transmitter timing diagram that are provided by manufacturer

[x] Not applicable - No average factor is required.

[] Please refer to Technical Description (descri.pdf) for more details

Issuing Laboratory:
Intertek Testing Services Hong Kong Limited

Hong Kong Accreditation Service (HKAS) has accredited this laboratory under the Hong Kong Laboratory Accreditation Scheme (HOKLAS) for specific laboratory activities as listed in the HOKLAS directory of accredited laboratories. The results shown in this report were determined by this laboratory in accordance with its terms of accreditation.



4.10 AC Power Line Conducted Emissions, FCC Rule 15.315:

The AC power line conducted emission shall not exceed the limits of FCC Rule 15.207.

Measurements are made in accordance with ANSI C63.4 sub-clause 7. Emissions that are directly caused by digital circuits in the transmit path and transmitter portion are measured.

- Not applicable – EUT is only powered by battery for operation.
- EUT connects to AC power line. Emission Data is listed in following pages.
- Base Unit connects to AC power line and has transmission. Headset connects to AC power line but has no transmission. Emission Data of Base Unit is listed in following pages.
- Handset connects to AC power line (indirectly) only during charging. Emission Data is listed in following pages.

Issuing Laboratory:
Intertek Testing Services Hong Kong Limited

Hong Kong Accreditation Service (HKAS) has accredited this laboratory under the Hong Kong Laboratory Accreditation Scheme (HOKLAS) for specific laboratory activities as listed in the HOKLAS directory of accredited laboratories. The results shown in this report were determined by this laboratory in accordance with its terms of accreditation.



4.10.1 AC Power Line Conducted Emissions Configuration Photographs:

Worst Case AC Power Line Conducted Emission

The worst case AC power Line conducted emission configuration photographs are saved with filename: config photos.pdf

4.10.2 AC Power Line Conducted Emissions Data:

The plot(s) and data in the following pages list the significant emission frequencies, the limit and the worst case margin of compliance.

Judgment:

More than 20dB margin

Issuing Laboratory:
Intertek Testing Services Hong Kong Limited

Hong Kong Accreditation Service (HKAS) has accredited this laboratory under the Hong Kong Laboratory Accreditation Scheme (HOKLAS) for specific laboratory activities as listed in the HOKLAS directory of accredited laboratories. The results shown in this report were determined by this laboratory in accordance with its terms of accreditation.



Worst Case: Talk



RBW 9 kHz
MT 1 s

Att 10 dB AUTO PREAMP OFF

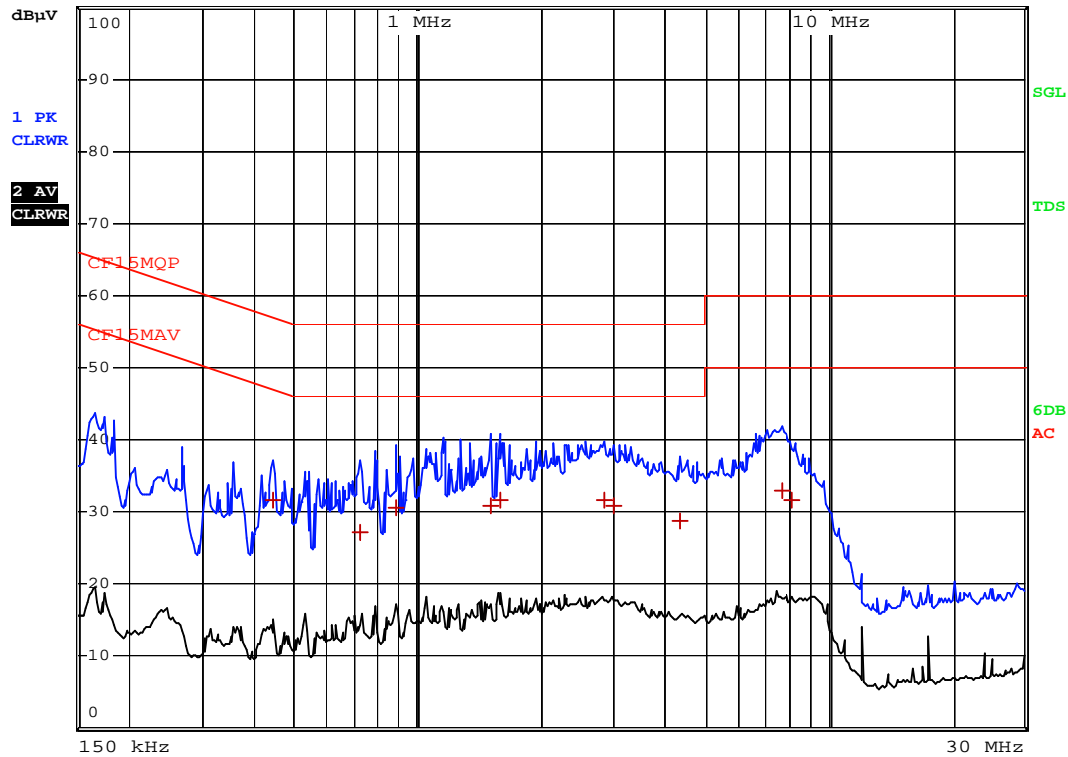

Date: 20.JUL.2012 09:55:46

Issuing Laboratory:
Intertek Testing Services Hong Kong Limited

Hong Kong Accreditation Service (HKAS) has accredited this laboratory under the Hong Kong Laboratory Accreditation Scheme (HOKLAS) for specific laboratory activities as listed in the HOKLAS directory of accredited laboratories. The results shown in this report were determined by this laboratory in accordance with its terms of accreditation.



Worst Case: Talk

EDIT PEAK LIST (Final Measurement Results)

Trace1: CF15MQP
Trace2: CF15MAV
Trace3: ---

TRACE	FREQUENCY	LEVEL dB μ V	DELTA LIMIT dB
1 Quasi Peak	442.5 kHz	31.75 L1 gnd	-25.26
1 Quasi Peak	721.5 kHz	27.11 L1 gnd	-28.88
1 Quasi Peak	888 kHz	30.67 L1 gnd	-25.32
1 Quasi Peak	1.5135 MHz	30.78 L1 gnd	-25.21
1 Quasi Peak	1.581 MHz	31.55 L1 gnd	-24.45
1 Quasi Peak	2.841 MHz	31.52 L1 gnd	-24.47
1 Quasi Peak	3.0075 MHz	30.74 L1 gnd	-25.26
1 Quasi Peak	4.335 MHz	28.86 L1 gnd	-27.13
1 Quasi Peak	7.692 MHz	33.04 L1 gnd	-26.96
1 Quasi Peak	8.124 MHz	31.67 L1 gnd	-28.32

Date: 20.JUL.2012 09:55:29

Issuing Laboratory:
Intertek Testing Services Hong Kong Limited

Hong Kong Accreditation Service (HKAS) has accredited this laboratory under the Hong Kong Laboratory Accreditation Scheme (HOKLAS) for specific laboratory activities as listed in the HOKLAS directory of accredited laboratories. The results shown in this report were determined by this laboratory in accordance with its terms of accreditation.



4.11 Radio Frequency Radiation Exposure, FCC Rule 15.319(i):

EUT is subject to the radio frequency exposure requirements specified in FCC Rule §§ 1.1307(b), 2.1091 and 2.1093. It shall be considered to operate in a “general population / uncontrolled” environment.

- [x] Handset unit: EUT was evaluated for Specific Absorption Rate (SAR) evaluation compliance according to OET Bulletin 65, Supplement C (Edition 01-01). It is in compliance with the SAR evaluation requirements. A SAR test report was submitted at same time and saved with filename: SAR Report.pdf.
- [x] Base unit: EUT was evaluated for Maximum Permissible Exposure (MPE) evaluation compliance according to OET Bulletin 65, Supplement C (Edition 01-01). The evaluation calculation results are saved with filename: RF exposure info.pdf.

Issuing Laboratory:
Intertek Testing Services Hong Kong Limited

Hong Kong Accreditation Service (HKAS) has accredited this laboratory under the Hong Kong Laboratory Accreditation Scheme (HOKLAS) for specific laboratory activities as listed in the HOKLAS directory of accredited laboratories. The results shown in this report were determined by this laboratory in accordance with its terms of accreditation.



4.12 Frame Repetition Stability, FCC Rule 15.323(e):

- EUT implements Time Division Duplex (TDD) (not include TDMA) in order to support duplex connection on a given frequency carrier shall maintain a frame repetition rate whereby 3 x standard deviation of the frequency stability shall not exceed 50 ppm, not including a shift of the mean.
- EUT uses Time Division Multiple Access (TDMA) in order to support multiple communication links on a given frequency carrier shall maintain a frame repetition rate whereby 3 x standard deviation of the frequency stability shall not exceed 10 ppm, not including a shift of the mean.

Measurements are made in accordance with ANSI C63.17 sub-clause 6.2.2. Test setup is shown in section 3.2 Figure 3.2.1. A spectrum analyzer measures the time duration between rising edges of two consecutive frames over a time period of at least 1000 frame periods. These measurement values are used to compute the 3 x standard deviation of the frequency stability.

Test Results:

I. Base unit

Maximum Frame Repetition Stability (ppm)	Limit (ppm)	Results
0.0405	±10	Pass

II. Handset

Maximum Frame Repetition Stability (ppm)	Limit (ppm)	Results
<0.0001	±10	Pass

Issuing Laboratory:
Intertek Testing Services Hong Kong Limited

Hong Kong Accreditation Service (HKAS) has accredited this laboratory under the Hong Kong Laboratory Accreditation Scheme (HOKLAS) for specific laboratory activities as listed in the HOKLAS directory of accredited laboratories. The results shown in this report were determined by this laboratory in accordance with its terms of accreditation.



4.13 Frame Period and Jitter, FCC Rule 15.323(e):

The frame period (a set of consecutive time slots in which the position of each time slot can be identified by reference to a synchronizing source) of EUT operating in these sub-bands shall be 20 ms or 10 ms/X where X is a positive whole number.

The jitter (time-related, abrupt, spurious variations in the duration of the frame interval) introduced at the two ends of such a communication link shall not exceed 25 μ s for any two consecutive transmissions. Transmissions shall be continuous in every time and spectrum window during the frame period defined for EUT.

Measurements are made in accordance with ANSI C63.17 sub-clause 6.2.3. Test setup is shown in section 3.2 Figure 3.2.1. A spectrum analyzer measures the time duration between the rising edges of two consecutive frames. The measurements are taken over 100,000 frames. These measurement values are used to compute mean value and the difference between any two consecutive frame periods. The mean value is the frame period.

Test Results:

I. Base unit

Measured Maximum Jitter (μ s)	Limit (μ s)	Result
-0.1806	± 25	Pass

II. Handset

Measured Maximum Jitter (μ s)	Limit (μ s)	Result
-0.2968	± 25	Pass

4.14 Carrier Frequency Stability, FCC Rule 15.323(f):

The carrier frequency stability of EUT shall be maintained within +/-10 ppm at the following conditions:

1. Over 1 hour at nominal supply voltage and a temperature of +20 °C;
2. Over a variation in the primary supply voltage of 85 % to 115 % of nominal supply voltage at a temperature of +20 °C. This test does not apply to an EUT that is only powered by battery for operation;
3. Over a temperature variation of -20 °C to +50 °C or at extreme temperatures as declared by manufacturer, and at nominal supply voltage.

For base unit:

The nominal supply voltage: 115VAC and the extreme temperatures of -20°C to +50°C are declared by manufacturer.

For handset:

The nominal supply voltage: 2.4VDC and the extreme temperatures of -20°C to +50°C are/is declared by manufacturer.

Measurements are made in accordance with ANSI C63.17 sub-clause 6.2.1 The EUT and CMD60 is connected with shielded coaxial cable. The EUT is controlled by DECT Radio Communication Tester, CMD60, to use a fixed frequency channel during test as well as record the frequency offset. The transmission of EUT is in burst mode with pseudo-random data. Test setup is shown as follows.

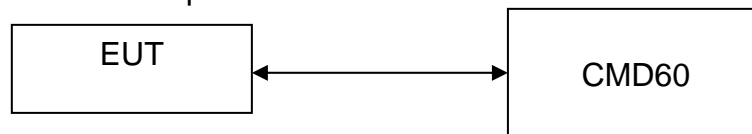

Test Results:

I a. Carrier Frequency Stability over time - base unit

Supply Voltage	Temperature (°C)	Measured Frequency Offset Over an hour (ppm)		Limit (ppm)	Result
		Max.	Min.		
Nominal	+20°C	0.78	-0.26	±10	Pass

I b. Carrier Frequency Stability over Power Supply Voltage - base unit

Supply Voltage	Temperature (°C)	Measured Frequency Offset (ppm)	Limit (ppm)	Results
85%	+20°C	0.77	±10	Pass
115%	+20°C	0.25	±10	Pass

Issuing Laboratory:
Intertek Testing Services Hong Kong Limited

Hong Kong Accreditation Service (HKAS) has accredited this laboratory under the Hong Kong Laboratory Accreditation Scheme (HOKLAS) for specific laboratory activities as listed in the HOKLAS directory of accredited laboratories. The results shown in this report were determined by this laboratory in accordance with its terms of accreditation.



4.14 Carrier Frequency Stability, FCC Rule 15.323(f): -Continued

I c. Carrier Frequency Stability over Temperature - base unit

Supply Voltage	Temperature (°C)	Measured Frequency Offset (ppm)	Limit (ppm)	Results
Nominal	-20°C	0.77	±10	Pass
Nominal	+50°C	-0.78	±10	Pass

II a. Carrier Frequency Stability over time - handset

Supply Voltage	Temperature (°C)	Measured Frequency Offset Over an hour (ppm)		Limit (ppm)	Result
		Max.	Min.		
Nominal	+20°C	0.43	-1.13	±10	Pass

II b. Carrier Frequency Stability over Power Supply Voltage - handset

Supply Voltage	Temperature (°C)	Measured Frequency Offset (ppm)	Limit (ppm)	Results
85%	+20°C	NA	±10	NA
115%	+20°C	NA	±10	NA

II c. Carrier Frequency Stability over Temperature -handset

Supply Voltage	Temperature (°C)	Measured Frequency Offset (ppm)	Limit (ppm)	Results
Nominal	-20°C	-2.26	±10	Pass
Nominal	+50°C	-0.70	±10	Pass

Issuing Laboratory:
Intertek Testing Services Hong Kong Limited

Hong Kong Accreditation Service (HKAS) has accredited this laboratory under the Hong Kong Laboratory Accreditation Scheme (HOKLAS) for specific laboratory activities as listed in the HOKLAS directory of accredited laboratories. The results shown in this report were determined by this laboratory in accordance with its terms of accreditation.



4.15 Monitoring Threshold:

Monitoring threshold can be relaxed according to FCC Rule 15.323(c)(9). EUT that has a power output lower than the maximum permitted under FCC Rule 15.319(c) may increase their monitoring detection threshold by one decibel for each one decibel that the transmitter power is below the maximum permitted.

Calculation of Monitoring Threshold Limit:

$$\begin{aligned} \text{Monitoring Threshold } (T) &\leq -174 + 10 \log_{10} B + M + P_{\max} - P_{\text{EUT}} \text{ dBm} \\ &\leq 15 \log_{10} B - 184 + M - P_{\text{EUT}} \text{ dBm} \end{aligned}$$

- Where B = Measured Emission Bandwidth of base unit - FCC: 1.50×10^6 Hz
 B = Measured Emission Bandwidth of handset - FCC: 1.50×10^6 Hz
 M = 30 dB for Lower Monitoring Threshold (T_L), or
= 50 dB for Upper Monitoring Threshold (T_U)
 P_{\max} = $5 \log_{10} B - 10$ dBm
 P_{EUT} = Measured Peak Transmit Power of base unit - FCC: 17.70 dBm
 P_{EUT} = Measured Peak Transmit Power of handset - FCC: 19.96 dBm

Calculated Monitoring Threshold Limits:

I. Base unit

	FCC
Lower Monitoring Threshold ($T_L + U_M$) in dBm	-73.1
Upper Monitoring Threshold ($T_U + U_M$) in dBm	-53.1

II. Handset

	FCC
Lower Monitoring Threshold ($T_L + U_M$) in dBm	-75.3
Upper Monitoring Threshold ($T_U + U_M$) in dBm	-55.3

NA - Not applicable

Issuing Laboratory:
Intertek Testing Services Hong Kong Limited

Hong Kong Accreditation Service (HKAS) has accredited this laboratory under the Hong Kong Laboratory Accreditation Scheme (HOKLAS) for specific laboratory activities as listed in the HOKLAS directory of accredited laboratories. The results shown in this report were determined by this laboratory in accordance with its terms of accreditation.



4.15.1 Lower Monitoring Threshold, FCC Rule 15.323(c)(2):

- Not applicable – EUT which supports at least of 40 duplex system access channels and implements Least Interfered Channel (LIC) algorithm is permitted to use an upper monitoring threshold. Please refer to the section 4.16.2 for more details.
- The lower monitoring threshold must not be more than 30 dB above the thermal noise power for a bandwidth equivalent to the emission bandwidth used by EUT.

Measurements are made in accordance with ANSI C63.17 sub-clause 7.3.1. Test setup is shown in section 3.3 Figure 3.3.1. The test is performed on the carrier closest to center of the band. RF signal generators apply uniform CW interference on all EUT carriers each at level $T_L + U_M + 10$ dB. Then, the interference level is reduced uniformly on all carriers until the EUT can transmit. The interference level shall be lower than or equal to the threshold limit.

Test Results:

I. Base unit

Measured Maximum Interference Level (dBm)	Lower Monitoring Threshold Limit (dBm) ($T_L + U_M$)	Results
	FCC	
NA	-73.1	NA

II. Handset

Measured Maximum Interference Level (dBm)	Lower Monitoring Threshold Limit (dBm) ($T_L + U_M$)	Results
	FCC	
NA	-75.3	NA

NA - Not applicable

Issuing Laboratory:
Intertek Testing Services Hong Kong Limited

Hong Kong Accreditation Service (HKAS) has accredited this laboratory under the Hong Kong Laboratory Accreditation Scheme (HOKLAS) for specific laboratory activities as listed in the HOKLAS directory of accredited laboratories. The results shown in this report were determined by this laboratory in accordance with its terms of accreditation.



4.15.2 Least Interfered Channel, LIC, FCC Rule 15.323(c)(5):

- [] Not implemented – EUT met lower monitoring threshold requirements. Please refer to the section 4.17.1 for more details
- [x] If access to spectrum is not available as determined by section 4.16.1 and a minimum of 40 duplex system access channels are defined for the EUT, the time and spectrum windows with the lowest power level below a monitoring threshold of 50 dB above the thermal noise power determined for the emission bandwidth may be accessed

Number of duplex channels per frequency channel = 12
 Number of frequency channel = 5
 Total Duplex Channels = 60

Hence, the time and spectrum windows below upper monitoring threshold may be accessed.

4.15.2.1 Upper Monitoring Threshold, FCC Rule 15.323(c)(5):

Measurements are made in accordance with ANSI C63.17 sub-clause 7.3.2. Test setup is shown in section 3.3 Figure 3.3.1. The test is performed on the carrier closest to center of the band. RF signal generators apply uniform CW interference on all EUT carriers each at level $T_U + U_M + 10$ dB. Then, the interference level is reduced uniformly on all carriers until the EUT can transmit. The interference level shall be lower than or equal to the threshold limit.

Test Results:

I. Base unit

Measured Maximum Interference Level (dBm)	Upper Monitoring Threshold Limit (dBm) ($T_U + U_M$)	Results
	FCC	
-57.6	-53.1	Pass

Issuing Laboratory:
Intertek Testing Services Hong Kong Limited

Hong Kong Accreditation Service (HKAS) has accredited this laboratory under the Hong Kong Laboratory Accreditation Scheme (HOKLAS) for specific laboratory activities as listed in the HOKLAS directory of accredited laboratories. The results shown in this report were determined by this laboratory in accordance with its terms of accreditation.



4.15.2.1 Upper Monitoring Threshold, FCC Rule 15.323(c)(5) : - Continued

II. Handset

Measured Maximum Interference Level (dBm)	Upper Monitoring Threshold Limit (dBm) ($T_U + U_M$)	Results
	FCC	
-59.8	-55.3	Pass

NA - Not applicable

4.15.2.2 Least Interfered Channel (LIC) Selection, FCC Rule 15.323(c)(5):

The criteria are specified in section 4.16.2. In addition, the power measurement resolution for this comparison must be accurate to within 6 dB.

Measurements are made in accordance with ANSI C63.17 sub-clause 7.3.3. Test setup is shown in section 3.3 Figure 3.3.1. RF signal generators apply uniform CW interference on all EUT carriers except two carriers (designated f_1 and f_2), each at level $T_U + U_M$. EUT can only transmit on these two carriers.

Issuing Laboratory:
Intertek Testing Services Hong Kong Limited

Hong Kong Accreditation Service (HKAS) has accredited this laboratory under the Hong Kong Laboratory Accreditation Scheme (HOKLAS) for specific laboratory activities as listed in the HOKLAS directory of accredited laboratories. The results shown in this report were determined by this laboratory in accordance with its terms of accreditation.



4.15.2.2 Least Interfered Channel (LIC) Selection, FCC Rule 15.323(c)(5): - Continued

Test Descriptions and Results:

I. LIC Procedure - Base unit

	Test Descriptions	EUT transmits on	Results
1	Apply interference on f_1 at level $T_L + U_M + 7$ dB. Apply interference on f_2 at level $T_L + U_M$. Initiate transmission. Verify transmission on f_2 . Terminate transmission. Repeat 5 times.	f_2	Pass
2	Apply interference on f_1 at level $T_L + U_M$. Apply interference on f_2 at level $T_L + U_M + 7$ dB. Initiate transmission. Verify transmission on f_1 . Terminate transmission. Repeat 5 times.	f_1	Pass
3	Apply interference on f_1 at level $T_L + U_M + 1$ dB. Apply interference on f_2 at level $T_L + U_M - 6$ dB. Initiate transmission. Verify transmission on f_2 . Terminate transmission. Repeat 5 times.	f_2	Pass
4	Apply interference on f_1 at level $T_L + U_M - 6$ dB. Apply interference on f_2 at level $T_L + U_M + 1$ dB. Initiate transmission. Verify transmission on f_1 . Terminate transmission. Repeat 5 times.	f_1	Pass

NA - Not applicable

Issuing Laboratory:
Intertek Testing Services Hong Kong Limited

Hong Kong Accreditation Service (HKAS) has accredited this laboratory under the Hong Kong Laboratory Accreditation Scheme (HOKLAS) for specific laboratory activities as listed in the HOKLAS directory of accredited laboratories. The results shown in this report were determined by this laboratory in accordance with its terms of accreditation.



4.15.2.2 Least Interfered Channel (LIC) Selection, FCC Rule 15.323(c)(5) : -Continued

Test Descriptions and Results:

II. LIC Procedure - Handset

	Test Descriptions	EUT transmits on	Results
1	Apply interference on f_1 at level $T_L + U_M + 7$ dB. Apply interference on f_2 at level $T_L + U_M$. Initiate transmission. Verify transmission on f_2 . Terminate transmission. Repeat 5 times.	f_2	Pass
2	Apply interference on f_1 at level $T_L + U_M$. Apply interference on f_2 at level $T_L + U_M + 7$ dB. Initiate transmission. Verify transmission on f_1 . Terminate transmission. Repeat 5 times.	f_1	Pass
3	Apply interference on f_1 at level $T_L + U_M + 1$ dB. Apply interference on f_2 at level $T_L + U_M - 6$ dB. Initiate transmission. Verify transmission on f_2 . Terminate transmission. Repeat 5 times.	f_2	Pass
4	Apply interference on f_1 at level $T_L + U_M - 6$ dB. Apply interference on f_2 at level $T_L + U_M + 1$ dB. Initiate transmission. Verify transmission on f_1 . Terminate transmission. Repeat 5 times.	f_1	Pass

NA - Not applicable

Issuing Laboratory:
Intertek Testing Services Hong Kong Limited

Hong Kong Accreditation Service (HKAS) has accredited this laboratory under the Hong Kong Laboratory Accreditation Scheme (HOKLAS) for specific laboratory activities as listed in the HOKLAS directory of accredited laboratories. The results shown in this report were determined by this laboratory in accordance with its terms of accreditation.



4.15.2.3 Least Interfered Channel (LIC) Confirmation, FCC Rule 15.323(c)(5):

EUT utilizing the provision of FCC Rule 15.323(c)(5) must have monitored all access channels defined for its system within the last 10 s and must verify, within the 20 ms (40 ms for EUT designed to use a 20 ms frame period) immediately preceding actual channel access that the detected power of the selected time and spectrum windows is no higher than the previously detected value.

Measurements are made in accordance with ANSI C63.17 sub-clause 7.3.4. This test is performed in section 4.16 and 4.17.

Results:

The tests are reported in section 4.16 and 4.17.

4.15.2.4 Maximum Spectrum Occupancy, FCC Rule 15.323(c)(5):

No EUT or group of co-operating EUTs located within 1 meter of each other shall during any frame period occupy more than 6 MHz of aggregate bandwidth, or alternatively, more than one third of the time and spectrum windows defined by the EUT.

Attestation:

According to the technical description provided, the total number of the time and spectrum windows defined by the system is $5 \times 12 = 60$.

During any frame period, the maximum number of time and spectrum windows occupied by the system will be 12, which is less than one third of the time and spectrum windows defined by the system.

4.16 Monitoring Time, FCC Rule 15.323(c)(1):

Immediately prior to initiating transmission, EUT must monitor the combined time and spectrum windows in which they intend to transmit for a period of at least 10 ms for EUT designed to use a 10 ms or shorter frame period, or at least 20 ms for EUT designed to use a 20 ms frame period.

Measurements are made in accordance with ANSI C63.17 sub-clause 7.3.4. Test setup is shown in section 3.3 Figure 3.3.1. RF signal generators apply uniform CW interference on all system carriers except two carriers (designated f_1 and f_2), each at level $T_U + U_M$. EUT can only transmit on these two carriers.

Test Descriptions and Results:

I. Base unit

	Test Descriptions	EUT transmits on	Results
1	Apply interference on f_1 at level $T_U + U_M$, and no interference on f_2 . Initiate transmission. Verify transmission on f_2 . Then, terminate transmission.	f_2	Pass
2	Apply interference on f_2 at level $T_U + U_M$, and remove interference from f_1 immediately. Also immediately initiate transmission but is at least 20 ms after interference on f_2 is applied. Verify transmission on f_1 .	f_1	Pass

II. Handset

	Test Descriptions	EUT transmits on	Results
1	Apply interference on f_1 at level $T_U + U_M$, and no interference on f_2 . Initiate transmission. Verify transmission on f_2 . Then, terminate transmission.	f_2	Pass
2	Apply interference on f_2 at level $T_U + U_M$, and remove interference from f_1 immediately. Also immediately initiate transmission but is at least 20 ms after interference on f_2 is applied. Verify transmission on f_1 .	f_1	Pass

4.17 Maximum Transmit Period, FCC Rule 15.323(c)(3):

If no signal above the threshold level is detected, transmission may commence and continue with the same emission bandwidth in the monitored time and spectrum windows without further monitoring. However, occupation of the same combined time and spectrum windows by a EUT or group of co-operating EUTs continuously over a period of time longer than 8 hours is not permitted without repeating the access criteria.

EUT establishes a communication channel with its companion device, which occupies the duplex pair combined time and spectrum windows. Reference RF signal generator synchronized with the sample and then generated a pulse as a time frame reference. The centre frequency of spectrum analyzer was set to the carrier frequency and the SPAN was set to ZERO. The spectrum analyzer was used to monitor the time (reference to the time signal) and spectrum of the communication channel. The occupied time or spectrum of the communication channel shall be changed over a period of time no longer than 8 hours. For a EUT with a frame period of 10/X ms, no more than 2,880,000 X frames should be transmitted without a break.

Test setup is shown as follows:

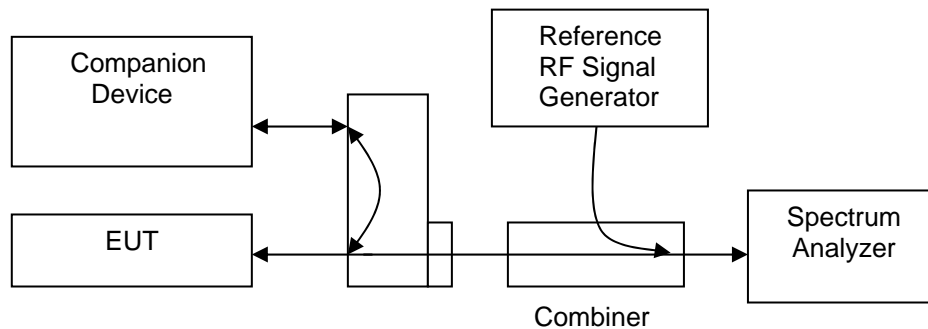

Test Results:

I. Base unit

Measured Maximum Transmission Duration (minutes)	Limit (minutes)	Results
50	480	Pass

II. Handset

Measured Maximum Transmission Duration (minutes)	Limit (minutes)	Results
50	480	Pass

Issuing Laboratory:
Intertek Testing Services Hong Kong Limited

Hong Kong Accreditation Service (HKAS) has accredited this laboratory under the Hong Kong Laboratory Accreditation Scheme (HOKLAS) for specific laboratory activities as listed in the HOKLAS directory of accredited laboratories. The results shown in this report were determined by this laboratory in accordance with its terms of accreditation.



4.18 System Acknowledgement, FCC Rule 15.323(c)(4):

Once access to specific combined time and spectrum windows is obtained an acknowledgment from a system participant must be received by the initiating transmitter within one second or transmission must cease. Periodic acknowledgments must be received at least every 30 seconds or transmission must cease. Channels used exclusively for control and signaling information may transmit continuously for 30 seconds without receiving an acknowledgment, at which time the access criteria must be repeated.

Measurements are made in accordance with ANSI C63.17 sub-clause 8.1.1 and 8.2.1. Test setup is shown in section 3.3 Figure 3.3.1.

Test Results:

I. Base Unit

[×] Timing for EUTs using control and signaling channel type transmissions:

Conditions	Transmission Duration (seconds)	Limit (seconds)	Results
Time needed to repeat access criteria	1.28	30	Pass

[×] Timing for EUTs using communications channel type transmissions:

Conditions	Transmission Duration (seconds)	Limit (seconds)	Results
Activate EUT w/ companion device off	NA	1	NA
Time needed to cease Traffic Channel	5	30	Pass

NA - Not applicable

Issuing Laboratory:
Intertek Testing Services Hong Kong Limited

Hong Kong Accreditation Service (HKAS) has accredited this laboratory under the Hong Kong Laboratory Accreditation Scheme (HOKLAS) for specific laboratory activities as listed in the HOKLAS directory of accredited laboratories. The results shown in this report were determined by this laboratory in accordance with its terms of accreditation.



4.18 System Acknowledgement, FCC Rule 15.323(c)(4): - Continued

II. Handset

Timing for EUTs using control and signaling channel type transmissions:

Conditions	Transmission Duration (seconds)	Limit (seconds)	Results
Time needed to repeat access criteria	NA	30	NA

Timing for EUTs using communications channel type transmissions:

Conditions	Transmission Duration (seconds)	Limit (seconds)	Results
Activate EUT w/ companion device off	0	1	Pass
Time needed to cease Traffic Channel	5	30	Pass

NA - Not applicable

4.19 Random Waiting, FCC Rule 15.323(c)(6):

If the selected combined time and spectrum windows are unavailable, the EUT may either monitor and select different windows or seek to use the same windows after waiting an amount of time, randomly chosen from a uniform random distribution between 10 and 150 ms, commencing when the channel becomes available.

Measurements are made in accordance with ANSI C63.17 sub-clause 8.1.2 or 8.1.3. Test setup is shown in section 3.3 Figure 3.3.1.

Test Results:

I. Base unit

Random Waiting is not implemented in the EUT:

Conditions	Transmit Channel	Results
Interference applied at operating Channel, f_1	f_2	Pass

Random Waiting is implemented in the EUT:

Maximum time interval from the end of interference to the start of the control channel	The distribution of the measured time intervals	Results
NA	NA	NA

II. Handset

Random Waiting is not implemented in the EUT:

Conditions	Transmit Channel	Results
Interference applied at operating Channel, f_1	NA	NA

Random Waiting is implemented in the EUT:

Maximum time interval from the end of interference to the start of the control channel	The distribution of the measured time intervals	Results
NA	NA	NA

NA - Not applicable

Issuing Laboratory:
Intertek Testing Services Hong Kong Limited

Hong Kong Accreditation Service (HKAS) has accredited this laboratory under the Hong Kong Laboratory Accreditation Scheme (HOKLAS) for specific laboratory activities as listed in the HOKLAS directory of accredited laboratories. The results shown in this report were determined by this laboratory in accordance with its terms of accreditation.



4.20 Monitoring Bandwidth, FCC Rule 15.323(c)(7).1:

The monitoring bandwidth must be equal to or greater than the emission bandwidth of the intended transmission.

Measurements are made in accordance with ANSI C63.17 sub-clause 7.4. Test setup is shown in section 3.3 Figure 3.3.1.

Attestation:

[×] Monitoring bandwidth of the EUT is equal to the emission bandwidth of the intended transmission. Monitoring is made through the radio receiver used by the EUT for communication. Please refer to the section 2.2 Technical Description for more details. Designed bandwidth refers to section 4.3 Emission Bandwidth.

[] Compliance is demonstrated by Monitoring Bandwidth Tests as shown below.

Test Results:

la. Simple Compliance Test Results - Base unit

Interference from Carrier	Reaction of EUT	Results
-30% EBW Bandwidth	NA	NA
+30% EBW Bandwidth	NA	NA

lb. Detailed Compliance Test Results - Base unit

CW Interference from Carrier	Reaction of EUT	Results
+ 6 dB	NA	NA
+ 12 dB	NA	NA
- 6 dB	NA	NA
- 12 dB	NA	NA

- A – Could Transmit
- B – Could not Transmit
- NA – Not applicable

*Remarks: Detailed Compliance Test was used to show the compliance of the EUT.

Issuing Laboratory:
Intertek Testing Services Hong Kong Limited

Hong Kong Accreditation Service (HKAS) has accredited this laboratory under the Hong Kong Laboratory Accreditation Scheme (HOKLAS) for specific laboratory activities as listed in the HOKLAS directory of accredited laboratories. The results shown in this report were determined by this laboratory in accordance with its terms of accreditation.



4.20 Monitoring Bandwidth, FCC Rule 15.323(c)(7).1: - Continued

Ila. Simple Compliance Test Results - Handset

Interference from Carrier	Reaction of EUT	Results
-30% EBW Bandwidth	NA	NA
+30% EBW Bandwidth	NA	NA

Ilb. Detailed Compliance Test Results - Handset

CW Interference from Carrier	Reaction of EUT	Results
+ 6 dB	NA	NA
+ 12 dB	NA	NA
- 6 dB	NA	NA
- 12 dB	NA	NA

- A – Could Transmit
- B – Could not Transmit
- NA – Not applicable

*Remarks: Detailed Compliance Test was used to show the compliance of the EUT.

Issuing Laboratory:
Intertek Testing Services Hong Kong Limited

Hong Kong Accreditation Service (HKAS) has accredited this laboratory under the Hong Kong Laboratory Accreditation Scheme (HOKLAS) for specific laboratory activities as listed in the HOKLAS directory of accredited laboratories. The results shown in this report were determined by this laboratory in accordance with its terms of accreditation.



4.21 Maximum Reaction Time, FCC Rule 15.323(c)(7).2:

The monitoring system bandwidth must have a maximum reaction time less than $50 \times \text{SQRT}(1.25/\text{emission bandwidth } B \text{ in MHz}) \mu\text{s}$ for signals at the applicable threshold level but shall not be required to be less than $50 \mu\text{s}$. If a signal is detected that is 6 dB or more above the applicable threshold level, the maximum reaction time shall be $35 \times \text{SQRT}(1.25/\text{emission bandwidth } B \text{ in MHz}) \mu\text{s}$ but shall not be required to be less than $35 \mu\text{s}$.

Measurements are made in accordance with ANSI C63.17 sub-clause 7.5. Test setup is shown in section 3.3 Figure 3.3.1.

Test Results:

	Test	Reaction of EUT	Results
1	With Interference Pulse = 50 μs	B	Pass
2	With Interference Pulse = 35 μs	B	Pass

- A – Could be connected in at least one channel
- B – Could not be connected in all channels
- NA – Not applicable

Issuing Laboratory:
Intertek Testing Services Hong Kong Limited

Hong Kong Accreditation Service (HKAS) has accredited this laboratory under the Hong Kong Laboratory Accreditation Scheme (HOKLAS) for specific laboratory activities as listed in the HOKLAS directory of accredited laboratories. The results shown in this report were determined by this laboratory in accordance with its terms of accreditation.



4.22 Monitoring Antenna, FCC Rule 15.323(c)(8):

The monitoring system shall use the same antenna used for transmission, or an antenna that yields equivalent reception at that location.

- EUT uses the same antenna used for transmission and monitoring that is in compliance meet above provision.

- EUT uses difference antenna used for transmission and monitoring. It must be verified that the monitoring antenna provides coverage equivalent to that of the transmitting antenna. Measurements are made in accordance with ANSI C63.17 sub-clause 4.

Issuing Laboratory:
Intertek Testing Services Hong Kong Limited

Hong Kong Accreditation Service (HKAS) has accredited this laboratory under the Hong Kong Laboratory Accreditation Scheme (HOKLAS) for specific laboratory activities as listed in the HOKLAS directory of accredited laboratories. The results shown in this report were determined by this laboratory in accordance with its terms of accreditation.



4.23 Duplex Connections, FCC 15.323(c)(10):

An initiating device may attempt to establish a duplex connection by monitoring both its intended transmit (Tx) and receive (Rx) time and spectrum windows. If both the intended transmit and receive time and spectrum windows meet the access criteria, then the initiating device can initiate a transmission in the intended transmit time and spectrum window. If the power detected by the responding device can be decoded as a duplex connection signal from the initiating device, then the responding device may immediately begin transmitting on the receive time and spectrum window monitored by the initiating device.

Measurements are made in accordance with ANSI C63.17 sub-clause 8.3. Test setup is shown in section 3.3 Figure 3.3.1.

Attestation:

The Handset is the initiating device of the duplex connection

Test Results:

1a. Base unit

Dual Access Criteria Check for EUT not Implemented the Upper Threshold:

Interference	Reaction of EUT	Results
All Tx and Rx Window, except one for Rx Window	NA	NA
All Tx and Rx Window, except one for Tx Window	NA	NA

A – Could be connected on the target Rx window and its duplex mate

B – Could be connected on the target Tx window and its duplex mate

C – Connected on window which is not the target Tx/Rx window

D – Could not be connected

NA – Not applicable

Issuing Laboratory:
Intertek Testing Services Hong Kong Limited

Hong Kong Accreditation Service (HKAS) has accredited this laboratory under the Hong Kong Laboratory Accreditation Scheme (HOKLAS) for specific laboratory activities as listed in the HOKLAS directory of accredited laboratories. The results shown in this report were determined by this laboratory in accordance with its terms of accreditation.



4.23 Duplex Connections, FCC 15.323(c)(10): - Continued

Ib. Base unit

[] Dual Access Criteria Check for EUT Implemented the Upper Threshold:

Interference	Reaction of EUT	Results
All Tx windows with level $T_L + U_M$ & Rx windows with level $T_L + U_M + 7\text{dB}$, except one for Tx window & one for Rx window, which are not duplex.	NA	NA
All Tx windows with level $T_L + U_M + 7\text{dB}$ & Rx windows with level $T_L + U_M$, except one for Tx window & one for Rx, which are not duplex	NA	NA
All Tx & Rx windows with level $T_U + U_M$, except one for Tx window & one for Rx Window, which are not duplex	NA	NA

- A – Could be connected on the target Rx window and its duplex mate
- B – Could be connected on the target Tx window and its duplex mate
- C – Connected on window which is not the target Tx/Rx window
- D – Could not be connected

- NA – Not applicable

4.23 Duplex Connections, FCC 15.323(c)(10): - Continued

IIa. Handset

[] Dual Access Criteria Check for EUT not Implemented the Upper Threshold:

Interference	Reaction of EUT	Results
All Tx and Rx Window, except one for Rx Window	NA	NA
All Tx and Rx Window, except one for Tx Window	NA	NA

IIb. Handset

[x] Dual Access Criteria Check for EUT Implemented the Upper Threshold:

Interference	Reaction of EUT	Results
All Tx windows with level $T_L + U_M$ & Rx windows with level $T_L + U_M + 7\text{dB}$, except one for Tx window & one for Rx window, which are not duplex.	A	Pass
All Tx windows with level $T_L + U_M + 7\text{dB}$ & Rx windows with level $T_L + U_M$, except one for Tx window & one for Rx, which are not duplex	B	Pass
All Tx & Rx windows with level $T_U + U_M$, except one for Tx window & one for Rx Window, which are not duplex	D	Pass

- A – Could be connected on the target Rx window and its duplex mate
- B – Could be connected on the target Tx window and its duplex mate
- C – Connected on window which is not the target Tx/Rx window
- D – Could not be connected

- NA – Not applicable

Issuing Laboratory:
Intertek Testing Services Hong Kong Limited

Hong Kong Accreditation Service (HKAS) has accredited this laboratory under the Hong Kong Laboratory Accreditation Scheme (HOKLAS) for specific laboratory activities as listed in the HOKLAS directory of accredited laboratories. The results shown in this report were determined by this laboratory in accordance with its terms of accreditation.



4.24 Alternative Monitoring Interval for Co-located Device, FCC Rule 15.323(c)(11):

An initiating device that is prevented from monitoring during its intended transmit window due to monitoring system blocking from the transmissions of a co-located (within one meter) transmitter of the same system, may monitor the portions of the time and spectrum windows in which they intend to receive over a period of at least 10 ms. The monitored time and spectrum window must total at least 50 % of the 10 ms frame interval and the monitored spectrum must be within the 1.25 MHz frequency channel(s) already occupied by that device or co-located co-operating devices. If the access criteria is met for the intended receive time and spectrum window under the above conditions, then transmission in the intended transmit window by the initiating device may commence.

Measurements are made in accordance with ANSI C63.17 sub-clause 8.4.

Attestation:

- [] Appropriate as it is co-located device, in which the monitoring system will be blocked from the transmissions of a co-located (Within one meter) transmitter of the same system. Please refer to attachment, 15.323(c)(11).pdf, for details.
- [x] Not appropriate, as the system always monitor both the transmit and receive time/spectrum windows, it is not a co-located device.

Issuing Laboratory:
Intertek Testing Services Hong Kong Limited

Hong Kong Accreditation Service (HKAS) has accredited this laboratory under the Hong Kong Laboratory Accreditation Scheme (HOKLAS) for specific laboratory activities as listed in the HOKLAS directory of accredited laboratories. The results shown in this report were determined by this laboratory in accordance with its terms of accreditation.



4.25 Fair Access, FCC Rule 15.323(c)(12):

The provisions of FCC Rule 15.323(c)(10) or (c)(11) shall not be used to extend the range of spectrum occupied over space or time for the purpose of denying fair access to spectrum to other devices.

Attestation:

The manufacturer declares that the device does not use any mechanisms as provided by Part 15.323(c)(10) or (c)(11) to extend the range of spectrum occupied over space or time for the purpose of denying fair access to spectrum to other devices.

Please refer to the declaration letter which is saved with filename: declaration.pdf.

Issuing Laboratory:
Intertek Testing Services Hong Kong Limited

Hong Kong Accreditation Service (HKAS) has accredited this laboratory under the Hong Kong Laboratory Accreditation Scheme (HOKLAS) for specific laboratory activities as listed in the HOKLAS directory of accredited laboratories. The results shown in this report were determined by this laboratory in accordance with its terms of accreditation.



5.0 Equipment List

1) Radiated Emissions Test

Equipment	EMI Test Receiver	Log Periodic Antenna	Double Ridged Guide Antenna (1GHz -18GHz)
Registration No.	EW-2500	EW-0446	EW-1133
Manufacturer	R&S	EMCO	EMCO
Model No.	ESCI	3146	3115
Calibration Date	Feb. 24, 2012	Oct. 31, 2011	Mar. 02, 2011
Calibration Due Date	Feb. 24, 2013	Apr. 30, 2013	Sep. 02, 2012

Equipment	Spectrum Analyzer	Biconical Antenna 20MHz to 200MHz	Broad-Band Horn Antenna
Registration No.	EW-2188	EW-2512	EW-1679
Manufacturer	AGILENTECH	EMCO	SCHWARZBECK
Model No.	E4407B	3104C	BBHA9170
Calibration Date	Sep. 26, 2011	Nov. 15, 2011	Mar. 21, 2012
Calibration Due Date	Sep. 26, 2012	May. 15, 2013	Mar. 21, 2013

2) Conducted Emissions Test

Equipment	EMI Test Receiver (9kHz to 7GHz)	Artificial Mains	Pulse Limiter
Registration No.	EW-2666	EW-0192	EW-0698
Manufacturer	R&S	R&S	R&S
Model No.	ESCI7	ESH3-Z5	ESH3-Z2
Calibration Date	May. 21, 2012	Apr. 11, 2012	Apr. 06, 2012
Calibration Due Date	May. 21, 2013	Apr. 11, 2013	Apr. 06, 2013

3) Conductive Measurement Test

Equipment	Coaxial directional coupler	Spectrum Analyzer	Digital Radiocommunication Tester for DECT
Registration No.	EW-2337	EW-2253	EW-2250
Manufacturer	MAGNA	R&S	R&S
Model No.	4222-16	FSP40	CMD60
Calibration Date	Nil*	Jan. 12, 2012	Aug. 18, 2011
Calibration Due Date	Nil*	Jan. 12, 2013	Aug. 18, 2012

Equipment	Digital Multimeter	Vector Signal Generator	Temperature & Humidity Chamber
Registration No.	EW-1017	EW-2411	EW-2134
Manufacturer	FLUKE	ROHDESCHWARZ	GIANT FORCE
Model No.	87-IV	SMU200A	GTH-750-40-CP-SD
Calibration Date	Jun. 06, 2012	Feb. 15, 2012	Sep. 02, 2011
Calibration Due Date	Jul. 06, 2013	Feb. 15, 2013	Aug. 29, 2012

END OF TEST REPORT

Test Report Number: HK12070743-1
FCC ID: EW780-9041-00

Page 71 of 71

Intertek Testing Services Hong Kong Ltd.

2/F., Garment Centre, 576 Castle Peak Road, Kowloon, Hong Kong.
Tel: (852) 2173 8888 Fax: (852) 2785 5487 Website: www.hk.intertek-etlsemko.com