



at&t

User's manual

TL88102/TL88202

DECT 6.0 2-line

cordless telephone/
answering system with
caller ID/call waiting



Congratulations

on your purchase of this AT&T product. Before using this AT&T product, please read the **Important safety information** section on pages 93-94 of this manual. Please thoroughly read this user's manual for all the feature operations and troubleshooting information necessary to install and operate your new AT&T product. You can also visit our website at **www.telephones.att.com** or call **1 (800) 222-3111**. In Canada, dial **1 (866) 288-4268**.

Model number: TL88102 (one handset)

TL88202 (two handsets)

Type: DECT 6.0 2-line cordless telephone/answering system
with caller ID/call waiting

Serial number: _____

Purchase date: _____

Place of purchase: _____

Both the model and serial numbers of your AT&T product can be found on the bottom of the telephone base.

Save your sales receipt and original packaging in case it is necessary to return your telephone for warranty service.



Telephones identified with this logo have reduced noise and interference when used with most T-coil equipped hearing aids and cochlear implants. The TIA-1083 Compliant Logo is a trademark of the Telecommunications Industry Association. Used under license.



The ENERGY STAR® program (www.energystar.gov) recognizes and encourages the use of products that save energy and help protect our environment. We are proud to mark this product with the ENERGY STAR® label indicating it meets the latest energy efficiency guidelines.

Parts checklist

Your telephone package contains the following items. Save your sales receipt and original packaging in the event warranty service is necessary.

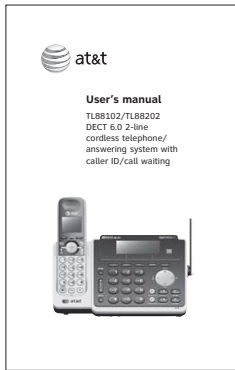

User's manual

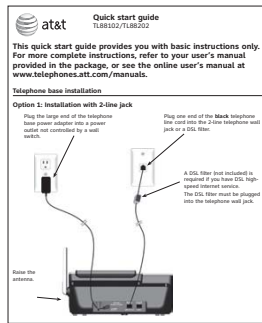

Quick start guide



Cordless handset
(1 for TL88102)
(2 for TL88202)



Telephone base



Charger for cordless handset
with power adapter installed
(1 for TL88202)



Belt clip
(1 for TL88102)
(2 for TL88202)



Battery for cordless handset
(1 for TL88102)
(2 for TL88202)



Battery compartment cover
(1 for TL88102)
(2 for TL88202)



Telephone line cords (2)

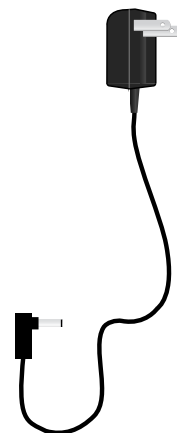

Power adapter for telephone base

Complete user's manual

TL88102/TL88202
DECT 6.0 2-line
cordless telephone/
answering system with
caller ID/call waiting



Table of contents

Getting started

Quick reference guide - handset.....	1
Quick reference guide - telephone base.....	3
Installation.....	5
Telephone base and charger installation.....	6
Telephone base installation.....	6
Charger installation.....	7
Battery installation and charging.....	8
Belt clip and optional headset.....	10
Belt Clip.....	10
Headset.....	10

Telephone settings

Handset settings.....	11
Ringer volume.....	12
Ringer tone.....	12
LCD language.....	13
Voicemail (visual message waiting) indicator.....	13
Clear voicemail indication.....	13
Key tone.....	14
Set date/time.....	15
Home area code.....	16
Telephone base settings.....	17
Ringer volume.....	18
Ringer tone.....	18
LCD language.....	19
Voicemail (visual message waiting) indicator.....	19
Clear voicemail indication.....	19

Key tone.....	20
Set date/time.....	21
Home area code.....	22

Telephone operation

Telephone operation.....	23
Make, answer or end a call.....	23
Silence the ringer.....	24
Handset speakerphone.....	24
Last number redial.....	24
Options while on call.....	27
Volume Control.....	27
Call waiting.....	27
Mute.....	27
Hold.....	28
Chain dialing.....	29

Multiple Handset use

Multiple handset use.....	31
Join a call in progress.....	31
Handset locator.....	31
Intercom.....	32
Answer an incoming call during an intercom call.....	33
Call Transfer using intercom.....	34
Transfer a call.....	34
Conference Call.....	36
Share an outside call.....	36
Conference line 1 and line 2 calls.....	36
Answer an incoming call during a conference call.....	38

Directory

About the directory.....	39
Shared directory.....	39
Capacity.....	39
Character chart.....	39
Create directory entries.....	40
Create a new directory entry.....	40
Review the directory.....	42
Review directory entries	42
Search by name.....	43
Dial, delete or edit directory entries	44
Dial a directory entry.....	44
Delete a directory entry.....	44
Edit a directory entry.....	44
Speed dial.....	46
Assign a speed dial number.....	46
Review the speed dial entries.....	48
Dial a speed dial entry.....	48
Edit a speed dial entry.....	49
Reassign a speed dial entry.....	50
Delete a speed dial entry.....	50

Caller ID

About caller ID	51
Information about caller ID with call waiting	51
Caller ID history.....	52
How the caller ID history (call log) works.....	52
Missed (new) call indicator	52
Caller ID operation.....	53
Memory match.....	53
Review the caller ID history	54
View dialing options.....	55
Dial a call log entry.....	55
Save a call log entry to the directory	56
Delete from the call log.....	57
Reasons for missing caller information	58

Answering system

Answering system settings.....	59
Announcement.....	59
Answer ON/OFF.....	63
Call screening.....	64

Number of rings.....	65
Remote access code.....	66
Message alert tone.....	67
About the answering system.....	68
Answering system and voicemail indicators.....	68
Using the answering system and voicemail together.....	68
Message capacity	69
New message indication.....	69
Voice prompts	69
Call screening.....	69
Call intercept.....	70
Base ringer.....	70
Temporarily turning off the message alert tone.....	70
Message playback.....	71
Message playback.....	71
Delete all messages.....	72
Recording and playing memos.....	73
Record a memo.....	73
Play back a memo	74
Remote access.....	75

Appendix

Adding and registering handsets ...	76
Register a handset to the telephone base.....	76
Deregistering handsets	77
Deregister all handsets from the telephone base	77
Handset and telephone base indicators.....	78
Handset screen icons	78
Telephone base screen icons	79
Alert tones and lights.....	80
Handset alert tones.....	80
Telephone base alert tones.....	80
Handset lights	81
Telephone base lights	81
Screen display messages	82
Screen messages	82
Troubleshooting	84
Maintenance.....	92
Important safety information	93
FCC Part 68 and ACTA.....	95
FCC Part 15.....	96

Limited warranty.....	97
Technical specifications	99
DECT 6.0 digital technology	99
Telephone operating range	99
Redefining long range coverage and clarity	99

Index

Index	100
-------------	-----

Quick reference guide - handset

CHARGE light

- On when the handset is charging in the telephone base or charger (page 9).

REDIAL/PAUSE

- Press to review the redial list (page 24).
- While dialing or entering numbers into the directory, press and hold to insert a dialing pause (pages 23 and 40).

▲DIR/VOLUME

- Press to enter the directory when the telephone is not in use (page 42).
- Press to scroll up while in menus.
- During a call or message playback, press to increase the listening volume (pages 27 and 71).
- While entering names or numbers, press to move the cursor to the right.

LINE 1/FLASH

- Press to make or answer a call on line 1 (page 23).
- During a call, press to answer an incoming call on line 1 when you receive a call waiting alert (page 27).

1

- While reviewing a call log entry, press repeatedly to add or remove 1 in front of the telephone number before dialing or saving it in the directory (page 55).

🔊/SPEAKER

- Press to make or join a call using the first available line, starting with line 1 (page 24).
- Press to answer a call using the speakerphone (page 23).
- During a call, press to switch between speakerphone and handset use (page 24).

Soft keys (2)

- Press to select a menu item displayed above the key.

📵OFF

- During a call, press to hang up (page 23).
- Press and hold while the telephone is not in use to erase the missed calls indicator (page 52).
- Press to delete a digit or character while entering a number or name.
- While in a menu, press to cancel an operation, back up to the previous menu, or exit the menu display, or press and hold to return to the idle mode.

▼CID/VOLUME

- Press to review the call log when the telephone is not in use (page 54).
- Press to scroll down while in menus.
- During a call or message playback, press to decrease the listening volume (pages 27 and 71).
- While entering names or numbers, press to move the cursor to the left.

LINE 2/FLASH

- Press to make or answer a call on line 2 (page 23).
- During a call, press to answer an incoming call on line 2 when you receive a call waiting alert (page 27).

(pound key)

- Press repeatedly to show other dialing options when reviewing a call log entry (page 55).

INT

- Press to initiate an intercom conversation (page 32) or transfer a call (page 34).

HOLD

- Press to put a call on hold (page 28).

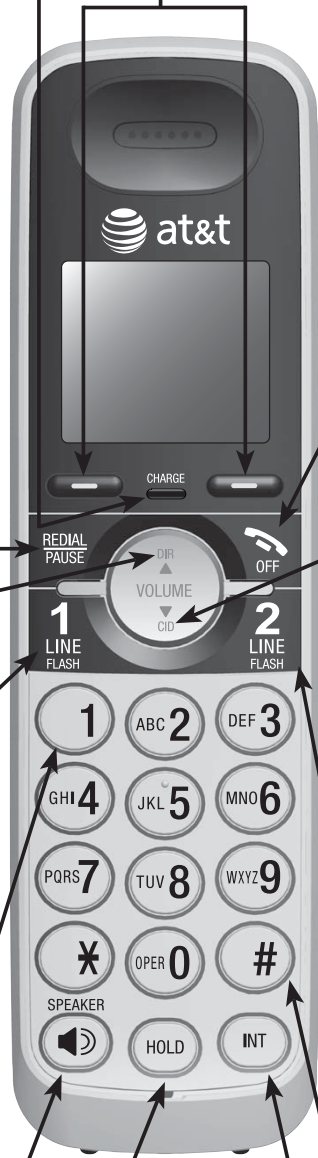

Main menu



Main menu

- ANSWERING SYS (page 59)
- DIRECTORY (page 39)
- CALL LOG (page 51)
- RINGERS page 12)
- SETTINGS (page 11)

Using menus:

- Press the **MENU** soft key to show the menu.
- Press **▼CID** or **▲DIR** to scroll through menu items.
- Press the **SELECT** soft key to confirm or save changes to a highlighted menu item.
- Press the **BACK** soft key or **OFF** to cancel an operation, back to the previous menu without making any changes, or exit the menu display.

Quick reference guide - telephone base

▲/VOLUME/▼

- During a call, press to adjust the speakerphone volume (page 27).
- Press to adjust the volume during message playback (page 71).
- While the telephone base is ringing, press the increase or decrease the ringer volume.
- When the telephone is not in use, press to adjust the telephone base ringer volume for all lines (page 70).

1

- While reviewing a call log entry, press repeatedly to add or remove 1 in front of the telephone number before dialing or saving it in the directory (page 55).

HOLD

- Press to put a call on hold (page 28).

FLASH

- During a call, press to answer an incoming call when you receive a call waiting alert (page 27).

(pound key)

- Press repeatedly to show other dialing options when reviewing a call log entry (page 55).

📞/ANSWER ON 1

- Press to turn the answering system of line 1 on or off (page 63).

📞/ANSWER ON 2

- Press to turn the answering system of line 2 on or off (page 63).

X/DELETE

- Press to delete messages (pages 71 and page 72).

◀/REPEAT

- Press to repeat a message or press twice to play the previous message (page 71).

▶/SKIP

- Press to skip to the next message (page 71).

•/REC

- Press to record a memo (page 73) or an outgoing announcement (page 60).



📞/LINE 1

- Press to make or answer a call on line 1 (page 23).

📞/LINE 2

- Press to make or answer a call on line 2 (page 23).

▶/MAIL BOX 1

- Press to start or stop message playback of the mailbox of line 1 (page 71).

▶/MAIL BOX 2

- Press to start or stop message playback of the mailbox of line 2 (page 71).

Quick reference guide - telephone base

▼CID

- Press to review the call log when the telephone is not in use (page 54).
- Press to scroll down while in menus.
- While entering names or numbers, press to move the cursor to the left.

▲DIR

- Press to enter the directory when the telephone is not in use (page 42).
- Press to scroll up while in menus.
- While entering names or numbers, press to move the cursor to the right.

CANCEL

- While in a menu setting item, press to exit without making changes or press and hold to return to idle mode.
- While the telephone base is ringing, press to silence the ringer temporarily (page 24).
- Press and hold to erase the missed calls indicator while the telephone is not in use (page 52).
- While entering names or numbers, press to delete a character or a digit.

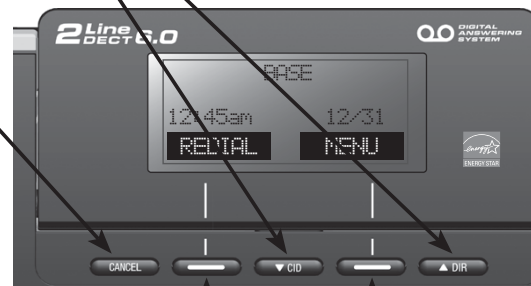

Soft keys (2)

- Press to select a menu item displayed above the key.



Main menu

- Answering sys (page 59)
- Directory (page 39)
- Call log (page 51)
- Page all HS (page 31)
- Intercom (page 32)
- Ringers (page 18)
- Settings (page 17)

Using menus:

- Press the **MENU** soft key to show the menu.
- Press **▼CID** or **▲DIR** to scroll through menu items.
- Press the **SELECT** soft key to confirm or save changes to a highlighted menu item.
- Press the **BACK** soft key or **CANCEL** to cancel an operation, back to the previous menu without making any changes, or exit the menu display.

You must install and charge the battery before using the telephone.



STOP!

See page 8-9 for easy instructions.

Install the telephone base close to a telephone jack and a power outlet not controlled by a wall switch. For optimum range and better reception, place the telephone base in a central and open location.

If you subscribe to high-speed Internet service (DSL - digital subscriber line) through your telephone line, you must install a DSL filter between the telephone line cord and the telephone wall jack (see pages 6-7). The filter prevents noise and caller ID problems caused by DSL interference. Please contact your DSL service provider for more information about DSL filters.

Your product may be shipped with protective stickers covering the handset and telephone base displays - remove them before use.

For customer service or product information, visit our website at **www.telephones.att.com** or call **1 (800) 222-3111**. In Canada, dial **1 (866) 288-4268**.

Avoid placing the telephone base too close to:

- Communication devices such as television sets, VCRs, or other cordless telephones.
- Excessive heat sources.
- Noise sources such as a window with traffic outside, motors, microwave ovens, refrigerators, or fluorescent lighting.
- Excessive dust sources such as a workshop or garage.
- Excessive moisture.
- Extremely low temperature.
- Mechanical vibration or shock such as on top of a washing machine or workbench.

Telephone base and charger installation

Telephone base installation

If you subscribe to digital subscriber line (DSL) high-speed Internet service through your telephone line, you must install a DSL filter between each telephone line cord and telephone wall jack. The filter prevents noise and caller ID problems caused by DSL interference. Contact your DSL service provider for more information about DSL filters.

If you have a 2-line wall jack, install the telephone base as shown in **Option 1** below.

If you have separate wall jacks for each line, install the telephone base as shown in **Option 2** on the next page.

Option 1: Installation with 2-line jack

Plug the large end of the telephone base power adapter into a power outlet not controlled by a wall switch.

Plug one end of the **black** telephone line cord into the 2-line telephone wall jack or a DSL filter.

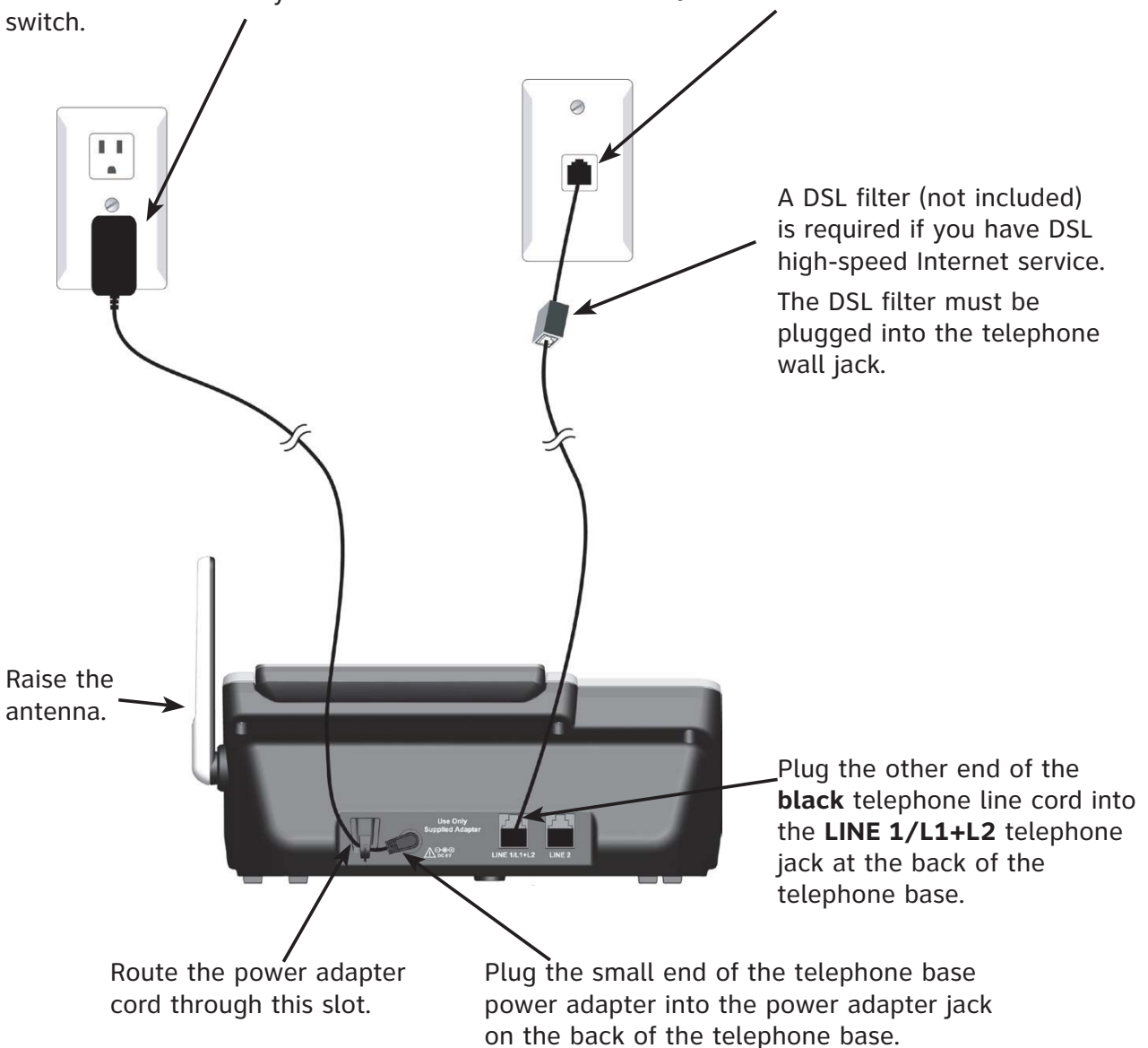

Telephone base and charger installation

Option 2: Installation with separate line jacks

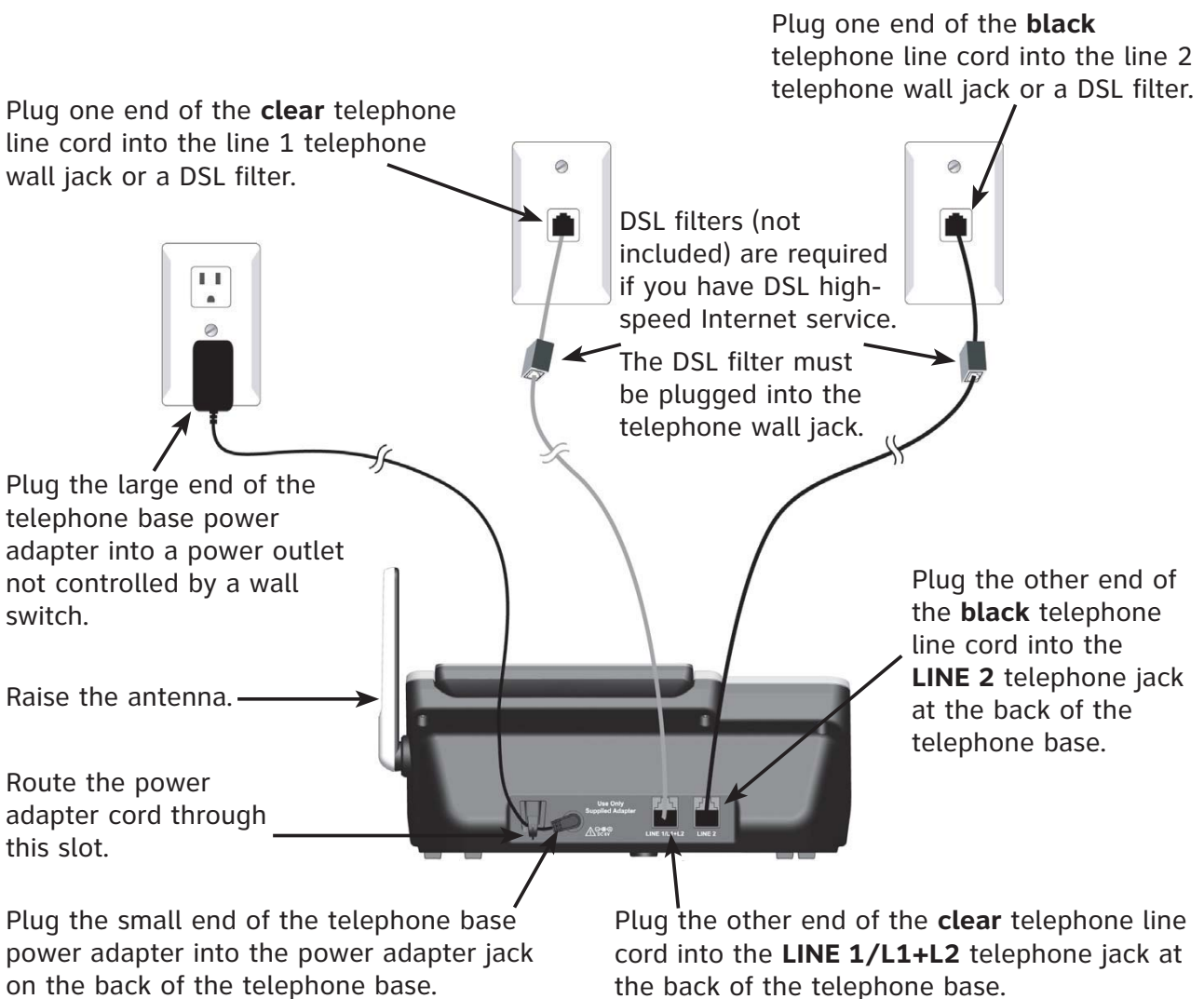

Charger installation

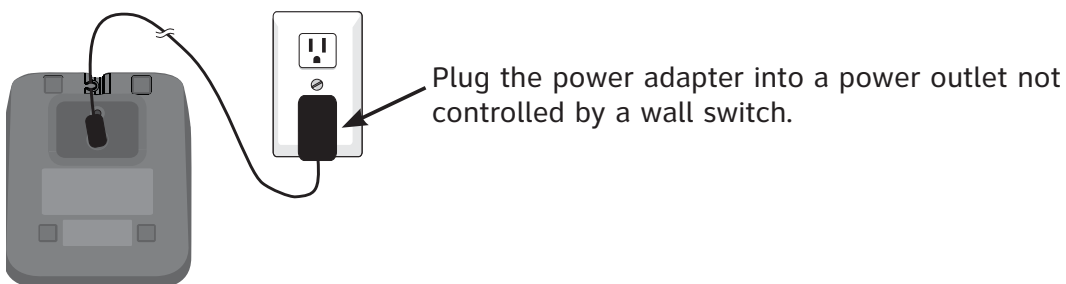



IMPORTANT INFORMATION

- Use only the power adapter(s) supplied with this product. To order a replacement power adapter, visit our website at www.telephones.att.com or call **1 (800) 222-3111**. In Canada, dial **1 (866) 288-4268**.
- The power adapters are intended to be correctly oriented in a vertical or floor mount position. The prongs are not designed to hold the plug in place if it is plugged into a ceiling, under-the-table or cabinet outlet.

Battery installation and charging

Install the battery as shown below. Once you have installed the battery, the screen indicates the battery status (see the table below). If necessary, place the handset in the telephone base or charger to charge the battery. For best performance, keep the handset in the telephone base or charger when not in use. The battery is fully charged after 16 hours of continuous charging.

If the screen shows **Place handset in charger** and  flashes, you need to charge the handset without interruption for at least 30 minutes to give the handset enough charge to use the telephone for a short time. The following table summarizes the battery charge indicators and actions to take.

Battery indicators	Battery status	Action
The screen is blank, or shows Place handset in charger and  (flashing).	Battery has no or very little charge. The handset cannot be used.	Charge without interruption (at least 30 minutes).
The screen shows Low battery and  (flashing).	Battery has enough charge to be used for a short time.	Charge without interruption (at least 30 minutes).
The screen shows HANDSET X.	Battery is charged.	To keep the battery charged, place it in the telephone base or charger when not in use.



NOTE: If you are on a phone call in low battery mode, you hear four short beeps every minute.

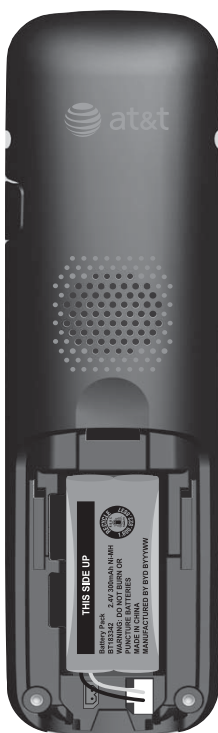

Step 1

Plug the battery connector securely into the socket inside the handset battery compartment. Insert the supplied battery with the label **THIS SIDE UP** facing up as indicated.

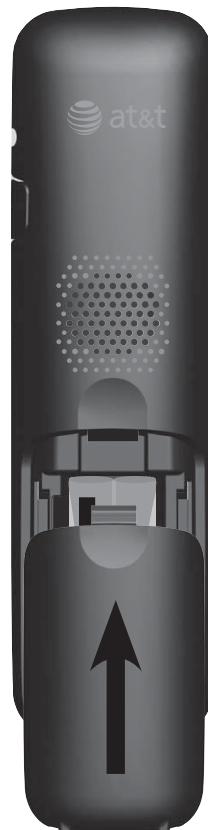

Step 2

Align the cover flat against the battery compartment, then slide it upwards until it clicks into place.

Battery installation and charging

CHARGE light



Step 3

Charge the handset by placing it face forward in the telephone base or charger. The **CHARGE** light under the screen of the handset is on during charging.

After you install your telephone or power returns following a power outage, you have to reset the date and time. For instructions, see **Set date/time** on pages 15 and 21.

IMPORTANT INFORMATION

- Use only the supplied rechargeable battery or replacement battery (model BT183342). To order, visit our website at www.telephones.att.com or call **1 (800) 222-3111**. In Canada, dial **1 (866) 288-4268**.
- If you do not use the handset for a long time, disconnect and remove the battery to prevent possible leakage.

Belt clip and optional headset

Belt Clip



Headset

For handsfree telephone conversation, you can use any industry standard 2.5mm headset (purchased separately). For best results, use an **AT&T** 2.5mm headset. To purchase a headset, visit our website at **www.telephones.att.com** or call **1 (800) 222-3111**. In Canada, dial **1 (866) 288-4268**.

Plug a 2.5mm headset into the jack on the side of the handset (beneath the small plastic cover).



Side view of handset



Handset settings

Use the menu to change the telephone settings.

1. Press the **MENU** soft key on the handset to enter the main menu when the handset is not in use.
2. Press **▼CID** or **▲DIR** to scroll to **SETTINGS**, then press the **SELECT** soft key.
3. Press **▼CID** or **▲DIR** to scroll to the desired item, then press the **SELECT** soft key.
4. When you successfully change a setting, there is a confirmation tone and the screen returns to the previous menu.

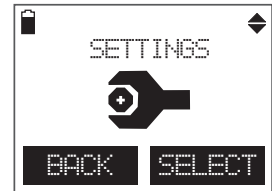

NOTE: Press **OFF** or the **BACK** soft key to cancel an operation, back up to the previous menu or exit the menu display. Press and hold **OFF** to return to idle mode.

Handset settings

Ringer volume

You can set the ringer volume level to one of six levels or turn the ringer off.

1. Press the **MENU** soft key when the handset is not in use.
2. Use **▼CID** or **▲DIR** to scroll to **RINGERS**, then press the **SELECT** soft key.
3. Press the **SELECT** soft key again to select **Ringer volume**.
4. Press **▼CID** or **▲DIR** to choose **Line 1**, **Line 2** or **Lines 1&2**, then press the **SELECT** soft key.
5. Press **▼CID** or **▲DIR** to adjust the volume. A sample of each ringer volume plays as you scroll through the choices. Press the **OFF** soft key to turn off the ringer and **Ringer muted** shows on the screen.
6. Press the **SET** soft key to save your setting or press **OFF** to exit to the previous menu.

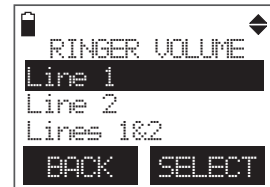
**NOTES:**

- The handset ringer volume also determines the ringer volume for intercom calls.
- If the ringer volume is set to off, that handset is silenced for all incoming calls.
- If you turn off the ringer, a ringer off icon, 🔇_1 , 🔇_2 , or $\text{🔇}_{1&2}$ of the respective phone line(s) flashes on the screen.

Ringer tone

You can choose one of ten ringer tones.

1. Press the **MENU** soft key when the handset is not in use.
2. Use **▼CID** or **▲DIR** to scroll to **RINGERS**, then press the **SELECT** soft key.
3. Press **▼CID** or **▲DIR** to scroll to **Ringer tone**, then press the **SELECT** soft key.
4. Press **▼CID** or **▲DIR** to choose **Line 1**, **Line 2** or **Lines 1&2**, then press the **SELECT** soft key.
5. Press **▼CID** or **▲DIR** to sample each ringer tone.
6. Press the **SET** soft key to save your setting or press the **BACK** soft key to exit to the previous menu.

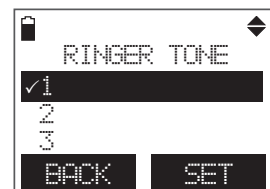
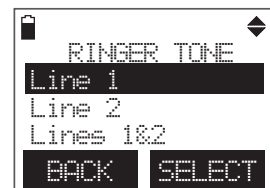

NOTE: If you turn off the ringer volume, you will not hear ringer tone samples.

Handset settings

LCD language

You can select the language used for all screen displays.

1. Press the **MENU** soft key when the handset is not in use.
2. Press **▼CID** or **▲DIR** to scroll to **SETTINGS**, then press the **SELECT** soft key.
3. Press the **SELECT** soft key to select **LCD language**.
4. Press **▼CID** or **▲DIR** to choose **English, Français** or **Español**. Press the **SET** soft key to save your setting, or press the **BACK** soft key to exit to the previous menu.

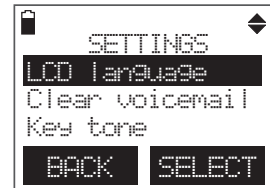
**Voicemail (visual message waiting) indicator**

If you subscribe to voicemail service offered by your telephone service provider, the  icon and a line number appear on both the handset and telephone base when you have new voicemail messages. Contact your telephone service provider for more information and assistance about using your voicemail service.

Clear voicemail indication

Use the clear voicemail indicator feature when the telephone indicates that there is new voicemail but there are none (for example, when you have accessed your voicemail while away from home). The clear voicemail feature only turns off the indicators; it does not delete your voicemail messages. As long as you have new voicemail messages, your telephone service provider continues to send the signal that turns on the indicators.

1. Press the **MENU** soft key when the handset is not in use.
2. Press **▼CID** or **▲DIR** to scroll to **SETTINGS**, then press the **SELECT** soft key.
3. Press **▼CID** or **▲DIR** to scroll to **Clear voicemail**, then press the **SELECT** soft key.
4. Press **▼CID** or **▲DIR** to choose **Line 1, Line 2,** or **Lines 1&2**, then press the **SELECT** soft key. The screen shows **Turn off indicator?**
5. Press the **YES** soft key to confirm, or press the **NO** soft key to exit to the previous menu.

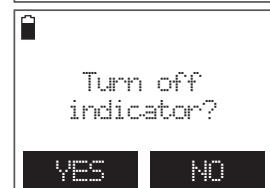
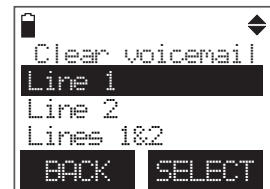
**NOTES:**

- This feature does not indicate new messages recorded on your phone's built-in answering system.
- For more information about the difference between your answering system and voicemail, see page 68.

Handset settings

Key tone

You can turn the key tone feature on or off. If you turn off the key tone, there are no beeps when you press keys.

1. Press the **MENU** soft key when the handset is not in use.
2. Press **▼CID** or **▲DIR** to scroll to **SETTINGS**, then press the **SELECT** soft key.
3. Press **▼CID** or **▲DIR** to scroll to **Key tone**, then press the **SELECT** soft key.
4. Press **▼CID** or **▲DIR** to choose **On** or **Off**.
5. Press the **SET** soft key to save your setting, or press the **BACK** soft key to exit to the previous menu.

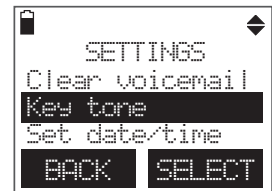

Handset settings

Set date/time

The answering system announces the day and time of each message prior to playing it. If you subscribe to caller ID service, the day, month and time are set automatically with each incoming call. The year must be set so that the day of the week can be calculated from the caller ID information. Before using the answering system, set the date and time as follows.

1. Press the **MENU** soft key when the handset is not in use.
2. Press **▼CID** or **▲DIR** to scroll to **SETTINGS**, then press the **SELECT** soft key.
3. Press **▼CID** or **▲DIR** to scroll to **Set date/time**, then press the **SELECT** soft key.
4. Use the dialing keys (**0-9**) to enter the month in two-digit format, or press **▼CID** or **▲DIR** to choose the correct setting, then press the **SET** soft key to move to set the day.
5. Use the dialing keys (**0-9**) to enter the day in two-digit format, or press **▼CID** or **▲DIR** to choose the correct setting, then press the **SET** soft key to move to set the year.
6. Use the dialing keys (**0-9**) to enter the year in two-digit format, or press **▼CID** or **▲DIR** to choose the correct setting, then press the **SET** soft key to move to set the hour.
7. Use the dialing keys (**0-9**) to enter the hour in two-digit format, or press **▼CID** or **▲DIR** to choose the correct setting, then press the **SET** soft key to move to set the minute.
8. Use the dialing keys (**0-9**) to enter the minute in two-digit format, or press **▼CID** or **▲DIR** to choose the correct setting, then press the **SET** soft key.
9. Press **▼CID** or **▲DIR** to choose between **AM** or **PM**, then press the **SET** soft key to confirm.

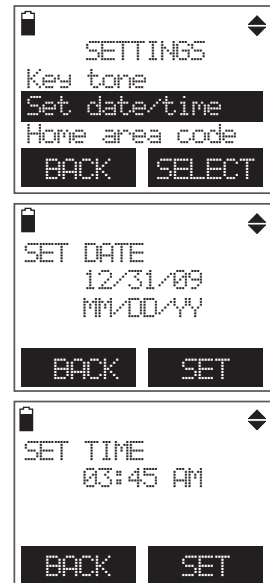

NOTE: If the clock is not set when a message is recorded, the system announces, "Time and day not set," before it plays the message.

Handset settings

Home area code

If you dial seven digits to make a local call (no area code required), enter your area code into the telephone as the home area code. When you receive a call from within your home area code, the caller ID history only displays the seven digits of the telephone number.

This feature makes it easy for you to place a call from the caller ID history. If you dial ten digits to make a local phone call, do not use this home area code feature. If you do, you cannot place local calls from your caller ID history, as they will have only seven digits.

To set the home area code:

1. Press the **MENU** soft key when the handset is not in use.
2. Press **▼CID** or **▲DIR** to scroll to **SETTINGS**, then press the **SELECT** soft key.
3. Press **▼CID** or **▲DIR** to scroll to **Home area code**, then press the **SELECT** soft key.
4. Use the dialing keys (**0-9**) to enter a three-digit home area code. Press **OFF** to delete a digit.
5. Press the **SET** soft key to save your setting, or press the **BACK** soft key to exit to the previous menu.

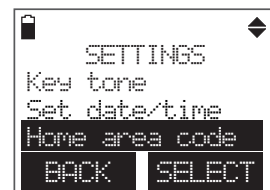

NOTE: If, in the future, your telephone service provider requires you to dial the area code when making a local call, or, if you move to a location that requires it, delete the home area code you have already programmed following the steps above. After you have deleted the home area code, _ _ _ appears in the display.

Telephone base settings

Use the menu to change the telephone settings.

1. Press the **MENU** soft key on the telephone base to enter the main menu when the telephone base is not in use.
2. Press **▼CID** or **▲DIR** to scroll to **Settings**, then press the **SELECT** soft key.
3. Press **▼CID** or **▲DIR** to scroll to the desired item, then press the **SELECT** soft key.
4. When you successfully change a setting, there is a confirmation tone and the screen returns to the previous menu.

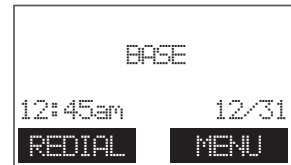

NOTE: Press **CANCEL** or the **BACK** soft key to cancel an operation, back up to the previous menu or exit the menu display. Press and hold CANCEL to return to idle mode.

Telephone base settings

Ringer volume

You can set the ringer volume level to one of six levels or turn the ringer off.

1. Press the **MENU** soft key when the telephone base is not in use.
2. Use **▼CID** or **▲DIR** to scroll to **Ringers**, then press the **SELECT** soft key.
3. Press the **SELECT** soft key again to select **Ringer volume**.
4. Press **▼CID** or **▲DIR** to choose **Line 1**, **Line 2** or **Lines 1&2**, then press the **SELECT** soft key.
5. Press **▼CID** or **▲DIR** to adjust the volume. A sample of each ringer volume plays as you scroll through the choices. Press the **OFF** soft key to turn off the ringer and **Ringer muted** shows on the screen.
6. Press the **SET** soft key to save your setting or press **CANCEL** to exit to the previous menu.

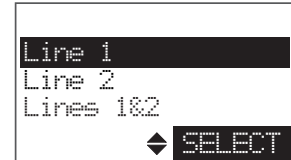

NOTES:

- The telephone base ringer volume also determines the ringer volume for intercom calls.
- If the ringer volume is set to off, the telephone base is silenced for all incoming calls.
- If you turn off the ringer, a ringer off icon, \mathcal{N}_1 , \mathcal{N}_2 , or $\mathcal{N}_{1/2}$ of the respective phone line(s) flashes on the screen.

Ringer tone

You can choose one of the ten ringer tones.

1. Press the **MENU** soft key when the handset is not in use.
2. Use **▼CID** or **▲DIR** to scroll to **Ringers**, then press the **SELECT** soft key.
3. Press **▼CID** or **▲DIR** to scroll to **Ringer tone**, then press the **SELECT** soft key.
4. Press **▼CID** or **▲DIR** to choose **Line 1**, **Line 2** or **Lines 1&2**, then press the **SELECT** soft key.
5. Press **▼CID** or **▲DIR** to sample each ringer tone.
6. Press the **SET** soft key to save your setting or press **CANCEL** to exit to the previous menu.

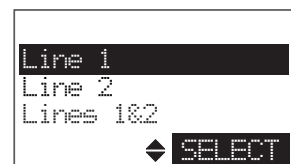

NOTE: If you turn off the ringer volume, you will not hear ringer tone samples.

Telephone base settings

LCD language

You can select the language used for all screen displays.

1. Press the **MENU** soft key when the telephone base is not in use.
2. Press **▼CID** or **▲DIR** to scroll to **Settings**, then press the **SELECT** soft key.
3. Press the **SELECT** soft key to select **LCD language**.
4. Press **▼CID** or **▲DIR** to choose **English**, **Français** or **Español**. Press the **SET** soft key to save your setting, or press **CANCEL** to exit to the previous menu.

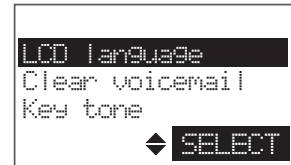

Voicemail (visual message waiting) indicator

If you subscribe to voicemail service offered by your telephone service provider, the  icon and a line number appear on both the handset and telephone base when you have new voicemail messages. Contact your telephone service provider for more information and assistance about using your voicemail service.

Clear voicemail indication

Use the clear voicemail indicator feature when the telephone indicates that there is new voicemail but there are none (for example, when you have accessed your voicemail while away from home). The clear voicemail feature only turns off the indicators; it does not delete your voicemail messages. As long as you have new voicemail messages, your telephone service provider continues to send the signal that turns on the indicators.

1. Press the **MENU** soft key when the handset is not in use.
2. Press **▼CID** or **▲DIR** to select **Settings**, then press the **SELECT** soft key.
3. Press **▼CID** or **▲DIR** to select **Clear voicemail**, then press the **SELECT** soft key.
4. Press **▼CID** or **▲DIR** to choose **Line 1**, **Line 2**, or **Lines 1&2**, then press the **SELECT** soft key. The screen shows **Turn off indicator?**
5. Press the **YES** soft key to save, or press the **NO** soft key to exit to the previous menu.

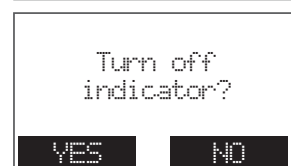
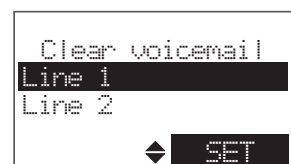
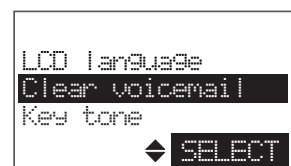

NOTES:

- This feature does not indicate new messages recorded on your phone's built-in answering system.
- For more information about the difference between your answering system and voicemail, see page 68.

Telephone base settings

Key tone

You can turn the key tone feature on or off. If you turn off the key tone, there are no beeps when you press keys.

1. Press the **MENU** soft key when the telephone base is not in use.
2. Press ▼**CID** or ▲**DIR** to scroll to **Settings**, then press the **SELECT** soft key.
3. Press ▼**CID** or ▲**DIR** to scroll to **Key tone**, then press the **SELECT** soft key.
4. Press ▼**CID** or ▲**DIR** to choose **On** or **Off**.
5. Press the **SET** soft key to save your setting or press **CANCEL** to exit to the previous menu.

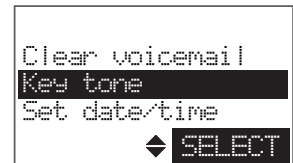

Telephone base settings

Set date/time

The answering system announces the day and time of each message prior to playing it. If you subscribe to caller ID service, the day, month and time are set automatically with each incoming call. The year must be set so that the day of the week can be calculated from the caller ID information. Before using the answering system, set the date and time as follows.

1. Press the **MENU** soft key when the telephone base is not in use.
2. Press **▼CID** or **▲DIR** to scroll to **Settings**, then press the **SELECT** soft key.
3. Press **▼CID** or **▲DIR** to select **Set date/time**, then press the **SELECT** soft key.
4. Use the dialing keys (**0-9**) to enter the month in two-digit format, or press **▼CID** or **▲DIR** to choose the correct setting, then press the **SET** soft key to move to set the day.
5. Use the dialing keys (**0-9**) to enter the day in two-digit format, or press **▼CID** or **▲DIR** to choose the correct setting, then press the **SET** soft key to move to set the year.
6. Use the dialing keys (**0-9**) to enter the year in two-digit format, or press **▼CID** or **▲DIR** to choose the correct setting, then press the **SET** soft key to move to set the hour.
7. Use the dialing keys (**0-9**) to enter the hour in two-digit format, or press **▼CID** or **▲DIR** to choose the correct setting, then press the **SET** soft key to move to set the minute.
8. Use the dialing keys (**0-9**) to enter the minute in two-digit format, or press **▼CID** or **▲DIR** to choose the correct setting, then press the **SET** soft key.
9. Press **▼CID** or **▲DIR** to choose between **AM** or **PM**, then press the **SET** soft key to confirm.

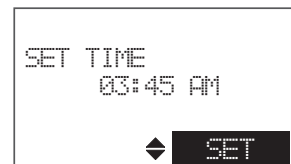

NOTE: If the clock is not set when a message is recorded, the system announces, "Time and day not set," before it plays the message.

Telephone base settings

Home area code

If you dial seven digits to make a local call (no area code required), enter your area code into the telephone as the home area code. When you receive a call from within your home area code, the caller ID history only displays the seven digits of the telephone number.

This feature makes it easy for you to place a call from the caller ID log. If you dial ten digits to make a local phone call, do not use this home area code feature. If you do, you cannot place local calls from your caller ID log, as they will have only seven digits.

To set the home area code:

1. Press the **MENU** soft key when the handset is not in use.
2. Press **▼CID** or **▲DIR** to scroll to **Settings**, then press the **SELECT** soft key.
3. Press **▼CID** or **▲DIR** to scroll to **Home area code**, then press the **SELECT** soft key.
4. Use the dialing keys (**0-9**) to enter a three-digit home area code. Press **CANCEL** to delete a digit.
5. Press the **SET** soft key to save or press the **BACK** soft key to exit to the previous menu.

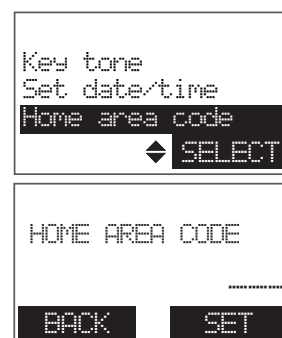

NOTE: If, in the future, your telephone service provider requires you to dial the area code when making a local call, or, if you move to a location that requires it, delete the home area code you have already programmed following the steps above. After you have deleted the home area code, _ _ _ appears in the display.

Telephone operation

Make, answer or end a call

Using the handset:

To make a call:

- Press **LINE 1/FLASH**, **LINE 2/FLASH** or **📞/SPEAKER**, then enter the telephone number.

To predial a call:

- Enter the telephone number, then press **LINE 1/FLASH**, **LINE 2/FLASH** or **📞/SPEAKER** to call.

To answer a call:

- Press **LINE 1/FLASH**, **LINE 2/FLASH** or **📞/SPEAKER** to answer.



NOTES:

- Pressing **📞/SPEAKER** picks the first available line, starting with line 1. Line 1 is selected first when both lines are in use or on hold.
- The screen shows the elapsed time as you talk (in hours, minutes and seconds).
- When predialing (preview numbers before dialing), press **🔙OFF** on the handset to backspace and delete; press and hold **REDIAL/PAUSE** on the handset to insert a dialing pause (a **p** appears).

To end a call:

- Press **🔙OFF** or return the handset to the telephone base or charger to hang up.

Using the telephone base:

To make a call:

- Press **📞/LINE 1** or **📞/LINE 2**, then enter the telephone number.

To predial a call:

- Enter the telephone number, then press **📞/LINE 1** or **📞/LINE 2**.

To answer a call:

- Press **📞/LINE 1** or **📞/LINE 2** to answer.



NOTES:

- The screen shows the elapsed time as you talk (in hours, minutes and seconds).
- When predialing (preview numbers before dialing), press **CANCEL** on the telephone base to backspace and delete; press the **PAUSE** soft key on the telephone base to insert a dialing pause (a **p** appears).

To end a call:

- Press **📞/LINE 1** or **📞/LINE 2**.

Telephone operation

Silence the ringer

When the telephone is ringing, you can temporarily silence the ringer of the handset or telephone base without disconnecting the call. The next call rings normal at the preset volume.

To silence the ringer when there is an incoming call:

- Press the **SILENCE** soft key on the handset or telephone base. The screen temporarily shows **Ringer muted** for a few seconds.

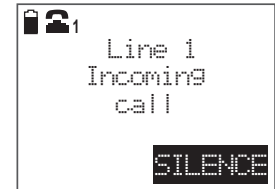

-OR-

- Press **CANCEL** on the telephone base. The screen temporarily shows **Ringer muted** for a few seconds.

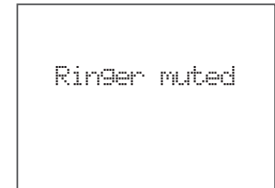

Handset speakerphone

During a call, press **SPEAKER** to switch between speakerphone and normal handset use.

After ending a call on line 1, there may be a few seconds delay before the **SPEAKER** key can accurately determine the availability of line 1. During this time, pressing **SPEAKER** may select line 2 automatically.



Last number redial

The redial list stores up to 20 entries on each of the handsets and the telephone base. When there are already 20 entries, the oldest entry is deleted to make room for the new entry. Entries are shown in reverse chronological order.

To view the 20 most recently dialed numbers:

- Press **REDIAL/PAUSE** on the handset or the **REDIAL** soft key on the telephone base when it is not in use.
- Press **▼CID** or **▲DIR** on the handset or on the telephone base to browse the redial list.

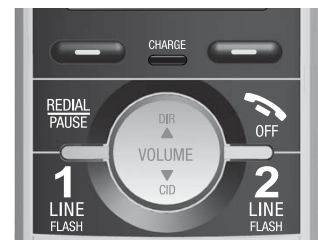

Telephone operation

To redial a number

Using the handset:

1. Press **REDIAL/PAUSE** when the handset is not in use.
2. Press **▼CID** or **▲DIR** to scroll to the desired number.
3. Press **LINE 1/FLASH**, **LINE 2/FLASH** or **📞/SPEAKER** to dial.

Using the telephone base:

1. Press the **REDIAL** soft key and then press **▼CID** or **▲DIR** to scroll to the desired number.
2. Press **📞/LINE1** or **📞/LINE2** to dial.

To save a redial entry to the directory

Using the handset:

1. Press **REDIAL/PAUSE** when the handset is not in use.
2. Press **▼CID** or **▲DIR** to scroll to the desired number, then press the **SAVE** soft key.
3. The screen shows **ENTER NUMBER**. Use the dialing keys to edit the number, if necessary.
4. Press the **NEXT** soft key to move to the name.
5. The screen displays **ENTER NAME**. Use the dialing keys to enter the name.
6. Press the **SAVE** soft key and **Saved to Directory** displays for a few seconds.

Using the telephone base:

1. Press the **REDIAL** soft key when the telephone base is not in use.
2. Press **▼CID** or **▲DIR** to scroll to the desired number, then press the **SAVE** soft key.
3. The screen shows **ENTER NUMBER**. Use the dialing keys to edit the number, if necessary.
4. Press the **NEXT** soft key to move to the name.
5. The screen displays **ENTER NAME**. Use the dialing keys to enter the name.
6. Press the **SAVE** soft key and **Saved to Directory** displays for a few seconds.

Telephone operation

Telephone operation

To delete a redial entry

Using the handset:

1. Press **REDIAL/PAUSE** and then press **▼CID** or **▲DIR** to scroll to the desired number.
2. Press the **DELETE** soft key to delete the displayed entry.

Using the telephone base:

1. Press the **REDIAL** soft key and then press **▼CID** or **▲DIR** to scroll to the desired number.
2. Press the **DELETE** soft key to delete the displayed entry.

Options while on call

Volume Control

During a call, you can adjust the listening volume on the handset or telephone base.

To adjust the listening volume of the handset:

- Press ▲/**VOLUME**/▼ on the handset while on a call.

To adjust the listening volume of the telephone base:

- Press ▲/**VOLUME**/▼ on the telephone base while on a call.

Call waiting

When you subscribe to call waiting service from your telephone service provider, you hear an alert tone if there is an incoming call while you are on another call.

- Press the corresponding line button, **LINE 1/FLASH** or **LINE 2/FLASH**, on the handset or **FLASH** on the telephone base to put your current call on hold and take the new call.
- Press the corresponding line button, **LINE 1/FLASH** or **LINE 2/FLASH** on the handset or **FLASH** on the telephone base at any time to switch back and forth between calls.



NOTE: Missed call waiting calls are not counted as missed calls.

Mute

During a call, the mute function enables you to turn off the microphone. You can hear the caller, but the caller cannot hear you.

To mute a call on the handset or telephone base:

- Press the **MUTE** soft key to turn off the microphone. The screen temporarily shows **Microphone off** for a few seconds and **MUTE** appears.



To take the handset or telephone base off mute:

- Press the **UNMUTE** soft key to resume the conversation. The screen temporarily shows **Microphone ON** for a few seconds.





Options while on call

Hold

During a call, you can place a call on hold. You hear an alert tone if you have not taken the call off of hold after 14 minutes. You hear another alert tone 30 seconds later. At 15 minutes on hold, the call automatically disconnects.



To place a call on hold using the handset or telephone base:

Press **HOLD** on the handset or telephone base.

- **L1)ON HOLD** appears on the screen while you are on a call on line 1. ₁ flashes on the handset and the telephone base.
- **L2)ON HOLD** appears on the screen while you are on a call on line 2. ₂ flashes on the handset and the telephone base.



To resume a call on hold using the handset or telephone base:

- On the handset, press the corresponding line button, **LINE 1/FLASH** or **LINE 2/FLASH**, to resume the call.
- On the telephone base, press the corresponding line button, /**LINE 1** or /**LINE 2**, to resume the call.

Options while on call

Chain dialing

Use this feature to initiate a dialing sequence from numbers stored in the directory, call log or redial while you are on a call.

Chain dialing can be useful if you wish to access other numbers (such as bank account information or access codes) from the directory, call log or redial list.

To access a number in the directory while on a call:

Press **▲DIR** on the telephone base and then press **▼CID** or **▲DIR** to select the desired entry. Press the **DIAL** soft key to dial the displayed number or press **CANCEL** to cancel the chain dialing.

-OR-

1. Press the **OPTION** soft key on the handset or telephone base.
2. Press **▼CID** or **▲DIR** on the handset or on the telephone base to select **Directory**, then press the **SELECT** soft key.
3. Press **▼CID** or **▲DIR** on the handset or on the telephone base to select the desired entry.
4. Press the **DIAL** soft key to dial the displayed number; or press the **BACK** soft key twice on the handset or **CANCEL** twice on the telephone base to cancel the chain dialing.

To access a number in the call log while on a call:

Press **▼CID** on the telephone base and then press **▼CID** or **▲DIR** to select the desired entry. Press the **DIAL** soft key to dial the displayed number or press **CANCEL** to cancel the chain dialing.

-OR-

1. Press the **OPTION** soft key on the handset or telephone base.
2. Press **▼CID** or **▲DIR** on the handset or on the telephone base to select **Call log**. Then press the **SELECT** soft key.
3. Press **▼CID** or **▲DIR** on the handset or on the telephone base to select the desired entry.
4. Press the **DIAL** soft key to dial the displayed number; or press the **BACK** soft key twice on the handset or **CANCEL** twice on the telephone base to cancel the chain dialing.

Options while on call

To access the last number redial while on a call:

Press **REDIAL/PAUSE** on the handset to display the last number dialed. Press the **DIAL** soft key to dial the displayed number or press the **BACK** soft key to cancel the chain dialing.

-OR-

1. Press the **OPTION** soft key on the handset or telephone base.
2. Press **▼CID** or **▲DIR** on the handset or on the telephone base to select **Redial last #**, then press the **SELECT** soft key on the handset or telephone base.
3. Press the **DIAL** soft key to dial the displayed number; or press the **BACK** soft key twice on the handset or **CANCEL** twice on the telephone base to cancel the chain dialing.



NOTES:

- You cannot edit a directory entry while on a call. For more details about the directory, see page 39.
- You cannot copy a call log entry into the directory while on a call. For more details about call log, see page 51.
- If you press **REDIAL/PAUSE** on the handset while on a call, you can only view the most recent call and cannot erase the entry. For more details about the redial memory, see **Last number redial** on pages 24-26.

Multiple handset use

Join a call in progress

You can use up to four system handsets, or three system handsets and the telephone base at the same time on an outside call. If a handset or the telephone base is already on a call on line 1 or line 2 and you would like to join the call, press the corresponding line button on another handset (**LINE 1/FLASH** or **LINE 2/FLASH**) or telephone base (**LINE 1** or **LINE 2**) to join the call.

To end the call, press **OFF** on the handset, place the handset in the telephone base or charger, or press **LINE 1** or **LINE 2** on the telephone base. The call will not be terminated until all handsets and/or the telephone base hang up.

Handset locator

This feature helps you find a misplaced handset.

To start paging:

1. Press the **MENU** soft key when the telephone base is not in use.
2. Press **▼CID** or **▲DIR** to scroll to **Page all HS**, then press the **SELECT** soft key on the telephone base. The telephone base shows **Paging all handsets** and the handset shows ****Paging****.



To end paging:

- Press the **STOP** soft key on the telephone base.

-OR-

- Press **OFF**, **LINE 1/FLASH**, **LINE 2/FLASH**, **SPEAKER**, **INT**, **▼CID**, **▲DIR**, **REDIAL/PAUSE**, **HOLD** or any dialing keys (**0-9**, **#**, **✕**) on the handset.

Intercom

Use the intercom feature for conversations between a handset and the telephone base or between two handsets. You can buy additional expansion handsets (model **TL88002**) for this telephone system. You can register up to 12 handsets to the telephone base (page 76).

To initiate an intercom call with a handset:

1. Press **INT** when the handset is not in use.
2. When you have only one system handset, your handset shows **Calling base** and the telephone base rings and shows **Handset is calling**.

-OR-

When you have more than one system handset, the originating handset shows **INTERCOM TO:**, press **▼CID** or **▲DIR** to select a destination and then press the **SELECT** soft key.

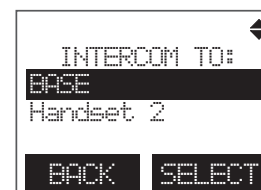

- If you are calling the telephone base, your handset shows **Calling base** and the telephone base rings and shows **Handset X is calling**.
- If you are calling another handset, your handset shows **Calling handset X** and the destination handset rings and shows **Other handset is calling** or **Handset X is calling**.

To initiate an intercom call from the telephone base

1. Press the **MENU** soft key when the telephone base is not in use.
2. Press **▼CID** or **▲DIR** to scroll to **Intercom** and then press the **SELECT** soft key.
3. When you have only one system handset, your telephone base shows **Calling handset** and the handset rings and shows **Base is calling**.

-OR-

When you have more than one system handset, your telephone base shows **INTERCOM TO:**, press **▼CID** or **▲DIR** to select a destination handset and then press the **SELECT** soft key. The telephone base shows **Calling handset X**. The destination handset rings and its screen shows **Base is calling**.

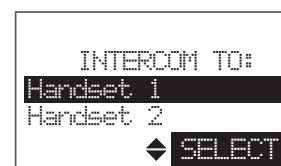

To answer an intercom call at the handset:

- Press **LINE1/FLASH**, **LINE2/FLASH** or **INT** to answer. Both screens show **Intercom**.

To answer an intercom call at the telephone base:

- Press **📞/LINE 1** or **📞/LINE 2**. Both screens show **Intercom**.

Intercom

To silence the ringer of an intercom call:

- Press the **SILENCE** soft key on the destination handset or telephone base.

To end an intercom call:

1. Press the **END** soft key, **CANCEL**, **◀/LINE 1** or **▶/LINE 2** on the telephone base; or press the **END** soft key, **INT** or **↖OFF** on the handset, or place the handset back in the telephone base or charger.
2. Both screens show **Intercom ended**.



NOTES:

- You can cancel the intercom call before it is answered by pressing **↖OFF** or **INT** on your originating handset; or **CANCEL** on the telephone base.
- If the destination handset or telephone base does not answer the intercom call within 100 seconds, is in the directory or call log, or is out of range, your originating handset or telephone base shows **Unable to call try again** and returns to idle mode.
- You can use a maximum of four handsets, or three handsets and the telephone base, at a time. When two handsets are used on an intercom call, use two other system handsets for an outside call.

Answer an incoming call during an intercom call

If you receive an incoming call during an intercom call, there will be an alert tone.

Using the handset:

To answer the call, press **LINE 1/FLASH** for line 1 or **LINE 2/FLASH** for line 2. The intercom call ends automatically.

-OR-

Press the **BACK** soft key to continue with the intercom call without answering the incoming call. Instead, the answering system answers the call.

Using the telephone base:

To answer the call, press **▶/LINE 1** or **▶/LINE 2**. The intercom call ends automatically.

-OR-

Press the **BACK** soft key to continue with the intercom call without answering the incoming call. Instead, the answering system answers the call.

Call Transfer using intercom

Using the intercom feature to transfer an outside call to another system handset or the telephone base. You can also share an outside call with another system handset or the telephone base.

Transfer a call

From the handset:

1. During a call, press **INT**.
2. When you have only one system handset, your handset shows **Calling base** and the telephone base rings and shows **Handset is calling**. The outside call is put on hold automatically.

-OR-

When you have more than one system handset, the originating handset shows **INTERCOM TO:**, press **▼CID** or **▲DIR** to select a destination and then press the **SELECT** soft key. The outside call is put on hold automatically.

- If you are calling the telephone base, your handset shows **Calling base** and the telephone base rings and shows **Handset X is calling**.
 - If you are calling another handset, your handset shows **Calling handset X** and the destination handset rings and shows **Other handset is calling** or **Handset X is calling**.
3. To answer the intercom call, press **📞/LINE 1** or **📞/LINE 2** on the telephone base, or press **LINE 1/FLASH**, **LINE 2/FLASH**, **📞/SPEAKER** or **INT** on the handset. The outside call is still on hold. Both the originating handset and the destination handset or the telephone base now show **Intercom**. You can now have a private conversation between the handset and the telephone base or between the two handsets.



NOTES:

- If you want to cancel an intercom call and reconnect to the outside call before the destination handset or telephone base answers, press the corresponding line button, **LINE 1/FLASH** or **LINE 2/FLASH**, on your originating handset.
 - If the destination handset or telephone base does not answer the intercom call within 100 seconds, is in the directory or call log, or is out of range, your originating handset shows **Unable to call try again** and the outside call is still on hold. Press the corresponding line button, **LINE 1/FLASH** or **LINE 2/FLASH**, on your originating handset to reconnect to the outside call.
4. Press **OFF** or the **END** soft key on the originating handset. Both screens show **Intercom ended**.
 5. The originating handset and the destination handset or telephone base show **L1)ON HOLD** if the call is on line 1. Press **LINE 1/FLASH** on the destination handset or press **📞/LINE 1** on the telephone base. The same procedures apply if the call is on line 2.

Call Transfer using intercom

At the telephone base:

1. During a call, press **HOLD** and the outside call is put on hold. Press the **MENU** soft key and then press **▼CID** or **▲DIR** to scroll to **Intercom**, then press the **SELECT** soft key.

-OR-

During a call, press the **OPTION** soft key and then press **▼CID** or **▲DIR** to scroll to **Intercom**, then press the **SELECT** soft key. The outside call is put on hold automatically.

2. When you have only one system handset, your telephone base shows **Calling handset** and the handset rings and shows **Base is calling**.

-OR-

When you have more than one system handset, your telephone base shows **INTERCOM TO:**, press **▼CID** or **▲DIR** to select a destination handset and then press the **SELECT** soft key. The telephone base shows **Calling handset X**. The destination handset rings and its screen shows **Base is calling**.

3. To answer the intercom call on the destination handset, press **LINE 1/FLASH**, **LINE 2/FLASH**, **📞/SPEAKER** or **INT**. The outside call is still on hold. Both telephone base and the destination handset now show **Intercom**. You can now have a private conversation between the telephone base and the destination handset.



NOTES:

- If you want to cancel an intercom call and reconnect to the outside call before the destination handset answers, press the corresponding line button, **📞/LINE 1** or **📞/LINE 2**, on your telephone base.
- If the destination handset does not answer the intercom call within 100 seconds, is in the directory or call log, or is out of range, your telephone base shows **Unable to call try again** and the outside call is still on hold. Press the corresponding line button, **📞/LINE 1** or **📞/LINE 2**, on your telephone base to reconnect to the outside call.

4. Press **CANCEL** or the **END** soft key on the telephone base. Both screens show **Intercom ended**.
5. The telephone base and the destination handset show **L1)ON HOLD** if the call is on line 1. Press **LINE 1/FLASH** on the destination handset to connect the call on line 1. The same procedures apply if the call is on line 2.

Conference Call

Share an outside call

You can let another system handset or telephone base join you on an outside call. That call continues until all participants hang up.

- During a call on line 1, press **LINE 1/FLASH** on the handset or **☎/LINE 1** on the telephone base to join the call.
- During a call on line 2, press **LINE 2/FLASH** on the handset or **☎/LINE 2** on the telephone base to join the call.



NOTE: You cannot press **☎/SPEAKER** on the handset to join the outside call. Instead, pressing **☎/SPEAKER** on the handset picks the first available line to make a new call.

Conference line 1 and line 2 calls

While you are on a call on line 1, and line 2 is on hold or in use, you can conference line 1 and line 2 using the handset or the telephone base.

To conference both line 1 and line 2 calls:

1. While on a call, press the **OPTION** soft key on the handset or the telephone base.
2. Press the **SELECT** soft key to select **Conference**. The handset or the telephone base shows **Lines 1 and 2 in conference** for a few seconds.



To select an option while on a conference call:

1. Press the **OPTION** soft key on the handset or telephone base.
2. Press **▼CID** or **▲DIR** on the handset or on the telephone base to select one of the following options:
 - **End line 1** - external parties originally on line 1 ended
 - **End line 2** - external parties originally on line 2 ended
 - **End Conference**
 - **Intercom** - option on the telephone base only
 - **Directory**
 - **Call log**
 - **Redial last #**
3. Press the **SELECT** soft key.



Conference Call

To initiate an intercom call while on a conference call:

When you initiate an intercom call during a conference call, it places all participants in the conference call on hold.

1. Press **INT** on the handset (see **To initiate an intercom call with a handset** on page 32).

-OR-

Select **Intercom** in the **OPTION** menu on the telephone base, then press the **SELECT** soft key (see **To initiate an intercom call from the telephone base** on page 32).

2. To reconnect to the conference call, press the **END** soft key, **INT** or **OFF** on the handset to end the intercom call.

-OR-

Press the **END** soft key, **CANCEL**, **LINE 1** or **LINE 2** on the telephone base to end the intercom call.

3. Press **LINE 1/FLASH** or **LINE 2/FLASH** on the handset or **LINE 1** or **LINE 2** on the telephone base to reconnect to the conference call.

To end a conference call:

- Press **OFF** on the handset or put the handset back in the telephone base or charger.

-OR-

- Press the **OPTION** soft key on the handset or telephone base. Then press **CID** or **DIR** on the handset or on the telephone base to select **End Conference**.

-OR-

- Press **LINE 1** or **LINE 2** on the telephone base.

Conference Call

Answer an incoming call during a conference call

When you subscribe to call waiting service with your telephone service provider, you hear a beep if someone calls on line 1 or line 2 while you are already on a conference call. When you subscribe to caller ID service with your telephone service provider, you see the incoming call information either on line 1 or line 2.

To answer the incoming call while on a conference call:

- On the handset, press the corresponding line button, **LINE 1/FLASH** or **LINE 2/FLASH**.

-OR-

- On the telephone base, press **FLASH** once to answer the call waiting call on line 1, press **FLASH** a second time to answer the call waiting call on line 2, and press **FLASH** a third time to return all original parties to the conference call.



NOTES:

- When you answer the incoming call during a conference call, the new party joins in the conference call and places the line's original party on hold.
- Contact your telephone service provider for more information about call waiting (page 27), caller ID (page 51) and voicemail service (page 68).

To end the call while on a conference call:

- Press the corresponding line button, **LINE 1/FLASH** or **LINE 2/FLASH**, on the handset. The original party of that line joins back the conference call.

-OR-

- Press **FLASH** on the telephone base to end the call. Press **FLASH** again to reconnect the original party of that line to join back the conference call.

About the directory

Shared directory

Directory entries are stored at the telephone base and shared by all system handsets. Any changes made on the handset or the telephone base apply to all.



NOTE: Only one handset or the telephone base can review the directory at a time. If another device tries to enter the directory, its screen shows **Not available at this time**.

Capacity

The directory can store up to 50 entries with up to 30 digits for each phone number and 15 characters for each name.

If you try to save an entry when there are already 50 entries, the screen shows **Directory is full**. You cannot store a new number until you delete one.

Character chart

Use the dialing keys and the chart below to enter a name (up to 15 characters). Each press of a particular key causes the characters to be displayed in the following order:

Dialing key	Characters by number of key presses								
	1	2	3	4	5	6	7	8	9
1	1	#	'	,	-	.	&		
2	A	B	C	2	a	b	c		
3	D	E	F	3	d	e	f		
4	G	H	I	4	g	h	i		
5	J	K	L	5	j	k	l		
6	M	N	O	6	m	n	o		
7	P	Q	R	S	7	p	q	r	s
8	T	U	V	8	t	u	v		
9	W	X	Y	Z	9	w	x	y	z
0	0								
TONE	*	?	!	/	()	@		
#	space								



NOTE: When entering a name in the directory, the first letter of each word is automatically capitalized.

Create directory entries

Create a new directory entry

Using the handset:

1. Press the **MENU** soft key when the handset is not in use.
2. Press **▼CID** or **▲DIR** to scroll to **DIRECTORY** and then press the **SELECT** soft key.
3. Press **▼CID** or **▲DIR** to scroll to **Add contact**, then press the **SELECT** soft key. The screen shows **ENTER NUMBER**.
4. Use the dialing keys (**0-9**) to enter the number.
 - Press **↵OFF** to backspace and erase a digit.
 - Press **▼CID** to move the cursor to the left or **▲DIR** to the right.
 - Press and hold **REDIAL/PAUSE** to insert a dialing pause (a **p** appears).
5. Press the **NEXT** soft key to move to the name. The screen displays **Already saved** if the number is already in the directory. You cannot save the same number twice.
6. The screen shows **ENTER NAME**. See the **Character chart** on page 39. Use the dialing keys to enter the name.
 - Press **↵OFF** to backspace and erase a character.
 - Press **▼CID** to move the cursor to the left or **▲DIR** to the right.
7. Press the **SAVE** soft key on the handset to save. There is a confirmation tone and the screen shows the saved entry.

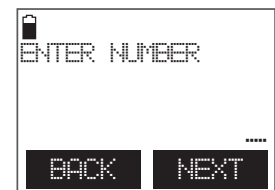

Using the telephone base:

1. Press the **MENU** soft key when the telephone base is not in use.
2. Press **▼CID** or **▲DIR** to scroll to **Directory** and then press the **SELECT** soft key.
3. Press **▼CID** or **▲DIR** to scroll to **Add contact**, then press the **SELECT** soft key. The screen shows **ENTER NUMBER**.
4. Use the dialing keys (**0-9**) to enter the number.
 - Press **CANCEL** to backspace and erase a digit.
 - Press **▼CID** to move the cursor to the left or **▲DIR** to the right.
 - Press the **PAUSE** soft key to insert a dialing pause (a **p** appears).



Create directory entries

5. Press the **NEXT** soft key to move to the name. The screen displays **Already saved** if the number is already in the directory. You cannot save the same number twice.
6. The screen shows **ENTER NAME**. See the **Character chart** on page 39. Use the dialing keys to enter the name.
 - Press **CANCEL** to backspace and erase a character.
 - Press **▼CID** to move the cursor to the left or **▲DIR** to the right.
7. Press the **SAVE** soft key on the telephone base to save. There is a confirmation tone and the screen shows the saved entry.

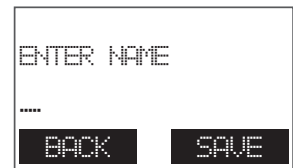

Review the directory

Review directory entries

Using the handset:

1. Press **▲DIR** when the handset is not in use.

-OR-

Press the **MENU** soft key when the handset is not in use.

Press **▼CID** or **▲DIR** to scroll to **DIRECTORY** and then press the **SELECT** soft key. Press the **SELECT** soft key again to select **Review**.



2. Press **▼CID** or **▲DIR** to browse. Entries are sorted alphabetically.

Using the telephone base:

1. Press **▲DIR** when the telephone base is not in use.

-OR-

Press the **MENU** soft key when the telephone base is not in use. Press **▼CID** or **▲DIR** to scroll to **Directory** and then press the **SELECT** soft key. Press the **SELECT** soft key again to select **Review**.



2. Press **▼CID** or **▲DIR** to browse. Entries are sorted alphabetically.



NOTE: **Directory empty** appears if there are no directory entries.

Review the directory

Search by name

1. Follow the steps in **Review directory entries** above to enter the directory.
2. When an entry appears, press the dialing keys (**0-9**) to start a name search. The directory shows the first name beginning with the first letter associated with the dialing key if there is an entry in the directory beginning with that letter. Press **▼CID** or **▲DIR** to scroll through the directory.
3. To see other names starting with the letters on the same dialing key, keep pressing the key. The names appear in alphabetical order.

For example, if you have the names **Jennifer**, **Jessie**, **Kevin** and **Linda** in your directory:

- If you press **5 (JKL)** once, you see **Jennifer**.
- If you press **5 (JKL)** twice, you see **Jessie**.
- If you press **5 (JKL)** three times, you see **Kevin**.
- If you press **5 (JKL)** four times, you see **Linda**.
- If you press **5 (JKL)** five times, you see **Jennifer** again.



NOTES:

- If there is no name matching the first letter of the key you press, the directory shows a name matching the following letters of the key.
- If you press a key (**0-9**) and no name starts with any of the letters on that key, the directory shows the entry matching the next letter in the directory.

Dial, delete or edit directory entries

Dial a directory entry

Using the handset:

1. Search for the desired entry in the directory (see **Review the directory** on pages 42-43).
2. Press **LINE 1/FLASH, LINE 2/FLASH** or **☎/SPEAKER**.

Using the telephone base:

1. Search for the desired entry in the directory (see **Review the directory** on pages 42-43).
2. Press **☎/LINE 1** or **☎/LINE 2**.

Delete a directory entry

1. Search for the desired entry in the directory (see **Review the directory** on pages 42-43).
2. When the desired entry appears, press the **DELETE** soft key. There is a confirmation tone and the screen shows the next alphabetical entry in the directory. You cannot retrieve a deleted entry.

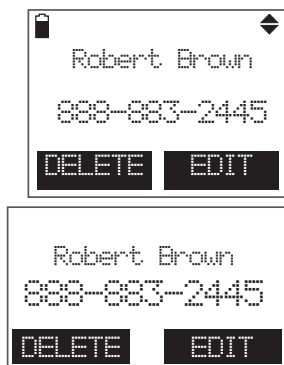

Edit a directory entry

Using the handset:

1. Search for the desired entry in the directory (see **Review the directory** on pages 42-43).
2. When the desired entry appears, press the **EDIT** soft key. The screen shows **EDIT NUMBER**.
3. Use the dialing keys (**0-9**) to edit the number.
 - Press **☎OFF** to backspace and erase a digit.
 - Press **▼CID** to move the cursor to the left or **▲DIR** to the right.
 - Press and hold **REDIAL/PAUSE** to insert a dialing pause (a **p** appears).
4. Press the **NEXT** soft key to move to the name. The screen shows **EDIT NAME**.
5. Use the dialing keys (see page 39) to edit the name.
 - Press **☎OFF** to backspace and erase a character.
 - Press **▼CID** to move the cursor to the left or **▲DIR** to the right.

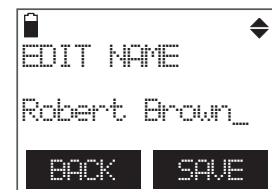
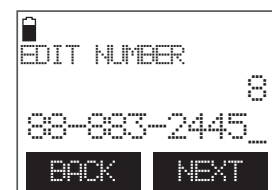

Dial, delete or edit directory entries

6. Press the **SAVE** soft key on the handset to save. There is a confirmation tone and the screen shows the edited entry.

Using the telephone base:

1. Search for the desired entry in the directory (see **Review the directory** on pages 42-43).

2. When the desired entry appears, press the **EDIT** soft key. The screen shows **EDIT NUMBER**.

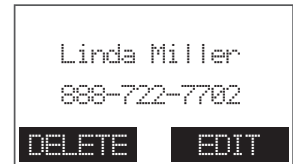

3. Use the dialing keys (**0-9**) to edit the number.

- Press **CANCEL** to backspace and erase a digit.
- Press ▼**CID** to move the cursor to the left or ▲**DIR** to the right.
- Press the **PAUSE** soft key to insert a dialing pause (a **p** appears).

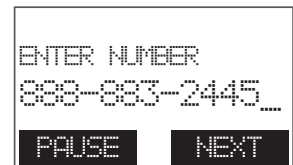

4. Press the **NEXT** soft key to move to the name. The screen shows **EDIT NAME**.

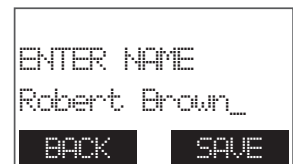

5. Use the dialing keys (see page 39) to edit the name.

- Press **CANCEL** to backspace and erase a character.
- Press ▼**CID** to move the cursor to the left or ▲**DIR** to the right.

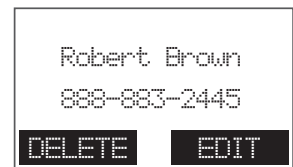

6. Press the **SAVE** soft key on the telephone base to save. There is a confirmation tone and the screen shows the edited entry.

Speed dial

The telephone system has 10 speed dial locations (**0-9**) where you can store the telephone numbers you wish to dial more quickly. You can store up to 30 digits in each location. Speed dial assignments can only be selected from existing directory entries.

Assign a speed dial number

Using the handset:

1. Press the **MENU** soft key when the handset is not in use.
2. Press **▼CID** or **▲DIR** to scroll to **DIRECTORY**, then press the **SELECT** soft key.
3. Press **▼CID** or **▲DIR** to scroll to **Speed dial**, then press the **SELECT** soft key. The screen shows a list from **1:<empty>** to **0:<empty>**.
4. Press **▼CID** or **▲DIR** to choose your desired speed dial location (**0-9**), then press the **REPLACE** soft key. The screen shows the directory listed in chronological order.
5. Press **▼CID** or **▲DIR** to scroll to the phone number you wish to assign to the selected speed dial location.
6. Press **ASSIGN** to save the setting. There is a confirmation tone and the screen returns to the speed dial list.

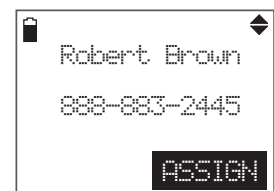
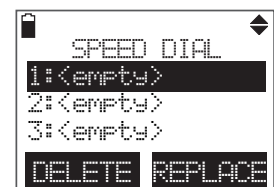

-OR-

1. Press and hold any dialing keys (**0-9**) when the telephone is not in use.
2. Press **▼CID** or **▲DIR** to choose your desired speed dial location (**0-9**), then press the **REPLACE** soft key. The screen shows the directory listed in chronological order.
3. Press **▼CID** or **▲DIR** to scroll to the phone number you wish to assign to the selected speed dial location.
4. Press the **ASSIGN** soft key to save the setting. There is a confirmation tone and the screen returns to the speed dial list.

Using the telephone base:

1. Press the **MENU** soft key when the telephone base is not in use.
2. Press **▼CID** or **▲DIR** to scroll to **Directory**, then press the **SELECT** soft key.
3. Press **▼CID** or **▲DIR** to scroll to **Speed dial**, then press the **SELECT** soft key. The screen shows a list from **1:<empty>** to **0:<empty>**.



Speed dial

4. Press ▼**CID** or ▲**DIR** to choose your desired speed dial location (**0-9**), then press the **REPLACE** soft key. The screen shows the directory listed in chronological order.
5. Press ▼**CID** or ▲**DIR** to scroll to the phone number you wish to assign to the selected speed dial location.
6. Press **ASSIGN** to save the setting. There is a confirmation tone and the screen returns to the speed dial list.



-OR-

1. Press and hold any dialing keys (**0-9**) when the telephone is not in use.
2. Press ▼**CID** or ▲**DIR** to choose your desired speed dial location (**0-9**), then press the **REPLACE** soft key. The screen shows the directory listed in chronological order.
3. Press ▼**CID** or ▲**DIR** to scroll to the phone number you wish to assign to the selected speed dial location.
4. Press the **ASSIGN** soft key to save the setting. There is a confirmation tone and the screen returns to the speed dial list.

Speed dial

Review the speed dial entries

Using the handset:

1. Press the **MENU** soft key when the handset is not in use.
2. Press **▼CID** or **▲DIR** to scroll to **DIRECTORY**, then press the **SELECT** soft key.
3. Press **▼CID** or **▲DIR** to scroll to **Speed dial**, then press the **SELECT** soft key.
4. Press **▼CID** or **▲DIR** to browse.



Using the telephone base:

1. Press the **MENU** soft key when the telephone base is not in use.
2. Press **▼CID** or **▲DIR** to scroll to **Directory**, then press the **SELECT** soft key.
3. Press **▼CID** or **▲DIR** to scroll to **Speed dial**, then press the **SELECT** soft key.
4. Press **▼CID** or **▲DIR** to browse.



Dial a speed dial entry

Using the handset:

1. When the handset is not in use, press and hold the dialing key (**0-9**) corresponding to the assigned location you wish to call.

-OR-

Follow the steps in **Review the speed dial entries** above to select the desired entry.

2. Press **LINE 1/FLASH**, **LINE 2/FLASH** or **📞/SPEAKER** to call.

Using the telephone base:

1. When the telephone base is not in use, press and hold the dialing key (**0-9**) corresponding to the assigned location you wish to call.

-OR-

Follow the steps in **Review the speed dial entries** above to select the desired entry.

2. Press **📞/LINE 1** or **📞/LINE 2** to call.

Speed dial

Edit a speed dial entry

Using the handset:

1. When the handset is not in use, press and hold the dialing key (**0-9**) corresponding to the assigned location you wish to edit.
2. When the desired entry appears, press the **EDIT** soft key. The screen shows **EDIT NUMBER**. Use the dialing keys (**0-9**) to edit the number.
 - Press **OFF** to backspace and erase a digit.
 - Press **▼CID** to move the cursor to the left or **▲DIR** to the right.
 - Press and hold **REDIAL/PAUSE** to insert a dialing pause (a **p** appears).
3. Press the **NEXT** soft key to move to the name. The screen shows **EDIT NAME**.
4. Use the dialing keys (see page 39) to edit the name.
 - Press **OFF** to backspace and erase a character.
 - Press **▼CID** to move the cursor to the left or **▲DIR** to the right.
5. Press the **SAVE** soft key to save. There is a confirmation tone and the screen shows the edited entry.

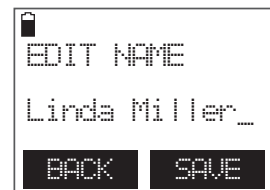
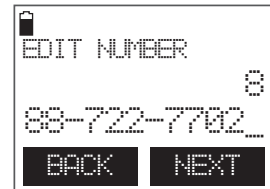
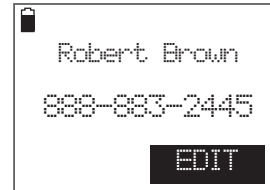

Using the telephone base:

1. When the telephone base is not in use, press and hold the dialing key (**0-9**) corresponding to the assigned location you wish to edit.
2. When the desired entry appears, press the **EDIT** soft key. The screen shows **EDIT NUMBER**.
3. Use the dialing keys (**0-9**) to edit the number.
 - Press **CANCEL** to backspace and erase a digit.
 - Press **▼CID** to move the cursor to the left or **▲DIR** to the right.
 - Press the **PAUSE** soft key to insert a dialing pause (a **p** appears).
4. Press the **NEXT** soft key to move to the name. The screen shows **EDIT NAME**.

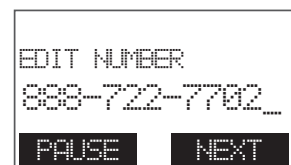
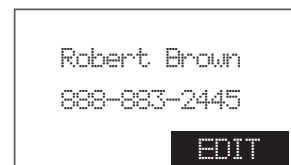

Speed dial

5. Use the dialing keys (see page 39) to edit the name.
 - Press **CANCEL** to backspace and erase a character.
 - Press **▼CID** to move the cursor to the left or **▲DIR** to the right.
6. Press the **SAVE** soft key to save. There is a confirmation tone and the screen shows the edited entry.



Reassign a speed dial entry

You can reassign a speed dial entry using a handset or the telephone base.

1. Search for the desired speed dial entry (see **Review the speed dial entries** on page 48).
2. When the desired entry appears, press the **REPLACE** soft key. The screen shows the directory listed in chronological order.
3. Press **▼CID** or **▲DIR** on the handset or on the telephone base to scroll to the desired entry, then press the **ASSIGN** soft key to confirm your selection. There is confirmation tone.
4. Press **OFF** on the handset or **CANCEL** on the telephone base to exit to the previous menu.

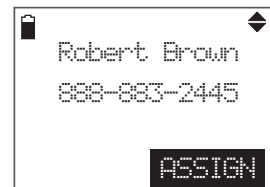

Delete a speed dial entry

You can delete a speed dial entry using a handset or the telephone base. Once a speed dial entry is deleted, it cannot be retrieved.

1. Search for the desired speed dial entry (see **Review the speed dial entries** on page 48).
2. When the desired entry appears, press the **DELETE** soft key to confirm. There is confirmation tone.



About caller ID

This product supports caller ID services offered by most telephone service providers. Caller ID allows you to see the name, number, date and time of calls. The available caller ID information will appear after the first or second ring.

Information about caller ID with call waiting

Caller ID with call waiting lets you see the name and telephone number of the caller before answering the call, even while on another call.

It may be necessary to change your telephone service to use this feature. Contact your telephone service provider if:

- You have both caller ID and call waiting, but as separate services (you may need to combine these services).
- You have only caller ID service, or only call waiting service.
- You don't subscribe to caller ID or call waiting services.

There are fees for caller ID services. In addition, services may not be available in all areas.

This product can provide information only if both you and the caller are in areas offering caller ID service and if both telephone service providers use compatible equipment. The time and date, along with the call information, are from the telephone service provider.

Caller ID information may not be available for every incoming call. Callers may intentionally block their names and/or telephone numbers. You can only view a maximum of 15 digits of every caller ID log entry. To view caller ID log entries with numbers between 16 and 24 digits, you must save the entry to the directory (see page 56).



NOTE: You can use this product with regular caller ID service, or you can use this product's other features without subscribing to caller ID or combined caller ID with call waiting service.

Caller ID history

How the caller ID history (call log) works

If you subscribe to caller ID service provided by your telephone service provider, information about each caller will appear after the first or second ring. If you answer a call before the caller information appears on the screen, it is not saved in the call log.

- The call log stores up to 50 entries. Each entry may have up to 24 digits for the phone number and 15 characters for the name.
- You can review, redial, and copy an entry into the directory.
- Entries appear in reverse chronological order.
- When the call log is full, the oldest entry is deleted to make room for new incoming call information.
- **L1)X Missed** and/or **L2)X Missed** displays when there are new call log entries that have not been reviewed.
- **Call log empty** shows when there are no records in the call log.
- Only one handset or the telephone base can review the call log at a time. If a handset tries to enter the call log while another handset or the telephone base is already in it, its screen shows **Not available at this time**.



NOTE: If the phone number has more than 24 digits, it will not be saved or shown in the call log.

Missed (new) call indicator

When there are calls that have not been reviewed in the call log, the corresponding line message, **L1)X Missed** or **L2)X Missed**, shows on the handset and the telephone base.

Each time you review a new caller ID log entry (indicated by **NEW** on the screen), the number of missed calls decreases by one.

If you do not want to review the missed calls one by one, but still want to keep them in the caller ID history, you can press and hold **OFF** on the handset for four seconds when the handset is idle, or press and hold **CANCEL** on the telephone base for four seconds when the telephone base is idle. You will hear a confirmation tone. All the entries in the caller ID history become old (reviewed already), and the missed calls message goes away.



Caller ID operation

Memory match

If the incoming telephone number matches the last seven digits of a telephone number in your directory, the name that appears on the screen matches the corresponding name in your directory.

For example, if Christine Smith calls, her name appears as **Chris** if this is how you entered it into your directory.



NOTE: The number shown in the call log is in the format sent by the telephone service provider. The telephone service provider usually delivers 10-digit phone numbers (area code plus phone number). If the last 7-digit of an incoming telephone number does not match a number in your directory, the name appears as it is delivered by the telephone service provider.

Caller ID operation

Review the caller ID history

Review the caller ID history to find out who called, to return the call, or to copy the caller's name and number into your directory. **Call log empty** displays on the screen if there are no records in the caller ID log.

Using the handset:

1. Press ▼**CID** when the handset is not in use.
2. Press ▼**CID** or ▲**DIR** to browse.

-OR-

1. Press the **MENU** soft key when the handset is not in use.
2. Press ▼**CID** or ▲**DIR** to select **CALL LOG**, then press the **SELECT** soft key.
3. Press the **SELECT** soft key again to select **Review**.
4. Press ▼**CID** or ▲**DIR** to browse.

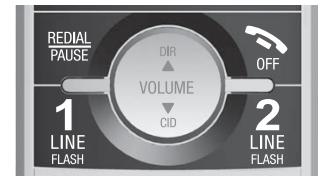

Using the telephone base:

1. Press ▼**CID** when the telephone base is not in use.
2. Press ▼**CID** or ▲**DIR** to browse.

-OR-

1. Press the **MENU** soft key when the telephone base is not in use.
2. Press ▼**CID** or ▲**DIR** to select **Call log**, then press the **SELECT** soft key.
3. Press the **SELECT** soft key again to select **Review**.
4. Press ▼**CID** or ▲**DIR** to browse.



NOTES:

- The name (if available), telephone number, date and time of all incoming calls are shown on the screen.
- You hear a double beep when you have reached the beginning or end of the call log.

Caller ID operation

View dialing options

Although the call log entries received have 10 digits (the area code plus the seven-digit number), in some areas, you may need to dial only the seven digits, 1 plus the seven digits, or 1 plus the area code plus the seven digits. You can change and store the number of digits that you dial in the caller ID log.

While reviewing the call log, press **#** (pound key) repeatedly to show different dialing options for local and long distance numbers before dialing or saving the telephone number in the directory.

Press **1** repeatedly if you need to add or remove 1 in front of the telephone number before dialing or saving it in the directory.

When the number is shown in the correct format for dialing, press **LINE 1/FLASH**, **LINE 2/FLASH** or **📞/SPEAKER** on the handset; or **📞/LINE 1** or **📞/LINE 2** on the telephone base to call the number.

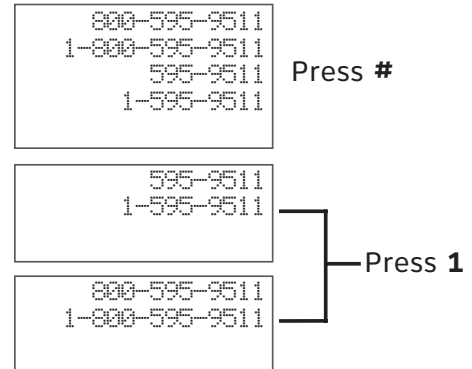

Dial a call log entry

Using the handset:

1. Search for the desired entry in the call log (see **Review the caller ID history** on page 54).
2. When the desired entry appears and is in the correct format for dialing, press **LINE 1/FLASH**, **LINE 2/FLASH** or **📞/SPEAKER** to dial the entry.

Using the telephone base:

1. Search for the desired entry in the call log (see **Review the caller ID history** on page 54).
2. When the desired entry appears and is in the correct format for dialing, press **📞/LINE 1** or **📞/LINE 2** to dial the entry.

Caller ID operation

Save a call log entry to the directory

Using the handset:

1. Select a desired entry in the call log (see **Review the caller ID history** on page 54).
2. When the desired entry appears, press the **SAVE** soft key. The screen shows **EDIT NUMBER**.
3. Use the dialing keys (**0-9**) to edit the number.
 - Press **OFF** to backspace and erase a digit.
 - Press **▼CID** to move the cursor to the left or **▲DIR** to the right.
 - Press and hold **REDIAL/PAUSE** to insert a dialing pause (a **p** appears).
4. Press the **NEXT** soft key to move to the name. The screen displays **EDIT NAME**.
5. Use the dialing keys (see page 39) to edit the name.
 - Press **OFF** to backspace and erase a character.
 - Press **▼CID** to move the cursor to the left or **▲DIR** to the right.
6. Press the **SAVE** soft key. There is a confirmation tone and the screen shows the saved entry.



Using the telephone base:

1. Select a desired entry in the call log (see **Review the caller ID history** on page 54).
2. When the desired entry appears, press the **SAVE** soft key. The screen shows **EDIT NUMBER**.
3. Use the dialing keys (**0-9**) to edit the number.
 - Press **CANCEL** to backspace and erase a digit.
 - Press **▼CID** to move the cursor to the left or **▲DIR** to the right.
 - Press the **PAUSE** soft key to insert a dialing pause (a **p** appears).
4. Press the **NEXT** soft key to move to the name. The screen displays **EDIT NAME**.
5. Use the dialing keys (see page 39) to edit the name.
 - Press **CANCEL** to backspace and erase a character.
 - Press **▼CID** to move the cursor to the left or **▲DIR** to the right.

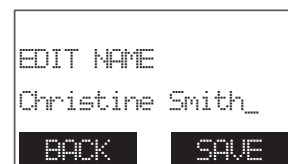
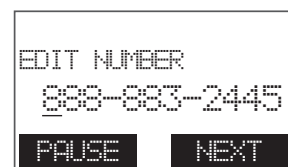
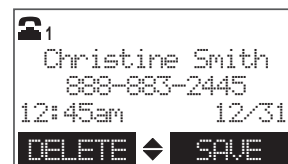

Caller ID operation

- Press the **SAVE** soft key. There is a confirmation tone and the screen shows the saved entry.



NOTES:

- If you try to save a call log entry to the directory that is already saved in the directory, the telephone base or handset shows **Already saved**.
- If you try to save a call log entry without caller ID information, the telephone base or handset shows **Unable to save**.

Delete from the call log

To delete a single entry:

- Select the desired entry in the call log using a handset or the telephone base (see **Review the caller ID history** on page 54).
- When the desired entry appears, press the **DELETE** soft key on the handset or the telephone base to confirm. There is a confirmation tone.

To delete all entries:

Using the handset:

- Press the **MENU** soft key when the handset is not in use.
- Press **▼CID** or **▲DIR** to scroll to **CALL LOG**, then press the **SELECT** soft key.
- Press **▼CID** or **▲DIR** to scroll to **Del all calls**, then press the **SELECT** soft key. The screen shows **Delete all calls?**
- Press the **YES** soft key to confirm. There is a confirmation tone. Or press the **NO** softkey to exit to the previous menu.



Using the telephone base:

- Press the **MENU** soft key when the telephone base is not in use.
- Press **▼CID** or **▲DIR** to scroll to **Call log** and then press the **SELECT** soft key.
- Press **▼CID** or **▲DIR** to scroll to **Del all calls**, then press the **SELECT** soft key. The screen shows **Delete all calls?**
- Press the **YES** soft key to confirm. There is a confirmation tone. Or press the **NO** soft key to exit to the previous menu.

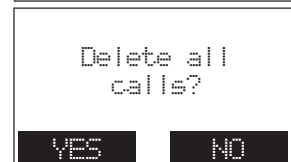

Reasons for missing caller information

There are occasions when other information or no information shows for various reasons:

On-screen message	Reason
Private number	The caller prefers not to show the phone number.
Private name	The caller prefers not to show the name.
Private caller	The caller prefers not to show the phone number and name.
Unknown number	Your telephone service provider cannot determine the caller's number.
Unknown name	Your telephone service provider cannot determine the caller's name.
Unknown caller	Your telephone service provider cannot determine the caller's name and telephone number. Calls from other countries may also generate this message.
Long distance OR L (before the caller's number)	It is a long distance call.

Answering system settings

Use the answering system menu of a system handset or the telephone base to set up the announcement message, turn on or off the answering system or message alert tone, activate call screening, or change the number of rings, or remote access code.

Announcement

Your outgoing announcement plays when calls are answered by the answering system. The telephone is preset with a greeting that answers calls with *"Hello, please leave a message after the tone."* You may use this preset announcement, or replace it with your own.

To play your current outgoing announcement:

Using the telephone base:

1. Press the **MENU** soft key when the telephone base is not in use.
2. Press the **SELECT** soft key to select **Answering sys.**
3. Press **▼CID** or **▲DIR** to choose **Mailbox 1** or **Mailbox 2**, then press the **SELECT** soft key. The corresponding icon, **1OO** or **OO2**, flashes on the screen.
4. Press **▼CID** or **▲DIR** to scroll to **Ans sys setup** and then press the **SELECT** soft key.
5. Press **▼CID** or **▲DIR** to scroll to **Announcement** and then press the **SELECT** soft key.
6. The telephone base announces, *"To play, press 2. To record, press 7."* Press **2** to play and the screen shows **Announcement playback**, or press **CANCEL** to exit to the previous menu.

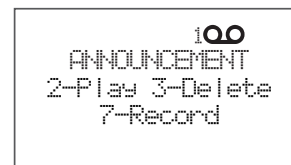
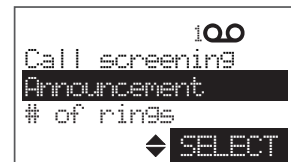

Using the handset:

1. Press the **MENU** soft key when the handset is not in use.
2. Press the **SELECT** soft key to select **ANSWERING SYS.**
3. Press **▼CID** or **▲DIR** to choose **Mailbox 1** or **Mailbox 2**, then press the **SELECT** soft key. The corresponding icon, **OO¹** or **OO₂**, flashes on the screen respectively.
4. Press **▼CID** or **▲DIR** to scroll to **Ans sys setup**, then press the **SELECT** soft key.
5. Press **▼CID** or **▲DIR** to scroll to **Announcement**, then press the **SELECT** soft key.
6. The handset announces, *"To play, press 2. To record, press 7."* Press **2** to play and the screen shows **Announcement playback**, or press the **BACK** soft key to exit to the previous menu.

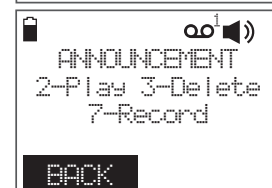
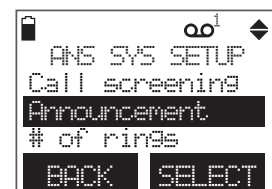

Answering system settings

To record a new outgoing announcement:

Using the telephone base:

1. Press **•/REC** while the telephone base is not in use.
2. Press **▼CID** or **▲DIR** to choose **Announcement**, then press the **SELECT** soft key.
3. Press **▼CID** or **▲DIR** to choose **Mailbox 1** or **Mailbox 2**, then press the **SELECT** soft key. The corresponding icon, **100** or **002**, flashes on the screen.
4. The telephone base announces, "Record after the tone. Press **5** when you are done." After the tone, speak towards the telephone base. Press **5** or the **STOP** soft key when finished recording.
5. The answering system automatically plays back the newly recorded announcement. Press **5** to stop the playback at any time.



-OR-

1. Press the **MENU** soft key when the telephone base is not in use.
2. Press the **SELECT** soft key to select **Answering sys.**
3. Press **▼CID** or **▲DIR** to choose **Mailbox 1** or **Mailbox 2**, then press the **SELECT** soft key. The corresponding icon, **100** or **002**, flashes on the screen.
4. Press **▼CID** or **▲DIR** to scroll to **Ans sys setup**, then press the **SELECT** soft key.
5. Press **▼CID** or **▲DIR** to scroll to **Announcement**, then press the **SELECT** soft key.
6. The telephone base announces, "To play, press **2**. To record, press **7**." Press **7** to record and the screen shows **Recording announcement...**, or press **CANCEL** to exit to the previous menu.
7. The telephone base announces, "Record after the tone. Press **5** when you are done." After the tone, speak towards the telephone base. Press **5** or the **STOP** soft key when finished recording.
8. The answering system automatically plays back the newly recorded announcement. Press **5** to stop the playback at any time; **2** to replay the recorded announcement; or **7** to record again if desired.

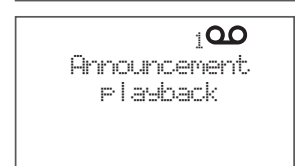
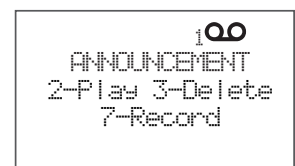
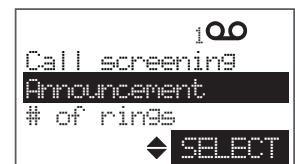

NOTES:

- Your announcement can be up to 90 seconds in length.
- Announcements shorter than two seconds are not recorded.

Answering system settings

Using the handset:

1. Press the **MENU** soft key menu when the handset is not in use.
2. Press the **SELECT** soft key to select **ANSWERING SYS**.
3. Press **▼CID** or **▲DIR** to choose **Mailbox 1** or **Mailbox 2**, then press the **SELECT** soft key. The corresponding icon, **☎¹** or **☎₂**, flashes on the screen.
4. Press **▼CID** or **▲DIR** to scroll to **Ans sys setup**, then press the **SELECT** soft key.
5. Press **▼CID** or **▲DIR** to scroll to **Announcement**, then press the **SELECT** soft key.
6. The handset announces, *"To play, press 2. To record, press 7."* Press **7** to record and the screen shows **Recording announcement...**, or press the **BACK** soft key to exit to the previous menu.
7. The handset announces, *"Record after the tone. Press 5 when you are done."* After the tone, speak towards the handset.
8. Press **5** or the **STOP** soft key when finished recording.
9. The answering system automatically plays back the newly recorded announcement. Press **5** to stop the playback at any time; **2** to replay the recorded announcement; or **7** to record again if desired.



NOTES:

- Your announcement can be up to 90 seconds in length.
- Announcements shorter than two seconds are not recorded.

Answering system settings

To delete your announcement

Using the telephone base:

1. Press the **MENU** soft key when the telephone base is not in use.
2. Press the **SELECT** soft key to select **Answering sys.**
3. Press **▼CID** or **▲DIR** to choose **Mailbox 1** or **Mailbox 2**, then press the **SELECT** soft key. The corresponding icon, **1OO** or **OO2**, flashes on the screen.
4. Press **▼CID** or **▲DIR** to scroll to **Ans sys setup**, then press the **SELECT** soft key.
5. Press **▼CID** or **▲DIR** to scroll to **Announcement**, then press the **SELECT** soft key.
6. The telephone base announces, *"To play, press 2. To record, press 7."* Press **3** to delete your own recorded announcement. The telephone base announces, *"Announcement deleted."*



Using the handset:

1. Press the **MENU** soft key when the handset is not in use.
2. Press the **SELECT** soft key to select **ANSWERING SYS.**
3. Press **▼CID** or **▲DIR** to choose **Mailbox 1** or **Mailbox 2**, then press the **SELECT** soft key. The corresponding icon, **OO1** or **OO2**, flashes on the screen.
4. Press **▼CID** or **▲DIR** to scroll to **Ans sys setup**, then press the **SELECT** soft key.
5. Press **▼CID** or **▲DIR** to scroll to **Announcement**, then press the **SELECT** soft key.
6. The handset announces, *"To play, press 2. To record, press 7."* Press **3** to delete your own recorded announcement. The handset announces, *"Announcement deleted."*
7. Press the **BACK** soft key to exit to the previous menu.

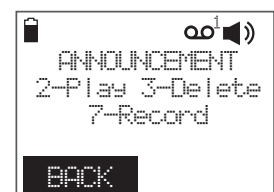

NOTE: When your announcement is deleted, calls are answered with the preset announcement.

Answering system settings

Answer ON/OFF

You must turn on the answering system for answering and recording messages.

To turn the answering system on or off:

Using the telephone base:

- Press **☎/ANSWER ON 1** and/or **☎/ANSWER ON 2** to turn on the corresponding answering system. The telephone base announces and shows, "Calls will be answered." The **☎/ANSWER ON 1** light and/or **☎/ANSWER ON 2** light will be on respectively.
- Press **☎/ANSWER ON 1** and/or **☎/ANSWER ON 2** to turn off the corresponding answering system. The telephone base announces and shows, "Calls will not be answered." The **☎/ANSWER ON 1** light and/or **☎/ANSWER ON 2** light will be off respectively.



Using the handset:

1. Press the **MENU** soft key when the handset is not in use.
2. Press the **SELECT** soft key to select **ANSWERING SYS**.
3. Press **▼CID** or **▲DIR** to choose **Mailbox 1** or **Mailbox 2**, then press the **SELECT** soft key. The corresponding icon, **☎¹** or **☎₂**, flashes on the screen.
4. Press **▼CID** or **▲DIR** to scroll to **Ans sys setup**, then press the **SELECT** soft key.
5. Press the **SELECT** soft key again to select **Answer ON/OFF**.
6. Press **▼CID** or **▲DIR** to select **On** or **Off**, then press the **SET** soft key to confirm your setting. There is a confirmation tone. Or press the **BACK** soft key to exit to the previous menu without making any changes.
7. The screen displays **ANS¹ ON** or **ANS₂ ON** when the answering system of line 1 or line 2 is turned on respectively. The screen displays **ANS¹ ON₂** when the answering systems of both lines 1 and 2 are turned on.

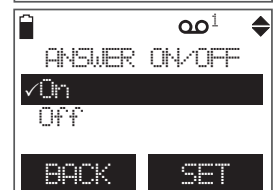
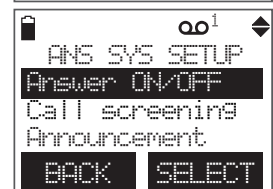
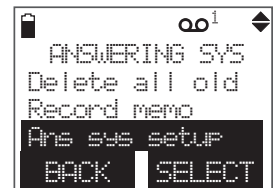

Answering system settings

Call screening

The call screening feature lets you listen at the telephone base to a caller leaving a message. You can turn this feature on or off with either your handset or telephone base. Unless you change it, the call screening feature is preset to on.

Using the telephone base:

1. Press the **MENU** soft key when the telephone base is not in use.
2. Press the **SELECT** soft key to select **Answering sys.**
3. Press **▼CID** or **▲DIR** to choose **Mailbox 1** or **Mailbox 2**, then press the **SELECT** soft key. The corresponding icon, **100** or **002**, flashes on the screen.
4. Press **▼CID** or **▲DIR** to scroll to **Ans sys setup**, then press the **SELECT** soft key.
5. Press the **SELECT** soft key again to select **Call screening**.
6. Press **▼CID** or **▲DIR** to select **On** or **Off**, then press the **SET** soft key to confirm your setting. There is a confirmation tone. Or press **CANCEL** to exit to the previous menu without making any changes.



Using the handset:

1. Press the **MENU** soft key when the handset is not in use.
2. Press the **SELECT** soft key to select **ANSWERING SYS.**
3. Press **▼CID** or **▲DIR** to choose **Mailbox 1** or **Mailbox 2**, then press the **SELECT** soft key. The corresponding icon **00¹** or **00₂**, flashes on the screen.
4. Press **▼CID** or **▲DIR** to scroll to **Ans sys setup**, then press the **SELECT** soft key.
5. Press **▼CID** or **▲DIR** to scroll to **Call screening**, then press the **SELECT** soft key.
6. Press **▼CID** or **▲DIR** to select **On** or **Off**, then press the **SET** soft key to confirm your setting. There is a confirmation tone. Or press the **BACK** soft key to exit to the previous menu without making any changes.

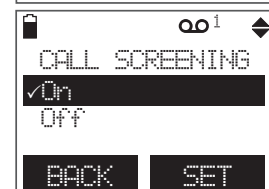
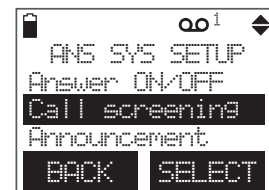

Answering system settings

Number of rings

You can set the answering system to answer an incoming call after two, four or six rings; or toll saver. With toll saver selected, the answering system answers after two rings when you have new messages, and after four rings when you have no new messages. This enables you to check for new messages and avoid paying unnecessary long distance charges if you are calling from out of your local area.

Using the telephone base:

1. Press the **MENU** soft key when the telephone base is not in use.
2. Press the **SELECT** soft key to select **Answering sys.**
3. Press **▼CID** or **▲DIR** to choose **Mailbox 1** or **Mailbox 2**, then press the **SELECT** soft key. The corresponding icon, **100** or **002**, flashes on the screen.
4. Press **▼CID** or **▲DIR** to scroll to **Ans sys setup**, then press the **SELECT** soft key.
5. Press **▼CID** or **▲DIR** to scroll to **# of rings**, then press the **SELECT** soft key.
6. Press **▼CID** or **▲DIR** to choose **2**, **4**, **6**, or **Toll saver**, then press the **SET** soft key to confirm your setting. There is a confirmation tone. Or press **CANCEL** to exit to the previous menu without making any changes.

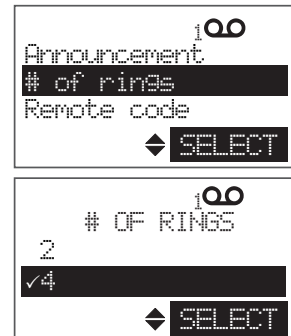

Using the handset:

1. Press the **MENU** soft key when the handset is not in use.
2. Press the **SELECT** soft key to select **ANSWERING SYS.**
3. Press **▼CID** or **▲DIR** to choose **Mailbox 1** or **Mailbox 2**, then press the **SELECT** soft key. The corresponding icon, **00¹** or **00₂**, flashes on the screen.
4. Press **▼CID** or **▲DIR** to scroll to **Ans sys setup**, then press the **SELECT** soft key.
5. Press **▼CID** or **▲DIR** to scroll to **# of rings**, then press the **SELECT** soft key.
6. Press **▼CID** or **▲DIR** to choose **2**, **4**, **6**, or **Toll saver**, then press the **SET** soft key to confirm your setting. There is a confirmation tone. Or press the **BACK** soft key to exit to the previous menu without making any changes.

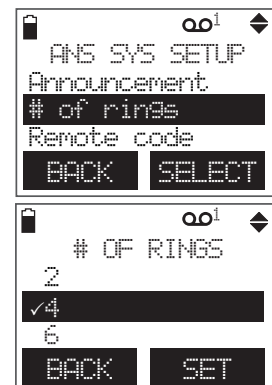

Answering system settings

Remote access code

A two-digit security code is required to access the answering system remotely from any touch-tone telephone. The preset code is **19**. You can set the code to any number from **00** to **99**.

Using the telephone base:

1. Press the **MENU** soft key when the telephone base is not in use.
2. Press the **SELECT** soft key to select **Answering sys.**
3. Press **▼CID** or **▲DIR** to choose **Mailbox 1** or **Mailbox 2**, then press the **SELECT** soft key. The corresponding icon, **100** or **002**, flashes on the screen.
4. Press **▼CID** or **▲DIR** to scroll to **Ans sys setup**, then press the **SELECT** soft key.
5. Press **▼CID** or **▲DIR** to scroll to **Remote code**, then press the **SELECT** soft key.
6. Use the dialing keys (**0-9**) to enter a two-digit code. Press **CANCEL** to delete a digit.
7. Then press the **SET** soft key to confirm your setting. There is a confirmation tone.

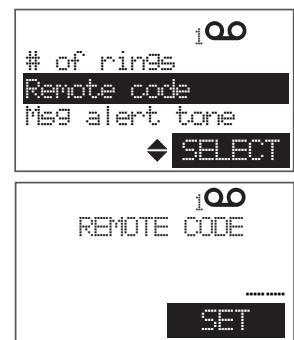

Using the handset:

1. Press the **MENU** soft key when the handset is not in use.
2. Press the **SELECT** soft key to select **ANSWERING SYS.**
3. Press **▼CID** or **▲DIR** to choose **Mailbox 1** or **Mailbox 2**, then press the **SELECT** soft key. The corresponding icon, **00¹** or **00₂**, flashes on the screen.
4. Press **▼CID** or **▲DIR** to scroll to **Ans sys setup**, then press the **SELECT** soft key.
5. Press **▼CID** or **▲DIR** to scroll to **Remote code**, then press the **SELECT** soft key.
6. Use the dialing keys to enter a two-digit code. Press **OFF** to delete a digit.
7. Then press the **SET** soft key to confirm your setting. There is a confirmation tone. Or press the **BACK** soft key to exit to the previous menu without making any changes.

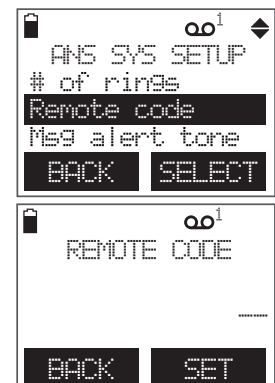

NOTE: If you change the remote access code setting on either **Mailbox 1** or **Mailbox 2**, it applies to both mailboxes in your answering system.

Answering system settings

Message alert tone

When the answering system is turned on, the telephone base beeps every 10 seconds to alert you of new messages. The alert stops when all new messages have been reviewed.

Using the telephone base:

1. Press the **MENU** soft key when the telephone base is not in use.
2. Press the **SELECT** soft key to select **Answering sys.**
3. Press **▼CID** or **▲DIR** to choose **Mailbox 1** or **Mailbox 2**, then press the **SELECT** soft key. The corresponding icon, **100** or **002**, flashes on the screen.
4. Press **▼CID** or **▲DIR** to scroll to **Ans sys setup**, then press the **SELECT** soft key.
5. Press **▼CID** or **▲DIR** to scroll to **Msg alert tone**, then press the **SELECT** soft key.
6. Press **▼CID** or **▲DIR** to choose **On** or **Off**, then press the **SET** soft key to confirm your setting. There is a confirmation tone. Or press **CANCEL** to exit to the previous menu without making any changes.

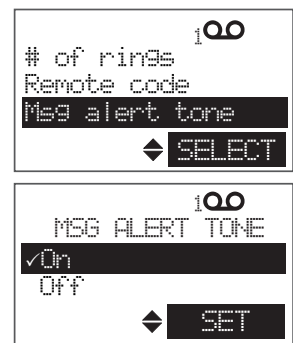

Using the handset:

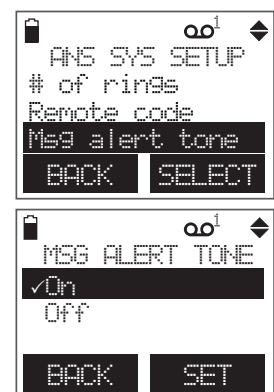

1. Press the **MENU** soft key when the handset is not in use.
2. Press the **SELECT** soft key to select **ANSWERING SYS.**
3. Press **▼CID** or **▲DIR** to choose **Mailbox 1** or **Mailbox 2**, then press the **SELECT** soft key. The corresponding icon, **00¹** or **00₂**, flashes on the screen.
4. Press **▼CID** or **▲DIR** to scroll to **Ans sys setup**, then press the **SELECT** soft key.
5. Press **▼CID** or **▲DIR** to scroll to **Msg alert tone**, then press the **SELECT** soft key.
6. Press **▼CID** or **▲DIR** to choose **On** or **Off**, then press the **SET** soft key to confirm your setting. There is a confirmation tone. Or press the **BACK** soft key to exit to the previous menu without making any changes.



About the answering system

Answering system and voicemail indicators

Your telephone has separate indicators for two different types of voice messages: those left on its built-in answering system and those left on your telephone service provider's voicemail (fees may apply). Your telephone's built-in answering system messages and voicemail messages are separate. Each alerts you to new messages differently.

- If the  icon and a line number appear on the handset and telephone base, your telephone service provider is indicating that it has new voicemail for you. To listen to your voicemail, you typically dial an access number provided by your telephone service provider, followed by a security code or PIN.
- If the /MAIL BOX 1 or /MAIL BOX 2 button on the telephone base flashes, your digital answering system has new messages for you. To listen to the messages, press the flashing mailbox button.

Some telephone service providers bundle or combine multiple services like voicemail and call waiting, so you may not be aware that you have voicemail. To check what services you have and how to access them, contact your telephone service provider.

To use your voicemail service rather than your answering system, turn off your answering system. To use your answering system rather than your voicemail service, contact your telephone service provider to deactivate your voicemail service.

Using the answering system and voicemail together

You can also use your telephone answering system and voicemail together by setting your built-in answering system to answer before voicemail answers as described below. To learn how to program your voicemail settings, contact your telephone service provider. Then, if you are on a call, or if the answering system is busy recording a message and you receive another call, the second caller can leave a voicemail message.

Set your answering system to answer calls at least two rings earlier than your voicemail is set to answer. For example, if your voicemail answers after six rings, set your answering system to answer after four rings. Some voicemail providers may program the delay before answering calls in seconds instead of rings; in this case, allow six seconds per ring when determining the appropriate setting.

About the answering system

Message capacity

The answering system of line 1 and line 2 can each record and store up to 99 messages. Each message can be up to four minutes in length. The total storage capacity of each telephone line for the announcement, messages and memos is approximately 14 minutes. The actual recording time depends on individual message characteristics. Messages remain available for replay until you delete them.

New message indication

When there are new messages on the answering system of line 1, **L1)X New Msgs** and **00¹** display on the handset and **100** on the telephone base. **▶/■/MAIL BOX 1** flashes on the telephone base.

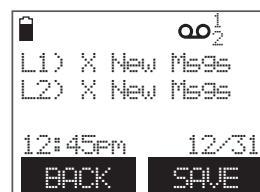

When there are new messages on the answering system of line 2, **L2)X New Msgs** and **00₂** display on the handset and telephone base. **▶/■/MAIL BOX 2** flashes on the telephone base.



When there are new messages on the answering system of both line 1 and line 2, **L1)X New Msgs**, **L2)X New Msgs** and **00₂** display on the handset and **1002** on the telephone base. **▶/■/MAIL BOX 1** and **▶/■/MAIL BOX 2** flash on the telephone base.

Voice prompts

The system provides voice prompts to guide you through the setup procedures at the telephone base, message playback, remote access and recording outgoing announcements.

Call screening

To screen a call at the telephone base:

If the answering system and call screening are on (see **Call screening** on page 64), the announcement and the incoming message broadcast at the telephone base when a call is answered by the answering system.

Options while a message is being recorded:

- Press **▼/VOLUME/▲** on the telephone base to adjust the call screening volume.
- Press the **STOP** soft key, **CANCEL**, **▶/■/MAIL BOX 1** or **▶/■/MAIL BOX 2** to stop the recording.
- Press **◀/LINE 1** or **◀/LINE 2** to answer the call.

About the answering system

Call intercept

If you want to talk to the caller who is leaving a message on line 1, press **LINE 1/FLASH** on the handset or press **📞/LINE 1** on the telephone base.

If you want to talk to the caller who is leaving a message on line 2, press **LINE 2/FLASH** on the handset or press **📞/LINE 2** on the telephone base.

Base ringer

Press **▼/VOLUME/▲** on the telephone base to adjust the ringer volume of both line 1 and line 2 when the telephone is not in use.

You hear a sample of the ringer while adjusting the volume. The telephone base shows **Ringer muted** when you turn the ringer off.

Temporarily turning off the message alert tone

If the message alert tone is turned on, the telephone base beeps every 10 seconds when there are new messages. Pressing any telephone base key temporarily silences the message alert tone.

Message playback

Message playback

If you have new messages, the telephone plays only the new messages (oldest first). If there are no new messages, the telephone plays back all messages (oldest first).

When playback begins, the total number of messages is announced. Before each message, you hear the day and time of the recording. If the date and time are not set, you hear, *"Time and date not set,"* before playback. After the last message, the telephone announces, *"End of messages."*

To listen to messages at the telephone base:

1. Press ►/■/MAIL BOX 1 for line 1 or ►/■/MAIL BOX 2 for line 2 to listen to messages.

Options during playback:

- Press ▼/VOLUME/▲ to adjust the speaker volume.
- Press ►/SKIP to skip to the next message.
- Press ◀/REPEAT to repeat the message currently playing. Press ◀/REPEAT twice to listen to the previous message.
- Press X/DELETE to delete the current message. The system advances to the next message.
- Press ►/■/MAIL BOX 1 for line 1 or ►/■/MAIL BOX 2 for line 2 to stop listening to messages.
- Press CANCEL to exit to the previous menu.



To listen to messages on the handset:

1. Press the **MENU** soft key when the handset is not in use.
2. Press the **SELECT** soft key to select **ANSWERING SYS.**
3. Press ▼CID or ▲DIR to choose **Mailbox 1** or **Mailbox 2**. Press the **SELECT** soft key.
4. Press ▼CID or ▲DIR to scroll to **Play messages**, then press the **SELECT** soft key.

Options during playback:

- Press ▼/VOLUME/▲ to adjust the speaker volume.
- Press 6 to skip to the next message.
- Press 4 to repeat the message currently playing. Press 4 twice to listen to the previous message.
- Press 3 to delete the current message. The system advances to the next message.

Message playback

- Press **5** to stop.
- Press the **BACK** soft key to exit to the previous menu.



NOTE: When the memory of the answering system is full on line 1 or line 2, the corresponding line message, **L1)Ans Sys Full** or **L2)Ans Sys Full**, displays on both the handset and the telephone base. Delete some messages to make room for new messages.

Delete all messages

You can only delete old (reviewed) messages. You cannot delete new messages until you review them. You cannot retrieve deleted messages.

Using the telephone base:

1. Press **X/DELETE** when the telephone base is not in use.
2. Press **▼CID** or **▲DIR** to choose **Mailbox 1** or **Mailbox 2**, then press the **SELECT** soft key.
3. The telephone base shows **Delete all old messages?** Press the **YES** soft key to confirm or press the **NO** soft key to return to the previous menu.

-OR-

1. Press the **MENU** soft key when the telephone base is not in use. Press the **SELECT** soft key to select **Answering sys.**
2. Press **▼CID** or **▲DIR** to choose **Mailbox 1** or **Mailbox 2**, then press the **SELECT** soft key.
3. Press the **SELECT** soft key again to select **Delete all old.**
4. The telephone base shows **Delete all old messages?** Press the **YES** soft key to confirm or press the **NO** soft key to return to the previous menu.

Using the handset:

1. Press the **MENU** soft key when the handset is not in use.
2. Press the **SELECT** soft key to select **ANSWERING SYS.**
3. Press **▼CID** or **▲DIR** to choose **Mailbox 1** or **Mailbox 2**, then press the **SELECT** soft key.
4. Press **▼CID** or **▲DIR** to scroll to **Delete all old**, then press the **SELECT** soft key.
5. The handset shows **Delete all old messages?** Press the **YES** soft key to confirm or press the **NO** soft key to return to the previous menu.

Recording and playing memos

Record a memo

Memos are your own recorded messages used as reminders for yourself or others who use the same answering system. You can record your own memos using the handset or telephone base. Playback and delete them the same way as incoming messages.

Using the telephone base:

1. Press **•/REC** while the telephone base is not in use.
2. Press the **SELECT** soft key to select **Memo**.
3. Press **▼CID** or **▲DIR** to choose **Mailbox 1** or **Mailbox 2**, then press the **SELECT** soft key.
4. The telephone base announces, "Record after the tone. Press 5 when you are done." The telephone base displays **Recording memo...** After the tone, speak towards the telephone base. Press **5** or the **STOP** soft key when finished recording. The telephone base announces, "Recorded."



-OR-

1. Press the **MENU** soft key when the telephone base is not in use.
2. Press the **SELECT** soft key to select **Answering sys.**
3. Press **▼CID** or **▲DIR** to choose **Mailbox 1** or **Mailbox 2**, then press the **SELECT** soft key.
4. Press **▼CID** or **▲DIR** to scroll to **Record memo**, then press the **SELECT** soft key.
5. The telephone base announces, "Record after the tone. Press 5 when you are done." The telephone base displays **Recording memo...** After the tone, speak towards the telephone base. Press **5** or the **STOP** soft key when finished recording. The telephone base announces, "Recorded."

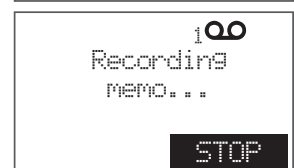

Recording and playing memos

Using the handset:

1. Press the **MENU** soft key when the handset is not in use.
2. Press the **SELECT** soft key to select **ANSWERING SYS**.
3. Press **▼CID** or **▲DIR** to choose **Mailbox 1** or **Mailbox 2**. Press the **SELECT** soft key.
4. Press **▼CID** or **▲DIR** to scroll to **Record memo**. Press the **SELECT** soft key.
5. The handset announces, *“Record after the tone. Press 5 when you are done.”* The handset screen displays **Recording memo...** After the tone, speak towards the handset.
6. Press **5** or the **STOP** soft key when finished recording. The handset announces, *“Recorded.”*



NOTES:

- *“Memory is full”* is announced if you record a memo when the memory is full.
- Each memo can be up to four minutes in length.
- Memos shorter than one second are not recorded.

Play back a memo

Play memos the same way as messages. See **Message playback** on page 71.

Remote access

You can reach your answering system remotely by dialing your home telephone number from any touch-tone telephone.

1. Dial your telephone number from any touch-tone telephone.
2. When the system plays your announcement, enter the two-digit security code (19 is the default code. See page 66 to change it).
3. Once the new messages have played, you can also enter one of the following remote commands.

Command	Function
1	Play all messages.
2	Play only new messages.
3	Delete the current message (during playback).
33	Delete all old messages.
4	Repeat the current message (during playback).
44	Skip to the previous message (during playback).
5	Stop.
*5	Hear a list of remote commands.
6	Skip to the next message (during playback).
*7	Record a new announcement.
8	End the call.
0	Turn the answering system on or off.

4. Hang up or press **8** to end the call.



NOTES:

- If you do not press any key after you enter the remote access code, all new messages play. If there are no new messages, all old messages play.
- Once the new messages have played, the telephone announces the help menu options. If you do not press any key within 20 seconds, the remote access call automatically disconnects.
- When the answering system is turned off, the telephone answers after 10 rings, and announces, *"Please enter your remote access code."*
- When the memory is full, the answering system answers incoming calls after 10 rings and announces, *"Memory is full. Enter the remote access code."*

Adding and registering handsets

The handset provided with your telephone system is already registered as **HANDSET**. Additional handsets registered to the telephone system are assigned in sequential order. If you register another new handset to your telephone system, the new registered handset is assigned **HANDSET 2**. Then your first handset is renamed as **HANDSET 1**. This telephone system accommodates up to 12 handsets.

You can add new handsets (**TL88002**, purchased separately) to your telephone system, but each handset must be registered with the telephone base before use. When first purchased, each expansion handset shows **Press [HOLD] on base for 4 sec, then press [#] on handset**. You may need to charge the handset before registering to the telephone base. For more details on battery charging, see the table on page 8.

Register a handset to the telephone base

1. Before you begin registration, make sure the handset displays **Press [HOLD] on base for 4 sec, then press [#] on handset**.
2. Place the unregistered handset in the telephone base.
3. Press and hold **HOLD** on the telephone base for about four seconds until the telephone base displays **Registering handset...** While the handset is still in the telephone base, press **#** (pound key) on the handset. The handset shows **Registering... Please wait** and it takes up to 60 seconds to complete the registration. The handset and the telephone base show **HANDSET X Registered** (X represents the handset number assigned) and you hear a beep when the registration completes.



NOTES:

- If the registration fails, the handset shows **Registration failed**. To reset the handset, remove the handset from the telephone base and place it back in. Try the registration process again.
- You cannot register a handset if any other system handset is in use.

Deregistering handsets

You may need to deregister your handsets if:

- You have 12 registered handsets and need to replace a handset.

-OR-

- You wish to change the designated handset number of your registered handsets.

You must first deregister **ALL** handsets, and then register each handset you wish to use again, one at a time.

Please read carefully through all the instructions on this page before beginning the deregistration process.

Deregister all handsets from the telephone base

1. Remove any handset from the telephone base. Press and hold **HOLD** on the telephone base for about 10 seconds until the telephone base displays **Deregister all handsets?**
2. Press the **YES** soft key. There is a confirmation tone.
3. The deregistration process takes about 10 seconds to complete. All handsets show **Press [HOLD] on base for 4 sec, then press [#] on handset** when the deregistration completes.

If deregistration fails, you may need to reset the telephone and try again.

To reset:

1. Pick up the registered handset and then press **LINE 1/FLASH** or **LINE 2/FLASH**.
2. Press **OFF** and then place the handset back in the telephone base.

-OR-

Unplug the power adapter from the telephone base, then plug it back in.











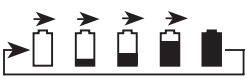











NOTES:

- You cannot deregister a handset if any system handset or telephone base is in use.
- Even if the battery is depleted, you can still deregister the handsets by following the steps above. After the handset is charged for at least 10 minutes, the screen shows **Press [HOLD] on base for 4 sec, then press [#] on handset**.













Handset and telephone base indicators

Handset screen icons

	Handset battery is charging (animated displayed). Becomes solid when the battery is fully charged.
	Flashes when the battery is low and needs charging.
	Line 1 is in use.
	Line 2 is in use.
	Handset ringer of line 1 is turned off.
	Handset ringer of line 2 is turned off.
	Handset ringers of line 1 and line 2 are turned off.
	New voicemail received on line 1 from the telephone service provider.
	New voicemail received on line 2 from the telephone service provider.
	New voicemail received on lines 1 and 2 from the telephone service provider.
	New answering system message(s) on line 1.
	New answering system message(s) on line 2.
	New answering system messages on lines 1 and 2.
	Answering system of line 1 is turned on.
	Answering system of line 2 is turned on.
	Answering systems of line 1 and line 2 are turned on.
	Speakerphone is in use.
	A wired headset is being used.
	New missed call(s) in call log.
	Microphone is muted.

Handset and telephone base indicators

Telephone base screen icons

	Line 1 is in use.
	Line 2 is in use.
	Base ringer of line 1 is turned off.
	Base ringer of line 2 is turned off.
	Base ringers of lines 1 and 2 are turned off.
	New voicemail received on line 1 from the telephone service provider.
	New voicemail received on line 2 from the telephone service provider.
	New voicemail received on lines 1 and 2 from the telephone service provider.
	New answering system message(s) on line 1.
	New answering system message(s) on line 2.
	New answering system messages on lines 1 and 2.
	New missed call(s) in call log.
	Microphone is muted.

Alert tones and lights

Handset alert tones

One short beep	Tone of each key press, if key tone is turned on.
One long beep	Indication to begin recording a message, memo or announcement.
Two short beeps	You are pressing ▼ _{CID} or ▲ _{DIR} on a cordless handset when the volume is already at its highest or lowest setting. -OR- Call waiting tone. -OR- Error tone. -OR- Registration failure tone.
Confirmation tone (three rising tones)	The system has completed the command successfully.
Four beeps	The other party has ended your intercom call. -OR- The handset has gone out of range from the base during a call.
Four short beeps	Low battery warning.

Telephone base alert tones

One short beep	Tone of each key press, if key tone is turned on.
One long beep	Indication to begin recording a message, memo or announcement.
Two short beeps	You are pressing ▼/ VOLUME /▲ on the telephone base when the volume is already at its highest or lowest setting. -OR- Call waiting tone. -OR- Error tone. -OR- Registration slots are full.
Confirmation tone (three rising tones)	The system has completed the command successfully.
Four beeps	The other party has ended your intercom call.

Alert tones and lights

Handset lights

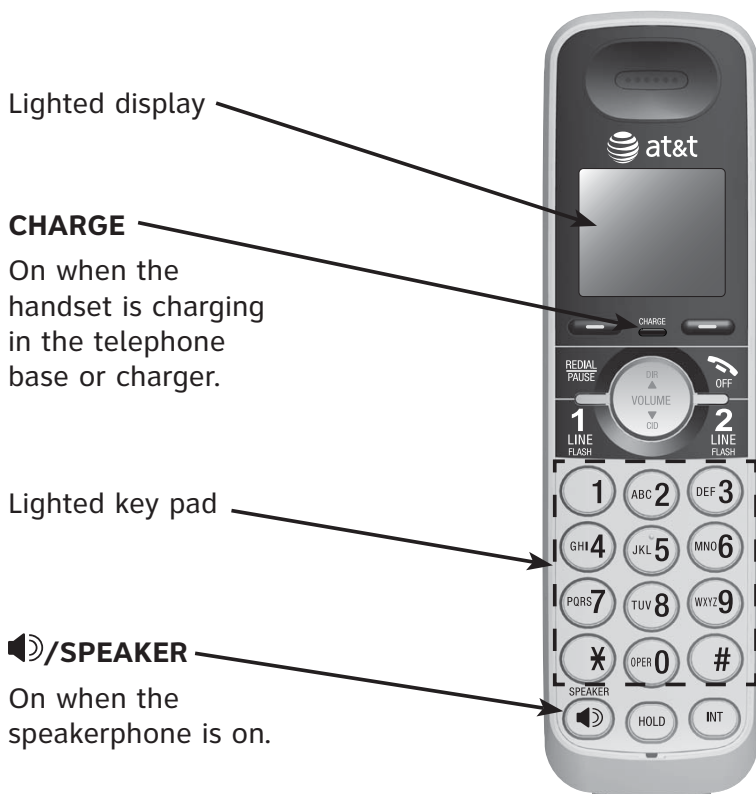

Lighted display

CHARGE

On when the handset is charging in the telephone base or charger.

Lighted key pad

SPEAKER

On when the speakerphone is on.

Telephone base lights

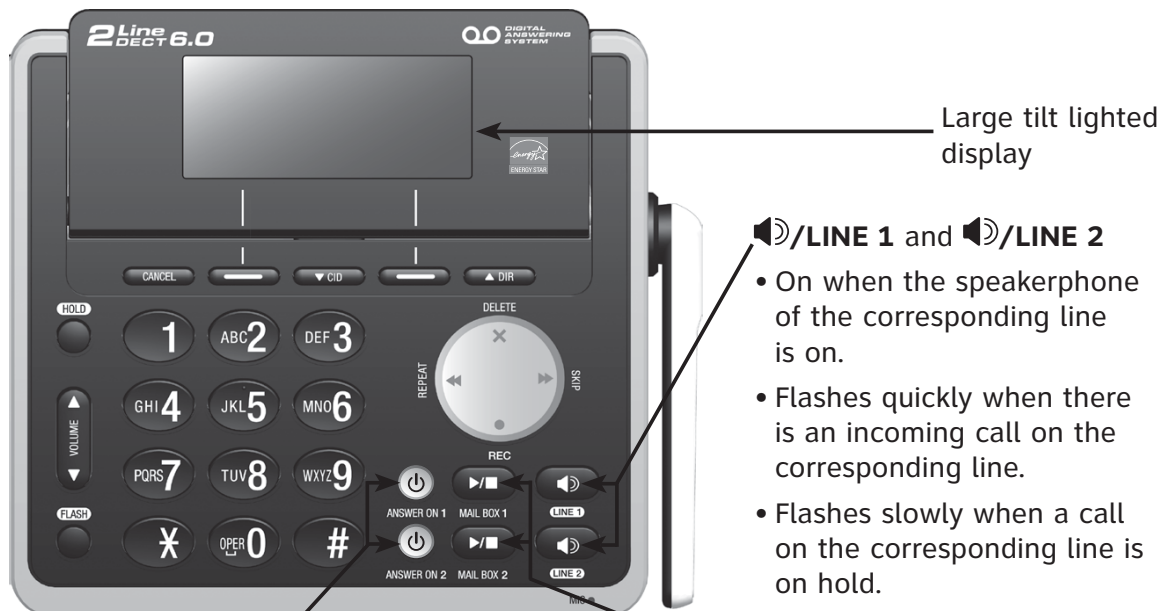

Large tilt lighted display

SPEAKER/LINE 1 and SPEAKER/LINE 2

- On when the speakerphone of the corresponding line is on.
- Flashes quickly when there is an incoming call on the corresponding line.
- Flashes slowly when a call on the corresponding line is on hold.

ANSWER ON 1 and ANSWER ON 2

- On when the answering system of the corresponding line is on.

MAIL BOX 1 and MAIL BOX 2

- On when a message of the corresponding line is playing.
- Flashes when there are new messages in the mail box of the corresponding line.

Screen display messages

Screen messages

Already saved	The telephone number entered is already stored in the directory.
Base is calling	Telephone base is calling.
Call log empty	There are no call log entries.
Calling base	A system handset is calling the telephone base.
Calling handset (for model with one handset) Calling handset X (for model with two or more handsets)	Another system handset or the telephone base is calling a system handset.
Directory empty	There are no directory entries.
Directory is full	The directory is full.
Ended	You have just ended a call.
Handset is calling (for model with one handset) Handset X is calling (for model with two or more handsets)	The telephone base is called by a system handset.
Other handset is calling (for model with two handsets) Handset X is calling (for model with three or more handsets)	A system handset is called by another system handset.
Intercom	A system handset or the telephone base is on an intercom call.
Intercom ended	You have just ended an intercom call.
L1)X Missed	There are calls that have not been reviewed in your call log on line 1.
L2)X Missed	There are calls that have not been reviewed in your call log on line 2.
L1)Ans Sys Full	Answering system of line 1 is full.
L2)Ans Sys Full	Answering system of line 2 is full.
L1)IN USE	Line 1 is in use.
L2)IN USE	Line 2 is in use.
L1)X New Msg(s)	There are new voicemail messages from your telephone service provider on line 1.
L2)X New Msg(s)	There are new voicemail messages from your telephone service provider on line 2.
L1)NO LINE	There is no telephone line connected on line 1.
L2)NO LINE	There is no telephone line connected on line 2.

Screen display messages

L1)ON HOLD	Line 1 is on hold.
L2)ON HOLD	Line 2 is on hold.
Line 1 Incoming call	There is an incoming call on line 1.
Line 2 Incoming call	There is an incoming call on line 2.
Microphone ON	MUTE is turned off and the person on the other end can hear you.
Microphone off	You have turned off the handset microphone. The other party cannot hear you but you can hear the other party.
No signal, call ended	Communication between the system handset and telephone base is lost during a call.
Not available at this time	One system handset or the telephone base is already viewing the call log or directory and another handset/telephone base attempts to review it.
Out of range OR no power at base	The system handset cannot communicate with the telephone base. Check the telephone base power connection or move closer.
Paging all handsets	The telephone base is paging handset(s).
Paging	The system handset is paged.
Place handset in charger	The battery is very low. Place the system handset in the telephone base for recharging.
Ringer muted	The ringer is muted temporarily during an incoming call.
Saved	Your selection has been saved.
Unable to call try again	You try to make an intercom call but the system handset/telephone base you are calling is in the directory, in the call log, on an outside call, or the system handset is out of range.
Unable to save	You try to save a caller ID entry with no name or number.

Troubleshooting

If you have difficulty with your phone, please try the suggestions below. For Customer Service, visit our website at **www.telephones.att.com** or call **1 (800) 222-3111**. In Canada, dial **1 (866) 288-4268**.

My telephone doesn't work at all.

- Make sure the power cord is securely plugged in.
- Make sure you plug the battery connector securely into the cordless handset.
- Make sure you plug the telephone line cord securely and firmly into the telephone base and the telephone wall jack.
- Charge the battery in the cordless handset for at least ten hours. For optimum daily performance, return the cordless handset to the telephone base or charger when not in use.
- If the battery is depleted, it may take approximately 30 minutes to charge the handset before it shows **Low battery**. See page 8 for details.
- Reset the telephone base. Unplug the electrical power. Wait for approximately 15 seconds, then plug it back in. Allow up to one minute for the cordless handset and telephone base to reset.
- You may need to purchase a new battery. Please refer to **Battery installation and charging** in this user's manual on pages 8-9.

I cannot get a dial tone.

- Try all the suggestions above.
- Move the cordless handset closer to the telephone base. You may have moved out of range.
- If the previous suggestions do not work, disconnect the telephone base from the telephone jack and connect to a different phone. If there is no dial tone on that phone either, the problem is in your wiring or telephone service. Contact your telephone service provider.
- Your line cord may be defective. Try installing a new line cord.

I cannot dial out.

- Try all the suggestions above.
- Make sure you have a dial tone before dialing. The cordless handset may take a second or two to find the telephone base and produce a dial tone. This is normal. Wait an extra second before dialing.
- Eliminate any background noise. Noise from a television, radio or other appliances may cause the phone to not dial out properly. If you cannot eliminate the background noise, first try muting the cordless handset before dialing, or dialing from another room with less background noise.
- If other phones in your home are having the same problem, contact your telephone service provider (charges may apply).

Troubleshooting

My cordless handset isn't performing normally.

- Make sure you plug the power cord securely into the telephone base. Plug the power adapter into a different working electrical outlet without a wall switch.
- Move the cordless handset closer to the telephone base. You may have moved out of range.
- Reset the telephone base. Unplug the electrical power. Wait for 15 seconds then plug it back in. Allow up to one minute for the cordless handset and telephone base to reset.
- Other electronic products such as HAM radios and other DECT phones can cause interference with your cordless phone. Try installing your phone as far away as possible from these types of electronic devices.

Out of range OR no power at base appears on my cordless handset.

- Ensure you plug the telephone base in properly and the power is on.
- Place the cordless handset in the telephone base for one minute to allow the cordless handset and base to synchronize.
- Move the cordless handset closer to the telephone base. You may have moved out of range.
- Reset the telephone base. Unplug the electrical power. Wait for 15 seconds then plug it back in. Allow up to one minute for the cordless handset and telephone base to reset.
- Other electronic products such as HAM radios and other DECT phones can cause interference with your cordless phone. Try installing your phone as far away as possible from these types of electronic devices.

The batteries do not hold a charge.

- If the cordless handset is in the telephone base or charger and the charge light is not on, refer to **The charge light is off or blinking** (page 88).
- Charge the battery in the cordless handset for at least ten hours. For optimum daily performance, return the cordless handset to the telephone base or charger when not in use.
- If the battery is depleted, it may take approximately 30 minutes to charge the handset before it shows **Low battery**. Refer to the table on page 8 for details.
- You may need to purchase a new battery. Please refer to **Battery installation and charging** in this user's manual on page 8-9.

Troubleshooting

I get noise, static, or weak signals even when I'm near the telephone base.

- If you subscribe to high-speed Internet service (DSL - digital subscriber line) through your telephone line, you must install a DSL filter between the telephone line cord and the telephone wall jack (pages 6-7). The filter prevents noise and caller ID problems as a result of DSL interference. Please contact your DSL service provider for more information about DSL filters.
- You may be able to improve the performance of your cordless phone by installing your new telephone base as far as possible from any other existing cordless telephone system that may already be installed.
- Other electronic products such as HAM radios and other DECT phones can cause interference with your cordless phone. Try installing your phone as far away as possible from these types of electronic devices.
- Do not install this phone near a microwave oven or on the same electrical outlet. You may experience decreased performance while the microwave oven is operating.
- If you plug your phone in with a modem or a surge protector, plug the phone (or modem/surge protector) into a different location. If this does not solve the problem, relocate your phone or modem farther apart from one another, or use a different surge protector.
- Move your phone to a higher location. The phone may have better reception in a high area.
- If other phones in your home are having the same problem, contact your telephone service provider (charges may apply).

I experience poor sound quality when using the handset speakerphone.

- For increased sound quality while using the handset speakerphone, place the handset on a flat surface with the dial pad facing up.

I hear other calls while using my phone.

- Disconnect the telephone base from the telephone jack, and plug in a different telephone. If you still hear other calls, call your telephone service provider.

My cordless handset does not ring when I receive a call.

- Make sure that the ringer is not off. Refer to **Ringer volume** on page 12 in this user's manual.
- Make sure you plug in the telephone line cord securely into the telephone base and the telephone jack. Make sure you plug in the power cord securely.
- The cordless handset may be too far from the telephone base.

Troubleshooting

- Charge the battery in the cordless handset for at least ten hours. For optimum daily performance, return the cordless handset to the telephone base or charger when not in use.
- You may have too many extension phones on your telephone line to allow all of them to ring simultaneously. Try unplugging some of the other phones.
- The layout of your home or office may be limiting the operating range. Try moving the telephone base to another location, preferably to a higher location.
- If other phones in your home are having the same problem, contact your telephone service provider (charges may apply).
- Test a working phone at the phone jack. If another phone has the same problem, contact your telephone service provider (charges may apply).
- Other electronic products can cause interference with your cordless phone. Try installing your phone as far away as possible from electronic devices such as television sets, VCRs, or other cordless telephones.
- Remove the battery. Install the battery again and place the cordless handset into the telephone base. Wait for the cordless handset to reestablish its connection with the telephone base. Allow up to one minute for this to take place.
- Your line cord may be defective. Try installing a new line cord.

My calls cut in and out while I'm using my cordless handset.

- Other electronic products such as HAM radios and other DECT phones can cause interference with your cordless phone. Try installing your phone as far away as possible from these types of electronic devices.
- Do not install this phone near a microwave oven or on the same electrical outlet. You may experience decreased performance while the microwave oven is operating.
- If you plug your phone in with a modem or surge protector, plug the phone (or modem/surge protector) into a different location. If this does not solve the problem, relocate your phone or modem farther apart from one another, or use a different surge protector.
- Move your telephone base to a higher location. The phone may have better reception when installed in a high area.
- If other phones in your home are having the same problem, contact your telephone service provider (charges may apply).

Troubleshooting

The charge light is off or blinking.

- Make sure you plug the power and line cords in correctly and securely.
- Unplug the electrical power. Wait for 15 seconds, then plug it back in. Allow up to one minute for the cordless handset and telephone base to reset.
- Clean the cordless handset, charger and telephone base charging contacts each month with a pencil eraser or cloth.
- A blinking **CHARGE** light is an indication that the battery is not connected to the handset or is missing completely. Ensure that the battery is installed properly.

My caller ID isn't working.

- Caller ID is a subscription service. You must subscribe to this service from your telephone service provider for this feature to work on your phone.
- The caller may be calling from an area that supports caller ID.
- Both your and your caller's telephone service providers must use caller ID compatible equipment.
- If you subscribe to high-speed Internet service (DSL - digital subscriber line) through your telephone line, you must install a DSL filter between the telephone line cord and the telephone wall jack (pages 6-7). The filter prevents noise and caller ID problems resulting from DSL interference. Please contact your DSL service provider for more information about DSL filters.

System does not receive caller ID when on a call.

- Make sure you subscribe to caller ID with call waiting features from your telephone service provider. Caller ID features works only if both you and the caller are in areas offering caller ID service, and if both telephone service providers use compatible equipment.

Incomplete messages.

- If a caller leaves a very long message, part of it may be lost when the system disconnects the call after the maximum recording time you have set.
- If the caller pauses for longer than seven seconds, the system stops recording and disconnects the call.
- If the system's memory becomes full during a message, the system stops recording and disconnects the call.
- If the caller's voice is very soft, the system may stop recording and disconnect the call.

Troubleshooting

Difficulty hearing messages.

- Press **VOLUME/▲** to increase the telephone base speaker volume.
- Press **▲DIR/VOLUME** to adjust the message playback volume on a handset.

System does not answer after the correct number of rings.

- Make sure that the answering system is on. ^{Ans1} ON₁, ^{Ans} ON₂ or ^{Ans1} ON₂ should show on the handset and the **☎/ANSWER ON 1** and/or **☎/ANSWER ON 2** light on the telephone base should be on.
- If toll saver is activated, the number of rings changes to two when you have new messages stored (page 65).
- If the memory is full or the system is off, the system will answer after ten rings.
- In some cases, the answering system is affected by the ringing system used by your telephone service provider.
- If you subscribe to voicemail service, change the number of rings so that your answering system answers before your voicemail answers (page 65). To determine how many rings activate your voicemail, contact your telephone service provider.
- If there is a fax machine connected to the same telephone line, try disconnecting the fax machine. If that solves the problem, consult your fax machine documentation for information on compatibility with answering systems.

System does not respond to remote commands.

- Make sure to enter your remote access code correctly (page 66).
- Make sure you are calling from a touch-tone phone. When you dial a number, you should hear tones. If you hear clicks, the phone is not a touch-tone telephone and cannot activate the answering system.
- The answering system may not detect the remote access code while your announcement is playing. Try waiting until the announcement is over before entering the code.
- There may be interference on the phone line you are using. Press dialing keys firmly.

Troubleshooting

System does not record messages.

- Make sure the answering system is on. ^{ANS1} ON1, ^{ANS} ON2 or ^{ANS1} ON2 should show on the handset and the **☎/ANSWER ON 1** and/or **☎/ANSWER ON 2** light on the telephone base should be on.
- Make sure the memory of the answering system is not full.
- If you subscribe to voicemail service, change the number of rings so that your answering system answers before your voicemail answers (page 65). To determine how many rings activate your voicemail, contact your telephone service provider.
- If there is a fax machine connected to the same telephone line, try disconnecting the fax machine. If that solves the problem, consult your fax machine documentation for information on compatibility with answering systems.

System announces, “Time and day not set.”

- You need to reset the system clock (page 15 or 21).

Outgoing announcement is not clear.

- When you record your announcement, make sure you speak in a normal tone of voice, about nine inches from the handset or the telephone base.
- Make sure there is no background noise (TV, music, etc.) while recording.

An icon and a line number appear on the handset and telephone base screen and I don't know why.

- Your telephone has voicemail indication that is separate from the built-in answering system. If the  icon and a line number appear on the display, your telephone has received a signal from your telephone service provider that you have a voicemail message waiting for you to retrieve from them. Contact your telephone service provider for more information on how to access your voicemail.

I cannot retrieve voicemail messages.

- Your telephone has both a built-in answering system and voicemail indication. They are independent features and each alerts you to new messages differently (page 68). If you subscribe to voicemail service from your telephone service provider, contact your telephone service provider for more information on how to access your voicemail.

Troubleshooting

I subscribe to a nontraditional telephone service that uses my computer to establish connections, and my telephone doesn't work.

- Make sure your computer is powered on.
- Make sure your Internet connection is working properly.
- Make sure that the software is installed and running for your nontraditional telephone service.
- Make sure to plug your USB telephone adapter into a dedicated USB port on your computer. Do not plug it into a multiple port USB hub (USB splitter) that is not powered.
- In a few rare instances, the USB port on your computer may not have enough power. Try using a USB hub with its own external power supply.
- If you are using a firewall, it may prevent access to your nontraditional telephone service provider. Contact your service provider for more information.

Common cure for electronic equipment.

If the telephone does not seem to be responding normally, try putting the cordless handset in the telephone base or charger. If it does not fix the problem, do the following (in the order listed):

1. Disconnect the power to the telephone base.
2. Disconnect the cordless handset battery.
3. Wait a few minutes.
4. Connect power to the telephone base.
5. Remove the battery. Replace the battery and place the cordless handset into the telephone base or charger.
6. Wait for the cordless handset to reestablish its connection with the telephone base. Allow up to one minute for this to take place.

Maintenance

Taking care of your telephone

- Your cordless telephone contains sophisticated electronic parts, so you must treat it with care.
- Avoid rough treatment.
- Place the handset down gently.
- Save the original packing materials to protect your telephone if you ever need to ship it.

Avoid water

- You can damage your telephone if it gets wet. Do not use the handset in the rain, or handle it with wet hands. Do not install the telephone base near a sink, bathtub or shower.

Electrical storms

- Electrical storms can sometimes cause power surges harmful to electronic equipment. For your own safety, take caution when using electric appliances during storms.

Cleaning your telephone

- Your telephone has a durable plastic casing that should retain its luster for many years. Clean it only with a soft cloth slightly dampened with water or mild soap.
- Do not use excess water or cleaning solvents of any kind.

Remember that electrical appliances can cause serious injury if used when you are wet or standing in water. If the telephone base should fall into water, **DO NOT RETRIEVE IT UNTIL YOU UNPLUG THE POWER CORD AND TELEPHONE LINE CORDS FROM THE WALL.** Then pull the unit out by the unplugged cords.

Important safety information



This symbol is to alert you to important operating or servicing instructions that may appear in this user's manual. Always follow basic safety precautions when using this product to reduce the risk of injury, fire, or electric shock.

Safety information

- Read and understand all instructions in the user's manual. Observe all markings on the product.
- Avoid using a telephone during a thunderstorm. There may be a slight chance of electric shock from lightning.
- Do not use a telephone in the vicinity of a gas leak. Under certain circumstances, a spark may be created when the adapter is plugged into the power outlet, or when the handset is replaced in its cradle. This is a common event associated with the closing of any electrical circuit. The user should not plug the phone into a power outlet, and should not put a charged handset into the cradle, if the phone is located in an environment containing concentrations of flammable or flame-supporting gases, unless there is adequate ventilation. A spark in such an environment could create a fire or explosion. Such environments may include: medical use of oxygen without adequate ventilation; industrial gases (cleaning solvents; gasoline vapors; etc.); a leak of natural gas; etc.
- Do not use this product near water, or when you are wet. For example, do not use it in a wet basement or shower, or next to a swimming pool, bathtub, kitchen sink, or laundry tub. Do not use liquids or aerosol sprays for cleaning. If the product comes in contact with any liquid, unplug any line or power cord immediately. Do not plug the product back in until it has dried thoroughly.
- Install this product in a protected location where no one can trip over any line or power cords. Protect cords from damage or abrasion.
- If this product does not operate normally, see the **Troubleshooting** section on pages 84-91 of this user's manual. If you cannot solve the problem, or if the product is damaged, refer to the **Limited warranty** section on pages 97-98. Do not open this product except as directed in your user's manual. Opening the product or reassembling it incorrectly may expose you to hazardous voltages or other risks.
- Replace batteries only as described in your user's manual (pages 8-9). Do not burn or puncture batteries — they contain caustic chemicals.
- The power adapters are intended to be correctly oriented in a vertical or floor mount position. The prongs are not designed to hold the plug in place if it is plugged into a ceiling, under-the-table or cabinet outlet.



Caution: Use only the power adapters provided with this product. To obtain a replacement, visit our website at www.telephones.att.com or call **1 (800) 222-3111**. In Canada, dial **1 (866) 288-4268**.

Important safety information

Especially about cordless telephones

- **Privacy:** The same features that make a cordless telephone convenient create some limitations. Telephone calls are transmitted between the telephone base and the handset by radio waves, so there is a possibility that your cordless telephone conversations could be intercepted by radio receiving equipment within range of the cordless handset. For this reason, you should not think of cordless telephone conversations as being as private as those on corded telephones.
- **Electrical power:** The telephone base of this cordless telephone must be connected to a working electrical outlet which is not controlled by a wall switch. Calls cannot be made from the handset if the telephone base is unplugged, switched off or if the electrical power is interrupted.
- **Potential TV interference:** Some cordless telephones operate at frequencies that may cause interference to TVs and VCRs. To minimize or prevent such interference, do not place the telephone base of the cordless telephone near or on top of a TV or VCR. If interference is experienced, moving the cordless telephone farther away from the TV or VCR will often reduce or eliminate the interference.
- **Rechargeable batteries:** This product contains nickel-metal hydride rechargeable batteries. Exercise care in handling batteries in order not to create a short circuit with conductive material such as rings, bracelets and keys. The battery or conductor may overheat and cause harm. Observe proper polarity between the battery and the battery charger.
- **Nickel-metal hydride rechargeable batteries:** Dispose of these batteries in a safe manner. Do not burn or puncture. Like other batteries of this type, if burned or punctured, they could release caustic material which could cause injury.



The RBRC™ Seal means that the manufacturer is voluntarily participating in an industry program to collect and recycle nickel-metal hydride rechargeable batteries when taken out of service within the United States. These batteries may be taken to a participating local retailer of replacement batteries or recycling center. Or you may call 1 (800) 8-BATTERY for locations accepting spent Ni-MH batteries.

Precautions for users of implanted cardiac pacemakers

Cardiac pacemakers (applies only to digital cordless telephones):

Wireless Technology Research, LLC (WTR), an independent research entity, led a multidisciplinary evaluation of the interference between portable wireless telephones and implanted cardiac pacemakers. Supported by the U.S. Food and Drug Administration, WTR recommends to physicians that:

Pacemaker patients

- Should keep wireless telephones at least six inches from the pacemaker.
- Should NOT place wireless telephones directly over the pacemaker, such as in a breast pocket, when it is turned ON.
- Should use the wireless telephone at the ear opposite the pacemaker.

WTR's evaluation did not identify any risk to bystanders with pacemakers from other persons using wireless telephones.

Especially about telephone answering systems

Two-way recording: This unit does not sound warning beeps to inform the other party that the call is being recorded. To ensure that you are in compliance with any federal or state regulations regarding recording a telephone call, you should start the recording process and then inform the other party that you are recording the conversation.

SAVE THESE INSTRUCTIONS

FCC Part 68 and ACTA

This equipment complies with Part 68 of the FCC rules and with technical requirements adopted by the Administrative Council for Terminal Attachments (ACTA). The label on the back or bottom of this equipment contains, among other things, a product identifier in the format US:AAAEQ##TXXXX. This identifier must be provided to your telephone service provider upon request.

The plug and jack used to connect this equipment to premises wiring and the telephone network must comply with the applicable Part 68 rules and technical requirements adopted by ACTA. A compliant telephone cord and modular plug is provided with this product. It is designed to be connected to a compatible modular jack that is also compliant. An RJ11 jack should normally be used for connecting to a single line and an RJ14 jack for two lines. See the installation instructions in the user's manual.

The Ringer Equivalence Number (REN) is used to determine how many devices you may connect to your telephone line and still have them ring when you are called. The REN for this product is encoded as the 6th and 7th characters following the US: in the product identifier (e.g., if ## is 03, the REN is 0.3). In most, but not all areas, the sum of all RENs should be five (5.0) or less. For more information, please contact your telephone service provider.

This equipment may not be used with Party Lines. If you have specially wired alarm dialing equipment connected to your telephone line, ensure the connection of this equipment does not disable your alarm equipment. If you have questions about what will disable the alarm equipment, consult your telephone service provider or a qualified installer.

If this equipment is malfunctioning, it must be unplugged from the modular jack until the problem has been corrected. Repairs to this telephone equipment can only be made by the manufacturer or its authorized agents. For repair procedures, follow the instructions outlined under the **Limited warranty** section.

If this equipment is causing harm to the telephone network, the telephone service provider may temporarily discontinue your telephone service. The telephone service provider is required to notify you before interrupting service. If advance notice is not practical, you will be notified as soon as possible. You will be given the opportunity to correct the problem and the telephone service provider is required to inform you of your right to file a complaint with the FCC. Your telephone service provider may make changes in its facilities, equipment, operation, or procedures that could affect the proper functioning of this product. The telephone service provider is required to notify you if such changes are planned.

If this product is equipped with a corded or cordless handset, it is hearing aid compatible.

If this product has memory dialing locations, you may choose to store emergency telephone numbers (e.g., police, fire, medical) in these locations. If you do store or test emergency numbers, please:

- Remain on the line and briefly explain the reason for the call before hanging up.
- Perform such activities in off-peak hours, such as early morning or late evening.

Industry Canada

Operation is subject to the following two conditions: (1) this device may not cause harmful interference, and (2) this device must accept any interference, including interference that may cause undesired operation.

The term "IC:" before the certification/registration number only signifies that the Industry Canada technical specifications were met.

The Ringer Equivalence Number (REN) for this terminal equipment is 1.0. The REN is an indication of the maximum number of devices allowed to be connected to a telephone interface. The termination on an interface may consist of any combination of devices subject only to the requirement that the sum of the RENs of all the devices does not exceed five.

This product meets the applicable Industry Canada technical specifications.

FCC Part 15

This equipment has been tested and found to comply with the requirements for a Class B digital device under Part 15 of the Federal Communications Commission (FCC) rules. These requirements are intended to provide reasonable protection against harmful interference in a residential installation. This equipment generates, uses and can radiate radio frequency energy and, if not installed and used in accordance with the instructions, may cause harmful interference to radio communications. However, there is no guarantee that interference will not occur in a particular installation. If this equipment does cause harmful interference to radio or television reception, which can be determined by turning the equipment off and on, the user is encouraged to try to correct the interference by one or more of the following measures:

- Reorient or relocate the receiving antenna.
- Increase the separation between the equipment and receiver.
- Connect the equipment into an outlet on a circuit different from that to which the receiver is connected.
- Consult the dealer or an experienced radio/TV technician for help.

Changes or modifications to this equipment not expressly approved by the party responsible for compliance could void the user's authority to operate the equipment.

This device complies with Part 15 of the FCC Rules. Operation is subject to the following two conditions: (1) this device may not cause harmful interference, and (2) this device must accept any interference received, including interference that may cause undesired operation. Privacy of communications may not be ensured when using this telephone.

To ensure safety of users, the FCC has established criteria for the amount of radio frequency energy that can be safely absorbed by a user or bystander according to the intended usage of the product. This product has been tested and found to comply with the FCC criteria. The handset may be safely held against the ear of the user. The telephone base shall be installed and used such that parts of the user's body other than the hands are maintained at a distance of approximately 20 cm (8 inches) or more.

This Class B digital apparatus complies with Canadian ICES-003.

For body worn operation, this handset has been tested and meets the FCC RF exposure guidelines when used with an accessory that contains no metal and that positions the handset a minimum of 0mm from the body. Use of other accessories may not ensure compliance with FCC RF exposure guidelines.

Limited warranty

The AT&T brand is used under license - any repair, replacement or warranty service, and all questions about this product should be directed to our website at **www.telephones.att.com** or call **1 (800) 222-3111**. In Canada, dial **1 (866) 288-4268**.

1. What does this limited warranty cover?

The manufacturer of this AT&T branded product warrants to the holder of a valid proof of purchase ("CONSUMER" or "you") that the product and all accessories provided in the sales package ("PRODUCT") are free from defects in material and workmanship, pursuant to the following terms and conditions, when installed and used normally and in accordance with the PRODUCT operating instructions. This limited warranty extends only to the CONSUMER for products purchased and used in the United States of America and Canada.

2. What will be done if the PRODUCT is not free from defects in materials and workmanship during the limited warranty period ("materially defective PRODUCT")?

During the limited warranty period, the manufacturer's authorized service representative will repair or replace at the manufacturer's option, without charge, a materially defective PRODUCT. If the manufacturer repairs the PRODUCT, they may use new or refurbished replacement parts. If the manufacturer chooses to replace the PRODUCT, they may replace it with a new or refurbished PRODUCT of the same or similar design. The manufacturer will retain defective parts, modules, or equipment. Repair or replacement of the PRODUCT, at the manufacturer's option, is your exclusive remedy. The manufacturer will return repaired or replacement products to you in working condition. You should expect the repair or replacement to take approximately 30 days.

3. How long is the limited warranty period?

The limited warranty period for the PRODUCT extends for ONE (1) YEAR from the date of purchase. If the manufacturer repairs or replaces a materially defective PRODUCT under the terms of this limited warranty, this limited warranty also applies to repaired or replacement PRODUCT for a period of either (a) 90 days from the date the repaired or replacement PRODUCT is shipped to you or (b) the time remaining on the original one-year limited warranty; whichever is longer.

4. What is not covered by this limited warranty?

This limited warranty does not cover:

- PRODUCT that has been subjected to misuse, accident, shipping or other physical damage, improper installation, abnormal operation or handling, neglect, inundation, fire, water, or other liquid intrusion; or
- PRODUCT that has been damaged due to repair, alteration, or modification by anyone other than an authorized service representative of the manufacturer; or
- PRODUCT to the extent that the problem experienced is caused by signal conditions, network reliability or cable or antenna systems; or
- PRODUCT to the extent that the problem is caused by use with non-AT&T accessories; or
- PRODUCT whose warranty/quality stickers, PRODUCT serial number plates or electronic serial numbers have been removed, altered or rendered illegible; or
- PRODUCT purchased, used, serviced, or shipped for repair from outside the United States of America or Canada, or used for commercial or institutional purposes (including but not limited to products used for rental purposes); or
- PRODUCT returned without valid proof of purchase (see item 6 below); or
- Charges for installation or setup, adjustment of customer controls, and installation or repair of systems outside the unit.

Limited warranty

5. How do you get warranty service?

To obtain warranty service, visit our website at **www.telephones.att.com** or call **1 (800) 222-3111**. In Canada, dial **1 (866) 288-4268**.

NOTE: Before calling for service, please review the user's manual; a check of the PRODUCT's controls and features may save you a service call.

Except as provided by applicable law, you assume the risk of loss or damage during transit and transportation and are responsible for delivery or handling charges incurred in the transport of the PRODUCT(s) to the service location. The manufacturer will return repaired or replaced PRODUCT under this limited warranty to you. Transportation, delivery or handling charges are prepaid. The manufacturer assumes no risk for damage or loss of the PRODUCT in transit. If the PRODUCT failure is not covered by this limited warranty, or proof of purchase does not meet the terms of this limited warranty, the manufacturer will notify you and will request that you authorize the cost of repair prior to any further repair activity. You must pay for the cost of repair and return shipping costs for the repair of products that are not covered by this limited warranty.

6. What must you return with the PRODUCT to get warranty service?

You must:

- Return the entire original package and contents including the PRODUCT to the service location along with a description of the malfunction or difficulty; and
- Include a "valid proof of purchase" (sales receipt) identifying the PRODUCT purchased (PRODUCT model) and the date of purchase or receipt; and
- Provide your name, complete and correct mailing address, and telephone number.

7. Other limitations

This warranty is the complete and exclusive agreement between you and the manufacturer of this AT&T branded PRODUCT. It supersedes all other written or oral communications related to this PRODUCT. The manufacturer provides no other warranties for this PRODUCT. The warranty exclusively describes all of the manufacturer's responsibilities regarding the PRODUCT. There are no other express warranties. No one is authorized to make modifications to this limited warranty and you should not rely on any such modification.

State/Provincial Law rights: This warranty gives you specific legal rights, and you may also have other rights which vary from state to state or province to province.

Limitations: Implied warranties, including those of fitness for a particular purpose and merchantability (an unwritten warranty that the PRODUCT is fit for ordinary use) are limited to one year from date of purchase. Some states/provinces do not allow limitations on how long an implied warranty lasts, so the above limitation may not apply to you. In no event shall the manufacturer be liable for any indirect, special, incidental, consequential, or similar damages (including, but not limited to lost profits or revenue, inability to use the PRODUCT or other associated equipment, the cost of substitute equipment, and claims by third parties) resulting from the use of this PRODUCT. Some states/provinces do not allow the exclusion or limitation of incidental or consequential damages, so the above limitation or exclusion may not apply to you.

Please retain your original sales receipt as proof of purchase.

Technical specifications

RF frequency band	1921.536MHz - 1928.448MHz
Channels	5
Operating temperature	32°F - 122°F 0°C - 50°C
Telephone base voltage (AC voltage, 60Hz)	96Vrms - 129Vrms
Telephone base voltage (AC adapter output)	6V DC @ 600mA
Handset voltage	2.4VDC - 3.2VDC
Charger voltage (AC adapter output)	6VAC @ 300mA

Operation	Operating time*
Talk time (cordless handset)	Up to seven hours
Talk time (cordless handset speakerphone)	Up to five hours
Standby	Up to seven days

* Operating times vary depending on your actual use and the age of the battery.

DECT 6.0 digital technology

The AT&T DECT 6.0 products offer unsurpassed range performance and sound clarity. This is achieved through a unique antenna design and advances in noise-filtering technology. An independent laboratory has confirmed that AT&T DECT 6.0 products perform up to 45% better in range competitions against similarly equipped phones of the leading competition. Now calls can be taken in the basement, backyard and garage with exceptional sound quality.

Telephone operating range

This cordless telephone operates within the maximum power allowed by the Federal Communications Commission (FCC). Even so, this handset and telephone base can communicate over only a certain distance — which can vary with the locations of the telephone base and handset, the weather, and the construction of your home or office.

Redefining long range coverage and clarity

This telephone base comes with an antenna which gives much better clarity and covers a longer range than before.

Index

A

- Add a handset 76
- Alert tones
 - handset 67, 80
 - message alert tone 67, 70
 - telephone base 67, 80
- Announcement 59–62
- Answer an incoming call during an intercom call 33
- Answering calls 23
- Answering system 59–75
- Answer ON/OFF 63
- Area code 16, 22

B

- Battery
 - charging 9
 - installation 8
- Belt Clip 10

C

- Caller ID (CID)
 - add entries to phone directory 56
 - delete entries 57
 - dial entries 55
 - review entries 54
- Call intercept 70
- Call screening 64, 69
- Call transfer 34–35
- Call waiting 27
- Chain dialing 29–30
- Character chart 39
- Charger installation 7
- Clear voicemail indication
 - handset 13
 - telephone base 19
- Clock
 - handset 15
 - telephone base 21
- Conference Call 38

D

- Dialing
 - from the directory 44
 - Day and time
 - handset 15
 - telephone base 21
 - Delete
 - a caller ID log entry 57
 - a directory entry 44
 - all old messages 72
 - an announcement 62
 - a speed dial number 50
 - Deregister handsets 77
 - Dial
 - from a record in the caller ID history 55
 - from the directory 44
 - Directory
 - dial a number 44
 - edit entries 44–45
 - name search 43
 - new entries 40–41
 - DSL 6–7
-
- ## E
-
- Ending a call 23
-
- ## F
-
- Find handset 31
-
- ## H
-
- Handset
 - handset locator 31
 - quick reference guide 1–2
 - ringer tone 12
 - ringer volume 12
 - screen icons 78
 - speakerphone 24
 - temporary ringer silencing 24
 - voicemail indicator 68
 - Headset 10
 - Hold 28

Index

- Home area code
 - handset 16
 - telephone base 22

I

- Important safety information 93–94
- Installation 5–9
- Intercom 32–35

K

- Key tone
 - handset 14
 - telephone base 20

L

- Last number redial 24–26
- LCD language 13, 19
- Lights 81
- Limited warranty 97–98

M

- Maintenance 92
- Making calls 23
- Memo 73–74
- Memory match 53
- Message
 - alert tone 67, 70
 - capacity 69
 - indicator 69
 - playback 71–72
- Missed call indicator 52
- Multiple handset use 31
- Mute 27

N

- Number of rings 65

O

- Outgoing announcement 59–62

P

- Phonebook 39
- Power adapter 6–7
- Predialing 23

Q

- Quick reference guide 1–4

R

- Reassign a speed dial number 50
- Receiving calls 23
- Recharging 9
- Redial 24–26
- Remote access 66, 75
- Remote access code 66
- Ringer silencing 24
- Ringer volume
 - handset 12
 - telephone base 18
- Ring tone options
 - handset 12
 - telephone base 18

S

- Safety information 93–94
- Screen display message 82–83
- Settings
 - answering system 59–67
 - handset 11–16
 - telephone base 17–22
- Share an outside call 36
- Silence the ringer 24
- Speakerphone 24
- Speed dial
 - assign a number 46
 - delete a number 50
 - edit a number 49–50
 - enter a number 46–47

Index

T

- Technical specifications 99
- Telephone base
 - quick reference guide 3
 - ringer tone 18
 - ringer volume 18, 70
 - screen icons 79
 - voicemail indicator 19
- Temporary ringer silencing 24
- Time
 - handset 15
 - telephone base 21
- Transfer a call 34–35
- Troubleshooting 84–91

V

- Visual message waiting indicator 13, 19
- Voicemail 68
- Voice prompts 69
- Volume control
 - handset 27, 71
 - telephone base 27, 70, 71

W

- Warranty 97–98

Remote access wallet card

Use the wallet card below to help you remember commands to control your answering system from any touch-tone telephone.

Cut along dotted line.



at&t

Call your phone number, then enter your two-digit access code (preset to **19**).

Action	Remote command
--------	----------------

Play all messages	1
Play new messages.....	2
Delete the message.....	3
Delete all old messages	33
Repeat or go back	4
Stop.....	5
Help menu	* 5

Fold here.

Skip the message.....	6
Record announcement	* 7
End remote access call	8 (or hang up)
Turn system off or on	0

Models: TL88102/TL88202
Type: DECT 6.0 2-line cordless telephone/answering system with caller ID/call waiting

© 2012 Advanced American Telephones. All Rights Reserved.
AT&T and the AT&T logo are trademarks of AT&T Intellectual Property licensed to Advanced American Telephones, San Antonio, TX 78219.
Printed in China.



www.telephones.att.com