

TEST REPORT

Applicant Name: VTech Telecommunications Ltd
Address: 23/F Tai Ping Ind Center Block 1 57 Ting Kok Rd
Tai Po NT, Hong Kong
Report Number: SZ1231226-78524E-RF-00B
FCC ID: EW780-8534-00A

Test Standard (s)

FCC PART 15D

Sample Description

Product Type: DECT 6.0 cordless telephone
Model No.: CS6529-2
Multiple Model(s) No.: CS6529, CS6529-14, CS6529-15, CS6529-16, CS6529-17,
CS6529-19, CS6529-25, CS6529-26, CS6529-3, CS6529-4,
CS6529-4B, CS6529-5, CS652Z-XY
Trade Mark: VTech
Date Received: 2023/12/26
Report Date: 2024/04/23

Test Result:	Pass▲
--------------	-------

▲ In the configuration tested, the EUT complied with the standards above.

Prepared and Checked By:

Andy Yu

Andy Yu
RF Engineer

Approved By:

Nancy Wang

Nancy Wang
RF Supervisor

Note: The information marked # is provided by the applicant, the laboratory is not responsible for its authenticity and this information can affect the validity of the result in the test report. Customer model name, addresses, names, trademarks etc. are included.

This report cannot be reproduced except in full, without prior written approval of the Company. Unless otherwise stated the results shown in this test report refer only to the sample(s) tested. This report is valid only with a valid digital signature. The digital signature may be available only under the Adobe software above version 7.0.

This report must not be used by the customer to claim product certification, approval, or endorsement by NVLAP or any agency of the U.S. Government.

This report may contain data that are not covered by the NVLAP accreditation and are marked with an asterisk "▼".

Bay Area Compliance Laboratories Corp. (Shenzhen)

5F(B-West), 6F, 7F, the 3rd Phase of Wan Li Industrial Building D, Shihua Rd, FuTian Free Trade Zone, Shenzhen, China

Tel: +86-755-33320018 Fax: +86-755-33320008 www.baclcorp.com.cn

TABLE OF CONTENTS

DOCUMENT REVISION HISTORY	4
GENERAL INFORMATION.....	5
PRODUCT DESCRIPTION FOR EQUIPMENT UNDER TEST (EUT)	5
OBJECTIVE	5
MEASUREMENT UNCERTAINTY.....	6
TEST FACILITY	6
SYSTEM TEST CONFIGURATION.....	7
DESCRIPTION OF TEST CONFIGURATION	7
EQUIPMENT MODIFICATIONS	7
LOCAL SUPPORT EQUIPMENT LIST AND DETAILS	7
EXTERNAL I/O CABLE.....	7
BLOCK DIAGRAM OF TEST SETUP	7
SUMMARY OF TEST RESULTS	9
TEST EQUIPMENT LIST	10
FCC §1.1307(B) & §2.1091 –MPE-BASED EXEMPTION.....	12
APPLICABLE STANDARD	12
RESULT	13
§ 15.317, § 15.203 ANTENNA REQUIREMENT	14
APPLICABLE STANDARD	14
ANTENNA CONNECTOR CONSTRUCTION	14
FCC§15.315 & §15.207 - CONDUCTED EMISSIONS.....	15
APPLICABLE STANDARD	15
EUT SETUP.....	15
EMI TEST RECEIVER SETUP.....	15
TEST PROCEDURE	16
FACTOR & OVER LIMIT CALCULATION.....	16
TEST RESULTS SUMMARY	16
TEST DATA	16
FCC §15.205, §15.209 & §15.319 (G) - RADIATED EMISSIONS.....	19
APPLICABLE STANDARD	19
EUT SETUP	19
EMI TEST RECEIVER & SPECTRUM ANALYZER SETUP	20
TEST PROCEDURE	20
FACTOR & OVER LIMIT/MARGIN CALCULATION	21
TEST DATA	21
FCC§15.323 (A) - EMISSION BANDWIDTH.....	33
APPLICABLE STANDARD	33
TEST PROCEDURE	33
TEST DATA	33
FCC§15.319 (C) - PEAK TRANSMIT POWER.....	38
APPLICABLE STANDARD	38
TEST PROCEDURE	38
TEST DATA	39

FCC§15.319 (D) - POWER SPECTRAL DENSITY43
 APPLICABLE STANDARD43
 TEST PROCEDURE43
 TEST DATA43

FCC§15.323 (D) - EMISSION INSIDE AND OUTSIDE THE SUB-BAND.....48
 APPLICABLE STANDARD48
 TEST PROCEDURE48
 TEST DATA48

FCC§15.323 (F) - FREQUENCY STABILITY.....58
 APPLICABLE STANDARD58
 TEST PROCEDURE58
 TEST DATA58

FCC§15.323 (C) (E) & §15.319(F) – SPECIFIC REQUIREMENTS FOR UPCS DEVICE.....60
 APPLICABLE STANDARD60
 TEST PROCEDURE60
 TEST DATA60
 1) AUTOMATIC DISCONTINUATION OF TRANSMISSION, FCC §15.319(F)61
 2) MONITORING TIME, FCC §15.323(c) (1)61
 3) LOWER MONITORING THRESHOLD, FCC §15.323(c) (2)61
 4) MAXIMUM TRANSMIT PERIOD, FCC §15.323(c) (3)62
 5) SYSTEM ACKNOWLEDGEMENT, FCC §15.323(c) (4)62
 6) LEAST INTERFERED CHANNEL (LIC), FCC §15.323(c) (5)63
 7) RANDOM WAITING, FCC §15.323(c) (6)65
 8) MONITORING BANDWIDTH AND REACTION TIME, FCC §15.323(c) (7)65
 9) MONITORING ANTENNA, FCC §15.323(c) (8)66
 10) MONITORING THRESHOLD RELAXATION, FCC §15.323(c) (9)67
 11) DUPLEX CONNECTIONS, FCC §15.323(c) (10).....67
 12) ALTERNATIVE MONITORING INTERVAL, FCC §15.323(c) (11).....68
 13) FAIR ACCESS, FCC §15.323(c) (12)69
 14) FRAME REPETITION STABILITY FRAME PERIOD AND JITTER, FCC§15.323 (E)69

EUT PHOTOGRAPHS70

TEST SETUP PHOTOGRAPHS71

DOCUMENT REVISION HISTORY

Revision Number	Report Number	Description of Revision	Date of Revision
0	SZ1231226-78524E-RF-00B	Original Report	2024/04/23

GENERAL INFORMATION

Product Description for Equipment under Test (EUT)

Product	DECT 6.0 cordless telephone
Tested Model	CS6529-2
Multiple Model(s)	CS6529, CS6529-14, CS6529-15, CS6529-16, CS6529-17, CS6529-19, CS6529-25, CS6529-26, CS6529-3, CS6529-4, CS6529-4B, CS6529-5, CS652Z-XY
Frequency Range	1921.536-1928.448 MHz
Maximum conducted peak output power	19.29dBm
Modulation Technique	GFSK
Antenna Specification [#]	0dBi(It is provided by the applicant)
Voltage Range	DC 6V From adapter
Sample serial number	2FTJ-5 for Conducted and Radiated Emissions Test 2FTJ-1 for RF Conducted Test (Assigned by BACL, Shenzhen)
Sample/EUT Status	Good condition
Adapter Information	<p>Adapter 1 Model:A318-060040W-US1 Input: AC 100-120V~50/60Hz 0.15A Output: DC 6.0V.0.4A</p> <p>Adapter 2 Model:DSA-3PFM-05 BUS 060040 Input: AC 100-120V~50/60Hz 0.15A Output: DC 6.0V.0.4A 2.4W</p> <p>Adapter 3 Model:E004-1A060040VU Input: AC 100-120V~50/60Hz 0.1A Output: DC 6.0V.0.4A</p> <p>Adapter 4 Model:GQ06-060040-ZU Input: AC 100-120V~50/60Hz 0.15A Output: DC 6.0V.0.4A</p> <p>Adapter 5 Model:VT05UUS06040 Input: AC 100-120V~60Hz 150mA Output: DC 6.0V.400mA</p>
<p>Note1: The multiple models are electrically identical with the test model, except for color, model number, package type and the number of handset and charger. Please refer to the declaration letter[#] for more detail, which was provided by manufacturer.</p> <p>Note2: The EUT supply with five adapters, the worst case adapter was selected to test for AC line conducted and radiated emission below 1GHz according to DSS report test result.</p>	

Objective

The tests were performed in order to determine the compliance of the EUT with FCC Part 15-Subpart D, section 15.207, 15.315, 15.317, 15.319 and 15.323 rules. The EMI measurements were performed according to the measurement procedure described in ANSI C63.17 – 2013.

Measurement Uncertainty

Parameter		Uncertainty
Occupied Channel Bandwidth		±5%
RF Frequency		213.55hZ(k=2, 95% level of confidence)
RF output power, conducted		0.72dB(k=2, 95% level of confidence)
Unwanted Emission, conducted		1.75dB(k=2, 95% level of confidence)
AC Power Lines Conducted Emissions	9kHz-150kHz	3.94dB(k=2, 95% level of confidence)
	150kHz-30MHz	3.84dB(k=2, 95% level of confidence)
Radiated Emissions	9kHz - 30MHz	3.30dB(k=2, 95% level of confidence)
	30MHz~200MHz (Horizontal)	4.48dB(k=2, 95% level of confidence)
	30MHz~200MHz (Vertical)	4.55dB(k=2, 95% level of confidence)
	200MHz~1000MHz (Horizontal)	4.85dB(k=2, 95% level of confidence)
	200MHz~1000MHz (Vertical)	5.05dB(k=2, 95% level of confidence)
	1GHz - 6GHz	5.35dB(k=2, 95% level of confidence)
	6GHz - 18GHz	5.44dB(k=2, 95% level of confidence)
	18GHz - 40GHz	5.16dB(k=2, 95% level of confidence)
Temperature		±1°C
Humidity		±1%
Supply voltages		±0.4%

Note: The extended uncertainty given in this report is obtained by combining the standard uncertainty times the coverage factor K with the 95% confidence interval. Otherwise required by the applicant or Product Regulations, Decision Rule in this report did not consider the uncertainty.

Test Facility

The Test site used by Bay Area Compliance Laboratories Corp. (Shenzhen) to collect test data is located on the 5F(B-West) , 6F, 7F, the 3rd Phase of Wan Li Industrial Building D, Shihua Rd, FuTian Free Trade Zone, Shenzhen, China.

The lab has been recognized as the FCC accredited lab under the KDB 974614 D01 and is listed in the FCC Public Access Link (PAL) database, FCC Registration No. : 715558, the FCC Designation No. : CN5045.

SYSTEM TEST CONFIGURATION

Description of Test Configuration

The system was configured to testing mode which is provided by the manufacturer.

Equipment Modifications

No modification was made to the EUT tested.

Local Support Equipment List and Details

Manufacturer	Description	Model	Serial Number
Rohde & Schwarz	Digital Radio Communication Tester	CMD60	830553/018

External I/O Cable

Cable Description	Length (m)	From Port	To
Unshielded un-detachable AC cable	1.2	LISN/ AC mains	Receptacle
Unshielded un-detachable AC cable	1.2	AC Power Source	CMD60
Unshielded un-detachable DC cable	2.0	Adapter	EUT(Base)

Block Diagram of Test Setup

For conducted emission

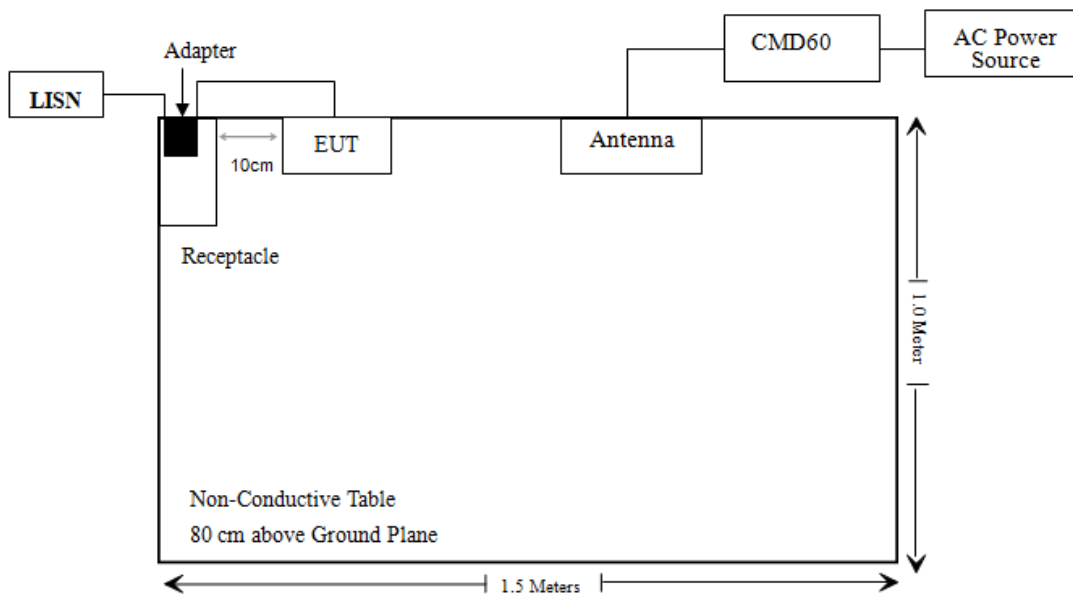

For Radiated Emissions:

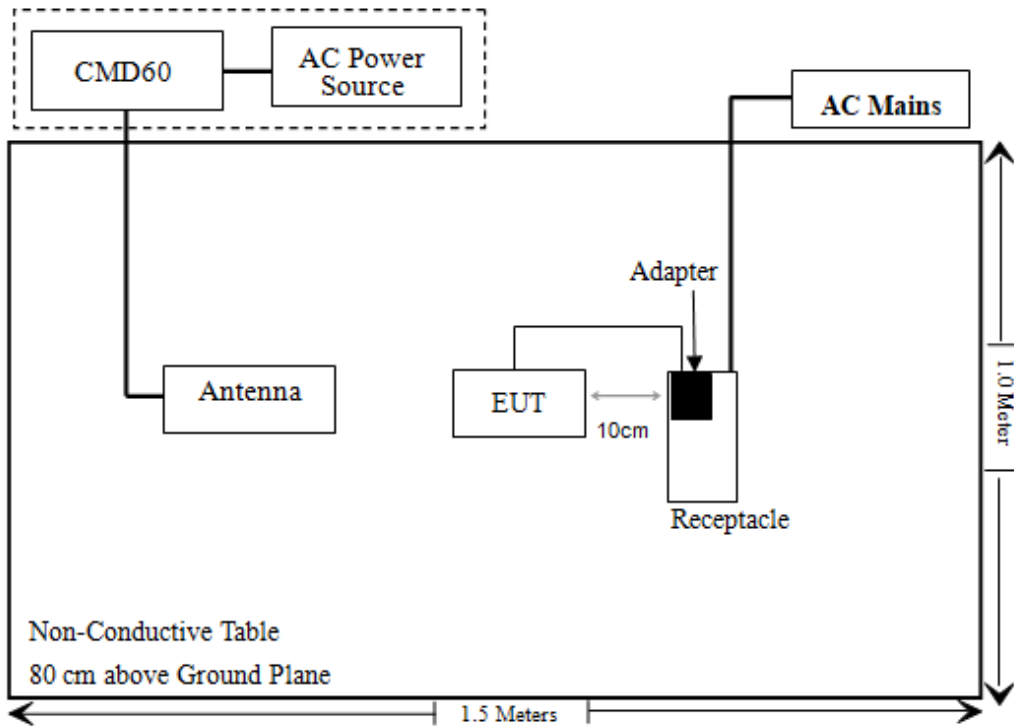

SUMMARY OF TEST RESULTS

FCC Rules	Description of Test	Result
§1.1307 (b) & §2.1091	MPE-Based Exemption	Compliant
§ 15.317, § 15.203	Antenna Requirement	Compliant
§ 15.315, § 15.207	Conducted Emission	Compliant
§ 15.323 (a)	Emission Bandwidth	Compliant
§ 15.319 (c)	Peak Transmit Power	Compliant
§ 15.319 (d)	Power Spectral Density	Compliant
§ 15.323 (d)	Emission Inside and Outside the sub-band	Compliant
§ 15.323 (f)	Frequency Stability	Compliant
§15.205; §15.209; §15.319 (g)	Radiated Emissions	Compliant
§ 15.323 (c)(e) § 15.319 (f)	Specific Requirements for UPCS	Compliant

Note: EUT have two antennas, pre-scan output power of the two antennas, the maximum output power ANT1 was select to test.

TEST EQUIPMENT LIST

Manufacturer	Description	Model	Serial Number	Calibration Date	Calibration Due Date
Conducted Emissions Test					
Rohde & Schwarz	EMI Test Receiver	ESCI	101120	2024/01/16	2025/01/15
Rohde & Schwarz	LISN	ENV216	101613	2024/01/16	2025/01/15
Rohde & Schwarz	Transient Limiter	ESH3Z2	DE25985	2023/08/03	2024/08/02
Unknown	CE Cable	CE Cable	UF A210B-1-0720-504504	2023/08/03	2024/08/02
Audix	EMI Test software	E3	191218	NCR	NCR
Radiated Emission Test					
R&S	EMI Test Receiver	ESR3	102455	2024/01/16	2025/01/15
Sonoma instrument	Pre-amplifier	310 N	186238	2023/06/08	2024/06/07
Sunol Sciences	Broadband Antenna	JB1	A040904-1	2023/07/20	2024/07/19
ETS	Passive Loop Antenna	6512	29604	2023/07/07	2024/07/06
Unknown	Cable	Chamber Cable 1	F-03-EM236	2023/08/03	2024/08/02
Unknown	Cable	Chamber Cable 4	EC-007	2023/08/03	2024/08/02
Audix	EMI Test software	E3	19821b(V9)	NCR	NCR
Rohde & Schwarz	Spectrum Analyzer	FSV40	101605	2023/04/18	2024/04/17
COM-POWER	Pre-amplifier	PA-122	181919	2023/06/29	2024/06/28
Schwarzbeck	Horn Antenna	BBHA9120D(1201)	1143	2023/07/26	2024/07/25
Unknown	RF Cable	KMSE	0735	2023/10/08	2024/10/07
Unknown	RF Cable	UFA147	219661	2023/10/08	2024/10/07
Unknown	RF Cable	XH750A-N	J-10M	2023/10/08	2024/10/07
SNSD	2.4G Band Reject filter	BSF2402-2480MN-0898-001	2.4G filter	2023/08/03	2024/08/02
Audix	EMI Test software	E3	191218(V9)	NCR	NCR
A.H.System	Pre-amplifier	PAM-1840VH	190	2023/08/03	2024/08/02
Electro-Mechanics Co	Horn Antenna	3116	9510-2270	2023/09/18	2026/09/17
UTIFLEX	RF Cable	NO. 13	232308-001	2023/08/03	2024/08/02

Manufacturer	Description	Model	Serial Number	Calibration Date	Calibration Due Date
RF Conducted Test					
R&S	spectrum analyzer	FSV40	101942	2023/12/18	2024/12/17
R&S	SPECTRUM ANALYZER	FSU26	200120	2024/01/08	2025/01/07
BACL	Temperature & Humidity Chamber	BTH-150-40	30145	2024/01/16	2025/01/15
Rohde & Schwarz	Digital Radio Communication Tester	CMD60	830553/018	2023/06/08	2024/06/07
Keysight	MXG Vector Signal Generator	N5182B	MY53051503	2024/01/08	2025/01/07
HELLVIAO	Contact voltage regulator	TDGC2-5KVA	Unknown	NCR	NCR
Fluke	Digital Multimeter	287	19000011	2023/06/08	2024/06/07
WEINSCHL	3dB Attenuator	Unknown	F-03-EM220	2023/07/04	2024/07/03
WEINSCHL	Power Splitter	1515	RH386	2023/07/04	2024/07/03
Unknown	RF Cable	65475	01670515	2023/07/04	2024/07/03

* **Statement of Traceability:** Bay Area Compliance Laboratories Corp. (Shenzhen) attests that all calibrations have been performed in accordance to requirements that traceable to National Primary Standards and International System of Units (SI).

FCC §1.1307(b) & §2.1091 –MPE-BASED EXEMPTION

Applicable Standard

According to KDB 447498 D04 Interim General RF Exposure Guidance v01, clause 2.1.4 –MPE-Based Exemption:

An alternative to the SAR-based exemption is provided in § 1.1307(b)(3)(i)(C), for a much wider frequency range, from 300 kHz to 100 GHz, applicable for separation distances greater or equal to $\lambda/2\pi$, where λ is the free-space operating wavelength in meters. The MPE-based test exemption condition is in terms of ERP, defined as the product of the maximum antenna gain and the delivered maximum time-averaged power. For this case, a RF source is an RF exempt device if its ERP (watts) is no more than a frequency-dependent value, as detailed tabular form in Appendix B. These limits have been derived based on the basic specifications on Maximum Permissible Exposure (MPE) considered for the FCC rules in § 1.1310(e)(1).

Table to § 1.1307(b)(3)(i)(C) - Single RF Sources Subject to Routine Environmental Evaluation

RF Source frequency (MHz)	Threshold ERP (watts)
0.3-1.34	$1,920 R^2$.
1.34-30	$3,450 R^2/f^2$.
30-300	$3.83 R^2$.
300-1,500	$0.0128 R^2f$.
1,500-100,000	$19.2R^2$.

f = frequency in MHz;

R = minimum separation distance from the body of a nearby person (appropriate units, e.g., m);

For multiple RF sources: Multiple RF sources are exempt if:

in the case of fixed RF sources operating in the same time-averaging period, or of multiple mobile or portable RF sources within a device operating in the same time averaging period, if the sum of the fractional contributions to the applicable thresholds is less than or equal to 1 as indicated in the following equation:

$$\sum_{i=1}^a \frac{P_i}{P_{th,i}} + \sum_{j=1}^b \frac{ERP_j}{ERP_{th,j}} + \sum_{k=1}^c \frac{Evaluated_k}{Exposure Limit_k} \leq 1$$

Result

Mode	Frequency (MHz)	Tune up conducted power [#]	Antenna Gain [#]		ERP		Evaluation Distance (m)	MPE-Based Exemption Threshold (mW)
		(dBm)	(dBi)	(dBd)	(dBm)	(mW)		
BT	2402-2480	4.5	0	-2.15	2.35	1.72	0.2	768
DECT	1921.536-1928.448	20.0	0	-2.15	17.85	60.95	0.2	768

Note 1: The tune-up power and antenna gain was declared by the applicant.

Note 2: 0dBd=2.15dBi.

Note 3: The DECT function can transmit at the same time with the Bluetooth function.

Simultaneous transmitting consideration (worst case):

The ratio= $ERP_{DECT}/limit + ERP_{BT}/limit = 60.95/768 + 1.72/768 = 0.082 < 1.0$

To maintain compliance with the FCC’s RF exposure guidelines, place the equipment at least 20cm from nearby persons.

Result: Compliant

§ 15.317, § 15.203 ANTENNA REQUIREMENT

Applicable Standard

According to FCC § 15.203, an intentional radiator shall be designed to ensure that no antenna other than that furnished by the responsible party shall be used with the device. The use of a permanently attached antenna or of an antenna that uses a unique coupling to the intentional radiator shall be considered sufficient to comply with the provisions of this Section. The manufacturer may design the unit so that a broken antenna can be replaced by the user, but the use of a standard antenna jack or electrical connector is prohibited.

Antenna Connector Construction

The EUT has two antennas which were permanently attached and the maximum antenna gain[#] is 0dBi, fulfill the requirement of this section. Please refer to the EUT photos.

Result: Compliant

FCC§15.315 & §15.207 - CONDUCTED EMISSIONS

Applicable Standard

FCC§15.315, an unlicensed PCS device that is designed to be connected to the public utility (AC) power line must meet the limits specified in §15.207.

EUT Setup

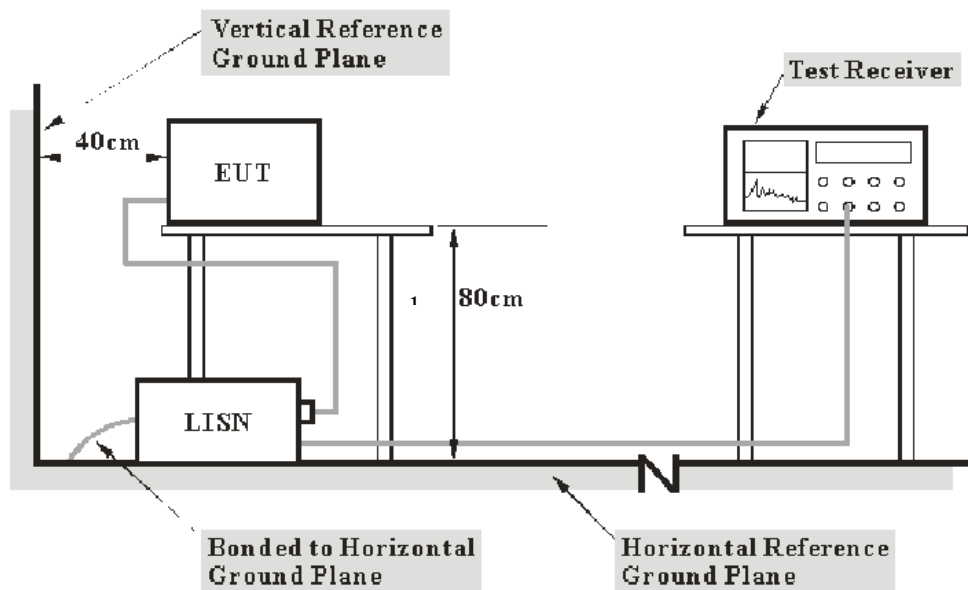

- Note: 1. Support units were connected to second LISN.
 2. Both of LISNs (AMN) 80 cm from EUT and at the least 80 cm from other units and other metal planes support units.

The setup of EUT is according with per ANSI C63.4-2014 measurement procedure. The specification used was with the FCC 15.315 and FCC 15.207 limits.

The external I/O cables were draped along the test table and formed a bundle 30 to 40 cm long in the middle.

The spacing between the peripherals was 10 cm.

The adapter was connected to a 120 VAC/60 Hz power source.

EMI Test Receiver Setup

The EMI test receiver was set to investigate the spectrum from 150 kHz to 30 MHz.

During the conducted emission test, the EMI test receiver was set with the following configurations:

Frequency Range	IF B/W
150 kHz – 30 MHz	9 kHz

Test Procedure

During the conducted emission test, adapter was connected to the outlet of the LISN.

Maximizing procedure was performed on the six (6) highest emissions of the EUT.

All final data was recorded in the Quasi-peak and average detection mode.

Factor & Over Limit Calculation

The factor is calculated by adding LISN VDF (Voltage Division Factor) and Cable Loss. The basic equation is as follows:

$$\text{Factor} = \text{LISN VDF} + \text{Cable Loss}$$

The “**Over limit**” column of the following data tables indicates the degree of compliance with the applicable limit. For example, an Over limit of -7 dB means the emission is 7 dB below the limit. The equation for calculation is as follows:

$$\begin{aligned} \text{Over Limit} &= \text{Level} - \text{Limit} \\ \text{Level} &= \text{Read Level} + \text{Factor} \end{aligned}$$

Note: The term "cable loss" refers to the combination of a cable and a 10dB transient limiter (attenuator).

Test Results Summary

According to the recorded data in following table, the EUT complied with the FCC Part 15.207.

Test Data

Environmental Conditions

Temperature:	26 °C
Relative Humidity:	58 %
ATM Pressure:	101.0 kPa

The testing was performed by Macy Shi on 2024-04-23.

Test mode: Transmitting (Maximum output power mode, ANTI Middle Channel)

The worst case adapter: A318-060040W-US1

AC 120V/60 Hz, Line

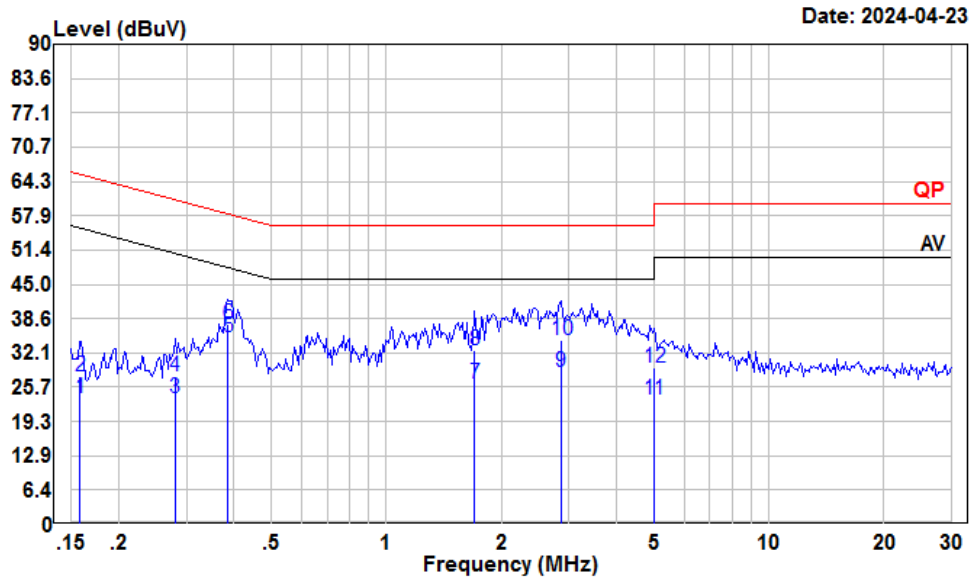

Date: 2024-04-23

Condition: Line
 Project : SZ1231226-78524E-RF
 Tester : Macy shi
 Note : GFSK

	Read Freq	Read Level	LISN Level	LISN Factor	Cable Loss	Limit Line	Over Limit	Remark
	MHz	dBuV	dBuV	dB	dB	dBuV	dB	
1	0.16	2.53	23.56	10.88	10.15	55.56	-32.00	Average
2	0.16	6.80	27.83	10.88	10.15	65.56	-37.73	QP
3	0.28	2.83	23.68	10.69	10.16	50.81	-27.13	Average
4	0.28	6.86	27.71	10.69	10.16	60.81	-33.10	QP
5	0.39	14.37	35.16	10.59	10.20	48.17	-13.01	Average
6	0.39	16.69	37.48	10.59	10.20	58.17	-20.69	QP
7	1.70	5.71	26.37	10.55	10.11	46.00	-19.63	Average
8	1.70	11.90	32.56	10.55	10.11	56.00	-23.44	QP
9	2.85	7.80	28.50	10.45	10.25	46.00	-17.50	Average
10	2.85	13.72	34.42	10.45	10.25	56.00	-21.58	QP
11	5.00	2.66	23.26	10.38	10.22	50.00	-26.74	Average
12	5.00	8.79	29.39	10.38	10.22	60.00	-30.61	QP

AC 120V/60 Hz, Neutral

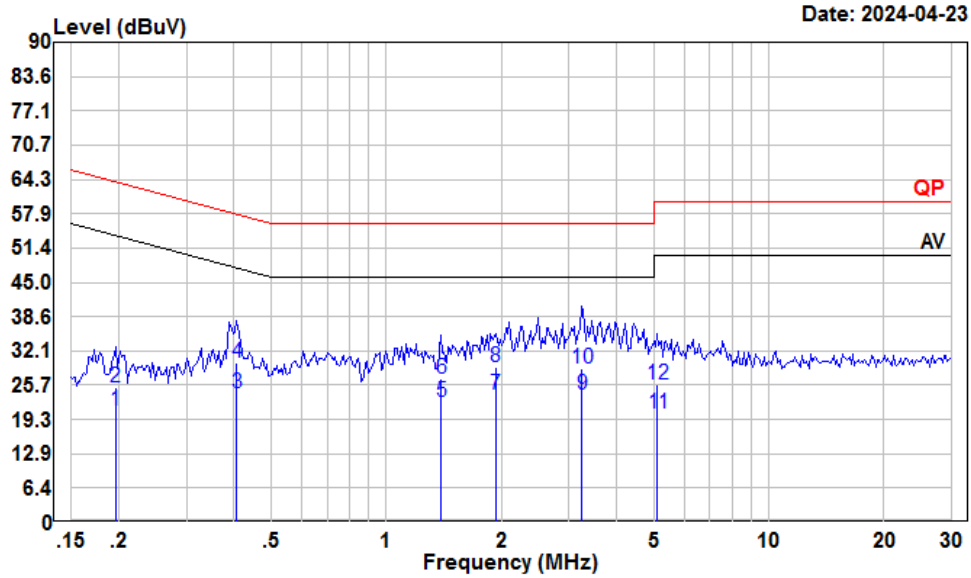

Condition: Neutral
 Project : SZ1231226-78524E-RF
 Tester : Macy shi
 Note : GFSK

	Read	LISN	Cable	Limit	Over			
Freq	Level	Level	Factor	Loss	Line	Limit		
MHz	dBuV	dBuV	dB	dB	dBuV	dB		
1	0.20	0.45	20.97	10.42	10.10	53.80	-32.83	Average
2	0.20	4.67	25.19	10.42	10.10	63.80	-38.61	QP
3	0.41	3.40	24.25	10.63	10.22	47.73	-23.48	Average
4	0.41	8.96	29.81	10.63	10.22	57.73	-27.92	QP
5	1.39	1.80	22.52	10.66	10.06	46.00	-23.48	Average
6	1.39	6.20	26.92	10.66	10.06	56.00	-29.08	QP
7	1.93	3.25	23.85	10.43	10.17	46.00	-22.15	Average
8	1.93	8.45	29.05	10.43	10.17	56.00	-26.95	QP
9	3.24	3.19	23.86	10.40	10.27	46.00	-22.14	Average
10	3.24	8.25	28.92	10.40	10.27	56.00	-27.08	QP
11	5.11	-0.37	20.38	10.53	10.22	50.00	-29.62	Average
12	5.11	5.00	25.75	10.53	10.22	60.00	-34.25	QP

FCC §15.205, §15.209 & §15.319 (g) - RADIATED EMISSIONS

Applicable Standard

FCC §15.205; §15.209; §15.319 (g)

EUT Setup

9 kHz-30MHz:

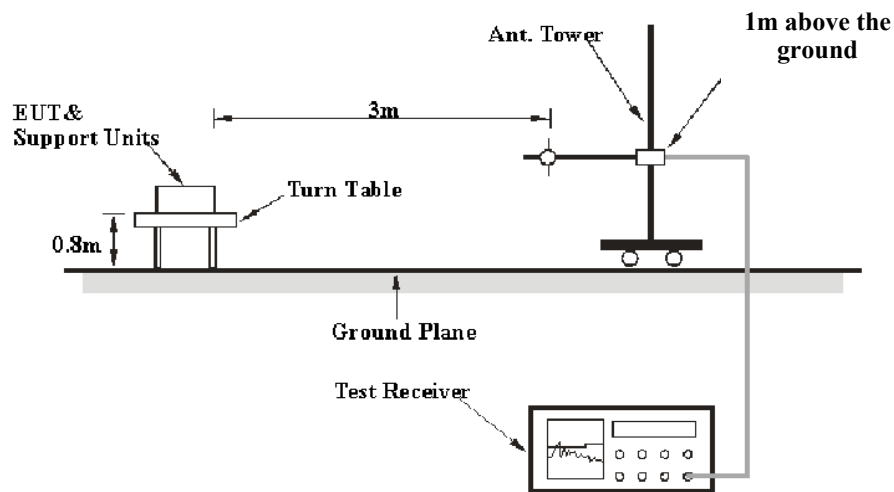

30MHz-1GHz:

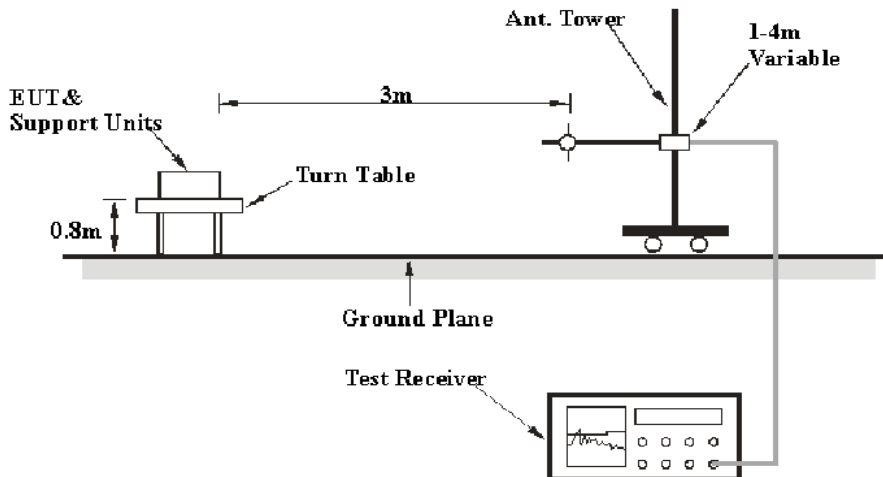

Above 1GHz:

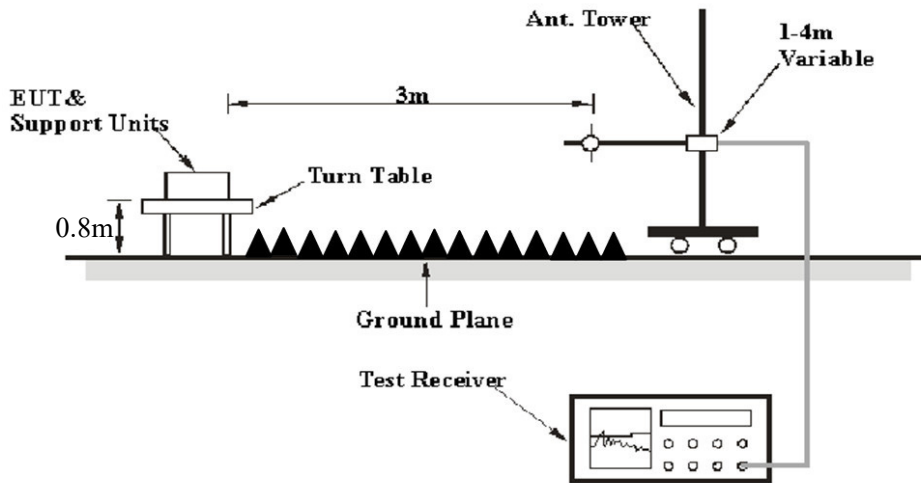

The radiated emission tests were performed in the 3 meters, using the setup accordance with the ANSI C63.10-2013. The specification used was the FCC 15.209 and FCC 15.319 (g) limits.

EMI Test Receiver & Spectrum Analyzer Setup

The EMI test receiver & Spectrum Analyzer Setup were set with the following configurations:

Frequency Range	RBW	Video B/W	IF B/W	Measurement
9 kHz – 150 kHz	/	/	200 Hz	QP
	300 Hz	1 kHz	/	PK
150 kHz – 30 MHz	/	/	9 kHz	QP
	10 kHz	30 kHz	/	PK
30 MHz – 1000 MHz	/	/	120 kHz	QP
	100 kHz	300 kHz	/	PK
Above 1 GHz	Fundamental & Harmonics			
	1MHz	3 MHz	/	PK
	Average level= Peak level+ 20lg (Duty cycle)			
	Non-Harmonics			
	1MHz	3 MHz	/	PK
	1MHz	10 Hz	/	Average

Test Procedure

Maximizing procedure was performed on the highest emissions to ensure that the EUT complied with all installation combinations.

All final data was recorded in Quasi-peak detection mode except for the frequency bands 9–90 kHz, 110–490 kHz and above 1000 MHz, average detection modes for frequency bands 9–90 kHz and 110–490 kHz, peak and average detection modes for frequencies above 1 GHz.

For 9 kHz-30MHz, the report shall list the six emissions with the smallest margin relative to the limit, for each of the three antenna orientations (parallel, perpendicular, and ground-parallel) unless the margin is greater than 20 dB.

If the maximized peak measured value complies with under the QP/Average limit more than 6dB, then it is unnecessary to perform an QP/Average measurement.

All emissions under the average limit and under the noise floor have not recorded in the report.

Factor & Over Limit/Margin Calculation

The Factor is calculated by adding the Antenna Factor and Cable Loss, and subtracting the Amplifier Gain. The basic equation is as follows:

$$\text{Factor} = \text{Antenna Factor} + \text{Cable Loss} - \text{Amplifier Gain}$$

The “**Over Limit/Margin**” column of the following data tables indicates the degree of compliance with the applicable limit. For example, an Over Limit/margin of -7dB means the emission is 7dB below the limit. The equation for calculation is as follows:

$$\begin{aligned} \text{Over Limit/Margin} &= \text{Level/Corrected Amplitude} - \text{Limit} \\ \text{Level / Corrected Amplitude} &= \text{Read Level} + \text{Factor} \end{aligned}$$

Test Data

Environmental Conditions

Temperature:	22~24.7 °C
Relative Humidity:	44~55 %
ATM Pressure:	101.0 kPa

The testing was performed by Warren Huang on 2024-01-25 for below 1GHz and Dylan Yang on 2024-02-05 and Hanic Pan on 2024-02-23 for above 1GHz.

Test mode: Transmitting

9K~30 MHz:

The amplitude of spurious emissions attenuated more than 20 dB below the limit was not recorded.

30MHz-1GHz: (Maximum output mode ANTI Middle channel)

Horizontal

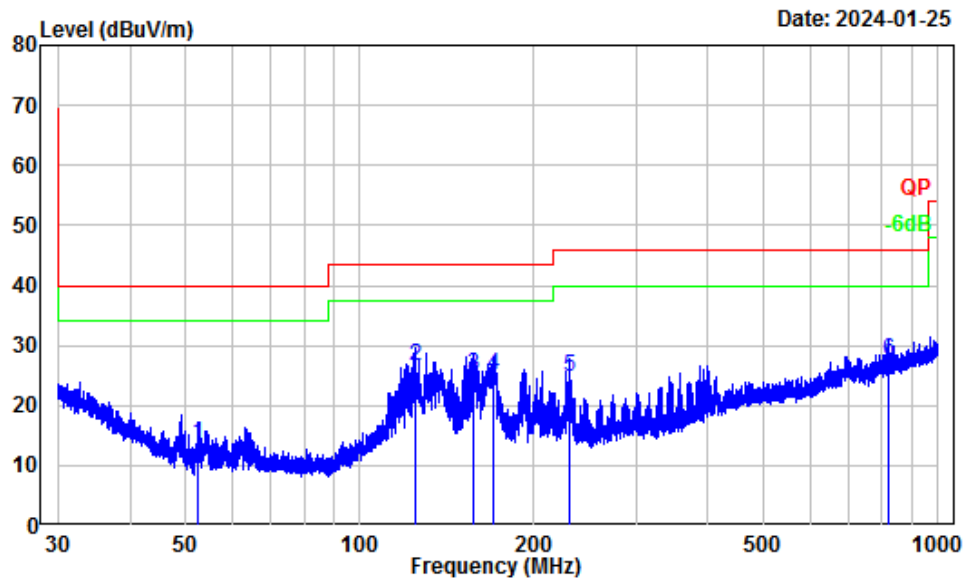

Site : chamber
 Condition : 3m Horizontal
 Project Number: SZ1231226-78524E-RF
 Note : GFSK
 Tester : Warren Huang

	Freq	Factor	Read Level	Limit Level	Over Line	Over Limit	Remark
	MHz	dB/m	dBuV	dBuV/m	dBuV/m	dB	
1	52.37	-16.63	30.26	13.63	40.00	-26.37	QP
2	124.46	-10.32	36.88	26.56	43.50	-16.94	QP
3	157.21	-11.73	36.80	25.07	43.50	-18.43	QP
4	170.27	-12.08	37.20	25.12	43.50	-18.38	QP
5	230.20	-11.52	36.37	24.85	46.00	-21.15	QP
6	820.27	-0.25	27.84	27.59	46.00	-18.41	QP

Vertical

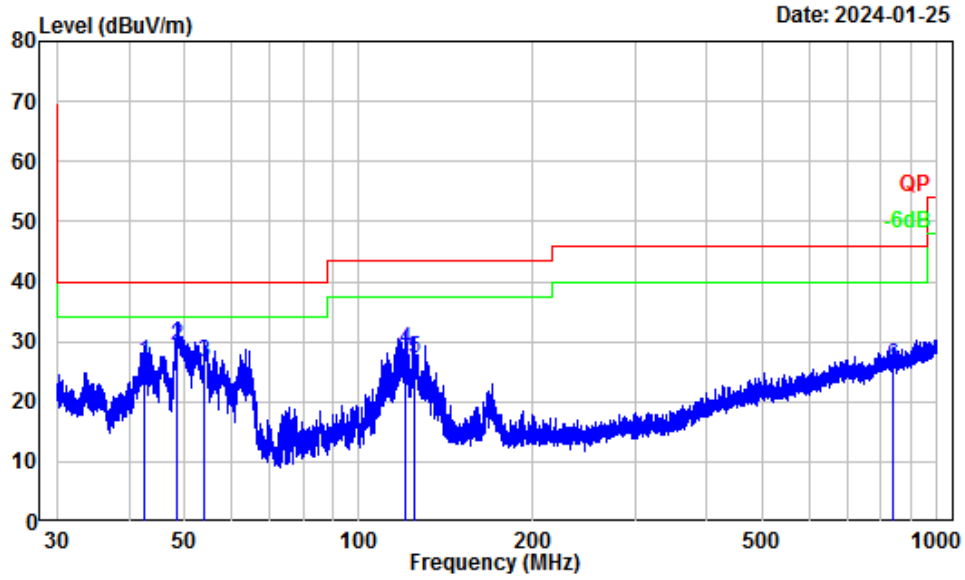

Site : chamber
 Condition : 3m Vertical
 Project Number: SZ1231226-78524E-RF
 Note : GFSK
 Tester : Warren Huang

	Freq	Factor	Read Level	Limit Level	Over Limit	Remark
	MHz	dB/m	dBuV	dBuV/m	dBuV/m	dB
1	42.62	-13.38	40.00	26.62	40.00	-13.38 QP
2	48.52	-16.66	45.93	29.27	40.00	-10.73 QP
3	54.02	-17.52	43.98	26.46	40.00	-13.54 QP
4	120.70	-10.76	39.30	28.54	43.50	-14.96 QP
5	124.73	-10.77	37.81	27.04	43.50	-16.46 QP
6	836.61	-0.26	26.08	25.82	46.00	-20.18 QP

Above 1GHz:

Frequency (MHz)	Receiver		Polar (H/V)	Factor (dB/m)	Corrected Amplitude (dBµV/m)	Limit (dBµV/m)	Margin (dB)
	Reading (dBµV)	PK/Ave					
ANT 0							
Low Channel							
1921.53	115.59	PK	H	-6.39	109.20	/	/
1921.53	113.67	PK	V	-6.39	107.28	/	/
3843.06	59.98	PK	H	-1.14	58.84	74	-15.16
3843.06	60.16	PK	V	-1.14	59.02	74	-14.98
Middle Channel							
1924.99	114.98	PK	H	-6.39	108.59	/	/
1924.99	113.77	PK	V	-6.39	107.38	/	/
3849.98	60.12	PK	H	-1.14	58.98	74	-15.02
3849.98	60.39	PK	V	-1.14	59.25	74	-14.75
High Channel							
1928.45	114.12	PK	H	-6.39	107.73	/	/
1928.45	113.74	PK	V	-6.39	107.35	/	/
3856.90	61.39	PK	H	-0.74	60.65	74	-13.35
3856.90	60.61	PK	V	-0.74	59.87	74	-14.13
ANT 1							
Low Channel							
1921.53	117.99	PK	H	-6.39	111.60	/	/
1921.53	116.84	PK	V	-6.39	110.45	/	/
3843.06	59.51	PK	H	-1.14	58.37	74	-15.63
3843.06	60.22	PK	V	-1.14	59.08	74	-14.92
Middle Channel							
1924.99	117.83	PK	H	-6.39	111.44	/	/
1924.99	116.45	PK	V	-6.39	110.06	/	/
3849.98	59.66	PK	H	-1.14	58.52	74	-15.48
3849.98	60.64	PK	V	-1.14	59.50	74	-14.50
High Channel							
1928.45	117.69	PK	H	-6.39	111.30	/	/
1928.45	116.10	PK	V	-6.39	109.71	/	/
3856.90	60.32	PK	H	-0.74	59.58	74	-14.42
3856.90	60.05	PK	V	-0.74	59.31	74	-14.69

Note:
 Factor = Antenna factor (RX) + Cable Loss – Amplifier Factor
 Corrected Amplitude = Factor + Reading
 Margin = Corrected. Amplitude - Limit

Field Strength of Average							
Frequency (MHz)	Peak Measurement @3m (dBµV/m)	Polar (H/V)	Duty Cycle Correction Factor (dB)	Average Level (dBµV/m)	FCC Part 15D		
					Limit (dBµV/m)	Margin (dB)	Comment
ANT 0							
1921.536MHz							
1921.53	109.20	H	-27.96	81.24	/	/	Fundamental
1921.53	107.28	V	-27.96	79.32	/	/	Fundamental
3843.06	58.84	H	-27.96	30.88	54	-23.12	Harmonic
3843.06	59.02	V	-27.96	31.06	54	-22.94	Harmonic
1924.992MHz							
1924.99	108.59	H	-27.96	80.63	/	/	Fundamental
1924.99	107.38	V	-27.96	79.42	/	/	Fundamental
3849.98	58.98	H	-27.96	31.02	54	-22.98	Harmonic
3849.98	59.25	V	-27.96	31.29	54	-22.71	Harmonic
1928.448MHz							
1928.45	107.73	H	-27.96	79.77	/	/	Fundamental
1928.45	107.35	V	-27.96	79.39	/	/	Fundamental
3856.9	60.65	H	-27.96	32.69	54	-21.31	Harmonic
3856.9	59.87	V	-27.96	31.91	54	-22.09	Harmonic
ANT 1							
1921.536MHz							
1921.53	111.60	H	-27.96	83.64	/	/	Fundamental
1921.53	110.45	V	-27.96	82.49	/	/	Fundamental
3843.06	58.37	H	-27.96	30.41	54	-23.59	Harmonic
3843.06	59.08	V	-27.96	31.12	54	-22.88	Harmonic
1924.992MHz							
1924.99	111.44	H	-27.96	83.48	/	/	Fundamental
1924.99	110.06	V	-27.96	82.10	/	/	Fundamental
3849.98	58.52	H	-27.96	30.56	54	-23.44	Harmonic
3849.98	59.50	V	-27.96	31.54	54	-22.46	Harmonic
1928.448MHz							
1928.45	111.30	H	-27.96	83.34	/	/	Fundamental
1928.45	109.71	V	-27.96	81.75	/	/	Fundamental
3856.9	59.58	H	-27.96	31.62	54	-22.38	Harmonic
3856.9	59.31	V	-27.96	31.35	54	-22.65	Harmonic

Note: Average level= Peak level+ Duty Cycle Factor

Duty cycle:

Ton1 =0.4ms

Tp = 10.04ms

Duty cycle = Ton/Tp = 0.4/10.04=0.040

Duty Cycle Corrected Factor = 20lg (Duty cycle) = 20lg0.040= -27.96

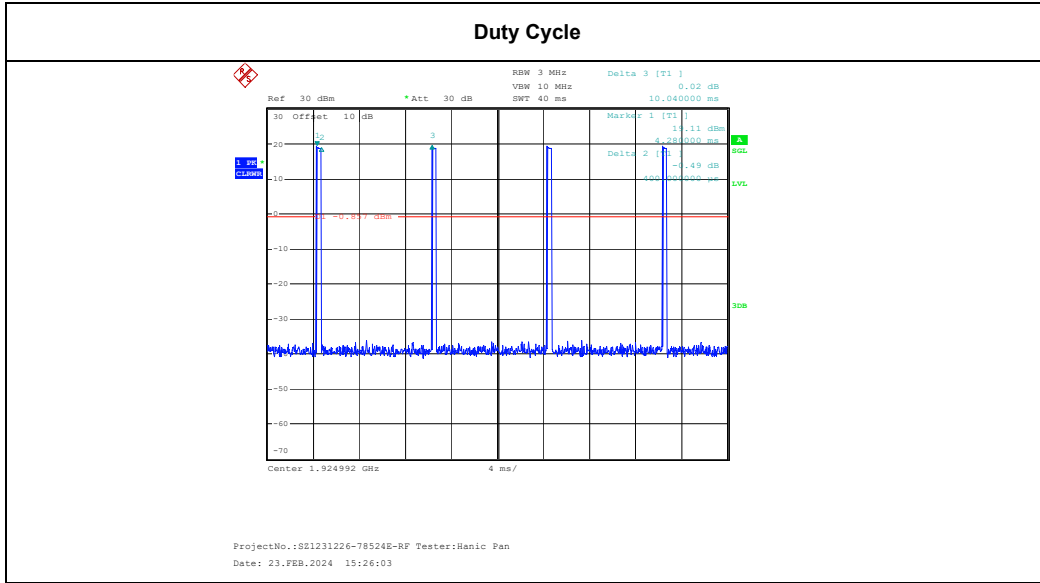

Listed with the worst harmonic margin test plot: (ANT 0 High channel)

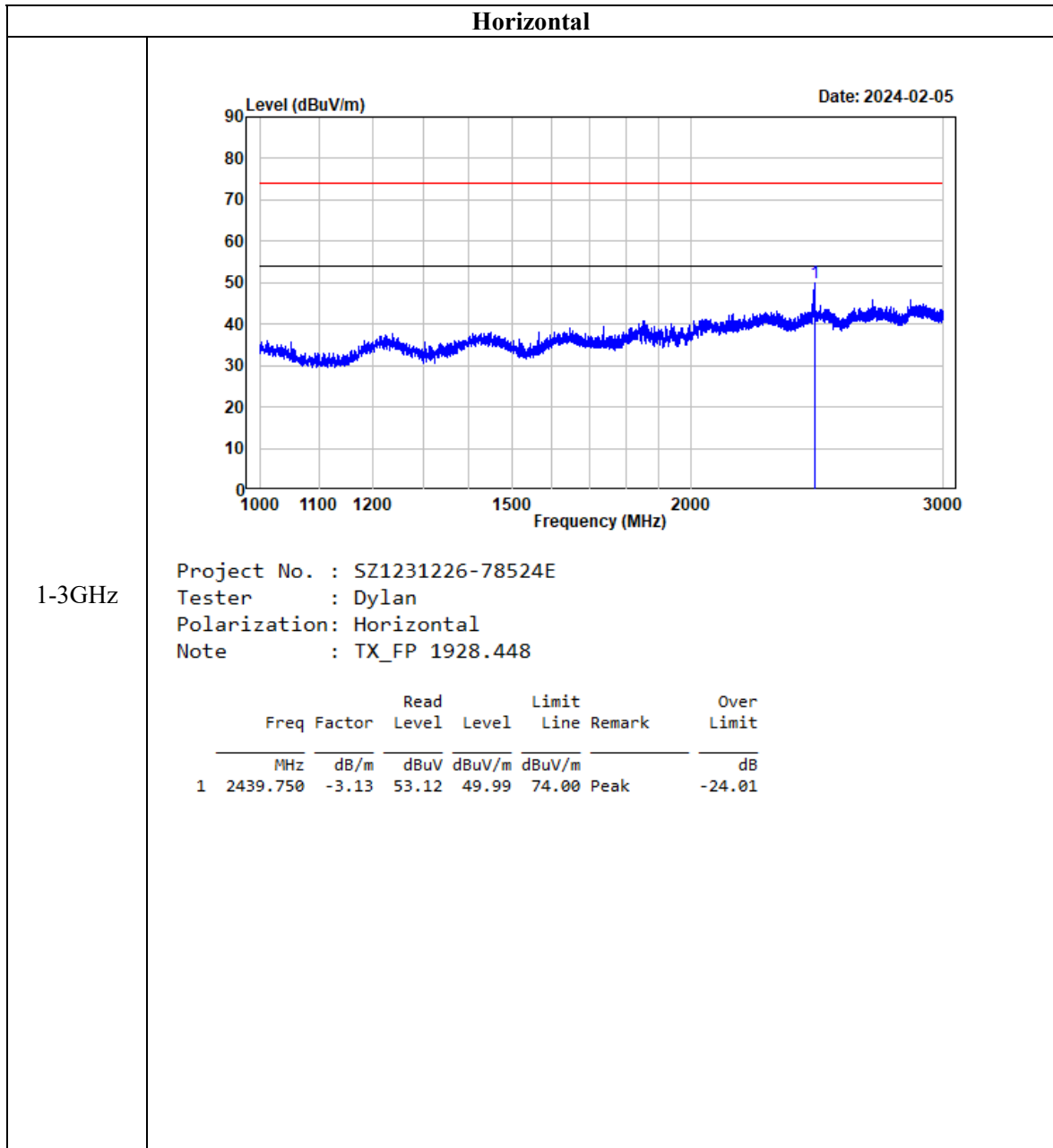

Vertical

1-3GHz

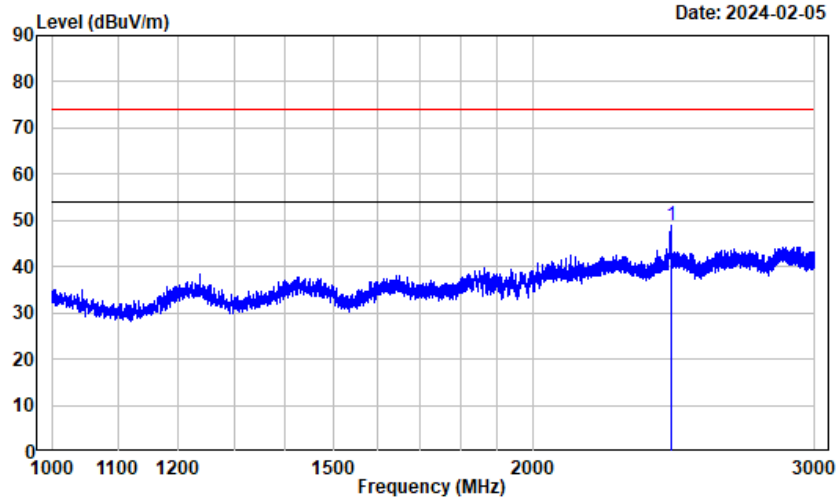

Project No. : SZ1231226-78524E
 Tester : Dylan
 Polarization: Vertical
 Note : TX_FP 1928.448

	Freq	Factor	Read		Limit	Remark	Over
			Level	Level	Line		Limit
	MHz	dB/m	dBuV	dBuV/m	dBuV/m		dB
1	2438.250	-3.13	51.87	48.74	74.00	Peak	-25.26

Horizontal

3-18GHz

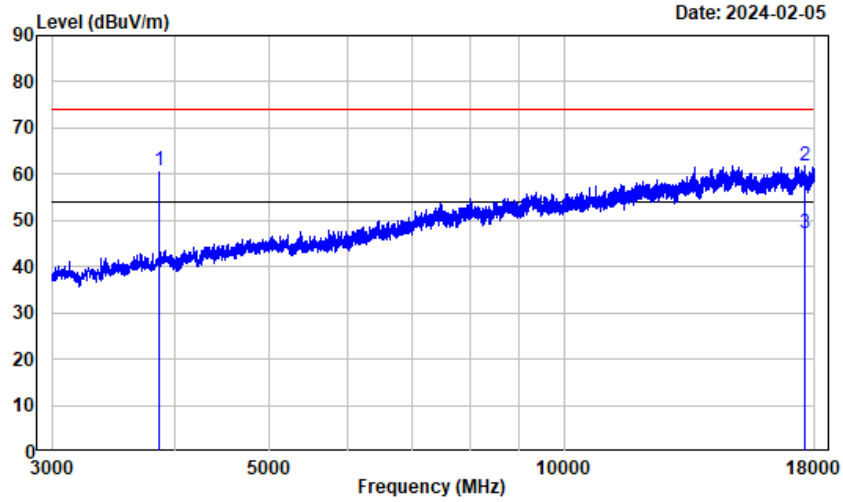

Project No. : SZ1231226-78524E
 Tester : Dylan
 Polarization: Horizontal
 Note : TX_FP 1928.448

	Freq	Factor	Read Level	Level	Limit Line	Over Limit	Remark
	MHz	dB/m	dBuV	dBuV/m	dBuV/m	dB	
1	3856.900	-0.74	61.39	60.65	74.00	-13.35	Peak
2	17578.130	20.53	41.21	61.74	74.00	-12.26	Peak
3	17578.130	20.53	26.82	47.35	54.00	-6.65	Average

Vertical

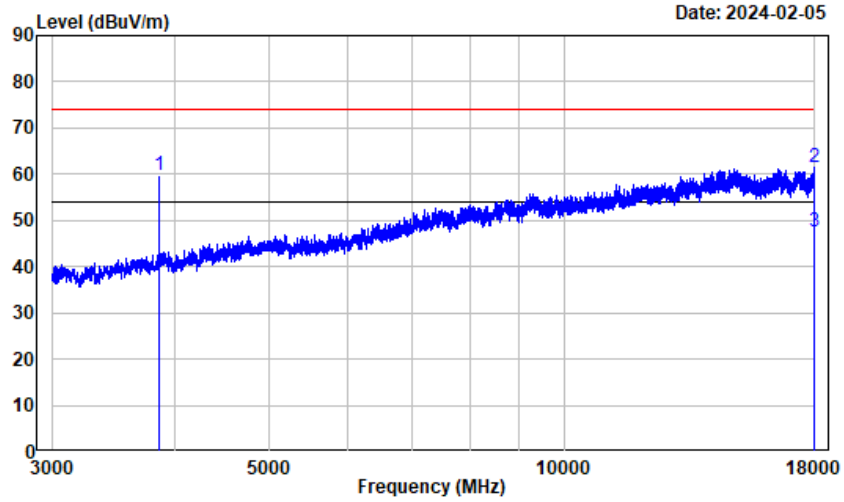

3-18GHz

Project No. : SZ1231226-78524E
 Tester : Dylan
 Polarization: Vertical
 Note : TX_FP 1928.448

	Freq	Factor	Read Level	Level	Limit Line	Over Limit	Remark
	MHz	dB/m	dBuV	dBuV/m	dBuV/m	dB	
1	3856.900	-0.74	60.61	59.87	74.00	-14.13	Peak
2	17986.880	24.53	37.02	61.55	74.00	-12.45	Peak
3	17986.880	24.53	22.89	47.42	54.00	-6.58	Average

Horizontal

18-20GHz

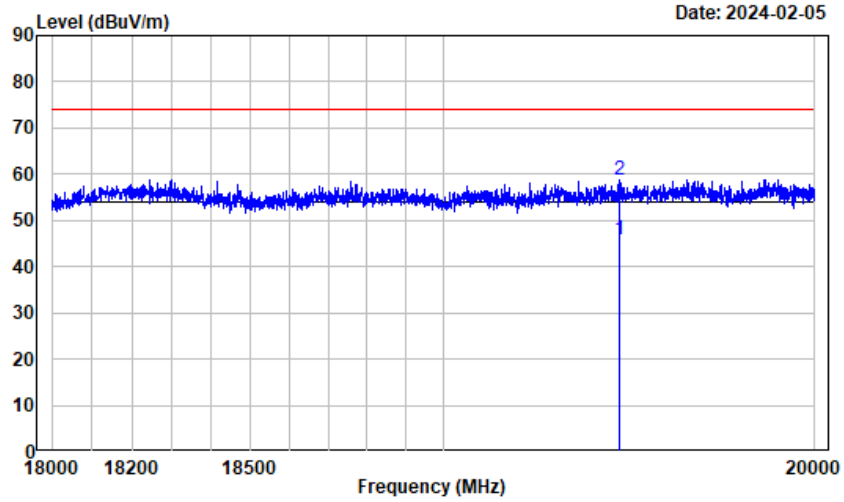

Project No. : SZ1231226-78524E
 Tester : Dylan
 Polarization: Horizontal
 Note : FP_1928.448

	Freq	Factor	Read		Limit	Remark	Over
			Level	Level			
	MHz	dB/m	dBuV	dBuV/m	dBuV/m		dB
1	19466.500	13.86	32.13	45.99	54.00	Average	-8.01
2	19466.500	13.86	45.04	58.90	74.00	Peak	-15.10

Vertical

18-20GHz

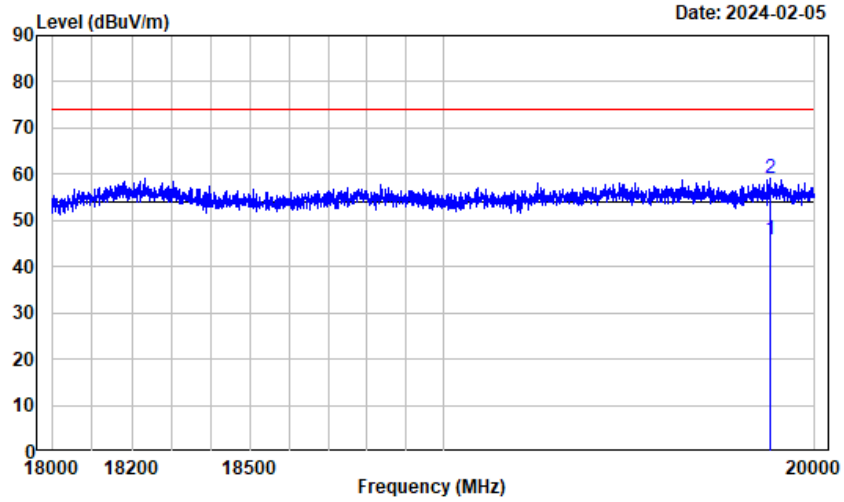

Project No. : SZ1231226-78524E
 Tester : Dylan
 Polarization: Vertical
 Note : FP_1928.448

	Freq	Factor	Read		Limit	Remark	Over
			Level	Level			
	MHz	dB/m	dBuV	dBuV/m	dBuV/m		dB
1	19876.880	13.84	32.09	45.93	54.00	Average	-8.07
2	19876.880	13.84	45.34	59.18	74.00	Peak	-14.82

FCC§15.323 (a) - EMISSION BANDWIDTH

Applicable Standard

Operation shall be contained within the 1920–1930 MHz band. The emission bandwidth shall be less than 2.5 MHz and greater than 50 kHz.

The emission bandwidth is measured in accordance with ANSI C63.17 sub-clause 6.1.3 using the setup below:

Test Setup 1:

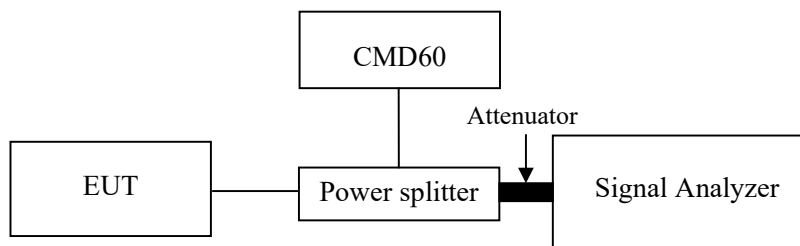

The width, in Hz, of the signal between two points, one below the carrier center frequency and one above the carrier center frequency, that is 26 dB down relative to the maximum level of the modulated carrier. It is based on the use of measurement instrumentation employing a peak detector function with an instrument resolution bandwidth approximately equal to 1% of the emission band-width of the device under measurement. [Extraction from 47 CFR 15, subpart D, 15.303 (C)].

Test Procedure

Using the manufacturer’s information on occupied bandwidth set the spectrum analyzer as follows:

Resolution bandwidth	1.0% of the emission bandwidth (as close as possible)
Video bandwidth	>3 times the resolution bandwidth
Number of sweeps	sufficient to stability the trace
Detection mode	peak detection with maximum hold

Test Data

Environmental Conditions

Temperature:	24.5 °C
Relative Humidity:	46 %
ATM Pressure:	101.0 kPa

The testing was performed by Hanic Pan on 2024-02-23.

Test mode: Transmitting

Test Result: Compliant. Please refer to the following table and plots.

Channel	Center Frequency (MHz)	99% Emission Bandwidth (MHz)	26 dB Emission Bandwidth (MHz)	Limit
Low	1921.536	1.212	1.476	50 kHz ~ 2.5 MHz
Middle	1924.992	1.212	1.476	50 kHz ~ 2.5 MHz
High	1928.448	1.212	1.476	50 kHz ~ 2.5 MHz

26 dB Emission Bandwidth

Low Channel

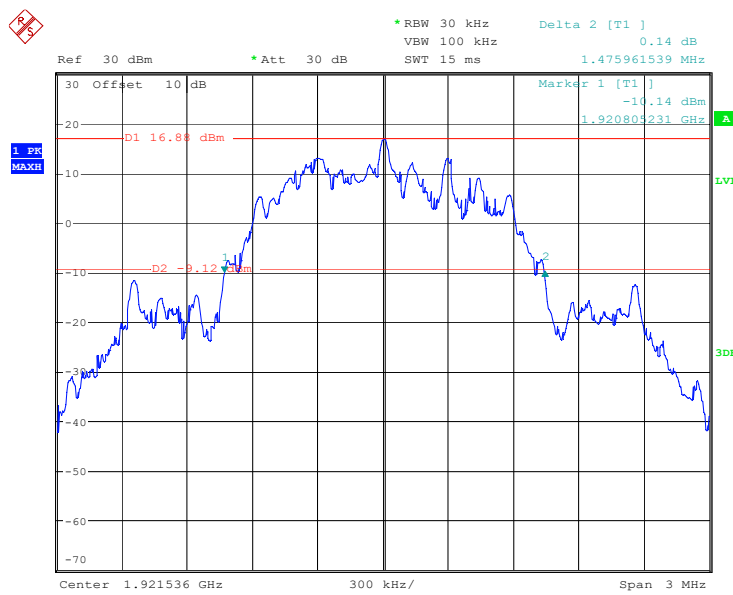

ProjectNo.:SZ1231226-78524E-RF Tester:Hanic Pan
 Date: 23.FEB.2024 15:22:16

Middle Channel

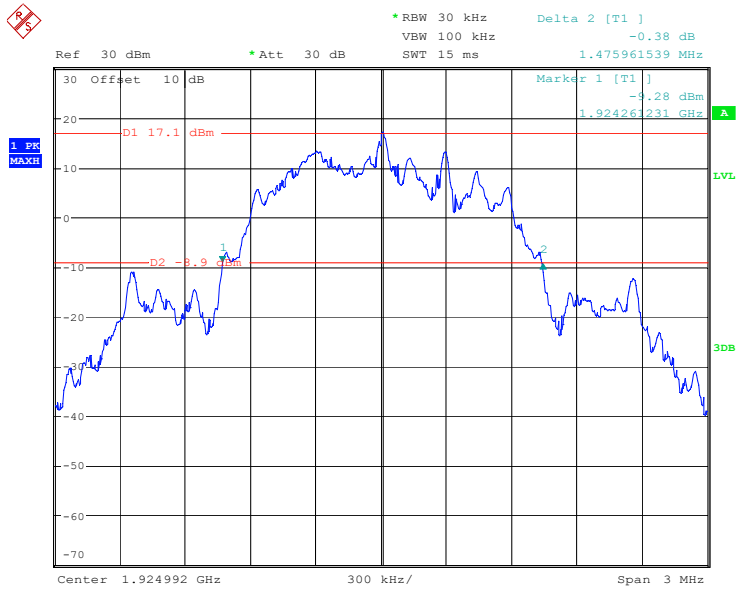

ProjectNo.:SZ1231226-78524E-RF Tester:Hanic Pan
 Date: 23.FEB.2024 15:25:24

High Channel

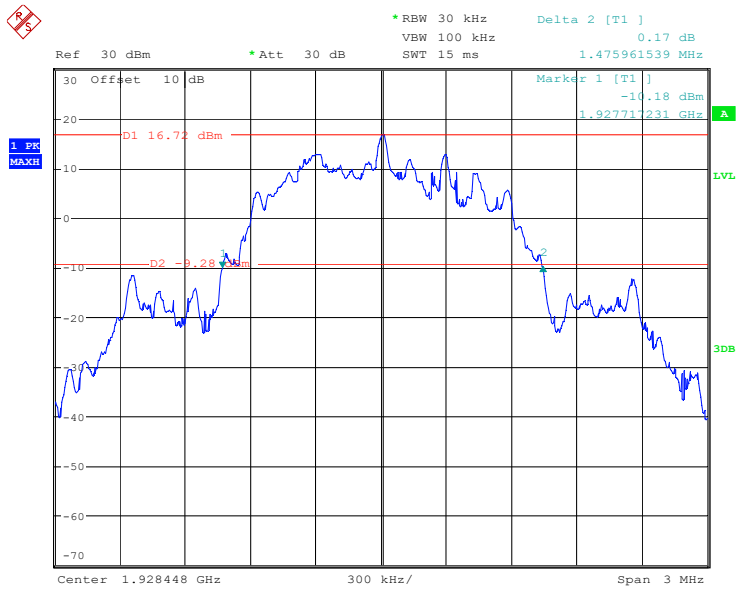

ProjectNo.:SZ1231226-78524E-RF Tester:Hanic Pan
 Date: 23.FEB.2024 15:15:39

99% Emission Bandwidth

Low Channel

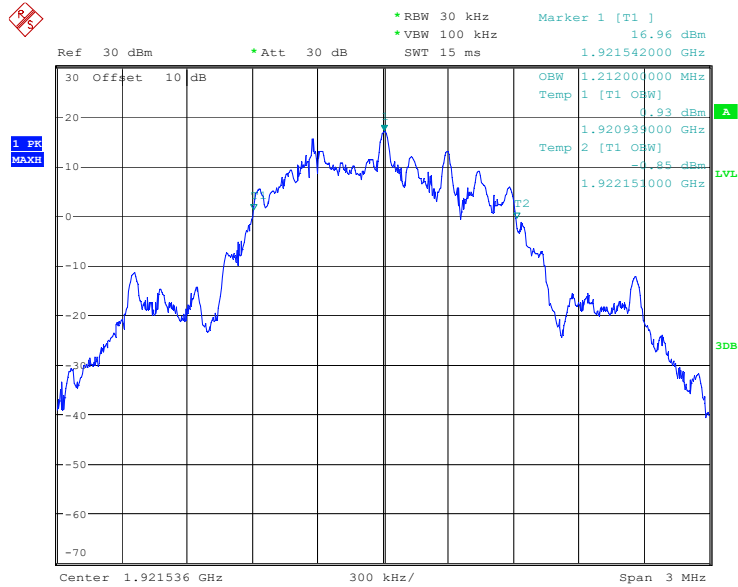

ProjectNo.:SZ1231226-78524E-RF Tester:Hanic Pan
Date: 23.FEB.2024 15:21:36

Middle Channel

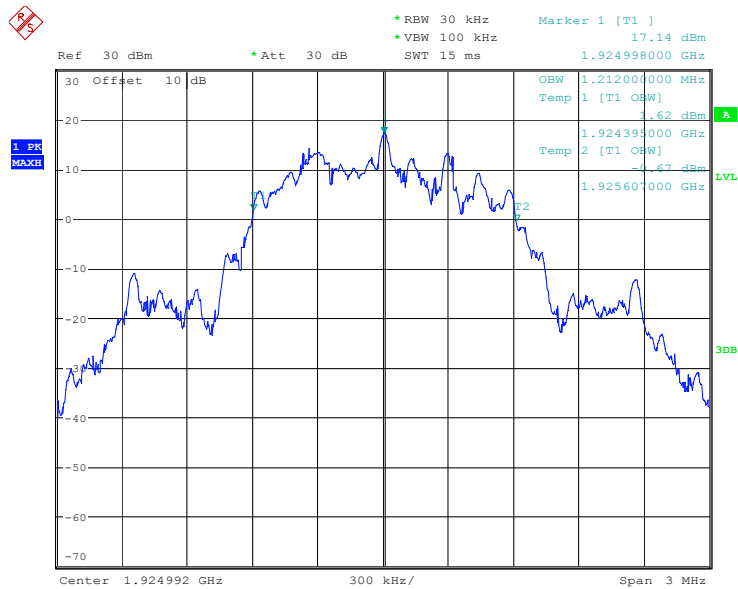

ProjectNo.:SZ1231226-78524E-RF Tester:Hanic Pan
Date: 23.FEB.2024 15:24:46

High Channel

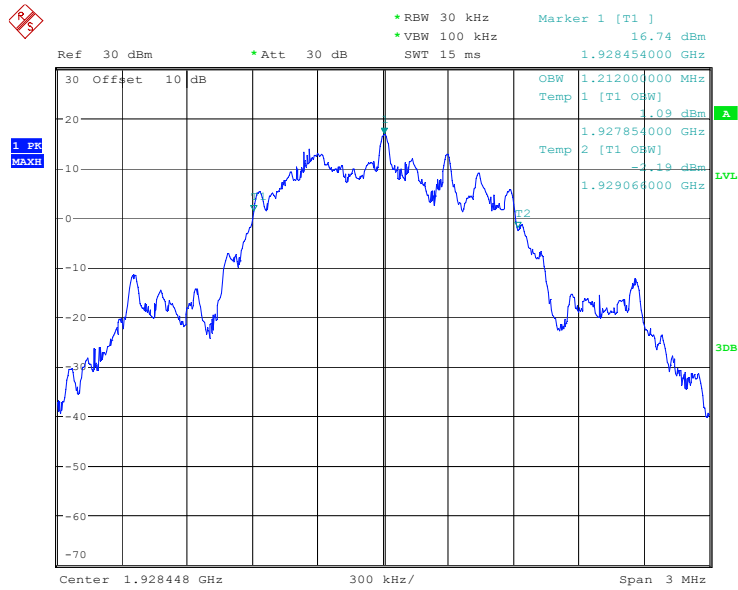

ProjectNo.:SZ1231226-78524E-RF Tester:Hanic Pan
Date: 23.FEB.2024 15:14:48

FCC§15.319 (c) - PEAK TRANSMIT POWER

Applicable Standard

The peak power output as measured over an interval of time equal to the frame rate or transmission burst of the device under all conditions of modulation. Usually this parameter is measured as a conducted emission by direct connection of a calibrated test instrument to the equipment under test. If the device cannot be connected directly, alternative techniques acceptable to the Commission may be used[47 CFR 15, subpart D, 15.303].

The peak transmit power is according to ANSI C63.17-2013 §6.1.2

Per FCC Part15.319 (c) Peak transmit power shall not exceed 100 microwatts multiplied by the square root of the emission bandwidth in hertz. Peak transmit power must be measured over any interval of continuous transmission using instrumentation calibrated in terms of an rms-equivalent voltage. The measurement results shall be properly adjusted for any instrument limitations, such as detector response times, limited resolution bandwidth capability when compared to the emission bandwidth, sensitivity, etc., so as to obtain a true peak measurement for the emission in question over the full bandwidth of the channel.

Per FCC Part15.319 (e), the peak transmit power shall be reduced by the amount in decibels that the maximum directional gain of the antenna exceeds 3 dBi.

Calculation of Peak Transmit Power Limit:

$$\text{Peak Transmit Power Limit} = 100\mu\text{W} \times (\text{EBW})^{1/2}$$

EBW is the transmit emission bandwidth in Hz determined in the other test item:

Test Procedure

Using the manufacturer’s information on occupied bandwidth set the spectrum analyzer as follows:

RBW	≥ Emission bandwidth
Video bandwidth	≥ RBW
Span	Zero
Center frequency	Nominal center frequency of channels
Amplitude scale	Log (linear may be used if analyzer has sufficient linear dynamic range and accuracy)
Detection	Peak detection
Trigger	Video
Sweep rate	Sufficiently rapid to permit the transmit pulse to be resolved accurately

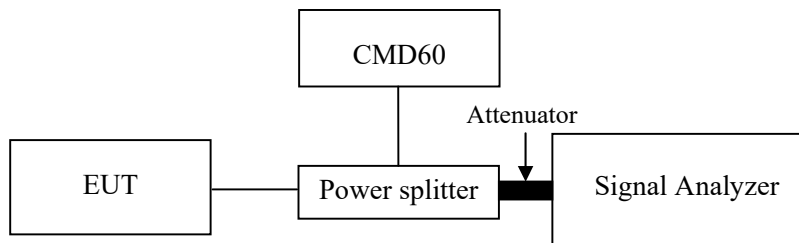

Test Data

Environmental Conditions

Temperature:	25 °C
Relative Humidity:	47 %
ATM Pressure:	101.0 kPa

The testing was performed by Hanic Pan on 2024-01-24.

Test mode: Transmitting

Test Result: Compliant. Please refer to the following table and plots.

Antenna	Channel	Frequency (MHz)	Peak Transmit Power (dBm)	Limit (dBm)
ANT 0	Low	1921.536	17.48	20.85
	Middle	1924.992	17.61	20.85
	High	1928.448	17.68	20.85
ANT 1	Low	1921.536	19.24	20.85
	Middle	1924.992	19.29	20.85
	High	1928.448	19.28	20.85

Note: Peak Transmit Power Limit = 100(EBW)^{1/2} μW

ANT 0

Low Channel

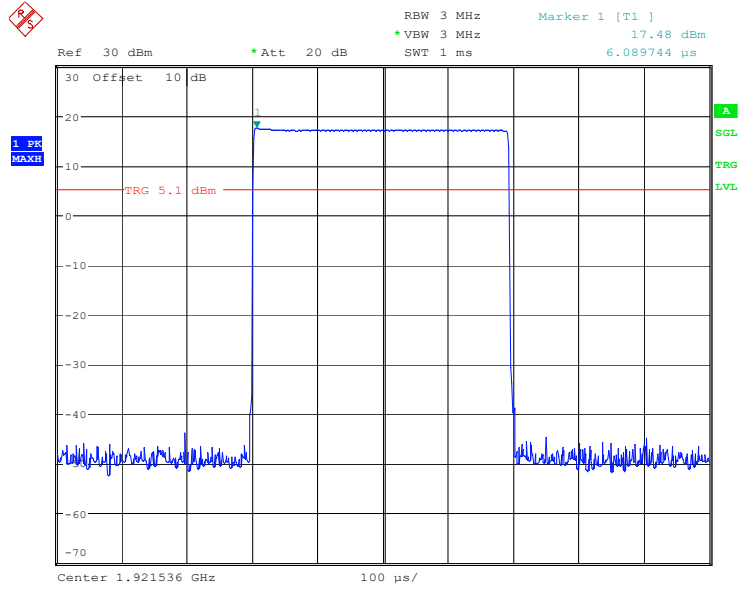

ProjectNo.:SZ1231226-78524E-RF Tester:Hanic Pan
Date: 24.JAN.2024 14:15:01

Middle Channel

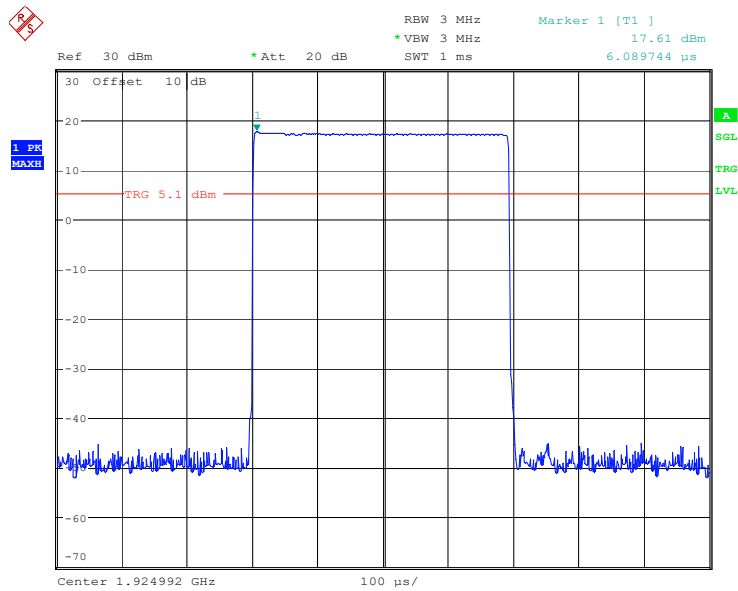

ProjectNo.:SZ1231226-78524E-RF Tester:Hanic Pan
Date: 24.JAN.2024 14:13:45

High Channel

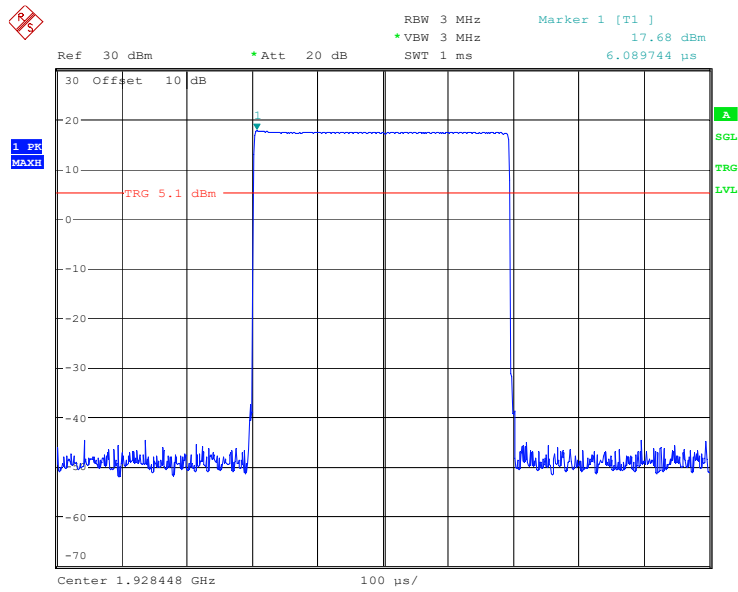

ProjectNo.:SZ1231226-78524E-RF Tester:Hanic Pan
Date: 24.JAN.2024 14:12:13

ANT 1

Low Channel

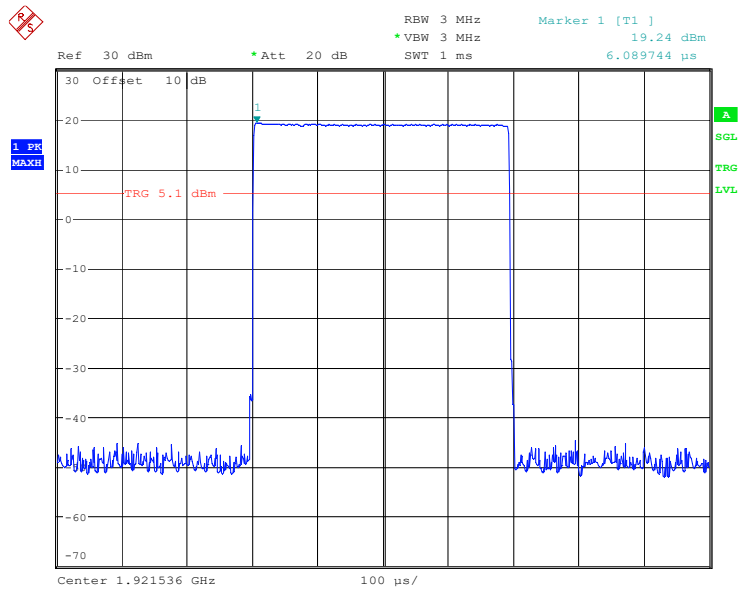

ProjectNo.:SZ1231226-78524E-RF Tester:Hanic Pan
Date: 24.JAN.2024 14:39:33

Middle Channel

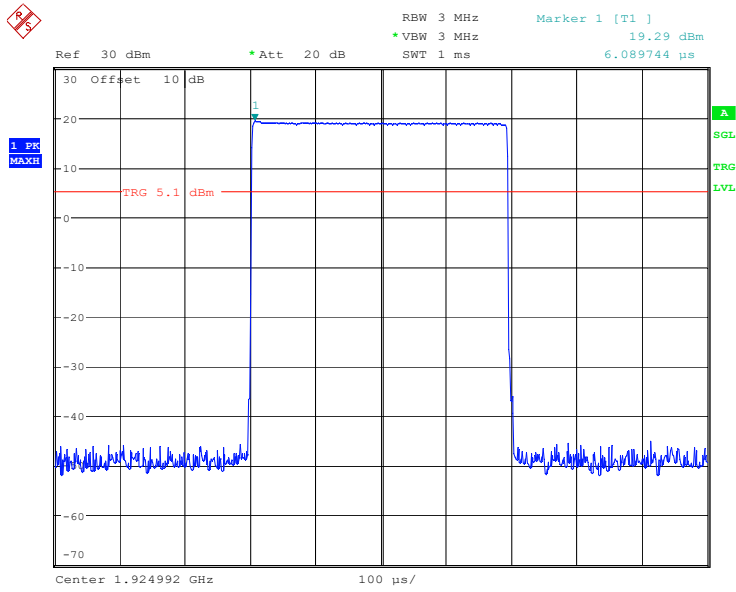

ProjectNo.:SZ1231226-78524E-RF Tester:Hanic Pan
Date: 24.JAN.2024 14:38:42

High Channel

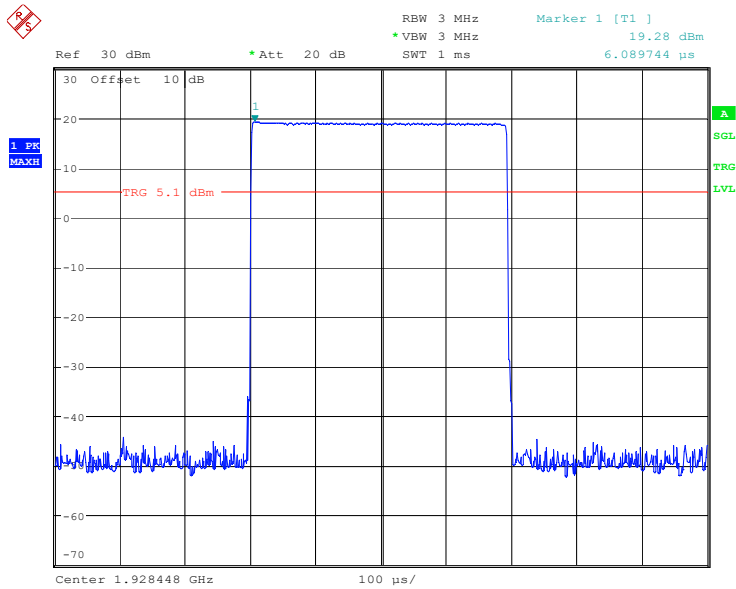

ProjectNo.:SZ1231226-78524E-RF Tester:Hanic Pan
Date: 24.JAN.2024 14:37:29

FCC§15.319 (d) - POWER SPECTRAL DENSITY

Applicable Standard

The average pulse energy in a 3 kHz bandwidth is divided by the pulse duration.

The power spectral density shall not exceed 3mW in any 3 kHz bandwidth as measured with a spectrum analyzer having a resolution bandwidth of 3 kHz.

The power spectral density is measured in accordance with ANSI C63.17.2013 Clause 6.1.5.

Test Procedure

Using the manufacturer’s information on occupied bandwidth set the spectrum analyzer as follows:

RBW	3 kHz
Video bandwidth	$\geq 3 \times \text{RBW}$
Span	Zero span at frequency with the maximum level (frequency determined in 6.1.3 if the same type of signal (continuous versus burst) was used in 6.1.3)
Center frequency	Spectral peak as determined in 6.1.3
Sweep time	For burst signals, sufficient to include essentially all of the maximum length burst at the output of a 3 kHz filter (e.g., maximum input burst duration plus 600 μs). For continuous signals, 20 ms.
Amplitude scale	Log power
Detection	Sample detection and averaged for a minimum of 100 sweeps
Trigger	External or internal

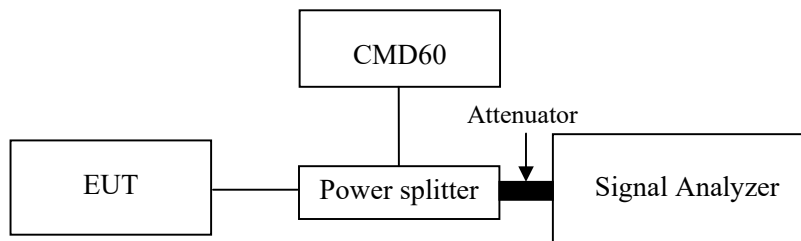

Test Data

Environmental Conditions

Temperature:	25.5 °C
Relative Humidity:	48 %
ATM Pressure:	101.0 kPa

The testing was performed by Hanic Pan on 2024-02-02.

Test mode: Transmitting

Test Result: Compliant. Please refer to following table and plots

Channel	Frequency (MHz)	Power Spectral Density		Limit (mW/3kHz)
		(dBm/3kHz)	(mW/3kHz)	
Low	1921.536	-1.10	0.776	3
Middle	1924.992	-0.79	0.834	3
High	1928.448	0.57	1.140	3

Low Channel

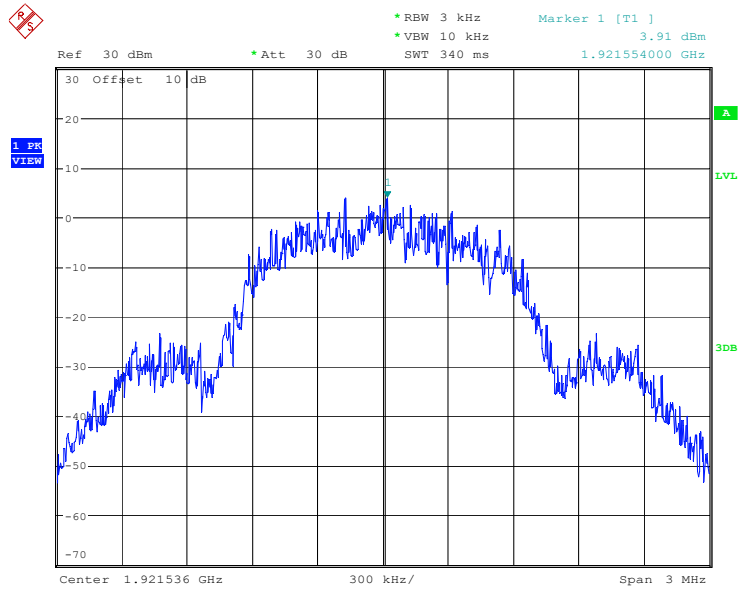

ProjectNo.:SZ1231226-78524E-RF Tester:Hanic Pan
Date: 2.FEB.2024 10:48:59

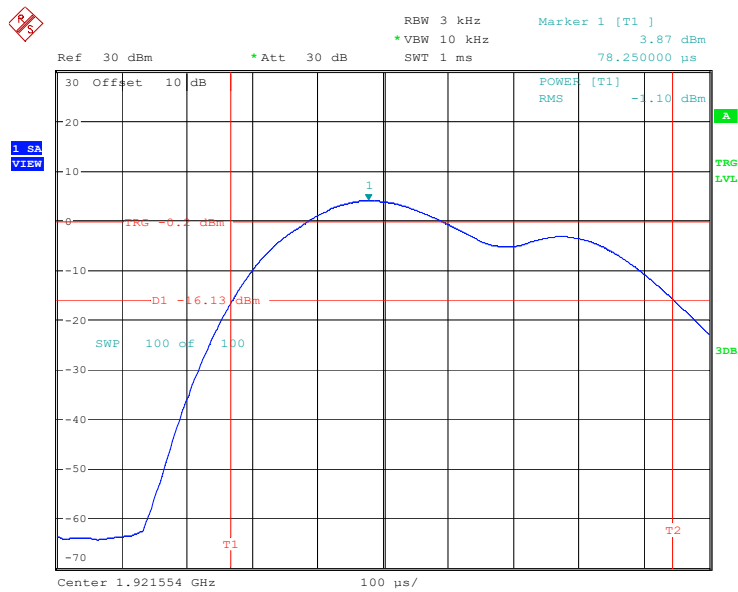

ProjectNo.:SZ1231226-78524E-RF Tester:Hanic Pan
Date: 2.FEB.2024 11:06:35

Middle Channel

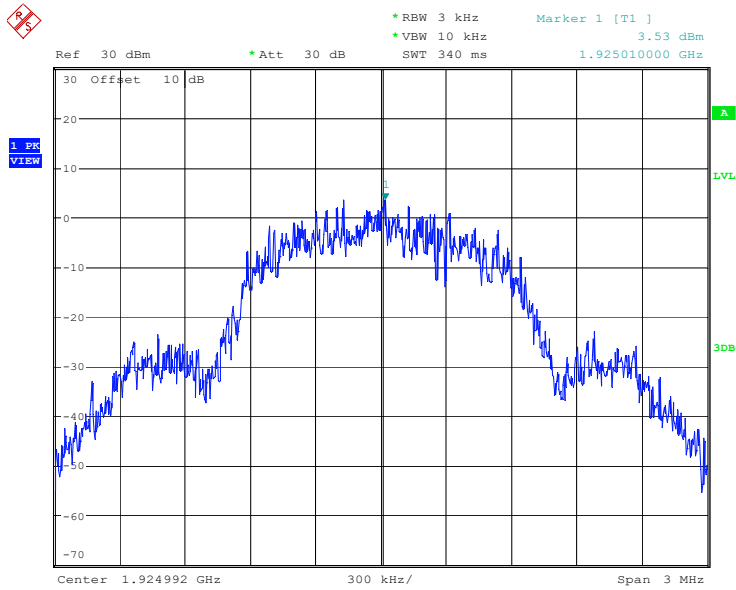

ProjectNo.:SZ1231226-78524E-RF Tester:Hanic Pan
Date: 2.FEB.2024 10:45:53

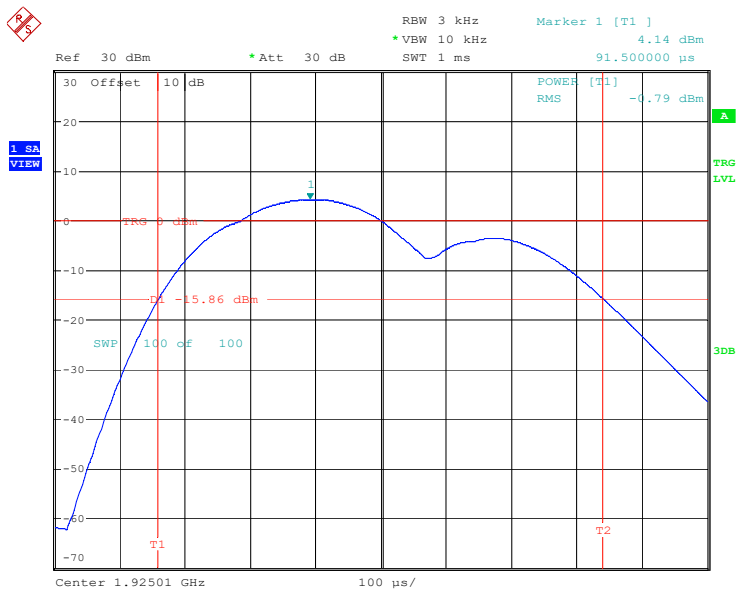

ProjectNo.:SZ1231226-78524E-RF Tester:Hanic Pan
Date: 2.FEB.2024 10:47:27

High Channel

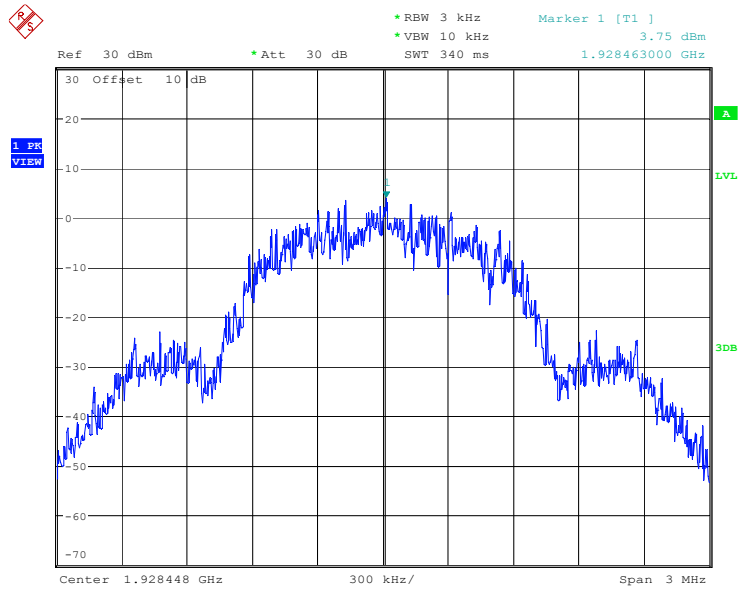

ProjectNo.:SZ1231226-78524E-RF Tester:Hanic Pan
Date: 2.FEB.2024 10:41:32

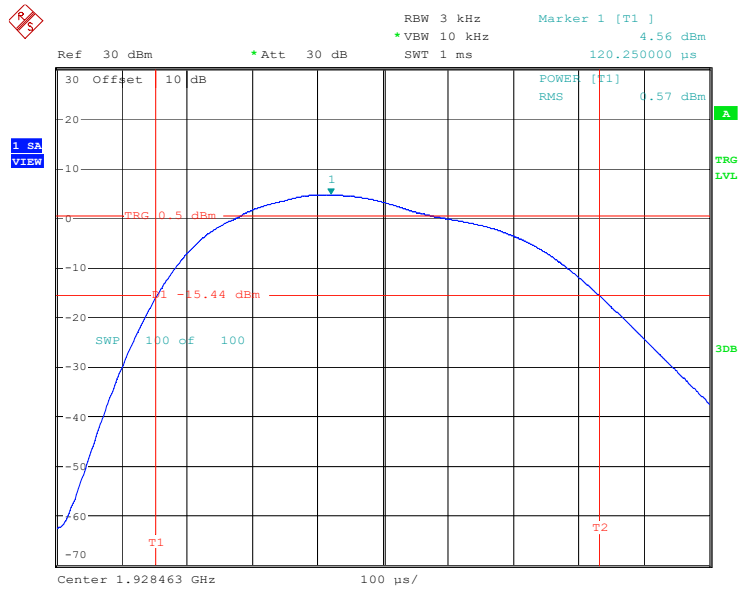

ProjectNo.:SZ1231226-78524E-RF Tester:Hanic Pan
Date: 2.FEB.2024 10:44:14

FCC§15.323 (d) - EMISSION INSIDE AND OUTSIDE THE SUB-BAND

Applicable Standard

Emissions inside the sub-band must comply with the following emission mask:

1. In the bands between 1B and 2B measured from the center of the emission bandwidth the total power emitted by the device shall be at least 30 dB below the transmit power permitted for that device;
2. in the bands between 2B and 3B measured from the center of the emission bandwidth the total power emitted by an intentional radiator shall be at least 50 dB below the transmit power permitted for that radiator;
3. in the bands between 3B and the sub-band edge the total power emitted by an intentional radiator in the measurement bandwidth shall be at least 60 dB below the transmit power permitted for that radiator.

Where B = emission bandwidth

Emission Outside the sub-band shall be attenuated below a reference power of 112 mw (20.5 dBm) as follows:

1. 30 dB between the sub-band and 1.25 MHz above or below the sub-band;
2. 50 dB between 1.25 and 2.5 MHz above or below the sub-band;
3. 60 dB at 2.5 MHz or greater above or below the sub-band.

Test Procedure

According to ANSI C63.17-2013 Clause 6.1.6.

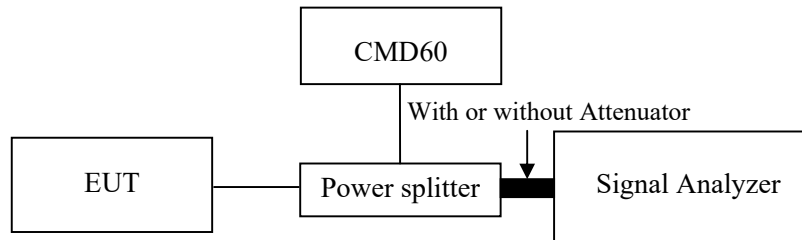

Test Data

Environmental Conditions

Temperature:	24.5~25 °C
Relative Humidity:	46~47 %
ATM Pressure:	101.0 kPa

The testing was performed by Hanic Pan from 2024-01-24 to 2024-02-23.

Test mode: Transmitting

Test Result: Compliant. Please refer to following plots

Low Channel (Unwanted Emission inside the Sub-band)

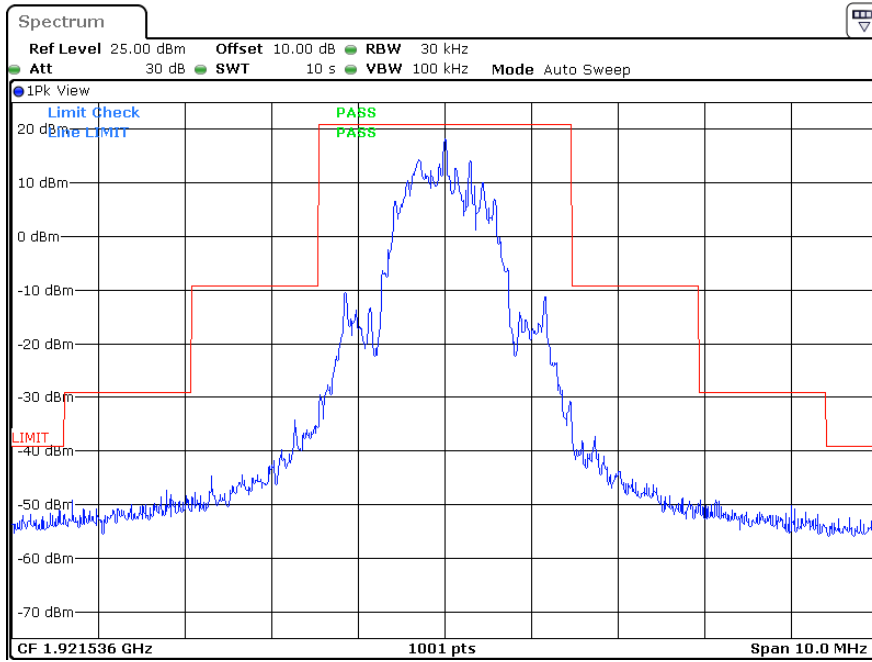

ProjectNo.:SZ1231226-78524E-RF Tester:Hanic Pan
Date: 23.FEB.2024 19:14:20

Middle Channel (Unwanted Emission inside the Sub-band)

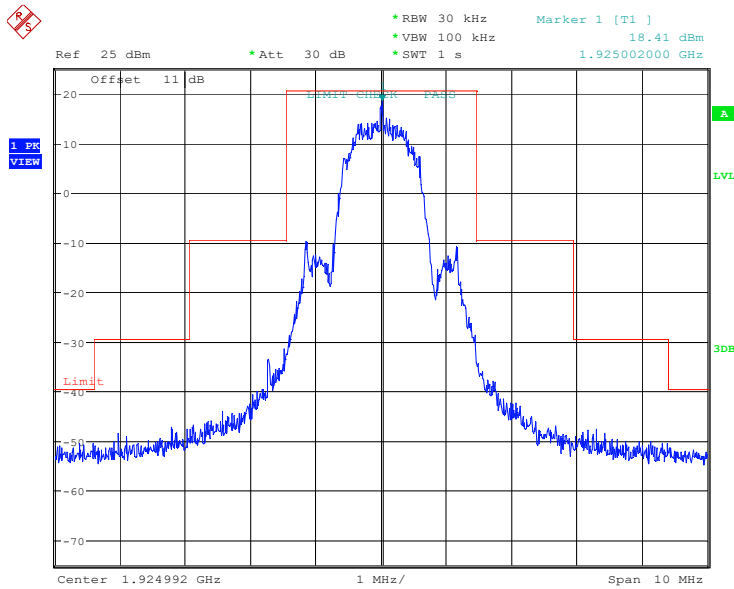

ProjectNo.:SZ1231226-78524E-RF Tester:Hanic Pan
Date: 24.JAN.2024 16:45:51

High Channel (Unwanted Emission inside the Sub-band)

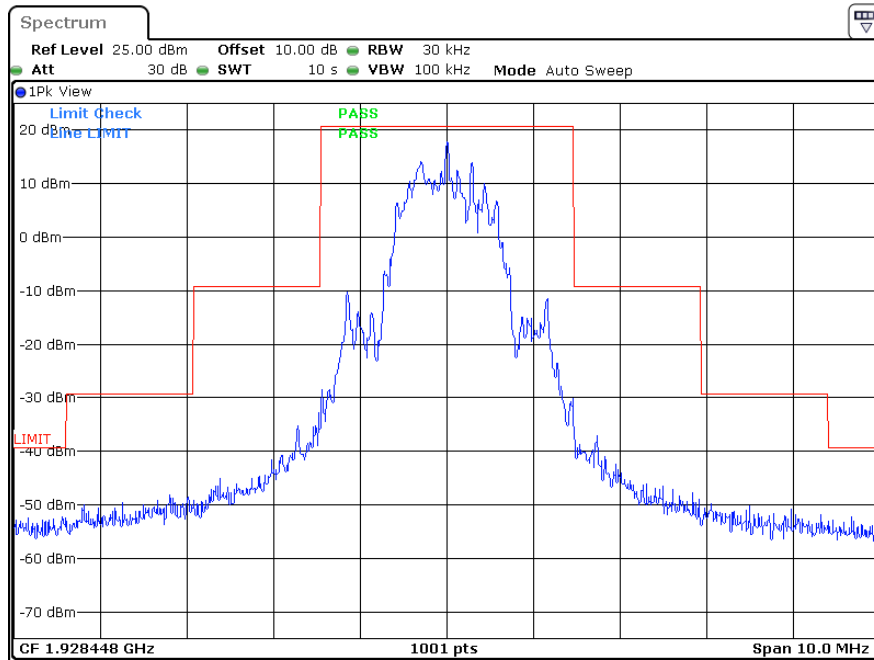

ProjectNo.:SZ1231226-78524E-RF Tester:Hanic Pan
 Date: 23.FEB.2024 19:18:21

Low Channel (Unwanted Emission outside the Sub-band)

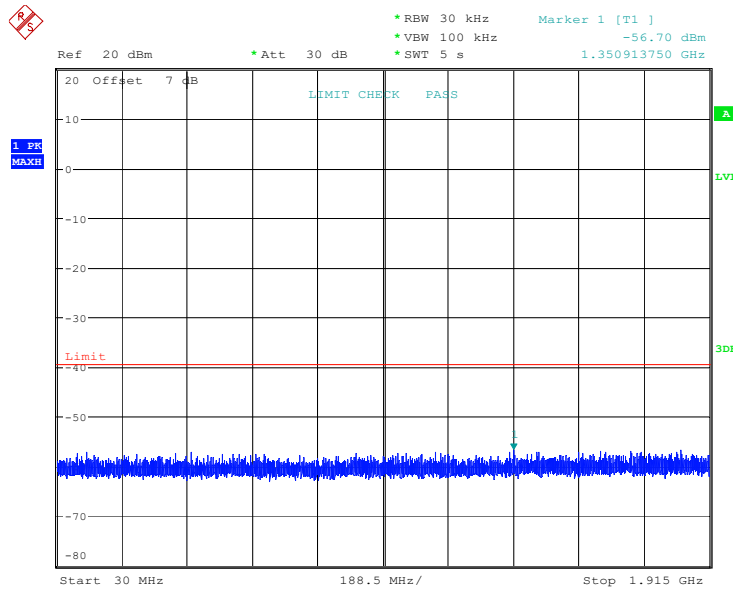

ProjectNo.:SZ1231226-78524E-RF Tester:Hanic Pan
 Date: 24.JAN.2024 17:03:07

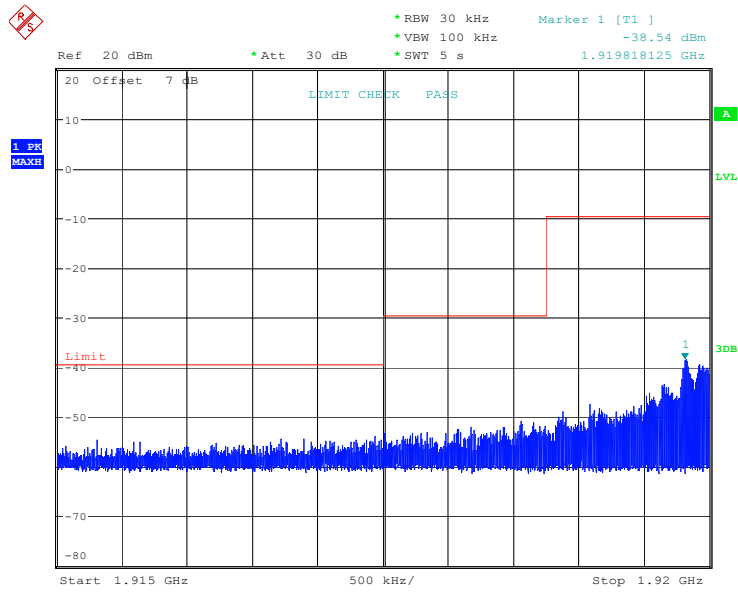

ProjectNo.:SZ1231226-78524E-RF Tester:Hanic Pan
Date: 24.JAN.2024 17:03:50

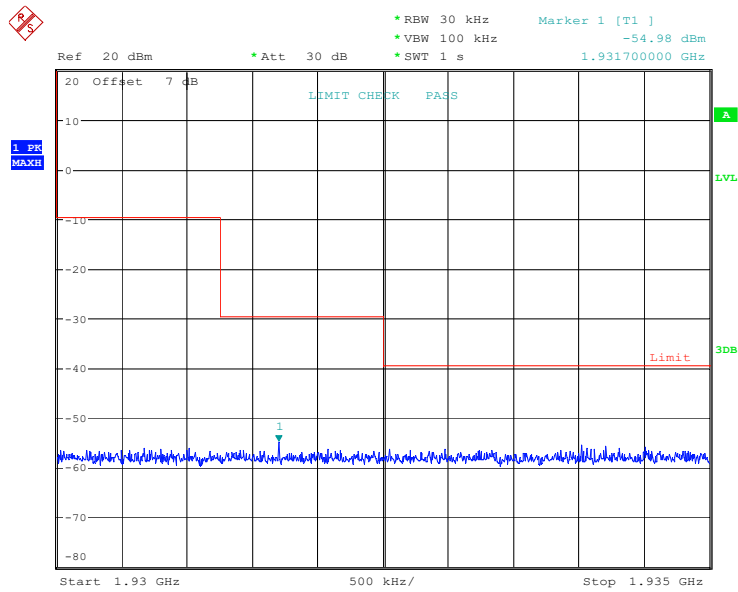

ProjectNo.:SZ1231226-78524E-RF Tester:Hanic Pan
Date: 24.JAN.2024 17:04:26

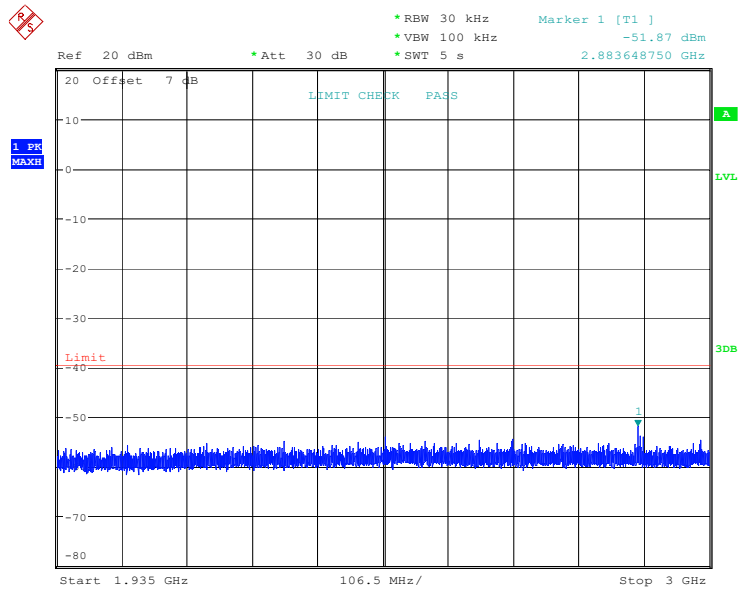

ProjectNo.:SZ1231226-78524E-RF Tester:Hanic Pan
Date: 24.JAN.2024 17:05:08

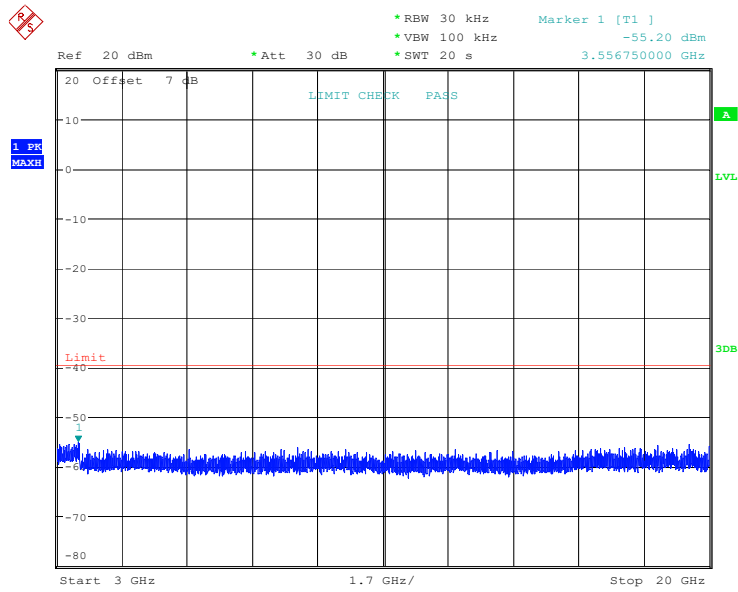

ProjectNo.:SZ1231226-78524E-RF Tester:Hanic Pan
Date: 24.JAN.2024 17:06:09

Middle Channel (Unwanted Emission outside the Sub-band)

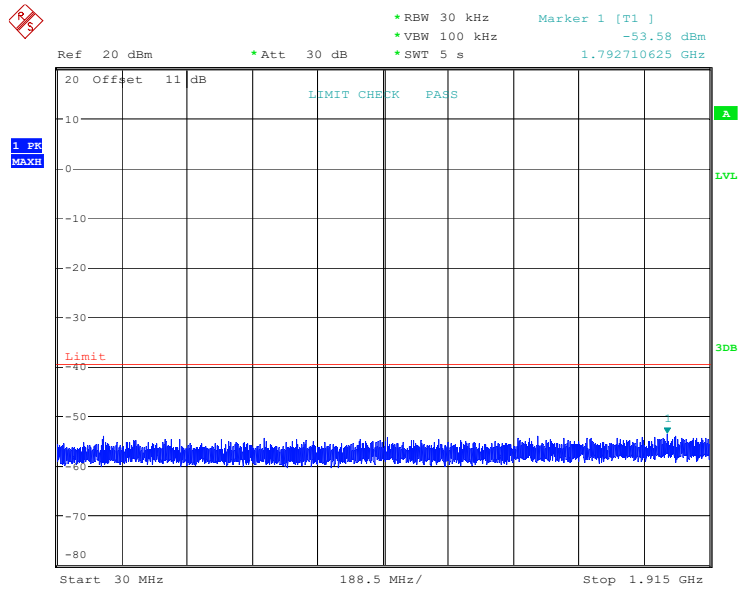

ProjectNo.:SZ1231226-78524E-RF Tester:Hanic Pan
Date: 24.JAN.2024 16:46:33

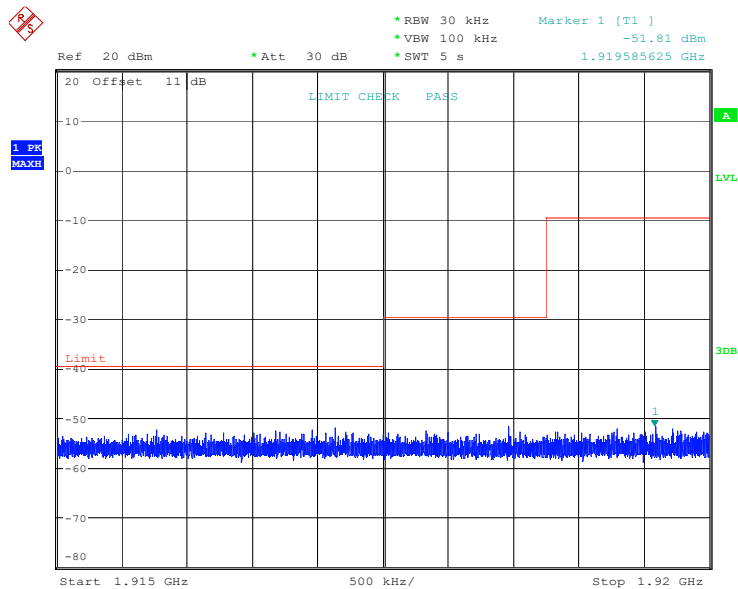

ProjectNo.:SZ1231226-78524E-RF Tester:Hanic Pan
Date: 24.JAN.2024 16:47:16

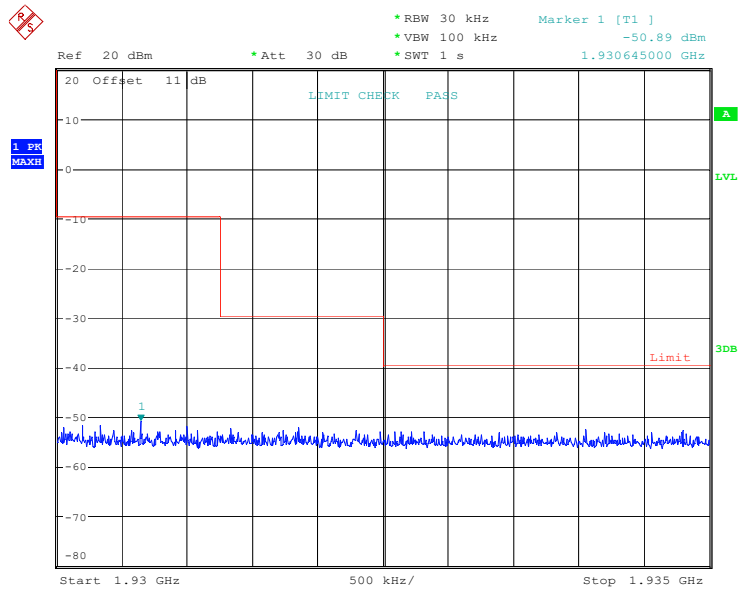

ProjectNo.:SZ1231226-78524E-RF Tester:Hanic Pan
Date: 24.JAN.2024 16:47:52

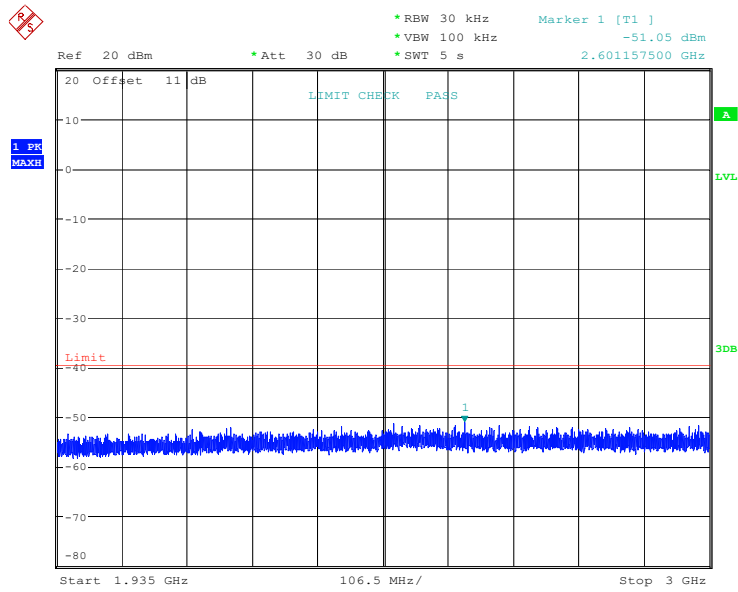

ProjectNo.:SZ1231226-78524E-RF Tester:Hanic Pan
Date: 24.JAN.2024 16:48:34

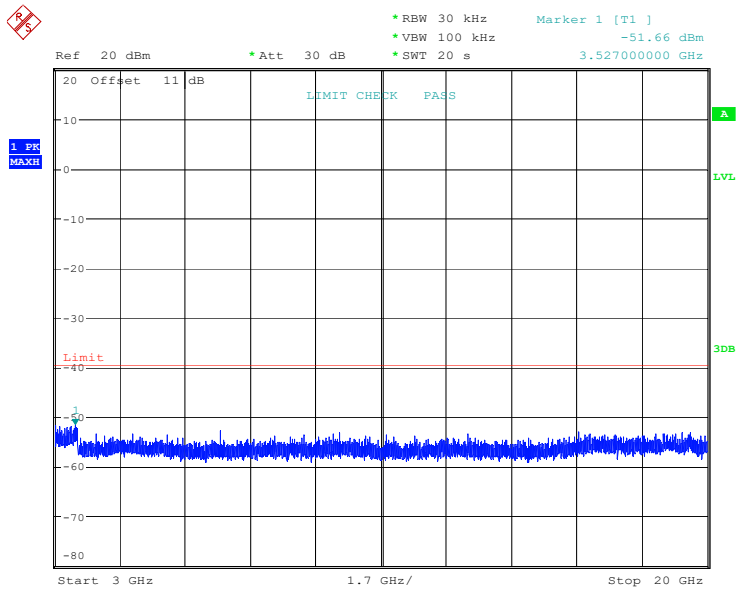

ProjectNo.:SZ1231226-78524E-RF Tester:Hanic Pan
Date: 24.JAN.2024 16:49:35

High Channel (Unwanted Emission outside the Sub-band)

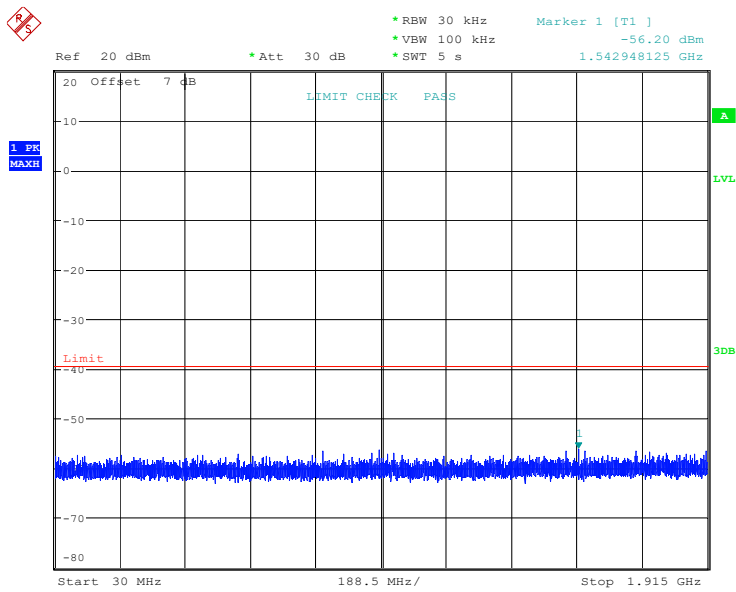

ProjectNo.:SZ1231226-78524E-RF Tester:Hanic Pan
Date: 24.JAN.2024 16:51:57

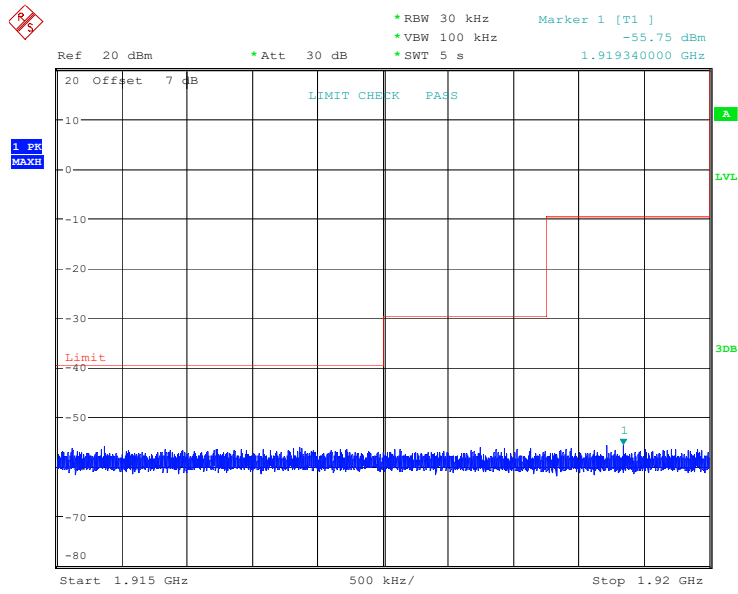

ProjectNo.:SZ1231226-78524E-RF Tester:Hanic Pan
Date: 24.JAN.2024 16:52:39

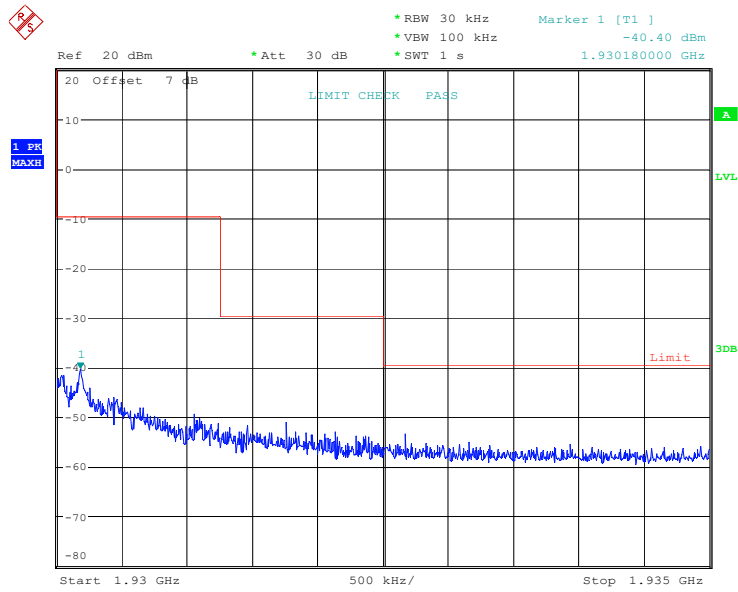

ProjectNo.:SZ1231226-78524E-RF Tester:Hanic Pan
Date: 24.JAN.2024 16:53:15

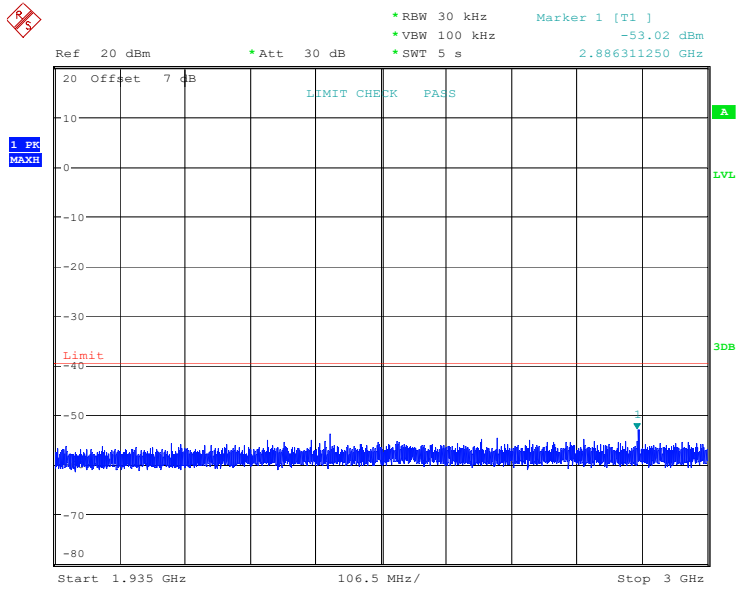

ProjectNo.:SZ1231226-78524E-RF Tester:Hanic Pan
Date: 24.JAN.2024 16:53:57

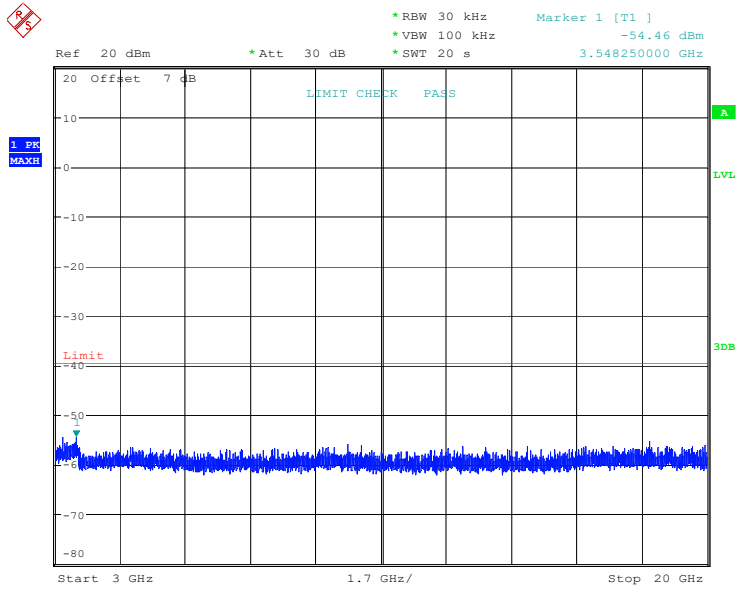

ProjectNo.:SZ1231226-78524E-RF Tester:Hanic Pan
Date: 24.JAN.2024 16:54:58

FCC§15.323 (f) - FREQUENCY STABILITY

Applicable Standard

Per §15.323(f), the frequency stability of the carrier frequency of the intentional radiator shall be maintained within ± 10 ppm over 1 hour or the interval between channel access monitoring, whichever is shorter. The frequency stability shall be maintained over a temperature variation of -20°C to $+50^{\circ}\text{C}$ at normal supply voltage, and over a variation in the primary supply voltage of 85 percent to 115 percent of the rated supply voltage at a temperature of 20°C . For equipment that is capable only of operating from a battery, the frequency stability tests shall be performed using a new battery without any further requirement to vary supply voltage

Test Procedure

This procedure should be carried out for each of the following test cases:

Temperature	Supply Voltage
20°C	85-115% or new batteries
-20°C	Normal
+50°C	Normal

During test, the equipment shall be placed in the boxes and set the temperature to the specified requirement until the thermal balance has been reached.

Using the mean carrier frequency at 20°C and at nominal supply voltage as the reference, the mean carrier frequency shall be maintained within ± 10 ppm at the two extreme temperatures (or as declared by the manufacturer) and at normal temperature (typically 20°C) at the two extreme supply voltages. This test does not apply to a EUT that is capable only of operating from a battery.

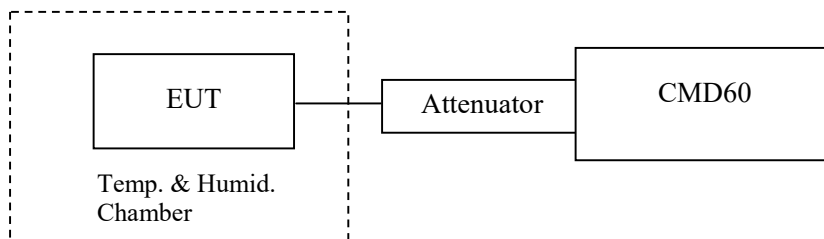

Test Data

Environmental Conditions

Temperature:	25 °C
Relative Humidity:	47 %
ATM Pressure:	101.0kPa

The testing was performed by Hanic Pan on 2024-01-24.

Test mode: Transmitting

Test Result: Compliant

Temperature (°C)	Voltage (V _{AC})	Channel Frequency (MHz)	Measured Frequency Offset (kHz)	Measured Frequency Offset (ppm)	Limit (ppm)
-20	120	1924.992	6	3.12	±10
20	102	1924.992	7	3.64	±10
	138	1924.992	7	3.64	±10
50	120	1924.992	5	2.60	±10

FCC§15.323 (c) (e) & §15.319(f) – SPECIFIC REQUIREMENTS FOR UPCS DEVICE

Applicable Standard

FCC§15.323(c)(e) & §15.319(f) Specific Requirements for UPCS device.
 ANSI C63.17 2013 §6.2 Frequency and time stability and §7.Monitoring tests and §8.Time and spectrum window access procedure.

Test Procedure

Measurement method according to ANSI C63.17 -2013

Test configuration as below

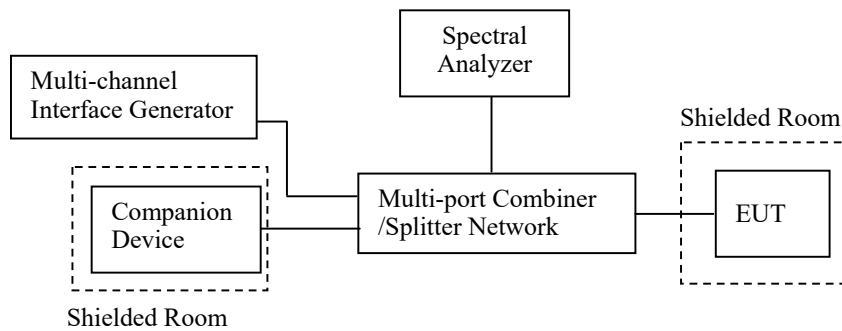

Test Data

Environmental Conditions

Temperature:	25 °C
Relative Humidity:	47 %
ATM Pressure:	101.0 kPa

The testing was performed by Hanic Pan on 2024-01-24.

Test Result: Compliant, please see the below data

1) Automatic Discontinuation of Transmission, FCC §15.319(f)

The device shall automatically discontinue transmission in case of either absence of information to transmit or operational failure. The provisions in this section are not intended to preclude transmission of control and signaling information or use of repetitive codes used by certain digital technologies to complete frame or burst intervals.

Test result:

The following tests were performed after a connection had been established with handset.

Test condition	Reaction of EUT	Pass/Fail
The Base power off	Connection break down	Pass
The battery remove from Handset	Connection break down	Pass

2) Monitoring Time, FCC §15.323(c) (1)

Immediately prior to initiating transmission, devices must monitor the combined time and spectrum window in which they intend to transmit. For a period of at least 10 milliseconds for systems designed to use a 10 milliseconds or shorter frame period or at least 20 milliseconds for systems designed to use a 20 milliseconds frame period

Test procedure:

Measurement method is in according to ANSI C63.17 2013 clause 7.3.3. RF signal generators apply uniform CW interference on all system carriers except two carriers (designated f_1 and f_2), each at level $T_L + U_M$. EUT can only transmit on these two carriers.

Test result:

This requirement is covered by the results of Least Interfered Channel (LIC).

Interference (Refer to ANSI C63.17 clause 7.3.3)	Reaction of EUT	Results
a) Apply the interference on f_1 at level $T_L + U_M + 20\text{dB}$ and no interference on f_2 . Initiate transmission and verify the transmission only on f_2 . Then terminate it.	EUT transmits on f_2	Pass
b) Apply the interference on f_2 at level $T_L + U_M + 20\text{dB}$ and immediately remove all interference from f_1 . The EUT should immediately attempt transmission on f_1 (but at least 20 ms after the interference on f_2 is applied), verify the transmission only on f_1 .	EUT transmission f_1	Pass

3) Lower Monitoring Threshold, FCC §15.323(c) (2)

The monitoring threshold must not be more than 30 dB above the thermal noise power for a bandwidth equivalent to the emission bandwidth used by the device.

Test procedure:

Measurement method according to ANSI C63.17 2013 clause 7.3.1

Test result:

Not applicable because the EUT has more 40 defined duplex system access channels and meet the provision of the Least Interfered Channel (LIC) based on FCC §15.323(c) (5).

4) Maximum Transmit Period, FCC §15.323(c) (3)

If no signal above the threshold level is detected, transmission may commence and continue with the same emission bandwidth in the monitored time and spectrum windows without further monitoring. However, occupation of the same combined time and spectrum windows by a device or group of cooperating devices continuously over a period of time longer than 8 hours is not permitted without repeating the access criteria.

Test procedure:

Measurement method according to ANSI C63.17- 2013 clause 8.2.2

The test procedure is as follows:

- a) Activate the EUT and initiate a communication channel with the companion device, and start a timer or frame counter.
- b) The centre frequency of spectrum analyzer was set to the carrier frequency and SPAN was set to ZERO. The spectrum analyzer was used to monitor the time and spectrum window of the communication channel.
- c) Stop the timer at the end of the EUT transmission on the current time and frequency window (measure the time until the EUT changes to a different slot).

Test result:

Repetition of Access Criteria	Measured Maximum Transmission Time (Second)	Limit (Second)	Results
First	18660	28,800	Pass
Second	18660	28,800	Pass

5) System Acknowledgement, FCC §15.323(c) (4)

Once access to specific combined time and spectrum windows is obtained an acknowledgment from a system participant must be received by the initiating transmitter within one second or transmission must cease.

Periodic acknowledgments must be received at least every 30 seconds or transmission must cease. Channels used exclusively for control and signaling information may transmit continuously for 30 seconds without receiving an acknowledgment, at which time the access criteria must be repeated.

Test procedure:

Measurement method according to ANSI C63.17 2013 clause 8.2.1

During testing initial transmission without acknowledgement, the signal from the EUT to the companion device is blocked by the circulator.

The test of the transmission time after loss of acknowledgements is performed by cutting off the signal from the companion device by a RF switch and measuring the time until the EUT stops transmitting.

Test result:

Test	Time taken (second)	Limit (second)	Result
Initial Connection acknowledgement	0.42	1	Pass
Change of access criteria for control information	N/A	30	N/A
Transmission cease time after loss of acknowledgement	4.23	30	Pass

Note: N/A=Not Applicable

6) Least Interfered Channel (LIC), FCC §15.323(c) (5)

If access to spectrum is not available as determined by the above, and a minimum of 20 duplex system access channels are defined for the system, the time and spectrum windows with the lowest power level may be accessed.

A device utilizing the provisions of this paragraph (5) must have monitored all access channels defined for its system within the last 10 seconds and must verify, within the 20 milliseconds (40 milliseconds for devices designed to use a 20 millisecond frame period) immediately preceding actual channel access, that the detected power of the selected time and spectrum windows is no higher than the previously detected value.

The power measurement resolution bandwidth for this comparison must be accurate to within 6 dB. No device or group of cooperating devices located within 1 metre of each other shall during any frame period occupy more than 6 MHz of aggregate bandwidth, or alternatively, more than one third of the time and spectrum windows defined by the system.

Calculation of monitoring threshold limits for isochroous devices:

Lower threshold: $T_L = -174 + 10\text{Log}_{10}B + M_L + P_{MAX} - P_{EUT}$ (dBm)

Where: B=Emission bandwidth (Hz)

M_L = dB the threshold may exceed thermal noise (30 for T_L)

$P_{MAX} = 5\text{Log}_{10}B - 10$ (dBm)

P_{EUT} = Transmitted power (dBm)

Calculated thresholds:

Monitor Threshold	B(MHz)	M_L (dB)	P_{MAX} (dBm)	P_{EUT} (dBm)	Threshold (dBm)
Lower threshold	1.476	30	20.85	19.29	-80.75

Note: 1.The upper threshold is applicable as the EUT utilizes more than 20 duplex system channels

Test procedure:

Measurement method according to ANSI C63.17 clause 7.3.2, 7.3.3

C63.17 clause 7.3.2, LIC procedure test:

- a) Allow EUT transmission on only two carrier frequencies, which will be designated f_1 and f_2 .
- b) Apply interference to the EUT on f_1 at a level of $TL + UM + 7$ dB and on f_2 at a level of $TL + UM$. Initiate transmission. The EUT should transmit on f_2 . Terminate the connection. Repeat five times. If the EUT transmits once on f_1 , the test failed.
- c) Apply interference to the EUT on f_1 at a level of $TL + UM$ and on f_2 at a level of $TL + UM + 7$ dB. Initiate transmission. The EUT should transmit on f_1 . Terminate the connection. Repeat five times. If the EUT transmits once on f_2 , the test failed.
- d) Apply interference to the EUT on f_1 at a level of $TL + UM + 1$ dB and on f_2 at a level of $TL + UM - 6$ dB. Initiate transmission. If the EUT transmits on f_2 , terminate the connection. Repeat five times. If the EUT transmits once on f_1 , the test failed.
- e) Apply interference to the EUT on f_1 at a level of $TL + UM - 6$ dB and on f_2 at a level of $TL + UM + 1$ dB. Initiate transmission. If the EUT transmits on f_1 , terminate the connection. Repeat five times. If the EUT transmits once on f_2 , the test failed.

C63.17 clause 7.3.3, Selected channel confirmation:

- a) Allow EUT transmission on only two carrier frequencies, which will be designated f_1 and f_2 . This limitation to carriers f_1 and f_2 is performed preferably by administration commands for the EUT, or alternatively by applying by a multicarrier interference generator uniform interference on all system carriers except f_1 and f_2 , at a level of $TL + UM + 20$ dB in-band per carrier. Set the interference level to the EUT on f_1 to a level of $TL + UM + 20$ dB, and let there be no interference applied on f_2 .
- b) Initiate transmission and verify that the EUT transmits on f_2 . If a connection was made, terminate it.
- c) Apply interference on f_2 at a level of $TL + UM + 20$ dB in-band, and immediately remove all interference from f_1 and immediately (but not sooner than 20 ms after the interference on f_2 is applied) cause the EUT to attempt transmission. The EUT should now transmit on f_1 , if it transmits.
- d) If the EUT transmits on f_2 , it fails.

Test result:

1) LIC procedure test:

Interference (Refer to ANSI C63.17 clause 7.3.3)	Reaction of EUT	Results
a) Apply the interference on f_1 at level T_L+U_M+7 dB and the interference on f_2 at level T_L+U_M . Initiate transmission and verify the transmission only on f_2 . Repeat 5 times.	EUT transmits on f_2	Pass
b) Apply the interference on f_1 at level T_L+U_M and the interference on f_2 at level T_L+U_M+7 dB. Initiate transmission and verify the transmission only on f_1 . Repeat 5 times.	EUT transmits on f_1	Pass
c) Apply the interference on f_1 at level T_L+U_M+1 dB the interference on f_2 at level T_L+U_M-6 dB. Initiate transmission and verify the transmission only on f_2 . Repeat 5 times.	EUT transmits on f_2	Pass
d) Apply the interference on f_1 at level T_L+U_M-6 dB and the interference on f_2 at level T_L+U_M+1 dB. Initiate transmission and verify the transmission only on f_1 . Repeat 5 times.	EUT transmits on f_1	Pass

2) Selected channel confirmation:

Interference (Refer to ANSI C63.17 clause 7.3.4)	Reaction of EUT	Results
a) Apply the interference on f_1 at level T_U+U_M and no interference on f_2 . Initiate transmission and verify the transmission only on f_2 . Then terminate it.	EUT transmits on f_2	Pass
b) Apply the interference on f_2 at level T_L+U_M and immediately remove all interference from f_1 . The EUT should immediately attempt transmission on f_1 (but at least 20 ms after the interference on f_2 is applied), verify the transmission only on f_1 .	EUT transmission f_1	Pass

7) Random waiting, FCC §15.323(c) (6)

If the selected combined time and spectrum windows are unavailable, the device may either monitor and select different windows or seek to use the same window after waiting an amount of time, randomly chosen from a uniform random distribution between 10 and 150 milliseconds, commencing when the channel becomes available.

Test procedure:

This test is for EUTs that transmit control and signaling channels and that use the provisions of FCC §15.323(c)(6), thus to verify that the EUT (if in deferral) waits for a channel to go clear, then implements a 10 ms to 150 ms hold off prior to using the channel. FCC §15.323(c)(6) is not restrictive for EUTs that use the LIC and offer 20 or more duplex communications channels, as a combined time and spectrum window cannot become unavailable as there is no threshold limit. Test method according to ANSI C63.17 2013 clause 8.1.3

- a) Restrict operation of the EUT to a single carrier designated f_1 . For TDMA system, further restrict EUT transmission to a single timeslot of the usable timeslots available in the TDMA frame structure and synchronize the interference so as to occur centered within the timeslot.
- b) Activate the EUT with no interference present. The EUT must transmit on f_1 . Then apply CW interference on f_1 . The interference level shall be at $TL + UM$ as appropriate for EUTs that do or do not meet the requirements for using the upper threshold. The EUT must stop transmitting within 30 s.
- c) Cancel the interference. Measure the time interval between the end of the interference transmission and the beginning of transmission by the EUT.
- d) Repeat step b) and step c) 100 times. If the measured time intervals vary uniformly between 10 ms and 150 ms, the EUT passes the test.

Note: This is Not Applicable

8) Monitoring Bandwidth and Reaction Time, FCC §15.323(c) (7)

The monitoring system bandwidth must be equal to or greater than the emission bandwidth of the intended transmission and have a maximum reaction time less than $50 \times \text{SQRT}(1.25/\text{emission bandwidth in MHz})$ microseconds for signals at the applicable threshold level but shall not be required to be less than 50 microseconds

Test procedure:

Measurement method according to ANSI C63.17 2013 clause 7.5

- a) Restrict the EUT to a single transmit carrier frequency f_1 , and verify that the EUT can establish a connection with no interference applied on f_1 .
- b) Apply time-synchronized, pulsed interference on f_1 at the pulsed level $TL + UM$, verify that the EUT does not establish a connection when the width of the interference pulse exceeds the largest of $50 \mu s$ and $50 \sqrt{1.25/B} \mu s$, where B is the emission bandwidth of the EUT in megahertz.
- c) With the channel interference level 6 dB above $TL + UM$, verify that the EUT does not establish a connection when the width of the interference pulse exceeds the largest of $35 \mu s$ and $35 \sqrt{1.25/B} \mu s$, where B is the emission bandwidth of the EUT in megahertz.

Test Pulse width Equation (μs)	B(bandwidth) (MHz)	Pulse width (μs)	Limit (largest) (μs)
$50 (1.25/B)^{1/2}$	1.476	46.01	50
$35 (1.25/B)^{1/2}$	1.476	32.21	35

Test result:

1) Monitoring Bandwidth:

The antenna of the EUT used for monitoring is the same interior antenna that used for transmission, so the monitoring system bandwidth is equal to the emission bandwidth of the intended transmission

2) Reaction Time Test:

No.	Interference Pulse width (μs)	Reaction of EUT	Observing time (μs)	Result
1	$50 \mu s$ with level $T_L + U_M$	No transmission	46.52	Pass
2	$35 \mu s$ with level $T_L + U_M + 6dB$	No transmission	32.97	Pass

9) Monitoring Antenna, FCC §15.323(c) (8)

The monitoring system shall use the same antenna used for transmission, or an antenna that yields equivalent reception at that location.

Test procedure:

Measurement method according to ANSI C63.17 2013 paragraph 4

Test result:

The antenna of the EUT used for transmission is the same interior antenna that used for monitoring.

10) Monitoring threshold relaxation, FCC §15.323(c) (9)

Devices that have a power output lower than the maximum permitted under the rules can increase their monitoring detection threshold by one decibel for each one decibel that the transmitter power is below the maximum permitted.

Test procedure:

Measurement method according to ANSI C63.17 2013 paragraph 4

Test result:

This requirement is covered by the results of Least Interfered Channel (LIC) based on FCC §15.323(c)(5).

11) Duplex Connections, FCC §15.323(c) (10)

An initiating device may attempt to establish a duplex connection by monitors both its intended transmit and receive time and spectrum windows. If both the intended transmit and receive time and spectrum windows meet the access criteria, then the initiating device can initiate a transmission in the intended transmit time and spectrum window. If the power detected by the responding device can be decoded as a duplex connection signal from the initiating device, then the responding device may immediately begin transmitting on the receive time and spectrum window monitored by the initiating device.

Test procedure:

This test validates proper operation of an EUT that operates according to the provisions of FCC §15.323(c)(10) using a check of both transmit and receive channels on one end of the link to qualify both ends of the link for transmissions. Test method according to ANSI C63.17 clause 8.3.2 Validation of dual access criteria check for EUTs that implement the upper threshold

- a) Adjust the path loss between the EUT and its companion device such that the received signal to the EUT from the companion device is at least 40 dB above $TL + UM$.
- b) Restrict the EUT and its companion device to operation at a single carrier f_1 for TDMA systems and on f_1 and f_2 and corresponding duplex carriers for FDMA systems. Verify that the EUT and its companion device can establish a connection on a time/spectrum window on the enabled carrier(s). Terminate the connection.
- c) Apply interference to the EUT on the EUT's *transmit* time/spectrum windows at $TL + UM$ per carrier on all time/spectrum windows except for one, which has interference at least 10 dB below TL . Adjust the interference to the EUT on its *receive* time/spectrum windows such that a single time/spectrum window has interference at least 10 dB below TL , and the interference on the other time/spectrum windows is at $TL + UM + 7$ dB. The interference to the companion device should be at least 10 dB below TL on all active time/spectrum windows. The interference-free *receive* time/spectrum window must not be the duplex mate of the interference-free *transmit* time/spectrum window.
- d) Cause the EUT to attempt to establish a connection. The connection should be made on the interference-free *receive* time/spectrum window and its duplex mate. Otherwise, the EUT fails the test.
- e) If a connection exists, terminate it. Reduce the interference on the EUT's *receive* time/spectrum windows to a level of $TL + UM$ per carrier on all time/spectrum windows except for one, which has interference at least 10 dB below TL . Raise the interference on the EUT's *transmit* time/spectrum windows to a level of $TL + UM + 7$ dB, maintaining one time/spectrum window with interference at least 10 dB below TL . The interference to the companion device should be at least 10 dB below TL on

all active time/spectrum windows. Again, the interference-free *transmit* and *receive* time/spectrum windows should not constitute a duplex pair if the system designates a specific duplex pairing for time/spectrum windows.

- f) Cause the EUT to attempt to establish a connection. The connection should be made on the interference-free *transmit* time/spectrum window and its duplex mate. Otherwise, the system fails the test.

Test result:

Interference (Refer to ANSI C63.17 § 8.3.2)	Reaction of EUT	Results
a) Only a single carrier f_1 for EUT TDMA systems and on f_1 and f_2 and corresponding duplex carriers for FDMA systems.	EUT can transmit	Pass
b) All Tx windows with level TL+UM except one & Rx windows with level TL+UM+7dB except one, which are not the duplex mate.	Connected on the target Rx window and its duplex mate.	Pass
c) All Tx windows with level TL+UM+7dB except one & Rx windows with level TL+UM except one, which are not duplex mate.	Connected on the target Tx window and its duplex mate.	Pass
d) All Tx & Rx windows with level TU+UM, except one for Tx window & one for Rx window, which are not duplex mate.	No connection possible	Pass

12) Alternative monitoring interval, FCC §15.323(c) (11)

An initiating device that is prevented from monitoring during its intended transmit window due to monitoring system blocking from the transmissions of a co-located (within one meter) transmitter of the same system, may monitor the portions of the time and spectrum windows in which they intend to receive over a period of at least 10 milliseconds. The monitored time and spectrum window must total at least 50 percent of the 10 millisecond frame interval and the monitored spectrum must be within 1.25 MHz of the center frequency of channel(s) already occupied by that device or co-located co-operating devices. If the access criteria is met for the intended receive time and spectrum window under the above conditions, then transmission in the intended transmit window by the initiating device may commence.

Test procedure:

This test validates the ability of the EUT to distinguish between same-system and other-system interference for purposes of satisfying the requirement of 47CFR15.323(c) (11). Test method according to ANSI C63.17 2013 clause 8.4

- a) Adjust the path loss between the EUT and its companion device such that the received signal to the EUT from the companion device is at least 30 dB above *TL*.
- b) Restrict the EUT and its companion device to operation at a single carrier f_1 for TDMA systems and on f_1 and f_2 and corresponding duplex carriers for FDMA systems. Verify that the EUT and its companion device can establish a connection.
- c) Apply interference at $TL + UM$ per carrier to the EUT on all *transmit* time/spectrum windows on the enabled carrier(s). The interference must use the same physical layer parameters (modulation, frame format, etc.) as the EUT transmissions, but with a system identifier different from that used by the EUT and the companion device. Ensure that the interference level at the companion device is at least 10 dB below *TL*. Apply no interference to the *receive* time/spectrum windows on the enabled carriers.
- d) Cause the EUT to attempt to establish a connection. If a connection is established, the test fails.

Test result:

Interference (Refer to ANSI C63.17 § 8.4)	Reaction of EUT	Results
a) Only a single carrier f_1 for EUT TDMA systems and on f_1 and f_2 and corresponding duplex carriers for FDMA systems.	EUT can transmit	Pass
b) Apply interference with same parameters as EUT transmissions on all Tx windows with level TL+UM on the enabled carrier(s) and no interference on the Rx windows on the enabled carriers.	No connection is established	Pass

13) Fair Access, FCC §15.323(c) (12)

The provisions of FCC §15.323 (c) (10) or (11) shall not be used to extend the range of spectrum occupied over space or time for the purpose of denying fair access to spectrum to other devices.

Test result:

The manufacturer declares that this device does not use any mechanisms as provided by FCC §15.323(c)(10) or (11) to extend the range of spectrum occupied over space or time for the purpose of denying fair access to spectrum to other device.

14) Frame Repetition Stability Frame Period and Jitter, FCC§15.323 (e)

The frame period (a set of consecutive time slots in which the position of each time slot can be identified by reference to a synchronizing source) of an intentional radiator operating in these sub-bands shall be 20 milliseconds or 10 milliseconds/X where X is a positive whole number. Each device that implements time division for the purposes of maintaining a duplex connection on a given frequency carrier shall maintain a frame repetition rate with a frequency stability of at least 50 parts per million (ppm). Each device which further divides access in time in order to support multiple communication links on a given frequency carrier shall maintain a frame repetition rate with a frequency stability of at least 10 ppm. The jitter (time-related, abrupt, spurious variations in the duration of the frame interval) introduced at the two ends of such a communication link shall not exceed 25 microseconds for any two consecutive transmissions. Transmissions shall be continuous in every time and spectrum window during the frame period defined for the device.

Test procedure:

Measurement method according to ANSI C63.17- 2013 clause 6.2.2, 6.2.3

Test result:

Frame Period and Jitter:

Max. pos. Jitter (µs)	Max. neg. Jitter (µs)	Frame period (ms)	Limit	
			Frame Period (ms)	Jitter (µs)
0.07	-0.04	10.22	20 or 10/X	25

Note: X is a positive whole number.

EUT PHOTOGRAPHS

Please refer to the attachment SZ1231226-78524E-RF External photo and SZ1231226-78524E-RF Internal photo.

TEST SETUP PHOTOGRAPHS

Please refer to the attachment SZ1231226-78524E-RFB Test Setup photo.

******* END OF REPORT *******