

Model: CS6529 Base Antenna 0**Antenna description:**

This wire Monopole antenna is optimized and used in the Base unit. This antenna is directly soldered to the ANT_0 RF output in the main PCB.

Model Number	Description
CS6529 BS ANT_0	1.9GHz Monopole

Specification:

Operation Frequency Range	1921.536 to 1928.448 MHz
Maximum Gain	0 dBi
Type	Monopole
Operation bandwidth	70MHz
Nominal Impedance	~50 ohms
Manufacturer	Vtech Telecommunications Ltd
Manufacturer address	23/F, Tai Ping Industrial Centre, Blk1, 57 Ting Kok Road, Tai Po, Hong Kong
Model number	ANT-CS6529-F-DE-0

*NOTE: Frequency and Orientation with maximum Antenna Gain.

Frequency: 1924.992 MHz

	Vertical	Horizontal
Antenna Gain (dBi)	-2.65	0.00

CS6529 BS ANT0 Radiation Pattern_XY Plane

◆ Vertical
■ Horizontal

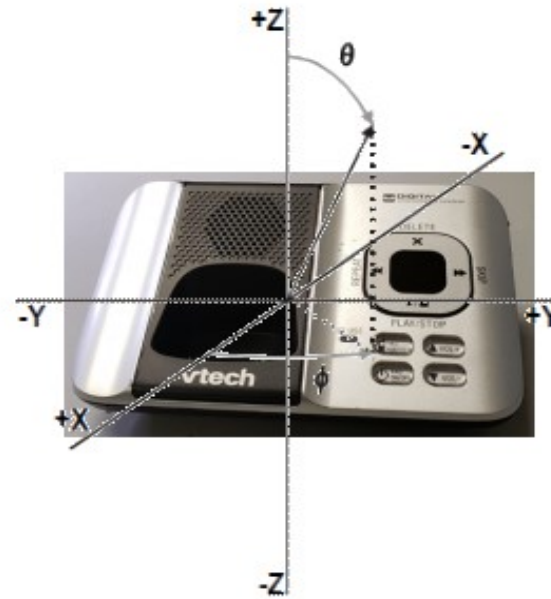
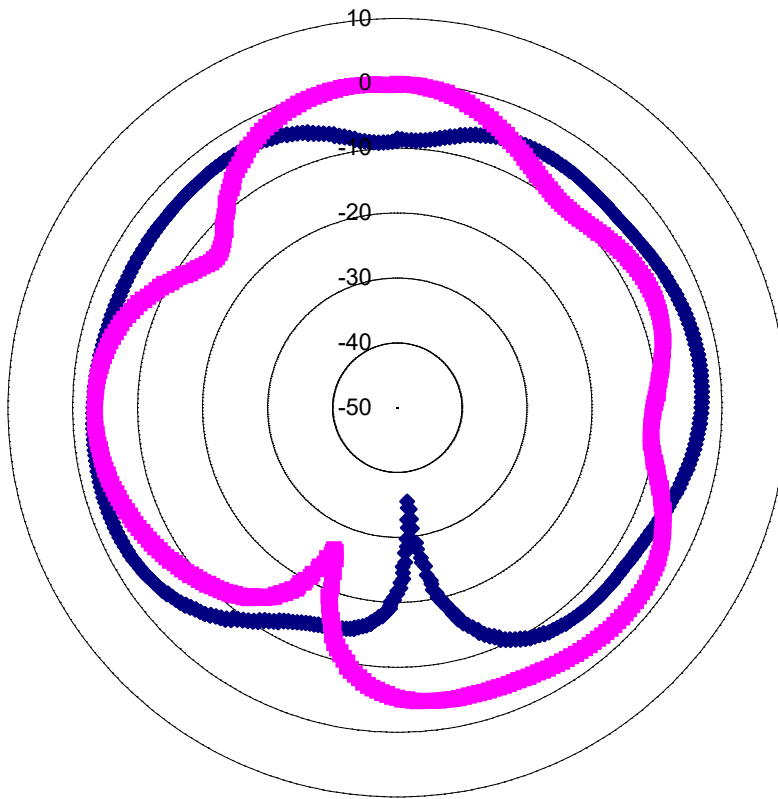

CS6529 BS ANT0 Antenna Dimensions in mm

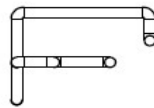
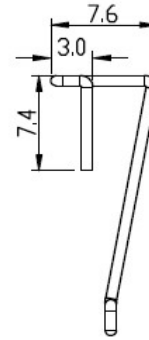
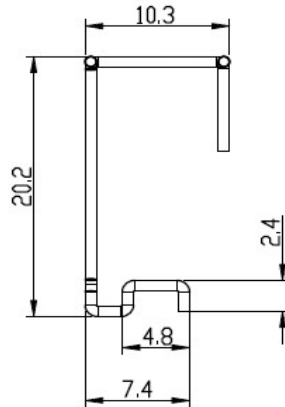
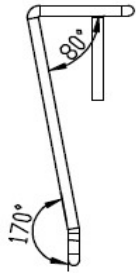
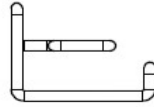

Model: CS6529 Base Antenna 1

Antenna description:

This wire Monopole antenna is optimized and used in the Base unit. This antenna is directly soldered to the ANT_1 RF output in the main PCB.

Model Number	Description
CS6529 BS ANT_1	1.9GHz Monopole

Specification:

Operation Frequency Range	1921.536 to 1928.448 MHz
Maximum Gain	0 dBi
Type	Monopole
Operation bandwidth	70MHz
Nominal Impedance	~50 ohms
Manufacturer	Vtech Telecommunications Ltd
Manufacturer address	23/F, Tai Ping Industrial Centre, Blk1, 57 Ting Kok Road, Tai Po, Hong Kong
Model number	ANT-CS6529-F-DE-1

*NOTE: Frequency and Orientation with maximum Antenna Gain.

Frequency: 1924.992 MHz

	Vertical	Horizontal
Antenna Gain (dBi)	-1.63	0.00

CS6529 BS ANT1 Radiation Pattern_XY Plane

◆ Vertical
■ Horizontal

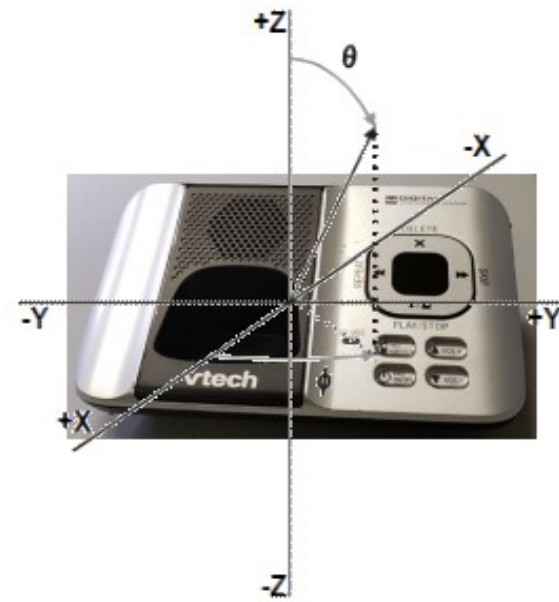
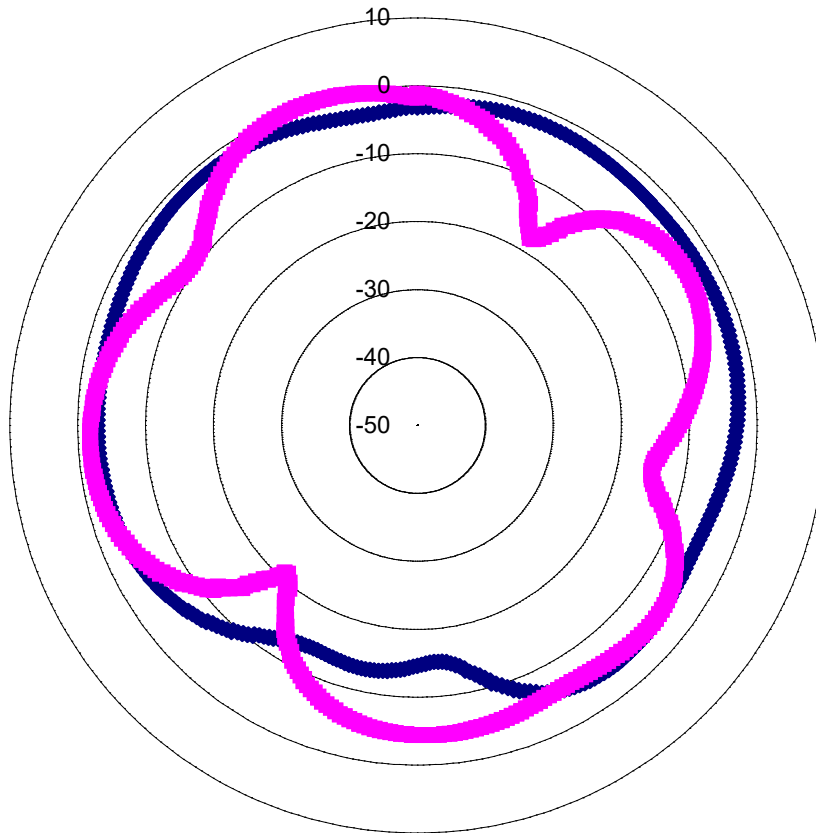

CS6529 BS ANT1 Antenna Dimensions in mm

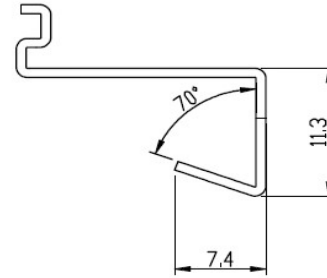
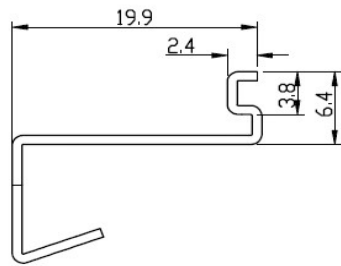
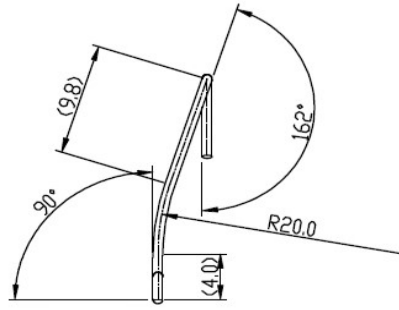

Model: CS6529 Base Bluetooth Antenna

Antenna description:

This printed F antenna is optimized and used in the Base unit. This antenna is directly soldered to the Bluetooth RF output in the main PCB.

Model Number	Description
CS6529 BS BT ANT	2.4GHz Printed F Antenna

Specification:

Operation Frequency Range	2402 to 2480 MHz
Maximum Gain	0 dBi
Type	Printed F Antenna
Operation bandwidth	90MHz
Nominal Impedance	~50 ohms
Manufacturer	Vtech Telecommunications Ltd
Manufacturer address	23/F, Tai Ping Industrial Centre, Blk1, 57 Ting Kok Road, Tai Po, Hong Kong
Model number	ANT-CS6529-F-BT-0

*NOTE: Frequency and Orientation with maximum Antenna Gain.

Frequency: 2440MHz

	Vertical	Horizontal
Antenna Gain (dBi)	-6.26	0.00

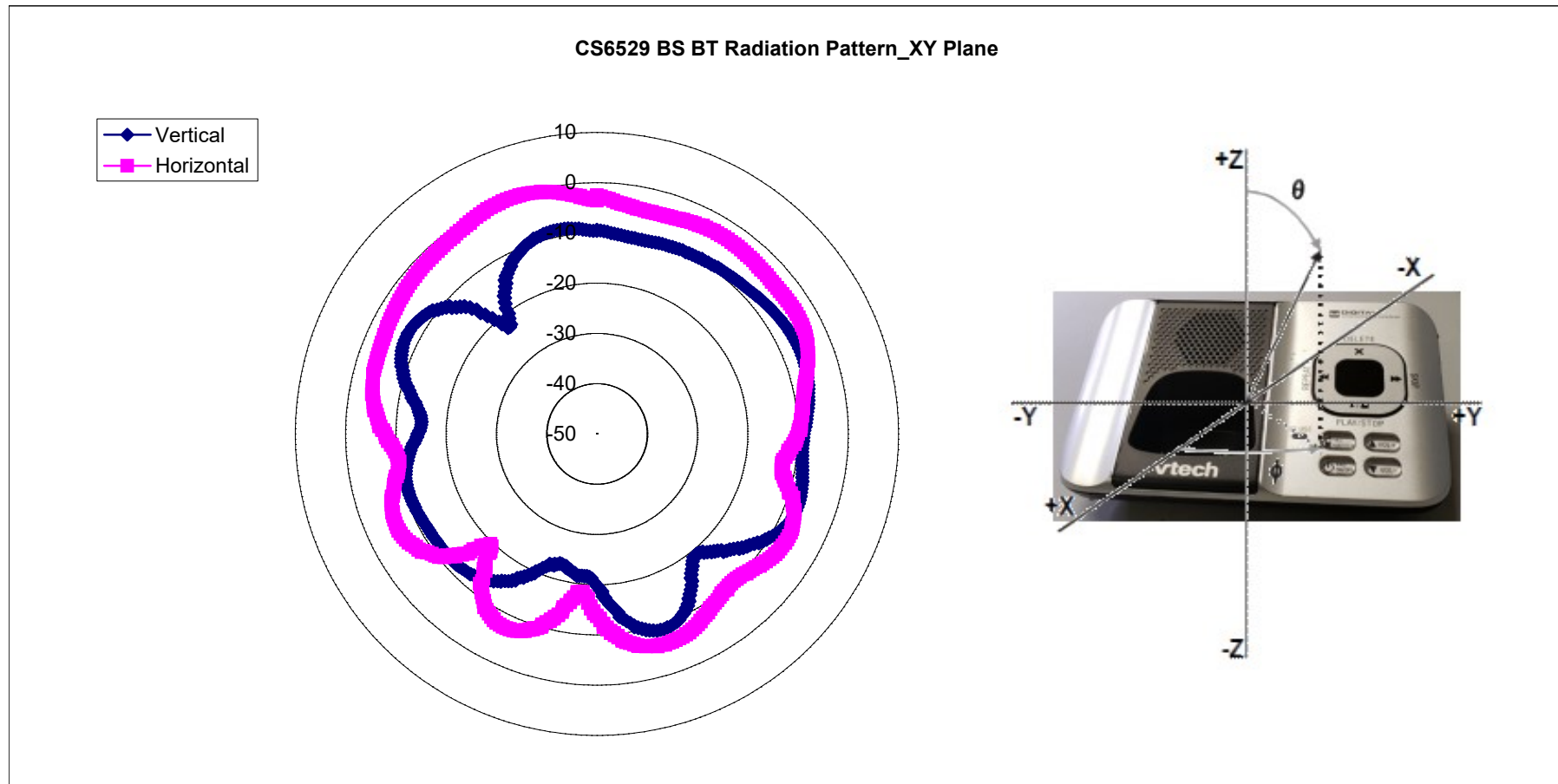

CS6529 BS BT Antenna Dimensions in mm

