

Issuing Laboratory:  
Intertek Testing Services Hong Kong Limited

Hong Kong Accreditation Service (HKAS) has accredited this laboratory under the Hong Kong Laboratory Accreditation Scheme (HOKLAS) for specific laboratory activities as listed in the HOKLAS directory of accredited laboratories. The results shown in this report were determined by this laboratory in accordance with its terms of accreditation.



## TEST REPORT

**Report Number: 13070800HKG-001**

Application  
For  
Original Grant of 47 CFR Part 15 Certification  
New Family of RSS-213 Issue 2 Equipment Certification

Unlicensed Personal Communication Service Devices/  
2 GHz License-exempt Personal Communications Service Devices  
(Deskset)

**FCC ID: EW780-8479-00**

**IC: 1135B-80847900**

Prepared and Checked by:

A handwritten signature in black ink, appearing to read 'Benny Lau', written over a horizontal line.

Lau Chi Yu, Benny  
Lead Engineer

Approved by:

A handwritten signature in black ink, appearing to read 'Melvin Nip', written over a horizontal line.

Nip Ming Fung, Melvin  
Assistant Manager  
September 10, 2013

- The test report only allows to be revised within the retention period unless further standard or the requirement was noticed.
- This report is for the exclusive use of Intertek's Client and is provided pursuant to the agreement between Intertek and its Client. Intertek's responsibility and liability are limited to the terms and conditions of the agreement. Intertek assumes no liability to any party, other than to the Client in accordance with the agreement, for any loss, expense or damage occasioned by the use of this report. Only the Client is authorized to permit copying or distribution of this report and then only in its entirety. Any use of the Intertek name or one of its marks for the sale or advertisement of the tested material, product or service must first be approved in writing by Intertek. The observations and test results in this report are relevant only to the sample tested. This report by itself does not imply that the material, product, or service is or has ever been under an Intertek certification program.

**Intertek Testing Services Hong Kong Ltd.**

2/F., Garment Centre, 576 Castle Peak Road, Kowloon, Hong Kong.  
Tel: (852) 2173 8888 Fax: (852) 2785 5487 Website: [www.hk.intertek-etlsemko.com](http://www.hk.intertek-etlsemko.com)

Issuing Laboratory:  
Intertek Testing Services Hong Kong Limited

Hong Kong Accreditation Service (HKAS) has accredited this laboratory under the Hong Kong Laboratory Accreditation Scheme (HOKLAS) for specific laboratory activities as listed in the HOKLAS directory of accredited laboratories. The results shown in this report were determined by this laboratory in accordance with its terms of accreditation.



## GENERAL INFORMATION

<b>VTech Telecommunications Ltd.:</b>	VTech Telecommunications Ltd.
<b>Applicant Address:</b>	23/F., Tai Ping Industrial Centre, Block 1, 57 Ting Kok Road, Tai Po, Hong Kong.
<b>FCC Specification Standard:</b>	FCC Part 15, October 1, 2011 Edition and 77 FR 43013, July 23, 2012
<b>FCC ID:</b>	EW780-8479-00
<b>FCC Model(s):</b>	SB35025, SB67025
<b>IC Specification Standard:</b>	RSS-213 Issue 2, December 2005 RSS-Gen Issue 3, December 2010
<b>IC:</b>	1135B-80847900
<b>IC Model(s):</b>	SB35025, SB67025
<b>Type of EUT:</b>	Unlicensed Personal Communications Service Devices
<b>Description of EUT:</b>	1.9Hz DECT Deskset
<b>Serial Number:</b>	N/A
<b>Sample Receipt Date:</b>	July 17, 2013
<b>Date of Test:</b>	August 6, 2013 to August 9, 2013
<b>Report Date:</b>	September 10, 2013
<b>Environmental Conditions:</b>	Temperature: +10 to 40°C Humidity: 10 to 90%

## Table of Contents

<b>1.0 Test Results Summary &amp; Statement of Compliance</b> .....	5
1.1 Summary of Test Results .....	5
1.2 Statement of Compliance .....	6
<b>2.0 General Description</b> .....	8
2.1 Product Description .....	8
2.2 Technical Description .....	8
2.3 Test Methodology .....	9
2.4 Test Facility .....	9
<b>3.0 System Test Configuration</b> .....	11
3.1 Justification .....	11
3.2 Conducted Emission Test Configuration .....	13
3.3 Conducted Monitoring and Operational Test Configuration .....	13
3.4 EUT Exercising Software.....	13
3.5 Details of EUT and Description of Accessories .....	14
3.6 Measurement Uncertainty .....	14
<b>4.0 Measurement Results</b> .....	16
4.1 Antenna Requirement .....	16
4.2 Digital Modulation Techniques.....	16
4.3 Emission Bandwidth .....	17
4.4 Directional Gain of the Antenna .....	20
4.5 Peak Transmit Power .....	21
4.6 Power Spectral Density .....	24
4.7 Automatic Discontinuation of Transmission.....	27
4.8 Unwanted Emission Inside the Sub-Band .....	28
4.9 Emissions Outside the Sub-Band .....	32
4.9.1 Radiated Emissions Configuration Photographs .....	33
4.9.2 Radiated Emissions Data .....	33
4.9.3 Field Strength Calculation.....	37
4.9.4 Average Factor Calculation and Transmitter ON Time Measurements .....	38
4.10 AC Power Line Conducted Emissions .....	39
4.10.1 AC Power Line Conducted Emissions Configuration Photographs .....	40
4.10.2 AC Power Line Conducted Emissions Data .....	40
4.11 Frame Repetition Stability .....	44
4.12 Frame Period and Jitter .....	45
4.13 Carrier Frequency Stability .....	46
4.14 Monitoring Threshold.....	47
4.14.1 Lower Monitoring Threshold .....	48
4.14.2 Least Interfered Channel .....	49
4.14.2.1 Upper Monitoring Threshold .....	49
4.14.2.2 Least Interfered Channel (LIC) Selection .....	50
4.14.2.3 Least Interfered Channel (LIC) Confirmation.....	51

Issuing Laboratory:  
Intertek Testing Services Hong Kong Limited

Hong Kong Accreditation Service (HKAS) has accredited this laboratory under the Hong Kong Laboratory Accreditation Scheme (HOKLAS) for specific laboratory activities as listed in the HOKLAS directory of accredited laboratories. The results shown in this report were determined by this laboratory in accordance with its terms of accreditation.



## Table of Contents

4.14.2.4 Maximum Spectrum Occupance .....	51
4.15 Monitoring Time.....	52
4.16 Maximum Transmit Period.....	53
4.17 System Acknowledgement .....	54
4.18 Random Waiting.....	55
4.19 Monitoring Bandwidth .....	56
4.20 Maximum Reaction Time.....	57
4.21 Monitoring Antenna .....	57
4.22 Duplex Connections .....	58
4.23 Alternative Monitoring Interval for Co-located Device.....	60
4.24 Fair Access.....	60
<b>5.0 Equipment List .....</b>	<b>62</b>

Issuing Laboratory:  
**Intertek Testing Services Hong Kong Limited**

Hong Kong Accreditation Service (HKAS) has accredited this laboratory under the Hong Kong Laboratory Accreditation Scheme (HOKLAS) for specific laboratory activities as listed in the HOKLAS directory of accredited laboratories. The results shown in this report were determined by this laboratory in accordance with its terms of accreditation.



**EXHIBIT 1**  
**TEST RESULTS SUMMARY & STATEMENT OF COMPLIANCE**

Issuing Laboratory:  
Intertek Testing Services Hong Kong Limited

Hong Kong Accreditation Service (HKAS) has accredited this laboratory under the Hong Kong Laboratory Accreditation Scheme (HOKLAS) for specific laboratory activities as listed in the HOKLAS directory of accredited laboratories. The results shown in this report were determined by this laboratory in accordance with its terms of accreditation.



1.0 **Test Results Summary & Statement of Compliance**

1.1 Summary of Test Results

<b>General Technical Requirements</b>					
<b>Test Items</b>	<b>RSS-213 / RSS-Gen<sup>#</sup> Clause</b>	<b>FCC Part 15 Section</b>	<b>Test Procedure ANSI C63.17 / ANSI C63.4<sup>*</sup></b>	<b>Results</b>	<b>Details see section</b>
Antenna Requirement	7.1.2 <sup>#</sup>	15.317	---	Pass	4.1
Digital Modulation Techniques	6.1	15.319(b)	6.1.4	Pass	4.2
Occupied/Emission Bandwidth	6.4	15.323(a)	6.1.3	Pass	4.3
Directional Gain of the Antenna	4.1(e)	15.319(e)	4.3.1	Pass	4.4
Peak Transmit Power	6.5	15.319(c)	6.1.2	Pass	4.5
Power Spectral Density	6.6	15.319(d)	6.1.5	Pass	4.6
Automatic Discontinuation of Transmission	4.3.4(a)	15.319(f)	---	Pass	4.7
AC Power Line Conducted Emissions from EUT	6.3	15.315	7 <sup>*</sup>	Pass	4.10

## 1.1 Summary of Test Results (continued)

<b>Specific Requirements for UPCS Device</b>					
<b>Test Items</b>	<b>RSS-213 Clause</b>	<b>FCC Part 15 Section</b>	<b>Test Procedure ANSI C63.17</b>	<b>Results</b>	<b>Details see section</b>
Unwanted Emission Inside the Sub-Band	6.7.2	15.323(d)	6.1.6.1	Pass	4.8
Emissions Outside the Sub-Band	6.7.1	15.323(d)	6.1.6.2	Pass	4.9
Frame Repetition Stability	4.3.4(c)	15.323(e)	6.2.2	Pass	4.11
Frame Period and Jitter	4.3.4(c)	15.323(e)	6.2.3	Pass	4.12
Carrier Frequency Stability	6.2	15.323(f)	6.2.1	Pass	4.13
Lower Monitoring Threshold	4.3.4(b2&b9)	15.323(c2&c9)	7.3.1	NA	4.14.1
Upper Monitoring Threshold	4.3.4(c5&c9)	15.323(c5.1&c9)	7.3.2	Pass	4.14.2.1
Least Interfered Channel (LIC) Selection	4.3.4(b5)	15.323(c)(5)	7.3.3	Pass	4.14.2.2
Least Interfered Channel (LIC) Confirmation	4.3.4(b5)	15.323(c)(5)	7.3.3	Pass	4.14.2.3
Maximum Spectrum Occupancy	4.3.4(b5)	15.323(c)(5)	---	Pass	4.14.2.4
Monitoring Time	4.3.4(b1)	15.323(c)(1)	7.3.4	Pass	4.15
Maximum Transmit Period	4.3.4(b3)	15.323(c)(3)	---	Pass	4.16
System Acknowledgement	4.3.4(b4)	15.323(c4)	8.1 or 8.2	Pass	4.17
Random Waiting	4.3.4(b6)	15.323(c)(6)	8.1.2 or 8.1.3	NA	4.18
Monitoring Bandwidth	4.3.4(b7)	15.323(c)(7)	7.4	Pass	4.19
Maximum Reaction Time	4.3.4(b7)	15.323(c)(7)	7.5	Pass	4.20
Monitoring Antenna	4.3.4(b8)	15.323(c)(8)	4	Pass	4.21
Duplex Connections	4.3.4(b10)	15.323(c)(10)	8.3	NA	4.22
Alternative Monitoring Interval for Co-located Device	4.3.4(b11)	15.323(c)(11)	8.4	NA	4.23
Fair Access	4.3.4(b12)	15.323(c)(12)	---	Pass	4.24

## 1.2 Statement of Compliance

The equipment under test is found to be complying with the following standards:

FCC Part 15, October 1, 2011 Edition and 77 FR 43013, July 23, 2012  
 RSS-213 Issue 2, December 2005  
 RSS-Gen Issue 3, December 2010

Issuing Laboratory:  
**Intertek Testing Services Hong Kong Limited**

Hong Kong Accreditation Service (HKAS) has accredited this laboratory under the Hong Kong Laboratory Accreditation Scheme (HOKLAS) for specific laboratory activities as listed in the HOKLAS directory of accredited laboratories. The results shown in this report were determined by this laboratory in accordance with its terms of accreditation.



**EXHIBIT 2**  
**GENERAL DESCRIPTION**



Issuing Laboratory:  
Intertek Testing Services Hong Kong Limited

Hong Kong Accreditation Service (HKAS) has accredited this laboratory under the Hong Kong Laboratory Accreditation Scheme (HOKLAS) for specific laboratory activities as listed in the HOKLAS directory of accredited laboratories. The results shown in this report were determined by this laboratory in accordance with its terms of accreditation.



## 2.0 General Description

### 2.1 Product Description

The SB35025 is a 1.9GHz DECT Deskset. It operates at frequency range of 1921.536MHz to 1928.448MHz with 5 channels (1921.536MHz, 1923.264MHz, 1924.992MHz, 1926.720MHz and 1928.448MHz). The Base Unit is powered by an adaptor 100-240VAC to 5.1VDC 1700mA and/or powered over Ethernet.

The antenna used in Deskset is integral, and the test sample is a prototype.

For FCC, the Model(s): SB67025 is the same as model SB35025 in electronics/electrical designs, including firmware, PCB layout and construction design/physical design/enclosure. The only differences between these models are cosmetic details, model number and no “audio jack” in rear case, “Music and Hold” and “External overhead paging” feature for model SB67025; software and main machine interface is difference from SB35025, just because of “audio jack”, “Music and Hold” and “External overhead paging” feature only to be sold for marketing purpose.

For IC, the Model(s): SB67025 is the same as model SB35025 in electronics/electrical designs, including firmware, PCB layout and construction design/physical design/enclosure. The only differences between these models are cosmetic details, model number and no “audio jack” in rear case, “Music and Hold” and “External overhead paging” feature for model SB67025; software and main machine interface is difference from SB35025, just because of “audio jack”, “Music and Hold” and “External overhead paging” feature only to be sold for marketing purpose.

### 2.2 Technical Description

The circuit description and digital modulation techniques description are saved with filename: descri.pdf.

Issuing Laboratory:  
Intertek Testing Services Hong Kong Limited

Hong Kong Accreditation Service (HKAS) has accredited this laboratory under the Hong Kong Laboratory Accreditation Scheme (HOKLAS) for specific laboratory activities as listed in the HOKLAS directory of accredited laboratories. The results shown in this report were determined by this laboratory in accordance with its terms of accreditation.



### 2.3 Test Methodology

The radiated emission measurements for unintentional radiator (if any) and AC power line-conducted emission measurements were performed according to the test procedures specified in ANSI C63.4 (2009). The radiated emission measurements for intentional radiator contained in UPCS device, conducted emission measurements, Listen Before Transmit (LBT) tests, Time Frame and Frequency Stability tests were performed according to the test procedures specified in ANSI C63.17 (2006). All radiated measurements were performed in Open Area Test Sites. Preliminary scans were performed in the Open Area Test Sites only to determine worst case modes. All radiated tests were performed at an antenna to EUT distance of 3 meters, unless stated otherwise in the "Justification Section" of this Application. All other measurements were made in accordance with the procedures in 47 CFR Part 2 / RSS-Gen Issue 3 (2010).

### 2.4 Test Facility

The open area test site, AC power line conducted measurement facility and antenna port conducted measurement facility used to collect the radiated data, AC Power Line conducted data, and conductive data are at Rooftop, 2<sup>nd</sup> Floor and 5<sup>th</sup> Floor respectively of Intertek Testing Services Hong Kong Ltd., which is located at Garment Centre, 576 Castle Peak Road, Kowloon, Hong Kong. This test facility and site measurement data have been fully placed on file with FCC and Industry Canada.

Issuing Laboratory:  
**Intertek Testing Services Hong Kong Limited**

Hong Kong Accreditation Service (HKAS) has accredited this laboratory under the Hong Kong Laboratory Accreditation Scheme (HOKLAS) for specific laboratory activities as listed in the HOKLAS directory of accredited laboratories. The results shown in this report were determined by this laboratory in accordance with its terms of accreditation.



**EXHIBIT 3**  
**SYSTEM TEST CONFIGURATION**

Issuing Laboratory:  
Intertek Testing Services Hong Kong Limited

Hong Kong Accreditation Service (HKAS) has accredited this laboratory under the Hong Kong Laboratory Accreditation Scheme (HOKLAS) for specific laboratory activities as listed in the HOKLAS directory of accredited laboratories. The results shown in this report were determined by this laboratory in accordance with its terms of accreditation.



### 3.0 **System Test Configuration**

#### 3.1 Justification

For emissions testing, the equipment under test (EUT) was set up to transmit continuously in burst mode with pseudo-random data to simplify the measurement methodology. Care was taken to ensure proper power supply voltages during testing. During testing, all cables (if any) were manipulated to produce worst-case emissions.

The EUT was powered by a 100-240VAC to 5.1VDC 1700mA adaptor and/or powered over Ethernet.

For the measurements, the EUT was attached to a plastic stand if necessary and placed on the wooden turntable. If the EUT is attached to accessories, they were connected and operational (as typical as possible).

The signal was maximized through rotation and placement in the three orthogonal axes. The antenna height and polarization were varied during the search for maximum signal level. The antenna height was varied from 1 to 4 meters. Detector function was in peak mode. Radiated emissions are taken at three meters unless the signal level was too low for measurement at that distance. If necessary, a pre-amplifier was used and/or the test was conducted at a closer distance.

For UPCS transmitter radiated measurement, the spectrum analyzer resolution bandwidth was approximately 1% of EUT emission bandwidth, unless otherwise specified.

Radiated emission measurements for UPCS transmitter were performed from the lowest radio frequency signal generated in the device which is greater than 9 kHz to the tenth harmonic of the highest fundamental frequency or to 40 GHz, whichever is lower.

RF modules of Deskset Model SB35025 and SB67025 are identical. Their only different were minor changes on baseband circuit and software due to product features purposes. Both Desksets have been tested and checked. The radiated emission measurement and conducted emission measurement presented in this test report was the worst-case.

As the deskset unit has 2 antennas, both have been checked. While conducting the test on one of antennas, another one was being disable its transmission. The data in this report represented the worst-case.

The Deskset can power by Power adaptor and/or powered over Ethernet, both cases have been checked. The data in this report represented the worst-case.

Issuing Laboratory:  
**Intertek Testing Services Hong Kong Limited**

Hong Kong Accreditation Service (HKAS) has accredited this laboratory under the Hong Kong Laboratory Accreditation Scheme (HOKLAS) for specific laboratory activities as listed in the HOKLAS directory of accredited laboratories. The results shown in this report were determined by this laboratory in accordance with its terms of accreditation.



For AC line conducted emission test, the EUT along with its peripherals were placed on a 1.0m(W)x1.5m(L) and 0.8m in height wooden table and the EUT was adjusted to maintain a 0.4 meter space from a vertical reference plane. The EUT was connected to power mains through a line impedance stabilization network (LISN), which provided 50ohm coupling impedance for measuring instrument. The LISN housing, measuring instrument case, reference ground plane, and vertical ground plane were bounded together. The excess power cable between the EUT and the LISN was bundled.

All connecting cables of EUT and peripherals were manipulated to find the maximum emission.

### 3.2 Conducted Emission Test Configuration

The setup and equipment setting were made in accordance with ANSI C63.17. The antenna of EUT transmitter was replaced by a coaxial cable. The impedance matching of connection, cable loss and external RF attenuator are taken into account. The EUT was arranged to communicate via a fixed carrier frequency between its transmitter and a companion device. The transmission was configured in burst mode with pseudo-random data as typical as normal operation.

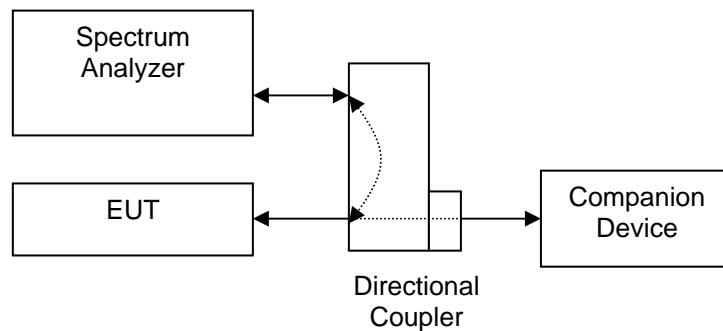

Figure 3.2.1

### 3.3 Conducted Monitoring and Operation Test Configuration

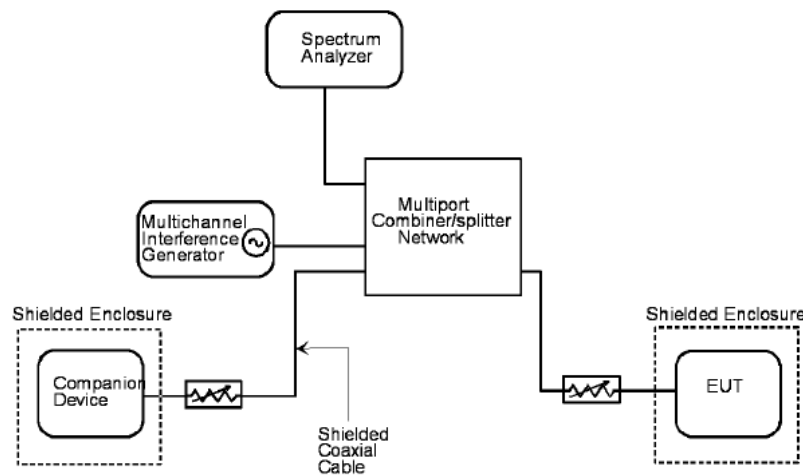

Figure 3.3.1

### 3.4 EUT Exercising Software

The EUT exercise program (if any) used during radiated and conducted testing was designed to exercise the various system components in a manner similar to a typical use.

Issuing Laboratory:  
Intertek Testing Services Hong Kong Limited

Hong Kong Accreditation Service (HKAS) has accredited this laboratory under the Hong Kong Laboratory Accreditation Scheme (HOKLAS) for specific laboratory activities as listed in the HOKLAS directory of accredited laboratories. The results shown in this report were determined by this laboratory in accordance with its terms of accreditation.



### 3.5 Details of EUT and Description of Accessories

#### Details of EUT:

An AC adaptor (provided with the unit) were used to power the device. Their descriptions are listed below.

- (1) An AC adaptor (100-240VAC to 5.1VDC 1700mA, Model: S012BU0510200, Brand: Ten Pao) (Supplied by Client)

#### Description of Accessories:

- (1) Buffalo Broad Band Router, Model: BBR-4HG, DoC Product(Supplied by Intertek)
- (2) HP Notebook, Model: CPQNC2400, S/N: CNF638276D, DoC Product (Supplied by Intertek)
- (3) Smart-Drive External Hard Disk, Model: HD3-SU2FW, S/N: 0800261, DoC Product (Supplied by Intertek)
- (4) TP-Link PoE Injector, Model: TL-POE150S, DoC Product (Supplied by Intertek)
- (5) Samsung MP3 Player, Model: YP-Z5F, DoC Product (Supplied by Intertek)
- (6) Telephone Headset with 1.1m long (Supplied by Client)
- (7) Cordless Headset, Model: TL7810, FCC ID: EW780-8523-01 (Supplied by Client)
- (8) 1 x USB Cable & 1394 with 1 meter long (Supplied by Client)
- (9) 2 x CAT5 LAN unshielded Cable with 1 meter long (Supplied by Client)

### 3.6 Measurement Uncertainty

When determining of the test conclusion, the Measurement Uncertainty of test has been considered.

Uncertainty and Compliance – Unless the standard specifically states that measured values are to be extended by the measurement uncertainty in determining compliance, all compliance determinations are based on the actual measured value.

Issuing Laboratory:  
**Intertek Testing Services Hong Kong Limited**

Hong Kong Accreditation Service (HKAS) has accredited this laboratory under the Hong Kong Laboratory Accreditation Scheme (HOKLAS) for specific laboratory activities as listed in the HOKLAS directory of accredited laboratories. The results shown in this report were determined by this laboratory in accordance with its terms of accreditation.



**EXHIBIT 4**  
**TEST RESULTS**



Issuing Laboratory:  
Intertek Testing Services Hong Kong Limited

Hong Kong Accreditation Service (HKAS) has accredited this laboratory under the Hong Kong Laboratory Accreditation Scheme (HOKLAS) for specific laboratory activities as listed in the HOKLAS directory of accredited laboratories. The results shown in this report were determined by this laboratory in accordance with its terms of accreditation.



#### 4.0 Measurement Results

##### 4.1 Antenna Requirement, FCC Rule 15.317 / RSS-Gen Clause 7.1.2:

EUT must meet the antenna requirement of FCC Rule 15.203 / RSS-Gen Clause 7.1.2.

- [ × ] EUT uses permanently attached antenna(s) which is considered sufficient to comply with the provisions of this rule. Please refer to internal photos.pdf for more details.
  
- [ ] EUT uses unique antenna jack(s) or electrical connector(s) which is considered sufficient to comply with the provisions of this rule. Please refer to internal photos.pdf for more details.

##### 4.2 Digital Modulation Techniques, FCC Rule 15.319(b) / RSS-213 Clause 6.1:

All transmissions must use only digital modulation techniques.

The requirements are made in accordance with ANSI C63.17 sub-clause 6.1.4.

Attestation:

Please refer to the technical description(descr.pdf) or relevant DECT standards for more details.

Issuing Laboratory:  
Intertek Testing Services Hong Kong Limited

Hong Kong Accreditation Service (HKAS) has accredited this laboratory under the Hong Kong Laboratory Accreditation Scheme (HOKLAS) for specific laboratory activities as listed in the HOKLAS directory of accredited laboratories. The results shown in this report were determined by this laboratory in accordance with its terms of accreditation.



4.3 Emission Bandwidth, FCC Rule 15.323(a) /  
Occupied Bandwidth, RSS-213 Clause 6.4:

Operation shall be contained within the 1920 – 1930 MHz band. The emission bandwidth ( $B$ ) shall be less than 2.5 MHz and greater than 50 kHz.

Measurements are made in accordance with ANSI C63.17 sub-clause 6.1.3 and RSS-Gen clause 4.6.1. Test setup is shown in section 3.2 Figure 3.2.1.

Test Results:

I. Traffic Carrier

Channel	Channel Frequency (MHz)	Measuring Signal Level	Measured Emission Bandwidth (MHz)	Results
Lowest	1921.536	26 dB down	1.50	Pass
Middle	1924.992	99% Bandwidth	1.22	Pass
Highest	1928.448	26 dB down	1.50	Pass

The plots of emission bandwidth and occupied bandwidth are saved as below.

## Plots of emission bandwidth (FCC)

Base unit, Lowest channel, Traffic carrier

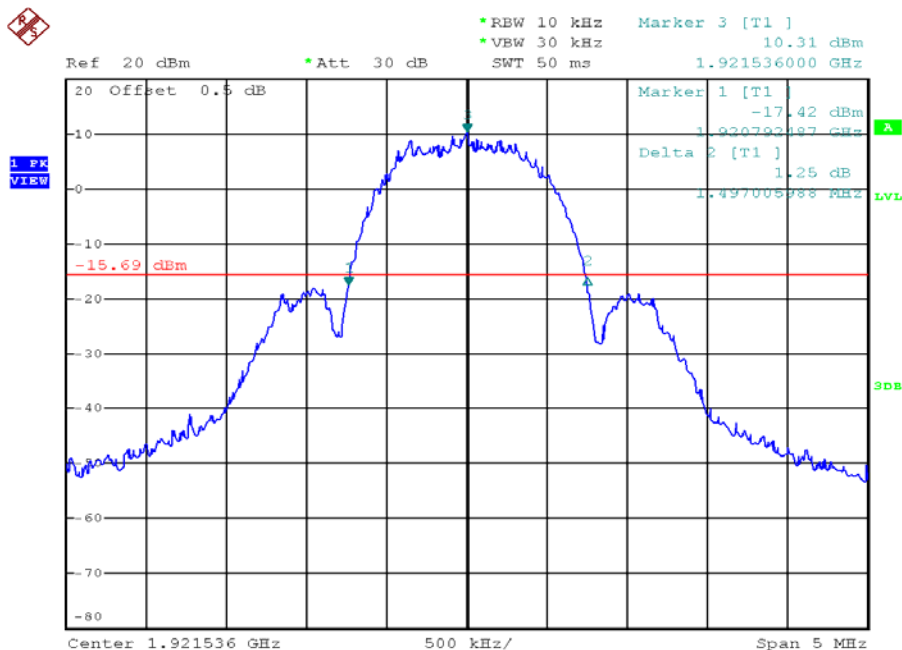

Base unit, Highest channel, Traffic carrier

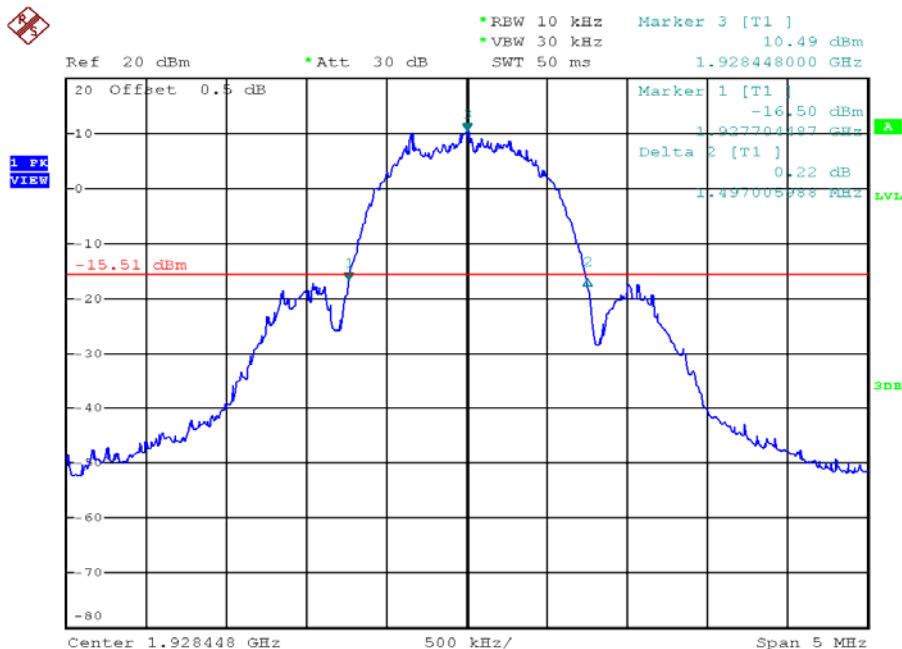

## Plots of occupied bandwidth (IC)

Base unit, Middle channel, Traffic carrier

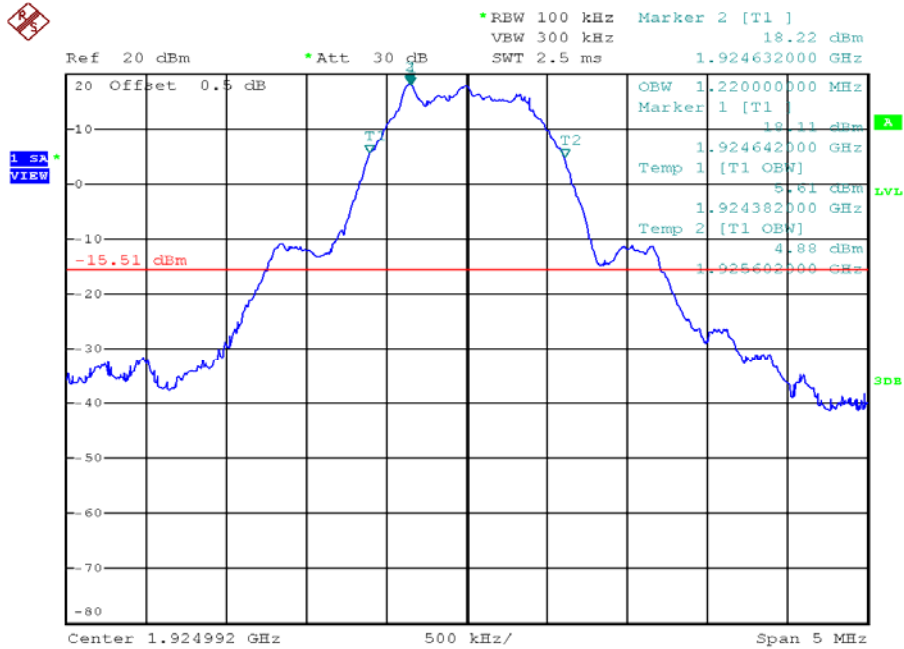

Issuing Laboratory:  
Intertek Testing Services Hong Kong Limited

Hong Kong Accreditation Service (HKAS) has accredited this laboratory under the Hong Kong Laboratory Accreditation Scheme (HOKLAS) for specific laboratory activities as listed in the HOKLAS directory of accredited laboratories. The results shown in this report were determined by this laboratory in accordance with its terms of accreditation.



4.4 Directional Gain of the Antenna, FCC Rule FCC 15.319(e) /  
RSS-213 Clause 4.1(e):

The peak transmit power shall be reduced by the amount in dB that the maximum directional gain of the antenna exceeds 3 dBi.

The requirements are made in accordance with ANSI C63.17 sub-clause 4.3.1 / RSS-213 Clause 4.1(e).

- Manufacturer declares that the directional gain of the antenna is less than or equal to 3dBi. No peak transmit power reduction is required.
- Manufacturer declares that the directional gain of the antenna is greater than 3dBi. The peak transmit power shall be reduced by \_\_\_\_ dB.

#### 4.5 Peak Transmit Power, FCC Rule 15.319(c) / RSS-213 Clause 6.5:

The peak transmit power ( $P_{EUT}$ ) shall not exceed  $100\mu W$  multiplied by the square root of the emission bandwidth / occupied bandwidth ( $B$ ) in Hz or  $5 \log_{10} B - 10$  dBm. The peak transmit power shall be reduced by the amount in dB that the maximum directional gain of the antenna exceeds 3 dBi.

Measurements are made in accordance with ANSI C63.17 sub-clause 6.1.2. Test setup is shown in section 3.2 Figure 3.2.1. The cable loss and/or external attenuation are included in OFFSET function of spectrum analyzer.

Calculation of Peak Transmit Power Limit ( $P_{max}$ ):

$$\begin{aligned} [\times] \quad P_{max} &= 5 \log_{10} B - 10 \text{ dBm} && \text{when } G_A \leq 3\text{dBi} \\ [ ] \quad P_{max} &= 5 \log_{10} B - 10 \text{ dBm} - (G_A - 3\text{dBi}) && \text{when } G_A > 3\text{dBi} \end{aligned}$$

Where  $G_A$  = EUT Antenna Gain:  $\geq$  dBi  
 $B$  = Measured Emission Bandwidth / Occupied Bandwidth

Test Results:

#### I. Traffic Carrier

Channel	Channel Frequency (MHz)	Measured Peak Transmit Power (dBm)	Limit (dBm)	Results
Lowest	1921.536	18.10	20.88	Pass
Middle	1924.992	18.19	20.43	Pass
Highest	1928.448	18.37	20.88	Pass

The plots of peak transmit power are saved as below.

## Plots of peak transmit power (FCC)

Deskset unit, Lowest channel, Traffic carrier

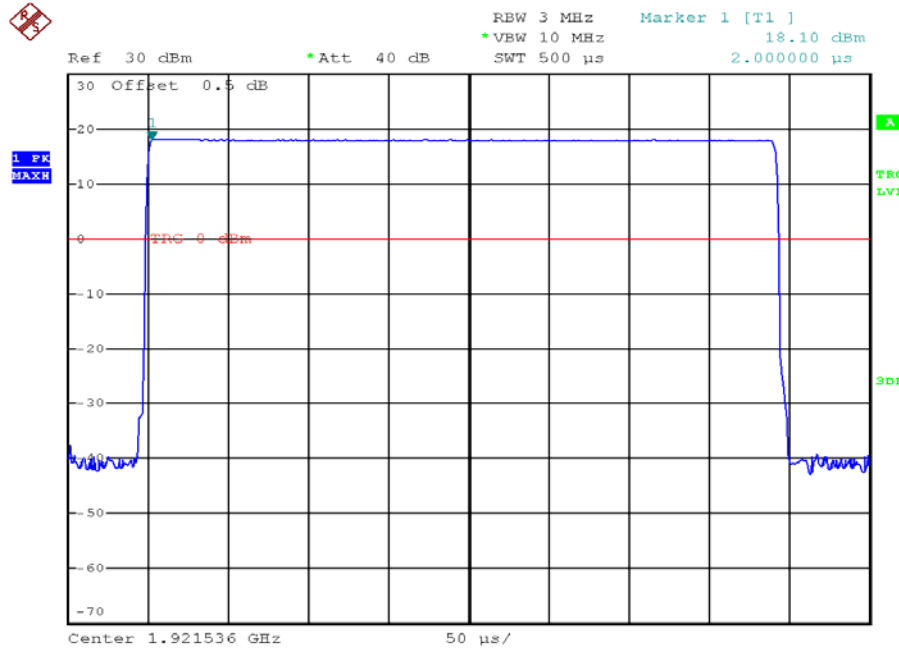

Deskset unit, Highest channel, Traffic carrier

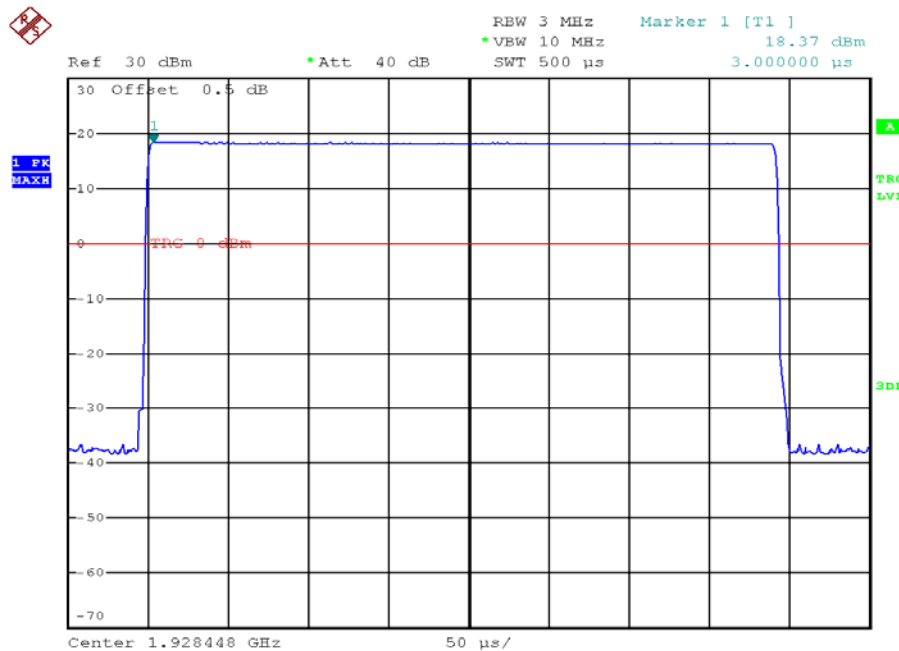

Issuing Laboratory:  
Intertek Testing Services Hong Kong Limited

Hong Kong Accreditation Service (HKAS) has accredited this laboratory under the Hong Kong Laboratory Accreditation Scheme (HOKLAS) for specific laboratory activities as listed in the HOKLAS directory of accredited laboratories. The results shown in this report were determined by this laboratory in accordance with its terms of accreditation.



### Plots of peak transmit power (IC)

Deskset unit, Middle channel, Traffic carrier

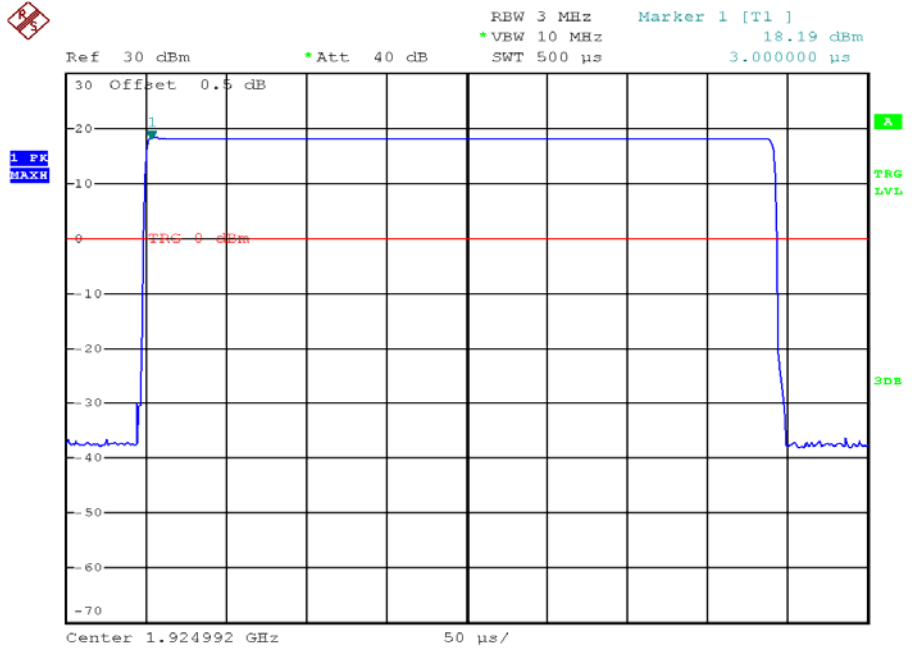



Issuing Laboratory:  
Intertek Testing Services Hong Kong Limited

Hong Kong Accreditation Service (HKAS) has accredited this laboratory under the Hong Kong Laboratory Accreditation Scheme (HOKLAS) for specific laboratory activities as listed in the HOKLAS directory of accredited laboratories. The results shown in this report were determined by this laboratory in accordance with its terms of accreditation.



4.6 Power Spectral Density, FCC Rule 15.319(d) / RSS-213 Clause 6.6:

Power spectral density shall not exceed 3 mW (4.8dBm) in any 3 kHz bandwidth as measured with a spectrum analyzer having a resolution bandwidth of 3 kHz.

Measurements are made in accordance with ANSI C63.17 sub-clause 6.1.5. Test setup is shown in section 3.2 Figure 3.2.1.

Test Results:

I. Traffic Carrier

Channel	Channel Frequency (MHz)	Measured Power Spectral Density (dBm/3kHz)	Limit (dBm/3 kHz)	Results
Lowest	1921.536	-6.10	4.8	Pass
Middle	1924.992	-5.82	4.8	Pass
Highest	1928.448	-5.87	4.8	Pass

The plots of the power spectral density are as below.

## Plots of the power spectral density (FCC)

Deskset unit, Lowest channel, Traffic carrier

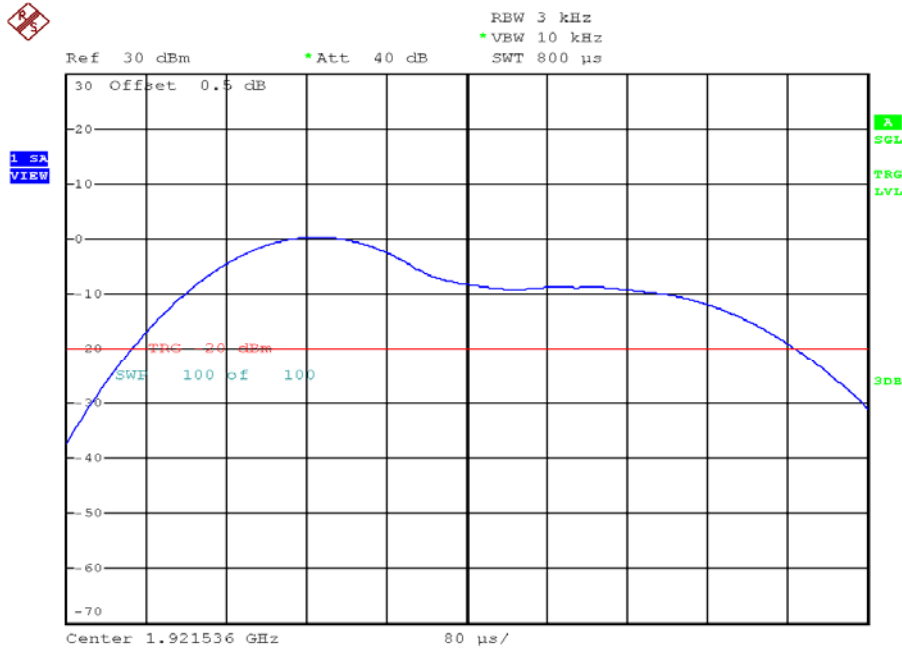

Deskset unit, Highest channel, Traffic carrier

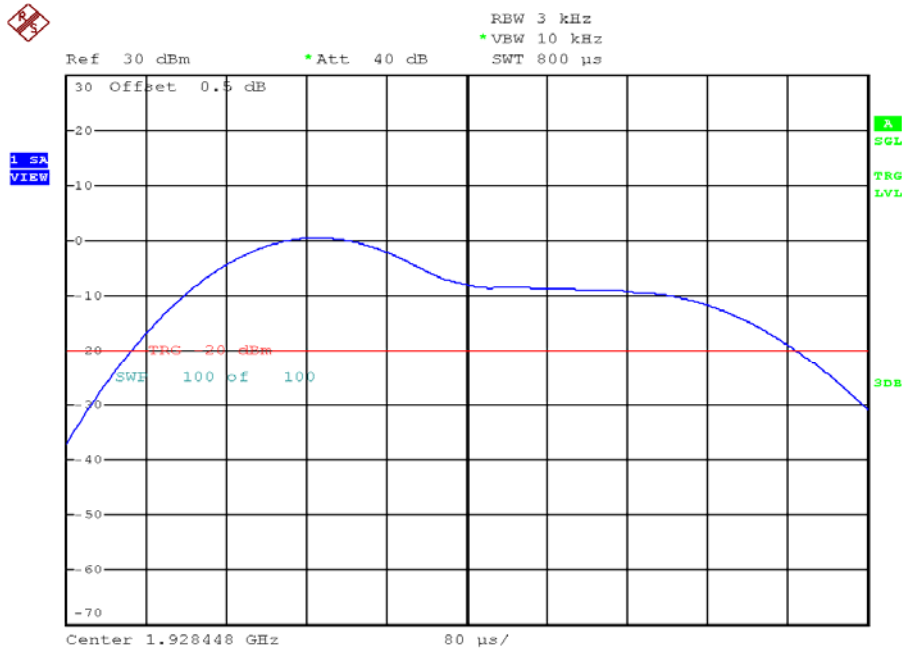

Issuing Laboratory:  
Intertek Testing Services Hong Kong Limited

Hong Kong Accreditation Service (HKAS) has accredited this laboratory under the Hong Kong Laboratory Accreditation Scheme (HOKLAS) for specific laboratory activities as listed in the HOKLAS directory of accredited laboratories. The results shown in this report were determined by this laboratory in accordance with its terms of accreditation.



### Plots of the power spectral density (IC)

Deskset unit, Middle channel, Traffic carrier

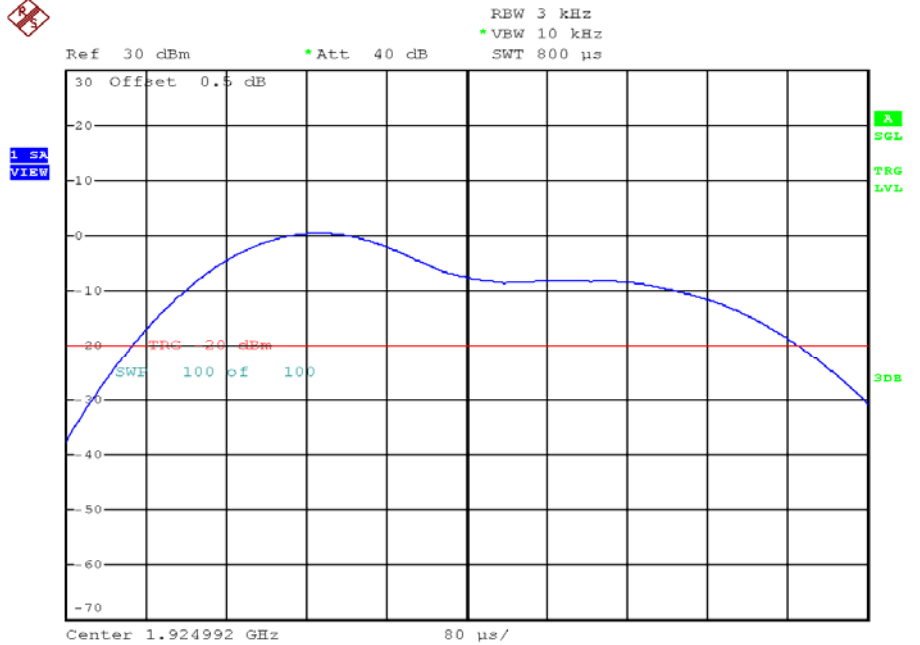

Issuing Laboratory:  
Intertek Testing Services Hong Kong Limited

Hong Kong Accreditation Service (HKAS) has accredited this laboratory under the Hong Kong Laboratory Accreditation Scheme (HOKLAS) for specific laboratory activities as listed in the HOKLAS directory of accredited laboratories. The results shown in this report were determined by this laboratory in accordance with its terms of accreditation.



4.7 Automatic Discontinuation of Transmission, FCC Rule 15.319(f) /  
RSS-213 Clause 4.3.4(a):

The EUT shall automatically discontinue transmission in case of either absence of information to transmit or operational failure. These provisions are not intended to preclude transmission of control and signaling information or use of repetitive codes used by certain digital technologies to complete frame or burst intervals.

The manufacturer declares that the EUT can automatically discontinue transmission in case of either absent information to transmit or operational failure. Please refer to the declaration letter for details, which is saved with filename: declaration.pdf.

Issuing Laboratory:  
Intertek Testing Services Hong Kong Limited

Hong Kong Accreditation Service (HKAS) has accredited this laboratory under the Hong Kong Laboratory Accreditation Scheme (HOKLAS) for specific laboratory activities as listed in the HOKLAS directory of accredited laboratories. The results shown in this report were determined by this laboratory in accordance with its terms of accreditation.



4.8 Unwanted Emission Inside the Sub-Band, FCC Rule 15.323(d) /  
RSS-213 Clause 6.7.2:

Emissions inside the sub-band must comply with the following emission mask:

1. In the bands between  $1B$  and  $2B$  measured from the center of the emission bandwidth, emission shall be at least 30 dB below the permitted peak transmit power.
2. In the bands between  $2B$  and  $3B$  measured from the center of the emission bandwidth, emission shall be at least 50 dB below the permitted peak transmit power.
3. In the bands between  $3B$  and the band edge, emission shall be at least 60 dB below the permitted peak transmit power.

Where  $B$  = emission bandwidth or occupied bandwidth in Hz

Measurements are made in accordance with ANSI C63.17 sub-clause 6.1.6.1. Test setup is shown in section 3.2 Figure 3.2.1.

Test Results:

I. Traffic Carrier

Channel	Channel Frequency (MHz)	Results
Lowest	1921.536	Pass
Middle	1924.992	Pass
Highest	1928.448	Pass

The plots of the unwanted emission inside the sub-band are as below.

## Plots of the unwanted emission inside the sub-band (FCC)

Deskset unit, Lowest channel, Traffic carrier

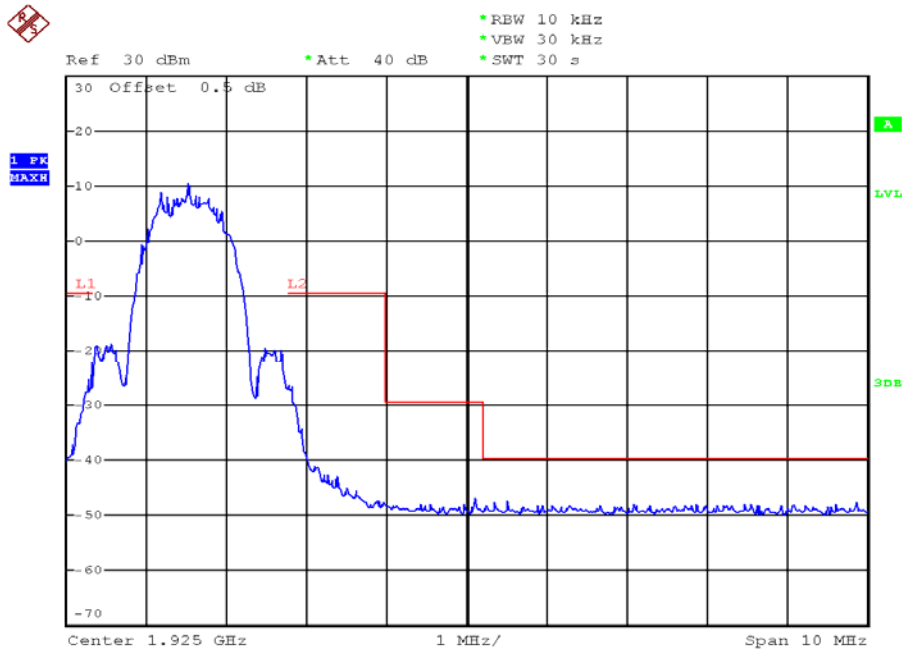

Deskset unit, Highest channel, Traffic carrier

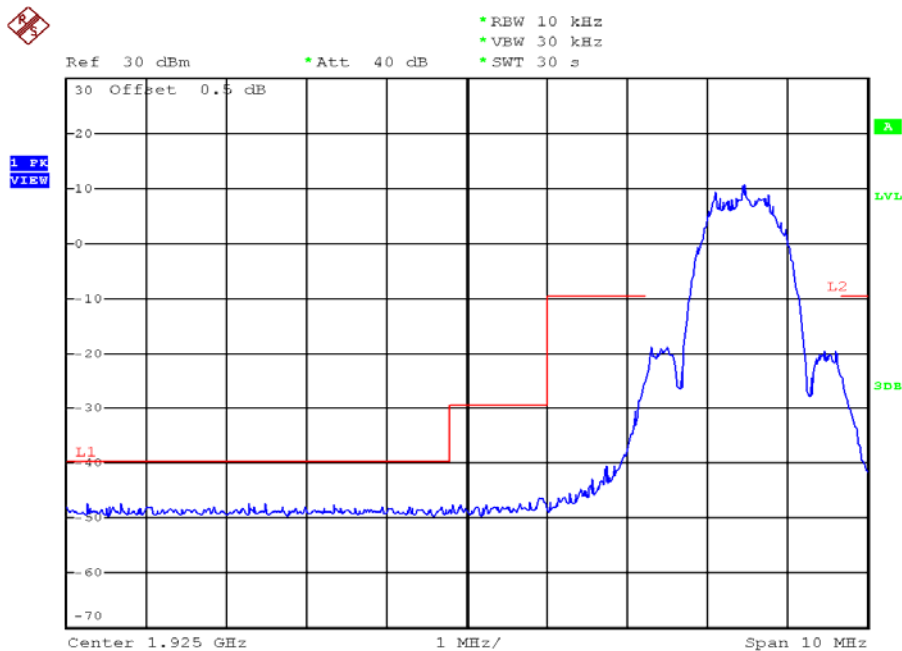

## Plots of the unwanted emission inside the sub-band (IC)

Deskset unit, Lowest channel, Traffic carrier

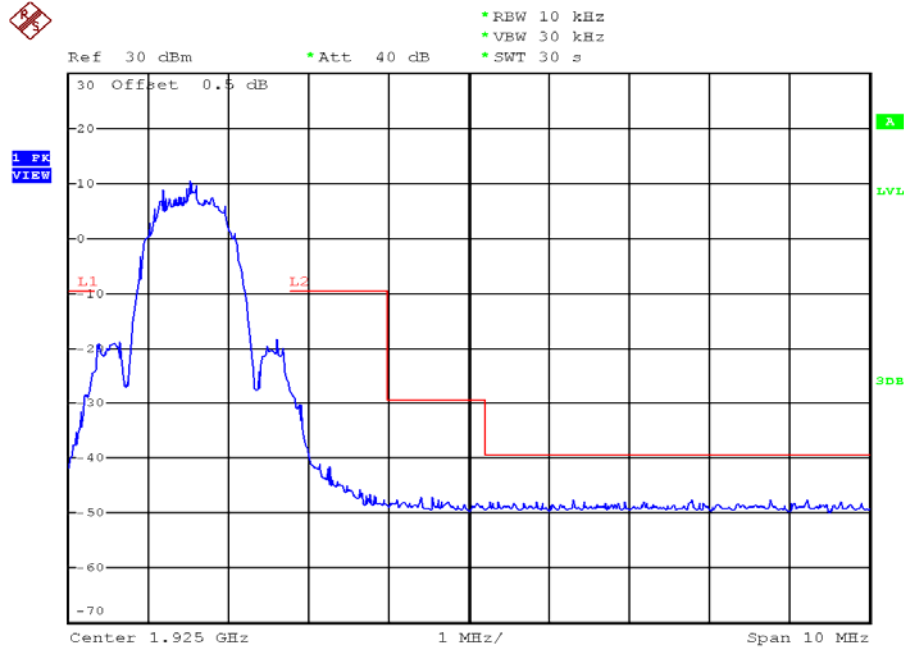

Deskset unit, Middle channel, Traffic carrier

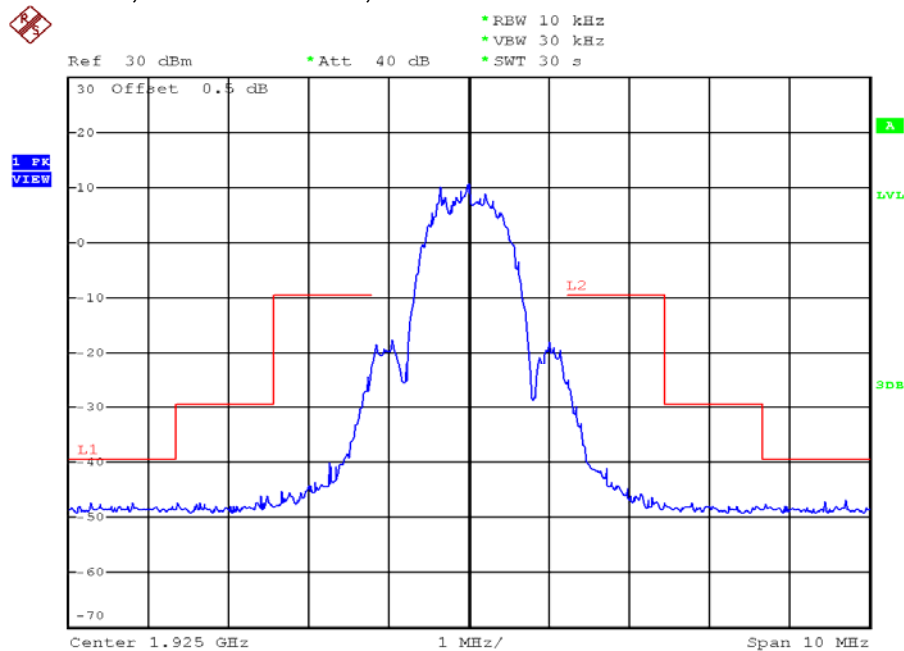

## Plots of the unwanted emission inside the sub-band (IC)

### Deskset unit, Highest channel, Traffic carrier

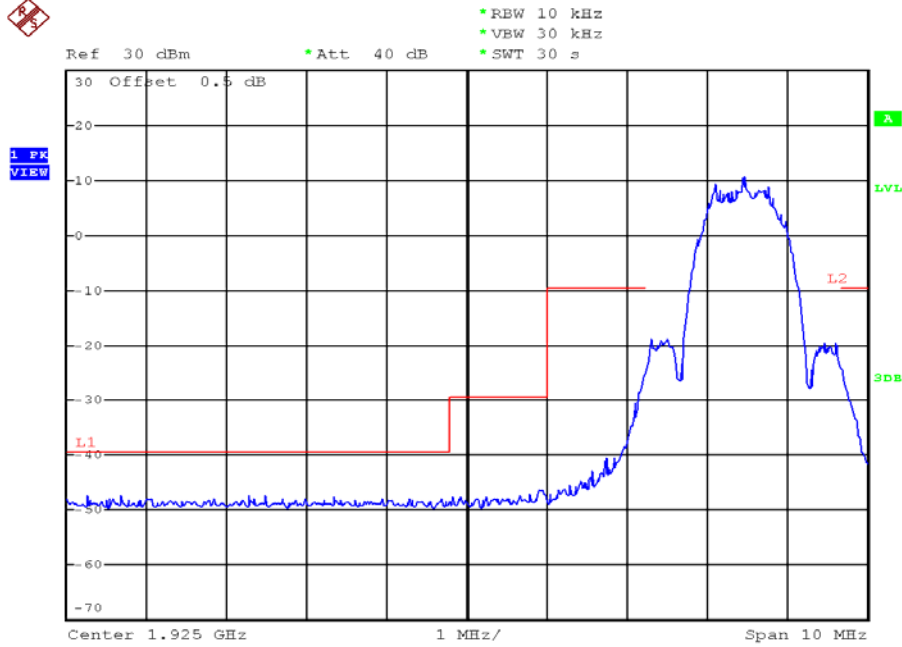



Issuing Laboratory:  
Intertek Testing Services Hong Kong Limited

Hong Kong Accreditation Service (HKAS) has accredited this laboratory under the Hong Kong Laboratory Accreditation Scheme (HOKLAS) for specific laboratory activities as listed in the HOKLAS directory of accredited laboratories. The results shown in this report were determined by this laboratory in accordance with its terms of accreditation.



4.9 Emissions Outside the Sub-Band, FCC Rule 15.323(d) / RSS-213 Clause 6.7.1:

Emissions outside the sub-band shall be attenuated below a reference power of 112 mW (20.5 dBm) as follows:

1. 30 dB between the band edge and 1.25 MHz above or below the band;
2. 50 dB between 1.25 and 2.5 MHz above or below the band; and
3. 60 dB at 2.5 MHz or greater above or below the band, or shall meet the requirement of FCC Rule 15.319(g) which shall not exceed the limits of FCC Rule 15.209 / RSS-210 Clause 2.5.

Example: Calculation of Limit for emissions between the band edge and 1.25 MHz (1920.000 – 1918.750 MHz)

The emissions shall not exceed the Limit: 20.5 dBm – 30 dB = -9.5 dBm

Measurements are made in accordance with ANSI C63.17 sub-clause 6.1.6.2. Radiated emissions test method is used. Emissions that are directly caused by digital circuits in the transmit path and transmitter portion are measured.

Test Results:

Channel	Carrier Frequency (MHz)	Measured Band (MHz)	Limit (dBm)	Results
Lowest	1921.536	1920.000 - 1918.750	-9.5	Pass
		1918.750 - 1917.500	-29.5	Pass
		0.009 - 1917.500 & 1932.500 - 19300.000	-39.5 / RSS-210 Clause 2.5	Pass
Highest	1928.448	1930.000 - 1931.250	-9.5	Pass
		1931.250 - 1932.500	-29.5	Pass
		0.009 – 1917.500 & 1932.500 - 19300.000	-39.5 / RSS-210 Clause 2.5	Pass

Issuing Laboratory:  
Intertek Testing Services Hong Kong Limited

Hong Kong Accreditation Service (HKAS) has accredited this laboratory under the Hong Kong Laboratory Accreditation Scheme (HOKLAS) for specific laboratory activities as listed in the HOKLAS directory of accredited laboratories. The results shown in this report were determined by this laboratory in accordance with its terms of accreditation.



#### 4.9.1 Radiated Emissions Configuration Photographs:

Worst Case Radiated Emission  
at

3856.896 MHz

The worst case radiated emission configuration photographs are saved with filename: config photos.pdf

#### 4.9.2 Radiated Emissions Data:

Data are included of the worst case configuration (the configuration which resulted in the highest emission levels). A sample calculation, configuration photographs and data tables of the emissions are included. All measurements were performed with peak detection unless otherwise specified.

The data in table 1-3 list the significant emission frequencies, the limit and the margin of compliance.

Judgement:

Passed by 3.6 dB margin

Issuing Laboratory:  
Intertek Testing Services Hong Kong Limited

Hong Kong Accreditation Service (HKAS) has accredited this laboratory under the Hong Kong Laboratory Accreditation Scheme (HOKLAS) for specific laboratory activities as listed in the HOKLAS directory of accredited laboratories. The results shown in this report were determined by this laboratory in accordance with its terms of accreditation.



Mode: Transmission

Table 1

**Radiated Emissions Data  
Pursuant To FCC Part 15 Section 15.323 (d) / RSS-213 Clause 6.7.1  
Emissions Requirements**

Lowest Channel

Polarization	Frequency (MHz)	Measured Power (dBm)	Power Limit (dBm)	Margin (dB)
V	1919.850	-42.4	-9.5	-32.9
V	1917.869	-46.7	-29.5	-17.2
V	1917.101	-51.6	-39.5	-12.1
H	3843.072	-43.3	-39.5	-3.8
H	5764.608	-43.8	-39.5	-4.3
H	7686.144	-44.6	-39.5	-5.1
H	9607.680	-45.0	-39.5	-5.5
H	11529.216	-45.1	-39.5	-5.6

NOTES:

1. Peak detector is used for the emission measurement.
2. All measurements were made at 3 meters.
3. Negative value in the margin column shows emission below limit.

Issuing Laboratory:  
Intertek Testing Services Hong Kong Limited

Hong Kong Accreditation Service (HKAS) has accredited this laboratory under the Hong Kong Laboratory Accreditation Scheme (HOKLAS) for specific laboratory activities as listed in the HOKLAS directory of accredited laboratories. The results shown in this report were determined by this laboratory in accordance with its terms of accreditation.



Mode: Transmission

Table 2

**Radiated Emissions Data**  
**Pursuant To FCC Part 15 Section 15.323 (d) / RSS-213 Clause 6.7.1**  
**Emissions Requirements**

Highest Channel

Polarization	Frequency (MHz)	Measured Power (dBm)	Power Limit (dBm)	Margin (dB)
V	1930.013	-42.3	-9.5	-32.8
V	1931.686	-46.7	-29.5	-17.2
V	1933.471	-51.3	-39.5	-11.8
H	3856.896	-43.1	-39.5	-3.6
H	5785.344	-43.9	-39.5	-4.4
H	7713.792	-44.8	-39.5	-5.3
H	9642.240	-44.9	-39.5	-5.4
H	11570.688	-45.2	-39.5	-5.7

NOTES:

1. Peak detector is used for the emission measurement.
2. All measurements were made at 3 meters.
3. Negative value in the margin column shows emission below limit.

Issuing Laboratory:  
Intertek Testing Services Hong Kong Limited

Hong Kong Accreditation Service (HKAS) has accredited this laboratory under the Hong Kong Laboratory Accreditation Scheme (HOKLAS) for specific laboratory activities as listed in the HOKLAS directory of accredited laboratories. The results shown in this report were determined by this laboratory in accordance with its terms of accreditation.



Mode: Base Talk +PC Online

Table 3

**Radiated Emissions Data  
Pursuant To FCC Part 15 Section 15.323 (d) / RSS-213 Clause 6.7.1  
Emissions Requirements**

Polarization	Frequency (MHz)	Measured Power (dBm)	Power Limit (dBm)	Margin (dB)
V	41.469	-63.9	-39.5	-24.4
V	69.119	-63.6	-39.5	-24.1
H	82.940	-63.2	-39.5	-23.7
H	124.415	-62.6	-39.5	-23.1
H	138.239	-61.2	-39.5	-21.7
H	152.063	-60.8	-39.5	-21.3
H	165.889	-54.9	-39.5	-15.4
H	192.521	-59.2	-39.5	-19.7
H	207.361	-62.5	-39.5	-23.0
H	235.809	-62.4	-39.5	-22.9
H	248.831	-62.7	-39.5	-23.2
H	271.099	-63.2	-39.5	-23.7

NOTES:

1. Peak detector is used for the emission measurement.
2. All measurements were made at 3 meters.
3. Negative value in the margin column shows emission below limit.

Issuing Laboratory:  
Intertek Testing Services Hong Kong Limited

Hong Kong Accreditation Service (HKAS) has accredited this laboratory under the Hong Kong Laboratory Accreditation Scheme (HOKLAS) for specific laboratory activities as listed in the HOKLAS directory of accredited laboratories. The results shown in this report were determined by this laboratory in accordance with its terms of accreditation.



#### 4.9.3 Field Strength Calculation

The field strength is calculated by adding the reading on the Spectrum Analyzer to the factors associated with preamplifiers (if any), antennas, cables, pulse desensitization and average factors (when specified limit is in average and measurements are made with peak detectors). A sample calculation is included below.

$$FS = RA + AF + CF - AG + PD + AV$$

Where

- FS = Field Strength in dB $\mu$ V/m
- RA = Receiver Amplitude (including preamplifier) in dB $\mu$ V
- CF = Cable Attenuation Factor in dB
- AF = Antenna Factor in dB
- AG = Amplifier Gain in dB
- PD = Pulse Desensitization in dB
- AV = Average Factor in -dB

In the radiated emission table which follows, the reading shown on the data table may reflect the preamplifier gain. An example of the calculations, where the reading does not reflect the preamplifier gain, follows:

$$FS = RA + AF + CF - AG + PD + AV$$

#### Example

Assume a receiver reading of 62.0 dB $\mu$ V is obtained. The antenna factor of 7.4 dB and cable factor of 1.6 dB is added. The amplifier gain of 29.0 dB is subtracted. The pulse desensitization factor of the spectrum analyzer is 0.0 dB, and the resultant average factor is -10.0 dB. The net field strength for comparison to the appropriate emission limit is 32.0 dB $\mu$ V/m. This value in dB $\mu$ V/m is converted to its corresponding level in  $\mu$ V/m.

RA = 62.0 dB $\mu$ V  
AF = 7.4 dB  
CF = 1.6 dB  
AG = 29.0 dB  
PD = 0.0 dB  
AV = -10 dB

$$FS = 62.0 + 7.4 + 1.6 - 29.0 + 0.0 + (-10.0) = 32.0 \text{ dB}\mu\text{V/m}$$

$$\text{Level in } \mu\text{V/m} = \text{Common Antilogarithm} [(32.0 \text{ dB}\mu\text{V/m})/20] = 39.8 \mu\text{V/m}$$

Issuing Laboratory:  
Intertek Testing Services Hong Kong Limited

Hong Kong Accreditation Service (HKAS) has accredited this laboratory under the Hong Kong Laboratory Accreditation Scheme (HOKLAS) for specific laboratory activities as listed in the HOKLAS directory of accredited laboratories. The results shown in this report were determined by this laboratory in accordance with its terms of accreditation.



4.9.4 Average Factor Calculation and Transmitter ON Time Measurements, FCC Rule 15.35(b, c) / RSS-Gen cl 4.5

[ ] The EUT antenna output port was connected to the input of the spectrum analyzer. The analyzer center frequency was set to EUT RF channel carrier. The SPAN function on the analyzer was set to ZERO. The transmitter ON time was determined from the resultant time-amplitude display:

Please refer to the attached plots for more details:

The plots of Transmitter ON Time Measurements are as below.

- [ ] Please refer to the attached transmitter timing diagram that are provided by manufacturer
- [ x ] Not applicable - No average factor is required.
- [ ] Please refer to Technical Description (descri.pdf) for more details

Issuing Laboratory:  
Intertek Testing Services Hong Kong Limited

Hong Kong Accreditation Service (HKAS) has accredited this laboratory under the Hong Kong Laboratory Accreditation Scheme (HOKLAS) for specific laboratory activities as listed in the HOKLAS directory of accredited laboratories. The results shown in this report were determined by this laboratory in accordance with its terms of accreditation.



4.10 AC Power Line Conducted Emissions, FCC Rule 15.315 / RSS-213 Clause 6.3:

The AC power line conducted emission shall not exceed the limits of FCC Rule 15.207 / Table 4 in RSS-Gen Clause 7.2.4.

Measurements are made in accordance with ANSI C63.4 sub-clause 7. Emissions that are directly caused by digital circuits in the transmit path and transmitter portion are measured.

- Not applicable – EUT is only powered by battery for operation.
  
- EUT connects to AC power line. Emission Data is listed in following pages.
  
- Deskset Unit connects to AC power line and has transmission. Handset connects to AC power line (indirectly) but has no transmission. Emission Data of Base Unit is listed in following pages.
  
- Handset connects to AC power line (indirectly) only during charging. Emission Data is listed in following pages.



Issuing Laboratory:  
Intertek Testing Services Hong Kong Limited

Hong Kong Accreditation Service (HKAS) has accredited this laboratory under the Hong Kong Laboratory Accreditation Scheme (HOKLAS) for specific laboratory activities as listed in the HOKLAS directory of accredited laboratories. The results shown in this report were determined by this laboratory in accordance with its terms of accreditation.



4.10.1 AC Power Line Conducted Emissions Configuration Photographs:

Worst Case AC Power Line Conducted Emission  
at  
0.5955 MHz

The worst case AC power Line conducted emission configuration photographs are saved with filename: config photos.pdf

4.10.2 AC Power Line Conducted Emissions Data:

The plot(s) and data in the following pages list the significant emission frequencies, the limit and the worst case margin of compliance.

Judgment:

Passed by 10.09 dB margin compared with average limit

Issuing Laboratory:  
Intertek Testing Services Hong Kong Limited

Hong Kong Accreditation Service (HKAS) has accredited this laboratory under the Hong Kong Laboratory Accreditation Scheme (HOKLAS) for specific laboratory activities as listed in the HOKLAS directory of accredited laboratories. The results shown in this report were determined by this laboratory in accordance with its terms of accreditation.



Worst Case: Talk

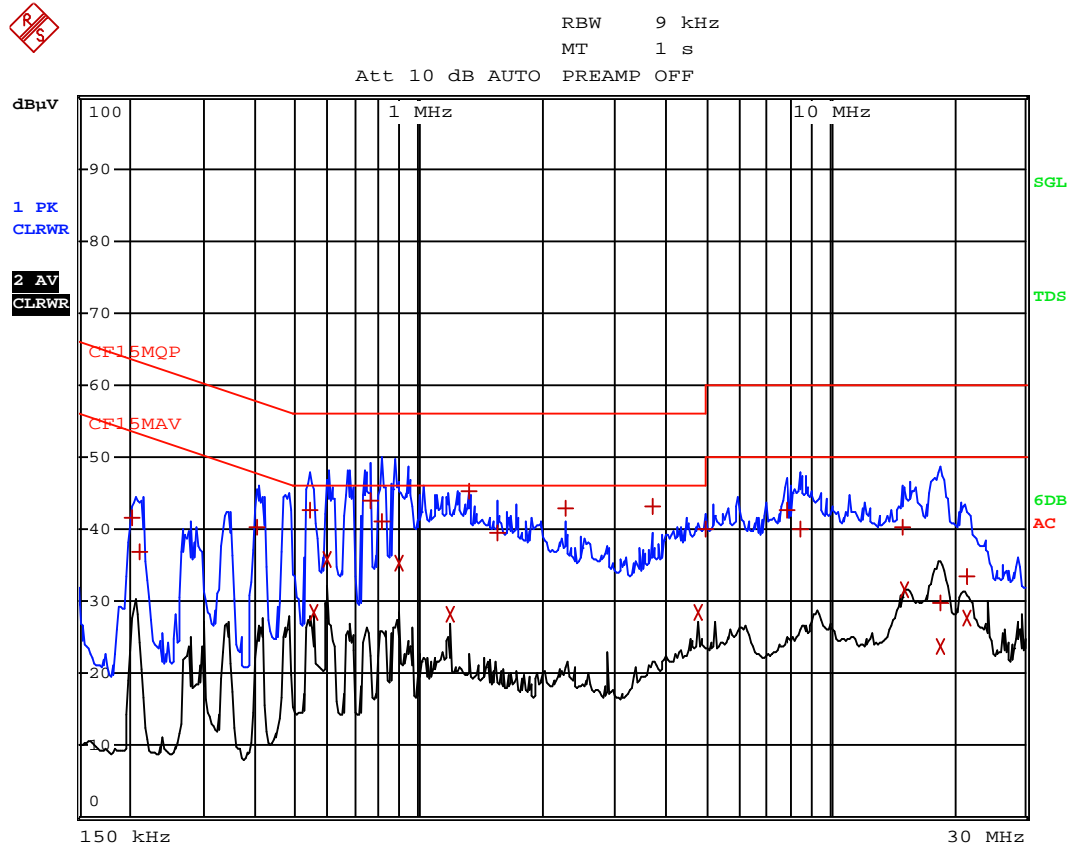

Date: 9.AUG.2013 12:48:56

Issuing Laboratory:  
Intertek Testing Services Hong Kong Limited

Hong Kong Accreditation Service (HKAS) has accredited this laboratory under the Hong Kong Laboratory Accreditation Scheme (HOKLAS) for specific laboratory activities as listed in the HOKLAS directory of accredited laboratories. The results shown in this report were determined by this laboratory in accordance with its terms of accreditation.



Worst Case:                      Talk

EDIT PEAK LIST (Final Measurement Results)				
Trace1:	CF15MQP			
Trace2:	CF15MAV			
Trace3:	---			
TRACE	FREQUENCY	LEVEL	dB $\mu$ V	DELTA LIMIT
1 Quasi Peak	204 kHz	41.59	L1	-21.85
1 Quasi Peak	213 kHz	36.94	L1	-26.14
1 Quasi Peak	402 kHz	40.38	N	-17.43
1 Quasi Peak	541.5 kHz	42.61	L1	-13.38
2 CISPR Average	555 kHz	28.59	N	-17.40
2 CISPR Average	595.5 kHz	35.90	N	-10.09
1 Quasi Peak	762 kHz	44.05	L1	-11.94
1 Quasi Peak	811.5 kHz	41.00	N	-14.99
2 CISPR Average	892.5 kHz	35.35	N	-10.64
2 CISPR Average	1.1895 MHz	28.19	N	-17.80
1 Quasi Peak	1.329 MHz	45.32	N	-10.67
1 Quasi Peak	1.5585 MHz	39.37	N	-16.62
1 Quasi Peak	2.274 MHz	42.97	L1	-13.02
1 Quasi Peak	3.723 MHz	43.08	N	-12.91
2 CISPR Average	4.803 MHz	28.37	N	-17.63
1 Quasi Peak	4.992 MHz	40.14	N	-15.85
1 Quasi Peak	7.9665 MHz	42.69	N	-17.30
1 Quasi Peak	8.4525 MHz	40.09	N	-19.90
1 Quasi Peak	15.0945 MHz	40.27	N	-19.72
2 CISPR Average	15.1935 MHz	31.56	N	-18.43

Date: 9.AUG.2013 12:50:51

Issuing Laboratory:  
Intertek Testing Services Hong Kong Limited

Hong Kong Accreditation Service (HKAS) has accredited this laboratory under the Hong Kong Laboratory Accreditation Scheme (HOKLAS) for specific laboratory activities as listed in the HOKLAS directory of accredited laboratories. The results shown in this report were determined by this laboratory in accordance with its terms of accreditation.



Worst Case:                      Talk

EDIT PEAK LIST (Final Measurement Results)				
Trace1:	CF15MQP			
Trace2:	CF15MAV			
Trace3:	---			
TRACE	FREQUENCY	LEVEL dBµV		DELTA LIMIT dB
1 Quasi Peak	18.5775 MHz	29.91	N	-30.08
2 CISPR Average	18.7035 MHz	23.72	N	-26.27
2 CISPR Average	21.5565 MHz	27.65	N	-22.34
1 Quasi Peak	21.561 MHz	33.36	N	-26.63

Date: 9.AUG.2013 12:50:14

Issuing Laboratory:  
Intertek Testing Services Hong Kong Limited

Hong Kong Accreditation Service (HKAS) has accredited this laboratory under the Hong Kong Laboratory Accreditation Scheme (HOKLAS) for specific laboratory activities as listed in the HOKLAS directory of accredited laboratories. The results shown in this report were determined by this laboratory in accordance with its terms of accreditation.



4.11 Frame Repetition Stability, FCC Rule 15.323(e) / RSS-213 Clause 4.3.4(c):

- EUT implements Time Division Duplex (TDD) (not include TDMA) in order to support duplex connection on a given frequency carrier shall maintain a frame repetition rate whereby 3 x standard deviation of the frequency stability shall not exceed 50 ppm, not including a shift of the mean.
- EUT uses Time Division Multiple Access (TDMA) in order to support multiple communication links on a given frequency carrier shall maintain a frame repetition rate whereby 3 x standard deviation of the frequency stability shall not exceed 10 ppm, not including a shift of the mean.

Measurements are made in accordance with ANSI C63.17 sub-clause 6.2.2. Test setup is shown in section 3.2 Figure 3.2.1. A spectrum analyzer measures the time duration between rising edges of two consecutive frames over a time period of at least 1000 frame periods. These measurement values are used to compute the 3 x standard deviation of the frequency stability.

Test Results:

Maximum Frame Repetition Stability (ppm)	Limit (ppm)	Results
0.040	±10	Pass

Issuing Laboratory:  
Intertek Testing Services Hong Kong Limited

Hong Kong Accreditation Service (HKAS) has accredited this laboratory under the Hong Kong Laboratory Accreditation Scheme (HOKLAS) for specific laboratory activities as listed in the HOKLAS directory of accredited laboratories. The results shown in this report were determined by this laboratory in accordance with its terms of accreditation.



4.12 Frame Period and Jitter, FCC Rule 15.323(e) / RSS-213 Clause 4.3.4(c):

The frame period (a set of consecutive time slots in which the position of each time slot can be identified by reference to a synchronizing source) of EUT operating in these sub-bands shall be 20 ms or 10 ms/X where X is a positive whole number.

The jitter (time-related, abrupt, spurious variations in the duration of the frame interval) introduced at the two ends of such a communication link shall not exceed 25  $\mu$ s for any two consecutive transmissions. Transmissions shall be continuous in every time and spectrum window during the frame period defined for EUT.

Measurements are made in accordance with ANSI C63.17 sub-clause 6.2.3. Test setup is shown in section 3.2 Figure 3.2.1. A spectrum analyzer measures the time duration between the rising edges of two consecutive frames. The measurements are taken over 100,000 frames. These measurement values are used to compute mean value and the difference between any two consecutive frame periods. The mean value is the frame period.

Test Results:

Measured Maximum Jitter ( $\mu$ s)	Limit ( $\mu$ s)	Result
-0.173	$\pm$ 25	Pass

4.13 Carrier Frequency Stability, FCC Rule 15.323(f) / RSS-213 Clause 6.2:

The carrier frequency stability of EUT shall be maintained within +/-10 ppm at the following conditions:

1. Over 1 hour at nominal supply voltage and a temperature of +20 °C;
2. Over a variation in the primary supply voltage of 85 % to 115 % of nominal supply voltage at a temperature of +20 °C. This test does not apply to an EUT that is only powered by battery for operation;
3. Over a temperature variation of -20 °C to +50 °C or at extreme temperatures as declared by manufacturer, and at nominal supply voltage.

The nominal supply voltage: 120VAC and the extreme temperatures of -20°C to +50°C are declared by manufacturer.

Measurements are made in accordance with ANSI C63.17 sub-clause 6.2.1 The EUT and CMD60 is connected with shielded coaxial cable. The EUT is controlled by DECT Radio Communication Tester, CMD60, to use a fixed frequency channel during test as well as record the frequency offset. The transmission of EUT is in burst mode with pseudo-random data. Test setup is shown as follows.

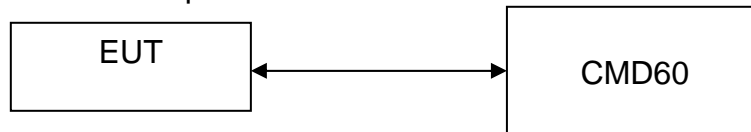

Test Results:

I a. Carrier Frequency Stability over time

Supply Voltage	Temperature (°C)	Measured Frequency Offset Over an hour (ppm)		Limit (ppm)	Result
		Max.	Min.		
Nominal	+20°C	0.80	-0.24	±10	Pass

I b. Carrier Frequency Stability over Power Supply Voltage

Supply Voltage	Temperature (°C)	Measured Frequency Offset (ppm)	Limit (ppm)	Results
85%	+20°C	0.28	±10	Pass
115%	+20°C	0.28	±10	Pass

4.13 Carrier Frequency Stability, FCC Rule 15.323(f) / RSS-213 Clause 6.2: -Continued

I c. Carrier Frequency Stability over Temperature

Supply Voltage	Temperature (°C)	Measured Frequency Offset (ppm)	Limit (ppm)	Results
Nominal	-20°C	2.53	±10	Pass
Nominal	+50°C	0.53	±10	Pass

4.14 Monitoring Threshold:

For FCC, upper monitoring threshold limit is declared by manufacturer, and lower monitoring threshold limit is calculated with 20dB difference of upper monitoring threshold limit.

For IC, monitoring threshold can be relaxed according to RSS-213 Clause 4.3.4(b)(9). EUT that has a power output lower than the maximum permitted under RSS-213 Clause 6.5 may increase their monitoring detection threshold by one decibel for each one decibel that the transmitter power is below the maximum permitted.

Calculation of Monitoring Threshold Limit:

$$\begin{aligned} \text{Monitoring Threshold } (T) &\leq -174 + 10 \log_{10} B + M + P_{\max} - P_{\text{EUT}} \text{ dBm} \\ &\leq 15 \log_{10} B - 184 + M - P_{\text{EUT}} \text{ dBm} \end{aligned}$$

Where  $B$  = Measured Emission Bandwidth or Occupied Bandwidth – IC: 1.22MHz  
 $M$  = 30 dB for Lower Monitoring Threshold ( $T_L$ ), or  
 = 50 dB for Upper Monitoring Threshold ( $T_U$ )  
 $P_{\max}$  =  $5 \log_{10} B - 10$  dBm  
 $P_{\text{EUT}}$  = Measured Peak Transmit Power - IC: 18.19dBm

Monitoring Threshold Limits:

	FCC	IC
Lower Monitoring Threshold ( $T_L + U_M$ ) in dBm	-79.7	-74.9
Upper Monitoring Threshold ( $T_U + U_M$ ) in dBm	-59.7	-54.9

NA - Not applicable



Issuing Laboratory:  
Intertek Testing Services Hong Kong Limited

Hong Kong Accreditation Service (HKAS) has accredited this laboratory under the Hong Kong Laboratory Accreditation Scheme (HOKLAS) for specific laboratory activities as listed in the HOKLAS directory of accredited laboratories. The results shown in this report were determined by this laboratory in accordance with its terms of accreditation.



4.14.1 Lower Monitoring Threshold, FCC Rule 15.323(c)(2) /  
RSS-213 Clause 4.3.4(b)(2):

- [ x ] Not applicable – EUT which supports at least of 20 duplex system access channels for FCC and 40 duplex system access channels for IC and implements Least Interfered Channel (LIC) algorithm is permitted to use an upper monitoring threshold. Please refer to the section 4.14.2 for more details.
- [ ] The lower monitoring threshold must not be more than 30 dB above the thermal noise power for a bandwidth equivalent to the emission bandwidth used by EUT.

Measurements are made in accordance with ANSI C63.17 sub-clause 7.3.1. Test setup is shown in section 3.3 Figure 3.3.1. The test is performed on the carrier closest to center of the band. RF signal generators apply uniform CW interference on all EUT carriers each at level  $T_L + U_M + 10$  dB. Then, the interference level is reduced uniformly on all carriers until the EUT can transmit. The interference level shall be lower than or equal to the threshold limit.

Test Results:

Measured Maximum Interference Level (dBm)	Lower Monitoring Threshold Limit (dBm) ( $T_L + U_M$ )		Results
	FCC	IC	
NA	-79.7	-74.9	NA

NA - Not applicable

Issuing Laboratory:  
Intertek Testing Services Hong Kong Limited

Hong Kong Accreditation Service (HKAS) has accredited this laboratory under the Hong Kong Laboratory Accreditation Scheme (HOKLAS) for specific laboratory activities as listed in the HOKLAS directory of accredited laboratories. The results shown in this report were determined by this laboratory in accordance with its terms of accreditation.



4.14.2 Least Interfered Channel, LIC, FCC Rule 15.323(c)(5) /  
RSS-213 Clause 4.3.4(b)(5):

- [ ] Not implemented – EUT met lower monitoring threshold requirements. Please refer to the section 4.15.1 for more details
- [ x ] If access to spectrum is not available as determined by section 4.14.1 and a minimum of 20 duplex system access channels (FCC) and 40 duplex system access channels (IC) are defined for the EUT, the time and spectrum windows with the lowest power level below a monitoring threshold of 50 dB above the thermal noise power determined for the emission bandwidth may be accessed

Number of duplex channels per frequency channel = 12  
 Number of frequency channel = 5  
 Total Duplex Channels = 60

Hence, the time and spectrum windows below upper monitoring threshold may be accessed.

4.14.2.1 Upper Monitoring Threshold, FCC Rule 15.323(c)(5) /  
RSS-213 Clause 4.3.4(b)(5):

Measurements are made in accordance with ANSI C63.17 sub-clause 7.3.2. Test setup is shown in section 3.3 Figure 3.3.1. The test is performed on the carrier closest to center of the band. RF signal generators apply uniform CW interference on all EUT carriers each at level  $T_U + U_M + 10$  dB. Then, the interference level is reduced uniformly on all carriers until the EUT can transmit. The interference level shall be lower than or equal to the threshold limit.

Test Results:

Measured Maximum Interference Level (dBm)	Upper Monitoring Threshold Limit (dBm) ( $T_U + U_M$ )		Results
	FCC	IC	
-73.15	-59.7	-54.9	Pass

NA - Not applicable

#### 4.14.2.2 Least Interfered Channel (LIC) Selection, FCC Rule 15.323(c)(5) / RSS-213 Clause 4.3.4(b)(5):

The criteria are specified in section 4.14.2. In addition, the power measurement resolution for this comparison must be accurate to within 6 dB.

Measurements are made in accordance with ANSI C63.17 sub-clause 7.3.3. Test setup is shown in section 3.3 Figure 3.3.1. RF signal generators apply uniform CW interference on all EUT carriers except two carriers (designated  $f_1$  and  $f_2$ ), each at level  $T_U + U_M$ . EUT can only transmit on these two carriers.

#### Test Descriptions and Results:

##### I. LIC Procedure

	Test Descriptions	EUT transmits on	Results
1	Apply interference on $f_1$ at level $T_L + U_M + 7$ dB. Apply interference on $f_2$ at level $T_L + U_M$ . Initiate transmission. Verify transmission on $f_2$ . Terminate transmission. Repeat 5 times.	$f_2$	Pass
2	Apply interference on $f_1$ at level $T_L + U_M$ . Apply interference on $f_2$ at level $T_L + U_M + 7$ dB. Initiate transmission. Verify transmission on $f_1$ . Terminate transmission. Repeat 5 times.	$f_1$	Pass
3	Apply interference on $f_1$ at level $T_L + U_M + 1$ dB. Apply interference on $f_2$ at level $T_L + U_M - 6$ dB. Initiate transmission. Verify transmission on $f_2$ . Terminate transmission. Repeat 5 times.	$f_2$	Pass
4	Apply interference on $f_1$ at level $T_L + U_M - 6$ dB. Apply interference on $f_2$ at level $T_L + U_M + 1$ dB. Initiate transmission. Verify transmission on $f_1$ . Terminate transmission. Repeat 5 times.	$f_1$	Pass

NA - Not applicable

Issuing Laboratory:  
Intertek Testing Services Hong Kong Limited

Hong Kong Accreditation Service (HKAS) has accredited this laboratory under the Hong Kong Laboratory Accreditation Scheme (HOKLAS) for specific laboratory activities as listed in the HOKLAS directory of accredited laboratories. The results shown in this report were determined by this laboratory in accordance with its terms of accreditation.



4.14.2.3 Least Interfered Channel (LIC) Confirmation, FCC Rule 15.323(c)(5) / RSS-213 Clause 4.3.4(b)(5):

EUT utilizing the provision of FCC Rule 15.323(c)(5) / RSS-213 Clause 4.3.4(b)(5) must have monitored all access channels defined for its system within the last 10 s and must verify, within the 20 ms (40 ms for EUT designed to use a 20 ms frame period) immediately preceding actual channel access that the detected power of the selected time and spectrum windows is no higher than the previously detected value.

Measurements are made in accordance with ANSI C63.17 sub-clause 7.3.4. This test is performed in section 4.15 and 4.16.

Results:

The tests are reported in section 4.15 and 4.16.

4.14.2.4 Maximum Spectrum Occupancy, FCC Rule 15.323(c)(5) / RSS-213 Clause 4.3.4(b)(5):

No EUT or group of co-operating EUTs located within 1 meter of each other shall during any frame period occupy more than 6 MHz of aggregate bandwidth, or alternatively, more than one third of the time and spectrum windows defined by the EUT.

Attestation:

According to the technical description provided, the total number of the time and spectrum windows defined by the system is  $5 \times 12 = 60$ .

During any frame period, the maximum number of time and spectrum windows occupied by the system will be 12, which is less than one third of the time and spectrum windows defined by the system.

Issuing Laboratory:  
Intertek Testing Services Hong Kong Limited

Hong Kong Accreditation Service (HKAS) has accredited this laboratory under the Hong Kong Laboratory Accreditation Scheme (HOKLAS) for specific laboratory activities as listed in the HOKLAS directory of accredited laboratories. The results shown in this report were determined by this laboratory in accordance with its terms of accreditation.



4.15 Monitoring Time, FCC Rule 15.323(c)(1) / RSS-213 Clause 4.3.4(b)(1):

Immediately prior to initiating transmission, EUT must monitor the combined time and spectrum windows in which they intend to transmit for a period of at least 10 ms for EUT designed to use a 10 ms or shorter frame period, or at least 20 ms for EUT designed to use a 20 ms frame period.

Measurements are made in accordance with ANSI C63.17 sub-clause 7.3.4. Test setup is shown in section 3.3 Figure 3.3.1. RF signal generators apply uniform CW interference on all system carriers except two carriers (designated  $f_1$  and  $f_2$ ), each at level  $T_U + U_M$ . EUT can only transmit on these two carriers.

Test Descriptions and Results:

	Test Descriptions	EUT transmits on	Results
1	Apply interference on $f_1$ at level $T_U + U_M$ , and no interference on $f_2$ . Initiate transmission. Verify transmission on $f_2$ . Then, terminate transmission.	$f_2$	Pass
2	Apply interference on $f_2$ at level $T_U + U_M$ , and remove interference from $f_1$ immediately. Also immediately initiate transmission but is at least 20 ms after interference on $f_2$ is applied. Verify transmission on $f_1$ .	$f_1$	Pass

4.16 Maximum Transmit Period, FCC Rule 15.323(c)(3) / RSS-213 Clause 4.3.4(b)(3):

If no signal above the threshold level is detected, transmission may commence and continue with the same emission bandwidth in the monitored time and spectrum windows without further monitoring. However, occupation of the same combined time and spectrum windows by a EUT or group of co-operating EUTs continuously over a period of time longer than 8 hours is not permitted without repeating the access criteria.

EUT establishes a communication channel with its companion device, which occupies the duplex pair combined time and spectrum windows. Reference RF signal generator synchronized with the sample and then generated a pulse as a time frame reference. The centre frequency of spectrum analyzer was set to the carrier frequency and the SPAN was set to ZERO. The spectrum analyzer was used to monitor the time (reference to the time signal) and spectrum of the communication channel. The occupied time or spectrum of the communication channel shall be changed over a period of time no longer than 8 hours. For a EUT with a frame period of 10/X ms, no more than 2,880,000 X frames should be transmitted without a break.

Test setup is shown as follows:

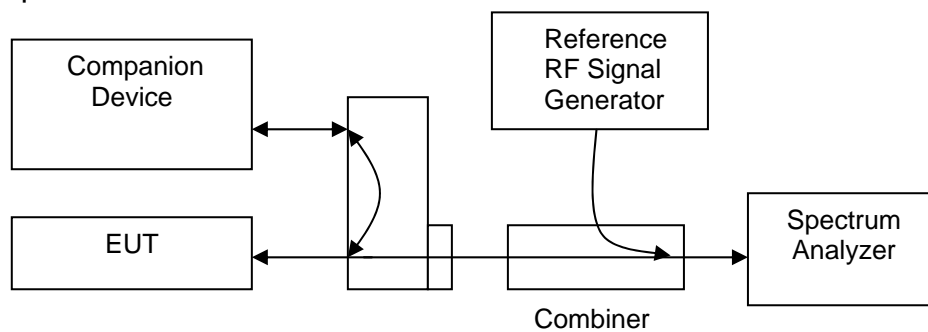

Test Results:

Measured Maximum Transmission Duration (minutes)	Limit (minutes)	Results
45	480	Pass

Issuing Laboratory:  
Intertek Testing Services Hong Kong Limited

Hong Kong Accreditation Service (HKAS) has accredited this laboratory under the Hong Kong Laboratory Accreditation Scheme (HOKLAS) for specific laboratory activities as listed in the HOKLAS directory of accredited laboratories. The results shown in this report were determined by this laboratory in accordance with its terms of accreditation.



4.17 System Acknowledgement, FCC Rule 15.323(c)(4) / RSS-213 Clause 4.3.4(b)(4):

Once access to specific combined time and spectrum windows is obtained an acknowledgment from a system participant must be received by the initiating transmitter within one second or transmission must cease. Periodic acknowledgments must be received at least every 30 seconds or transmission must cease. Channels used exclusively for control and signaling information may transmit continuously for 30 seconds without receiving an acknowledgment, at which time the access criteria must be repeated.

Measurements are made in accordance with ANSI C63.17 sub-clause 8.1.1 and 8.2.1. Test setup is shown in section 3.3 Figure 3.3.1.

Test Results:

[ x ] Timing for EUTs using control and signaling channel type transmissions:

Conditions	Transmission Duration (seconds)	Limit (seconds)	Results
Time needed to repeat access criteria	1.28	30	Pass

[ x ] Timing for EUTs using communications channel type transmissions:

Conditions	Transmission Duration (seconds)	Limit (seconds)	Results
Activate EUT w/ companion device off	NA	1	NA
Time needed to cease Traffic Channel	5	30	Pass

NA - Not applicable

Issuing Laboratory:  
Intertek Testing Services Hong Kong Limited

Hong Kong Accreditation Service (HKAS) has accredited this laboratory under the Hong Kong Laboratory Accreditation Scheme (HOKLAS) for specific laboratory activities as listed in the HOKLAS directory of accredited laboratories. The results shown in this report were determined by this laboratory in accordance with its terms of accreditation.



4.18 Random Waiting, FCC Rule 15.323(c)(6) / RSS-213 Clause 4.3.4(b)(6):

If the selected combined time and spectrum windows are unavailable, the EUT may either monitor and select different windows or seek to use the same windows after waiting an amount of time, randomly chosen from a uniform random distribution between 10 and 150 ms, commencing when the channel becomes available.

Measurements are made in accordance with ANSI C63.17 sub-clause 8.1.2 or 8.1.3. Test setup is shown in section 3.3 Figure 3.3.1.

Test Results:

Random Waiting is not implemented in the EUT:

Conditions	Transmit Channel	Results
Interference applied at operating Channel, $f_1$	$f_2$	Pass

Random Waiting is implemented in the EUT:

Maximum time interval from the end of interference to the start of the control channel	The distribution of the measured time intervals	Results
NA	NA	NA

NA - Not applicable



4.19 Monitoring Bandwidth, FCC Rule 15.323(c)(7).1 / RSS-213 Clause 4.3.4(b)(7).1:

The monitoring bandwidth must be equal to or greater than the emission bandwidth/occupied bandwidth of the intended transmission.

Measurements are made in accordance with ANSI C63.17 sub-clause 7.4. Test setup is shown in section 3.3 Figure 3.3.1.

Attestation:

Monitoring bandwidth of the EUT is equal to the occupied bandwidth of the intended transmission. Monitoring is made through the radio receiver used by the EUT for communication. Please refer to the section 2.2 Technical Description for more details. Designed bandwidth refers to section 4.3 Emission Bandwidth / Occupied Bandwidth.

Compliance is demonstrated by Monitoring Bandwidth Tests as shown below.

Test Results:

la. Simple Compliance Test Results

Interference from Carrier	Reaction of EUT	Results
-30% EBW / Occupied Bandwidth	NA	NA
+30% EBW / Occupied Bandwidth	NA	NA

lb. Detailed Compliance Test Results - Base unit

CW Interference from Carrier	Reaction of EUT	Results
+ 6 dB	NA	NA
+ 12 dB	NA	NA
- 6 dB	NA	NA
- 12 dB	NA	NA

- A – Could Transmit
- B – Could not Transmit
- NA – Not applicable

\*Remarks: Detailed Compliance Test was used to show the compliance of the EUT.

4.20 Maximum Reaction Time, FCC Rule 15.323(c)(7).2 / RSS-213 Clause 4.3.4(b)(7).2:

The monitoring system bandwidth must have a maximum reaction time less than  $50 \times \text{SQRT}(1.25/\text{emission bandwidth } B \text{ in MHz}) \mu\text{s}$  for signals at the applicable threshold level but shall not be required to be less than  $50 \mu\text{s}$ . If a signal is detected that is 6 dB or more above the applicable threshold level, the maximum reaction time shall be  $35 \times \text{SQRT}(1.25/\text{emission bandwidth } B \text{ in MHz}) \mu\text{s}$  but shall not be required to be less than  $35 \mu\text{s}$ .

Measurements are made in accordance with ANSI C63.17 sub-clause 7.5. Test setup is shown in section 3.3 Figure 3.3.1.

Test Results:

	Test	Reaction of EUT	Results
1	With Interference Pulse = $50 \mu\text{s}$ (FCC), $50\sqrt{1.25/B}$ us (IC)	B	Pass
2	With Interference Pulse = $35 \mu\text{s}$ (FCC), $35\sqrt{1.25/B}$ us (IC)	B	Pass

- A – Could be connected in at least one channel
- B – Could not be connected in all channels
- NA – Not applicable

4.21 Monitoring Antenna, FCC Rule 15.323(c)(8) / RSS-213 Clause 4.3.4(b)(8):

The monitoring system shall use the same antenna used for transmission, or an antenna that yields equivalent reception at that location.

- [ x ] EUT uses the same antenna used for transmission and monitoring that is in compliance meet above provision.
- [ ] EUT uses difference antenna used for transmission and monitoring. It must be verified that the monitoring antenna provides coverage equivalent to that of the transmitting antenna. Measurements are made in accordance with ANSI C63.17 sub-clause 4.

Issuing Laboratory:  
Intertek Testing Services Hong Kong Limited

Hong Kong Accreditation Service (HKAS) has accredited this laboratory under the Hong Kong Laboratory Accreditation Scheme (HOKLAS) for specific laboratory activities as listed in the HOKLAS directory of accredited laboratories. The results shown in this report were determined by this laboratory in accordance with its terms of accreditation.



4.22 Duplex Connections, FCC 15.323(c)(10) / RSS-213 Clause 4.3.4(b)(10):

An initiating device may attempt to establish a duplex connection by monitoring both its intended transmit (Tx) and receive (Rx) time and spectrum windows. If both the intended transmit and receive time and spectrum windows meet the access criteria, then the initiating device can initiate a transmission in the intended transmit time and spectrum window. If the power detected by the responding device can be decoded as a duplex connection signal from the initiating device, then the responding device may immediately begin transmitting on the receive time and spectrum window monitored by the initiating device.

Measurements are made in accordance with ANSI C63.17 sub-clause 8.3. Test setup is shown in section 3.3 Figure 3.3.1.

Attestation:

The Deskset is the initiating device of the duplex connection

Test Results:

Dual Access Criteria Check for EUT not Implemented the Upper Threshold:

Interference	Reaction of EUT	Results
All Tx and Rx Window, except one for Rx Window	NA	NA
All Tx and Rx Window, except one for Tx Window	NA	NA

- A – Could be connected on the target Rx window and its duplex mate
- B – Could be connected on the target Tx window and its duplex mate
- C – Connected on window which is not the target Tx/Rx window
- D – Could not be connected
  
- NA – Not applicable

Issuing Laboratory:  
Intertek Testing Services Hong Kong Limited

Hong Kong Accreditation Service (HKAS) has accredited this laboratory under the Hong Kong Laboratory Accreditation Scheme (HOKLAS) for specific laboratory activities as listed in the HOKLAS directory of accredited laboratories. The results shown in this report were determined by this laboratory in accordance with its terms of accreditation.



4.22 Duplex Connections, FCC 15.323(c)(10) /  
RSS-213 Clause 4.3.4(b)(10): - Continued

[ ] Dual Access Criteria Check for EUT Implemented the Upper Threshold:

Interference	Reaction of EUT	Results
All Tx windows with level $T_L + U_M$ & Rx windows with level $T_L + U_M + 7\text{dB}$ , except one for Tx window & one for Rx window, which are not duplex.	NA	NA
All Tx windows with level $T_L + U_M + 7\text{dB}$ & Rx windows with level $T_L + U_M$ , except one for Tx window & one for Rx, which are not duplex	N	NA
All Tx & Rx windows with level $T_U + U_M$ , except one for Tx window & one for Rx Window, which are not duplex	NA	NA

- A – Could be connected on the target Rx window and its duplex mate
- B – Could be connected on the target Tx window and its duplex mate
- C – Connected on window which is not the target Tx/Rx window
- D – Could not be connected
  
- NA – Not applicable

Issuing Laboratory:  
Intertek Testing Services Hong Kong Limited

Hong Kong Accreditation Service (HKAS) has accredited this laboratory under the Hong Kong Laboratory Accreditation Scheme (HOKLAS) for specific laboratory activities as listed in the HOKLAS directory of accredited laboratories. The results shown in this report were determined by this laboratory in accordance with its terms of accreditation.



4.23 Alternative Monitoring Interval for Co-located Device, FCC Rule 15.323(c)(11) / RSS-213 Clause 4.3.4(b)(11):

An initiating device that is prevented from monitoring during its intended transmit window due to monitoring system blocking from the transmissions of a co-located (within one meter) transmitter of the same system, may monitor the portions of the time and spectrum windows in which they intend to receive over a period of at least 10 ms. The monitored time and spectrum window must total at least 50 % of the 10 ms frame interval and the monitored spectrum must be within the 1.25 MHz frequency channel(s) already occupied by that device or co-located co-operating devices. If the access criteria is met for the intended receive time and spectrum window under the above conditions, then transmission in the intended transmit window by the initiating device may commence.

Measurements are made in accordance with ANSI C63.17 sub-clause 8.4.

Attestation:

- [ ] Appropriate as it is co-located device, in which the monitoring system will be blocked from the transmissions of a co-located (Within one meter) transmitter of the same system. Please refer to attachment, 15.323(c)(11).pdf / RSS-213(b)(11).pdf, for details.
- [ x ] Not appropriate, as the system always monitor both the transmit and receive time/spectrum windows, it is not a co-located device.

4.24 Fair Access, FCC Rule 15.323(c)(12) / RSS-213 Clause 4.3.4(b)(12):

The provisions of FCC Rule 15.323(c)(10) or (c)(11) / RSS-213 Clause 4.3.4(b)(10) or (b)(11) shall not be used to extend the range of spectrum occupied over space or time for the purpose of denying fair access to spectrum to other devices.

Attestation:

The manufacturer declares that the device does not use any mechanisms as provided by Part 15.323(c)(10) or (c)(11) / RSS-213 Clause 4.3.4(b)(10) or (b)(11) to extend the range of spectrum occupied over space or time for the purpose of denying fair access to spectrum to other devices.

Please refer to the declaration letter which is saved with filename: declaration.pdf.

Issuing Laboratory:  
**Intertek Testing Services Hong Kong Limited**

Hong Kong Accreditation Service (HKAS) has accredited this laboratory under the Hong Kong Laboratory Accreditation Scheme (HOKLAS) for specific laboratory activities as listed in the HOKLAS directory of accredited laboratories. The results shown in this report were determined by this laboratory in accordance with its terms of accreditation.



**EXHIBIT 5  
EQUIPMENT LIST**

Issuing Laboratory:  
Intertek Testing Services Hong Kong Limited

Hong Kong Accreditation Service (HKAS) has accredited this laboratory under the Hong Kong Laboratory Accreditation Scheme (HOKLAS) for specific laboratory activities as listed in the HOKLAS directory of accredited laboratories. The results shown in this report were determined by this laboratory in accordance with its terms of accreditation.



## 5.0 Equipment List

### 1) Radiated Emissions Test

Equipment	EMI Test Receiver	Spectrum Analyzer	Double Ridged Guide Antenna
Registration No.	EW-2500	EW-2188	EW-1015
Manufacturer	R&S	AGILENTTECH	EMCO
Model No.	ESCI	E4407B	3115
Calibration Date	Mar. 22, 2013	Nov. 5, 2012	Mar. 5, 2013
Calibration Due Date	Feb. 28, 2014	Nov. 5, 2013	Sep. 5, 2014

Equipment	Biconical Antenna	Log Periodic Antenna	Broad-Band Horn Antenna
Registration No.	EW-0571	EW-1042	EW-1679
Manufacturer	EMCO	EMCO	SCHWARZBECK
Model No.	3104C	3148	BBHA9170
Calibration Date	Apr. 5, 2012	Apr. 25, 2012	Apr. 1, 2013
Calibration Due Date	Oct. 5, 2013	Oct. 25, 2013	Apr. 1, 2014

### 2) Conducted Emissions Test

Equipment	EMI Test Receiver	Spectrum Analyzer	LISN
Registration No.	EW-2251	EW-2425	EW-2501
Manufacturer	R&S	R&S	R&S
Model No.	ESCI	FSP3	ENV-216
Calibration Date	Nov. 23, 2012	Nov. 16, 2012	Nov. 30, 2012
Calibration Due Date	Oct. 30, 2013	Nov. 16, 2013	Nov. 30, 2013

Equipment	Pulse Limiter
Registration No.	EW-0698
Manufacturer	R&S
Model No.	ESH3-Z2
Calibration Date	Apr. 6, 2013
Calibration Due Date	Apr. 6, 2014

Issuing Laboratory:  
Intertek Testing Services Hong Kong Limited

Hong Kong Accreditation Service (HKAS) has accredited this laboratory under the Hong Kong Laboratory Accreditation Scheme (HOKLAS) for specific laboratory activities as listed in the HOKLAS directory of accredited laboratories. The results shown in this report were determined by this laboratory in accordance with its terms of accreditation.



**5.0 Equipment List (continued)**

3) Conductive Measurement Test

Equipment	Coaxial directional coupler	Spectrum Analyzer	Digital Radiocommunication Tester for DECT
Registration No.	EW-2337	EW-2466	EW-1739
Manufacturer	MAGNA	R&S	R&S
Model No.	4222-16	FSP30	CMD60
Calibration Date	Nil*	Aug. 4, 2013	Sep. 17, 2012
Calibration Due Date	Nil*	Aug. 4, 2014	Sep. 17, 2013

Equipment	Vector Signal Generator	Digital Multimeter	Temperature & Humidity Chamber
Registration No.	EW-2411	EW-1017	EW-2134
Manufacturer	R&S	FLUKE	GIANT FORCE
Model No.	SMU200A	179	GTH-750-40-CP-SD
Calibration Date	Apr. 12, 2013	Sep. 9, 2012	Aug. 13, 2012
Calibration Due Date	Apr. 12, 2014	Oct. 1, 2013	Aug. 29, 2013

**END OF TEST REPORT**